

Connecting the Sensor Cable to the Control Unit

Step 1: Connect the RJ12 end of the sensor cable to the Control Unit (CU). For wiring connections from the Control Unit to the sensor, refer to the *Control Unit Installation Guide*.

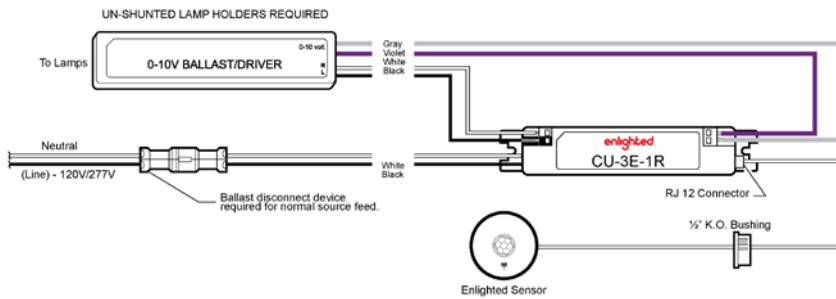

Step 2: Energize the luminaire and confirm that the green LED is solid.

LED Description

LED Status	Description/Solution
LED not on	Check power and wiring
Green blinking	Sensor commissioned and working
Red blinking	Sensor not commissioned
Red solid	Faulty sensor – replace sensor
Green solid	Sensor installed, initialized, and uncommissioned – waiting for discovery.
Blue solid	Sensor received a request to identify itself

Model No. : SU-5E-01

FCC ID: AQQ-SU5E

IC: 10138A-SU5E



FCC and Industry Canada Compliance Information

This equipment has been tested and found to comply with the limits for a Class A digital device, pursuant to part 15 of the FCC Rules. These limits are designed to provide reasonable protection against harmful interference when the equipment is operated in a commercial environment. This equipment generates, uses, and can radiate radio frequency energy and, if not installed and used in accordance with the instruction manual, may cause harmful interference to radio communications. Operation of this equipment in a residential area is likely to cause harmful interference in which case the user will be required to correct the interference at his own expense.

This device complies with Part 15 of the FCC Rules and Industry Canada license-exempt RSS standard(s). Operation is subject to the following two conditions:

- this device may not cause harmful interference, AND
- this device must accept any interference received, including interference that may cause undesired operation.

Changes or modifications not expressly approved by Enlighted Inc. could void the user's authority to operate the equipment.

Le présent appareil est conforme aux CNR d'Industrie Canada applicables aux appareils radio exempts de licence. L'exploitation est autorisée aux deux conditions suivantes:

- l'appareil ne doit pas produire de brouillage, ET
- l'utilisateur de l'appareil doit accepter tout brouillage radioélectrique subi, même si le brouillage est susceptible d'en compromettre le fonctionnement.

CE

This device complies with the essential requirements and other relevant requirements of the R&TTE Directive (1999/5/EC). The equipment is Class 1 radio equipment which can be placed on the market and be put into service without restrictions in accordance with article 1(3) of Commission Decision 2000/299/EC (Version July 2014).

Technical Support

For questions regarding the installation or operation of this product, contact Enlighted

Technical Support: support@enlightedinc.com

Company Contact Information

Location: 930 Benecia Ave, Sunnyvale, CA 94085

Phone: +1.650.964.1094

Web: enlightedinc.com

Copyright © 2017 Enlighted Inc. All rights reserved.

All other brand or product names are trademarks of their respective companies or organizations.



Micro Sensor (SU-5E) Installation Instructions

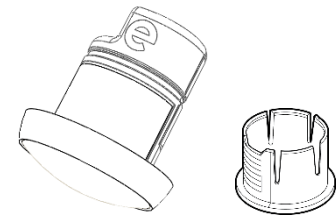

Micro Sensor and Carrier

Shipped Components

- Enlighted Micro Sensor

Supplemental Components

- Enlighted Sensor Cable
- Enlighted Control Unit

Tools you may Need

- 7/8" Drill bit (1/2" knock out trade size)
- Hand drill

Caution

Installation and maintenance must be performed by a qualified electrician in accordance with local, state, and national electrical codes (NEC) and requirements.

Fixture Mount Sensor Installation

Step 1: De-energize the luminaire.

Note: For fixture mounting, use the fixture carrier and nut that is shipped with the sensor.

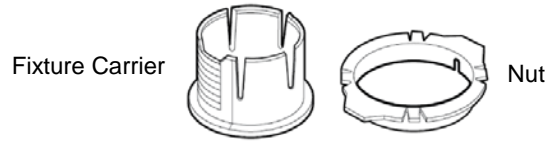

Step 2: Determine the location for the sensor in the fixture and cut a 1/2 inch (7/8" diameter) knockout in the fixture.

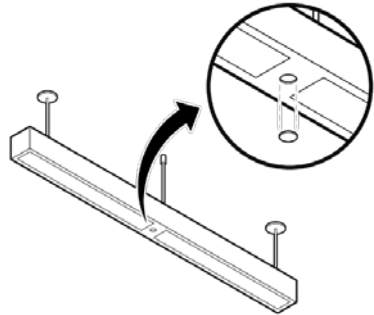

Step 3: Insert the fixture carrier through the hole in the fixture.

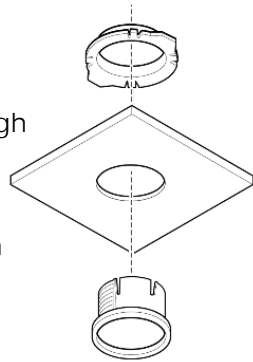

Step 4: From behind the fixture, align the tabs of the nut with the keys on the fixture carrier.

Step 5: Slide the tabs of the nut along the keys of the carrier to fasten the carrier.

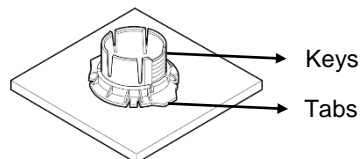

Step 6: Insert the 8-pin end of the sensor cable through the carrier.

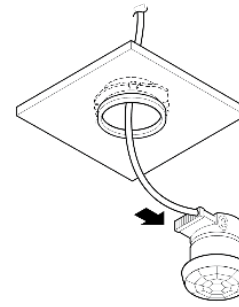

Step 7: Connect the 8-pin connector to the sensor.

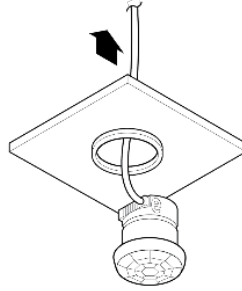

Step 8: Guiding the wire from above, push the sensor into the carrier until it securely clicks into the carrier.

Step 9: Leave four inches of slack cable in the sequence loop to avoid pinching of the cable and to bring the sensor down if it needs to be replaced.

Note: Do not pull the cable forcefully as this might damage the cable or connector.

Step 10: See section *Connecting the Sensor Cable to the Control Unit* on Page 5.

Tile Mount Sensor Installation

Step 1: De-energize the luminaire.

Note: For tile mounting, use the tile carrier and nut that is shipped with the sensor.

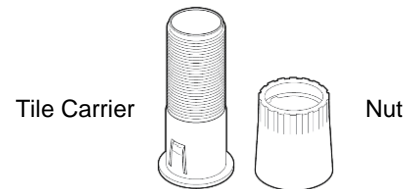

Step 2: Make a 7/8" diameter hole in the ceiling tile.

Step 3: Insert the tile carrier through the hole into the tile.

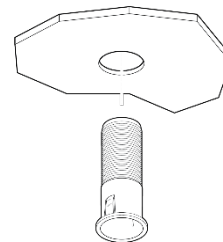

Step 4: Thread the plain end of the nut from behind the tile to secure the carrier.

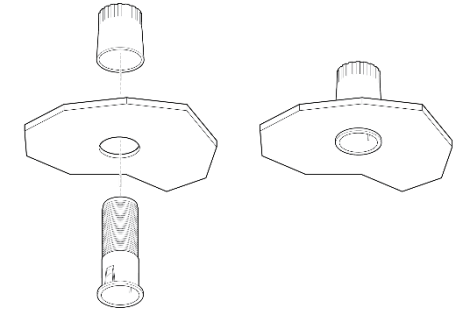

If the tile is thicker than normal, flip the nut and thread the ribbed end of the nut to secure the carrier.

Step 5: Insert the 8-pin end of the sensor cable through the carrier.

Step 6: Connect the 8-pin connector to the sensor.

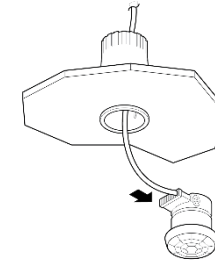

Step 7: Guiding the wire from above, push the sensor into the carrier until it securely clicks into the carrier.

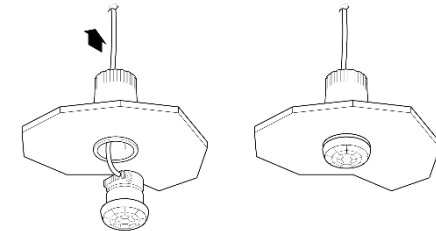

Step 8: Leave four inches of slack cable in the sequence loop to avoid pinching of the cable and to bring the sensor down if it needs to be replaced.

Note: Do not pull the cable forcefully as this might damage the cable or connector.

Step 9: See section *Connecting the Sensor Cable to the Control Unit* on Page 5.