

1200Channels PLL Wireless Sytem
USER GUIDE

UB-102B

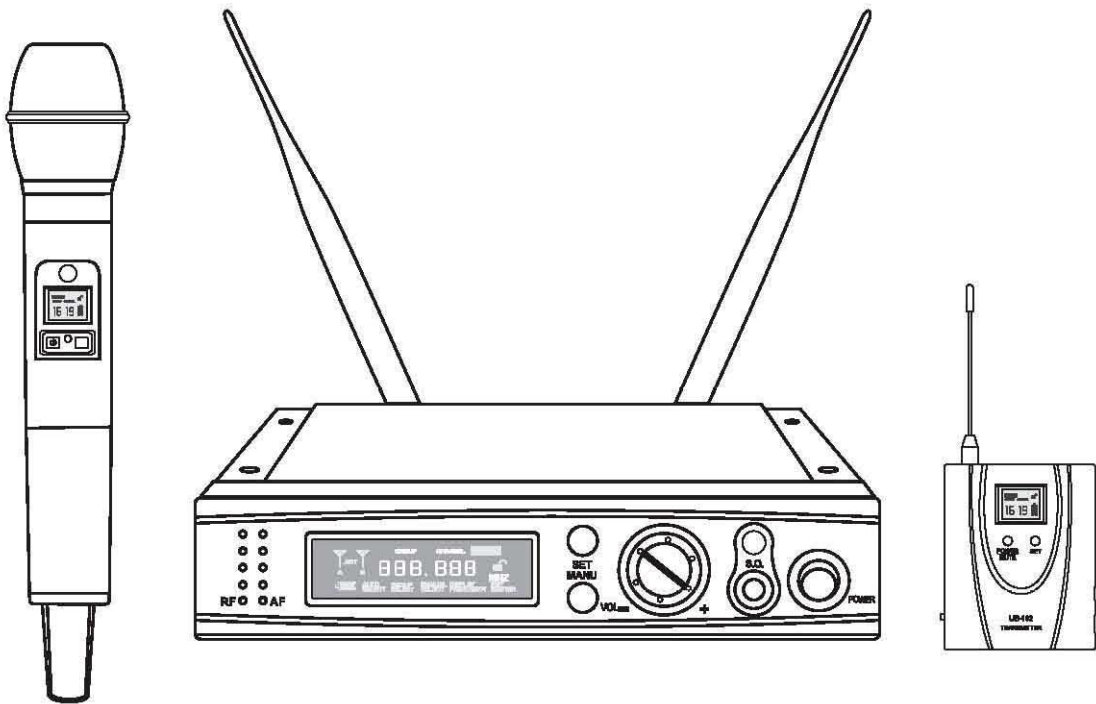

UHF-PLL Wireless
Microphone

Thank you and welcome to the world of wireless. This brand new system is designed to provide you with the most audio clarity and strongest anti-interference protection that you can ever imagine.

Follow our instructions in this user guide, and enjoy the easy way of setting up the system and operating the system now.

FREQUENCY BAND SELECTION

Most countries closely regulate the radio frequencies used in the transmission of wireless information.

These regulations state which devices can use which frequencies, and help to limit the amount of RF (radio frequency) interference in all wireless communications.

To be flexible enough to operate worldwide, this new system receiver is available in a number of frequency ranges. Each frequency range, or band, spans up to 30 MHz of the wireless broadcast spectrum. Available bands are:

U0: 614 - 698 MHz

To facilitate system setup and protect against RF interference, each system comes with multiple predefined frequency **groups** and **channels**.

When using a single system, the operating frequency will generally not have to be changed. In an installation with multiple receiver/transmitter systems, each system must operate on a separate channel. The group and channel system provides an optimum frequency spread when using multiple systems.

Within a single frequency band, up to 13 individual transmitter/receiver systems may be used in a single installation. In regions where additional frequency bands are available, it is possible to operate up to 20 systems simultaneously. Check with your local retailer for information on which bands are available in your area.



TABLE OF CONTENTS

System Components 1

Receiver Features 2

Handheld Transmitter 3

Bodypack Transmitter 4

Single System Setup 5

Multiple System Setup 5

Programming

 Receiver Programming 6

 Transmitter Programming 6

 The Master Frequency List 7-8

Rack-Mounting Receivers 9

Tips for Improving System Performance 10

Troubleshooting..... 10

Specifications..... 11



1200 Channels PLL Wireless

System Components

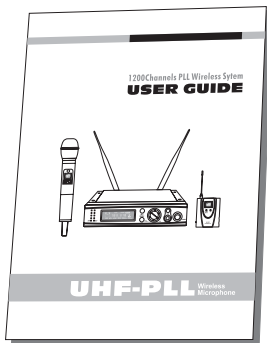
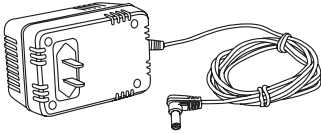
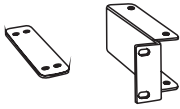
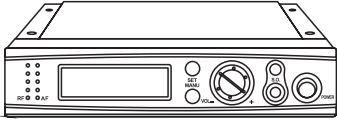

Any system will include:

- Receiver
- Power supply
- User guide

Optional accessories:

- Rack mount supplies
 - Short rack ear
 - Long rack ear
 - Link bar to mount to similar receiver
 - 8 rack ear screws
 - 4 rack mount screws with washers
- Extension cables and connectors for front-mounting antennas

And, a Handheld system will include:

- Microphone head ① (Optional DM-58, EM-11S)
- Handheld transmitter ②
- Microphone holder ③
- 2 AA batteries

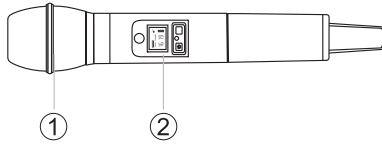

Or, a Body pack systems will include:

- Body pack transmitter ①
- Lavalier microphone (Optional LV-0211 ②, LV-6210 ③, LV-4111 ④)
- Headworn microphone (Optional HS-4111 ⑤, HS-6210 ⑥, HS-0211S ⑦)
- 2 AAA batteries

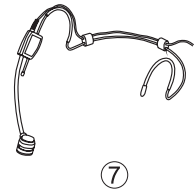
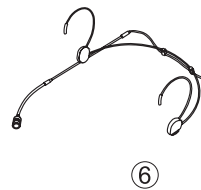
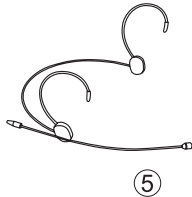
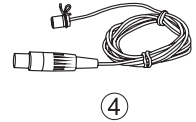
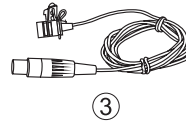
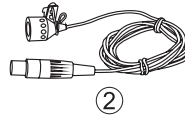
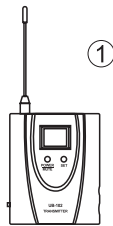

Or, a Guitar system will include:

- Body pack transmitter ①
- 1/4 jack to mini 4-pin guitar cable ②
- 2 AAA batteries

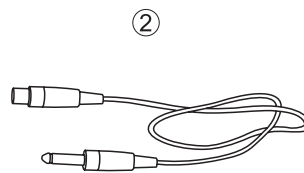
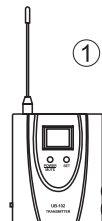

Receiver Features

Front Panel

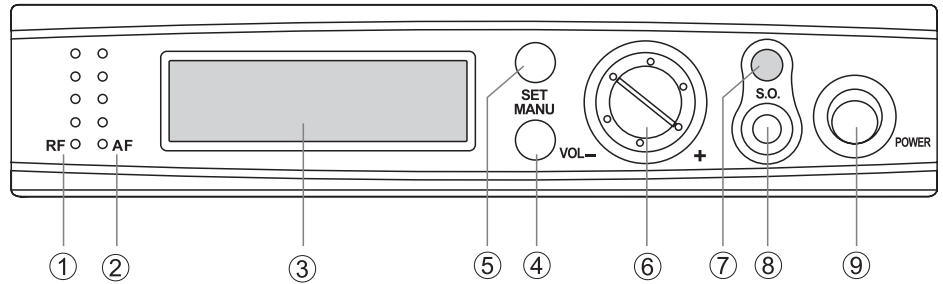

- ① RF LED - Indicates strength of incoming RF signal.
- ② Audio LED - Indicates strength of incoming audio signal.
- ③ LCD display - See "Programming" on page 6.
- ④ Menu switch - Press to scroll through menu options. See "Programming" on page 6.
- ⑤ Set switch - Press to select the currently displayed menu option. See "Programming" on page 6.
- ⑥ Volume control. The volume control dial should generally be left in the clockwise position. Turning the dial counter-clockwise decreases receiver output level.
- ⑦ Infrared (IR) port - Broadcasts IR signal to transmitter to synchronize frequencies.
- ⑧ Smart option - Press to initiate IR connection between receiver and transmitter. See "Programming" on page 5.
- ⑨ Power On/Off switch - Push up to turn on, push down to turn off.

Back Panel

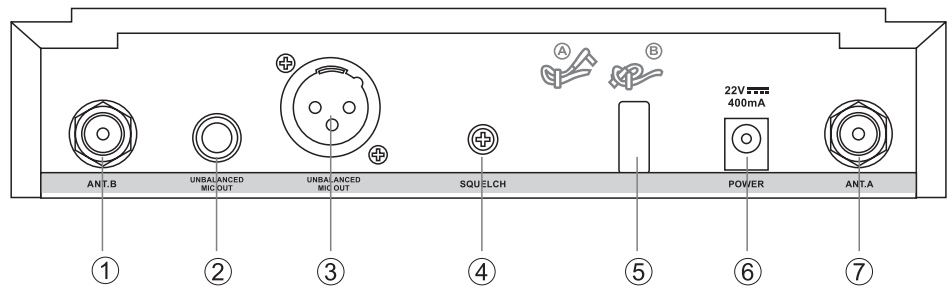

- ① Antenna jack B
- ② 1/4" jack output jack
- ③ XLR output jack
- ④ Squelch
- ⑤ Adapter cord tie-off - Follow strips shown to secure cord to receiver body.
- ⑥ AC adapter jack
- ⑦ Antenna jack A

Handheld Transmitter

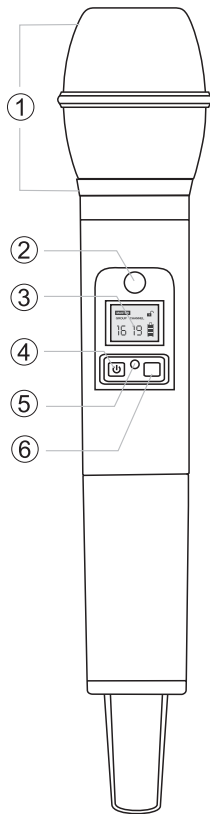

Features

- ① Interchangeable microphone head
- ② IR port - Receives infrared beam to synchronize frequencies. When using multiple systems, only one transmitter IR port should be exposed at a time.
- ③ LCD screen - See "Transmitter Programming" on page 6.
- ④ On-off / mute switch - Press and hold to turn on or off. Press and release to mute or unmute.

To avoid accidentally muting the microphone during a performance, lock the front panel while the microphone is in use.

- ⑤ Mute indicator- Red: mute on
- ⑥ Set switch - See "Transmitter Programming" on page 6.

Changing Batteries

Expected life for an Alkaline battery is approximately 8 hours.

When the battery bar in LCD display is empty, the batteries should be changed immediately as shown below:

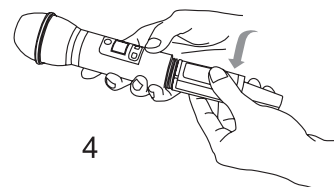
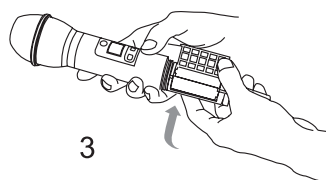
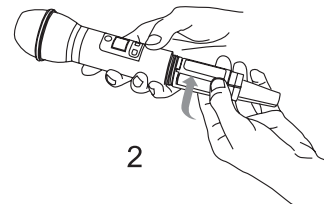
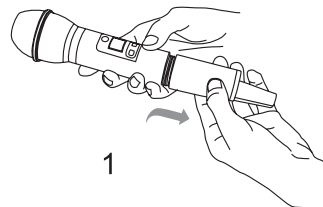

Bodypack Transmitter

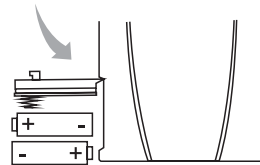
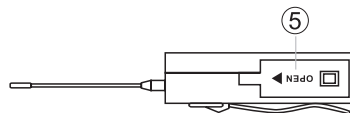
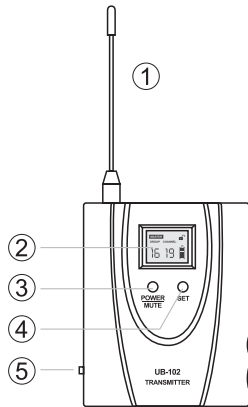

Features

- ① Antenna
- ② LCD screen
- ③ On-off / mute switch
Press and hold to turn on or off. Press and release to mute or unmute.
- ④ Set switch
- ⑤ Battery cover
- ⑥ IR port
Receives infrared beam to synchronize frequencies. When using multiple systems, only one transmitter IR port should be exposed at a time.
- ⑦ Gain adjustment switch
- ⑧ Mute indicator
Red: mute on
- ⑨ 4-Pin microphone input jack

Wearing the Bodypack Transmitter

- Clip the transmitter to a belt until the belt is pressed against the base of the clip as show on the left.

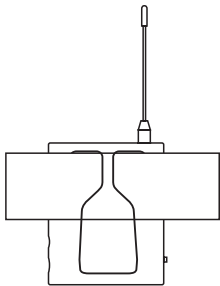

Changing Batteries

- Expected life for an Alkaline battery is approximately 8 hours.
- When the battery bar in LCD display is empty, the batteries should be changed immediately as shown below:

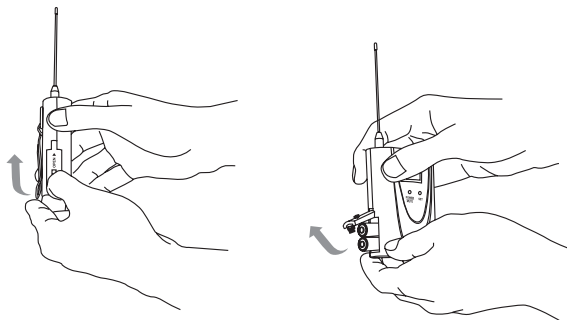

Single System Setup

Note: transmitting devices such as cellular phones and two-way radios may interfere with wireless audio transmissions. Keep your transmitters and receivers away from these and other potential sources of interference.

Follow these steps when using a single system:

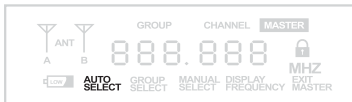

1. Automatic Frequency Selection ① menu ② set

Scans for an available channel and sets the receiver to that channel.

2. Automatic Transmitter Setup S.O.

Exposed the IR port to the receiver, press S.O.

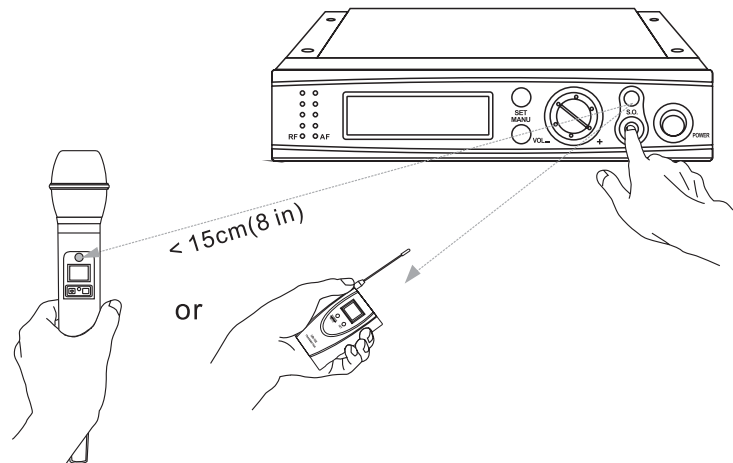

Multiple System Setup

Follow these steps when using multiple systems in a single installation:

1. Turn all receivers on and all transmitters off.
2. Set all receivers to the same frequency group.
3. Perform Automatic Frequency Selection from the Single System Setup section above.
4. Turn on the first transmitter.
5. Perform Automatic Transmitter Setup from the Single System Setup section above.
Repeat for each system.

Be sure that only one transmitter's IR port is exposed when synchronizing a system.

Programming

Any option displayed on screen will generally time out after five seconds.

Receiver Programming

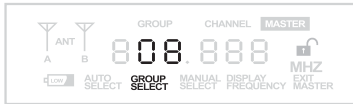

Group Selection ① 2x **menu** ② **set** ③ **S.O.**

Allows manual selection of a frequency group. Pressing **set** increases the group number by one. When the correct frequency is displayed press **S.O.**. For best results when operating multiple systems, set all systems to a single group; then set each system to a unique channel within that group.



Manual Channel Selection ① 3x **menu** ② **set** ③ **S.O.**

Allows manual selection of a frequency channel. Pressing **set** increases the channel number by one. When the correct frequency is displayed press **S.O.**.

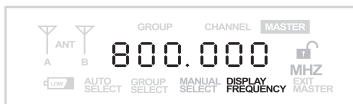

Display Frequency ① 4x **menu** ② **set**

Display the current frequency in MHz. Press again to display group and channel.

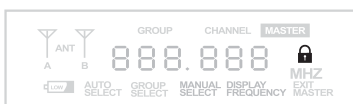

Lock or Unlock Receiver Settings **set** + **menu**

Hold down the **set** key and press **menu** to lock or unlock the receiver. When locked, the current receiver settings cannot be changed.

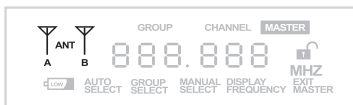

Antenna Status

Indicates RF activity. Only one antenna is active at any one time.

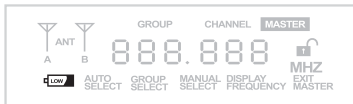

Transmitter Battery Status

Indicates a low transmitter battery charge.

Transmitter Programming

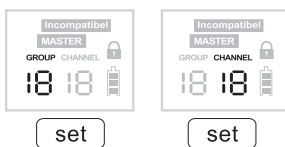

Manually Select a Group and/or Channel **set**

1. Press and hold the **set** button until the GROUP and CHANNEL displays begin to alternate.
2. To change the group setting, release the **set** button while GROUP is displayed. While GROUP is flashing, pressing **set** increases the group setting by one.
3. Press **power** button to switch between GROUP and CHANNEL settings.

Remember to press **power** and **set** button to confirm when the setting is completed.



Lock or Unlock Transmitter Settings **power** + **set**

Press the **power** and **set** buttons simultaneously to lock or unlock the transmitter settings. When locked, the current settings cannot be changed manually.



Battery Status

Indicates charge remaining in transmitter batteries.



Master List Indicator

Indicates that a master list frequency is currently in use. Group or channel information will be display.

Press **set** till GROUP and CHANNEL display begins to alternate. Hold **set** and press **power** till MASTER displays.

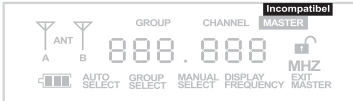

INCOMPATIBLE Frequency Warning

The INCOMPATIBLE warning indicates that the receiver and transmitter are set to incompatible frequency bands. Contact your retailer for assistance.

The Master Frequency List

Receiver

Using the Master **menu** + **power**

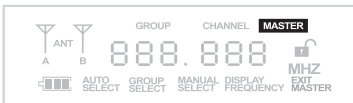

The "Master" of frequencies should be accessed only by experienced users in situations which call for precise frequency selection. The "Master" is a comprehensive index of all available frequencies in 25 kHz increments.

To access the Master, hold down the menu button while powering on the receiver.

Under the display of frequency

Select Frequencies in the Master ① 3x **menu** ② **set** ③ **set** ↑ / **menu** ↓

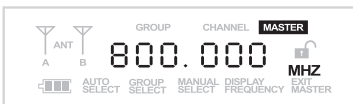

While FREQUENCY is flashing, the set button scrolls up through all available frequencies; The menu button scrolls down. Press and release to change the frequency in 25 kHz increments; press and hold to scroll quickly.

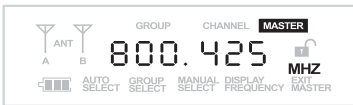

If you know the frequency you need, to speed up your selection, you can follow 2 steps below:

1. Select the frequency under zero, like 0.425MHz.
2. Press S.O., it will switch to select the frequency above zero, like 801MHz. Press and release to change the frequency in 1 MHz increments; press and hold to scroll quickly.

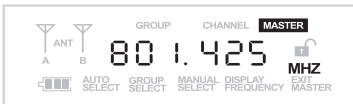

When the correct frequency is displayed, wait five seconds for the screen to time out.

Under the display of group and channel

Select Frequencies in the Master ① 3x **menu** ② **set** ③ **set** ↑ / **menu** ↓

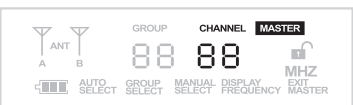

While CHANNEL is flashing, the set button scrolls up through all available frequencies; the menu button scrolls down. Press and release to change the frequency in 25 kHz increments; press and hold to scroll quickly.

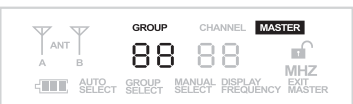

If you know the group and channel you need, to speed up your selection, you can follow 2 step below:

1. Select the channel.
2. Press S.O., It will switch to select the group. Press and release to change the frequency in 1 MHz increments; press and hold to scroll quickly

When the correct group and channel is displayed, wait five seconds for the screen to time out.

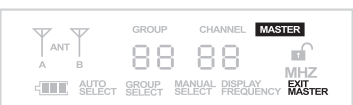

Exit the Master ① 2x **menu** ② **set**

To exit the Master and return to normal system operations, press menu, then set.



Transmitter

Enter the Master Press and hold +

While the "Master" is shown, release set + power, then press power + set to enter the "Master."

Select Frequencies in the Master

Press and hold the set button till the group is flashing. Press and release to change the frequency in 1 MHz increments. Press and hold to scroll quickly.

Switch to channel select by pressing the power button.

Press and hold the set button till the channel is flashing. Press and release to change the frequency in 25 KHz increments. Press and hold to scroll quickly.



Exit the Master Press and hold +

While the "Master" is disappear, release set + power, then press power + set to exit the "Master."



Rack-Mounting Receivers

The supplied mounting hardware allows an receiver to be mounted in any standard 19" audio equipment rack.

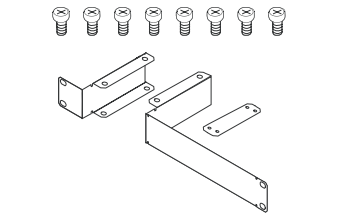
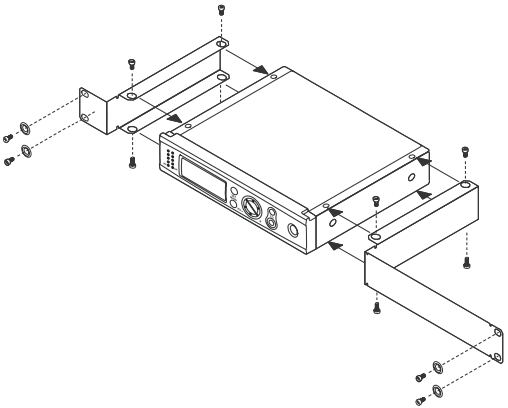
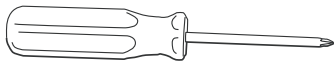
Hardware (Included)	Assembly
	
Tools (Not Included)	
	



Tips for Improving System Performance

- Maintain a line of sight between transmitter and antenna.
- Avoid placing the receiver near metal surfaces or any digital equipment (CD players, computers, etc.)
- Secure the AC adapter cable to the receiver using the cable retainer loop
- If rack-mounting the receiver, front-mount the antennas by using the extension cables and connectors.

Troubleshooting

Issue	Indicator Status	Solution
No sound or faint sound	Transmitter power light off	<ul style="list-style-type: none"> • Turn transmitter on • Make sure the +/- indicators on battery match the transmitter terminals • Insert a fresh battery
	Receiver LCD off	<ul style="list-style-type: none"> • Make sure AC adapter is securely plugged into electrical outlet and into DC input connector on rear panel of receiver • Make sure AC electrical outlet works and is supplying proper voltage
	Receiver display indicates antenna activity	<ul style="list-style-type: none"> • Press mute switch on transmitter • Turn up receiver volume control • Increase transmitter gain switch setting • Check cable connection between receiver and amplifier or mixer
	Receiver display indicates no antenna activity; transmitter and receiver power lights glowing	<ul style="list-style-type: none"> • Extend receiver antennas vertically • Move receiver away from metal objects • Check for line of sight between transmitter and receiver • Move transmitter closer to receiver • Check that receiver and transmitter are using the same frequency
	Transmitter power light glowing or flashing red	<ul style="list-style-type: none"> • Replace transmitter batteries
	INCOMPATIBLE warning on transmitter	<ul style="list-style-type: none"> • The INCOMPATIBLE warning indicates that the receiver and transmitter are set to incompatible frequency bands. Contact your retailer for assistance.
Distortion or unwanted noise bursts	Receiver display indicates antenna activity	<ul style="list-style-type: none"> • Remove nearby sources of RF interference (CD players, computers, digital effects, in-ear monitor systems, etc.) • Change receiver and transmitter to a different frequency • Reduce transmitter gain • Replace transmitter battery • If using multiple systems, increase the frequency spread between systems
Distortion level increases gradually	Transmitter power light glowing or flashing red	<ul style="list-style-type: none"> • Replace transmitter batteries
Sound level different from cabled guitar or microphone, or when using different guitars		<ul style="list-style-type: none"> • Adjust transmitter gain and receiver volume as necessary
FULL warning displays on receiver		<ul style="list-style-type: none"> • The FULL warning indicates that all available channels in the currently selected group are in use. When this occurs, reprogram all systems to an alternate group.
Cannot turn transmitter off	Transmitter light flashing red	<ul style="list-style-type: none"> • Replace transmitter batteries

Specifications

System

Operating Range Under Typical Conditions

100m (300 ft.)

Note: actual range depends on RF signal absorption, reflection, and interference

Audio Frequency Response (+/- 2 dB)

Minimum: 50 Hz

Maximum: 20 kHz

(Overall system frequency depends on microphone element.)

Total Harmonic Distortion (ref. +/- 30 kHz deviation, 400Hz tone)

0.5%, typical

Dynamic Range

>100 dB A-weighted

Operating Temperature Range

-18°C (0°F) to +57°C (+135°F)

Note: battery characteristics may limit this range

UB-102 Bodypack Transmitter

Gain Adjustment Range

30dB

Input Impedance

500K Ω

RF Transmitter Output

30 mW maximum (dependent on applicable country regulations)

Dimensions

85 mm H x 70 mm W x 20 mm D

Weight

97 g without batteries

Housing

Molded ABS case

Power Requirements

2 "AAA" size alkaline or rechargeable batteries

Battery Life

>5 hours (alkaline)

UH-102 Handheld Transmitter

RF Transmitter Output

30 mW maximum (dependent on applicable country regulations)

Dimensions (including EM-11S cartridge)

270 mm x 52 mm dia.

Weight

250 g without batteries

Housing

Molded ABS handle and battery cup

Power Requirements

2 "AA" size alkaline or rechargeable batteries

Battery Life

>8 hours (alkaline)

UHF-102 Receiver

Dimensions

205 mm H x 160 mm W x 39 mm D

Weight

960 g

Housing

Galvanized steel

Audio Output Level (ref. +/- 30 kHz deviation with 400Hz tone)

XLR connector (into 600 Ω load): -30dBV

1/4 inch connector (into 3000 Ω load): -9dBV

Output Impedance

XLR connector: 200 Ω

1/4 inch connector: 1k Ω

XLR output

Impedance balanced

Pin 1: Ground (cable shield)

Pin 2: Audio

Pin 3: No Audio

Sensitivity

-105 dBm for 12 dB SINAD, typical

Image Rejection

>70 dB, typical

Power Requirements

22V dc at 400mA, supplied by external power supply

