

ENVIROALERT® EA800



***Electronic Multi-Zone Environmental Alarm System
Installation/Owner's Manual***



Limitations of the Alarm System or Device

While your alarm system or device is reliable and sophisticated, it does not offer guaranteed protection against burglary, fire or other emergency. Any security product, whether commercial or residential, is subject to compromise or failure-to-warn for a variety of reasons. These include:

- Individuals may gain access through unprotected openings or have the technical sophistication to bypass an alarm sensor or disconnect an alarm warning device.
- Monitoring devices will not operate without power. Devices powered by AC will not work if their AC power supply is off for any reason. If system has battery backup, batteries that are not maintained can fail to provide the necessary power for devices to function properly.
- Alarm warning devices such as sirens, bells, and horns may not alert people or awaken sleepers if they are located on the other side of closed or partly closed doors. If warning devices are on a different level of the residence from the bedrooms, they are less likely to awaken or alert people inside the bedrooms.
- Telephone lines needed to transmit alarm signals from a premises to a central monitoring station may be out of service, and are subject to compromise by sophisticated means of attack.
- Signals sent by wireless transmitters may be blocked or reflected by metal before they reach the alarm receiver. Even if the signal path has been recently checked during a weekly test, blockage can occur if a metal object is moved into the path.
- Even if the system responds to the emergency as intended and is a monitored alarm system, the authorities may not respond appropriately.
- This equipment, like other electrical devices, is subject to component failure.
- The most common cause of an alarm system not functioning properly is due to inadequate maintenance. Your alarm system should be tested weekly to make sure all detection devices are operating properly. Your control panel and keypads should be tested as well.

Installing an alarm system may make you eligible for lower insurance rates, but an alarm system is not a substitute for insurance. Homeowners, property owners, and renters should continue to insure their lives and property.

Table of Contents

General Information	1
Overview	1
How to Use This Manual.....	2
Block Diagrams.....	3
Symbols on the Product or Manual Labeling	4
Monitoring Screens.....	5
Keys	6
Base Unit Connections	7
Access Control and Passwords	8
System Configuration Parameters	9
Sensors.....	10
Temperature Sensors	10
Humidity Sensors.....	11
4-20mA Sensors	11
Theory of Operation	11
Power Supply / Sensor Voltage Selection.....	12
Water Sensors	13
Multi-Function Sensors	13
Contact Closure Sensors	13
Sensor Parameter Descriptions	14
Relay Operation	15
Preparation	17
Installation	21
Tools and Supplies Required.....	21
Power Requirements	21
Mounting the EA800 Rear Plate	21
Install the Wired Sensors.....	22
EA800 Base Unit Power Connections	22
Install the Wireless Sensors.....	22
Connecting Wired Temperature, Contact Closure, and Water Bug Sensors.....	24
Connecting Wired HA-III+ Humidity Sensors.....	25
Connecting Wired 4-20mA Sensors.....	26
Connecting the EA800 Alarm Outputs.....	27
Programming	27
Accessing the MAIN MENU for Programming	28
Configuring System Parameter Settings.....	28
Setting the Current Date	31
Setting the Time.....	32
Adding Wireless Sensors.....	33
Adding a Wireless Temperature Sensor	33
Adding a Wireless Multi-Function Sensor Using a Wired Temperature Sensor	35
Adding a Wireless Humidity Sensor.....	37
Adding a Wireless Multi-Function Sensor Using a Wired WaterBug Sensor	38
Adding a Wireless Multi-Function Sensor Using a Wired Contact Closure Sensor	40
Verify Wireless Signal Strength	42
Adding Wired Sensors	43
Adding a Wired Temperature Sensor	43
Adding a Wired HA-III+ Humidity Sensor.....	44
Adding a Wired WaterBug Sensor	45
Adding a Wired Contact Closure Sensor	46
Adding a 4-20mA Sensor.....	47
Configuring the Relays.....	48

Operation	49
Monitoring Environmental Conditions	49
Viewing Sensor Settings	50
Viewing Active Alarms	50
Viewing the Alarm Log	51
Viewing Pending Alarm Information	51
Viewing Limit Settings	52
Viewing the Event Log	52
Viewing the Sensor Log	53
Viewing Firmware Information	53
Viewing RF Information.....	54
Maintenance	55
Locking and Unlocking the EA800	55
Pausing Monitoring and Cancelling Pause	56
Adding a Sensor	57
Replacing a Sensor.....	57
Editing Sensor Parameters	58
Reprogramming a Relay	59
Deleting a Sensor	59
Changing the Date Format.....	60
Changing the Time Format	60
Changing the Date or Time Setting.....	61
Changing Sensor Data Collection Frequency	61
Changing the Buzzer Setting	62
Changing the Password.....	63
Clearing the Alarm Log	64
Clearing the Sensor Log	64
Updating the Firmware.....	65
Saving Configuration Settings.....	66
Loading Configuration Settings.....	67
Exporting the Stored Logs	68
Exported Alarm Data.....	68
Exported Event Data	69
Exported Sensor Data.....	69
Troubleshooting	71
Verifying RF Signal Strength.....	72
Viewing Signal Strength for a Wireless Sensor.....	72
Specifications	73
Base Unit and Sensor Specifications	73
Accessories.....	74
Appendix A: Screen Maps	75
Appendix B: Planning Worksheet	83
Appendix C: Wiring Diagram	85
Appendix D: System Configuration Record	87
Warranty and Service Information	93

Overview

The EnviroAlert® EA800 Multi-Zone Environmental Alarm System monitors the environmental conditions detected by the sensors connected to the base unit, and provides alarm signals when monitored conditions at any of the sensors exceed the user-programmable HIGH LIMIT or LOW LIMIT set points. The alarm signals are provided via relay outputs that can operate with process controls, security systems, or other similar automated equipment. The EA800 Alarm System can be configured with wired or optional wireless sensors (sold separately). The EA800 allows connection of up to 4 wired and 4 wireless sensors.

Setup and programming is done using the front panel keys and the liquid crystal display (LCD) on the base unit. The display assists the user during setup, and shows measured conditions for the monitored environment during operation.

The EA800 can monitor multiple critical environments using multiple sensor inputs. Each sensor input/alarm channel is designated a "Relay".

Using the appropriate accessory sensors (sold separately), the EA800 Alarm System monitors and provides alarms for the following conditions:

- Normally open/normally closed contacts
- Temperature: from -80° C to 150° C (-112° F to 302° F)
- Humidity: from 5% to 95% RH (non-condensing)
- Presence of water
- Any sensor with a 4-20mA interface

The EA800 base unit may be mounted directly to a 3-gang electrical enclosure or to walls. The wireless sensors are easily mounted to the wall. Figure 1 shows the base unit and a wireless sensor.

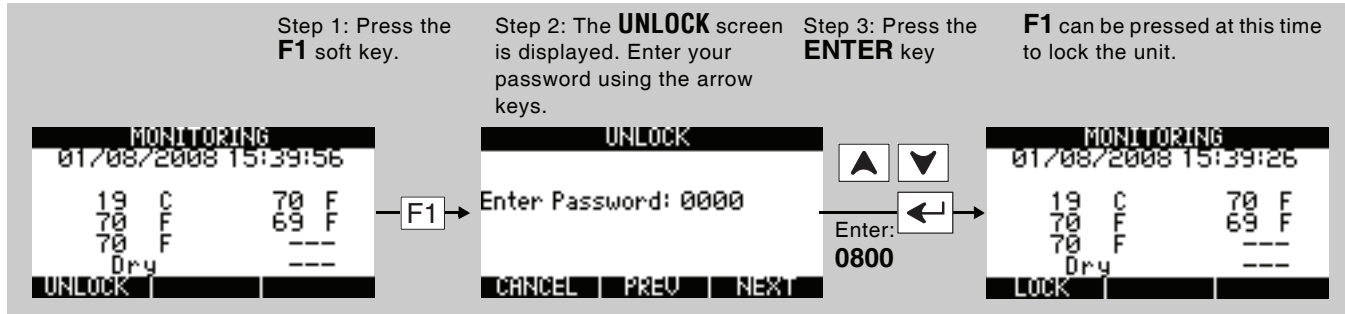

Figure 1 EnviroAlert EA800 Base Unit and Optional Wireless Sensor

How to Use This Manual

This manual is organized into sections that guide you through the installation process, then describe how to use the EA800 and change its programmed settings if necessary. Some troubleshooting guidelines are provided, and the appendices contain forms for you to photocopy and use to record the programmed settings of the EA800 and the monitoring system setup.

The manual presents EA800 programming procedures by showing you the sequence of menus and screens you will see as you perform the procedure, and the keys to press to advance to the next screen. The example below is the procedure for unlocking the EA800 base unit to allow programming.



The arrows on the drawing indicate the direction of procedure flow.

In all procedures, use the **▲** **▼** keys to select menu options and to increase/decrease alphanumeric values for programming options. Use the **PREV** and **NEXT** soft keys (**F2** and **F3**) to move the cursor to the next digit when entering numeric data.

The functions of the soft keys **F1** **F2** **F3** change and are defined on the screen in the area above each key. If no text is shown above a soft key, it means the key performs no function on the current screen.

"Keys" on page 6 describes the functions of each key on the base unit.

Note: For convenient reference, "Appendix A: Screen Maps" on page 75 contains maps of all menus and screens.

Throughout the manual, text that appears on the EA800 base unit screens is shown like this: **MONITORING**

Key names are shown in text like this: **F1**

The current menu selection is highlighted on the screen by arrows on either side of the selection, as shown in the example at right. On this **MAIN MENU** screen, the current selection is **Sensors**.

Use the **▲** or **▼** keys to move the highlight to the desired menu item, then press **↵** to make the selection.



Block Diagrams

Figure 2 shows a block diagram of the base unit interfaces and functions. The EA800 provides eight relays for indicating when a programmed alarm limit has been exceeded or a warning condition exists. An additional AUX (Auxiliary) Output relay provides an output signal to an optional audible alarm or strobe that is activated whenever an alarm condition exists.

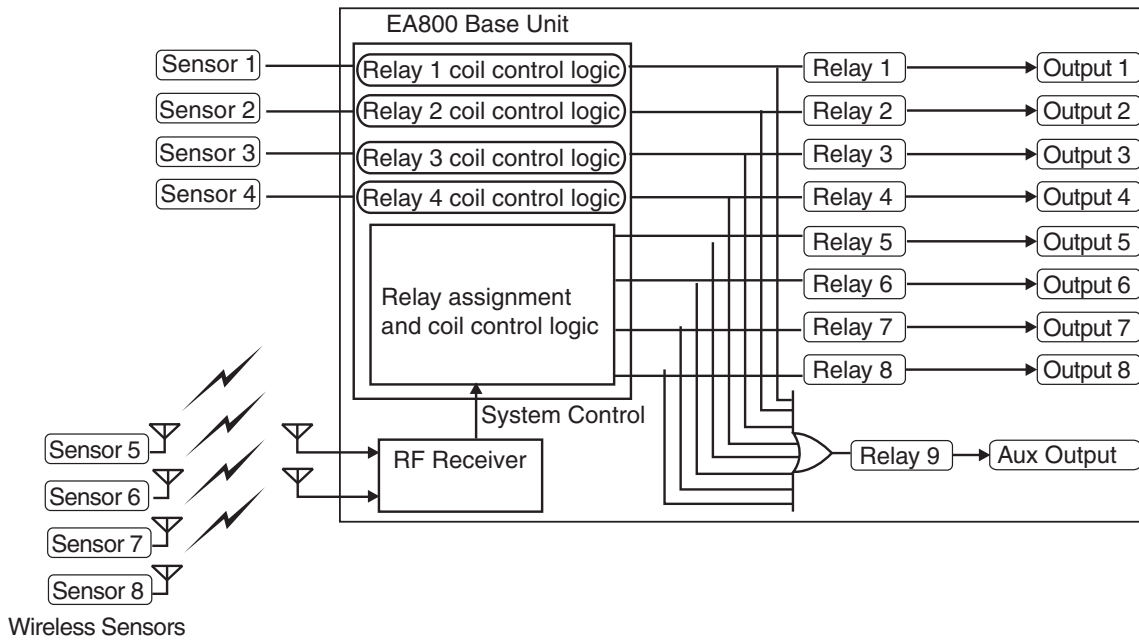

Figure 2 EA800 Environmental Alarm System Block Diagram

The EA800 can be made part of a larger security system as shown in Figure 3. In a security system there may be more than one EA800 installed along with other components such as the Winland EA200 or EA400 multi-zone environmental alarm systems.

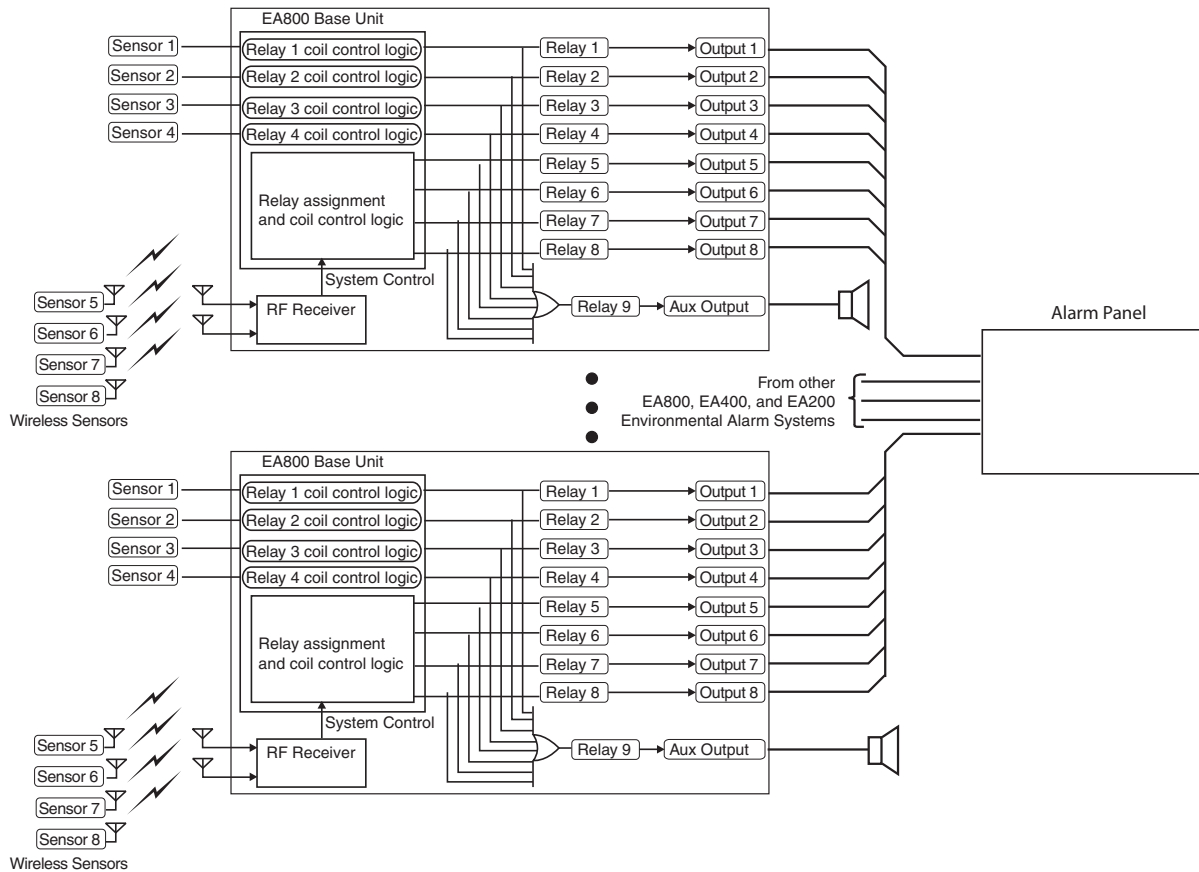







Figure 3 Facility Security System Block Diagram - Example

Symbols on the Product or Manual Labeling

Symbols appearing on the product labeling, packaging, and/or in this manual are shown and described in Table 1.

Table 1 Symbols on Product or Manual

Symbol	Definition
	Attention, consult accompanying documents or statements.
	For product disposal, ensure the following: <ul style="list-style-type: none"> • Do not dispose of this product as unsorted municipal waste. • Collect this product separately. • Use collection and return systems available to you.
	Indicates product complies with RoHS-WEEE directive.
NO	Normally Open (NO) relay contact terminal
NC	Normally Closed (NC) relay contact terminal
C	Common relay contact terminal
AUX	Combined single pole double throw (SPDT) NO relay output that activates upon an alarm from any of the sensors.
<p>Model: EA800</p> <ul style="list-style-type: none"> • FCC ID: V5SEA800-031108 • IC: 7635A-EA800 <p>Models: EA-WMFS, EA-WTS, EA-WHS</p> <ul style="list-style-type: none"> • FCC ID: V5SEA-WS-031108 • IC: 7635A-EAWS 	<p>This device complies with part 15 of the FCC Rules. Operation is subject to the following two conditions: (1) This device may not cause harmful interference, and (2) this device must accept any interference received, including interference that may cause undesired operation.</p> <p>Caution Statement (per CFR 15.21):</p> <p>Changes or modifications not expressly approved by the party responsible for compliance could void the user's authority to operate the equipment.</p> <p>Class B Product Compliance Statement (per CFR 15.105(b)):</p> <p>NOTE: This equipment has been tested and found to comply with the limits for a Class B digital device, pursuant to part 15 of the FCC Rules. These limits are designed to provide reasonable protection against harmful interference in a residential installation. This equipment generates, uses and can radiate radio frequency energy and, if not installed and used in accordance with the instruction, may cause harmful interference to radio communications. However, there is no guarantee that interference will not occur in a particular installation. If this equipment does cause harmful interference to radio or television reception, which can be determined by turning the equipment off and on, the user is encouraged to try to correct the interference by one or more of the following measures:</p> <ul style="list-style-type: none"> • Reorient or relocate the receiving antenna. • Increase the separation between the equipment and receiver • Connect the equipment into an outlet on a circuit different from that to which the receiver is connected. • Consult the dealer or an experienced radio/TV technician for help.
	The TÜV certification combines electrical safety certification for Canada (SCC), United States (NRTL), and Europe (EU Directives). This product was voluntarily tested according to the relevant safety requirements and mentioned properties pertaining to this certification mark.
	The product is in conformity with all applicable requirements for its placing on the European Union market.

Monitoring Screens

The EA800 user interface is menu-based. During normal system monitoring, one of the following three screens is displayed depending on the current state of the programmed sensors:

The **MONITORING** (home) screen is displayed when there are no active alarms. The screen lists all programmed sensors connected to the base unit and their current reading or state.

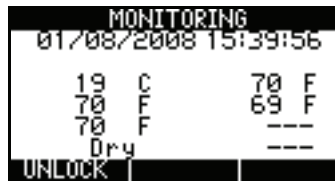

The **MONITORING** (home) screen displays pending alarms in reverse video as shown in the example at right (71° exceeds the temperature limit for Sensor 2, so it is shown as light text on black). Pending alarms indicate that the programmed limits for the sensor have been exceeded, but the sensor's programmed delay time has not elapsed yet. If the monitored conditions continue to exceed the programmed limits for longer than the programmed delay period, the pending alarm will become an active alarm.

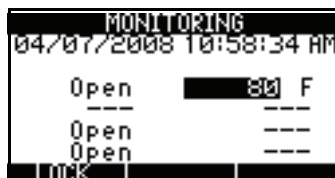

The **ACTIVE ALARMS** screen is shown when one or more sensors are in an active alarm or warning state. If more than one alarm is active, each will be listed on the screen. In the example shown, **Walk-in Cooler** and **Warehouse** alarms are occurring simultaneously.









Keys

Figure 4 shows the base unit display and entry keys. The keys are described in Table 2.



Figure 4 EA800 Base Unit Keys

Table 2 Key Functions

Key	Function
F1	This key's function changes as determined by the software. Its current function is displayed immediately above the key on the display.
F2	This key's function changes as determined by the software. Its current function is displayed immediately above the key on the display.
F3	This key's function changes as determined by the software. Its current function is displayed immediately above the key on the display.
	Up Arrow: This key provides the scroll up function. It moves the selection cursor up a list or increments the value of alphanumeric entry fields as identified by the flashing cursor. The values provided are dependent on the currently active field. For example, the available selections may be a + or - sign, numbers, or alphanumeric characters and special characters.
	Down Arrow: This key provides the scroll down function. It moves the selection cursor down a list or decrements the value of alphanumeric entry fields as identified by the flashing cursor. The values provided are dependent on the currently active field. For example, the available selections may be a + or - sign, numbers, or alphanumeric characters and special characters.
	ENTER key. This key accepts the currently entered selection when pressed. If the selection is a menu item, the selected item is accessed. If the current selection is an entered value, pressing the ENTER key accepts the entered value.
	HOME key. This key displays the home screen (MONITORING) when pressed.
	MENU key: Displays the MAIN MENU screen when pressed from any menu level or from the home screen.
	SILENCE key: Alarms cannot be cleared and will continue to recur until the monitored conditions detected by the sensors are within the programmed parameters. Pressing the SILENCE key temporarily silences the local audible alarm and deactivates the auxiliary relay for 10 minutes. If a new alarm originating from a different sensor occurs within this 10-minute period, the audible alarm and aux relay are reactivated, and require another key press to silence the audible alarm.

Base Unit Connections

Figure 5 shows the EA800 base unit's connections and Table 3 describes the functions of each connection.

Note: The base unit has four wired sensor inputs and four wireless RF sensor inputs.

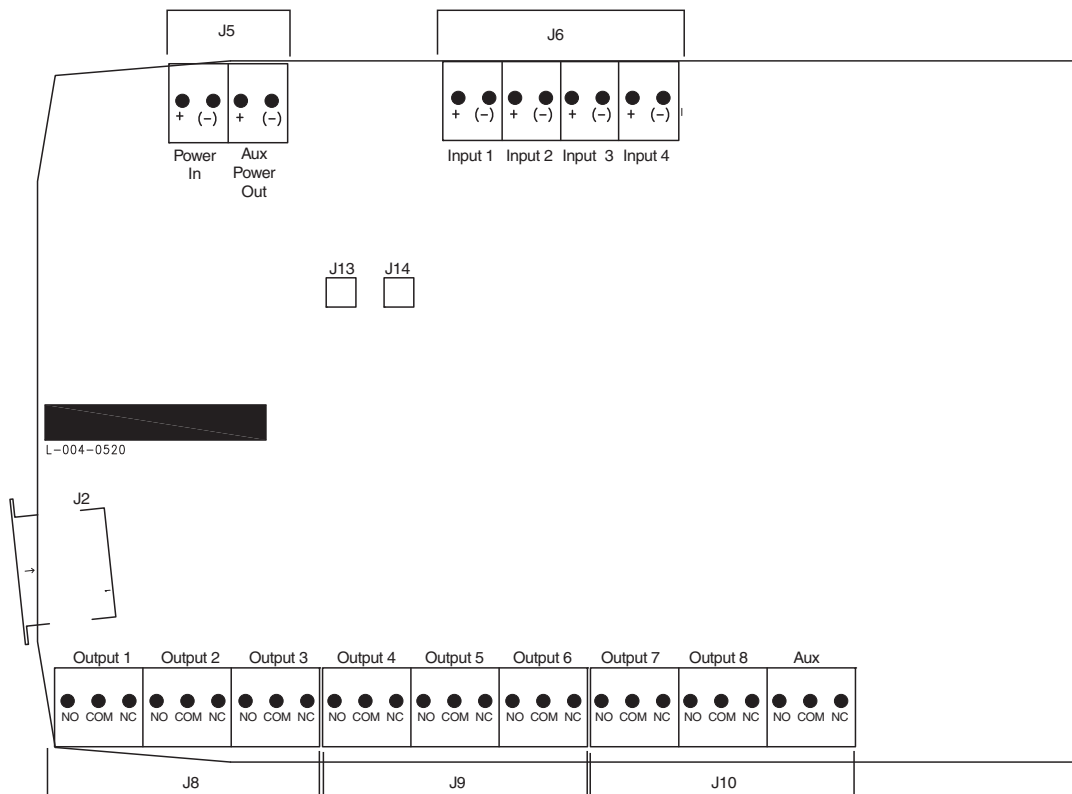

Figure 5 EA800 Base Unit Connections

Table 3 EA800 Base Unit Connector Functions

Connector	Designation	Function
J2	USB	USB Type A connection used to program firmware, export logs, and export and import configuration files. www.winland.com lists compatible USB sticks.
J5	Power In	11-26 VDC input power connection for EA800 base unit (from accessory power supply or alarm panel). CAUTION Observe (+) and (-) polarity markings screened on circuit board. EA800 can be damaged if power polarity is reversed.
	Aux Power Out	11-26 VDC power out connection for EA800 accessories requiring power (such as HA-III+ Humid Alert). This output voltage equals that of Power In and is current-limited to a maximum of 500 mA. CAUTION Connect only accessories specified in this manual to the Aux Power Out connection. Connection of unsuitable loads to this connection may damage the power supply and EA800, or result in improper or unreliable operation. Note: Accuracy for the HA-III+ sensor is stated at +12VDC input. If Aux Power Out is used to power the HA-III+ and is not +12VDC, then the accuracy of the HA-III+ is compromised.

Table 3 EA800 Base Unit Connector Functions — continued

Connector	Designation	Function
J6	INPUT 1	Wired input for Relay 1 external temperature, water, 4-20mA, contact closure, or humidity sensor.
	INPUT 2	Wired input for Relay 2 external temperature, water, 4-20mA, contact closure, or humidity sensor.
	INPUT 3	Wired input for Relay 3 external temperature, water, 4-20mA, contact closure, or humidity sensor.
	INPUT 4	Wired input for Relay 4 external temperature, water, 4-20mA, contact closure, or humidity sensor.
J8	OUTPUT 1	Form C relay alarm output for Relay 1.
	OUTPUT 2	Form C relay alarm output for Relay 2.
	OUTPUT 3	Form C relay alarm output for Relay 3.
J9	OUTPUT 4	Form C relay alarm output for Relay 4.
	OUTPUT 5	Form C relay alarm output for Relay 5.
	OUTPUT 6	Form C relay alarm output for Relay 6.
J10	OUTPUT 7	Form C relay alarm output for Relay 7.
	OUTPUT 8	Form C relay alarm output for Relay 8.
	AUX OUT	Form C relay output that activates upon an alarm from any of the relays (Relay 1 through Relay 8).
J13	Antenna	RF receive and transmit
J14	Antenna	RF receive and transmit

Access Control and Passwords

The EA800 base unit is normally locked to prevent unauthorized use. The currently active function of the **F1** soft key (**UNLOCK** or **LOCK**) is displayed above the key. The locked and unlocked states are described below.

Note: The base unit locks automatically after 30 minutes of inactivity if the user does not press the **LOCK** soft key (**F1**).

- **Locked:** This is the default state and limits access to the EA800 to viewing only. **UNLOCK** is displayed above the **F1** soft key indicates that the base unit is currently locked. Pressing the **F1** soft key prompts the user to enter a password to unlock the base unit, permitting full access to all screens and functions. The **HOME** key, **MENU** key, and the **MAIN MENU** options shown on the screen at right are available to the user when the base unit is locked.



- **Unlocked:** When the base unit is unlocked, **LOCK** displayed above the **F1** soft key, and all information, programming, and maintenance screens may be viewed and programming changes may be made. Pressing the **F1** soft key locks the EA800 base unit and protects it from unauthorized or unintended programming changes, log downloads, and firmware uploads.

The base unit allows the use of two passwords for unlocking:

- The factory default password is **0800**. This password cannot be changed or deleted.
- A second, optional password may be set by the user. To create a second user password, see “Changing the Password” on page 63.

System Configuration Parameters

The EA800 base unit requires certain system level information as outlined in Table 4.

Table 4 System Configuration Parameters

Parameter	Selections	Factory Default	Description
Date Format	<ul style="list-style-type: none"> • MM/DD/YYYY • DD/MM/YYYY 	MM/DD/YYYY	Sets the desired date format for all event time stamps.
Time Format	<ul style="list-style-type: none"> • 12-hour • 24-hour 	24-hour	Sets the desired time format for all event time stamps.
Data Collection Frequency	<ul style="list-style-type: none"> • 30 seconds • 1 minute • 5 minutes • 15 minutes • 30 minutes • 60 minutes 	5 minutes	<p>Sets the interval for collecting and recording data from the sensors. The data collection frequency applies to all sensors. The EA800 provides approximately 10,000 data points to be collected regardless of the frequency selected. The estimated time duration covered for each data collection frequency is listed below.</p> <p>30 seconds = 3.5 days 1 minute = 1 week 5 minutes = 1 month 15 minutes = 3 months 30 minutes = 6 months 60 minutes = 1 year</p>
Buzzer	<ul style="list-style-type: none"> • Enable • Disable 	Enabled	<p>Enables and disables the buzzer when an alarm limit has been exceeded or a warning condition exists.</p> <div style="background-color: black; color: white; padding: 5px; text-align: center;">  WARNING </div> <p>Selecting Disable for this parameter turns the audible alarm buzzer off completely. No audible alarm tone will sound when an alarm occurs if DISABLE is selected.</p>
RF Channel	11 (2405 MHz) 12 (2410 MHz) 13 (2415 MHz) 14 (2420 MHz) 15 (2425 MHz) 16 (2430 MHz) 17 (2435 MHz) 18 (2440 MHz) 19 (2445 MHz) 20 (2450 MHz) 21 (2455 MHz) 22 (2460 MHz) 23 (2465 MHz) 24 (2470 MHz) 25 (2475 MHz) 26 (2480 MHz)	channel 16	Selects the ISM band radio frequency (RF) channel for transmission between the wireless sensors and EA800 base unit.

Sensors

A variety of sensors may be used with the EA800 base unit to provide environmental status and information. These include the following:

- **Wired Sensors:** Relays 1 through 4 are for use with sensors wired to the base unit. Wired sensors can be any of the following types:
 - Low temperature sensors - Blue Thermistor Probes
 - High temperature sensors - Red Thermistor Probes
 - Ultra Low temperature sensors - White Thermistor Probes
 - HA-III+ humidity sensor
 - Water Bug sensor (supervised)
 - N.O. Contact
 - N.C. Contact
 - 4-20 mA
- **Wireless Sensors:** Relays 5 through 8 are for use with wireless sensors. These sensors transmit to the EA800 base unit through RF links. Each wireless sensor is hard-coded with an address the base unit uses to identify the sensors installed in the system. When you program the system you assign each installed wireless sensor to a relay using its hard coded address. Wireless sensors can be any of the following types:
 - Wireless Humidity Sensor (EA-WHS)
 - Wireless Temperature Sensor (EA-WTS)
 - Wireless Multi-Function Sensor (EA-WMFS): Any of the following wired sensors can be connected to the wireless multi-function sensor, effectively converting the wired sensor to wireless:
 - Low temperature sensors - Blue Thermistor Probes
 - High temperature sensors - Red Thermistor Probes
 - Ultra Low temperature sensors - White Thermistor Probes
 - Water Bug sensor (supervised)
 - Normally Open (NO) Contact
 - Normally Closed (NC) Contact

Temperature Sensors

Table 5 lists the temperature sensors available for use with the EA800 Alarm System.

Table 5 EA800 Compatible Temperature Sensors

Sensor	Part Number	Description	Operating Range/Parameters
High Temp Red, Stainless Steel	PN M-001-0081	Thermistor, Stainless Steel Probe, High Temperature Sensor	0° C to 150° C (32° F to 302° F)
Low Temp Blue, Stainless Steel	PN M-001-0082	Thermistor, Stainless Steel Probe, Low Temperature Sensor	-50° C to 70° C (-58° F to 158° F)
Low Temp Blue, waterproof	PN M-001-0086	Thermistor, waterproof, low temperature sensor. For use in coolers and freezers.	-50° C to 70° C (-58° F to 158° F)
High Temp Red, waterproof	PN M-001-0087	Thermistor, waterproof, high temperature sensor	0° C to 150° C (32° F to 302° F)
Ultra Low Temp White, Stainless Steel	PN M-001-0111	Thermistor Stainless Steel Probe, Ultra Low Temperature Sensor	-80° C to 0° C (-112° F to 32° F)
Wireless Temp	PN M-001-0125	Stand alone wireless temperature sensor	0° C to 50° C (32° F to 122° F)

Humidity Sensors

Table 6 lists the humidity sensors available for use with the EA800 Alarm System.

Table 6 EA800 Compatible Humidity Sensors

Sensor	Part Number	Description	Operating Range/Parameters
HA-III+	PN M-001-0091	Humidity monitoring module	5% to 95% rh (non-condensing)
Wireless Humidity	PN M-001-0126	Wireless humidity monitoring module	5% to 95% rh (non-condensing)

4-20mA Sensors

Theory of Operation

Industry standard 4-20mA sensors can be used with the EA800. However, it is important to verify that this type of sensor will operate properly over the entire output range.

Figure 6 shows an example of the loop circuit for a 4-20mA sensor whose minimum operating voltage is 8V or less when connected to an EA800 base unit that is powered with 12VDC.

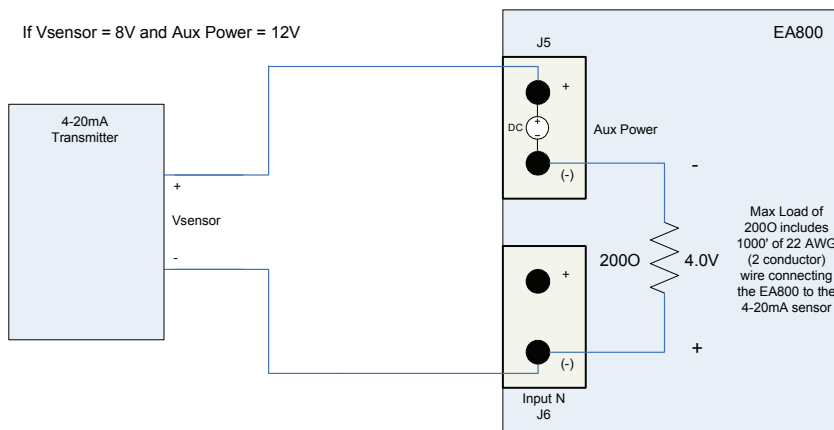

Figure 6 4-20mA Sensor Wiring Diagram - EA800 Aux Power Supply

Figure 7 shows an example of the loop circuit for a 4-20mA sensor whose minimum operating voltage is greater than 8V when connected to an EA800 base unit that is powered with 12VDC.

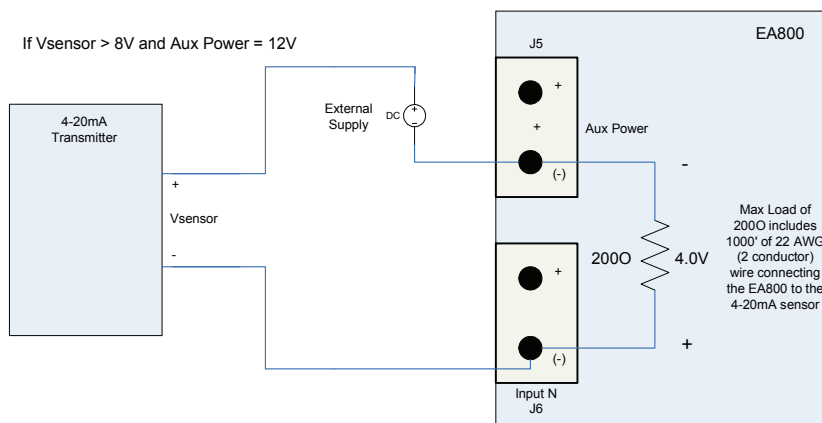

Figure 7 4-20mA Sensor Wiring Diagram - External Power Supply

Power Supply / Sensor Voltage Selection

In order to determine the power supply voltage necessary to ensure correct full-scale operation, it is necessary to identify all voltage drops within the current loop.

Figures 6 and 7 show an EA800 drop of 4.0 VDC. This value accounts for the voltage drop generated by connecting the 4-20mA sensor to the EA800 using 1000 feet of 22 AWG wire.

Now it is only necessary to identify the operating voltage range of the 4-20mA sensor, more importantly the minimum operating voltage. Once identified, the minimum operating voltage of the sensor can be added to the 4.0V voltage drop of the EA800 (+ wire) to determine the power supply voltage necessary to ensure correct full-scale operation.

Example:

- Assume that a 4-20mA sensor whose operating input voltage range is 10 – 30V has been selected for use. Therefore the minimum operating voltage of the sensor is 10V (V_{sensor}). When the 4.0V drop of the EA800 (and wire) is added, it can be determined that at least 14VDC is needed to power the loop.
- If the EA800 is connected to a 12VDC power supply, use of the sensor in this example requires an external power supply of at least 14V as shown in Figure 7.

It is important to not exceed the maximum operating voltage of the 4-20mA sensor, as specified within the sensor's product specification.

The following formula provides the basis for the selection matrix shown in Table 7. Please use Table 7 to select either the proper sensor rating to be used with a known power supply, or select a power supply for a known sensor rating.

$$R_L \leq (V_{cc} - x) .023$$

where:

- R_L = Loop resistance of 200
- V_{cc} = Power supplied to EA800 or Aux Power Out
- X = Sensor voltage (max)

Table 7 4-20mA Voltage Select Matrix

Power Supplied to EA800 or AUX. Power Out	V_{sensor} (max.) [Maximum sensor voltage rating]	Power Supplied to EA800 or AUX. Power Out	V_{sensor} (max.) [Maximum sensor voltage rating]
11 VDC	7 VDC	19 VDC	15 VDC
12 VDC	8 VDC	20 VDC	16 VDC
13 VDC	9 VDC	21 VDC	17 VDC
14 VDC	10 VDC	22 VDC	18 VDC
15 VDC	11 VDC	23 VDC	19 VDC
16 VDC	12 VDC	24 VDC	20 VDC
17 VDC	13 VDC	25 VDC	21 VDC
18 VDC	14 VDC	26 VDC	22 VDC

Water Sensors

Table 8 lists the water sensors available for use with the EA800 Alarm System.

Use of water sensors requires that at least one supervised water sensor be used. Up to five additional unsupervised water sensors may be added in parallel on the same input where the supervised water sensor is configured.

Table 8 EA800 Compatible Water Sensors

Sensor	Part Number	Description	Operating Range/Parameters
Water Bug	PN M-001-0094	Supervised water sensor ¹	NA

¹ Water sensors are not effective nor intended for use in distilled or deionized water.

Multi-Function Sensors

Multi-function wireless sensors may be connected to a wired sensor to act as a transmitter. Table 9 lists the multi-function sensor available for use with the EA800 Alarm System.

Table 9 EA800 Compatible Multi-Function Sensors

Sensor	Part Number	Description	Operating Range/Parameters
Wireless Multi-Function	PN M-001-0127	Wireless link for sensors. See page 16 for allowed sensors.	Dependent on sensor connected.

Contact Closure Sensors

Table 10 lists the contact closure sensors compatible for use with the EA800 Alarm System.

Table 10 EA800 Compatible Closure Sensors

Sensor	Description
NO closure	Normally open contact closure such as door contacts, motion detectors, and glass break sensors
NC closure	Normally closed contact closure such as door contacts, motion detectors, and glass break sensors

Sensor Parameter Descriptions

This section provides a description of each sensor parameter.

Table 11 Sensor Parameter Descriptions

Parameter	Applicable to Sensors	Description															
Sensor Name	All	<p>A name used to identify the sensor in the alarm system. Select a name readily identified by the viewer. The sensor name is displayed on the Main screen during a no-alarm condition and on the Alarm screen during an alarm condition. Two name choice types are available:</p> <ul style="list-style-type: none"> • Common Name: These are preprogrammed names. • Custom Name: This selection allows you to enter any name if the preprogrammed common names do not adequately identify the sensor in the system (limited to 16 characters). <p>Note: Duplicate sensor names are not permitted.</p>															
Unit of Measure	<ul style="list-style-type: none"> • Blue, Red and White temperature sensors • 4-20mA sensor • Wireless temperature sensors 	<p>This parameter allows you to choose the unit of measure used for sensor reading and display.</p> <ul style="list-style-type: none"> • Blue, Red and White temperature sensors: °C or °F • 4-20mA sensors: the following Common Units of measure are available: F (Fahrenheit), C (Centigrade), K (Kelvin), % rh (percent relative humidity), psi (pounds per square inch), Pa (Pascals), kPa (kiloPascals), lb (pound), kg (kilogram) • 4-20mA sensors can also use custom units. Enter the appropriate units for the connected 4-20mA sensor via the keypad. 															
Resolution	4-20mA sensor	<p>This determines the range that may be used for the 4-20mA sensor. The full scale range is determined by the values entered in the Low Scaled Value and the High Scaled Value. You must select the correct resolution in order to set the true range limits for the 4-20mA sensor you are installing. The available values are as follows:</p> <table border="1"> <thead> <tr> <th>Resolution</th> <th>Maximum Allowed Low Scaled Value</th> <th>Maximum Allowed High Scaled Value</th> </tr> </thead> <tbody> <tr> <td>1.</td> <td>-9999.</td> <td>+9999.</td> </tr> <tr> <td>0.1</td> <td>-999.9</td> <td>+999.9</td> </tr> <tr> <td>0.01</td> <td>-99.99</td> <td>+99.99</td> </tr> <tr> <td>0.001</td> <td>-9.999</td> <td>+9.999</td> </tr> </tbody> </table>	Resolution	Maximum Allowed Low Scaled Value	Maximum Allowed High Scaled Value	1.	-9999.	+9999.	0.1	-999.9	+999.9	0.01	-99.99	+99.99	0.001	-9.999	+9.999
Resolution	Maximum Allowed Low Scaled Value	Maximum Allowed High Scaled Value															
1.	-9999.	+9999.															
0.1	-999.9	+999.9															
0.01	-99.99	+99.99															
0.001	-9.999	+9.999															
Low Scaled Value	4-20mA sensor	This parameter equals the environmental reading that results in a sensor output of 4mA or its minimum valid reading. This is dependent on the setting of the resolution as discussed above.															
High Scaled Value	4-20mA sensor	This parameter equals the environmental reading that results in a sensor output of 20mA or its maximum valid reading. This is dependent on the setting of the resolution as discussed above.															
Hysteresis	<ul style="list-style-type: none"> • Blue, Red and White temperature sensors • HA-III+ • 4-20mA sensor 	The Hysteresis setting helps prevent alarms from being set and reset continually if the environment is at or near the alarm set point by providing an acceptable variance. For example, if Hysteresis is set at 2 and the sensor High limit is set at 50, the sensor reading must decrease to 48 (50 minus 2) in order for the alarm condition to reset to a no-alarm condition.															
Low Alarm Limit	<ul style="list-style-type: none"> • Blue, Red and White temperature sensors • HA-III+ • 4-20mA sensor • Wireless humidity sensor • Wireless temperature sensor 	The Low Alarm Limit sets the value that trips the low alarm when exceeded.															

Table 11 Sensor Parameter Descriptions — continued

Parameter	Applicable to Sensors	Description
High Alarm Limit	<ul style="list-style-type: none"> • Blue, Red and White temperature sensors • HA-III+ • 4-20mA sensor • Wireless humidity sensor • Wireless temperature sensor 	The High Alarm Limit sets the value that trips the high alarm when exceeded.
Alarm Delay Time	All	This sets the time period that an alarm condition can exist before the alarm is triggered. This is useful for helping to prevent false alarms from occurring in situations where normal activities cause conditions to temporarily exceed alarm thresholds. For example, the temperature in a freezer may temporarily rise above the High alarm limit while frozen food is being restocked and the freezer door is open, but the delay prevents the alarm from going off unless the temperature fails to cool below the alarm threshold within the alarm delay period.

Relay Operation

This section describes the operation of the base unit's relays. The relays must be programmed correctly so that their outputs provide the desired signaling to the alarm panel.

Table 12 Relay Configuration Settings

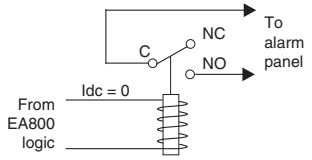
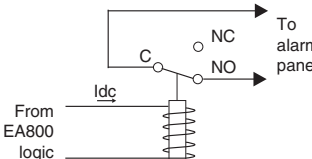
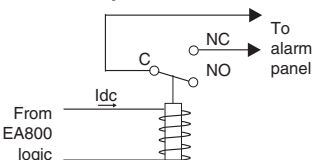
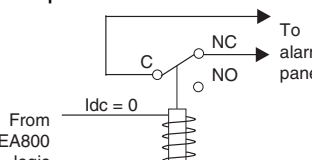
Relay Setting	Description
No Alarm Relay State: De-Energized (default)	<p>No Alarm: Power is removed from the relay coil as shown below.</p>  <p>Alarm: Power is applied to the relay coil as shown below.</p> 
No Alarm Relay State: Energized	<p>No Alarm: Power is applied to the relay coil as shown below.</p>  <p>Alarm: Power is removed from the relay coil as shown below. This provides for a default alarm if the EA800 loses power in addition to the sensors' alarms.</p> 
Active Condition: Alarm Only	Sets the alarm to be active when an alarm condition exists.
Active Condition: Alarm or Warning (default)	Sets the alarm to be active when an alarm condition exists or a warning is active.

Preparation

Before you begin installation, ensure that you properly plan the alarm system. During the planning phase you will generate all the documentation you need to successfully install the EA800 base unit and sensors in the alarm system. This is important because complete and accurate installation documentation aids in system maintenance later.

CAUTION

If the EA800 base unit will be connected to a remote alarm panel, do not connect the base unit to the alarm panel until after sensor connection and configuration is complete. Connecting the remote alarm panel before configuring the EA800 sensors will result in false alarms at the remote panel.

The suggested preparation procedure is as follows:

1. Read and understand the entire manual. General Information provides important information required to properly plan, install, and use the EA800. The preparation phase helps ensure that the EA800 system will function as required.
2. Photocopy the pages of Appendix B: Planning Worksheet, Appendix C: EA800 Wiring Diagram (one for each EA800 base unit in the system), and Appendix D: System Configuration Record to create a record of the specific EA800 alarm system installation you are currently working on.
3. Draw a floor plan for the facility where you will install the EA800 alarm system. Identify important details such as the coolers, doors, computer rooms, etc. An example is shown below.

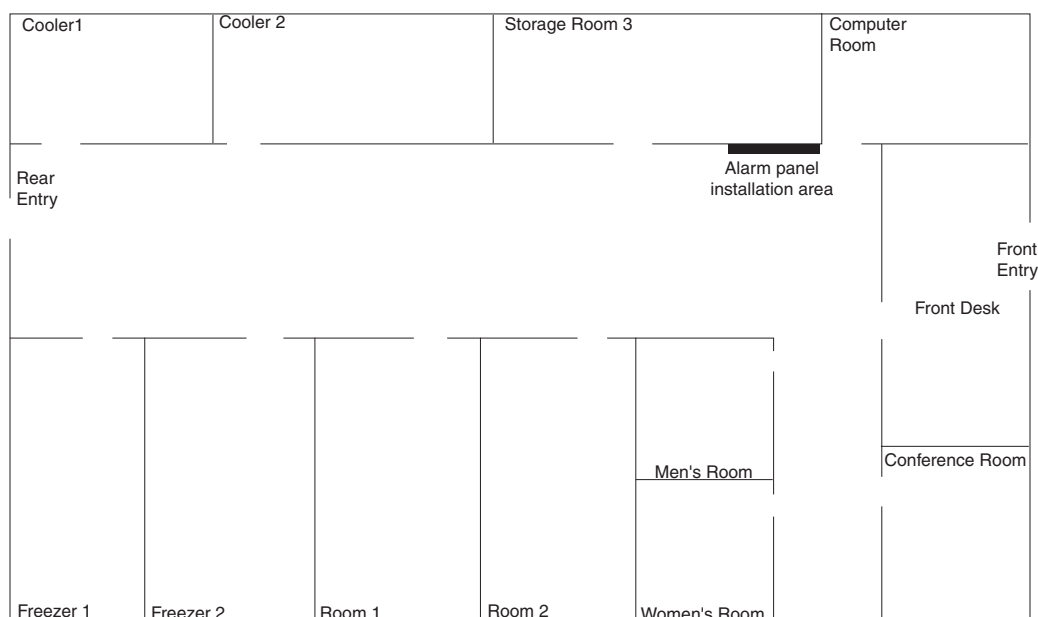

Figure 8 Example Floor Plan

4. Locate the base unit where authorized personnel can readily access it. If required, consideration should be made regarding a location that discourages unauthorized access. If using wireless sensors, locate the base unit to minimize the wireless distance. Ensure that the desired mounting locations for the EA800 base unit and each sensor comply with the environmental specifications listed in Table 13: Specifications.

CAUTION

Do not install the EA800 base unit in coolers or freezers.

CAUTION

Use only wired sensors specified in this manual for the INPUT 1 through INPUT 4 connections. Unverified sensors may damage the EA800 or result in improper or unreliable operation.

-
5. Complete the copy of Appendix B: Planning Worksheet for the facility in which the EA800 system is to be installed. This must include all monitored areas for the total security system so that you know how many EA800 base units are needed.
 6. Determine the sensors required from the Planning Worksheet you completed and the information provided for each sensor type in “System Configuration”. Enter these in the copy of the System Configuration Record you made.

Note: When water sensors are required, you must use at least one supervised water sensor and may add up to five additional unsupervised water sensors, all in parallel. Thus, an alarm on any sensor will result in an alarm with no way to determine which sensor is the source.

7. Enter the sensor information in the copy of the EA800 Wiring Diagram you made. It is a good idea to name each sensor on this diagram and use that name in both the EA800 Wiring Diagram and the System Configuration Record. This helps ensure proper programming of the system after you have physically installed the system.



EA800 relay outputs are intended only for use as low-voltage, low-current alarm connections, and not for direct switching or control of AC-mains powered loads. Additionally, local codes may further dictate or limit the types of loads and associated wiring to be used with the low-current Form C relay outputs used with the EA800. Connecting AC-mains type circuits to the EA800 may result in an electric shock and/or fire hazard.



Do not connect a load to the AUX OUT or OUTPUT 1 through OUTPUT 8 relay outputs that exceeds limitations stated in the Specifications section of this manual. Loads exceeding the specified limitations may damage the EA800, or result in improper or unreliable operation.

8. Using the floor plan you created, identify the specific locations for each sensor and verify that their locations meet the specifications. See Specifications for operational parameters such as cable length.

Note: For 4-20mA sensors: See 4-20mA Sensors for a discussion of determining the constraints for your 4-20mA sensor to ensure accuracy over its rated range.

9. Determine the channel to use for the wireless sensors. If more than one EA800 is being installed on-site, it is recommended that they be configured to use different channels.
10. The wireless sensor must be located so that the wireless signal strength is adequate as outlined in Winland Application Note AN00101. You must verify that the wireless sensors can communicate with the base unit before you permanently mount them.

Note: Certain environments may present conditions that intermittently cause interference with wireless sensor to base unit communications. You should understand the environment in which the EA800 is to operate to minimize their affects on system performance.

11. Decide the loop design you will use. Figure 9 shows an alarm loop where alarm power is derived from the alarm loop. Figure 10 shows an alarm loop where alarm power is derived from the power supply feeding the EA800.

Note: if using a self-powered loop, ensure the power supply can provide power for all loading conditions.

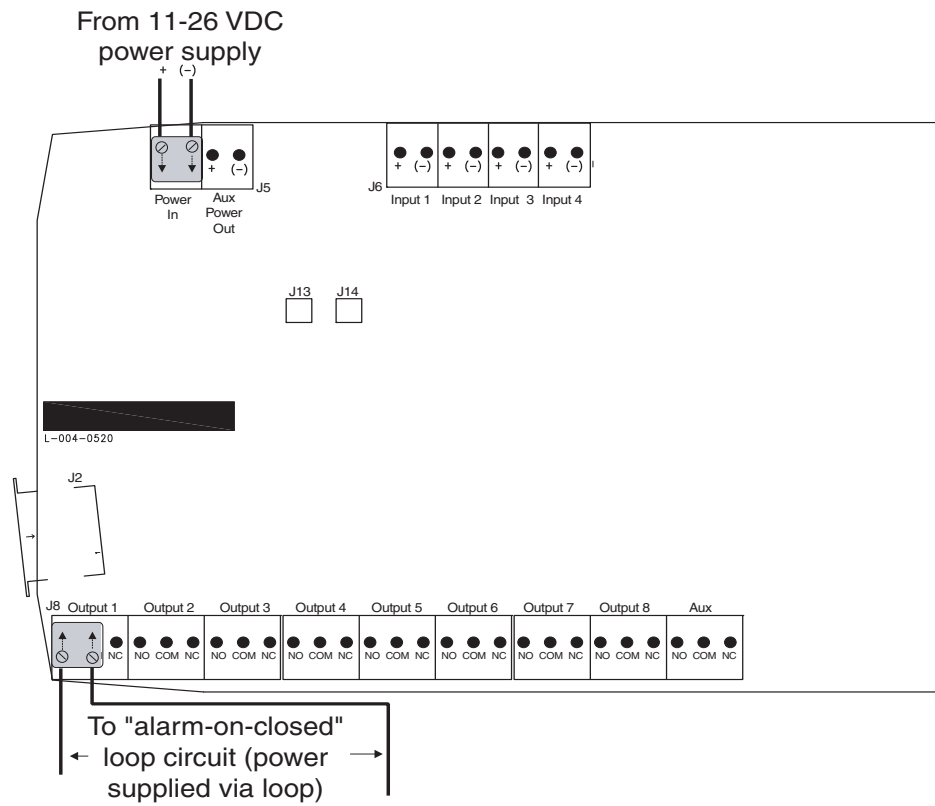

Figure 9 Typical Alarm Loop Wiring Configuration (External Power)

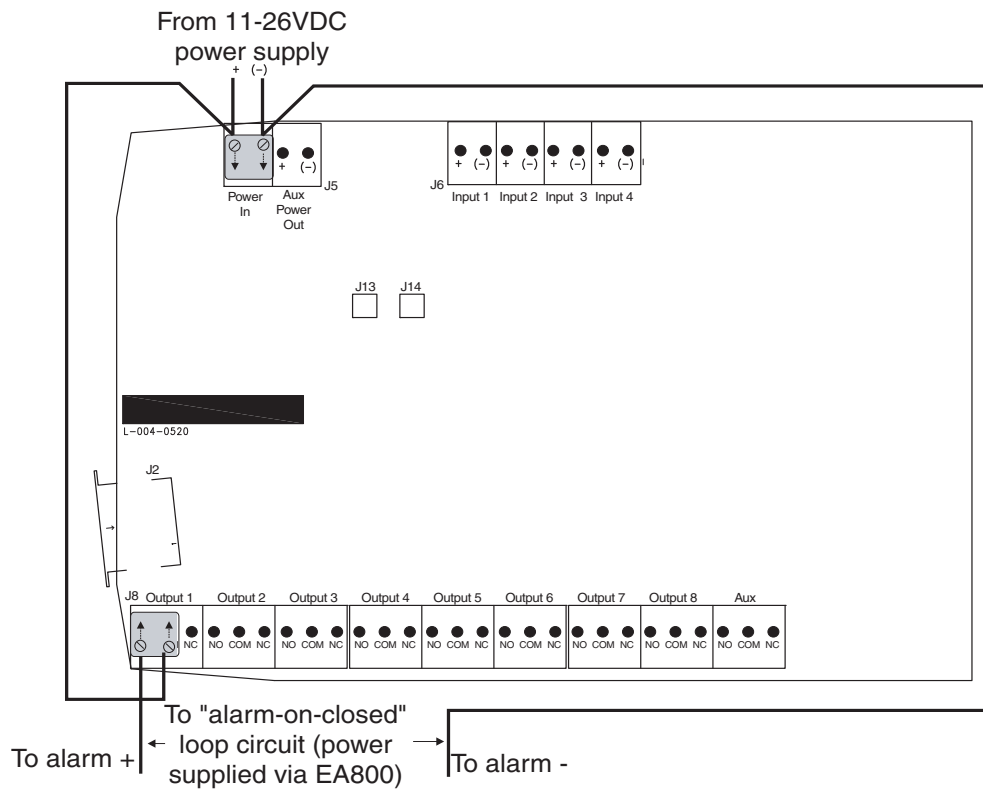

Figure 10 Typical Alarm Loop Wiring Configuration (Self-Powered)

12. Create an interconnect wiring diagram for the system. Identify the location of each sensor. An example of a system map is shown in Figure 11. This example illustrates a system that includes multiple EA800 Multi-Zone Environmental Alarm systems, a Winland EA400 Multi-Zone Environmental Alarm system, and a Winland EA200 Multi-Zone Environmental Alarm system.

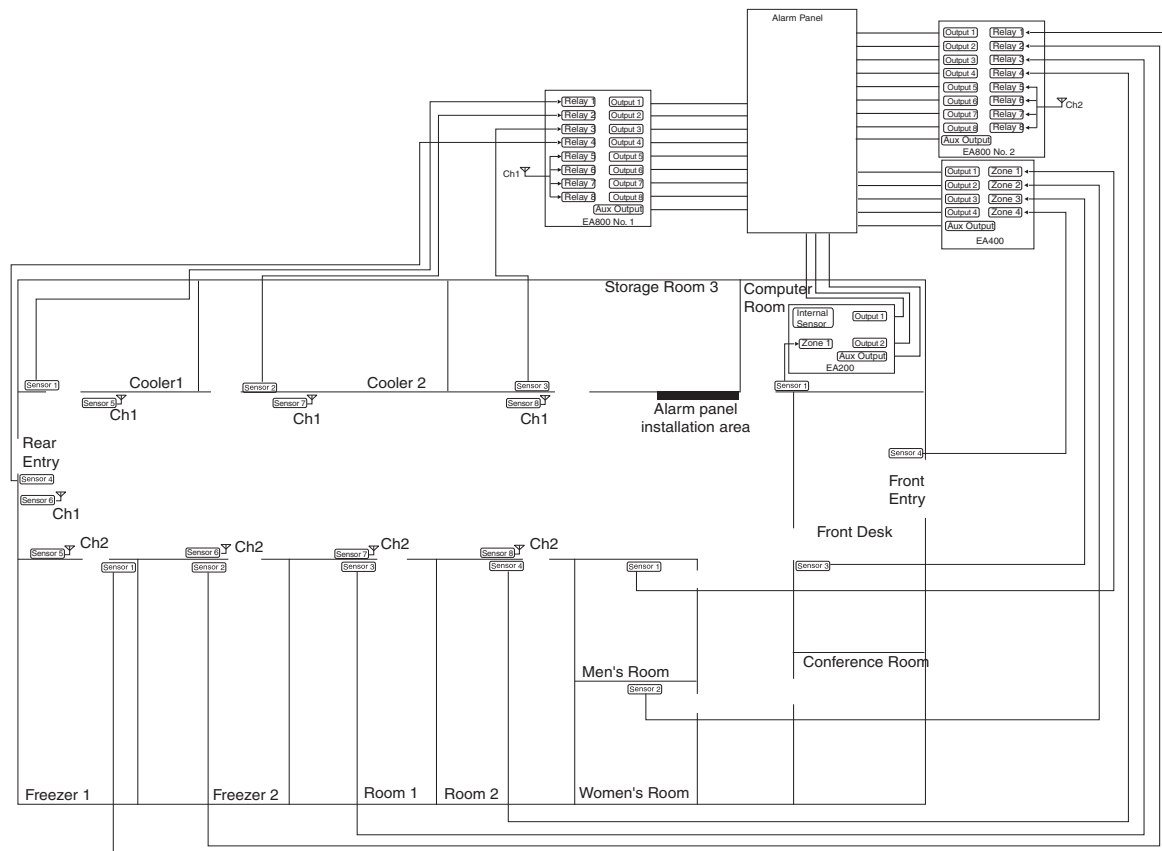

Figure 11 System Interconnect Wiring Diagram Example

13. Determine the cabling required to complete the installation as indicated by the loop design, the sensors you have selected, and the system interconnect wiring diagram.
14. Complete the System Configuration section on the copy of the System Configuration Record you made. See System Configuration for a description of each system level parameter.

When you have completed the previous steps you are ready to proceed to physically install the EA800 base unit and its associated sensors using the documentation you have just created.

Tools and Supplies Required

Ensure that you have the following prior to starting the installation:

- Phillips Screwdriver
- Mounting hardware for the EA800 base unit and any optional sensor units
- If required, a drill and the appropriate drill bits
- Wire stripper
- Sensors (not supplied; see “Accessories” on page 54)
- Sensor Wiring (typically 18-22 AWG twisted-pair; not supplied)
- Alarm Wiring (typically 18-22 AWG; see EA800 Output (Alarm) Connections)
- Power sources

Power Requirements

All power terminals must be connected to a Class 2 power limited circuit complying with the National Electric Code NFPA 70, Article 725. Where required, this equipment is to be isolated from the mains supply by a limited power source as specified in EN60950.

WARNING

EA800 relay outputs are intended only for use as low-voltage, low-current alarm connections, and not for direct switching or control of AC-mains powered loads. Additionally, local codes may further dictate or limit the types of loads and associated wiring to be used with the low-current Form C relay outputs used with the EA800. Connecting AC-mains type circuits to the EA800 may result in an electric shock and/or fire hazard.

CAUTION

Connect only sensors specified in this manual to the wired and wireless input connections. Using sensors not specified in this manual may damage the EA800 or cause improper or unreliable operation.

CAUTION

Do not connect a load to the AUX OUT or OUTPUT 1 through OUTPUT 8 relay outputs that exceeds limitations stated in the Specifications section of this manual. Loads exceeding the specified limitations may damage the EA800, or result in improper or unreliable operation.

CAUTION

The EA800 printed circuit board (PCB) contains electrostatic discharge (ESD) sensitive devices. To help prevent damage caused by ESD, observe appropriate ESD handling rules whenever the PCB in the EA800 is exposed.

CAUTION

Batteries shall not cause explosion or produce a fire HAZARD as a result of excessive charge or discharge, or if a battery is installed with incorrect polarity.

CAUTION

If the equipment is used in a manner not specified by the manufacturer, the protection provided by the equipment may be impaired.

Mounting the EA800 Rear Plate

The base unit has a removable rear plate that may be attached to a 3-gang electrical enclosure or directly to a wall.

1. Remove the rear mounting plate from the base unit as follows:
 - Pull the rear mounting plate down and away from the EA800 main chassis. The retainer tabs on the main chassis disengage from the holes in the rear mounting plate.
 - Completely remove the mounting plate from the base unit by disengaging the mounting plate hinges from the mating tabs on the base unit.

Install the Wired Sensors

2. Mount the mounting plate as follows:
 - Mounting to 3-gang enclosure: Use four (4) machine screws to secure the mounting plate to the mating holes in the 3-gang enclosure.
 - Mounting to drywall surface: Place the mounting plate in mounting position. Mark the four mounting hole locations. Install drywall anchors and secure the mounting plate to the anchors.

Note: If wall-mounted, prepare a wiring access hole at this time. All wiring must pass through the opening in the center of mounting plate.

Install the Wired Sensors

Install the wired sensors in accordance with the instructions provided with the wired sensors.

1. Mount each wired sensor in its designated location.
2. Label each sensor's wires for easy identification.
3. Route the wires from the sensor to the base unit and dress the wires as required by local code. It is important to ensure that the wires are protected along their entire length, are not stressed at any point, and are adequately supported along their entire length.
4. Pass the wires through the mounted EA800 rear panel.

EA800 Base Unit Power Connections



Do not connect or disconnect power, sensor, or alarm wiring while power is applied. Connecting and disconnecting the EA800 base unit with power connected may damage the base unit or result in improper or unreliable operation.



Connection of unsuitable loads to this connection may damage the power supply and EA800 base unit, or result in improper or unreliable operation.

Note: Do not apply power to the base unit until you are ready to begin sensor programming. The base unit has a 30-minute timer that starts when the unit is first powered up. If at least one sensor is not added and programmed within the 30-minute time period, an alarm will occur.

1. Using a terminal block adapter, connect power supply + and - leads to **POWER IN (+)** and **(-)** on **J5**. Observe proper polarity. If using a transformer, ensure that the transformer is an isolated power supply.
2. If Aux Power Out is to be used, connect + and - leads to **AUX POWER OUT (+)** and **(-)** on **J5** using a terminal block adapter.

Install the Wireless Sensors



If the EA800 base unit will be connected to a remote alarm panel, do not connect the base unit to the alarm panel until after sensor connection and configuration is complete. Connecting the remote alarm panel before configuring the EA800 sensors will result in false alarms at the remote panel.

Note: Verify that the wireless sensors can communicate with the base unit as outlined in the following procedure before permanently mounting them.

1. Remove the cover from the wireless sensors and record the MAC addresses (see Figure 12) of each wireless sensor on the Configuration Worksheet you completed during the preparation phase. The MAC address is printed on a label affixed to each wireless sensor's printed circuit board (PCB) and is used to identify each sensor during programming.
2. Temporarily mount the front panel of the base unit to the mounted rear panel.
3. Connect power to the EA800. The EA800 completes its boot process and the **MONITORING** or **NO SENSORS INSTALLED** (if there are currently no wireless sensors installed) screen is displayed.
4. With the wireless sensors located near the base unit, connect power to each wireless sensor.
5. Unlock the keypad and allow the base unit to detect the wireless sensors using the following procedure.

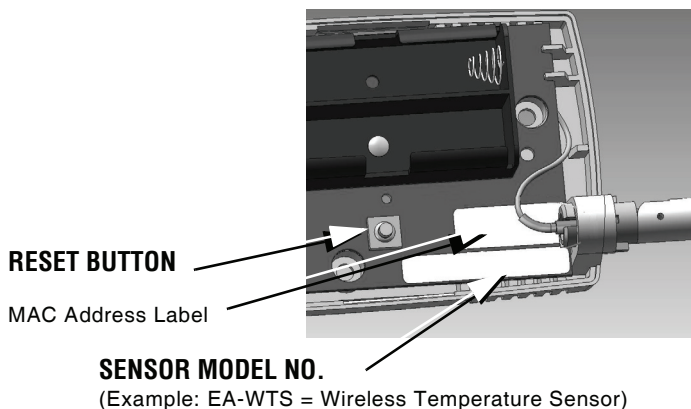
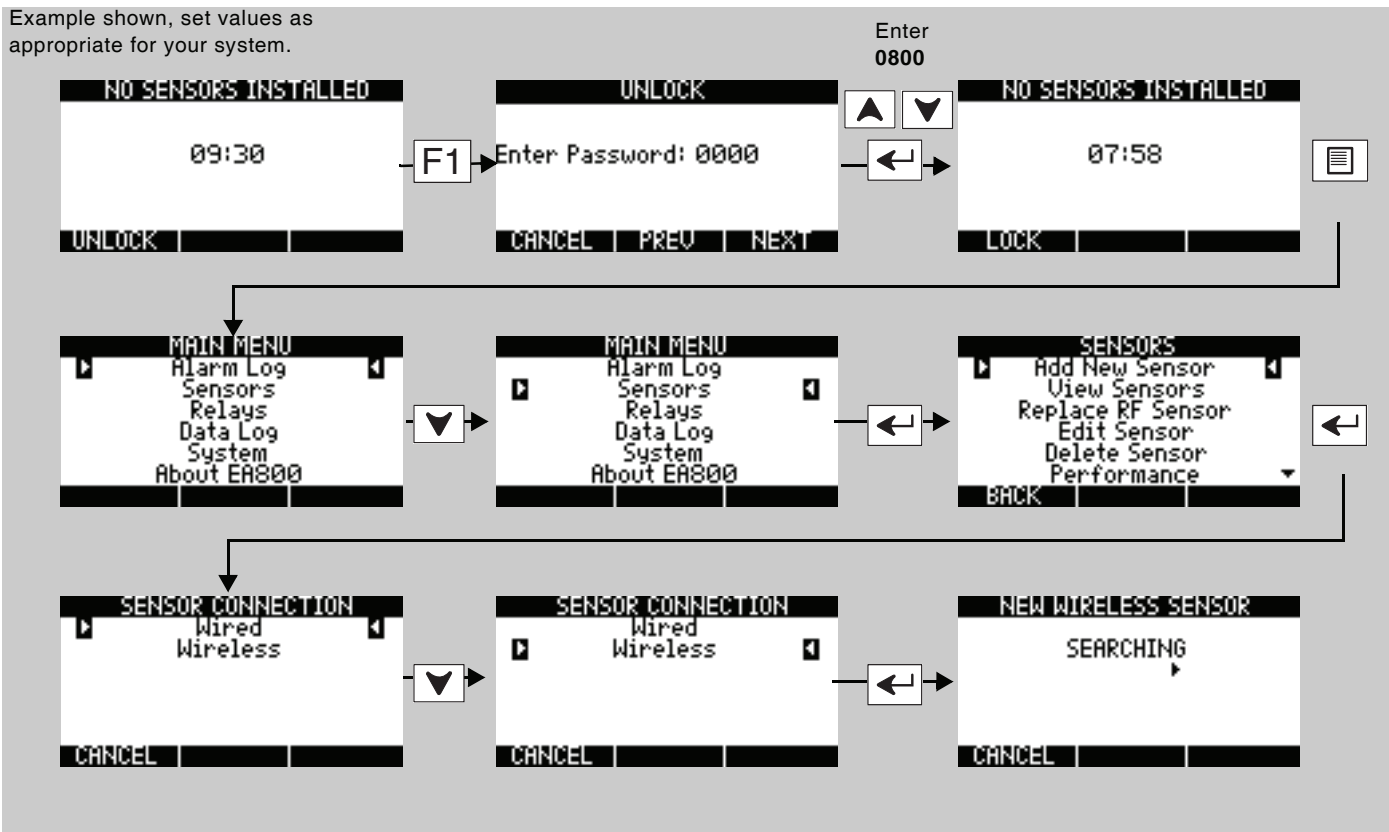

Figure 12 Wireless Sensor MAC Address Location

Note: The keypad locks automatically after 30 minutes of inactivity (no key presses). If you have not finished the detection and programming process for a sensor and this occurs, entered values are lost and you must start the programming procedure for the sensor from the beginning. It is recommended that you allow the base unit to identify the wireless sensors one at a time, with the sensors unmounted and in the same location as the base unit.

Example shown, set values as appropriate for your system.



Note: It may take a few minutes for the base unit to detect the wireless sensors.

At this point the **NEW WIRELESS SENSOR** screen is displayed and an arrow moves from left to right indicating that the EA800 is waiting to receive sensor ID data. When the EA800 has communicated with the reachable sensors the **SELECT SENSOR** screen displays a list of wireless sensors detected.

- When a sensor is detected, confirm that the ID number shown matches the ID number on the sensor's label.
- If the sensors can communicate with the EA800, their IDs appear in the list as shown in the example at right. Do not permanently install the sensors that appear in the list until you verify their signal strength when you program the wireless sensors in the system later in the installation process.
- If the list of number(s) on the screen does not contain the number found on the sensor's PC board, press **F1 (CANCEL)** to continue the search process.

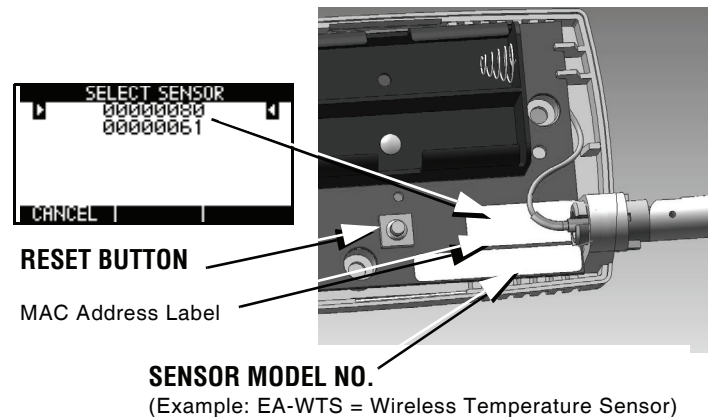

Figure 13 Wireless Sensor IDs and MAC Address Location

Note: Press the Reset Button on the sensor to restart the search process if necessary.

After the base unit has identified each wireless sensor and you have programmed it, temporarily mount it in its desired location using tape. This allows the sensor to be relocated if necessary in order to obtain good signal strength

Connecting Wired Temperature, Contact Closure, and Water Bug Sensors

1. Make certain the sensor's wiring is passed through the opening in the mounting plate.
2. Remove the adapter from the correct input connector header by pulling the adapter up and off of the circuit board header connector.
3. Strip the ends of each of the sensor's wires as indicated by the gauge on adapter you just removed.
4. Insert the stripped wire ends into screw terminals of the adapter as indicated by the EA800 Wiring Diagram you completed in the preparation phase. There is no need to observe polarity when connecting sensor wires. See Figure 14.

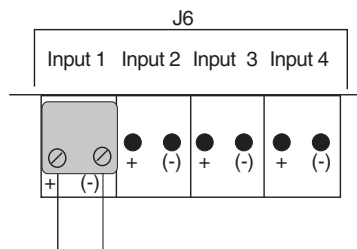

Figure 14 EA800 Base Unit Wired Temperature, Contact Closure, and Water Bug Sensor Connections

5. Secure the connections using the setscrews on the adapter. Check the connection by lightly pulling on each connection.
6. After connecting the wire ends to the adapter, align the adapter to the correct header pins as indicated by your EA800 Wiring Diagram, and press the adapter fully onto the header connector pins.

Connecting Wired HA-III+ Humidity Sensors

1. Make certain the sensor's wiring is passed through the opening in the mounting plate.
2. Remove the adapter from the correct input connector headers by pulling the adapter up and off of the circuit board header connectors.
3. Strip the ends of each of the sensor's wires as indicated by the gauge on adapter you just removed.
4. Insert the stripped wire ends into screw terminals of the adapter as indicated by your EA800 Wiring Diagram you completed in the preparation phase. Observe proper polarity. See Figure 15.

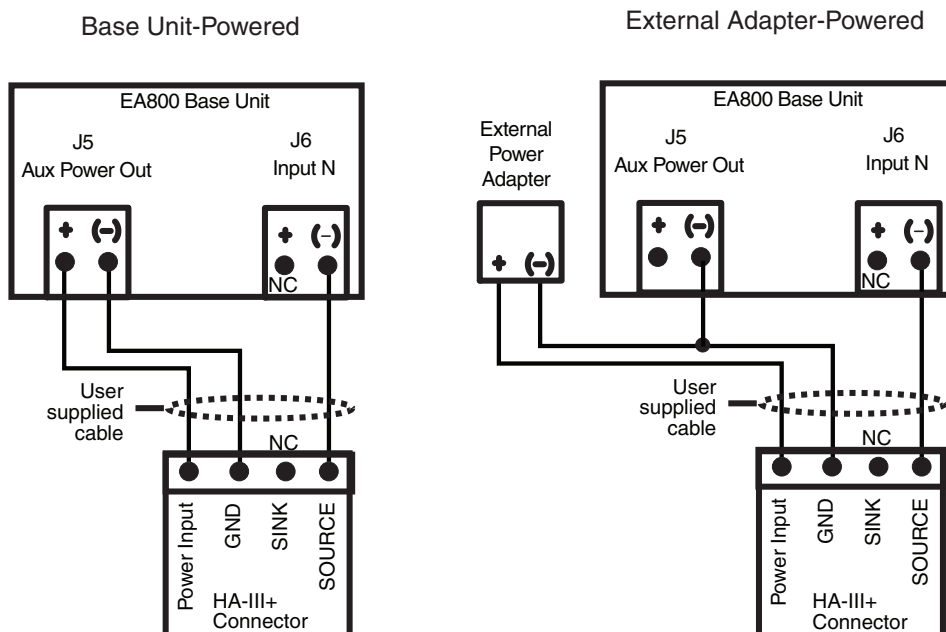

Figure 15 EA800 Base Unit Wired HA-III+ Sensor Connections

5. Secure the connections using the setscrews on the adapter. Check the connection by lightly pulling on each connection.
6. After connecting the wire ends to the adapter, align the adapter to the correct header pins as indicated by your EA800 Wiring Diagram, and press the adapter fully onto the header connector pins.

Connecting Wired 4-20mA Sensors

1. Make certain the sensor's wiring is passed through the opening in the mounting plate.
2. Remove the adapter from the correct input connector headers by pulling the adapter up and off of the circuit board header connectors.
3. Strip the ends of each of the sensor's wires as indicated by the gauge on adapter you just removed.
4. Insert the stripped wire ends into screw terminals of the adapter as indicated by your EA800 Wiring Diagram you completed in the preparation phase. Observe proper polarity. See Figure 15.

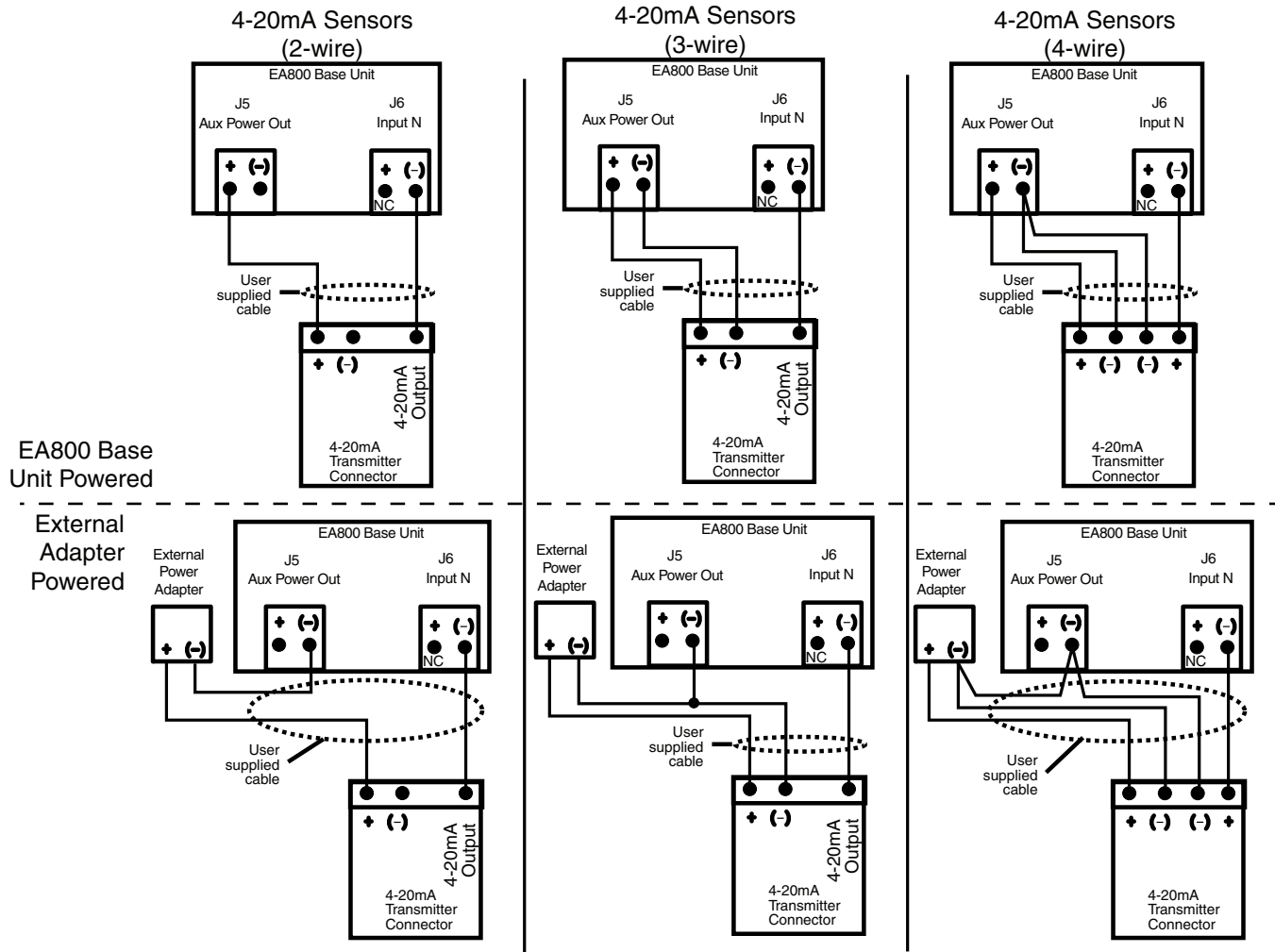

Figure 16 EA800 Base Unit Wired 4-20mA Sensor Connections

5. Secure the connections using the setscrews on the adapter. Check the connection by lightly pulling on each connection.
6. After connecting the wire ends to the adapter, align the adapter to the correct header pins as indicated by your EA800 Wiring Diagram, and press the adapter fully onto the header connector pins.

Connecting the EA800 Alarm Outputs



If the EA800 base unit will be connected to a remote alarm panel, do not connect the base unit to the alarm panel until after sensor connection and configuration is complete. Connecting the remote alarm panel before configuring the EA800 sensors will result in false alarms at the remote panel.

1. If alarm loops will be controlled by the EA800, install all required wiring from alarm loops to the EA800 mounting location.
2. Connect the alarm loop leads to the terminal block adapter. Attach the adapter to terminals C and either NC or NO on the appropriate circuit board header connector.
3. Repeat the previous step for each alarm loop.
4. Engage the mating tabs on the EA800 main chassis into the mounting plate upper hinges.
5. Pivot the bottom of the EA800 main chassis into closed position while aligning the retainer tabs on the main chassis with the holes in the rear mounting plate and ensure that the wiring is not pinched, stressed, or protruding between the chassis halves.
6. Snap the main chassis closed onto the mounting plate. When properly closed, the main chassis and mounting plate mating surfaces are flush.

Programming

When powered-up, the EA800 is ready for programming. The following is an overview of the general process for programming the EA800:

- View the **MAIN MENU** and unlock the EA800 as described in “Accessing the MAIN MENU for Programming” on page 28.
- Set the system configuration as described in “Configuring System Parameter Settings” on page 28.
- Set the current date as described in “Setting the Current Date” on page 31.
- Set the current time as described in “Setting the Time” on page 32.
- Add the wireless sensors. See the appropriate subsection under “Adding Wireless Sensors” on page 33.
- Add the wired sensors. See the appropriate subsection under “Adding Wired Sensors” on page 43.
- Verify performance of the wireless sensors. See “Verify Wireless Signal Strength” on page 42.
- Configure the relays. See “Configuring the Relays” on page 48.



If the EA800 base unit will be connected to a remote alarm panel, do not connect the base unit to the alarm panel until after sensor connection and configuration is complete. Connecting the remote alarm panel before configuring the EA800 sensors will result in false alarms at the remote panel.

Note: When no sensors are programmed in the EA800 system, the EA800 base unit boots up with a 30-minute delay before the alarm buzzer sounds. At this time the Alarm screen is displayed with a System Alarm caused by the fact that no sensors have been programmed yet. To prevent the System Alarm from going off, you must program at least 1 connected sensor into the EA800 base unit prior to the end of the 30-minute alarm time-out. If the alarm buzzer sounds press the Alarm Silence key to temporarily silence the alarm buzzer.

Accessing the MAIN MENU for Programming

- If not already powered up, apply power to the EA800 base unit. During the boot process:
 - The Winland Electronics splash screen is displayed.
 - The system verifies flash memory, as indicated by **FLASH BOOT** at the bottom of the screen.
 - The **About** screen is displayed.
 - The **MONITORING** screen is displayed. **UNLOCK** appears above the **F1** soft key.
- Follow the steps below to unlock the keypad and access the **MAIN MENU** screen.

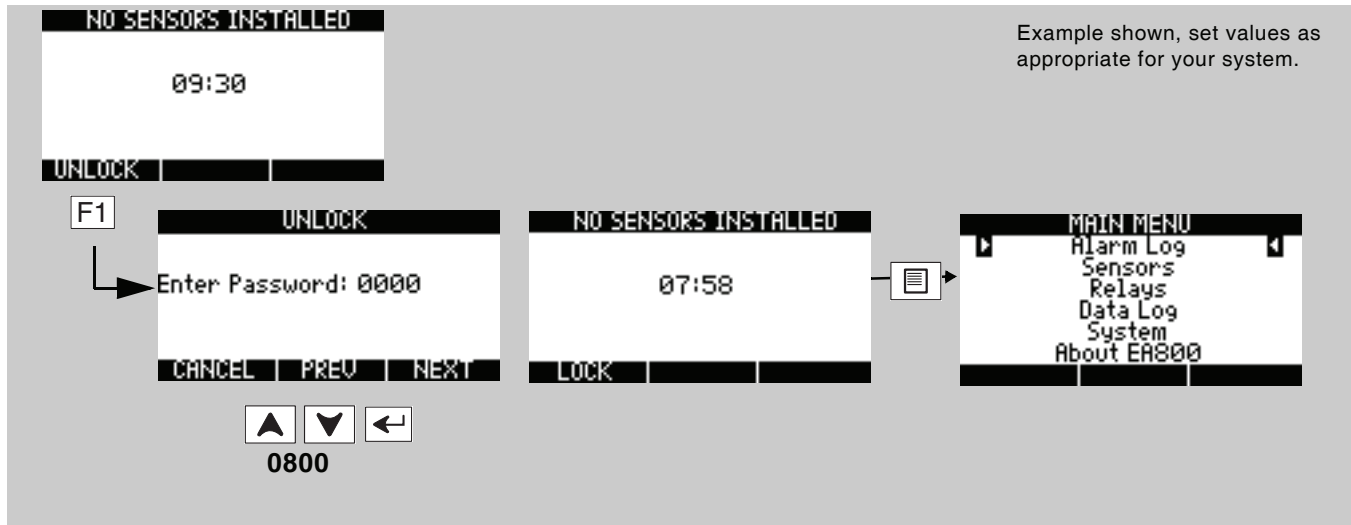

Note: If the password entered was incorrect, the **INVALID PASSWORD** screen is displayed. If this happens, press the **OK** soft key (**F3**) to try again. The 0800 password is a permanent password that can always be used to unlock the base unit even if a different password has been set.

Note: Because there are no sensors programmed into the EA800 base unit the buzzer will sound when the timer reaches 00:00 seconds. Press  to temporarily silence the buzzer.

You can now access the **MAIN MENU** programming functions.

Configuring System Parameter Settings

Configuring the system settings consists of selecting date and time display format, setting sensor data collection frequency, and enabling or disabling the audible alarm. The default system configuration parameter settings are shown on page 14. To configure the system settings, do the following:

- Unlock the base unit and access the **MAIN MENU**.
- When programming, use the arrow keys, the Enter key , and the three soft keys to advance through the menus and enter the appropriate information.

3. Enter the **SYSTEM** menu and then select the **CONFIGURATION** menu as shown below.

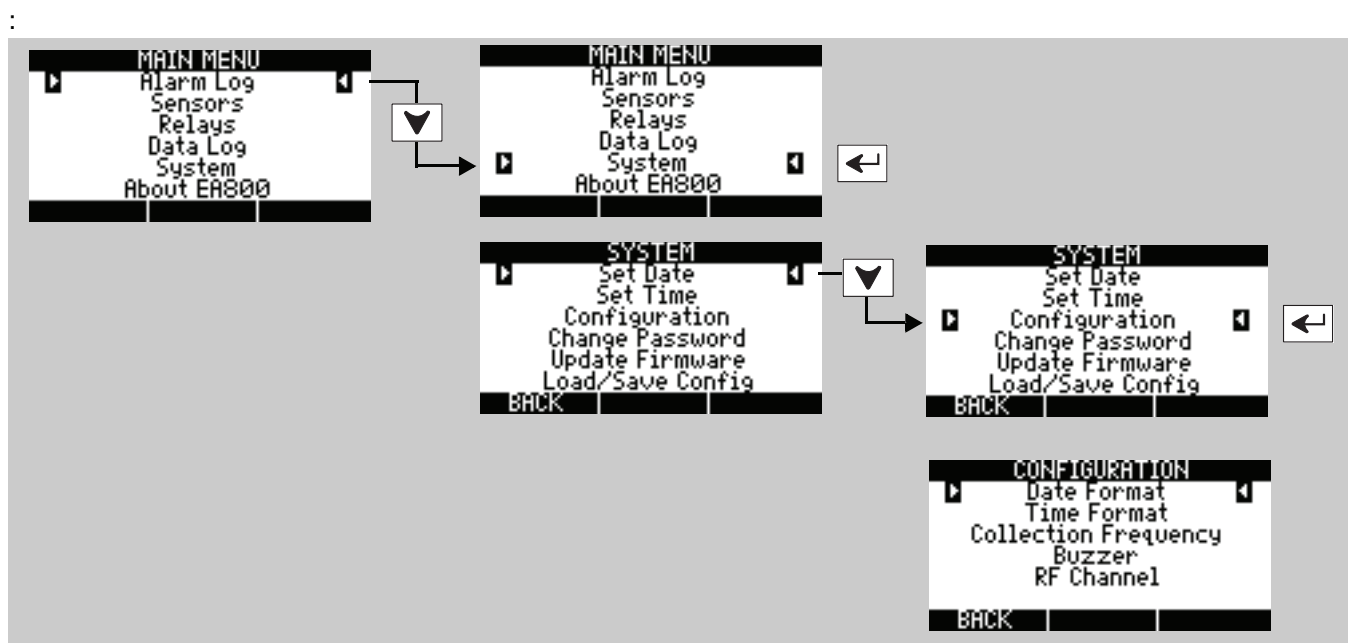

4. The default date format is MM/DD/YYYY. If you prefer DD/MM/YYYY format, from the **CONFIGURATION** menu, set the **DATE FORMAT** as appropriate for your region.

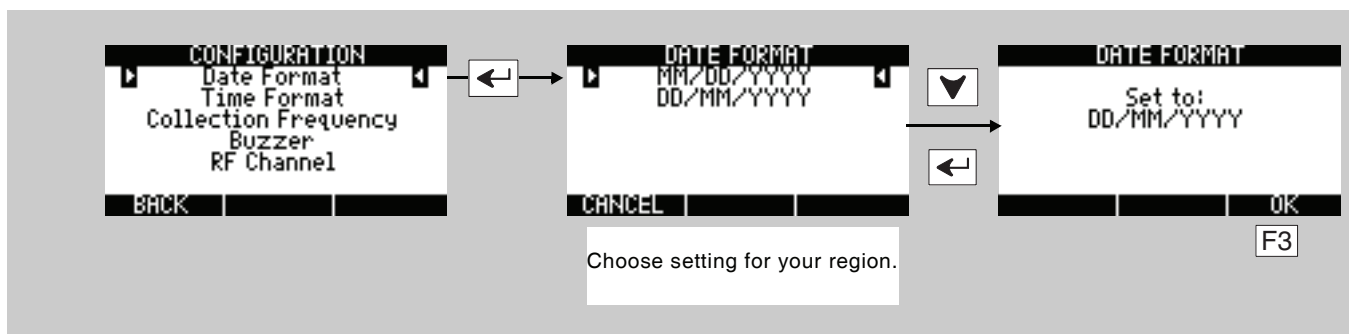

5. Press **F3** to confirm your selection. When the **CONFIGURATION** menu is displayed, skip **TIME FORMAT** if you want to use the default time format of 24-hour clock. If you prefer a 12-hour AM/PM clock, set the time format as follows:

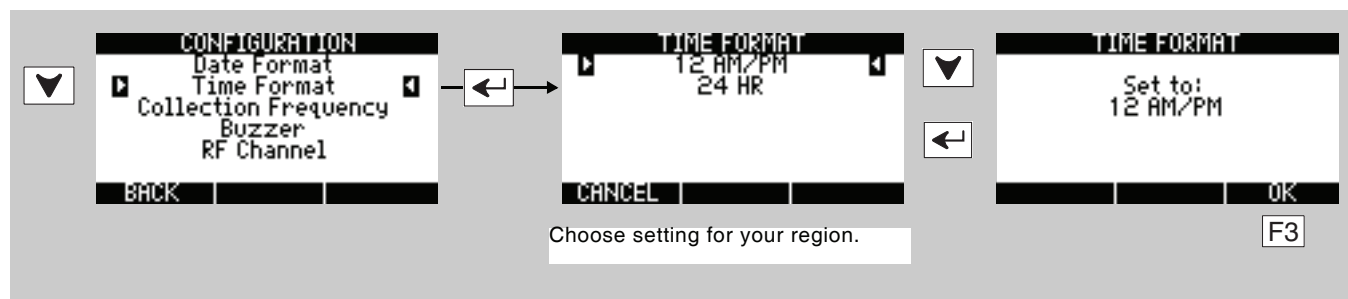

6. Press **F3** to confirm your selection. When the **CONFIGURATION** menu is displayed, select and set **COLLECTION FREQUENCY** as shown below. Collection Frequency determines how often the base unit collects data from the sensors.

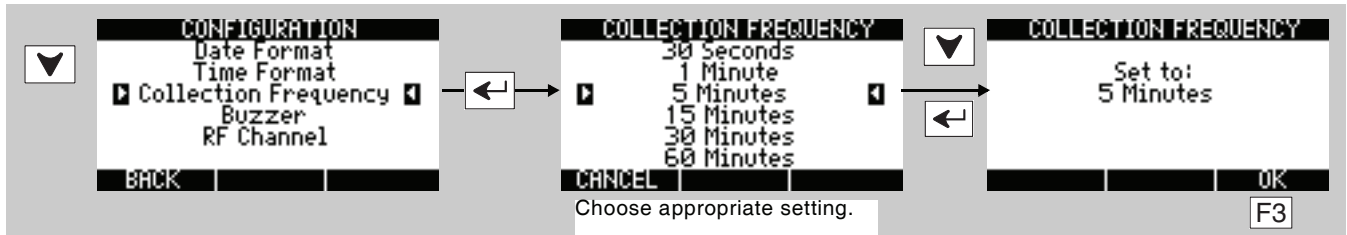

- Press **F3** to confirm your selection. When the **CONFIGURATION** menu is displayed, select and set **BUZZER** as shown below. The **BUZZER** setting enables/disables the audible alarm buzzer.



WARNING

Selecting **DISABLED** for this parameter turns the audible alarm buzzer off completely. No audible alarm tone will sound when an alarm occurs if **DISABLED** is selected.

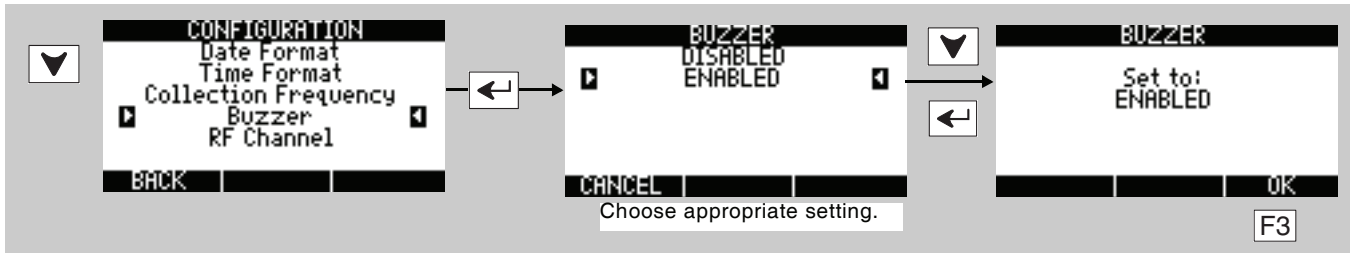

- Press **F3** to confirm your selection. When the **CONFIGURATION** menu is displayed, select and set **RF CHANNEL** as shown below. The **RF CHANNEL** setting determines the RF frequency at which the wireless sensor(s) and base station communicate.

Note: If the RF channel is changed after one or more wireless sensors have been added to the system, all wireless sensors must be reset.

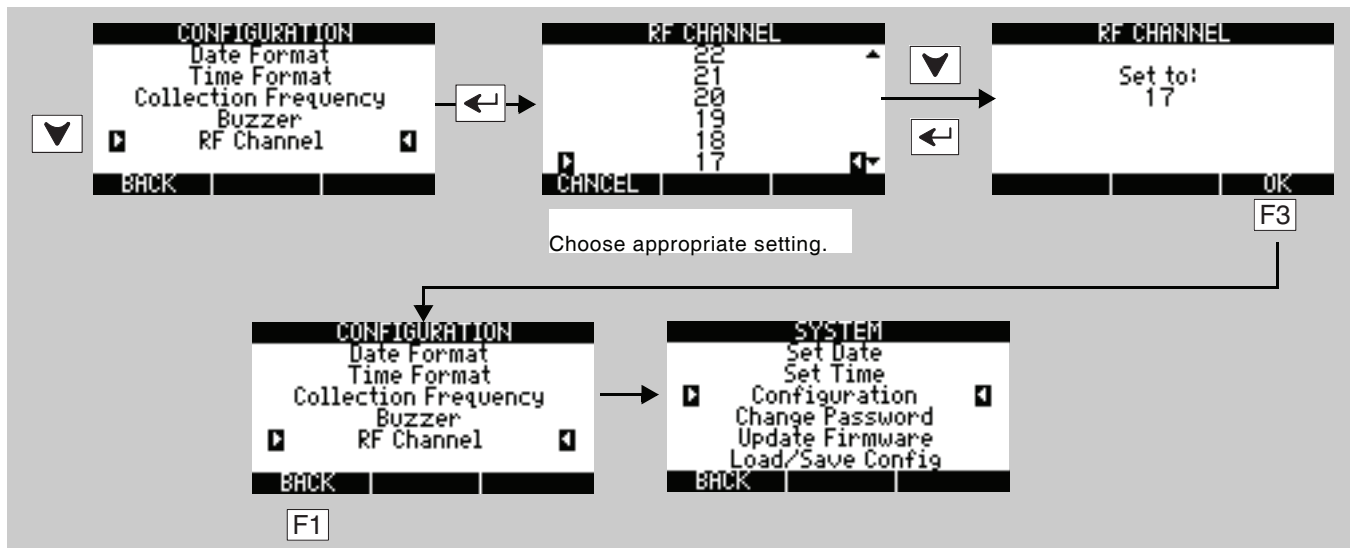

- Press **F3** to confirm your selection. When the **CONFIGURATION** menu is displayed, press **F1** to return to the **MAIN MENU**.

You have configured the EA800 system settings. Proceed to the next section to set the time and date.

Setting the Current Date

Unlock the EA800 to continue programming if necessary. See “Accessing the MAIN MENU for Programming” on page 28. From the **MAIN MENU**, use the arrow keys to select **SYSTEM**, then select **Set Date** and set the current date as shown below.

Note: To go back or to skip a step, press the **PREV (F2)** or **NEXT (F3)** keys. To cancel, press **F1**.

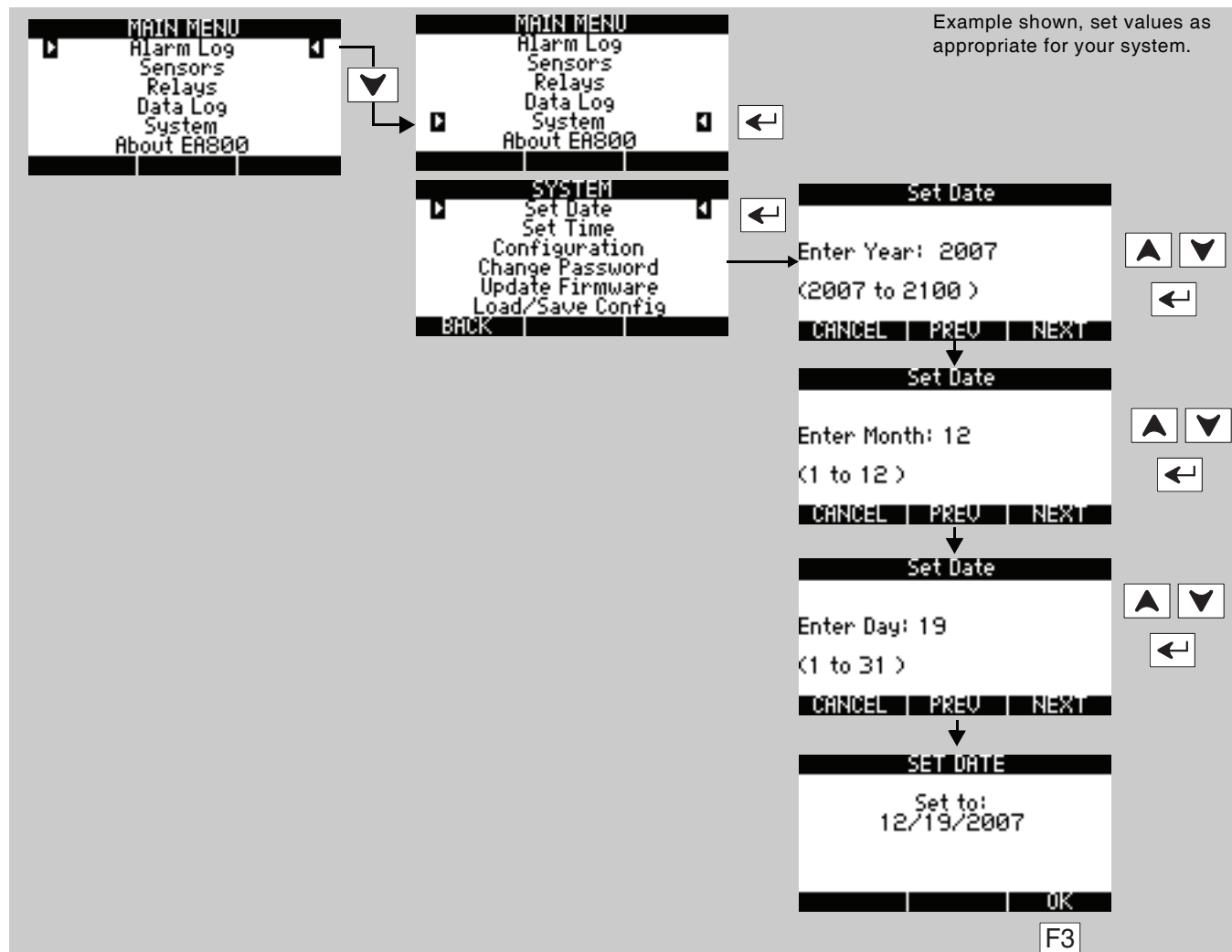

Setting the Time

Unlock the EA800 to continue programming if necessary. See “Accessing the MAIN MENU for Programming” on page 28.

From the **MAIN MENU**, use the arrow keys to select **SYSTEM**, then select **Set Time** and set the current time as shown below. If your region uses Daylight Savings Time and you want the EA800 to display the correct time, you must change the time setting manually when Daylight Savings Time starts and ends.

Note: To advance the cursor to the next digit when entering numeric values, press the **NEXT (F3)** key. To cancel, press **F1**. Use the arrow keys to increase or decrease the numeric value.

Note: The following menus are for setting time in 12-hour format. Follow the similar on-screen prompts to set time in 24-hour (military time) format.

Example shown, set values as appropriate for your system.

You have set the time for the EA800. Proceed to the next section to add wireless sensors. If you are not adding wireless sensors, skip to “Adding Wired Sensors” on page 43.

Adding Wireless Sensors

Go to the appropriate section for the wireless sensor to be added:

- **Wireless Temperature Sensor:** See “Adding a Wireless Temperature Sensor” on page 33
- **Wireless Humidity Sensor:** See “Adding a Wireless Humidity Sensor” on page 37
- **Wireless Multi-Function Sensor:** See “Adding a Wireless Multi-Function Sensor Using a Wired Temperature Sensor” on page 35. Multi-function sensor may be programmed to operate with the following types of wired sensors:
 - **Low Temperature Sensor - Blue Thermistor Probes:** See “Adding a Wireless Multi-Function Sensor Using a Wired Temperature Sensor” on page 35.
 - **High Temperature Sensor - Red Thermistor Probes:** See “Adding a Wireless Multi-Function Sensor Using a Wired Temperature Sensor” on page 35.
 - **Ultra Low Temperature Sensor - White Thermistor Probes:** See “Adding a Wireless Multi-Function Sensor Using a Wired Temperature Sensor” on page 35.
 - **WaterBug Sensor:** See “Adding a Wireless Multi-Function Sensor Using a Wired WaterBug Sensor” on page 38.
 - **N.O. Contact:** See “Adding a Wireless Multi-Function Sensor Using a Wired Contact Closure Sensor” on page 40.
 - **N.C. Contact:** See “Adding a Wireless Multi-Function Sensor Using a Wired Contact Closure Sensor” on page 40.



CAUTION

If the EA800 base unit will be connected to a remote alarm panel, do not connect the base unit to the alarm panel until after sensor connection and configuration is complete. Connecting the remote alarm panel before configuring the EA800 sensors will result in false alarms at the remote panel.

Adding a Wireless Temperature Sensor

1. Unlock the base unit if necessary to continue programming. See “Accessing the MAIN MENU for Programming” on page 28.
2. Select **SENSORS** from the **MAIN MENU** and follow the steps in the following diagram.
3. After you press the **ENTER** key, the **NEW WIRELESS SENSOR** screen is displayed. The EA800 searches for new wireless sensors, indicated by an arrow that moves from left to right across the screen. When an available wireless sensor has been detected, it is listed in the **SELECT SENSOR** screen as shown below.

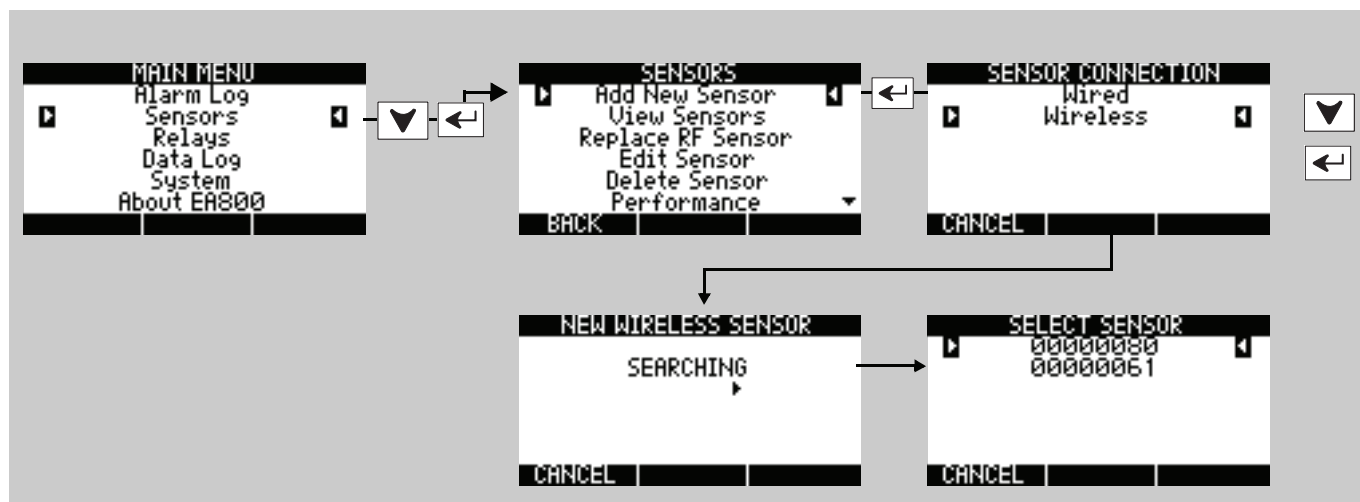

4. Confirm that all new (unprogrammed) wireless sensors are displayed on the **SELECT SENSOR** screen, use the arrow keys to select the sensor to be configured, then follow the prompts to configure all screens for that sensor.

Note: To enter numeric values, use the arrow keys. To advance the cursor to the next digit when entering numeric values, press the **NEXT** soft key (**F3**). To return to a previous digit, press the **PREV** soft key (**F2**).

The Hysteresis setting helps prevent alarms from being set and reset continually if the environment is at or near the alarm set point by providing an acceptable variance. For example, if **HYSTERESIS** is set at **1** and the sensor **High Alarm Limit** is set at **+158**, the sensor reading must decrease to **+157** (+158 minus 1) in order for the alarm condition to reset to a no-alarm condition.



Note: Repeat this sensor for each wireless temperature sensor you need to program. When you have finished programming wireless temperature sensors, proceed to the section appropriate for the other types of wireless sensors to be added.

Adding a Wireless Multi-Function Sensor Using a Wired Temperature Sensor

Wireless multi-function sensors are physically connected to wired sensors located elsewhere and provide a transmitter to send the signals monitored by the wired sensor to the base unit. To add a wireless multi-function sensor, do the following:

1. Unlock the base unit if necessary to continue programming. See “Accessing the MAIN MENU for Programming” on page 28.
2. Select **SENSORS** from the **MAIN MENU** and follow the steps in the following diagram.
3. After you press the **ENTER** key, the **NEW WIRELESS SENSOR** screen is displayed. The EA800 searches for new wireless sensors, indicated by an arrow that moves from left to right across the screen. When an available wireless sensor has been detected, it is listed in the **SELECT SENSOR** screen as shown below.

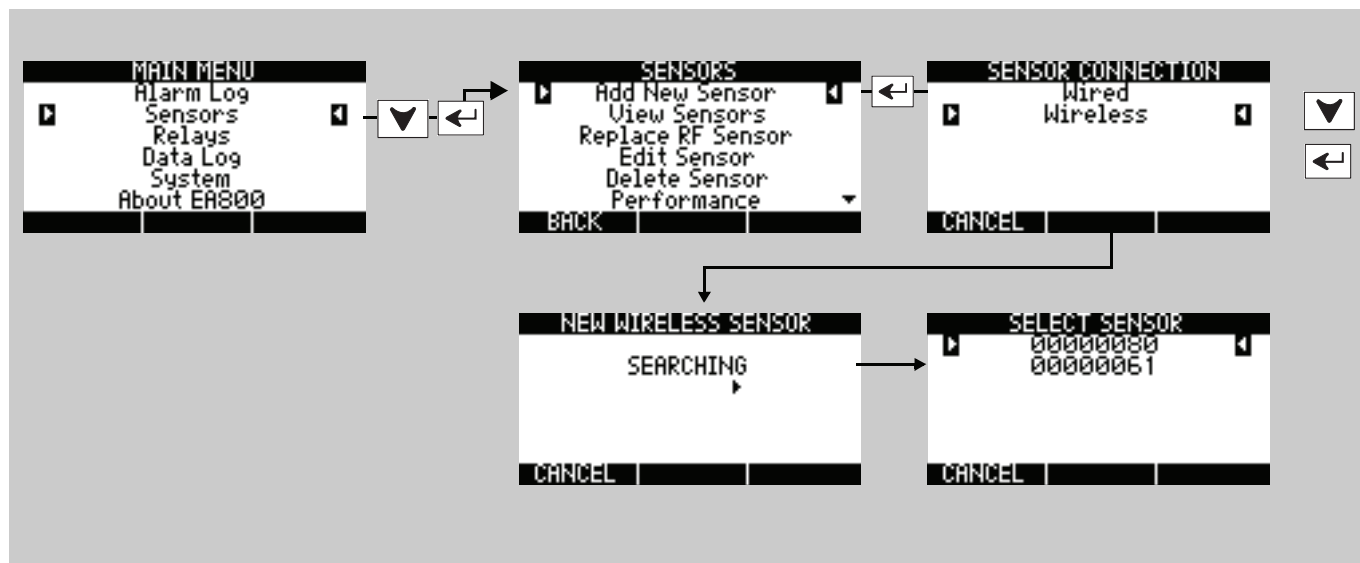

4. Use the arrow keys to select the wireless multifunction sensor to be configured, then follow the prompts to configure all screens for that sensor.

Follow the procedure shown on the next page to add a temperature sensor. The procedure shows a wired Blue temperature sensor, but is applicable to the wired Red and White temperature sensors as well.

The Hysteresis setting helps prevent alarms from being set and reset continually if the environment is at or near the alarm set point by providing an acceptable variance. For example, if **HYSTERESIS** is set at **1** and the sensor **High Alarm Limit** is set at **+158**, the sensor reading must decrease to **+157** (+157 minus 1) in order for the temperature alarm to reset to a no-alarm condition.

Adding Wireless Sensors

When setting numeric values, use the arrow keys to change the value. Use the **PREV** and **NEXT** soft keys to move the cursor to the next or previous digit. Press the **ENTER** key to enter the value.

Example shown, set values as appropriate for your system.

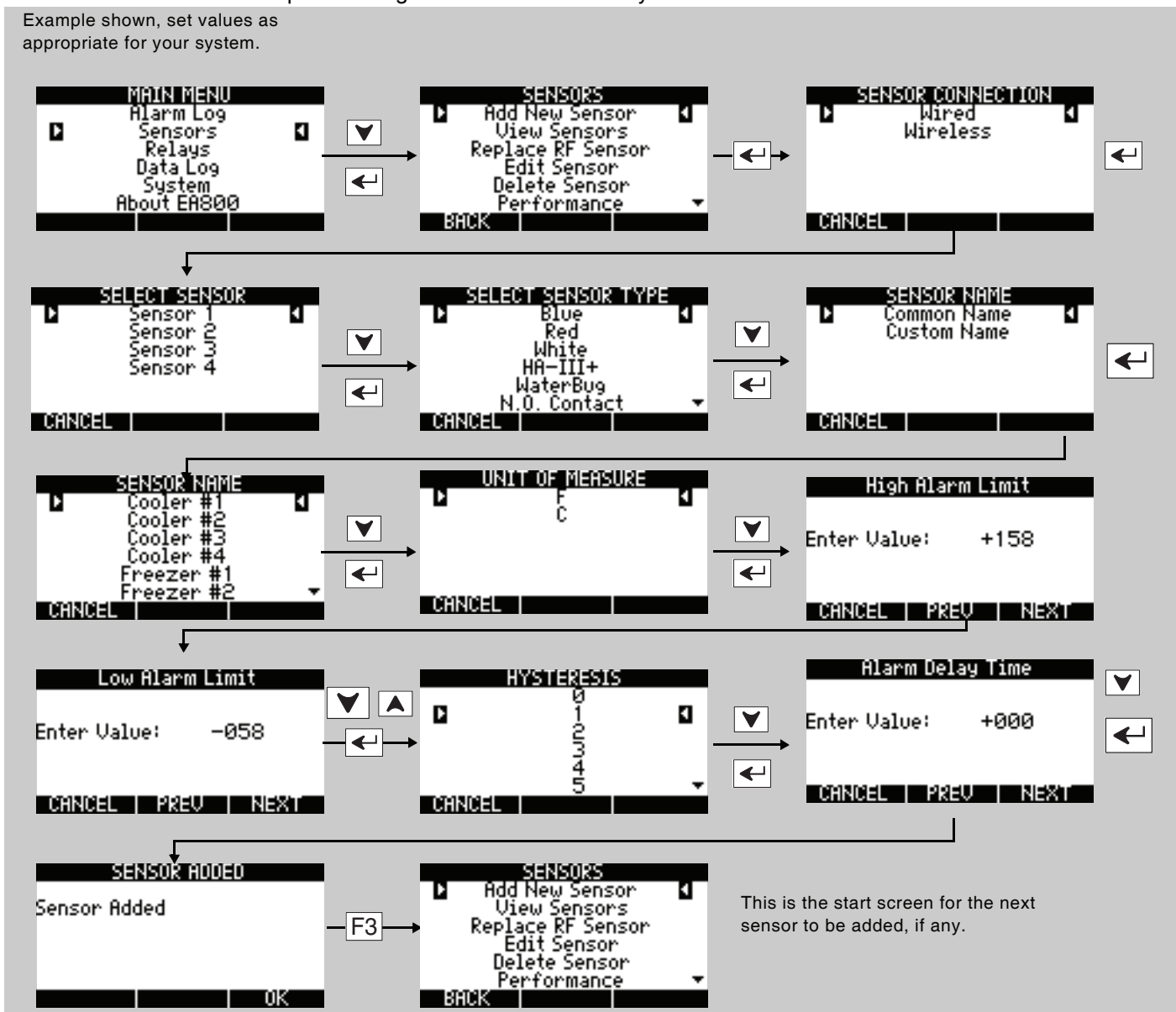

Adding a Wireless Humidity Sensor

The Hysteresis setting helps prevent alarms from being set and reset continually if the environment is at or near the alarm set point by providing an acceptable variance. For example, if **HYSTERESIS** is set at **1** and the sensor **High Alarm Limit** is set at **+95**, the sensor reading must decrease to **+94** (+95 minus 1) in order for the humidity alarm condition to reset to a no-alarm condition.

The humidity sensor also allows you to configure an alarm delay time if desired.

1. Unlock the base unit if necessary to continue programming. See “Accessing the MAIN MENU for Programming” on page 28.
2. Select **SENSORS** from the **MAIN MENU** and follow the steps in the following diagram.
3. After you press the **ENTER** key, the **NEW WIRELESS SENSOR** screen is displayed. The EA800 searches for new wireless sensors, indicated by an arrow that moves from left to right across the screen. When an available wireless sensor has been detected, it is listed in the **SELECT SENSOR** screen as shown below.
4. Use the arrow keys to select the sensor to be configured, then follow the prompts to configure all screens for that sensor as shown in the following diagram.

Example shown, set values as appropriate for your system.

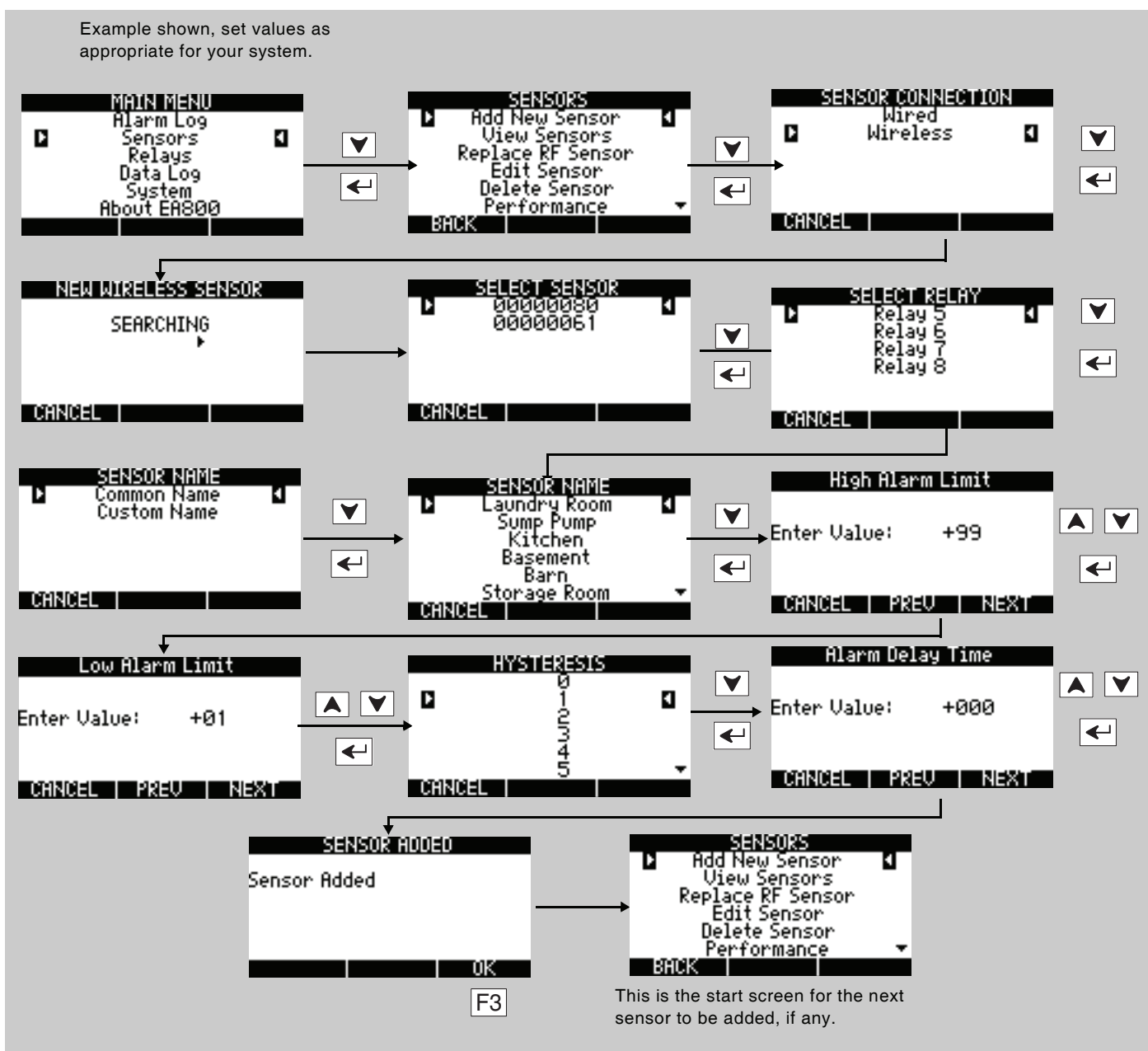

Adding a Wireless Multi-Function Sensor Using a Wired WaterBug Sensor

Wireless multi-function sensors are physically connected to wired sensors located elsewhere and provide a transmitter to send the signals monitored by the wired sensor to the base unit. To add a wireless multi-function sensor, do the following:

1. Unlock the base unit if necessary to continue programming. See “Accessing the MAIN MENU for Programming” on page 28.
2. Select **SENSORS** from the **MAIN MENU** and follow the steps in the following diagram.
3. After you press the **ENTER** key, the **NEW WIRELESS SENSOR** screen is displayed. The EA800 searches for new wireless sensors, indicated by an arrow that moves from left to right across the screen. When an available wireless sensor has been detected, it is listed in the **SELECT SENSOR** screen as shown below.

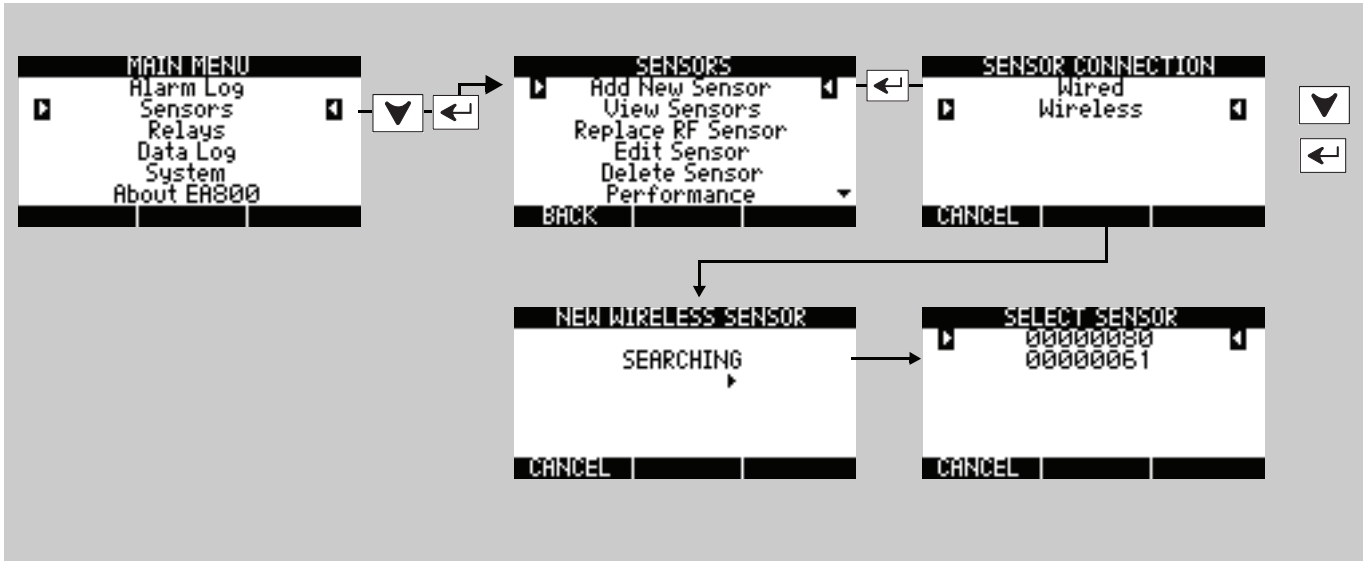

4. Use the arrow keys to select the wireless multifunction sensor to be configured, then follow the prompts to configure all screens for that sensor.

To add a wireless WaterBug sensor to the system perform the following procedure.

1. Unlock the base unit if necessary to continue programming. See “Accessing the MAIN MENU for Programming” on page 28.
2. Select **SENSORS** from the **MAIN MENU** and follow the steps in the following diagram.
3. After you press the **ENTER** key, the **NEW WIRELESS SENSOR** screen is displayed. The EA800 searches for new wireless sensors, indicated by an arrow that moves from left to right across the screen. When an available wireless sensor has been detected, it is listed in the **SELECT SENSOR** screen as shown below.
4. Use the arrow keys to select the sensor to be configured, then follow the prompts to configure all screens for that sensor as shown in the following diagram.

Example shown, set values as appropriate for your system.

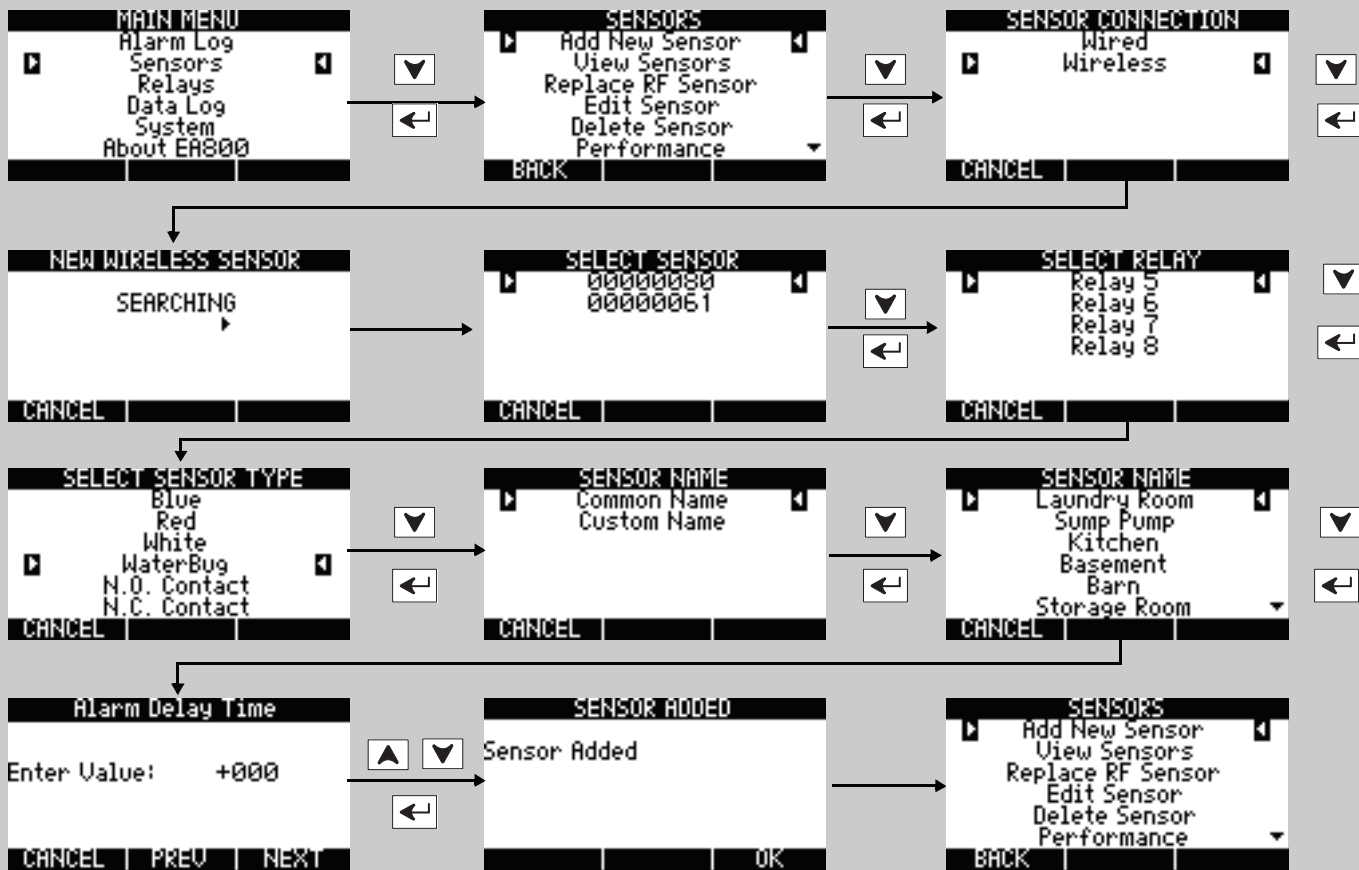

F3

This is the start screen for the next sensor to be added, if any.

Adding a Wireless Multi-Function Sensor Using a Wired Contact Closure Sensor

Wireless multi-function sensors are physically connected to wired sensors located elsewhere and provide a transmitter to send the signals monitored by the wired sensor to the base unit. To add a wireless multi-function sensor, do the following:

1. Unlock the base unit if necessary to continue programming. See “Accessing the MAIN MENU for Programming” on page 28.
2. Select **SENSORS** from the **MAIN MENU** and follow the steps in the following diagram.
3. After you press the **ENTER** key, the **NEW WIRELESS SENSOR** screen is displayed. The EA800 searches for new wireless sensors, indicated by an arrow that moves from left to right across the screen. When an available wireless sensor has been detected, it is listed in the **SELECT SENSOR** screen as shown below.

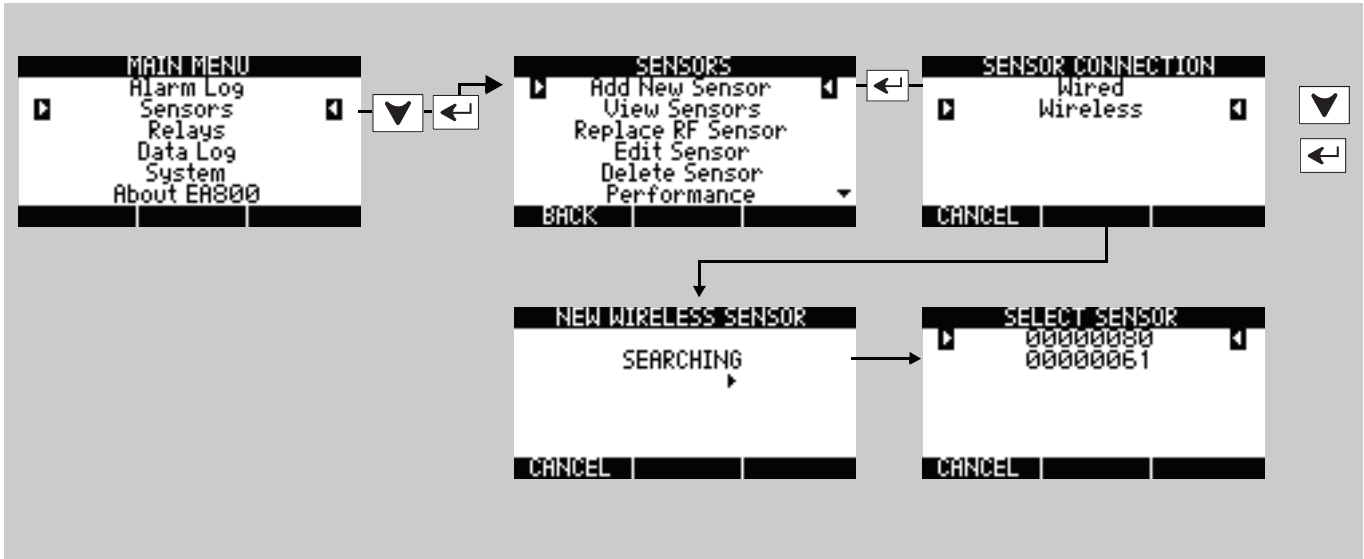

4. Use the arrow keys to select the wireless multifunction sensor to be configured, then follow the prompts to configure all screens for that sensor.

To add a wireless multi-function contact closure sensor to the system perform the following procedure. The procedure shown is for a normally open (N.O.) contact closure sensor but is essentially the same for the N.C. wireless contact closure sensor.

1. Unlock the base unit if necessary to continue programming. See “Accessing the MAIN MENU for Programming” on page 28.
2. Select **SENSORS** from the **MAIN MENU** and follow the steps in the following diagram.
3. After you press the **ENTER** key, the **NEW WIRELESS SENSOR** screen is displayed. The EA800 searches for new wireless sensors, indicated by an arrow that moves from left to right across the screen. When an available wireless sensor has been detected, it is listed in the **SELECT SENSOR** screen as shown below.
4. Use the arrow keys to select the sensor to be configured, then follow the prompts to configure all screens for that sensor as shown in the following diagram.

Example shown, set values as appropriate for your system.

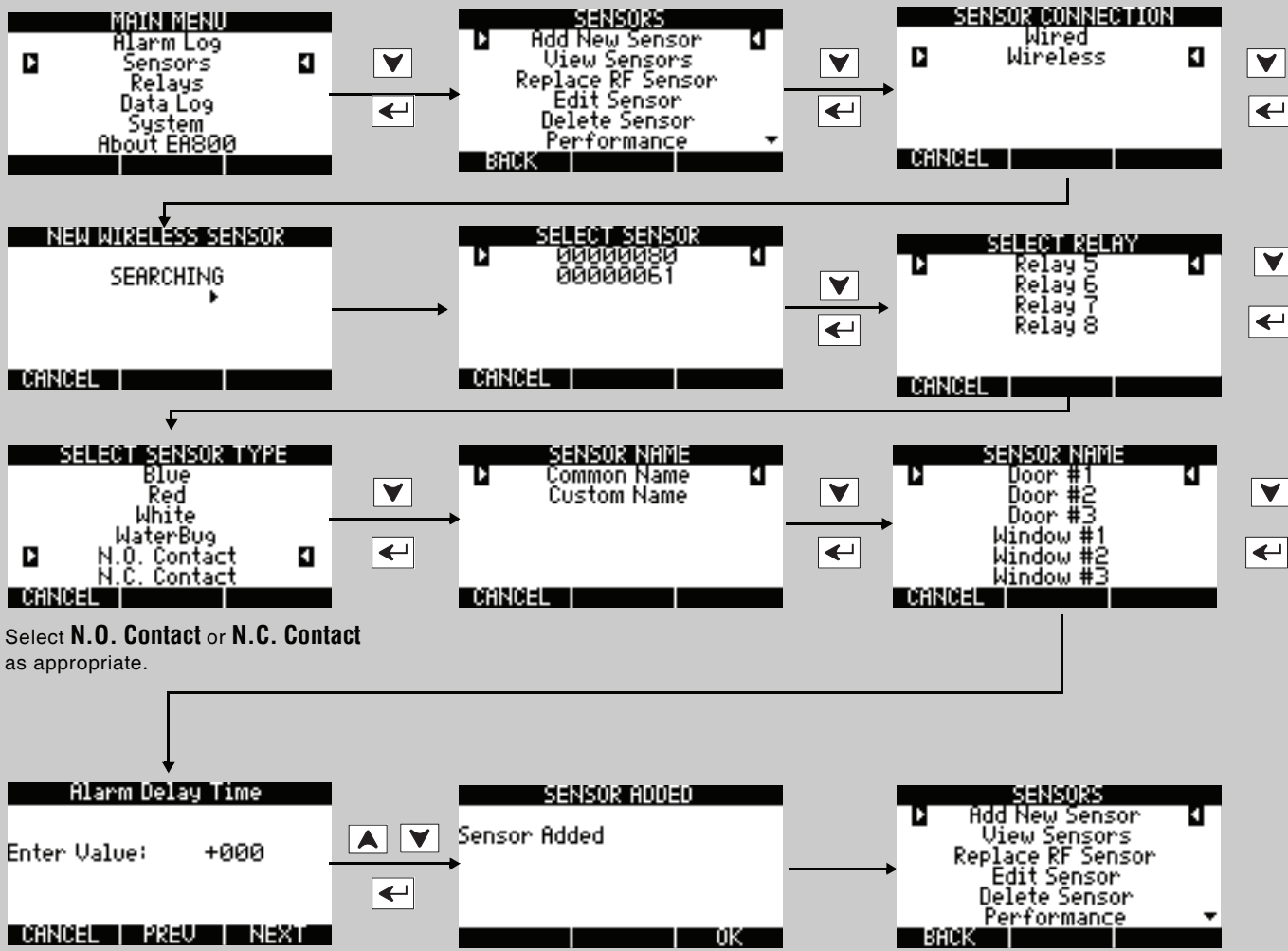

Select **N.O. Contact** or **N.C. Contact** as appropriate.

F3

This is the start screen for the next sensor to be added, if any.

Verify Wireless Signal Strength

After temporarily mounting the wireless sensors in the desired location, verify the signal strength at the base unit by performing the following procedure to verify the signal strength of each programmed wireless sensor. It may take as long as 30 seconds to acquire the current signal strength.

Perform the following procedure to verify the signal strength of each programmed wireless sensor.

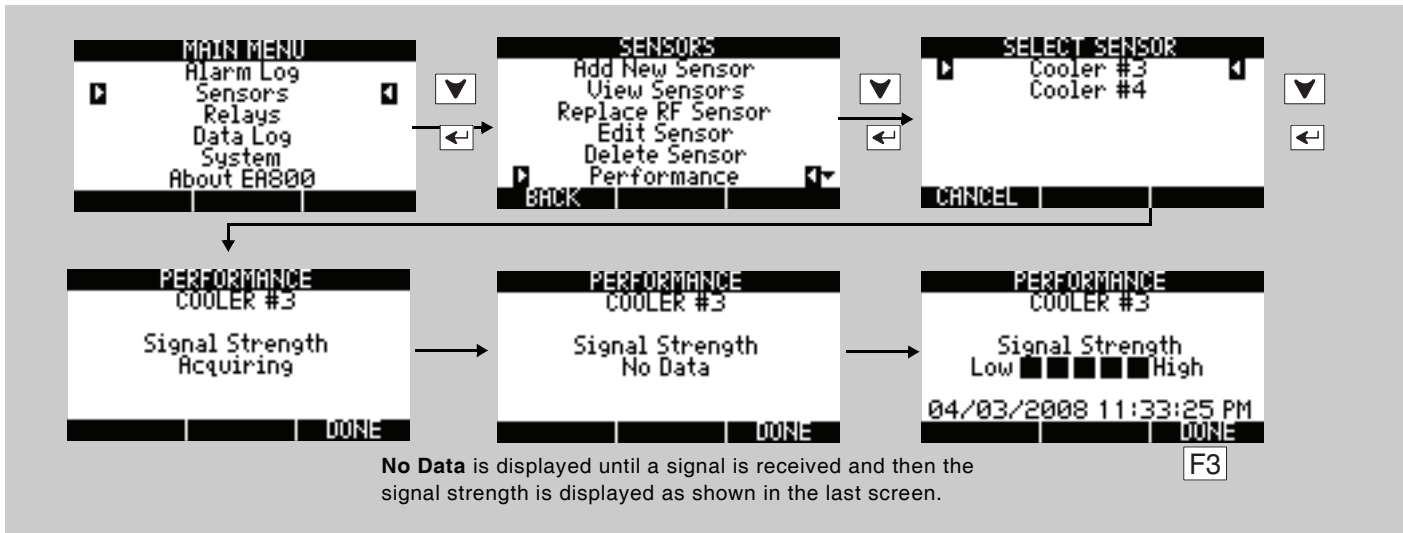

If **No Data** is displayed in place of bars, it indicates that recent signal strength information has not been received. If this persists for 1-2 minutes without displaying any performance bars, it is a strong indication that your sensor is placed out of range with the base unit.

If fewer than two bars are shown, it is recommended that the sensor be relocated to obtain a better signal. Refer to the instruction sheet included with the wireless sensor for details on ensuring optimum signal strength. The wireless environment can change throughout the day because of other activity in the vicinity. It is therefore important to verify the signal strength by approximating the worst case scenario the RF signal may encounter.

Adding Wired Sensors

- Low temperature sensors - Blue Thermistor Probes: See “Adding a Wired Temperature Sensor” on page 43.
- High temperature sensors - Red Thermistor Probes: See “Adding a Wired Temperature Sensor” on page 43.
- Ultra Low temperature sensors - White Thermistor Probes: See “Adding a Wired Temperature Sensor” on page 43.
- HA-III+ humidity sensor: See “Adding a Wired HA-III+ Humidity Sensor” on page 44.
- WaterBug sensor: See “Adding a Wired WaterBug Sensor” on page 45.
- N.O. Contact: See “Adding a Wired Contact Closure Sensor” on page 46.
- N.C. Contact: See “Adding a Wired Contact Closure Sensor” on page 46.
- 4-20 mA: See “Adding a 4-20mA Sensor” on page 47.

Adding a Wired Temperature Sensor

The procedure shown below adds a wired Blue temperature sensor, but is applicable to the wired Red and White temperature sensors as well.

The Hysteresis setting helps prevent alarms from being set and reset continually if the environment is at or near the alarm set point by providing an acceptable variance. For example, if **HYSTERESIS** is set at **1** and the sensor **High Alarm Limit** is set at **+158**, the sensor reading must decrease to **+157** (+158 minus 1) in order for the temperature alarm to reset to a no-alarm condition.

When setting numeric values, use the arrow keys to change the value. Use the **PREV** and **NEXT** soft keys to move the cursor to the next or previous digit. Press the **ENTER** key to enter the value.

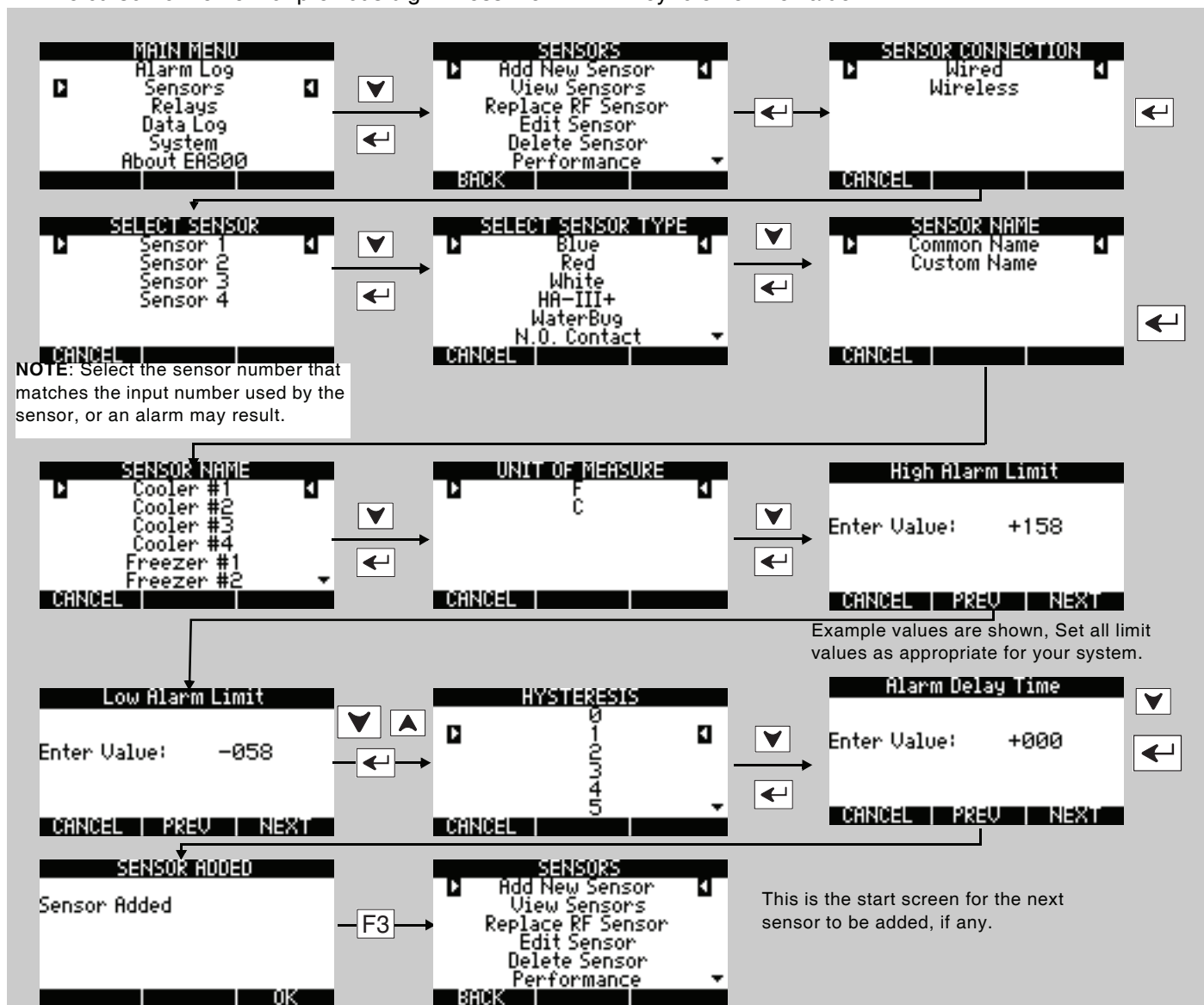

Adding a Wired HA-III+ Humidity Sensor

To add an HA-III+ humidity sensor perform the following procedure.

Example shown, set values as appropriate for your system.

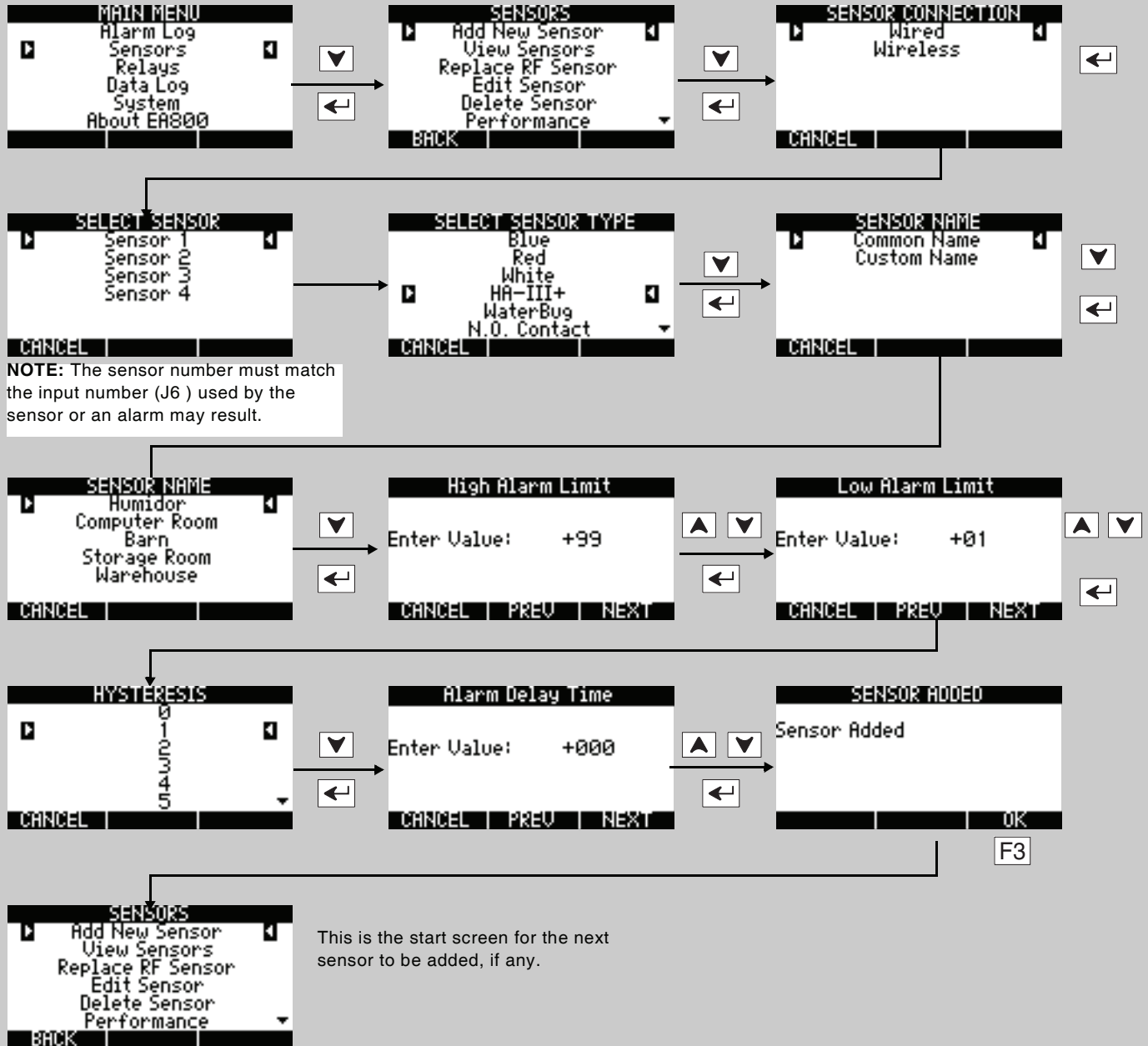

Adding a Wired WaterBug Sensor

To add a WaterBug sensor perform the following procedure:

Note: A supervised WaterBug sensor must be used.

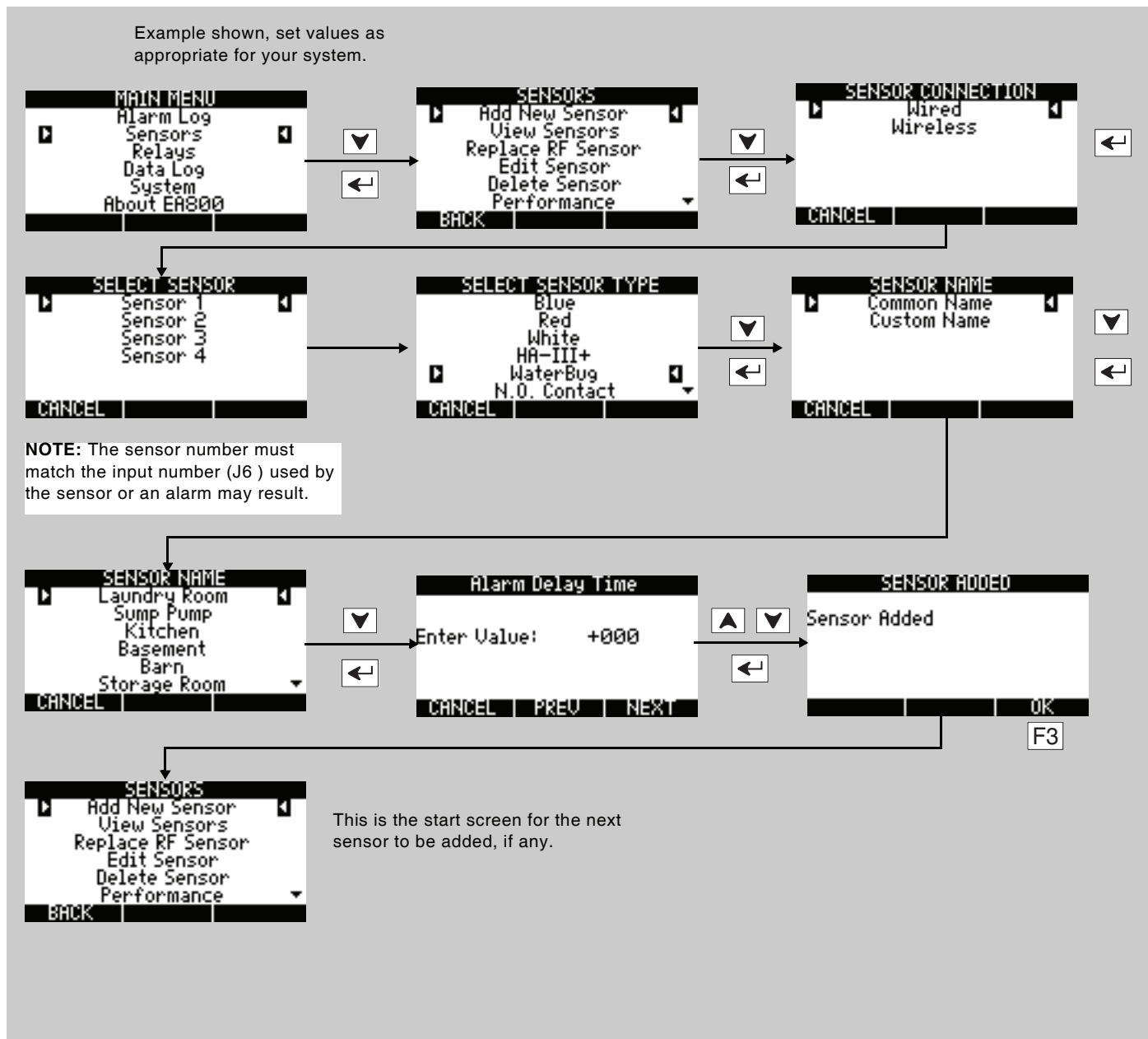

Adding a Wired Contact Closure Sensor

The following procedure shown adds a N.O. contact closure sensor but is the same for N.C. contact closure sensor.

Example shown, set values as appropriate for your system.

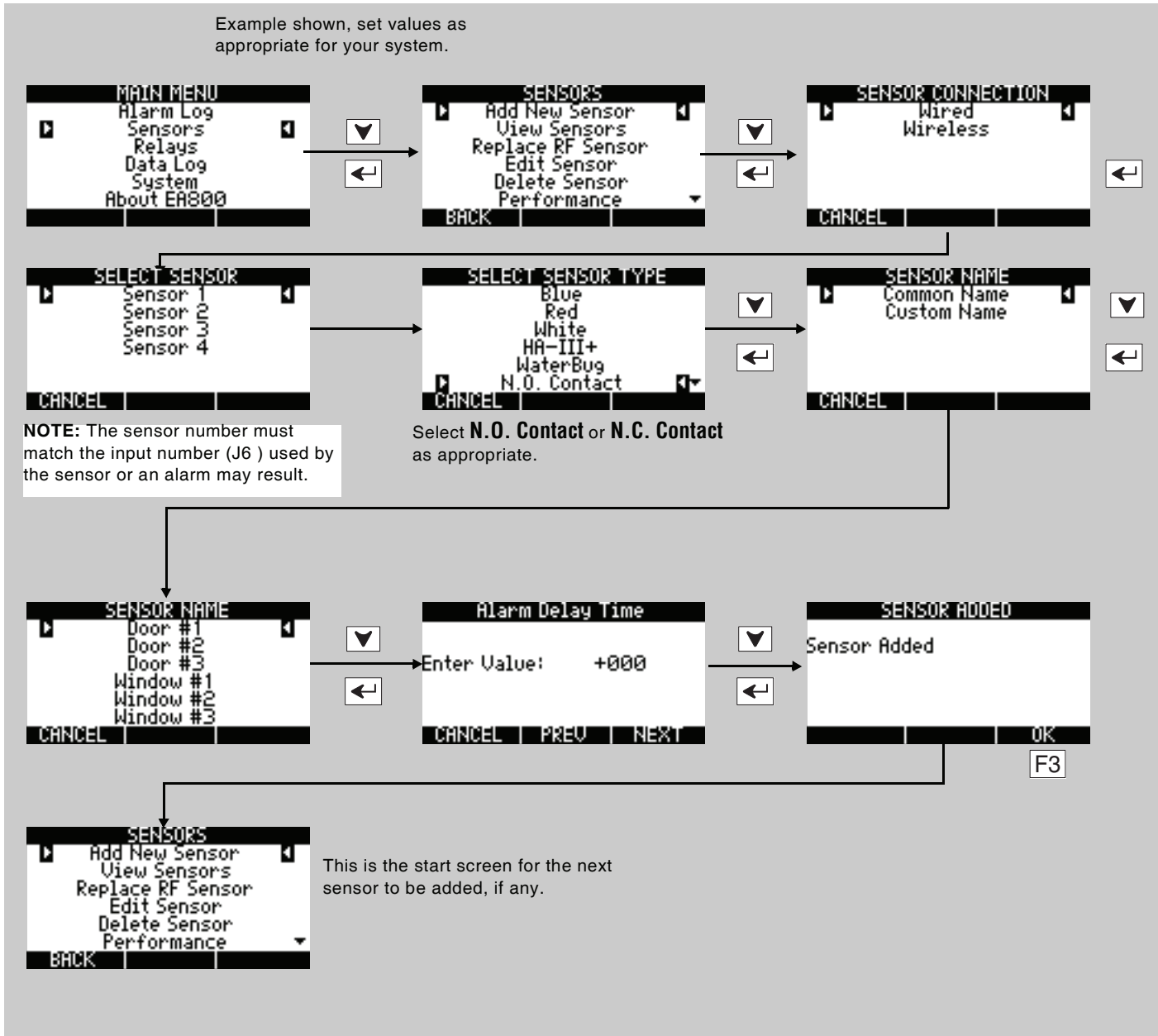

Adding a 4-20mA Sensor

To add a 4-20mA sensor, perform the following procedure. There are some additional parameters to configure with this type of sensor, including Unit of Measure and Resolution. 4-20mA sensors can be used for monitoring a variety of conditions because the measured value corresponds to a current level, which is configured to represent the conditions being monitored. Follow the steps outlined below to program a 4-20mA sensor.

Example shown, set values as appropriate for your system.

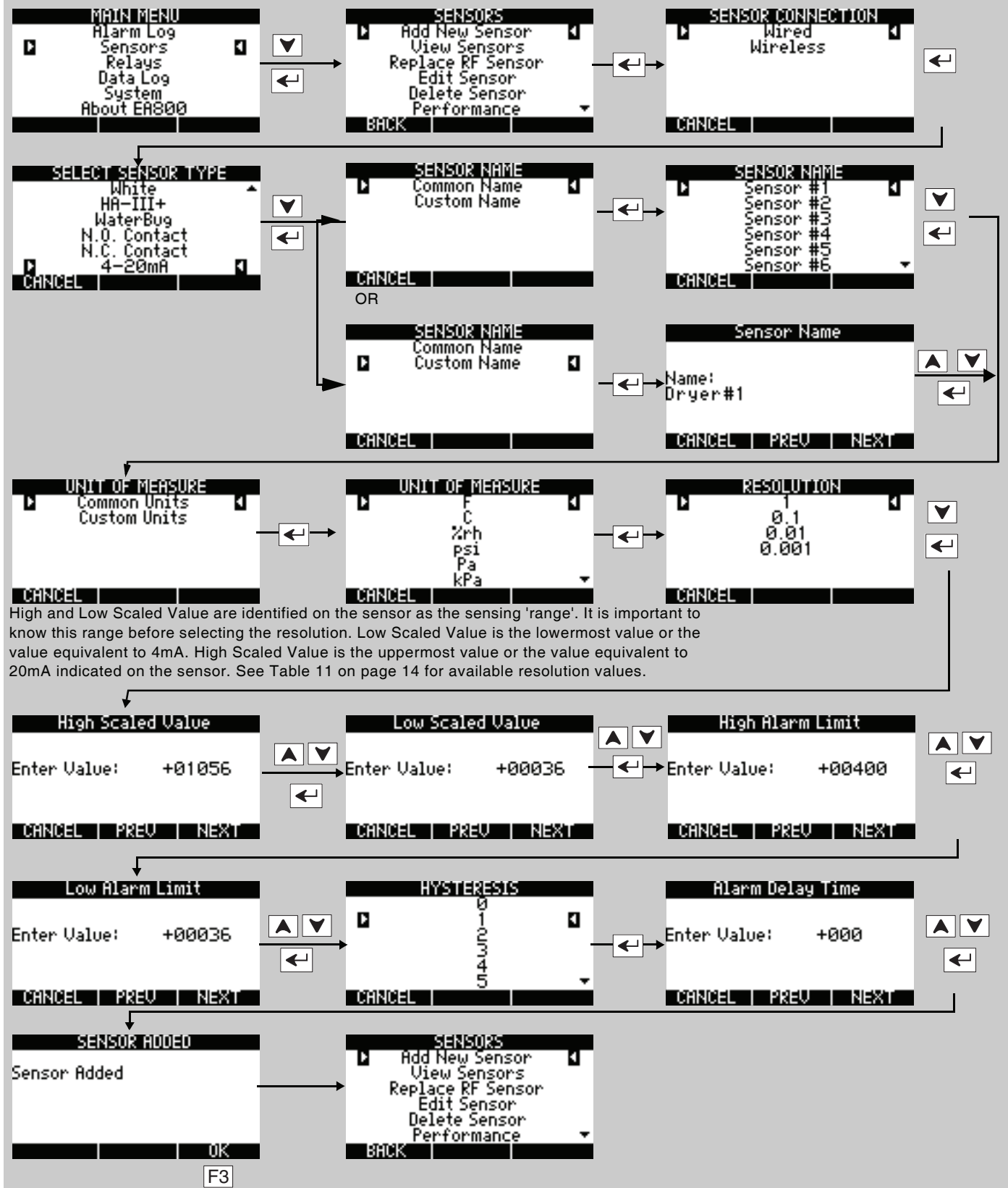

Configuring the Relays

When all sensors have been added, you must configure the relays so that the outputs indicate the monitored conditions correctly. Perform the following procedure to configure all relays used:

Note: The default relay settings are:

- Relays 1-8 (Active Condition = Alarm Only);
- Aux Relay (Active Condition = Alarm or Warning);
- All Relays (No Alarm - Relay State = De-Energized)

If these defaults are acceptable, it is not necessary to configure the relays.

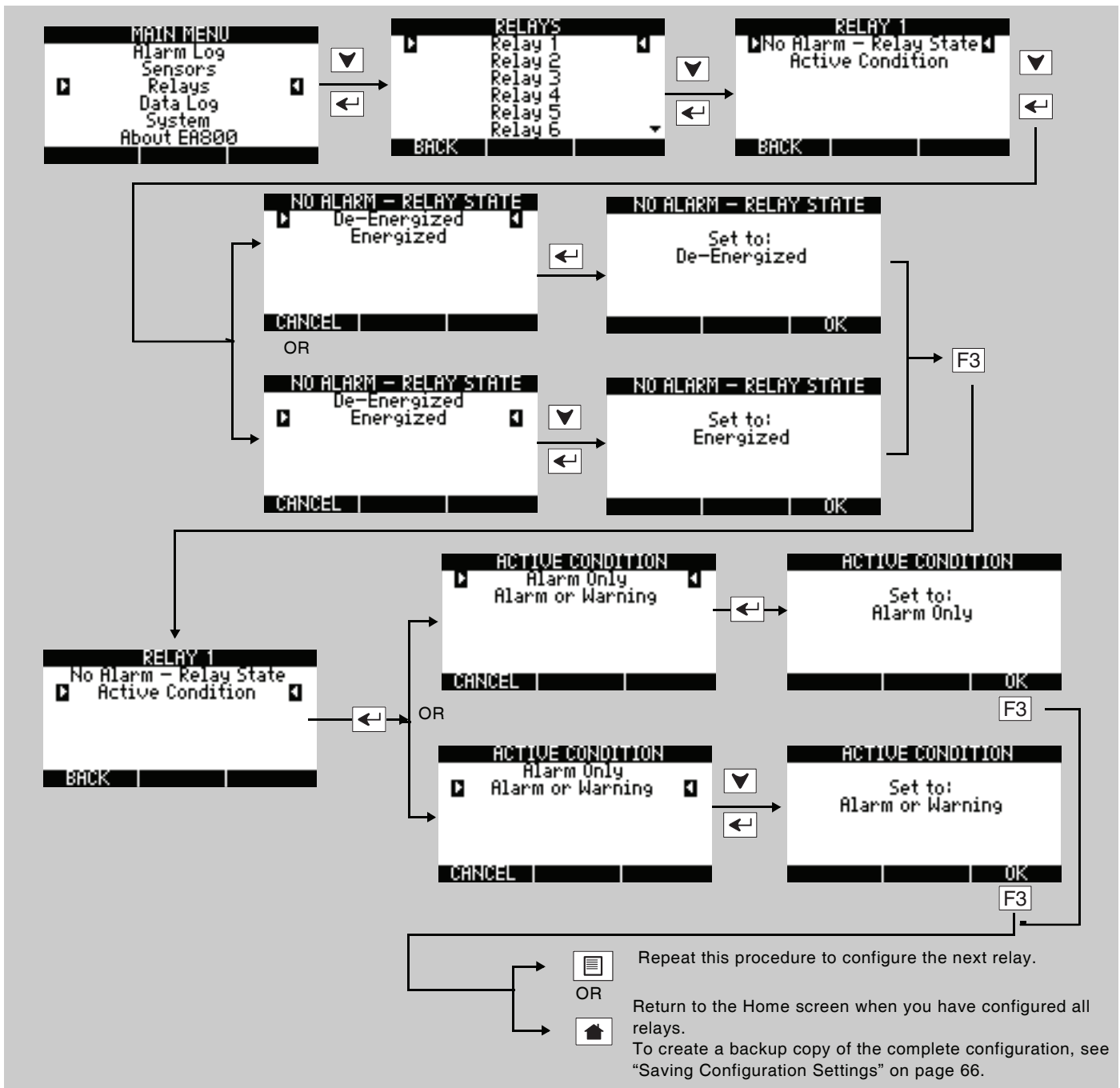

This chapter provides instructions for doing the following:

- “Monitoring Environmental Conditions” on page 49
- “Viewing Sensor Settings” on page 50
- “Viewing Active Alarms” on page 50
- “Viewing the Alarm Log” on page 51
- “Viewing Pending Alarm Information” on page 51
- “Viewing Limit Settings” on page 52
- “Viewing the Event Log” on page 52
- “Viewing the Sensor Log” on page 53
- “Viewing Firmware Information” on page 53
- “Viewing RF Information” on page 54

Monitoring Environmental Conditions

The current environmental conditions measured by each sensor connected to the EA800 base unit are shown on the home screen. Depending on the current sensor status the home screen may be one of the following screens:

- **MONITORING** screen: This screen is shown when there are no active alarms or pending alarms. This screen displays the current readings from all programmed sensors as shown in the example below.

Note: Dashes indicate that a sensor has not been programmed yet.

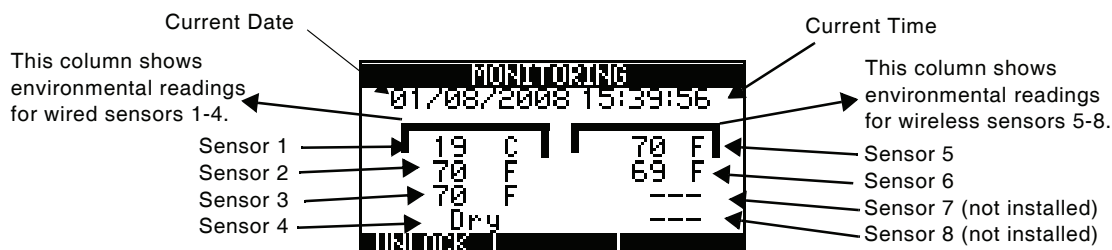

- **MONITORING** screen with pending alarm. A pending alarm indicates that a sensor has exceeded the low or high limits but that the condition has not exceeded the programmed delay (0 to 120 minutes). When an alarm is pending, the sensor’s reading is displayed in reverse text as shown in the example for wired sensor 2.

If conditions in the sensor’s area return to the non-alarm state within the alarm delay time, the text returns to normal. If conditions remain outside the programmed sensor alarm limits for longer than the delay time, the screen changes to the ACTIVE ALARMS screen below.

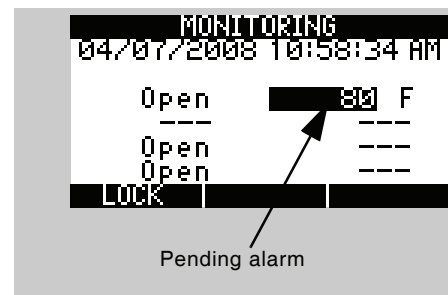

- **ACTIVE ALARMS** Screen: This screen is displayed when conditions monitored by any programmed sensor exceed one of its programmed limits for longer than the programmed delay period. Only the active alarm(s) is displayed as shown in the example below. See “Viewing Active Alarms” on page 50 for the procedure to access alarm information

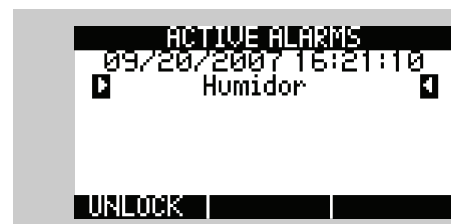

Viewing Sensor Settings

You can view the readings of each installed sensor on the MONITORING screen. To view details of a sensor's programmed settings and current readings on one screen perform the procedure shown below.

Note: The **MAIN MENU** screen shown in the example procedure is displayed when the system is locked. Sensor settings may also be viewed when the system is unlocked.

Use the arrow keys to highlight the desired menu item.

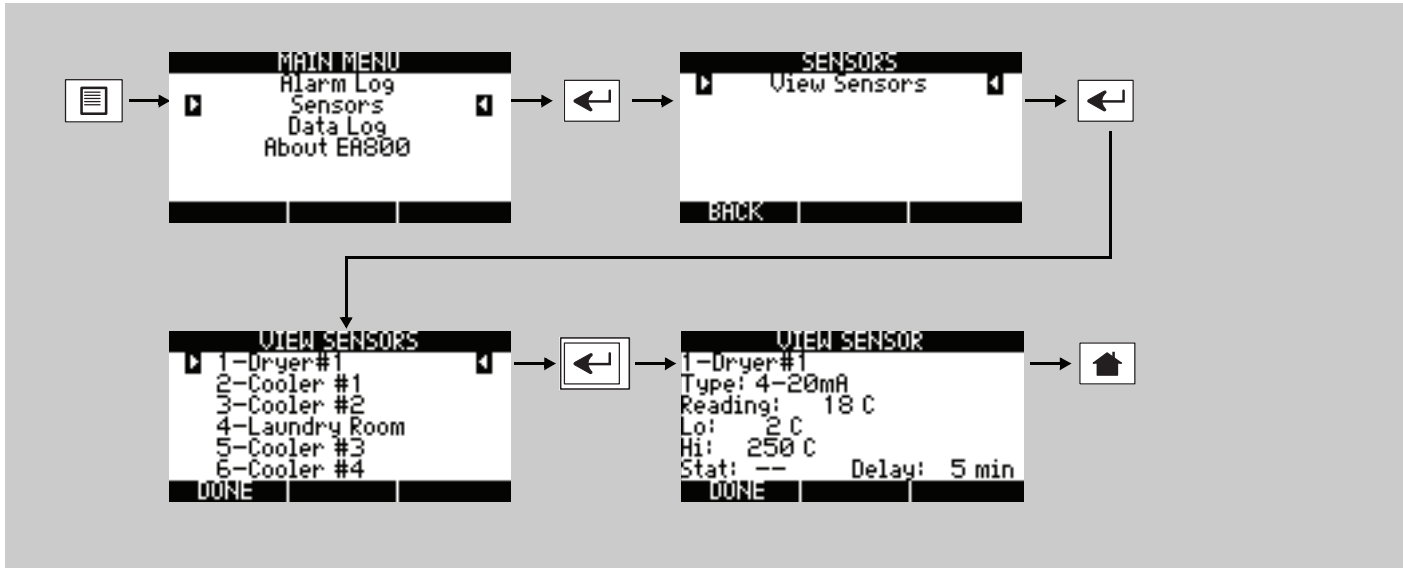

Viewing Active Alarms

To view the current readings of a sensor with an active alarm:



There are six conditions that may be shown in the alarm screen:

- **Comm:** Indicates that the wireless sensor is not communicating with the EA800.
- **High:** The sensor's current reading is greater than the programmed high threshold.
- **Low:** The sensor's current reading is less than the programmed low threshold.
- **Batt:** The sensor's battery is low.
- **Cut:** Supervised water sensors only: cable is cut or disconnected.
- **Fail:** Indicates that the sensor reading is exceeding the known range of the sensor.

More than one alarm condition may be displayed. For example, if a wireless sensor detects a high reading and then stops communicating with the base unit, the alarm log will indicate a Comm, High alarm. This type of alarm can be logged only if the high reading occurred prior to the communication failure.

Viewing the Alarm Log

This alarm log is a quick view of the 20 most recent alarms. Up to 100 alarms can be reviewed by selecting **Data Log** from the **MAIN MENU**, then selecting **View Alarm Log**. To review the alarm history and review a specific alarm stored in the log, perform the following procedure.

Note: The **MAIN MENU** screen shown in the example procedure is displayed when the system is locked. This alarm log may also be viewed when the system is unlocked.

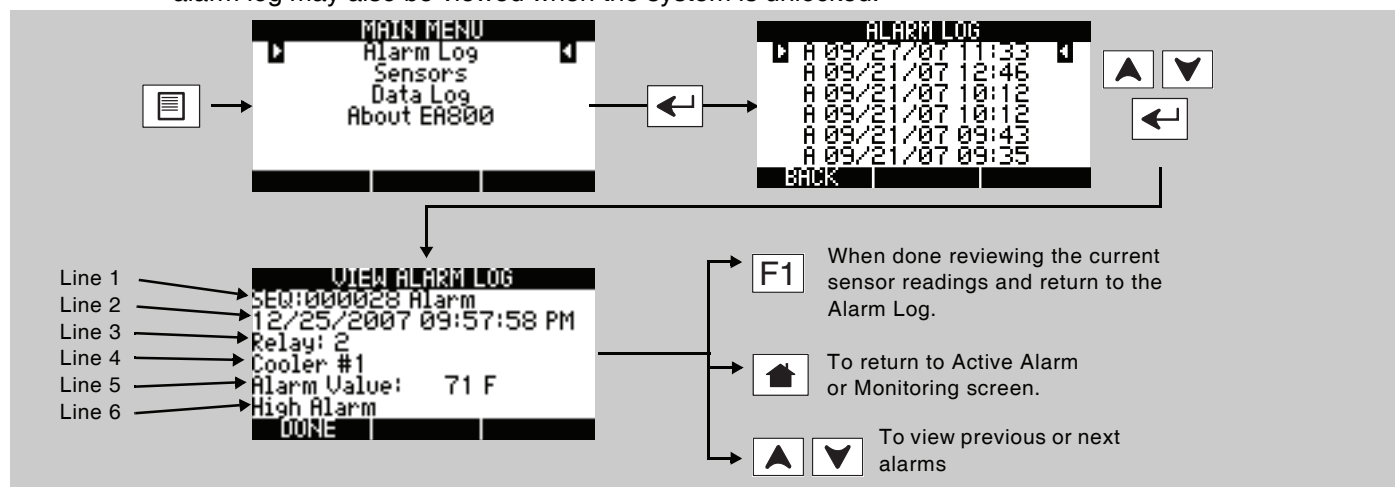

The View Alarm Log lines provide the following information:

- Line 1: Sequence number. Identifies the alarm in the log list.
- Line 2: Date and time the alarm was logged
- Line 3: The relay connected to the sensor that logged the alarm condition
- Line 4: The name of the sensor that logged the alarm condition
- Line 5: The sensor's reported value that generated the alarm
- Line 6: The alarm type or the clearing of alarm type

Viewing Pending Alarm Information

To view the current readings of a sensor that is in the pending alarm state perform the following procedure:

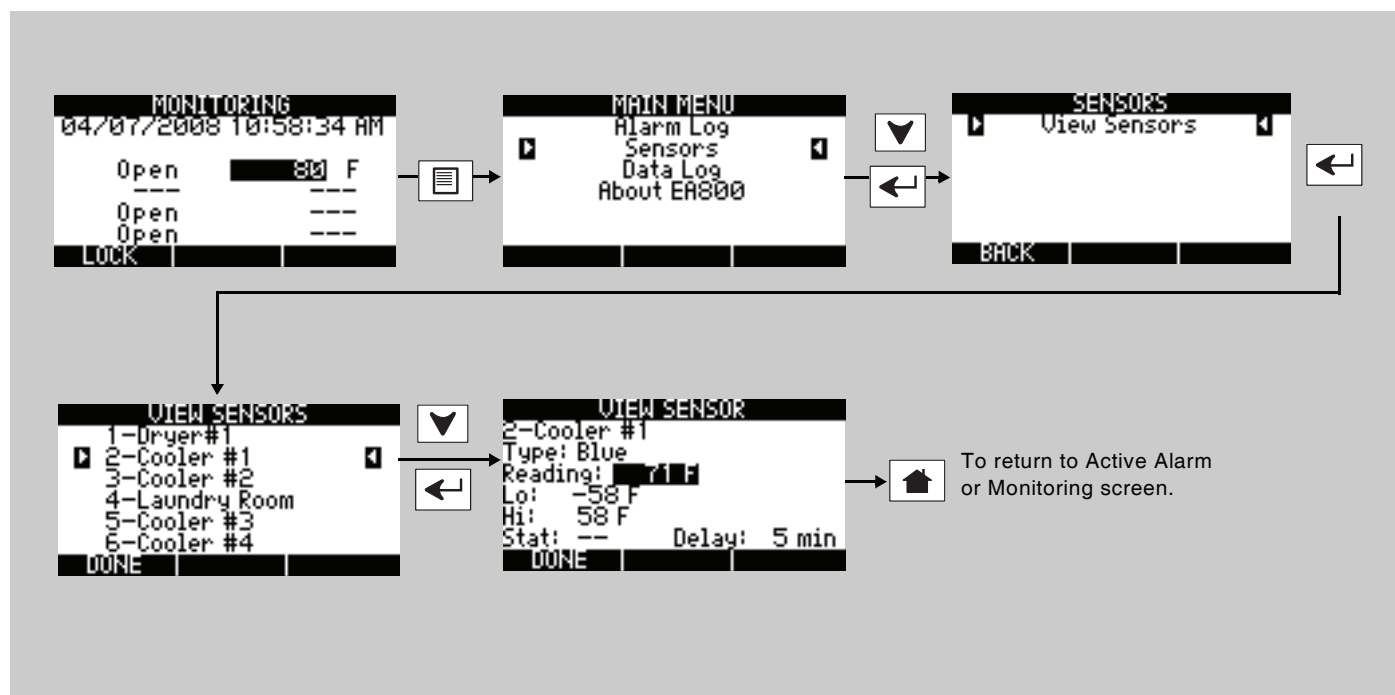

Viewing Limit Settings

To view the current readings and the limits of a sensor that is not in an alarm state perform the following procedure:

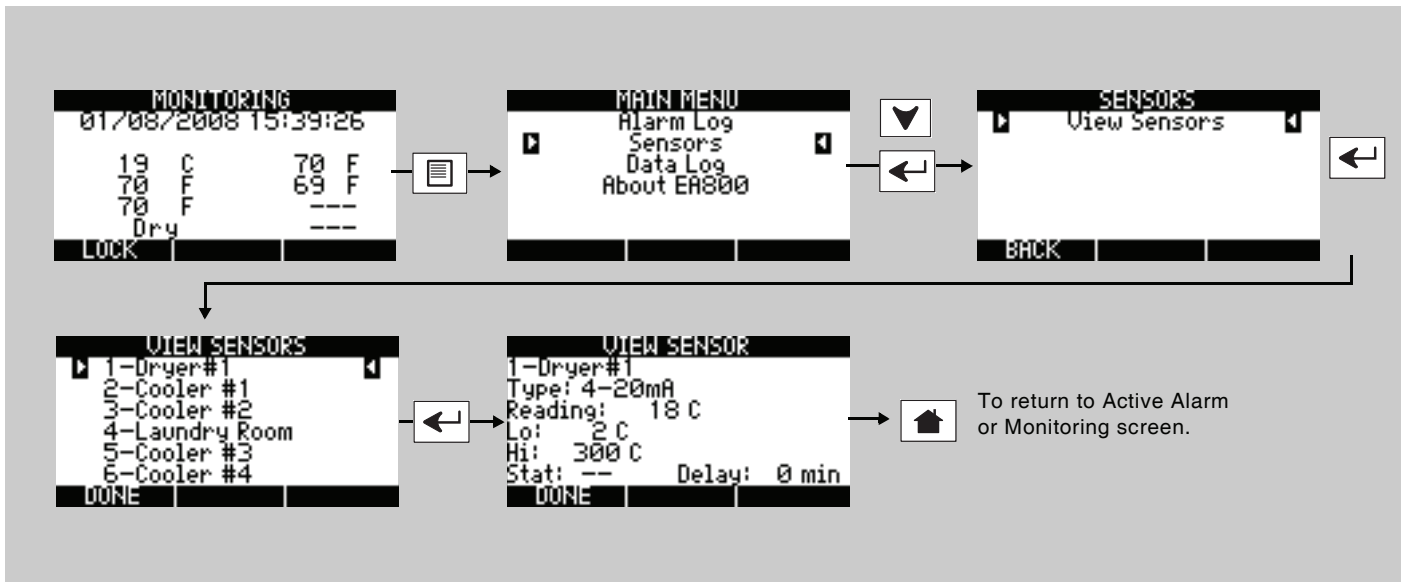

Viewing the Event Log

The EA800 Alarm System logs up to 100 events in its Event Log. At the minimum, the following events are logged:

- System power on: the date and time when the EA800 was powered on.
- Sensor added: indicates that a sensor was added.
- Sensor deleted: indicates that a sensor was deleted.
- WRM Msg error: indicates that an error message was generated.
- Firmware updated: indicates that the firmware was upgraded.
- Alarm log cleared: indicates when the alarm log was cleared.
- Data log cleared: indicates when the data log was cleared.

Note: Pressing either arrow key will eventually wrap to sequence number 1.

To review the event log, perform the following procedure:

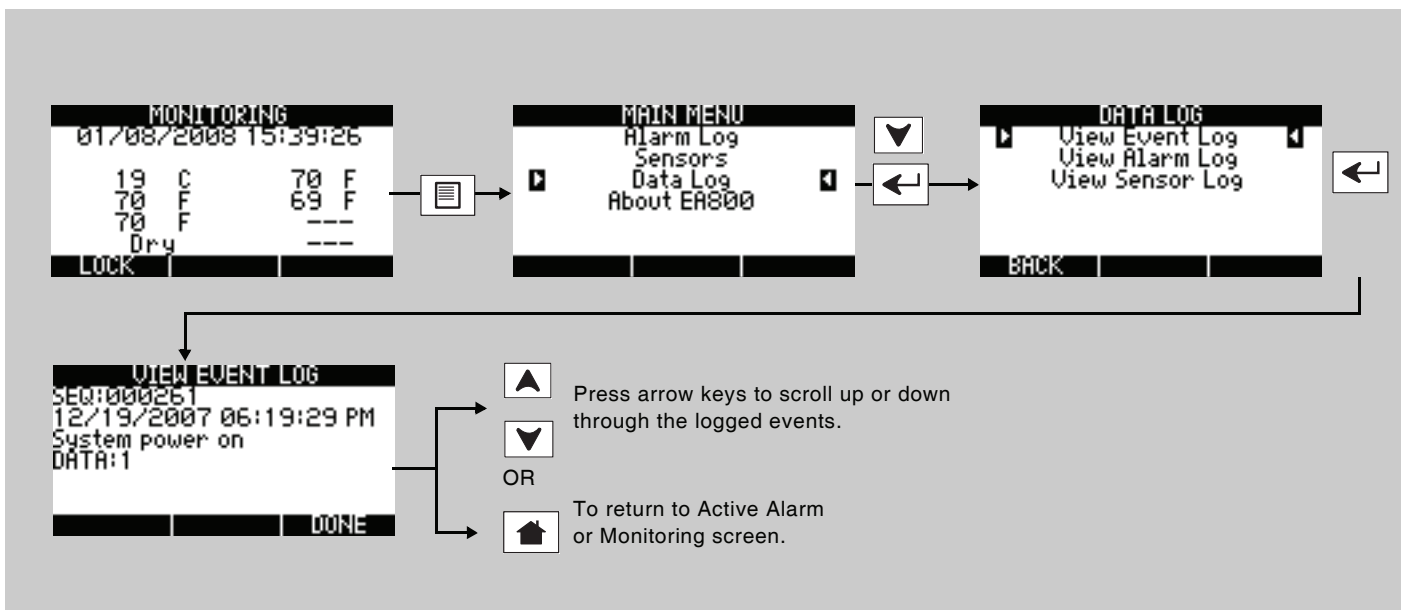

Viewing the Sensor Log

The sensor log provides a history of the environmental conditions for all installed sensors at a glance. Up to 100 data sets are stored in the sensor log. To view the sensor log, perform the following procedure:

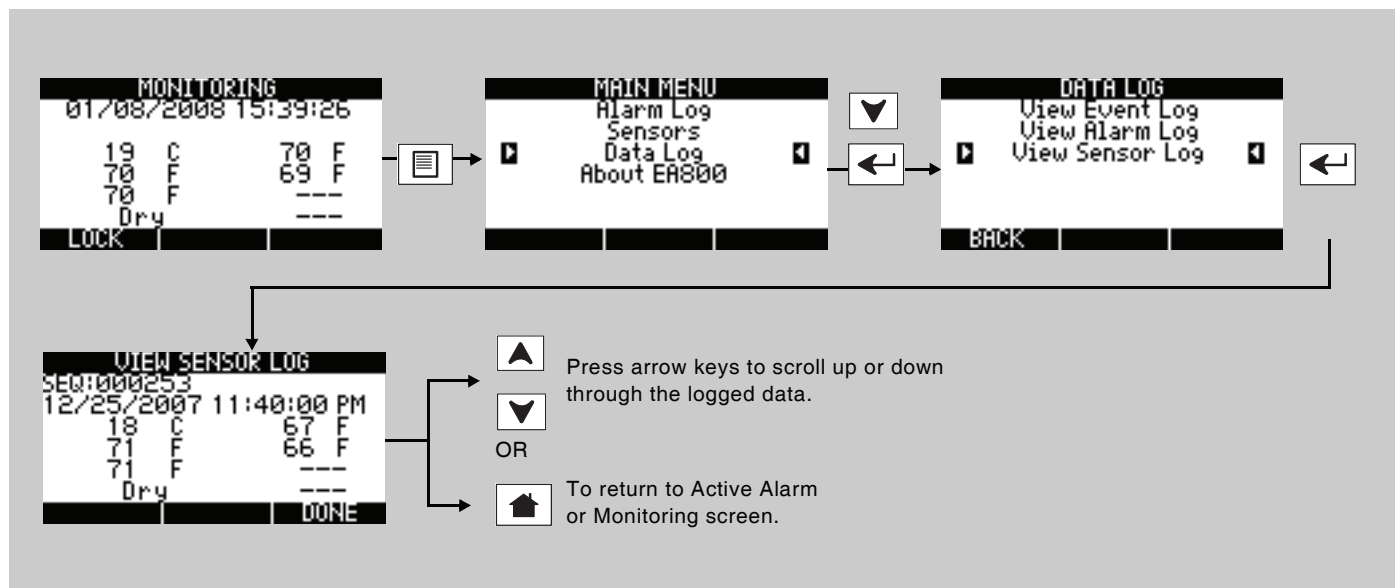

Viewing Firmware Information

The **About EA800** menu item displays the currently running firmware version. To view the firmware version, do the following:

Note: The firmware revision number shown indicates the firmware version currently installed.

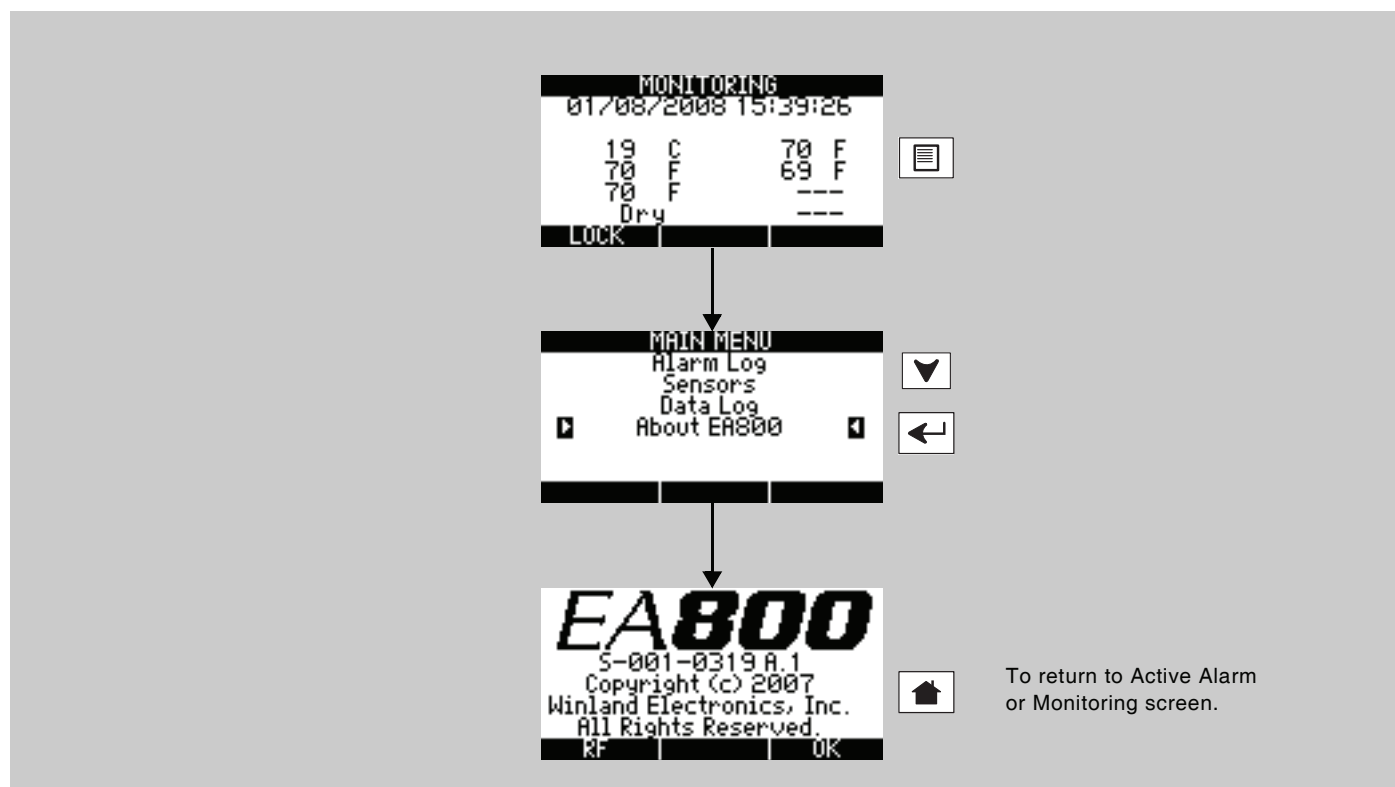

Viewing RF Information

The **ABOUT RF** screen displays the EA800 base unit's MAC address, the RF channel currently in use, the RF communications protocol version, and the RF subsystem's firmware version. To view the RF settings, perform the following procedure:

Note: The firmware revision number shown indicates the firmware version currently installed.

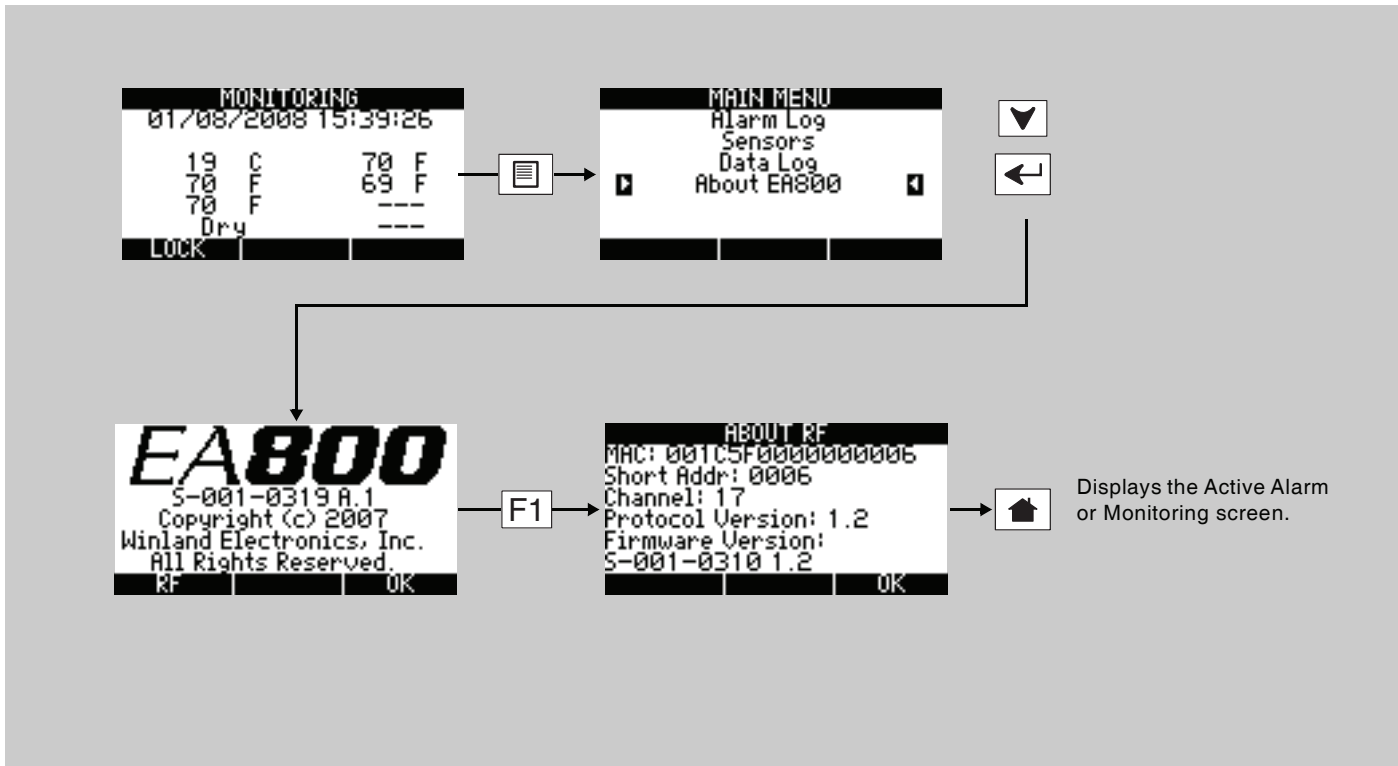

This chapter contains instructions on performing the following maintenance tasks:

- Lock/unlock the base unit: See “Locking and Unlocking the EA800” on page 55
- Pausing/resuming sensor monitoring: See “Pausing Monitoring and Cancelling Pause” on page 56
- Adding sensors: See “Adding a Sensor” on page 57
- Replacing a sensor. See “Replacing a Sensor” on page 57
- Deleting a sensor. See “Deleting a Sensor” on page 59
- Reprogramming a Relay. See “Reprogramming a Relay” on page 59
- Exporting all logs. See “Exporting the Stored Logs” on page 68
- Clear the alarm log. See “Clearing the Alarm Log” on page 64
- Clear the sensor log. See “Clearing the Sensor Log” on page 64
- Change the current date or time. See “Changing the Date or Time Setting” on page 61
- Change date format. See “Changing the Date Format” on page 60
- Change time format. See “Changing the Time Format” on page 60
- Change data collection frequency. See “Changing Sensor Data Collection Frequency” on page 61
- Enabling or disabling the audible alarm buzzer. See “Changing the Buzzer Setting” on page 62
- Changing the password. See “Changing the Password” on page 63
- Clearing the alarm log file. See “Clearing the Alarm Log” on page 64
- Clearing the sensor log file. See “Clearing the Sensor Log” on page 64
- Updating the firmware. See “Updating the Firmware” on page 65
- Saving the configuration to a USB drive. See “Saving Configuration Settings” on page 66
- Loading a configuration from a USB drive. See “Loading Configuration Settings” on page 67
- Exporting stored logfiles for review or archiving. See “Exporting the Stored Logs” on page 68

Note: The base unit must be unlocked before you can perform any of the maintenance tasks in this chapter.

Locking and Unlocking the EA800

The base unit is normally locked. When locked, it cannot be programmed and certain maintenance features, such as **PERFORMANCE**, cannot be accessed. Locking restricts access to these features to authorized personnel only. If left unlocked, the base unit locks automatically after a period of inactivity.

The current state of the EA800 is indicated by the text above the **F1** soft key when the home screen is displayed:

- When **UNLOCK** is displayed, the base unit is *locked*. Press **F1**, use the **PREV** and **NEXT** soft keys to advance the cursor to the next digit, and use the arrow keys to enter the value for the password. The default password is **0800**.



- When **LOCK** is displayed: The base unit is currently *unlocked*. Press **F1** to lock it. The base unit locks automatically after 30 minutes of inactivity

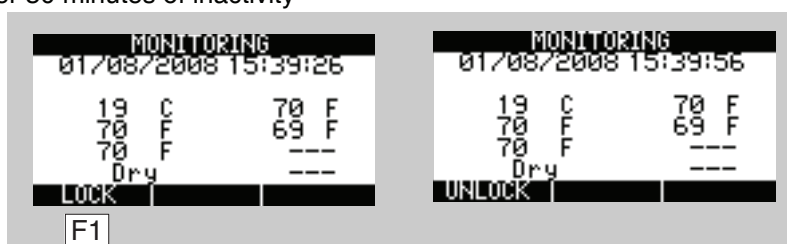

Pausing Monitoring and Cancelling Pause

To prevent false alarms when performing maintenance, pause sensor monitoring. Pausing stops monitoring and ignores active alarms for a 30-minute period. When the pause function times out, monitoring automatically starts. To pause the EA800 perform the following procedure:

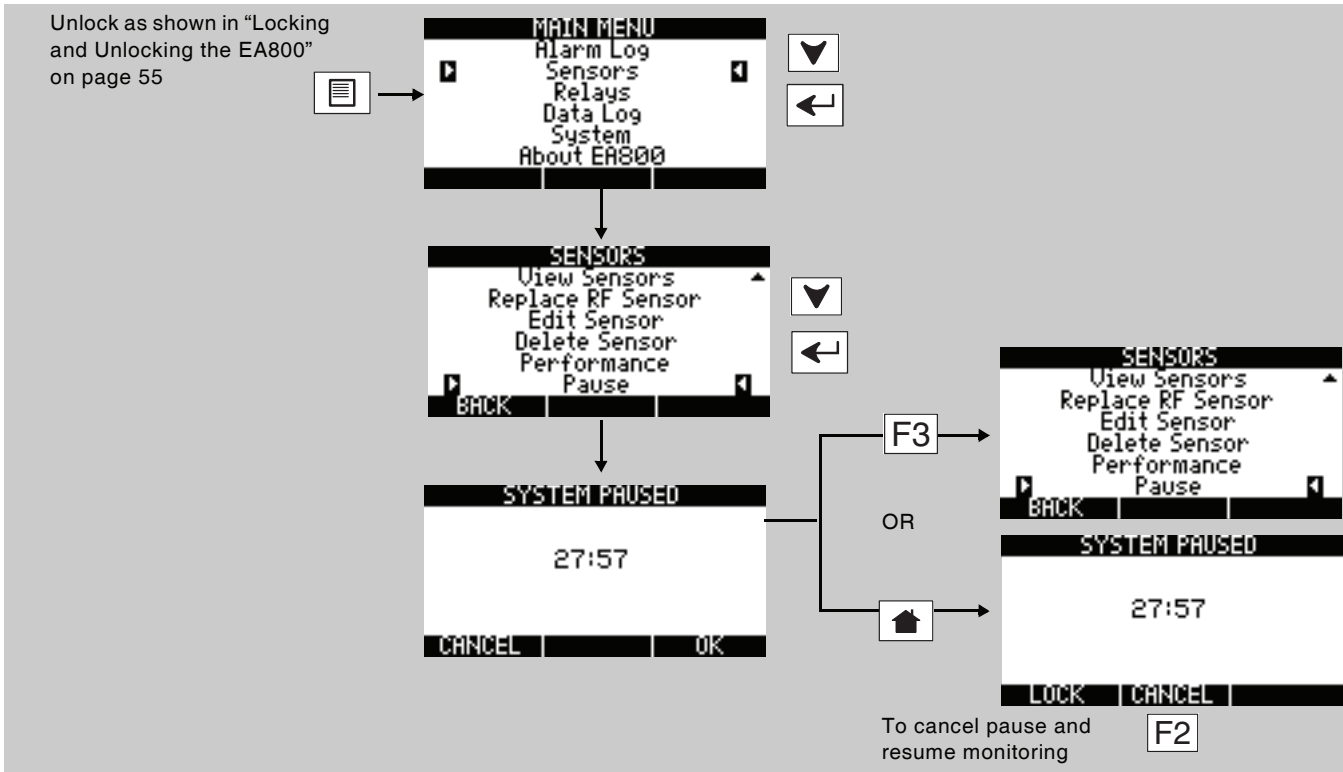

When the system is paused the **SYSTEM PAUSED** screen is displayed until pause times out (30 minutes) or you cancel it. You can access all functions in the main menu while the system is paused. To resume monitoring instead of allowing the pause function to time out perform the following procedure:

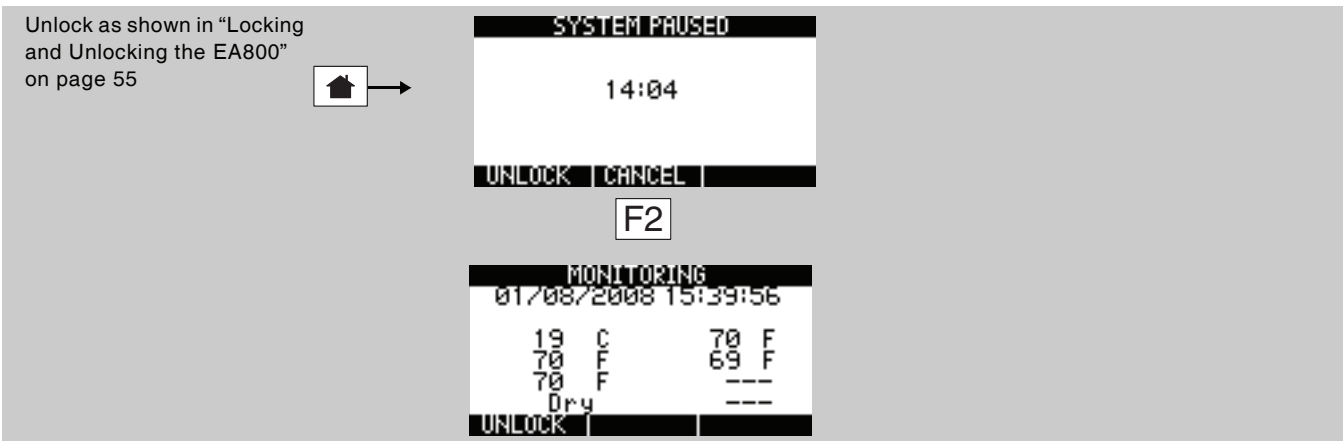

Adding a Sensor

The procedure for adding a sensor to an existing system is the same as for a new system. See “Install the Wired Sensors” on page 22 or “Install the Wireless Sensors” on page 22 for instructions on physically installing the sensor and then programming the sensor in the EA800 base unit.

Note: See “Pausing Monitoring and Cancelling Pause” on page 56 and pause the base unit before you begin so you can set up the sensor without tripping the alarm.

Note: If adding more than one sensor, add them to the system one at a time. (Power on one sensor and add it to the system, then power on the next sensor and add it). Do not power on all sensors at the same time.

Note: Update the system’s Configuration Worksheets to document any changes.

Replacing a Sensor

The EA800 allows you to replace an existing, programmed wireless sensor with another of the same type. When replaced, the original sensor’s programmed settings and parameters are retained and applied to the new sensor. If you need to change settings other than those provided in the **Edit Sensor** screen, you must delete the existing sensor and then add the replacement sensor.

Note: See “Pausing Monitoring and Cancelling Pause” on page 56 to pause the base unit before you begin so you can replace the sensor without tripping the alarm.

Note: If adding more than one sensor, add them to the system one at a time. (Power on one sensor and add it to the system, then power on the next sensor and add it). Do not power on all sensors at the same time.

Note: Update the system’s Configuration Worksheets to document any changes.

To replace an existing wireless sensor:

1. Physically replace the sensor with another of the same type and ensure it is powered on.
2. Perform the procedure shown below to allow the base unit to search for the new sensor:

Unlock the EA800 as shown in “Locking and Unlocking the EA800” on page 55

The diagram illustrates the navigation sequence for replacing a sensor. It starts with the MAIN MENU, where the user selects SENSORS. From the SENSORS menu, the user selects REPLACE RF SENSOR. This leads to a screen showing the current sensor (Cooler #3 and Cooler #4). The user then presses OK to enter the REPLACE RF SENSOR screen, which displays SEARCHING. Once a new sensor is detected, the user selects it from the SELECT SENSOR screen, which shows the sensor ID 00000081.

3. Select the detected sensor from the **SELECT SENSOR** screen. If the detected new sensor is the same type as the replaced sensor, the **SENSOR REPLACED** screen is displayed.
4. Press **OK (F3)** to return to the **SENSORS** screen. If the replacement sensor appears in the list, highlight it and press **Accept**. If it does not appear in the list, press **Cancel (F1)** to continue the search process.

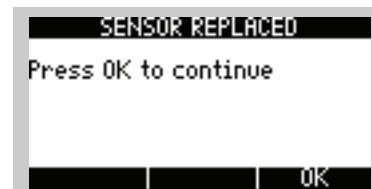

5. If the detected new sensor is **not** the same type as the replaced sensor, the **INVALID SENSOR TYPE** screen is displayed. Press **OK (F3)** to return to the **SENSORS** screen:
6. Do one of the following:
 - Replace the physical sensor with one that matches the type of the replaced sensor and repeat this procedure.
 - Delete the sensor from the base unit and replace with the new sensor (of a different type). See “Deleting a Sensor” on page 59 and “Adding a Sensor” on page 57.
7. If you wish to replace another wireless sensor, repeat this procedure.
8. If you are finished performing sensor maintenance, press  to exit maintenance and resume monitoring.
9. Press **F1** to lock the keypad.



Editing Sensor Parameters

The general procedure for editing sensor parameters is provided below. Not all sensor parameters can be edited for an installed sensor. The editable parameters are dependent on the installed sensor, so the **EDIT SENSOR** screen varies according to the sensor selected. You **cannot** edit the following:

- The low and high scaled values for a 4-20mA sensor. If these require changes, you must delete the 4-20mA sensor and re-add it to the system. See “Connecting Wired HA-III+ Humidity Sensors” on page 25.
- A sensor’s type. For example, if a 4-20mA sensor was incorrectly added as a Blue temperature sensor, you must delete the incorrect sensor and then re-add the correct sensor.
- The unit of measure. If unit of measure must be changed, the sensor must be deleted and re-added to the system.

Note: Update the system’s Configuration Worksheets to document changes.

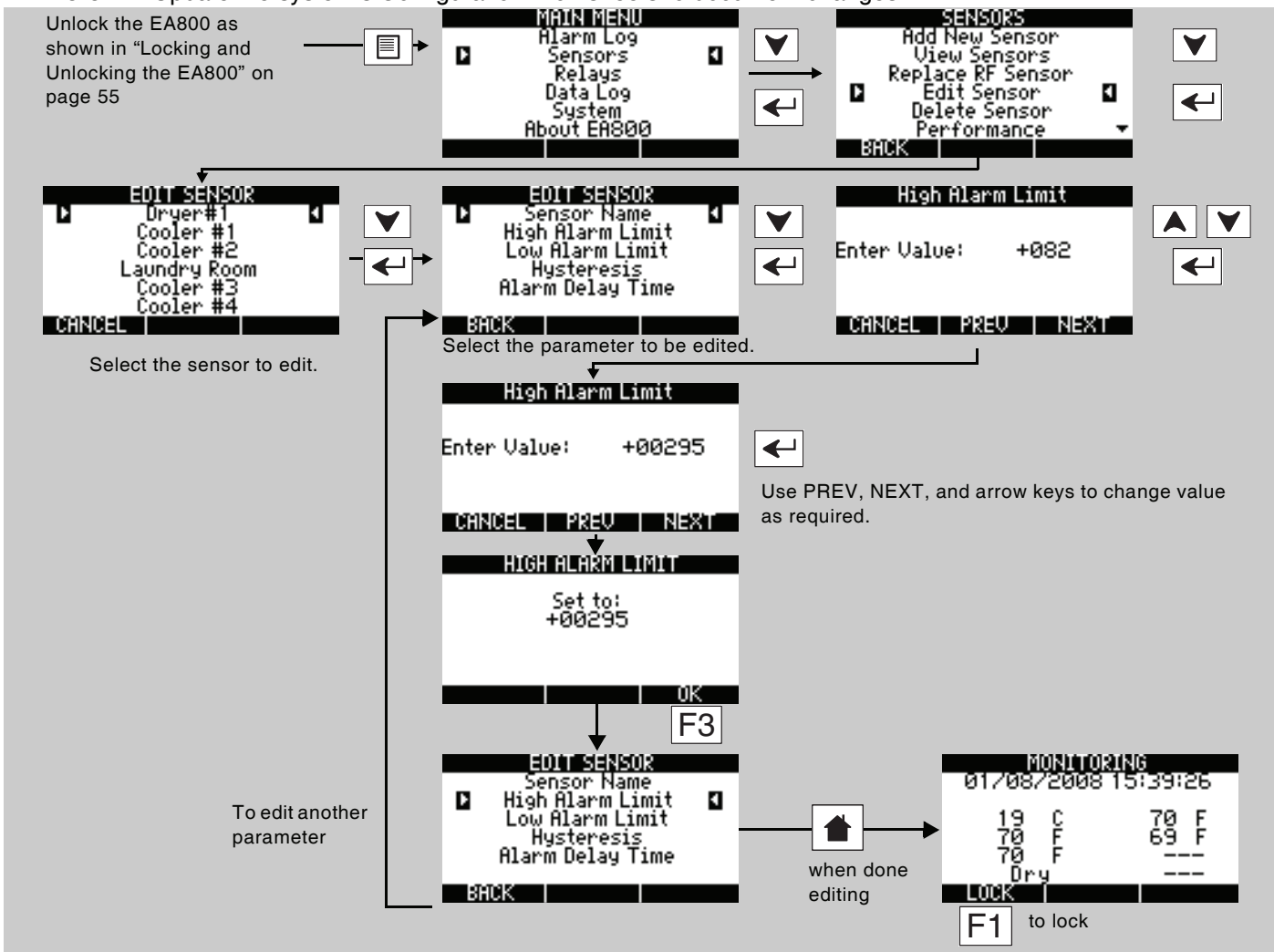

Reprogramming a Relay

Note: Ensure that the system's Configuration Worksheets are updated to document any changes.

A Relay can be reprogrammed as desired at any time. Perform the procedure outlined in "Configuring the Relays" on page 48 to reprogram any relay in the system.

Deleting a Sensor

Note: Update the system's Configuration Worksheets to document any changes.

To delete a sensor perform the following procedure:

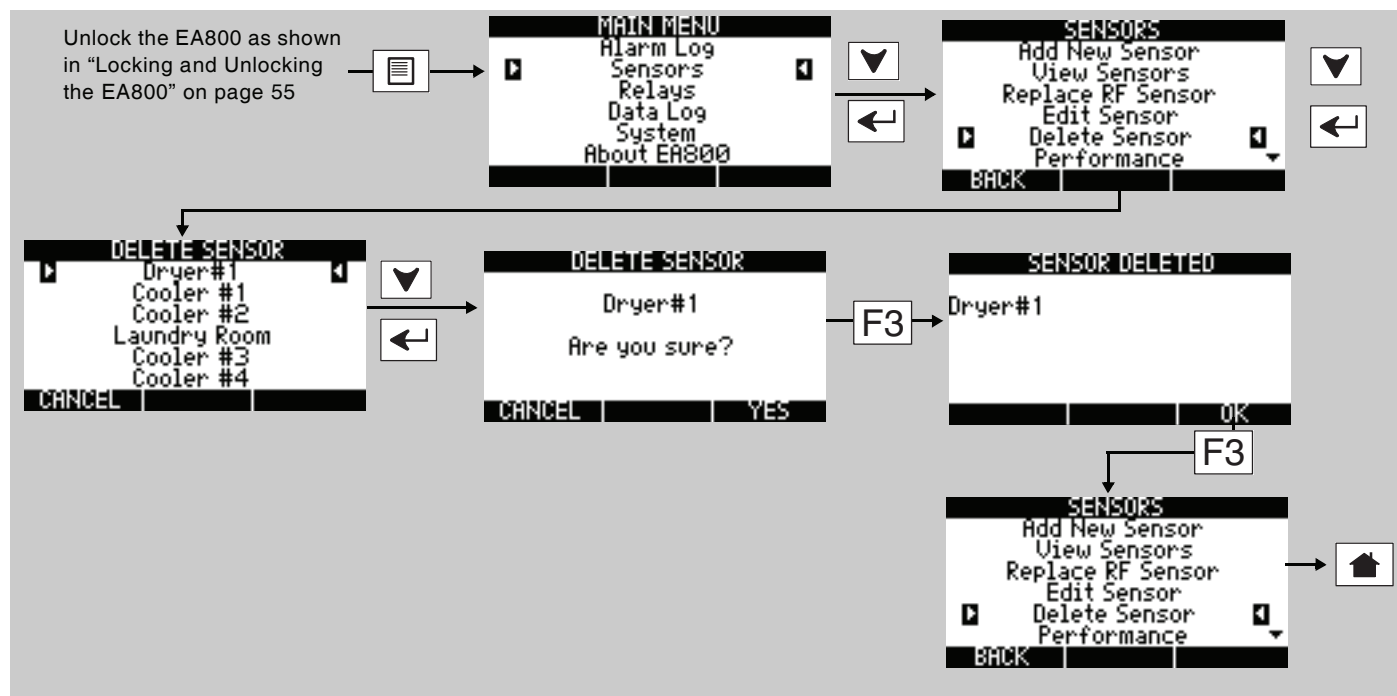

Changing the Date Format

Note: Update the system's Configuration Worksheets to document any changes.

Note: The default date format is MM/DD/YYYY.

To change the date format perform the following procedure:

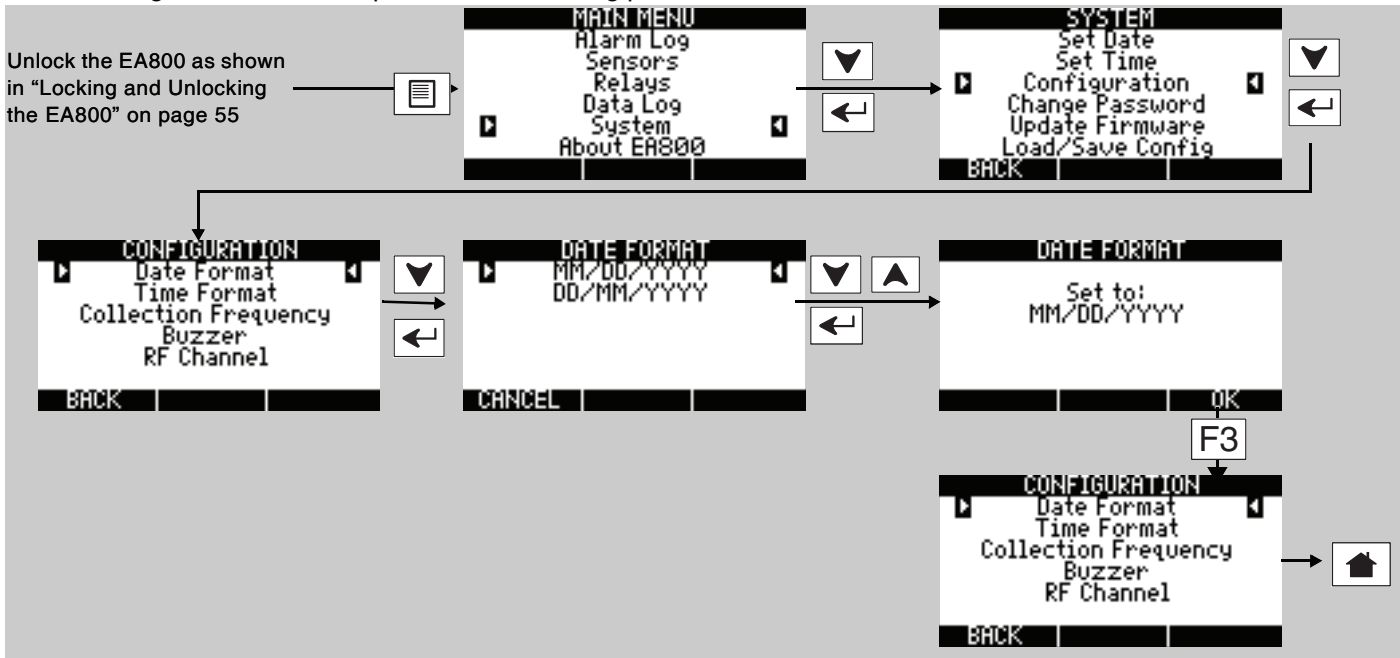

Changing the Time Format

Note: Update the system's Configuration Worksheets to document any changes.

Note: The default time format is 24 HR.

To change the time format perform the following procedure:

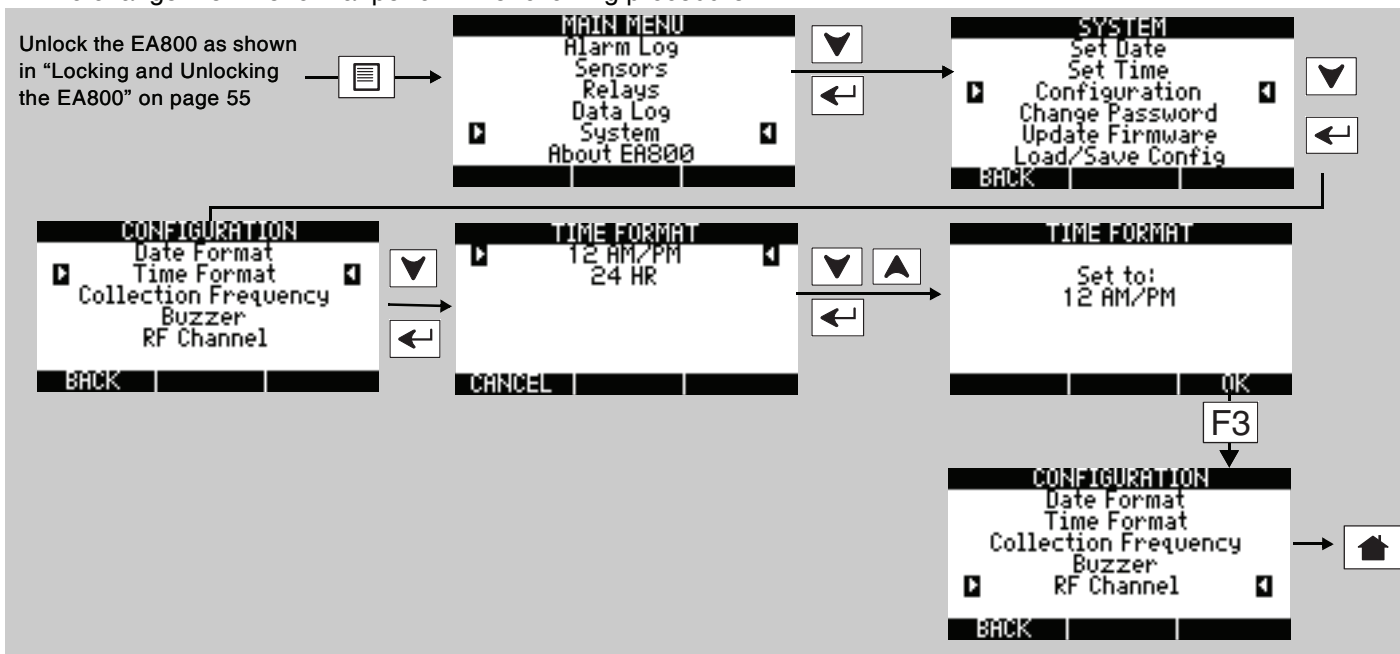

Changing the Date or Time Setting

To change the date see “Setting the Current Date” on page 31.

If your region uses Daylight Savings Time and you want the EA800 to display the correct time, you must change the time setting manually when Daylight Savings Time starts and ends. See “Setting the Time” on page 32.

Changing Sensor Data Collection Frequency

Note: Update the system’s Configuration Worksheets to document any changes.

Note: The default collection frequency is 5 Minutes. See Table 4 on page 9 for information on correlating data collection frequency to the number of data points collected.

To set the data collection frequency perform the following procedure:

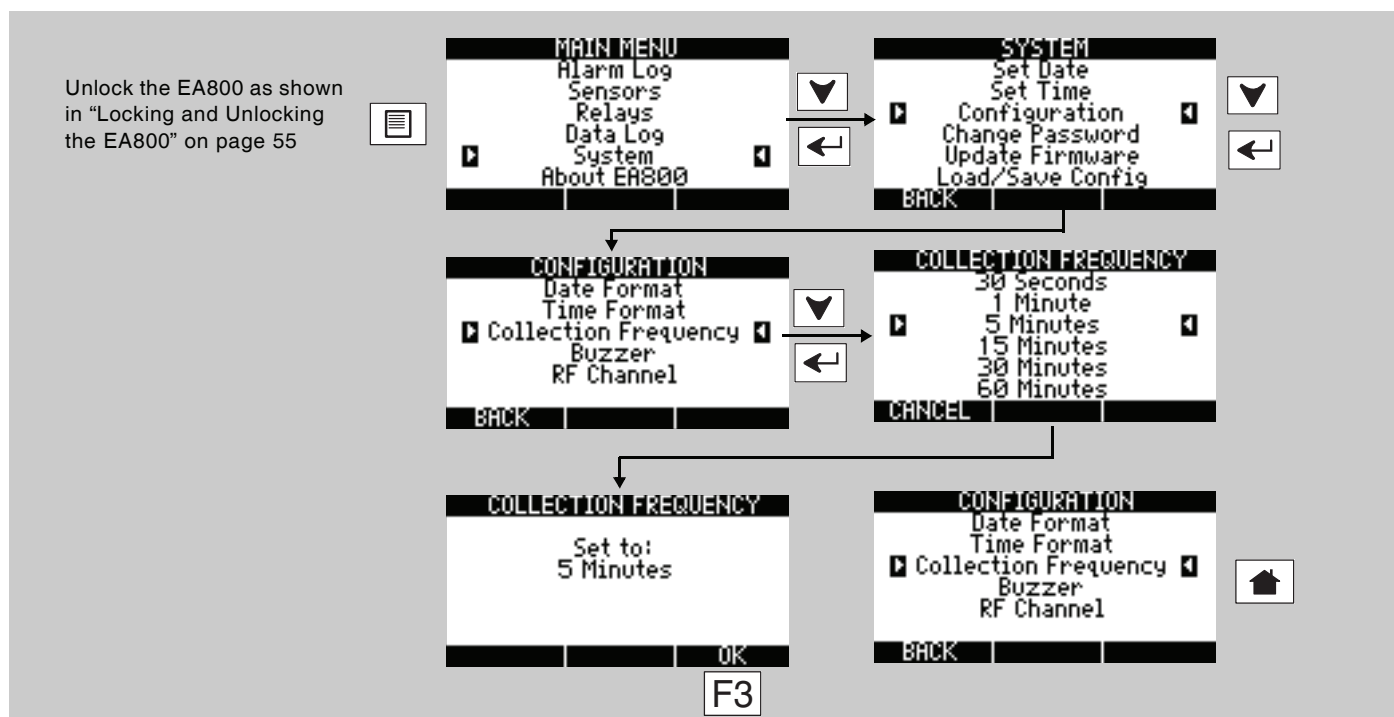

Changing the Buzzer Setting



Changing the buzzer setting to **DISABLED** turns off the audible alarm tone from the base unit. Do not disable the buzzer unless you are sure you do not want the base unit to emit an audible tone when an alarm occurs. The active condition of the buzzer mirrors what is assigned to the auxiliary relay.

Note: Update the system's Configuration Worksheets to document any changes.

Note: The default buzzer configuration is **ENABLED** and the active condition of the on-board buzzer mirrors what is assigned to the Auxiliary Relay.

To change the buzzer setting perform the following procedure:

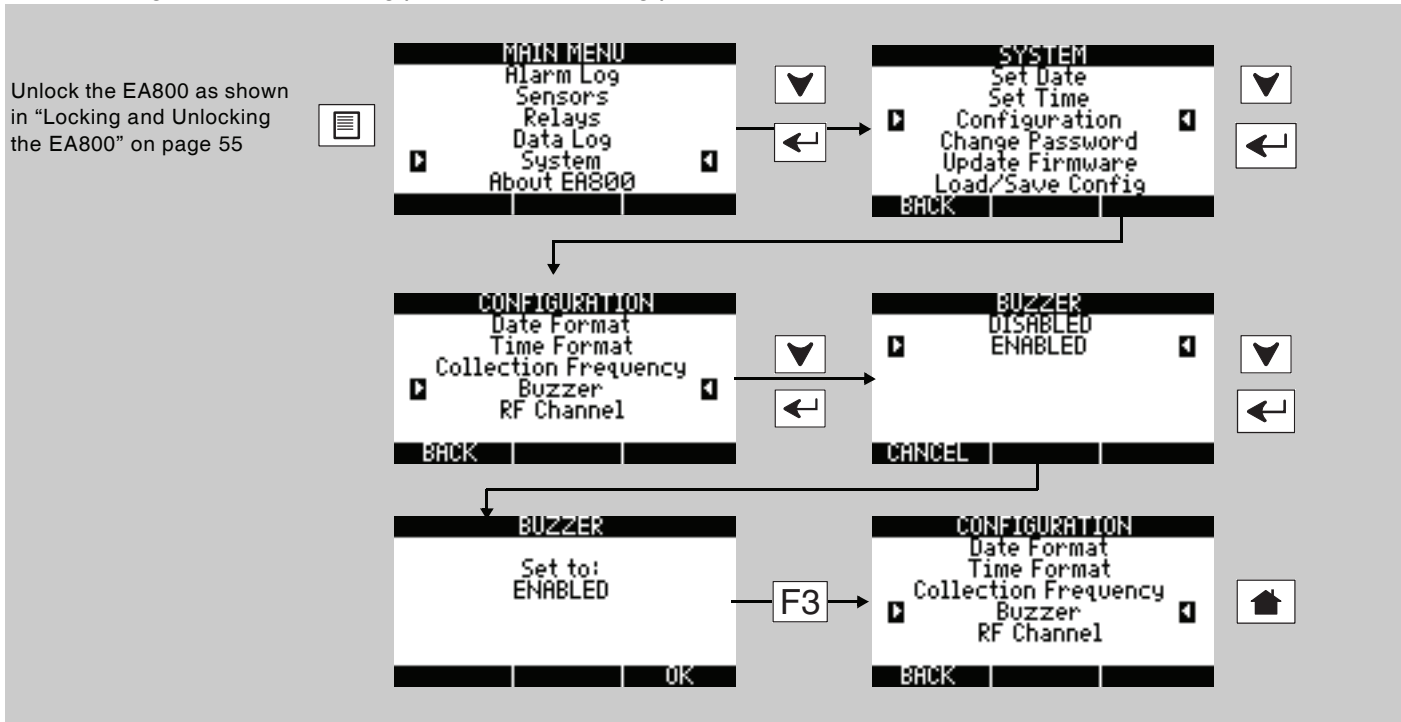

Changing the Password

Note: Update the system's Configuration Worksheets to document any changes.

Note: If you do not enter a valid password you will not be allowed to change the selected password. The default password (0800) cannot be changed or deleted. One user-configurable password may be set in addition to the default 0800 password.

To set or change the user-configurable password perform the following procedure:

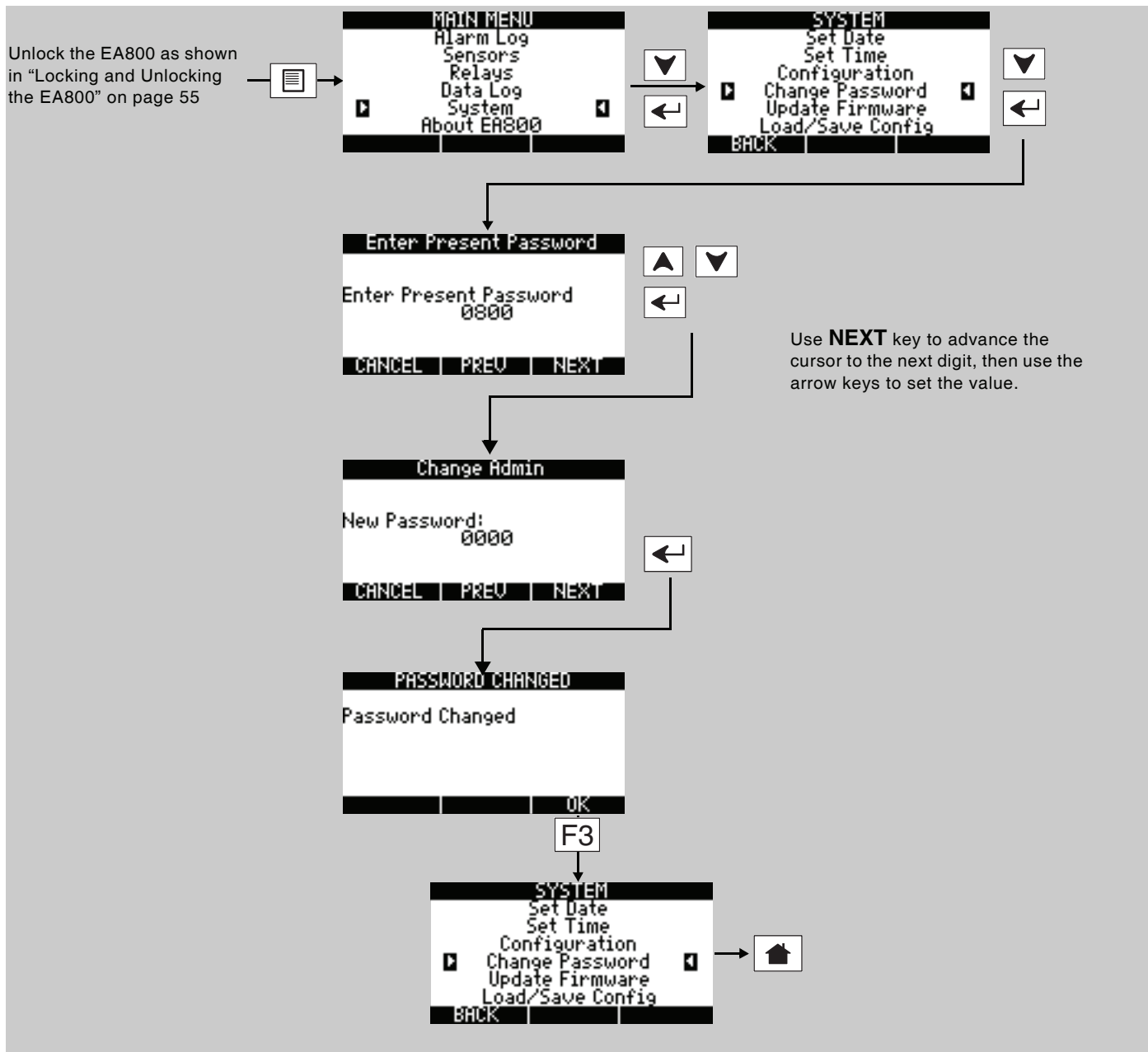

Clearing the Alarm Log

To clear all stored alarm records perform the following procedure:

Note: You cannot clear the Event Log.

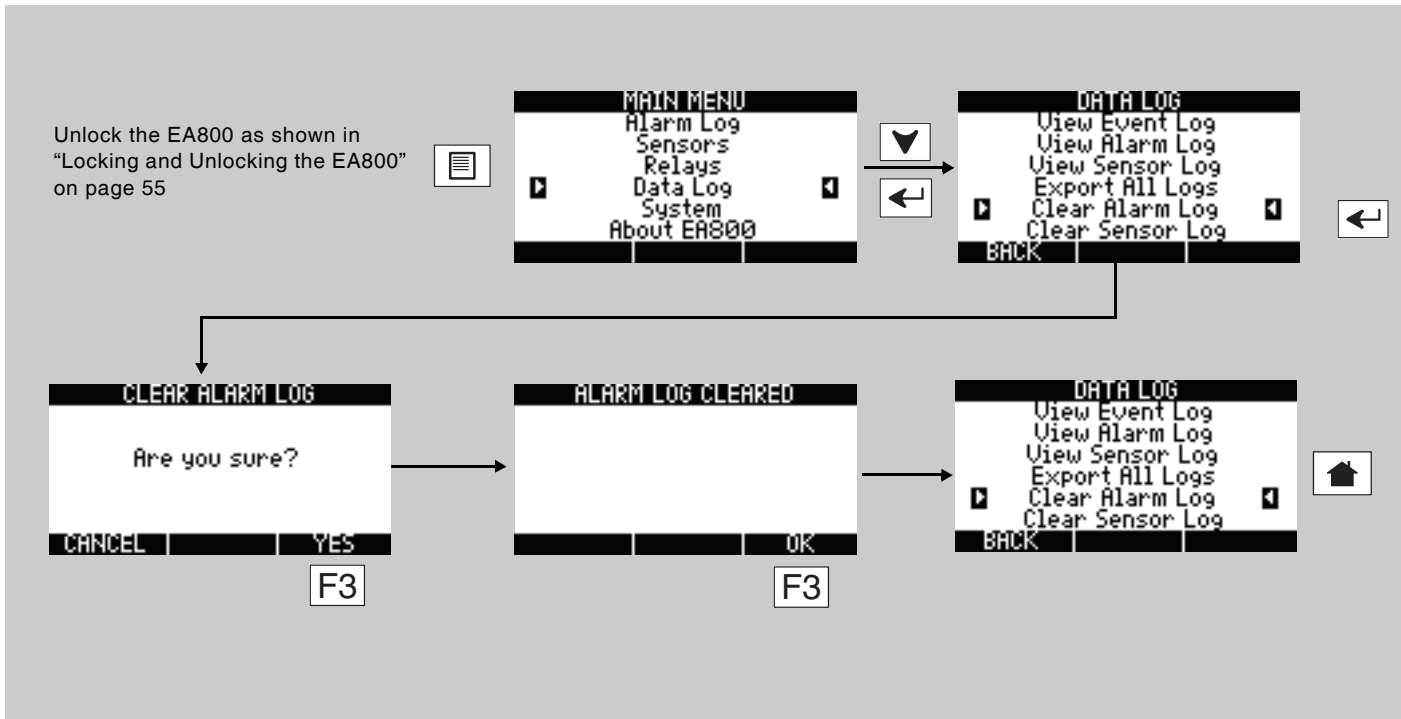

Clearing the Sensor Log

To clear all stored sensor records perform the following procedure:

Note: You cannot clear the Event Log.

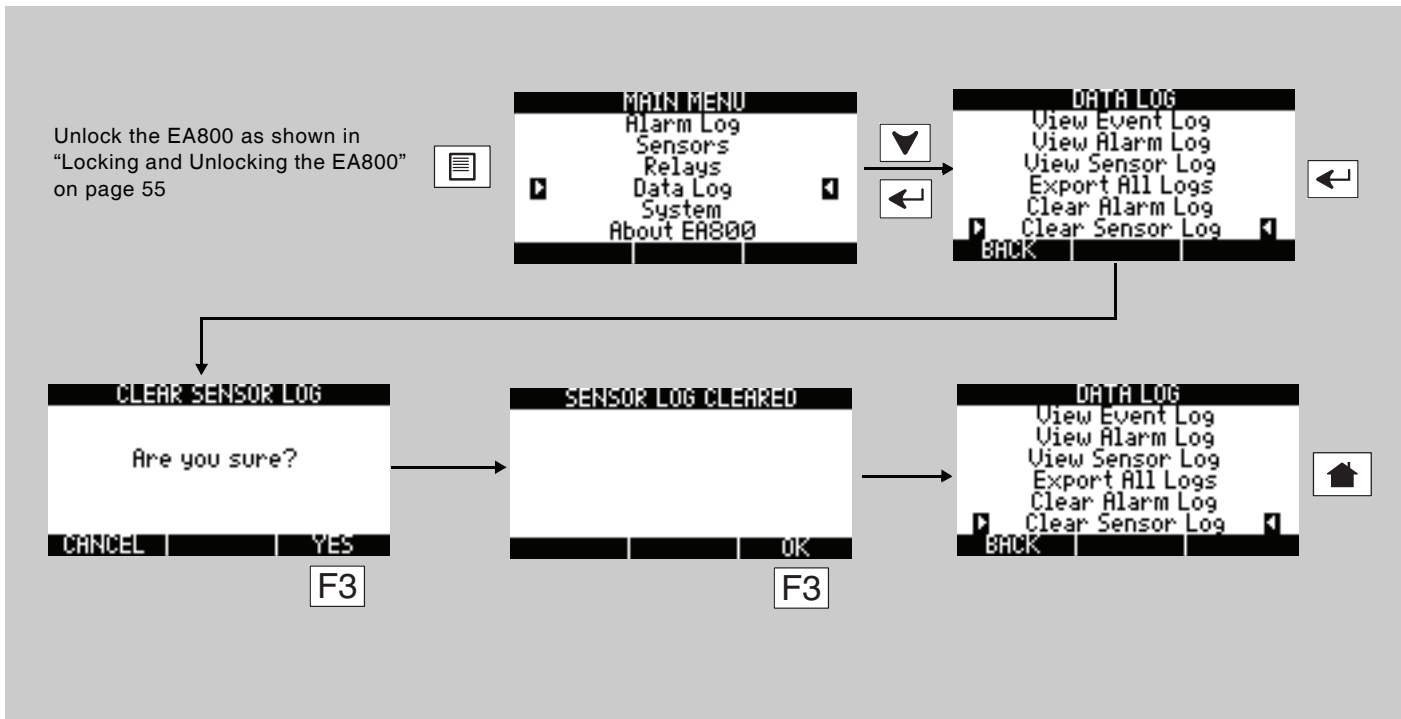

Updating the Firmware

Download the latest firmware from www.winland.com to your computer, then save it to a USB jump drive before performing the procedure for updating the firmware as shown below.

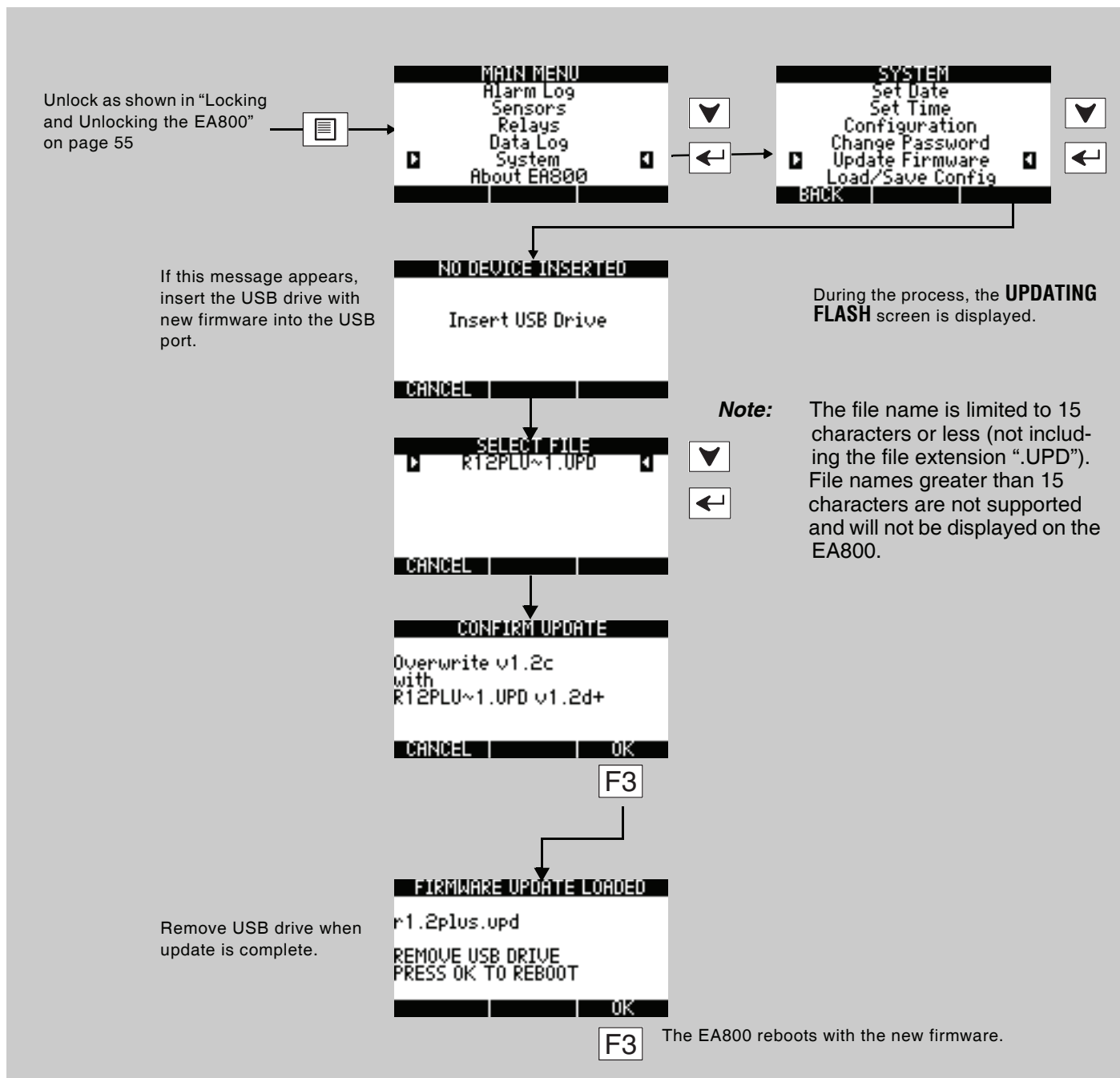

Saving Configuration Settings

You can export the configuration settings from the EA800 to serve as an archive for the system or as a template for quickly programming other systems. The configuration data is stored in a machine-readable format. To export configuration to a USB drive perform the following procedure:

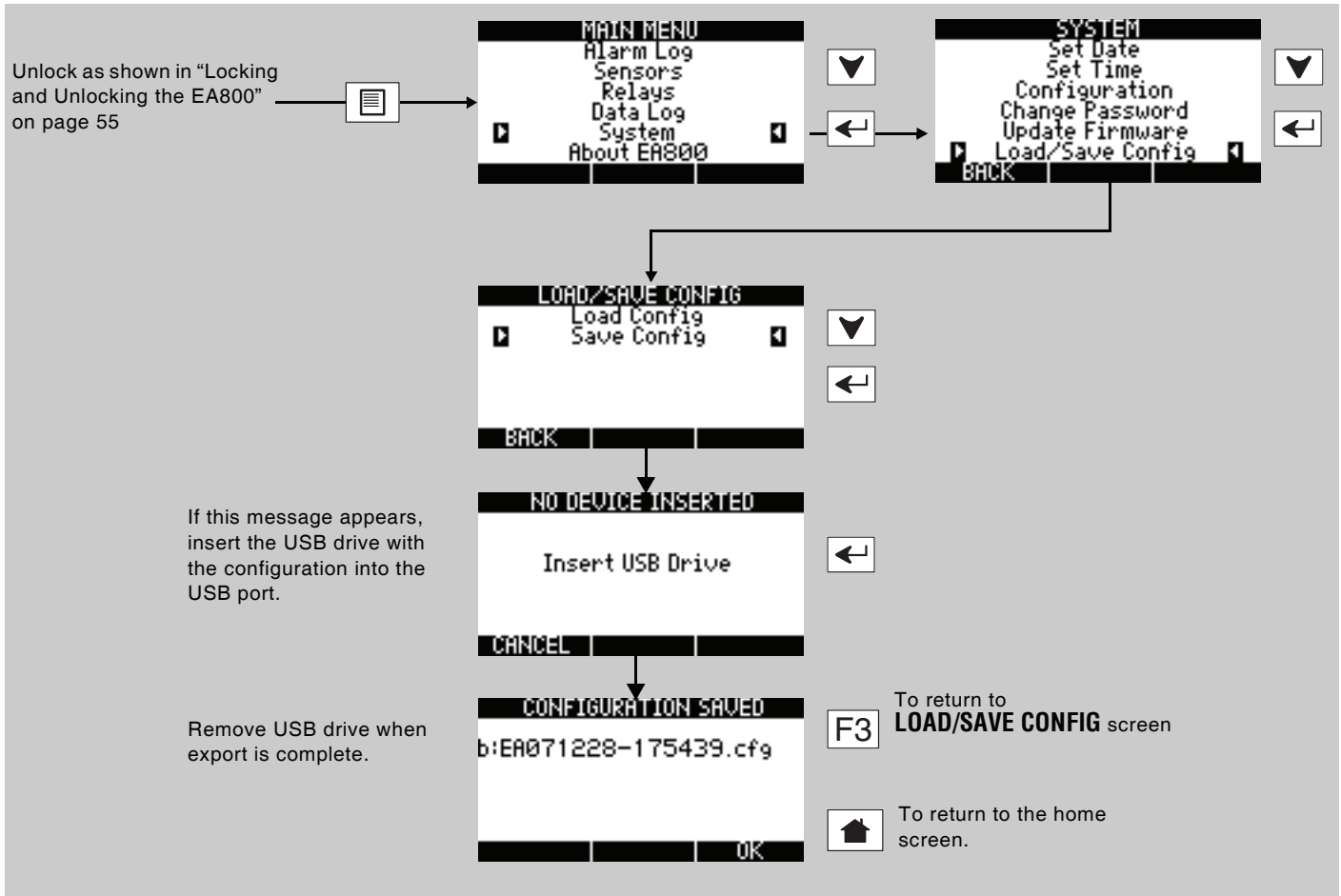

Now that the configuration is stored on the USB drive you should copy it onto a PC to provide a backup in the event that the USB drive is lost or fails. By default, the configuration file is named EAYMMDD-HHMMSS.cfg where:

- EA indicates that the configuration file is from the EA800.
- YYMMDD is the current date.
- HHMMSS is the current time in 24 hour format.

It is suggested that you rename saved configuration files to identify the specific EA800 system they came from using up to 15 characters, not including the file extension 'CFG'. File names longer than 15 characters are not supported.

Loading Configuration Settings

You can load configuration settings from a previously installed EA800 to serve as the template for the system being installed or updated. To load a configuration from a USB drive, insert the USB drive into the USB port and perform the following procedure:

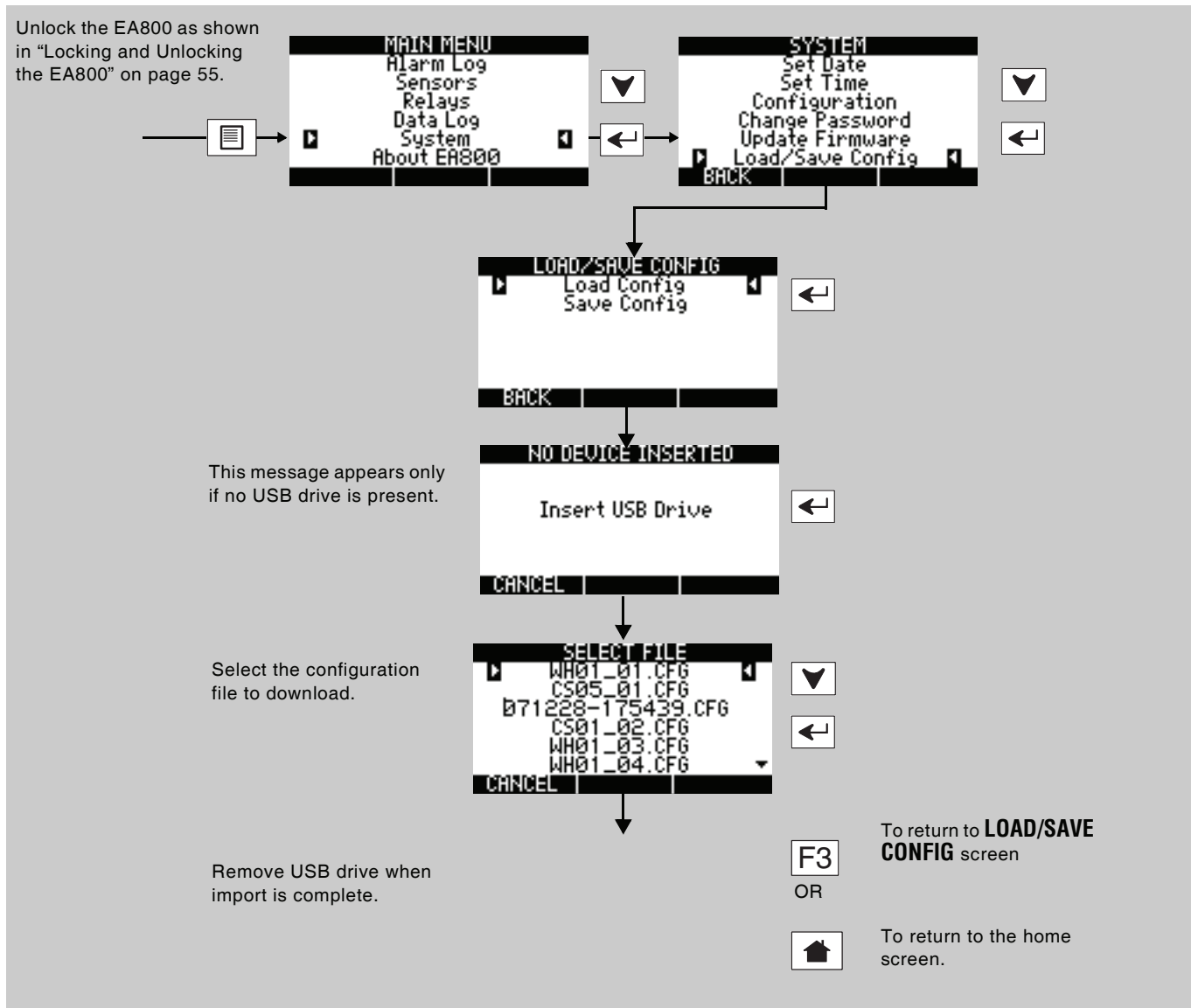

Exporting the Stored Logs

You can export the logs stored in the EA800 for archiving or later review. The export procedure exports the alarm log, data log, and event log files. To export the logfiles perform the following procedure:

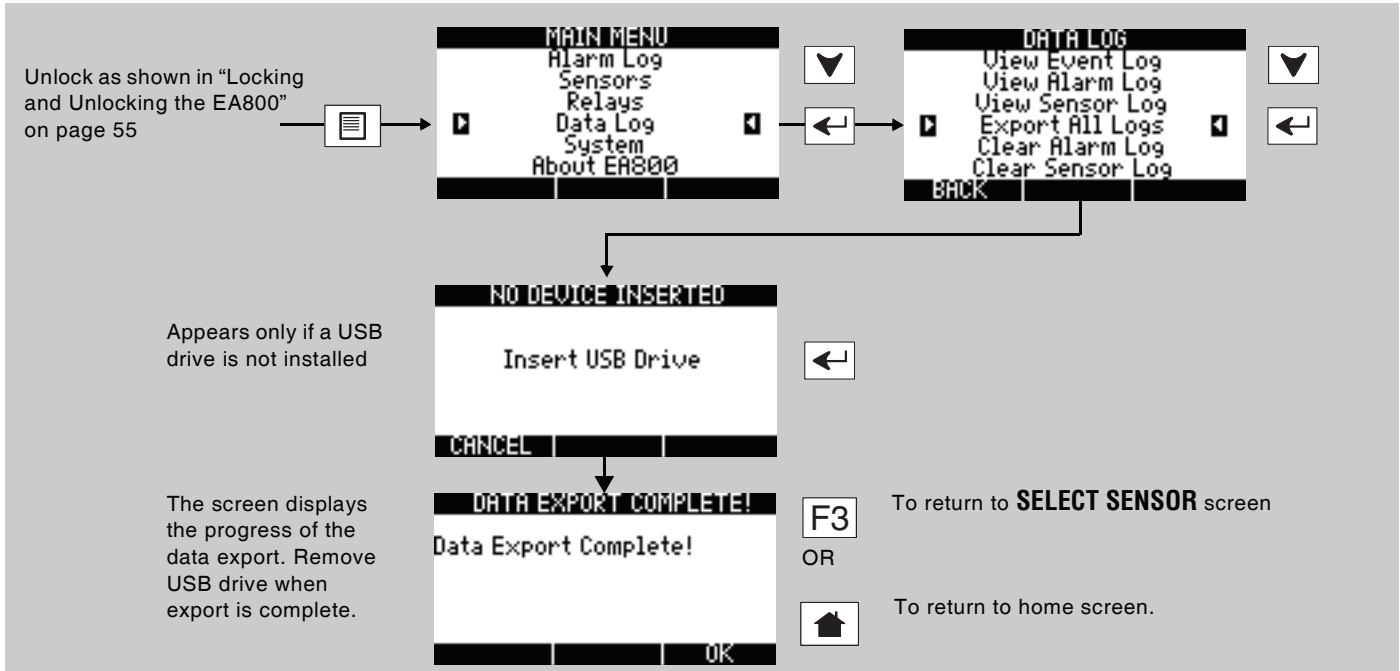

The EA800 stores the log files on the USB drive in comma separated value (CSV) format. The files are named in the format YYYYMMDD-HHMMSS.txt where:

- X = A, E, or D:
 - A = Alarm log file
 - E = Event log file
 - D = Sensor data log file
- YYYYMMDD is the current date.
- HHMMSS is the current time in 24 hour format.

You can rename the files to more easily identify the EA800 system they came from, however, the first character designating the log type (A, E, or D) must be retained if using the template available at www.winland.com. Because the files are in CSV format they can be converted to tables in a word processing program or imported into a spreadsheet program.

Exported Alarm Data

The following is an example of exported alarm data:

```
12/27/2007 01:28:39 ,3,Laundry Room,Wet,Dry,Dry,,Wired,WaterBug,1
12/27/2007 01:29:10 ,3,Laundry Room,Dry,Dry,Dry,,Wired,WaterBug,0
12/27/2007 02:38:45 ,4,Cooler #3,67,-58,158,F,RF Contact,Blue,4
12/27/2007 02:39:48 ,4,Cooler #3,67,-58,158,F,RF Contact,Blue,0
12/27/2007 07:10:45 ,3,Laundry Room,Wet,Dry,Dry,,Wired,WaterBug,1
12/27/2007 07:10:50 ,3,Laundry Room,Dry,Dry,Dry,,Wired,WaterBug,0
```

The data presented provides the following alarm information:

Date and time of reading	Sensor Number	Sensor Name	Sensor Reading (at time of alarm)	Low Limit Value	High Limit Value	Unit of Measure	Sensor Connection	Sensor Type	Code
12/27/2007 01:28:39	3	Laundry Room	Wet	Dry	Dry	N/A	Wired	WaterBug	1

Exported Event Data

The following is an example of exported event data:

```
12/24/2007 07:06:03 PM,Sensor deleted,1
12/24/2007 07:10:50 PM,Sensor added,1
12/25/2007 02:27:14 PM,System power on,1
12/25/2007 02:27:50 PM,Sensor deleted,1
12/25/2007 02:36:02 PM,Sensor added,1
12/25/2007 03:08:55 PM,Sensor deleted,1
12/25/2007 03:11:19 PM,Sensor added,1
```

The data presented provides the following event information:

Date and time of event	Event description	Code (For Factory Use)
12/24/2007 07:06:03 PM	Sensor deleted	1

Exported Sensor Data

The following is an example of exported sensor data. The data is collected from all sensors at the intervals as specified in the **Data Collection** system setting (every 5 minutes in this example). Each sensor is allocated 11 data fields and 11 data fields are provided for all 8 sensors, regardless of how many sensors are actually connected.

```
12/26/2007 09:55:00
PM,17,C,,0,0,0,0,0,0,0,0,69,F,,0,0,0,0,0,0,0,0,69,F,,0,0,0,0,0,0,0,0,1,,,0,0,0,0,0,0,0,0,66,F,255,0,0
,0,0,0,0,0,0,65,F,105,0,0,0,0,0,0,0,0,,,,,0,1,0,0,0,0,0,0,,,,,0,1,0,0,0,0,0,0
12/26/2007 10:00:01
PM,17,C,,0,0,0,0,0,0,0,0,69,F,,0,0,0,0,0,0,0,0,69,F,,0,0,0,0,0,0,0,0,1,,,0,0,0,0,0,0,0,0,66,F,255,0,0
,0,0,0,0,0,0,65,F,90,0,0,0,0,0,0,0,0,,,,,0,1,0,0,0,0,0,0,,,,,0,1,0,0,0,0,0,0
12/26/2007 10:05:00
PM,17,C,,0,0,0,0,0,0,0,0,69,F,,0,0,0,0,0,0,0,0,69,F,,0,0,0,0,0,0,0,0,1,,,0,0,0,0,0,0,0,0,66,F,255,0,0
,0,0,0,0,0,0,65,F,75,0,0,0,0,0,0,0,0,,,,,0,1,0,0,0,0,0,0,,,,,0,1,0,0,0,0,0,0
12/26/2007 10:10:00
PM,17,C,,0,0,0,0,0,0,0,0,69,F,,0,0,0,0,0,0,0,0,69,F,,0,0,0,0,0,0,0,0,1,,,0,0,0,0,0,0,0,0,66,F,240,0,0
,0,0,0,0,0,0,65,F,75,0,0,0,0,0,0,0,0,,,,,0,1,0,0,0,0,0,0,,,,,0,1,0,0,0,0,0,0
12/26/2007 10:15:00
PM,17,C,,0,0,0,0,0,0,0,0,69,F,,0,0,0,0,0,0,0,0,69,F,,0,0,0,0,0,0,0,0,1,,,0,0,0,0,0,0,0,0,66,F,255,0,0
,0,0,0,0,0,0,65,F,65,0,0,0,0,0,0,0,0,,,,,0,1,0,0,0,0,0,0,,,,,0,1,0,0,0,0,0,0
12/26/2007 10:20:01
PM,17,C,,0,0,0,0,0,0,0,0,69,F,,0,0,0,0,0,0,0,0,69,F,,0,0,0,0,0,0,0,0,1,,,0,0,0,0,0,0,0,0,66,F,255,0,0
,0,0,0,0,0,0,65,F,75,0,0,0,0,0,0,0,0,,,,,0,1,0,0,0,0,0,0,,,,,0,1,0,0,0,0,0,0
```

Each entry is interpreted as:

12/26/2007 09:55:00 PM,(11 CSVs for Sensor 1),(11 CSVs for Sensor 2),(11 CSVs for Sensor 3),(11 CSVs for Sensor 4),(11 CSVs for Sensor 5),(11 CSVs for Sensor 6),(11 CSVs for Sensor 7),(11 CSVs for Sensor 8)

There is a line feed and a carriage return character at the end of each The data collected at 09:55:00 in the data log example above provides the sensor information shown below for Sensor 1. The data represented by each of the 11 data fields is defined below and is applicable to each of the 8 sensors that may be connected.

Date and time of reading	Sensor # 1										
	CSV1 Reading	CSV2 Unit of Measure	CSV3 LQI	CSV4 Pause	CSV5 Pending Alarms	CSV6 Low	CSV7 High	CSV8 Comm	CSV9 Fail	CSV10 No Data	CSV11 Low Battery
12/26/2007 09:55:00 PM	17	C	Null	0	0	0	0	0	0	0	0

- Blank (,): The data is null and is not valid for that sensor. For example, the LQI (signal strength) position is null for wired sensors but shows the LQI value as shown for the two wireless sensors (255 and 105 respectively). Where wireless sensors are not installed the LQI is also blank indicating that no reading is made.
- 0 (,0,): The data is valid and is valid data for that sensor’s data point.

Troubleshooting

Operating or setup errors are indicated by flashing data on the display. Often, a programming error also results in an alarm for the misprogrammed relay. The table below shows and describes common error displays, along with corrective action. For updated information, go to the EA800 page at www.winland.com and look for the troubleshooting section.

Table 13 Troubleshooting

Symptom	Cause	Corrective Action
Temperature reading indicates maximum when temperature is actually less.	Wired sensor is shorted Wired sensor cable has a short. Sensor has failed	Ensure that the sensor connection is not shorted. A short equals zero resistance and thus the maximum value. Replace damaged cable. Contact Winland Technical Services at 1-800-635-4269
Temperature reading indicates minimum when temperature is actually greater.	Wired sensor is not connected Wired sensor cable has an open. Sensor has failed	Ensure that the sensor is connected to the correct header pins. An open connection equals an infinite resistance and thus the minimum value. Replace damaged cable. Contact Winland Technical Services at 1-800-635-4269.
Temperature display does not equal actual temperature.	Incorrect sensor programmed	Verify the actual sensor connected to the sensor input is programmed appropriately. Each temperature sensor is limited to a specific operating range.
Display flashes repeatedly between the Winland Electronics Inc. screen and a blank screen.	The EA800 reboots repeatedly and fails to successfully complete the boot process.	Cycle power to the EA800 and wait for a period of time before reapplying power. If a USB drive is attached to the USB port, remove it and cycle power as noted above. If the problem recurs, contact Winland Technical Service at 1-800-635-4269.
The display flashes while displaying the ACTIVE ALARMS screen	A sensor's reading has exceeded a set limit. A wireless sensor is not communicating with the base unit.	Verify the environmental conditions of the sensor. Verify the received signal strength as outlined in "Verifying RF Signal Strength" on page 72.

Verifying RF Signal Strength

Viewing Signal Strength for a Wireless Sensor

To verify the RF signal strength received by the EA800 perform the following procedure:

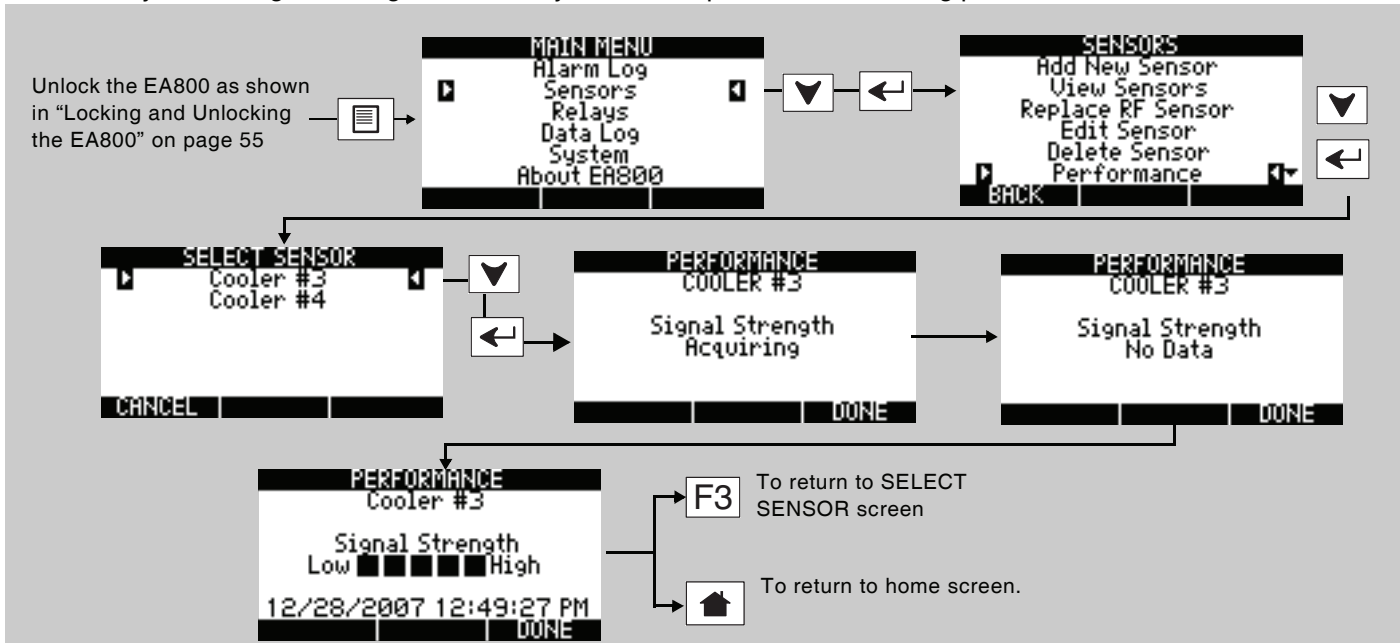

If the remote sensor transmitter you are verifying is battery powered, it may take up to 30 seconds for the base unit to receive a transmission from the remote sensor.

The base unit displays an approximation of signal strength as indicated by the number of filled boxes on the screen as shown at right.

Note: The date and time shown at the bottom of the **PERFORMANCE** screen is the time stamp of the last received transmission.



Ensure that at least 2 **Signal Strength** bars are displayed as shown at right. If not, it is recommended that the sensor be relocated until at least 2 bars are achieved. More bars reduces sensor alarm latency, reduces the probability of communication alarms, and increases battery life.

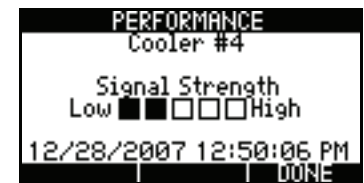

For additional information on how to improve signal strength, refer to Winland application note AN00101.

Base Unit and Sensor Specifications

The following table lists the specifications for the EA800 base unit, sensors, and accessories.

Table 14 Specifications

Item	Specification
Dimensions	Approximately 230 mm x 199 mm x 55 mm ("9.375 H x 8.125" W x 2.25" D)
Weight	Base Unit: 0.27 kg (0.6 lb.) Wireless Sensors: 0.11 kg (0.26 lb.) with batteries
Mounting	The EA800 base unit is mountable directly to 3-gang standard electrical enclosure using pre-drilled holes on the EA800 rear case. The EA800 base unit and wireless sensors can be mounted to drywall or similar surfaces using the appropriate anchors (not included).
Case Material	ABS, UL94V-0 rated
EA800 Input (Operating) Voltage 1, 2, 3	+11 to +26VDC @ \leq 500mA current draw. Standard commercial filtered and regulated power supply suitable. Supplied by AC adapter (not included; see Accessories) or alarm panel. Note: Power supply requirement does not include additional requirements for loads switched through alarm output relays where power is derived from EA800 EA400 terminal strip connections.
EA800 Aux Power Out	Equivalent to DC input voltage used: +11 to +26VDC (Maximum output current 0.5A).
EA800 Real-Time Clock Battery	CR2032 (3V Cell)
Wireless Sensor Input Voltage	Either: • +12VDC @ \leq 100mA current draw using a 2.1 mm barrel plug, center positive; OR • 2xAA Alkaline Batteries (1.5V Cell)
Wireless Sensor Radiating Power (minimum, at PCB antenna connector)	• EA800 base unit: -3.5 dBm • Sensors: -2.5 dBm
Wireless Sensitivity: (minimum at printed circuit board antenna connection)	• EA800: -94.5 dBm • Sensors: -95.5 dBm
Low and High Limit Adjust Range: (Winland thermistor sensors only)	
Temperature:	-80° C to 150° C (-112° F to 302° F) Note: The Low and High Limit Adjust Range is dependent upon the sensor being used. See "Accessories" on page 44.
Humidity:	5 to 95% RH Note: The Low and High Limit Adjust Range is dependent upon the sensor being used. See "Accessories" on page 44.
Water Presence:	No Alarm / Alarm
Sensors	Up to four wired sensors Up to four wireless sensors
Cable Length to Wireless Multi-Function Sensor EA-WMFS	100 ft. maximum
Wired Temperature Sensor:	2-wire; maximum 304 m (1000 ft.) cabling length
Wired Humidity Sensor:	3-wire; maximum 304 m (1000 ft.) cabling length

Table 14 Specifications — continued

Item	Specification
Wired Water Presence Sensor:	2-wire; maximum 304 m (1000 ft.) cabling length
Wired 4-20mA Sensor	EA800 load (160 Ohms maximum)
Relay Outputs	(9) Form C with 3-terminal NC/COM/NO connections. Note: There are 8 primary relays (1 dedicated for each sensor) and 1 auxiliary relay.
Relay Contact Ratings	Max 30VDC @ 1 amp resistive. Not for use with AC power.
Relay Logic	Each relay is user configurable.
Display	128x64 graphic LCD, with blue backlight
Device Environmental Operating Range:	
Humidity:	5 to 95% RH, non-condensing
Temperature, Operating:	0°C to 50°C (32° F to 122° F). Not for installation inside coolers or freezers.
Ambient Environmental Quality:	Indoor use intended, non-corrosive environment
Conformity Certifications	FCC Part 15, Subpart C, Class B ICES-003, Issue 3; 1997 NRTL CUE certification mark
Warranty	Two (2) Year Limited Warranty. See Warranty and Service Information.
Notes:	
1. Where required, this equipment is to be isolated from the mains supply by a limited power source as specified in EN60950.	
2. All terminals must be connected to a Class 2 Power Limited Circuit complying with the National Electric Code NFPA 70, Article 725.	
3. See "Specifications" on page 46 for power supply requirements.	

Accessories

Accessories available for use with the EA800 Environmental Alarm System are listed below.

Table 15 Accessories

Item (Winland Part Number)	Description
BZ-3: Audible alarm module (PN 1183)	Buzzer for connection to auxiliary relay output that provides audible alarm indication.
Power supply (transformer) (PN L-020-0085)	Regulated 110 VAC-to-12 VDC @ >500 mA (minimum) transformer suitable for use with EA800. Note: Power supply must be a limited power source per notes 1 and 2 in Table 14.

Appendix A: Screen Maps

The figures in this Appendix illustrate the flow of all EA800 screens.

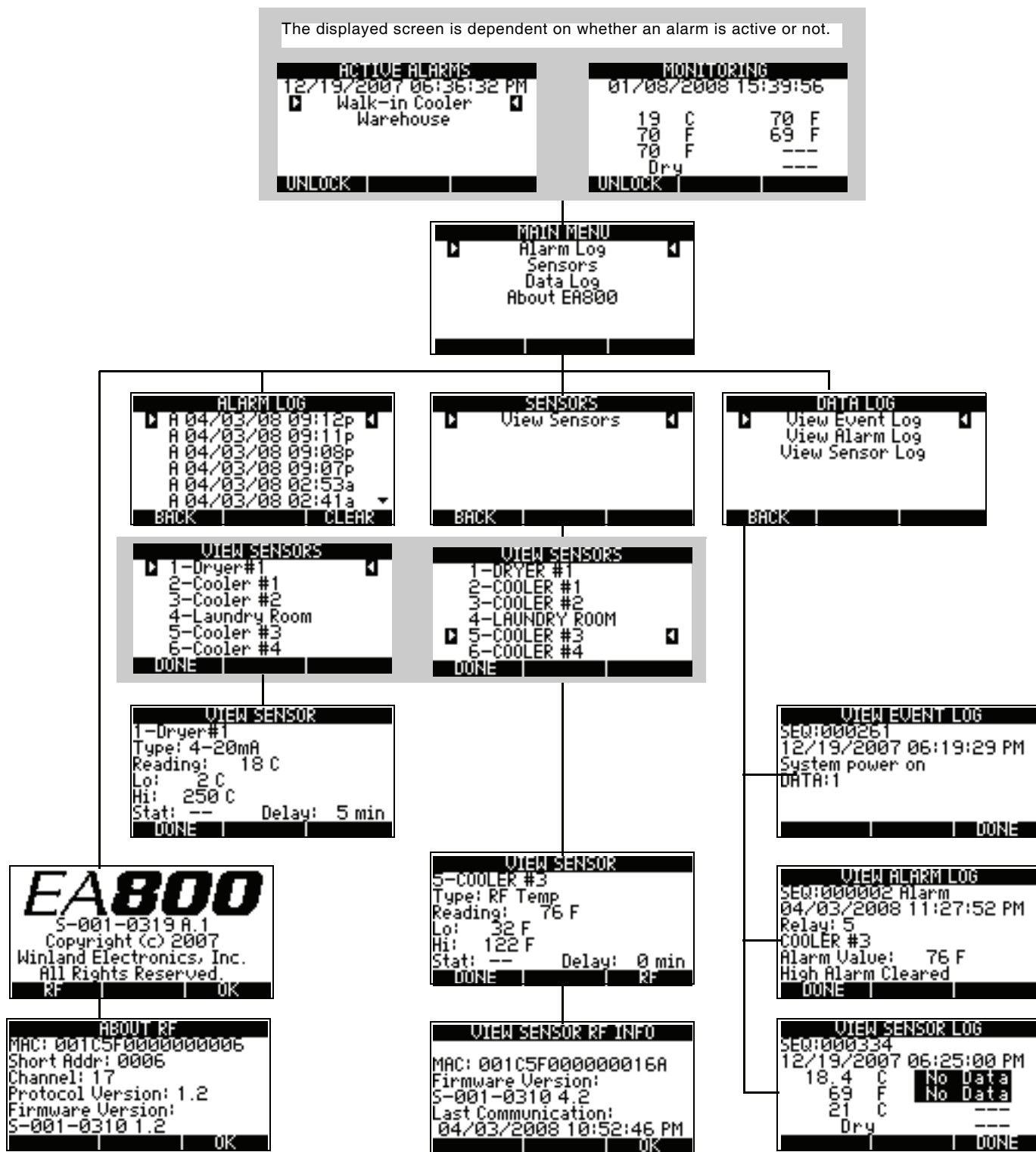

Figure 17. Locked Screen Map

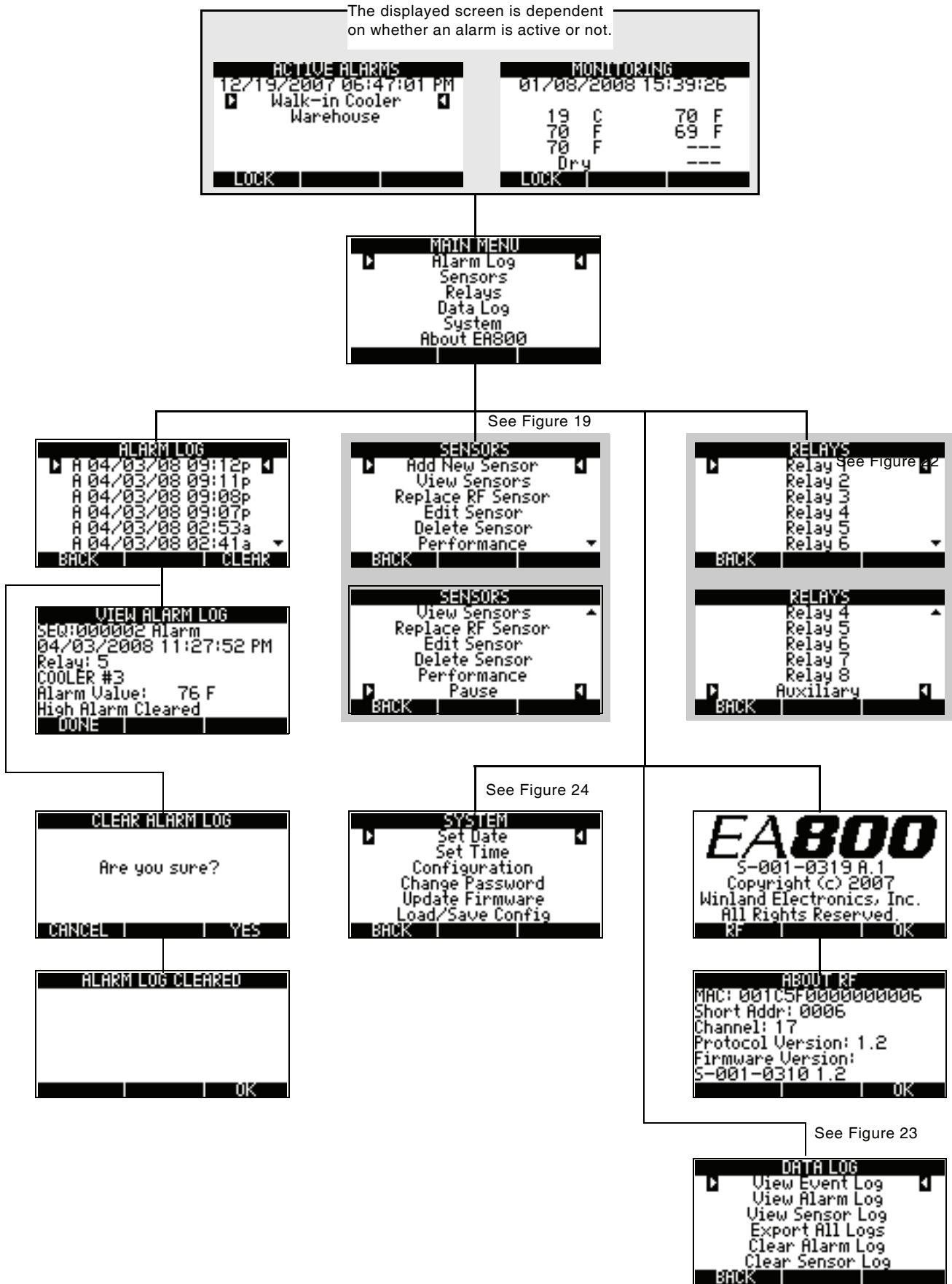
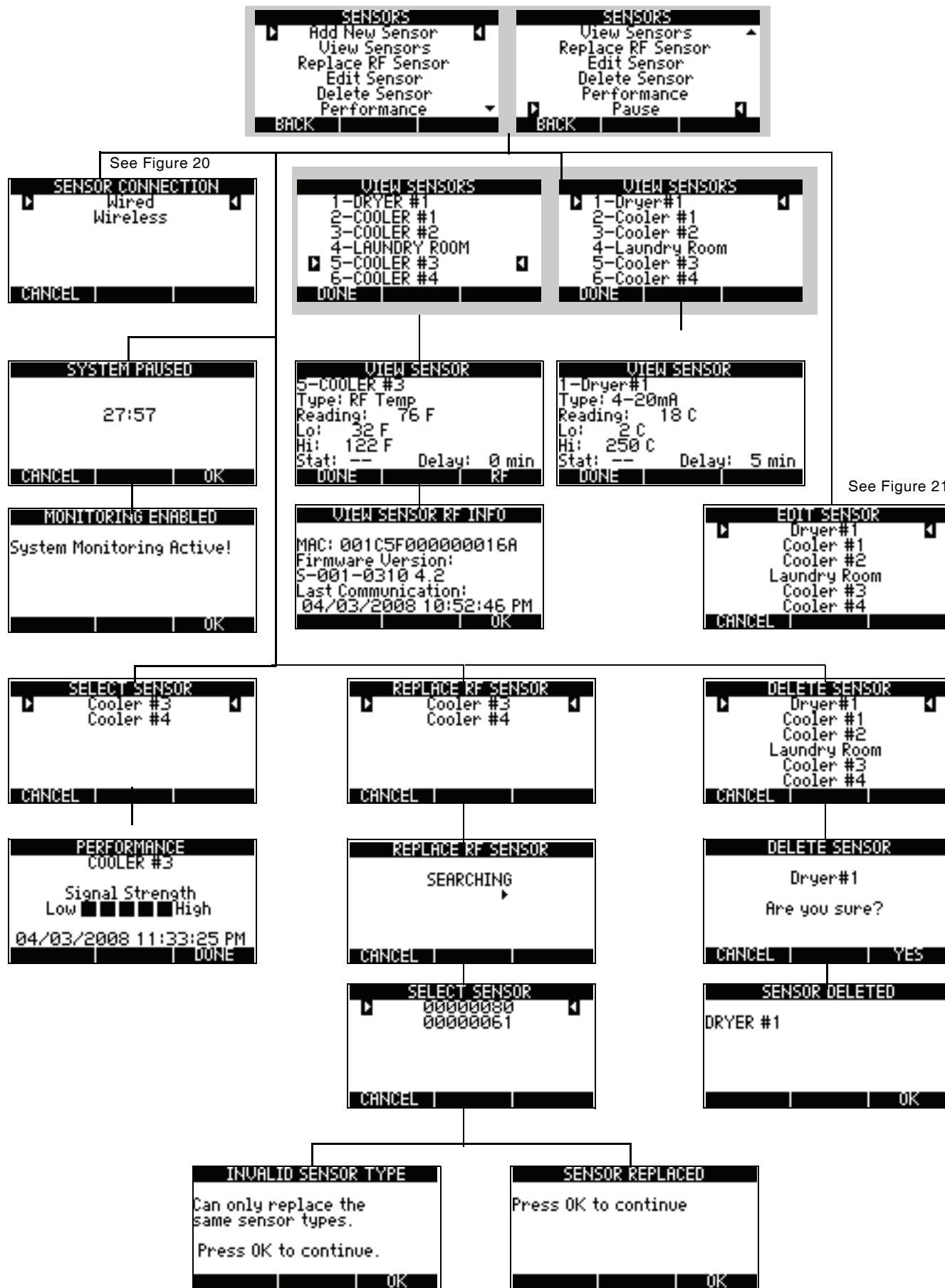

Figure 18. Unlocked Screen Map - Top Level



See Figure 20

See Figure 21

Figure 19. Sensors Screen Map

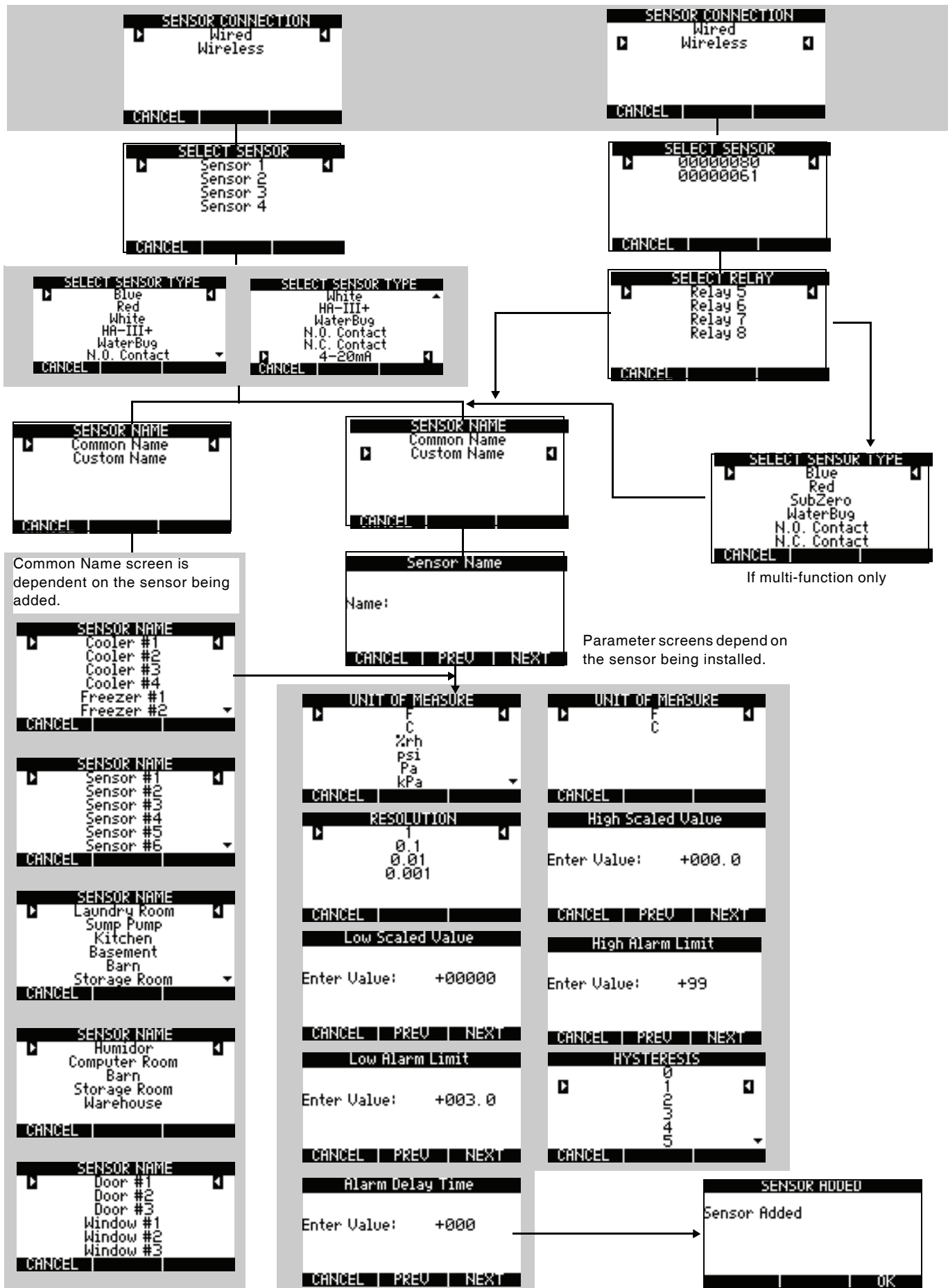
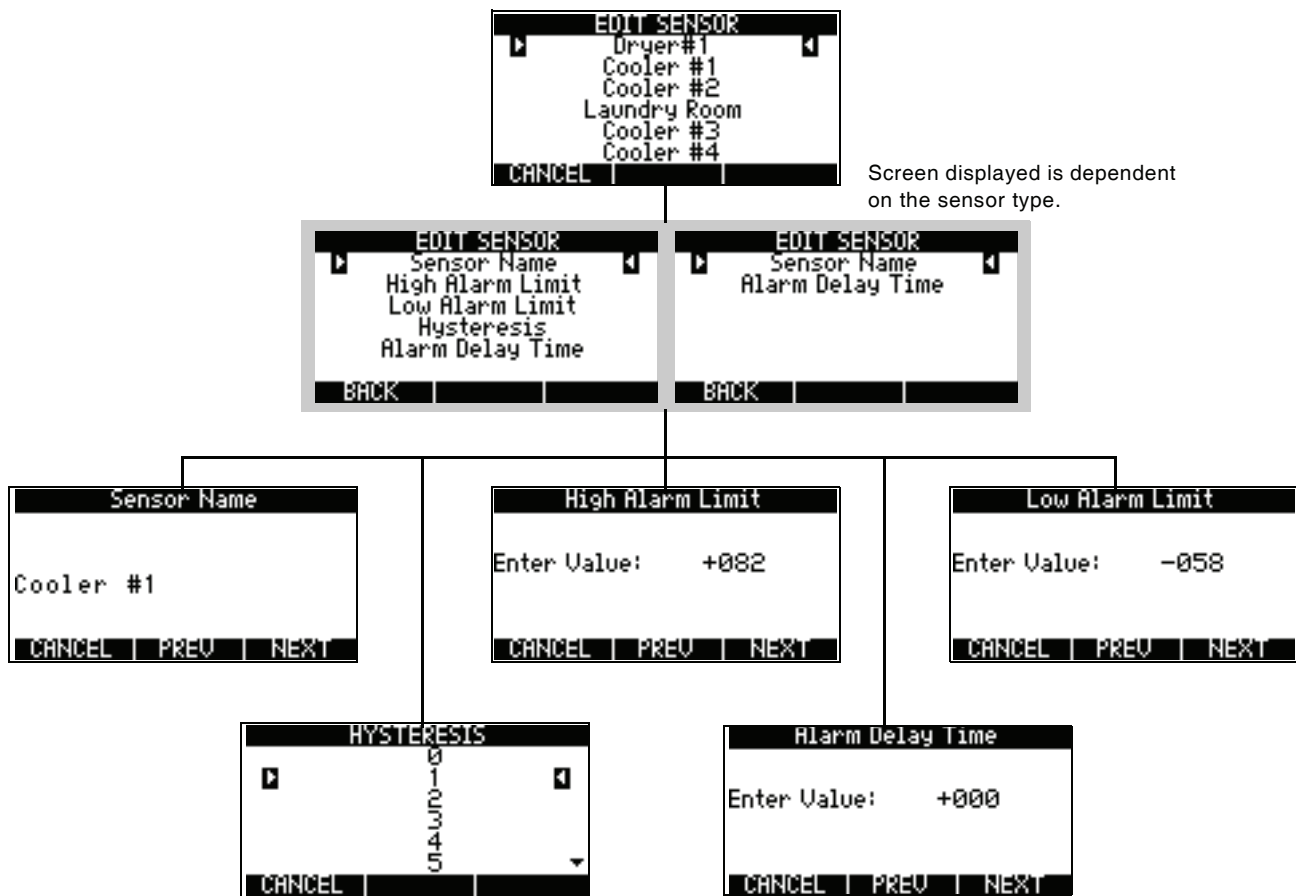

Figure 20. Add New Sensor Screen Map



Screen displayed is dependent on the sensor type.

Figure 21. Edit Sensor Screen Map

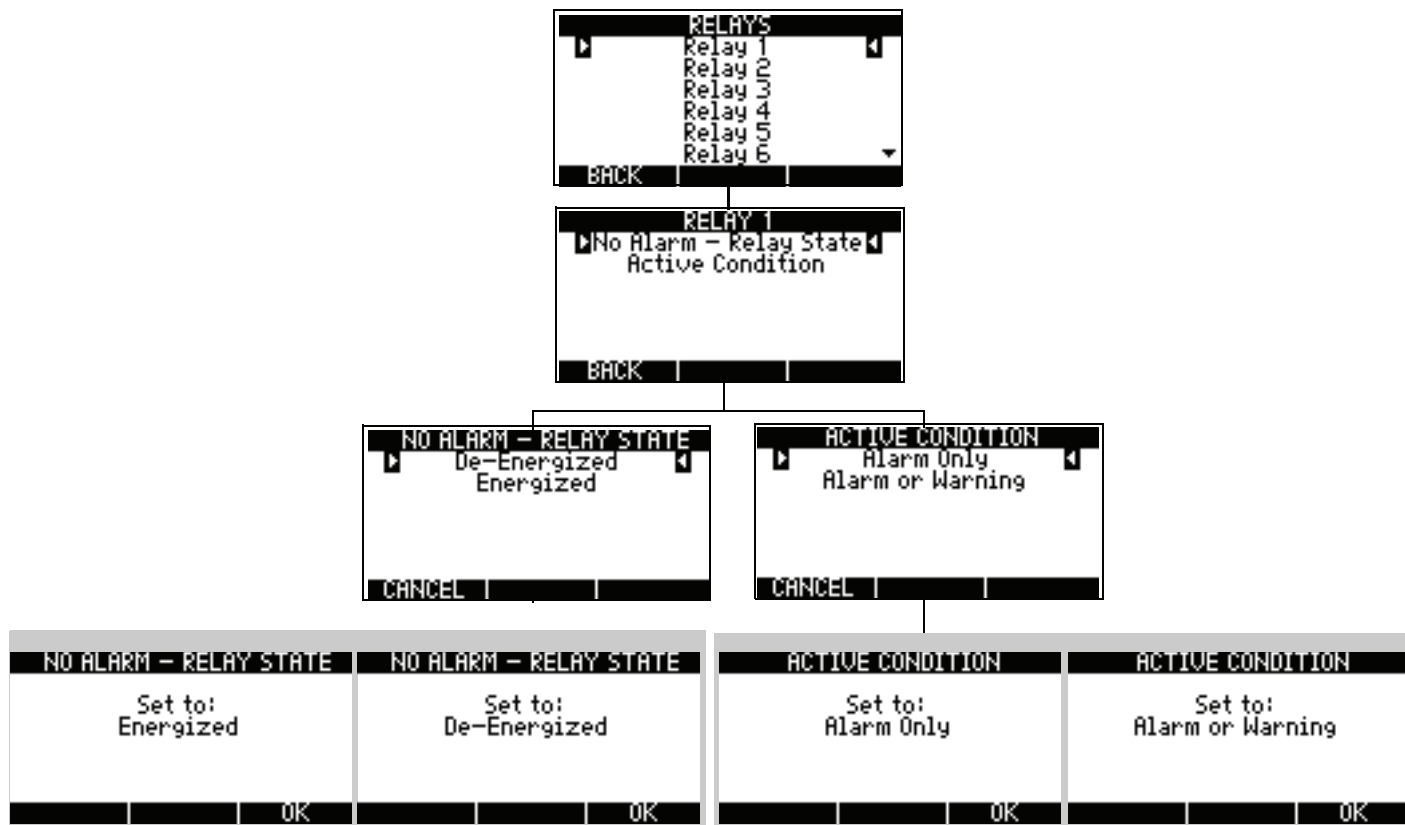

Figure 22. Relay Screen Map



Figure 23. Data Log Screen Map

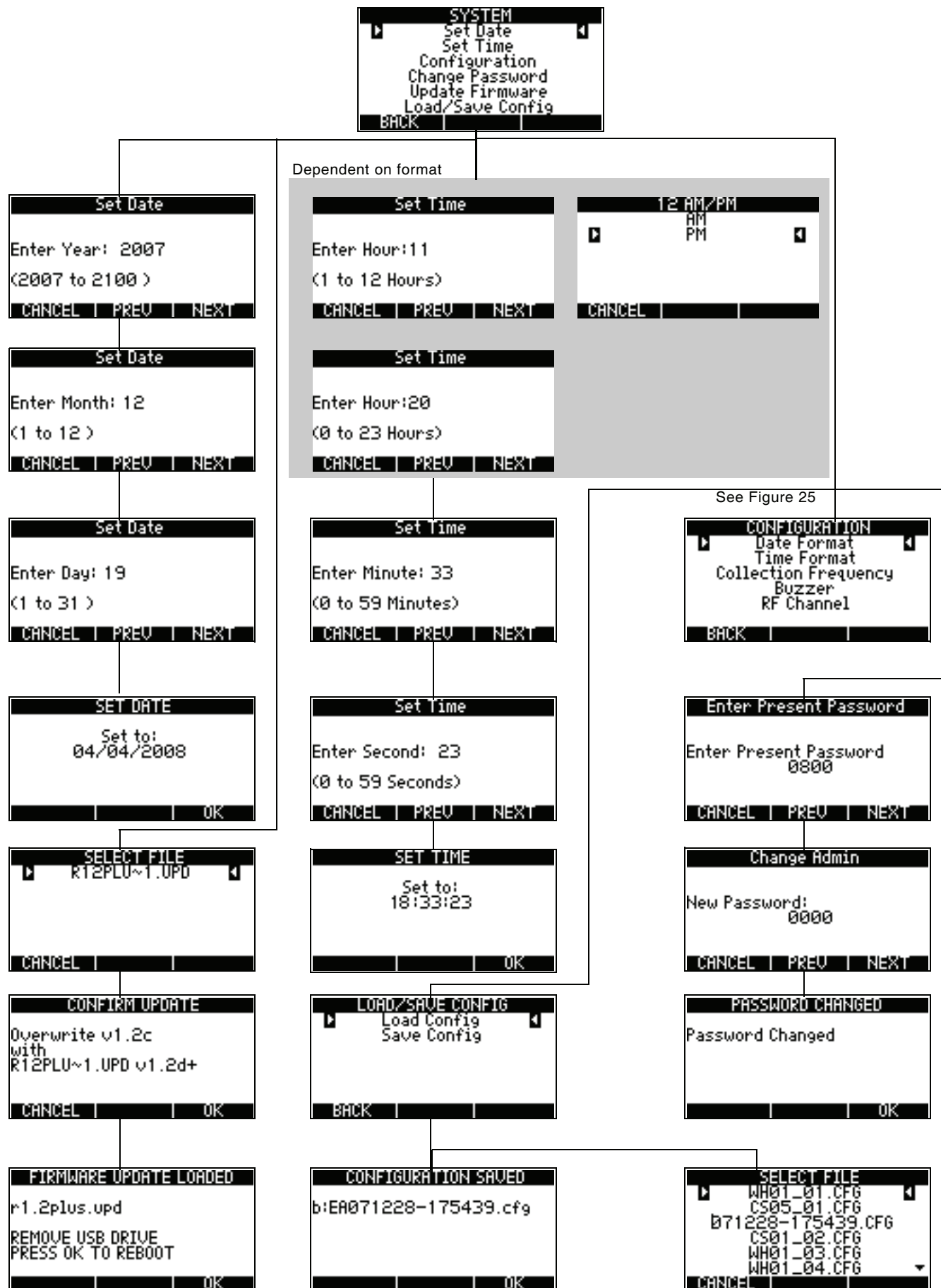

Figure 24. System Screen Map

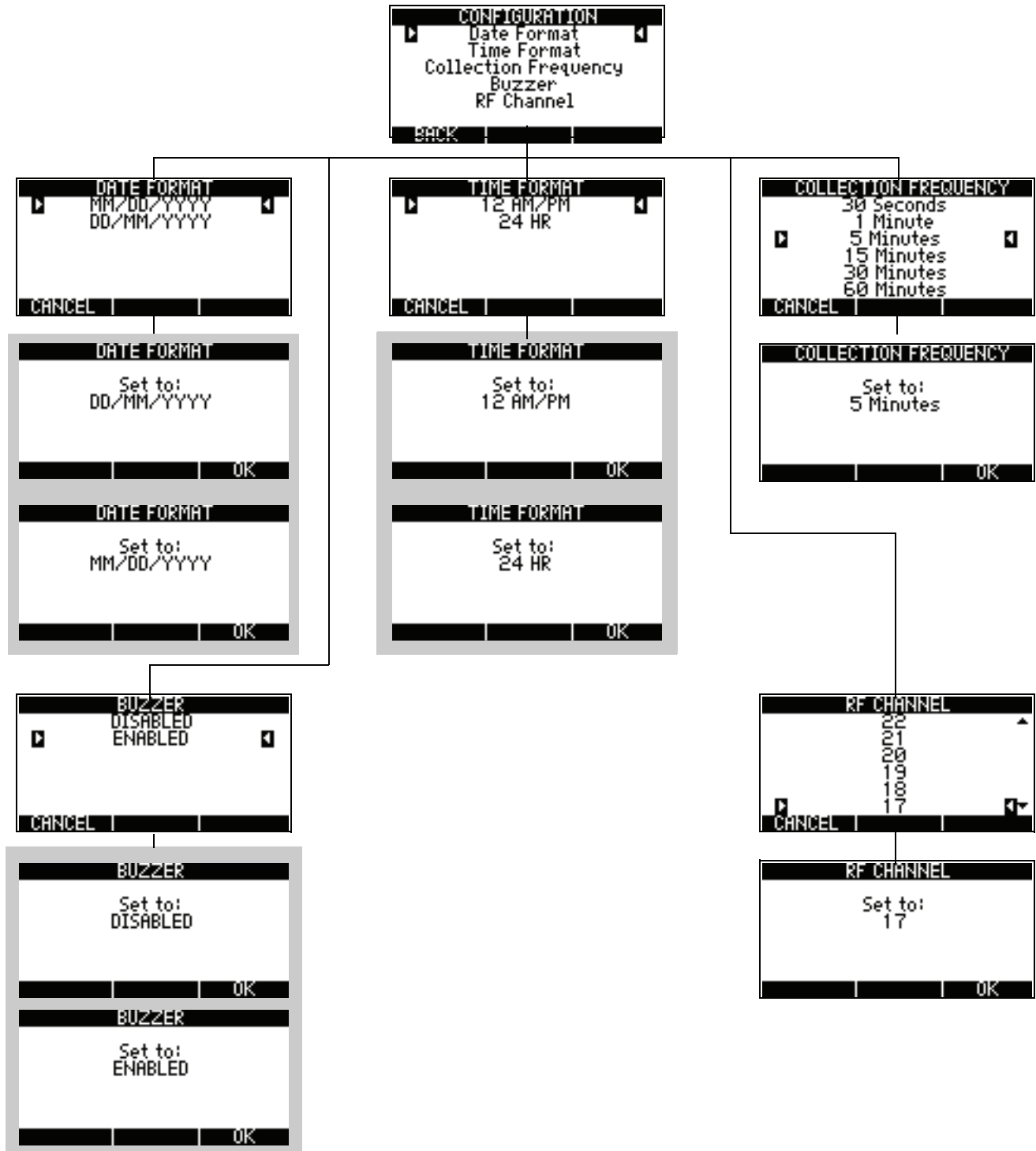
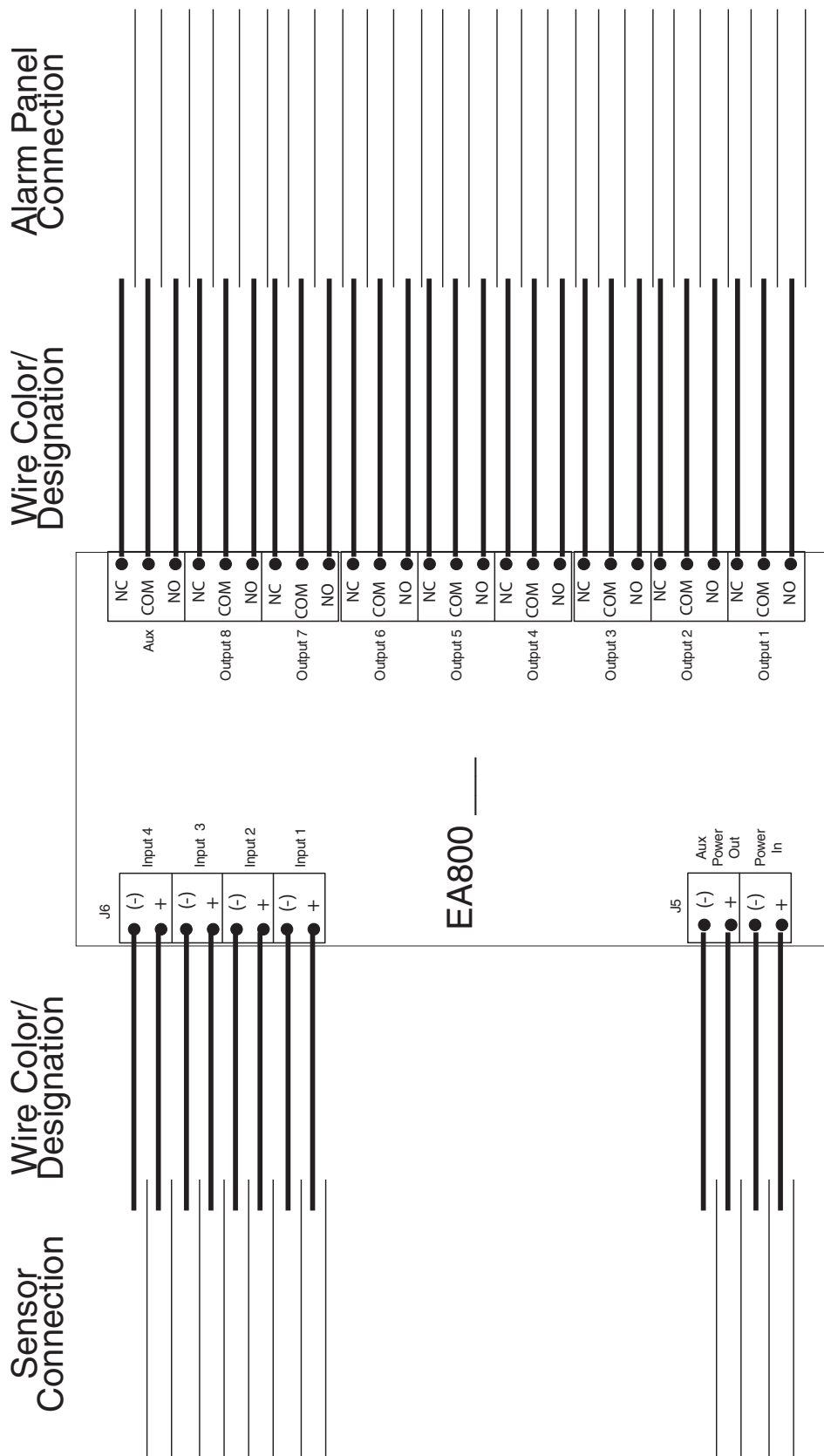

Figure 25. Configuration Screen Map

Appendix C: Wiring Diagram

Note: Photocopy and complete copy of this diagram for each EA800 to be installed in the system.



Appendix D: System Configuration Record

Note: Photocopy this appendix and complete a copy for each EA800 base unit in the system.

EA800 Environmental Alarm System Configuration Form

Date of installation/change:			
Name of Installation Company:			
Phone number:			
Name of installer (print):			
EA800 identifier:			
System Configuration (circle setting)			
Date Format: MM/DD/YYYY or DD/MM/YYYY		Collection Frequency: 30s, 1min, 5 min, 15 min, 30 min, 60 min	
Time Format: 12 hour or 24 hour		Channel: 11, 12, 13, 14, 15, 16, 17, 18, 19, 20, 21, 22, 23, 24, 25, 26	
Buzzer: Enabled or Disabled			
Sensor 1 Settings			
Sensor Model	Sensor Name	Physical Location	Parameter Settings
			Unit of Measure:
Operational Parameters:			Resolution:
			Low Scaled Value:
			High Scaled Value:
			Hysteresis:
			Low Alarm Limit
			High Alarm Limit:
			Alarm Delay Time:
			No Alarm - Relay State:
Notes:			Active Condition:

EA800 Environmental Alarm System Configuration Form

Sensor 2 Settings			
Sensor Model	Sensor Name	Physical Location	Parameter Settings
			Unit of Measure:
Operational Parameters:			Resolution:
			Low Scaled Value:
			High Scaled Value:
			Hysteresis:
			Low Alarm Limit
			High Alarm Limit:
			Alarm Delay Time:
			No Alarm - Relay State:
			Active Condition:
Notes:			
Sensor 3 Settings			
Sensor Model	Sensor Name	Physical Location	Parameter Setting
			Unit of Measure:
Operational Parameters:			Resolution:
			Low Scaled Value:
			High Scaled Value:
			Hysteresis:
			Low Alarm Limit
			High Alarm Limit:
			Alarm Delay Time:
			No Alarm - Relay State:
			Active Condition:
Notes:			

EA800 Environmental Alarm System Configuration Form

Sensor 4 Settings			
Sensor Model	Sensor Name	Physical Location	Parameter Settings
			Unit of Measure:
Operational Parameters: Notes:			Resolution:
			Low Scaled Value:
			High Scaled Value:
			Hysteresis:
			Low Alarm Limit
			High Alarm Limit:
			Alarm Delay Time:
			No Alarm - Relay State:
			Active Condition:
Sensor 5 Settings (wireless)			
Sensor Model	Sensor Name	Physical Location	Parameter Settings
			Unit of Measure:
Operational Parameters: Installed LQI (in bars): MAC Address: Notes:			Resolution:
			Low Scaled Value:
			High Scaled Value:
			Hysteresis:
			Low Alarm Limit
			High Alarm Limit:
			Alarm Delay Time:
			No Alarm - Relay State:
			Active Condition:

EA800 Environmental Alarm System Configuration Form

Sensor 6 Settings (wireless)			
Sensor Model	Sensor Name	Physical Location	Parameter Settings
			Unit of Measure:
Operational Parameters: Installed LQI (in bars): MAC Address: Notes:			Resolution:
			Low Scaled Value:
			High Scaled Value:
			Hysteresis:
			Low Alarm Limit
			High Alarm Limit:
			Alarm Delay Time:
			No Alarm - Relay State:
			Active Condition:
Sensor 7 Settings (wireless)			
Sensor Model	Sensor Name	Physical Location	Parameter Settings
			Unit of Measure:
Operational Parameters: Installed LQI (in bars): MAC Address: Notes:			Resolution:
			Low Scaled Value:
			High Scaled Value:
			Hysteresis:
			Low Alarm Limit
			High Alarm Limit:
			Alarm Delay Time:
			No Alarm - Relay State:
			Active Condition:
Sensor 8 Settings (wireless)			

EA800 Environmental Alarm System Configuration Form

Sensor Model	Sensor Name	Physical Location	Parameter Settings
			Unit of Measure:
Operational Parameters: Installed LQI (in bars): MAC Address: Notes:			Resolution:
			Low Scaled Value:
			High Scaled Value:
			Hysteresis:
			Low Alarm Limit
			High Alarm Limit:
			Alarm Delay Time:
			No Alarm - Relay State:
			Active Condition:

Warranty and Service Information

Winland Electronics, Inc. ("Winland") warrants to the end user/purchaser that each product of its manufacture shall be free from defects in material and factory workmanship for a period of two (2) years from the date of purchase, when properly installed and operated under normal conditions according to Winland's instruction.

Winland's obligation under this warranty is limited to correcting, without charge, at its factory any part or parts thereof which shall be returned to the factory, by the original purchaser, transportation charges prepaid, within one year of the date of purchase and which upon examination, shall disclose to Winland's satisfaction to have been originally defective. Correction of such defects by repair to, or supplying replacements for, defective parts shall constitute fulfillment of all Winland's obligations to purchaser under this limited warranty. Repair service performed by Winland after one year from date of purchase will be for a reasonable service charge.

This limited warranty shall not apply to any of Winland's products which have been subject to misuse, negligence or accident or which have been repaired or altered outside of Winland's factory.

Winland shall not be liable for loss, damage or expense resulting, directly or indirectly, from the use of its products or any other cause.

THIS WARRANTY IS IN LIEU OF ALL OTHER WARRANTIES, EXPRESS OR IMPLIED, INCLUDING, WITHOUT LIMITATION, ANY WARRANTIES OF MERCHANTABILITY, FITNESS FOR PARTICULAR PURPOSES, NON-INFRINGEMENT AND TITLE, AND ANY WARRANTIES ARISING FROM COURSE OF DEALING, USAGE OF TRADE OR OTHERWISE. ALL OTHER REPRESENTATIONS MADE TO THE END USER/PURCHASER BY ANY OTHER PARTY ARE ALSO EXCLUDED.

WINLAND SHALL NOT BE LIABLE TO ANY PERSON FOR INDIRECT, SPECIAL, INCIDENTAL OR CONSEQUENTIAL DAMAGES OF ANY DESCRIPTION, WHETHER ARISING OUT OF WARRANTY OR OTHER CONTRACT, NEGLIGENCE OR OTHER TORT, OR OTHERWISE. Under no circumstances shall Winland's liability under this limited warranty exceed the purchase price paid by the end user/purchaser for the product.

No person, agent or dealer is authorized to give warranties on behalf of Winland nor to assume for Winland any other liability in connection with any of its products.

Duplication or distribution of this manual and any information contained within is strictly prohibited without the express written permission of Winland Electronics, Inc. To order additional copies of this manual, or other related manuals, contact Winland Electronics Customer Service at 1-800-635-4269.

The information in this document has been carefully examined and is believed to be entirely reliable. However, no responsibility is assumed for inaccuracies.

EnviroAlert, and the **Winland logo**, are trademarks of Winland Electronics, Inc. in the U.S. Other product names and trademarks appearing in this manual are the property of their respective owners.



WINLAND
ELECTRONICS, INC.

Manufactured in the U.S.A by
Winland Electronics
1950 Excel Drive, Mankato, MN, 56001
Outside MN Phone: 1-800-635-4269
Phone: 507-625-7231
Fax: 507-387-2488
©Winland Electronics, Inc. 2008
www.winland.com
D-011-0152 Rev. A