

PictureMate®  
personal photo lab *Dash*



PM 260

PictureMate®  
personal photo lab *Zoom*



PM 290

**Basics**

# Contents

Welcome! .....	2
Prepare to Print .....	6
Choose Photos and Print .....	9
Do More With Your Photos .....	15
Save Photos to a CD .....	25
Print From an External Device .....	28
Print From a Computer .....	34
Replace Print Pack .....	49
Take PictureMate With You .....	53
Set PictureMate Preferences .....	56
Printer Care and Troubleshooting .....	60
Notices .....	69
Index .....	79

# Welcome!

PictureMate Dash™ and PictureMate Zoom™ are your easy-to-use, personal photo labs. Just insert a digital camera memory card and you're ready to print brilliant, long-lasting photos. Because PictureMate® is light and portable, you can print whenever and wherever you take pictures. Plus, your PictureMate prints will be as brilliant and vibrant generations from now as they are today.

## ***A Quick Introduction to Digital Photography***

With film cameras, the process was simple; buy film, take pictures, leave the film at the photo lab, and come back later for your photos and negatives. Since you had negatives, you could take them back later if you wanted reprints.

The digital process is simple too, and it gives you complete control. Just follow the basic steps shown on the right.



### **1. Review and Delete**

After you finish taking your photos, review them on your digital camera's screen. Delete the photos you don't want.



### **2. Print**

Insert your camera's memory card in PictureMate, choose your photos, and print.



### **3. Save**

To preserve your digital photo files (just like film negatives), save them to a CD, flash drive, or your computer. Then you can reprint them any time. (On PictureMate Zoom, you can use the built-in CD burner.)

### **4. Clear the Memory Card**

After you save your photos, use your camera to delete them from your card to make room for more photos.

## Special Features

Printing with your PictureMate becomes even easier with these special features:



From PictureMate's photo viewer screen, you can view your photos and press  **Print** to print the ones you want. Or you can select to print all photos. (See page 9.)

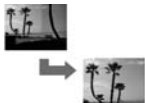

You can crop photos right from PictureMate—no computer required. (See page 16.)



If your camera supports DPOF (Digital Print Order Format), you can select which photos to print while the memory card is still in your camera. When you insert the card into PictureMate, you just have to press **OK** and  **Print**. (See page 13.)



If you have a PictBridge®- or USB DP (USB Direct Print)-enabled camera, you can connect the camera to PictureMate and control printing right from your camera. (See page 28.)



If you want to print outdoors or in other places without convenient electrical outlets, you can buy the optional PictureMate battery. (See page 54.)



If you have a Bluetooth®-enabled PDA, cell phone, or computer, you can send photos wirelessly to PictureMate for printing using the optional Epson® Bluetooth Photo Print Adapter. (See page 30.)

## Supported Photo Formats

Make sure your photos meet these requirements for printing with your PictureMate (without a computer):

- JPEG files or uncompressed TIFF files only
- Resolutions ranging from 80 × 80 to 9200 × 9200 pixels

PictureMate recognizes and prints the first 999 photos on your memory card.

## Where to Find Information

Your manuals cover both PictureMate Dash and Zoom.



See your **Start Here** sheet to unpack, set up, and use your PictureMate.



**Basics** (this book) explains how to print photos directly from your memory card, from your computer, and from other devices, replace the Print Pack, and solve problems.



The on-screen **User's Guide** installed from the CD has detailed instructions for using PictureMate.

## Where to Get a Print Pack and Accessories



The PictureMate 200 Series Print Pack has everything you need to print in one box: photo paper and a photo cartridge.

You can buy a Print Pack wherever PictureMate is sold or from retailers that sell printer supplies.

The following Print Packs are available:

Print Pack contents	Part number	Supported PictureMate models
Glossy photo paper (150 sheets) and photo cartridge	T5846	All PictureMate 200 Series models
Matte photo paper (100 sheets) and photo cartridge	T5845-M	

You can also buy a Print Pack and other PictureMate accessories from an Epson authorized reseller. To find the nearest reseller, call 800-GO-EPSON (800-463-7766). Or you can purchase online at [www.epsonstore.com](http://www.epsonstore.com) (U.S. sales) or [www.epson.ca](http://www.epson.ca) (Canadian sales).

## PictureMate Buttons

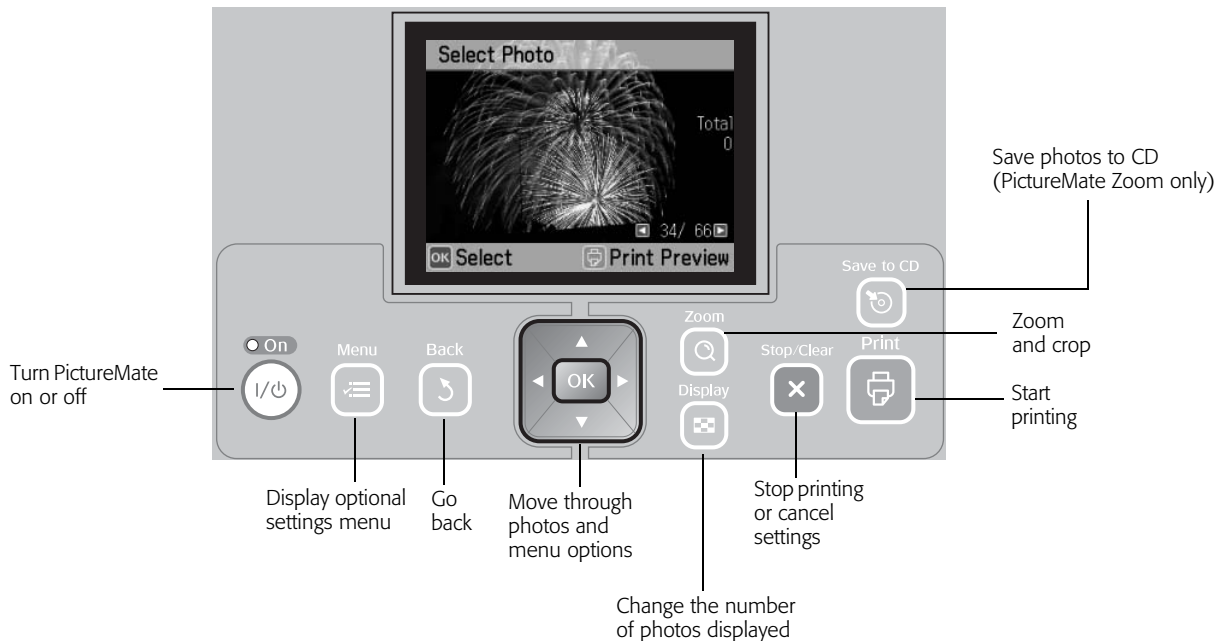

## Prepare to Print

Before you print with PictureMate, you need to do:

- Load paper (below)
- Insert your memory card (see page 7)

When you finish printing, you can remove your memory card (see page 8).

Note: The illustrations in this manual show PictureMate Dash, but the instructions cover both PictureMate Dash and PictureMate Zoom, except where noted.

### ***Loading Paper***

Caution: Don't load plain paper; this may damage PictureMate.

- 1** Move the handle to the back.

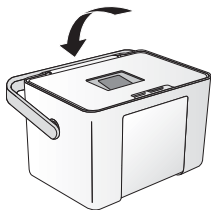

- 2** Open the paper support.

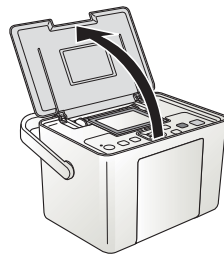

- 3** Press the corner of the output tray to open it.

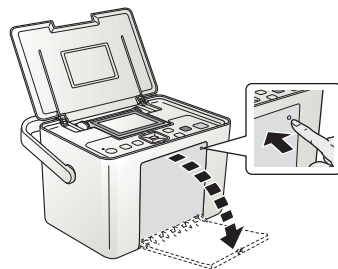

- 4** Slide the edge guides outward.

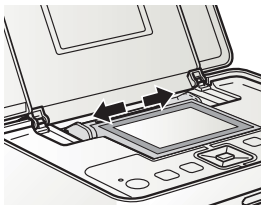

- 5** Create a stack of up to 20 sheets of paper and separate the sheets slightly by fanning them.
- 6** Place your paper into the slot between the edge guides with the glossy or whiter side up. Slide the edge guides inward slightly.

Load glossy or whiter side up

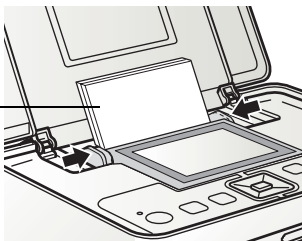

Note: Load a maximum of 20 sheets at a time. Load your paper glossy or whiter side up to prevent smearing.

- 7** Store any unused paper in the original package and keep it flat in a dry area to prevent curling.

Note: When you need more paper, order a PictureMate 200 Series Print Pack. See page 49 for more information.

## ***Inserting Your Memory Card***

- 1** Press the I/⏻ **On** button to turn on PictureMate.
- 2** Press the corner of the output tray to open it, if necessary.
- 3** Insert the memory card into the correct slot, as shown on the next page. Insert just one card at a time.

Note: PictureMate can't read multiple cards at once.

- 4** Push the card in carefully until it stops (it won't go in all the way).

**When the card is in, the memory card light comes on and begins to flash.**

Caution: Do not remove a card while the memory card light is flashing; you may lose photos on your card.



## Top slot:



SD™ (Secure Digital) and SDHC™ (High Capacity)  
miniSD™ \* and miniSDHC \*  
microSD \* and microSDHC \*  
MMC™ (MultiMediaCard™)  
xD-Picture Card™  
xD-Picture Card (Type M and Type H)  
Sony Memory Stick® \*\*  
Memory Stick Duo™ \*  
Memory Stick Micro\*  
Memory Stick PRO™  
Memory Stick PRO Duo™ \*  
MagicGate™ Memory Stick \*\*  
MagicGate Memory Stick Duo™ \*

## Bottom slot:



Microdrive™  
CompactFlash® (Type I and II)

\*Requires adapter  
\*\*Maximum capacity 128MB

Now you are ready to choose your photos and start printing. (See page 9.)

## Removing Your Memory Card

When you are ready to remove a memory card, first make sure the memory card light is not flashing.

Caution: Do not remove a card while the memory card light is flashing; you may lose photos on your card.

**Top slot:** Push in the card and release it, then pull it straight out of the slot.



**Bottom slot:** Push in and release the card release button so it pops out. Then push in the button again to eject your card and pull it straight out of the slot.

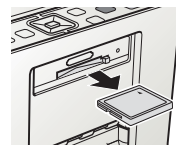

## Choose Photos and Print

After you insert your camera's memory card, PictureMate displays your photos on the photo viewer screen (shown at right).

Note: You can adjust the angle of the photo viewer screen by raising or lowering the top of the screen. Be sure to lower the screen before closing the printer lid.

You can view your photos and choose from the following options for printing them:

- Print individual photos on your card (see page 10)
- Print all the photos on your card (see page 11)
- Print photos taken on specific dates (see page 12)

If your camera supports DPOF (Digital Print Order Format), you can use it to pre-select the photos and copies you want to print. PictureMate then prints the selected photos. (See page 13.)

To view a slideshow of your photos, see page 13.

To store and display your printed photos, see page 14.

## Viewing Photos on PictureMate

PictureMate's photo viewer screen makes it easy to select the photos you want to print.

Blue lines indicate the area that will print

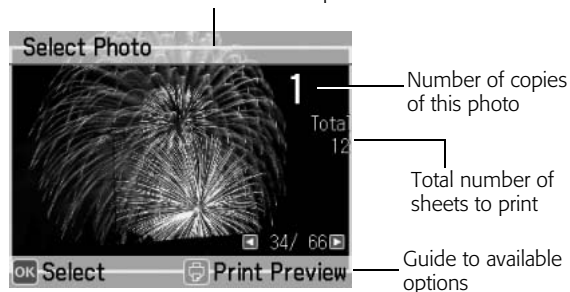

## Changing How Many Photos Display on the Screen

After inserting a memory card, you can change how many photos are displayed on the photo viewer screen.

Press the **Display** button to switch between one photo displayed with or without text, one photo with a “filmstrip” of 5 additional photos, or 16 photos, as shown:



1 photo



1 photo, full screen

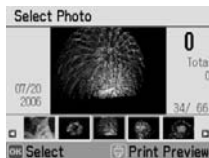
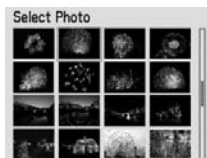

Photo with “filmstrip”



16 photos

## Responding to a Blank Screen (Power Saver)

If you are not using PictureMate, the screen goes dark after about 13 minutes to save power.

Press any button to turn it back on.

## Printing Individual Photos

You can use the photo viewer screen to select the pictures you want to print.

- 1 After inserting a memory card, press ◀ or ▶ to view your photos.
- 2 When you see a photo you want, press **OK** to select it for printing.

You see the number 1 on the photo, indicating that one copy will be printed:

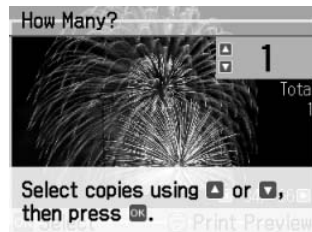

Note: If you want to change the layout or edit your photo, press **Menu**. See page 15 for instructions.

- 3 To print more than one copy, press ▲ to increase the number of copies or ▼ to decrease it. Then press **OK**.

- 4 To select more photos, press ◀ or ▶ to view a photo and press **OK** to select it. Repeat step 3 to select more copies, if necessary.
- 5 To preview your photos, press  **Print**.

The preview screen shows the layout, cropping, and other settings you have chosen, for example:

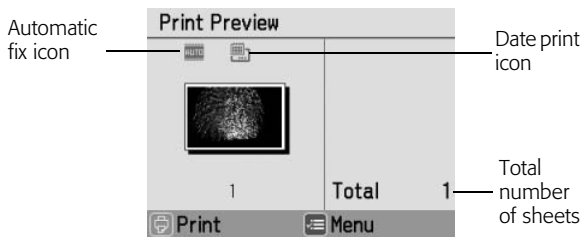

Note: For more information about print settings, see page 15.

- 6 Press ◀ or ▶ to review your selected photos. If you change your mind, press the ↶ **Back** button.
- 7 Make sure you have enough paper loaded, then press  **Print** to start printing.

Tip: You can check the total number of sheets on the screen before printing.

## Printing All Photos

You can print all the photos on your camera's memory card, and select the number of copies to print of each photo.

- 1 After inserting a card, press  **Menu**.

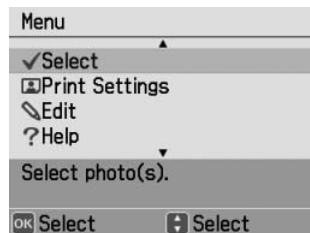

- 2 Press **OK** to choose **Select**, then press **OK** again to choose **Select All**.
- 3 If you want more than one copy of each picture, press ▲ to increase the number of copies. Press ▼ to decrease it.
- 4 To preview your photos, press  **Print**.
- 5 Press ◀ or ▶ to review your selected photos. If you change your mind, press ↶ **Back**.

**6** If you want to change the layout or edit your photos, press  **Menu**. See page 15 for instructions.

**7** Make sure you have enough paper loaded, then press  **Print** to start printing.

Note: If you are printing more than 20 photos, you will need to reload paper while printing. Load a maximum of 20 sheets at a time. When you see a message that paper is out, load more paper and press **OK** to continue printing. If you need to cancel printing, press **X Stop/Clear**.

## ***Printing Photos by Date***

You can print photos taken on specific dates. If you have a lot of photos on your memory card, this makes it easier to find the ones you want.

- 1** After inserting a card, press  **Menu**.
- 2** Press **OK** to choose **Select**.
- 3** Press **▲** or **▼** to highlight **Select By Date**, then press **OK**.

You see a list of dates.

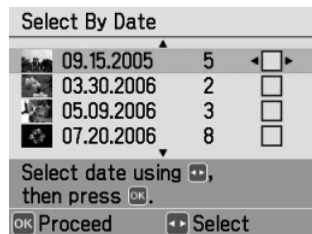

**4** Press **▲** or **▼** to highlight the date you want, then press **◀** or **▶** to select it.

A checkmark appears in the box for the selected date. You can select additional dates, if desired.

**5** After selecting all the dates you want, press **OK**.

The photos taken on the selected date(s) appear on the screen.

**6** Press **◀** or **▶** to view the selected photos.

**7** Follow the steps on page 10 to select photos, set the number of copies for each, and print.

## Printing Camera-Selected DPOF Photos

If your camera supports DPOF (Digital Print Order Format), you can use it to pre-select which photos and how many copies you want to print.

See your camera's manual to choose photos for printing with DPOF, then insert your memory card in PictureMate.

PictureMate automatically reads your pre-selected photos and displays this message:

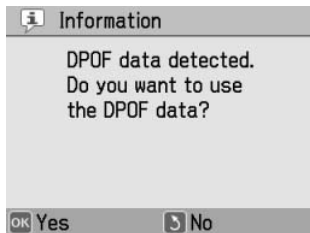

- 1 Press **OK** to confirm.
- 2 If you want to change any print settings from the defaults, press **Menu**. See page 15 for instructions.

- 3 Make sure you have enough paper loaded, then press **Print**.

## Viewing a Slideshow of Your Photos

You can have PictureMate display all the photos on your memory card one by one.

- 1 After inserting a card, press **Menu**.
- 2 Press **▲** or **▼** to highlight **Setup**, then press **OK**.
- 3 Press **OK** to select **Slide Show**. After a few moments, the slideshow begins.

PictureMate displays all the photos on your memory card as a continuously playing slide show.

- To stop the show at any time, press **Back** or **Stop/Clear**.
- If you see a photo you want to print, press **OK** to select it for printing.

## ***Storing and Displaying Your PictureMate Photos***

Photos printed on PictureMate photo paper are beautiful and long-lasting. Follow these guidelines to make sure they will look great for generations.

### **Caring for Your Photos**

- To avoid scratches or smudging, do not rub the printed side of the photo.
- To prevent smudging, avoid stacking your photos until they are completely dry.
- Let photos sit for 24 hours before framing.
- After you print, the colors on your photos will take some time to set as the ink dries. During this time, the colors may look different than you expect.

### **Displaying Your Photos**

- To ensure photos will last as long as possible, display them under glass or in photo albums.
- Keep photos out of the sun to help prevent fading.

### **Storing Unused Paper**

Return unused paper to the original package. Store paper flat to prevent curling, and keep it away from extreme temperatures, high humidity, and bright light.

## Do More With Your Photos

By pressing the  **Zoom** button, you can crop and enlarge a section of your photo (see page 16).









By pressing the  **Menu** button, you can:

- Choose from a variety of layouts (see page 17)
- Remove red eyes from your photos (see page 18)
- Fix photos that are too light or dark (see page 19)
- Add a date stamp to your photos (see page 21)
- Adjust the amount of expansion and cropping for borderless printing (see page 21)
- Print in black-and-white or sepia (see page 22)
- Add fun and festive decorations to your photos (see page 23)
- Print camera text (see page 24)
- Rotate your photos on the screen (see page 24)

Note: The features described in this section do not change or replace the original digital photo file; they customize only the print(s) you make at that time.

## Getting Help

You can learn how to improve print quality or handle memory cards, paper, or photo cartridges.

- 1** Press  **Menu**.
- 2** Press  or  to highlight **Setup**, then press **OK**.
- 3** Press  or  to highlight **Help**, then press **OK**.
- 4** Press  or  to highlight **Improve print quality** or **Quick Guide**, then press **OK**.
- 5** Press  or  to highlight the topic you need help with. Then press **OK** to see the solution for improving print quality, or a Quick Guide animation.



## Zooming and Cropping

You can print just part of a photo, cropping out the area that you don't want. The part you keep is automatically enlarged to fit the layout.

Cropping affects only your printed photo, not your original image.

- 1 Select the photo you want to crop.
- 2 Press the **Zoom** button. You see your photo with a list of options on the bottom of the screen.



- 3 Set the area you want to print:
  - Press **Zoom** to enlarge your photo up to 5 times.
  - Press **◀**, **▶**, **▲**, or **▼** to move the view to a different part of your photo.
  - Press **☰** **Menu** to rotate your photo.
- 4 Press **OK**. You see a question asking if you want to print the photo as shown on the screen.
- 5 Press **OK** to agree. You see your enlarged and cropped photo.





- 6 Follow the instructions on page 11 to set the number of copies, preview your photo, and start printing.



The **Zoom** icon appears on the preview screen to remind you that your photo is cropped.





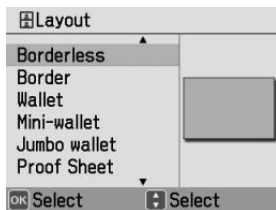













## Choosing a Layout

By default, your photos are printed at the full 4 × 6 size, without borders. If you want to print pictures with white borders or place several small photos on one sheet of paper, you can use the Layout menu to change the layout.

- 1 After inserting a card, press  **Menu**.
- 2 Press  or  to highlight **Print Settings**, then press **OK**.
- 3 Press **OK** to select **Layout**.



- 4 Press  or  to highlight the layout setting you want, then press **OK**. You have these choices:

- |   |   |
|---|---|
|  Borderless  |  Border  |
|  Wallet  |  Mini-wallet   |
|  Jumbo Wallet  |  Proof Sheet (20 photos per sheet)                         |
|  Portrait Pkg. (4)<br>(4 copies of each photo per sheet) |  Portrait Pkg. (10)<br>(10 copies of each photo per sheet) |
|  US Passport<br>(2 copies of each photo per sheet)       |  Digital Size<br>(4:3 aspect ratio)                        |
|  CD Index<br>(56 photos)                                 |  3 × 3 in Photo  |
|  6/Pg. Small   |  6/Pg. Medium  |
|  6/Pg. Large<br>(square photos)                          |  12/Pg. Medium   |
|  12/Pg. Large<br>(square photos)                         |  50mmx70mm   |

Note: Your photos will be cropped to fit in some layouts. For the fastest printing, select **Border**.

When you print without borders, your images are automatically expanded and cropped around the edges. This may cause part of your image to be cut off. You can control the amount of expansion and cropping; see page 21 for instructions.

- 5 At the photo selection screen, press **OK** to select the current photo for printing. (See page 10.)

For the Portrait Packages and US Passport, PictureMate prints multiple copies of each photo per sheet. For other layouts, to print two or more photos per sheet, select multiple copies or multiple photos.

For example, if you want 3 mini-wallet photos of one image and 4 of another, select 3 copies of photo A and 4 copies of photo B. Then choose **Mini-wallet** as the layout setting.

Your photos will be printed on 2 sheets of paper as shown:



- 6 Press ◀ or ▶ to select additional photos if you want.

- 7 Adjust any other settings you want, then press  **Print** to preview your photos.

- 8 If the layout preview is correct, press  **Print** to start printing.

## Reducing Red-Eye

When you take photos of people, they sometimes appear to have red eyes. You can use red-eye reduction to help eliminate this problem.

Note: Red-eye reduction may not correct red eyes in all photos, and printing will be slower when you use this feature.

- 1 Select a photo with the red-eye problem.
- 2 Press  **Menu**.
- 3 Press ▲ or ▼ to highlight **Edit**, then press **OK**.
- 4 Press ▲ or ▼ to highlight **Red-Eye**, then press **OK**.
- 5 Press ▲ or ▼ to highlight **On**, then press **OK**.
- 6 Select whether to apply the setting to the current photo or all photos, then press **OK**.

When you press  **Print**, you see an icon on the preview screen to remind you about the setting.

## Fixing Photos

PictureMate lets you correct the color and improve the image quality of your photos without using a computer. Two types of adjustments are available:

- Automatic adjustments

The Enhance setting, which is selected by default, improves your photos' colors and increases contrast and sharpness. It may correct images that are too dark, too light, or backlit.

You can select the following types of enhancement: Standard, People, Landscape, or Night scene.

If your camera supports PRINT Image Matching® (P.I.M.) or Exif Print, the printer's **P.I.M.** setting automatically adjusts your photos for the best results.

- Manual adjustments

If your photos are too light or too dark, you can manually adjust their brightness or control the saturation and sharpness.

If you want, you can make manual adjustments while P.I.M. or Enhance are turned on in order to fine-tune your automatic settings.

Note: These settings affect only your printed pictures. They do not change your original image files.

### Automatically Fixing Your Photos

PictureMate's automatic image adjustments are applied to all your photos in the current print job.

- 1 After inserting a card, press  **Menu**.
- 2 Press **▲** or **▼** to highlight **Print Settings**, then press **OK**.
- 3 Press **▲** or **▼** to highlight **Fix Photos**, then press **OK**.

- 4 Press ▲ or ▼ to highlight one of the following options:
- **Enhance:** This setting improves your photos' colors and increases contrast and sharpness. It may correct images that are too dark, too bright, or backlit. (**Enhance** is the default setting.)
  - **P.I.M.:** This information helps ensure an accurate image reproduction for files that include P.I.M. (PRINT Image Matching) or Exif Print data.
  - **None:** Prints photos as is or bypasses P.I.M. or Exif Print data. Select this setting for the fastest printing.
- 5 Press **OK** to apply the selected setting.

Note: The setting you select applies to all photos in the current print job.

If you select Enhance, you see a list of 4 enhance modes:

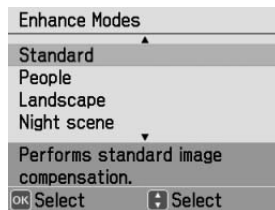

- 6 Press ▲ or ▼ to highlight the appropriate setting, then press **OK**. If you are printing a variety of photos, select **Standard**.

When you press  **Print**, you see the **AUTO** icon on the preview to remind you about the setting.

## Manually Fixing Your Photos

You can manually fix individual photos or fix all your photos at once. You can make different corrections for each photo on your memory card.

- 1 Select a photo that you want to adjust.
- 2 Press  **Menu**.
- 3 Press ▲ or ▼ to highlight **Edit**, then press **OK**.

- 4 Press ▲ or ▼ to highlight **Brightness**, **Saturation**, or **Sharpness**, then press **OK**. You see your photo next to the menu:



- 5 Press ▲ or ▼ to increase or decrease the setting. You can see the changes on your photo.
- 6 When the photo looks good, press **OK**.
- 7 At the next screen, select whether to apply the setting to the current photo or all photos, then press **OK**.
- 8 Repeat steps 2 through 7 to make other adjustments to the same photo, if necessary. Or repeat steps 1 through 7 to fix more photos.

When you press  **Print**, you see the color correction icon on the screen to remind you about the setting.

## ***Adding a Date Stamp***

You can add the date your photos were originally taken to the bottom right corner of each photo.

Note: The date comes from your camera, not from the printer. If this information is incorrect, adjust the date setting on your camera. This setting is not available for all layouts.

- 1 Press  **Menu**.
- 2 Press ▲ or ▼ to highlight **Print Settings**, then press **OK**.
- 3 Press ▲ or ▼ to highlight **Date Stamp**, then press **OK**.
- 4 Highlight **On**, then press **OK**.

The photos in your current print job are automatically date-stamped. You see the date stamp icon on the preview to remind you about the setting.

## ***Adjusting Borderless Expansion***

When you print borderless pictures, your images are automatically expanded and cropped.

If your pictures are cut off around the edges, you can adjust the amount of expansion and cropping.

- 1 Press **Menu**.
- 2 Press **▲** or **▼** to highlight **Print Settings**, then press **OK**.
- 3 Press **▲** or **▼** to highlight **Expansion**, then press **OK**. You can select **MAX**, **MID**, or **MIN**.
- 4 Press **▲** or **▼** to select **MIN** and reduce the amount of expansion. Then press **OK**. Read the warning message and press **OK**.

If you see white lines on the edges of your photos after printing with the **MIN** setting, repeat steps 1 to 3 and select **MID** or **MAX**.

## ***Printing Photos in Black-and-White or Sepia***

You can print pictures in black-and-white or in a sepia tone (like an old-fashioned photo) even when the originals are in color. Your original images are not changed.

You can apply the color effect to one photo or all photos currently selected for printing.

- 1 Select a photo or photos to print black-and-white or sepia.
- 2 Press **Menu**.
- 3 Press **▲** or **▼** to highlight **Edit**, then press **OK**.
- 4 Press **▲** or **▼** to highlight **Color Effect**, then press **OK**. You see this screen:

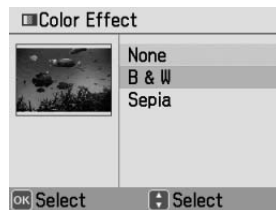











- 5 Press **▲** or **▼** to select **Black & White** or **Sepia**, then press **OK**. You can see the effect on your photo.
- 6 At the next screen, select whether to apply the color effect to the current photo or all photos, then press **OK**.

You see your photo(s) with the color effect you selected.





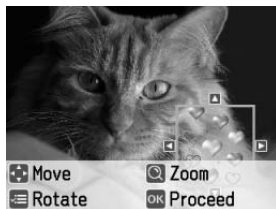

## Decorating Photos

You can add fun and festive decorations to your photos from PictureMate's built-in clipart collection. You can add up to four decorations to each photo.

- 1 Select a photo that you want to decorate.
- 2 Press  **Menu**.
- 3 Press  or  to highlight **Edit**, then press **OK**.
- 4 Press  or  to highlight **Decorate**, then press **OK**.
- 5 Press  or  to highlight **Add Decoration**, then press **OK**. You see a selection of decorations.
- 6 Press , , , or  to browse the images. When the decoration you want to use is highlighted, press **OK**. You see the decoration on your photo:



If you want to select a different decoration, press  **Back** and repeat step 6.

- 7 Adjust the size and position of the decoration:
  - Press  **Zoom** to make it larger. Continue pressing  **Zoom** to make it smaller.
  - Press , , , or  to move the decoration to a different part of your photo.
  - Press  **Menu** to rotate the decoration.
- 8 Press **OK**. You see your photo with the decoration applied, and a message asking if you want to keep it.
- 9 Press **OK**. You see a screen that allows you to add another decoration.
- 10 If you want to add another decoration, press **OK** and repeat steps 6 through 9.





You can print your decorated photo or select additional photos and print them with or without decorations.



## Adding Camera Text

If your camera allows you to add text to your photos, you can print the pictures along with the text.

This setting is available for borderless photos only.





- 1 Select the photos that have text added by your camera.
- 2 Press  **Menu**.
- 3 Press  or  to highlight **Print Settings**, then press **OK**.
- 4 Press  or  to highlight **Camera Text**, then press **OK**.
- 5 Highlight **On**, then press **OK**.

When you press  **Print**, you see the camera text icon on the preview to remind you about the setting.

Note: Before you print, make sure the Borderless Layout setting is selected. See page 17 for more information.

## Rotating

You can rotate a photo on PictureMate's photo viewer screen. This does not affect how the photo prints, only how you see it on the screen.

- 1 Select the photo you want to rotate.
- 2 Press  **Menu**.
- 3 Press  or  to highlight **Edit**, then press **OK**.
- 4 Press  or  to highlight **Rotate**, then press **OK**.

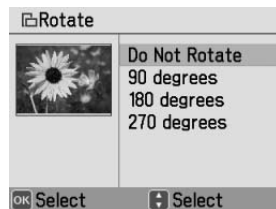

- 5 Select **90 degrees**, **180 degrees**, or **270 degrees** (or select **Do Not Rotate**). Your photo is rotated on the screen.
- 6 Press **OK**.
- 7 Select whether to apply the rotation to the current photo or all photos, then press **OK**.

## Save Photos to a CD

PictureMate Zoom can make backup copies of the photos on your camera's memory card by saving them to a CD in its built-in CD burner.

With PictureMate Dash, you can connect an external CD burner. See the on-screen *User's Guide* for instructions.

### ***Saving Photos to the Built-in CD Burner***

You can save photos to a CD using the built-in CD drive in PictureMate Zoom. Use only 12-cm CDs and select a quality brand. The following types are compatible with this printer:

- CD-R
- CD-RW Multi
- CD-RW High
- CD-RW Ultra

Note: PictureMate supports both 650MB (74 min.) and 700MB (80 min.) capacities for each type of CD.

You can also have PictureMate automatically print an index of your saved photos. An index provides small thumbnail images—up to 56 per sheet—of all the photos you've copied.

- 1** Make sure PictureMate Zoom is turned on.

Note: Copying to a CD takes extra energy. If you're using the optional battery, make sure it's fully charged, or connect the AC power adapter.

- 2** Insert your memory card into PictureMate.

- 3 Press the CD eject button to open the tray, then gently pull it out all the way.
- 4 Place a CD on the tray and carefully press it down over the hub.

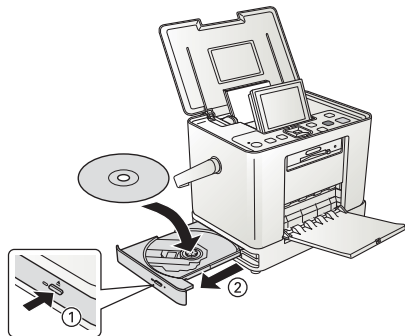

- 5 Gently push the tray back in.  
The light on the front of the tray flashes, indicating that the CD is being read.
- 6 If you want to copy all the photos on your memory card, skip to the next step.

To copy individual photos, select the ones you want to copy. (Press ◀ or ▶ to view your photos. Then press **OK** when you see a photo you want to copy.)

- 7 Press the  **Save to CD** button. (Or press  **Menu**, highlight **Save Photos**, then press **OK**.)



- 8 At the next screen, select whether to copy all photos or just the selected photos, then press **OK**.
- 9 When you see the warning screen, press **OK**. At the confirmation screen, press **OK** again.
- 10 When you see a message asking if you want to print an index of your copied photos, select **Print Backup Index** or **Do Not Print**. If necessary, make sure paper is loaded. The sheet automatically prints once the backup is complete.

- 11** Follow the instructions on the screen to complete the backup. The CD is ejected automatically when the backup is finished.

Each time you copy photos to the same CD, PictureMate creates a new numbered folder (001, 002, etc.) where it stores your photos.

If another CD is required to save all the photos, you will see a message on the screen. Insert another CD and press **OK**.

Caution: Avoid handling the printer during backup. Also, do not remove the memory card or CD while photos are being saved, or you may lose photos on your card or CD.

If you want to print any of your photos from the CD, see page 32 for instructions.

## Print From an External Device

PictureMate can print photos stored on a:

- PictBridge- or USB DIRECT-PRINT-enabled digital camera (this page)
- USB-connected external drive, such as a CD drive, Zip drive, or flash memory (thumb) drive (see page 29)
- Bluetooth-enabled device (requires an optional Bluetooth Photo Print adapter; see page 30)
- CD using PictureMate's built-in CD drive (PictureMate Zoom only; see page 32)

Tip: Once you've connected PictureMate to an external drive, you can copy photos from your camera's memory card to the drive for safekeeping. See your on-screen *User's Guide* for instructions.

## Printing From a Digital Camera

You can connect a digital camera that supports PictBridge or USB DIRECT-PRINT printing to PictureMate and use the camera to control printing.

(Check your camera manual to see if it supports PictBridge or USB DIRECT-PRINT. A cable may not be included with your camera.)

- 1** Make sure PictureMate is on but not printing.
- 2** Make sure there are no memory cards in PictureMate's slots.

Note: You must remove your memory card or the printer will read photos from the card, not from a camera.

- 3** Turn on your camera.

- 4** Connect your camera's USB cable to your camera and the  **EXT. I/F** port on the back of PictureMate.

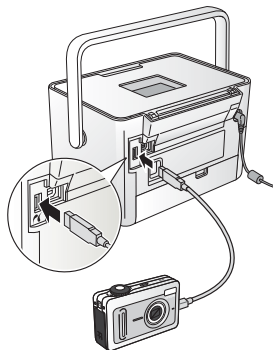

- 5** Use your camera's controls to select and print photos on PictureMate. (See your camera manual for instructions.)
- 6** If you need to adjust any print settings, press  **Menu**, select **Setup**, and then select **Direct Print Settings**. For more information, see page 58.
- 7** When you are finished, disconnect your camera before inserting a memory card in PictureMate.

## ***Printing From an External Drive***

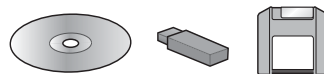

If you have saved photos on a CD, flash memory (thumb) drive, or Zip disk, you can connect the drive to the back of PictureMate and print just like you do when you insert a memory card.

You can also print photos from a CD that you get from a photo processing lab. (Images should be in JPEG or uncompressed Tiff file format. Some CDs may not work.)

- 1** Make sure PictureMate is on.
- 2** If PictureMate is connected to a computer, disconnect it or turn off the computer.

- 3** Connect your CD or Zip drive's USB cable, or plug in your flash memory drive, to the **EXT. I/F** port on the back of PictureMate.

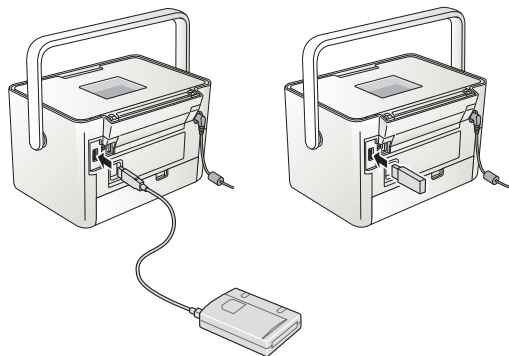

- 4** For a CD or Zip drive, insert a CD or Zip disk with photos into the drive.

If you have a memory card already inserted in PictureMate, you must select the external drive as the source to see any photos on the disc or drive.

To select the source, press **Menu**, highlight **Select**, and press **OK**. Then choose **Select Source**, press **OK**, and select **External Device**.

Once your photos are displayed, you can view and print them just like photos on a memory card.

Note: If there are folders on the CD, Zip disk, or thumb drive, PictureMate searches those folders and displays any photos stored in them.

## **Printing Wirelessly From a Bluetooth Device**



You can print photos wirelessly from your Bluetooth-enabled PDA, cell phone, or computer when you use the optional Epson Bluetooth Photo Print Adapter. The adapter (part# C12C824383) is available from your local reseller or Epson (see page 68).

Note: Although PictureMate complies with the Bluetooth specification, it is not guaranteed to work with all devices that have Bluetooth wireless technology. Make sure your photos meet the requirements listed on page 4.

- 1** Make sure PictureMate is on but not printing.

Caution: Do not connect or remove the Bluetooth Photo Print Adapter while it is communicating with a device or while PictureMate is printing; this may cause PictureMate to malfunction.

- 2** Plug the adapter all the way into the **EXT. I/F** port on the back of PictureMate.

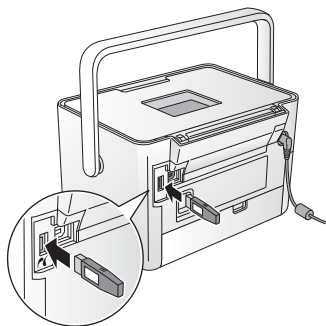

- 3** Make sure you are within about 30 feet of PictureMate.
- 4** Select the photo you want to print from your Bluetooth device and send it to PictureMate:
- **Windows:**® Send photos directly to PictureMate with your Bluetooth file sharing program. See the documentation included with your computer's Bluetooth adapter for details.

- **Macintosh:**® Double-click **Bluetooth File Exchange** in your **Utilities** folder. Follow the on-screen steps to choose a photo file, discover PictureMate, and send photos.
- **Cell phones or PDAs:** See your product's documentation for instructions on setting up Bluetooth file sharing and sending files.

Printing starts automatically.

If you see a Bluetooth error message on the PictureMate screen, try printing the photo from a memory card or your computer instead.

Note: For instructions on selecting PictureMate's Bluetooth settings, see page 58 and the on-screen *User's Guide*.



## Disconnecting the Adapter

Make sure PictureMate is not printing, then pull the adapter out of its port.

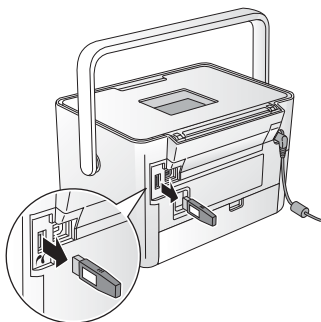

Caution: Do not connect or disconnect the Bluetooth Photo Print Adapter while it is communicating with your device or while PictureMate is printing; this may cause PictureMate to malfunction.

## Printing From the Built-in CD Drive

You can print photos from a CD or DVD using PictureMate Zoom's built-in CD drive.

Note: If you're using PictureMate Dash and you want to print photos from a CD or DVD, you can install the PictureMate software and connect the printer to your computer. See the section starting on page 34 for instructions.

- 1** Make sure PictureMate Zoom is turned on.
- 2** Press the  $\blacktriangle$  eject button to open the tray, then gently pull it all the way out.
- 3** Place a CD or DVD on the tray and carefully press it down over the hub.

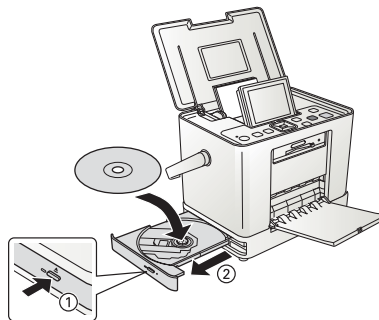

#### 4 Gently push the tray back in.

The light on the front of the tray flashes, indicating that the CD or DVD is being read.

If you also have a memory card already inserted in PictureMate Zoom, you must either remove the card or select the CD drive as the source to see any photos on the CD or DVD.

To select the source, press  **Menu**, highlight **Select**, and press **OK**. Then choose **Select Source**, press **OK**, and select **CD**.

Once your photos are displayed, you can view and print them just like photos on a memory card.

#### 5 If you want to print a proof sheet of the photos on your CD or DVD, press **Menu**, select **Print Settings**, select **Layout**, and select **CD Index**. Up to 56 photo thumbnails are printed on each sheet.

Note: In addition to printing from a CD or DVD, you can also back up photos on your camera's memory card by saving them on a CD in PictureMate Zoom's built-in CD drive (see page 25) or an external drive on PictureMate Dash (see your on-screen *User's Guide*).

### Ejecting the CD or DVD

- 1 Press the  eject button to open the tray, then gently pull it all the way out.
- 2 Remove the CD or DVD, then gently push the tray back in.

## Print From a Computer

To use PictureMate with your computer, you must first:

- Install the PictureMate software on your computer from the PictureMate CD as described here.



- Connect PictureMate to your computer with a USB cable. If you don't have a USB cable, you can buy one from your local computer dealer or from Epson.



Once your software is installed and PictureMate is connected to your computer, see page 39 for instructions on printing from your computer.

Tip: Once you've connected PictureMate to your computer, you can insert a memory card in PictureMate and view, copy, or print files on the memory card as if it were a drive on your computer. You can even copy files from your computer to the memory card. See your on-screen *User's Guide* for instructions.

Periodically, it's a good idea to check Epson's support website at [epson.com/support](http://epson.com/support) for free updates to your PictureMate printer software. Download instructions are posted for your convenience.

## Installing Software and Connecting PictureMate

**DO NOT** connect PictureMate to your computer before installing the software.

**REMOVE** your memory card from PictureMate before you begin.

Follow the installation steps for your computer:

- Windows (below)
- Macintosh (page 37)

Note: If you have problems installing the software, see page 65.

### Installing Software for Windows

Before you start, make sure PictureMate is **NOT** connected to your computer and does **NOT** have a memory card inserted in it.

- 1 Press the I/⏻ **On** button to turn on PictureMate.
- 2 Turn on your computer.

Note: If you see a Found New Hardware screen, click **Cancel** and disconnect PictureMate from your computer.



- 3 Insert the PictureMate CD in your CD/DVD drive.
- 4 With Windows Vista, you see this screen:



Click the option to run **RUNEPSON.exe**, then click **Continue** at the User Account Control screen.

- 5 When you see this screen, click **Next**.



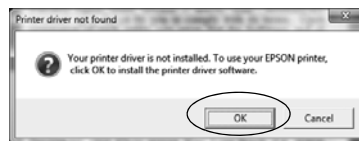

- 6 Read the license agreement and click **Agree**. You see this message:

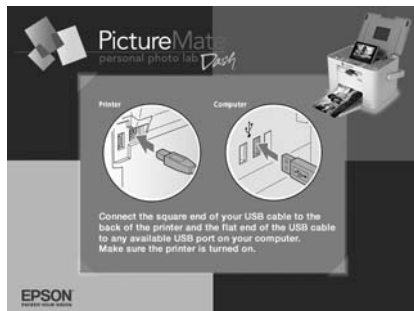

- 7 Click **OK**.

After a moment, you see this screen:



- 8** Connect the USB cable to any open USB port on your computer. Then connect the other end to the  USB port on the back of PictureMate.

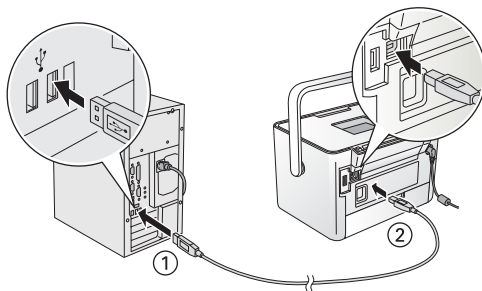

The installer installs your PictureMate software.

Note: If you see a screen like this one, remove your memory card and click the **X** in the corner to close it.

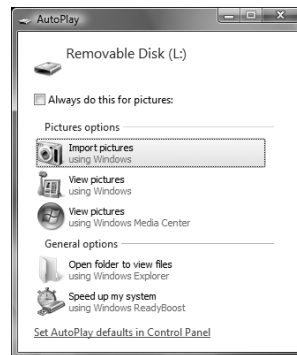

- 9 If you see the screen below, click **No** (unless PictureMate is your only printer).

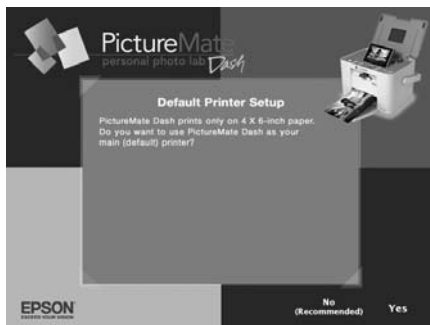

Note: With Windows Vista, PictureMate is automatically set as your default printer. If you have another printer, you can change this setting in the Windows Control Panel.

- 10 When you see a message that your printer driver is installed, click **Next**. ArcSoft® PhotoImpression™ and your on-screen *User's Guide* are installed.
- 11 When you see the Creative Zone screen, click **Add Icon**.
- 12 When you're finished, click **Exit**. You see the registration screen.

- 13 Follow the on-screen instructions to register PictureMate.

- 14 Remove the CD and restart your computer.

Now you can print photos from your computer on PictureMate (see page 39).

## Installing Software for Macintosh

Before you start, make sure PictureMate does **NOT** have a memory card inserted in it.

- 1 Connect the USB cable to any open USB port on your Macintosh. Then connect the other end to the  USB port on the back of PictureMate.

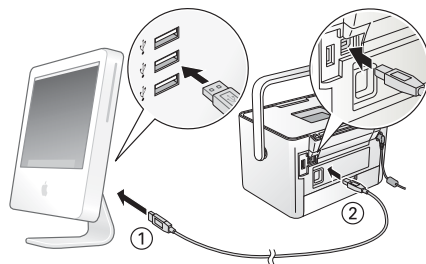

- 2 Press the I/⏻ **On** button to turn on PictureMate.

- 3 Turn on your Macintosh.
- 4 After the Macintosh starts up, insert the PictureMate CD in your CD-ROM or DVD drive.
- 5 Double-click the **EPSON PictureMate** icon.
- 6 Read the license agreement and click **Agree**. You see the Install Menu:



- 7 Click **Install Printer Driver**, then follow the on-screen instructions to install the driver.
- 8 When you return to the Install Menu, click **Install ArcSoft PhotoImpression**, then follow the on-screen instructions to install the software.
- 9 Click **Install Printer Manual**, wait a moment, then click **Add Creative Projects link**.
- 10 When you see the Creative Zone screen, click **Add Icon**.
- 11 Click **Exit**. You see the registration screen.
- 12 Follow the on-screen instructions to register PictureMate.
- 13 Remove the CD and restart your Macintosh.
- 14 To select PictureMate as your printer, open the **Applications > Utilities** folder and double-click **Printer Setup Utility (Print Center in OS X 10.2)**.
- 15 Click **Add**.

- 16** In OS X 10.4, select your **PictureMate** model. (In OS X 10.2 or 10.3, select **EPSON USB** at the top and your **PictureMate** model below.)

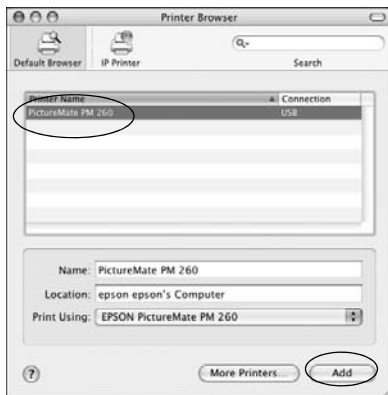

- 17** Click **Add**, then quit the Printer Setup Utility (or Print Center).

Now you can print photos from your Macintosh on PictureMate.

## ***Printing From a Computer***

Follow these basic printing instructions for your computer:

- Windows (below)
- Macintosh (see page 46)

For instructions on printing using ArcSoft PhotoImpression, see your on-screen *User's Guide*.

## **Printing From a Windows Computer**

You can print photos from an imaging application, the Windows Photo Gallery in Windows Vista (page 40), or the Picture and Fax Viewer in Windows XP (page 42).



## Printing with the Windows Vista Photo Gallery

- 1 Locate the photo you want to print on your computer.
- 2 Right-click the photo, highlight **Open With**, and select **Windows Photo Gallery**.



- 3 Click the **Print** icon at the top of the screen, then select **Print** from the drop-down menu that appears.

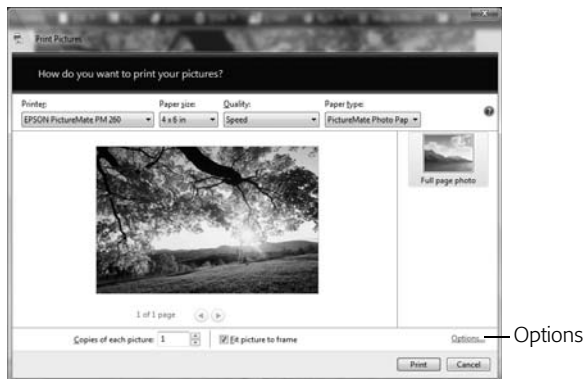

- 4 Make sure your printer is selected, then choose **PictureMate Photo Paper** as the Paper type setting. (**4 × 6 in** is automatically selected as the Paper size setting.)
- 5 Click **Options** in the lower right corner of the screen and select **Printer Properties**.

You see the printer settings window:

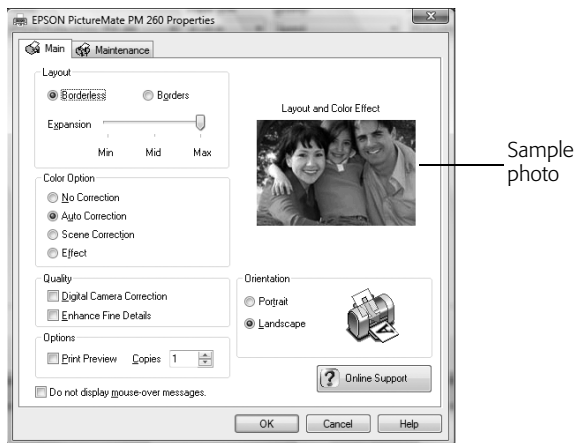

Sample photo

## 6 Choose from the following settings:

- Select **Borderless** to print a photo without borders. Select **Borders** to print with a white border all around.
- Borderless prints are automatically expanded. If too much of your photo edges are cut off, set the Expansion slider to **Min**. If you see a white edge on your photo, select **Mid** or **Max**.

- You can change the Color Option and see the effects on the sample photo (the changes don't affect your original).

**Auto Correction** improves the quality of photos that are too dark or have a color cast.

**Scene Correction** lets you choose the subject of your photo so that PictureMate can correct it appropriately. You can select **People**, **Landscapes**, or **Night scene**.

**Effect** lets you choose from two color effects: **Sepia** (for an old-fashioned look) or **Black & White**.

- If your photo was taken with a digital camera, select **Digital Camera Correction** to minimize common digital flaws.
- Select **Enhance Fine Details** to bring out the fine details of a particularly intricate photo (printing may be slower).
- Select **Print Preview** to see what your photo will look like before you print.
- Select the number of copies you want to print.

Tip: For more information about printer settings, click Help.

- 7 Click **OK**.
- 8 When you return to the Windows Photo Gallery, click **Print** to start printing.

During printing, this window appears on your computer screen showing the progress of your print job. You can cancel, pause, or resume printing, and view your Print Pack status.

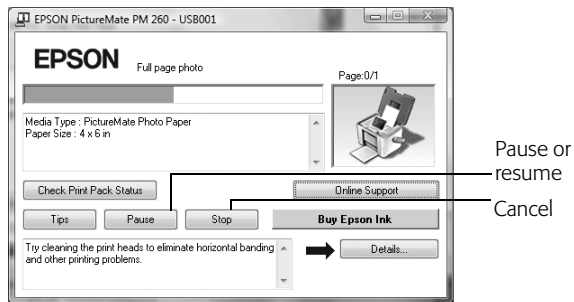

## ***Printing with the Windows XP Picture and Fax Viewer***

- 1 Locate the photo you want to print on your computer.
- 2 Right-click the photo, highlight **Open With**, and select **Windows Picture and Fax Viewer**.



Print icon

- 3 Click the  Print icon at the bottom of the screen.
- 4 Click **Next**.

- 5 When you see this screen, select the photo(s) you want to print and click **Next**.



- 6 When you see this screen, select your **EPSON PictureMate** model and click **Printing Preferences**.

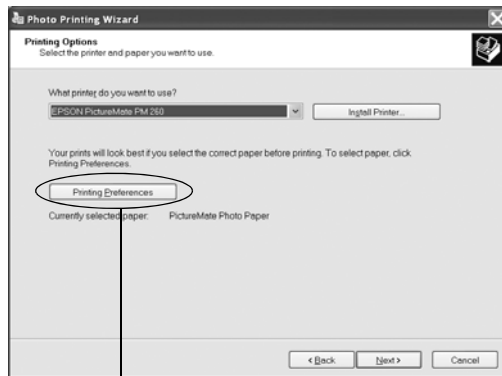

Printing Preferences

You see the printer settings screen:

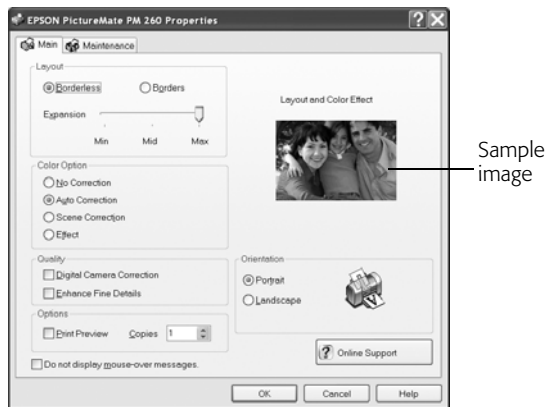

Sample image

## 7 Choose from the following settings:

- Select **Borderless** to print a photo without borders. Select **Borders** to print with a white border all around.
- Borderless prints are automatically expanded. If too much of your photo edges are cut off, set the Expansion slider to **Min**. If you see a white edge on your photo, select **Mid** or **Max**.

- You can change the Color Option and see the effects on the sample photo (the changes don't affect your original).

**Auto Correction** improves the quality of photos that are too dark or have a color cast.

**Scene Correction** lets you choose the subject of your photo so that PictureMate can correct it appropriately. You can select **People**, **Landscapes**, or **Night scene**.

**Effect** lets you choose from two color effects: **Sepia** (for an old-fashioned look) or **Black & White**.

- If your photo was taken with a digital camera, select **Digital Camera Correction** to minimize common digital flaws.
- Select **Enhance Fine Details** to bring out the fine details of a particularly intricate photo (printing may be slower).
- Select **Print Preview** to see what your photo will look like before you print.
- Select the number of copies you want to print.

Tip: For more information about printer settings, click **Help**.

- 8 Click **OK**.
- 9 At the Photo Printing Wizard screen, click **Next**.
- 10 When you see this screen, select **Full page photo print** and click **Next**.



Full page photo print

During printing, this window appears on your computer screen showing the progress of your print job. You can cancel, pause, or resume printing, and see your Print Pack status.

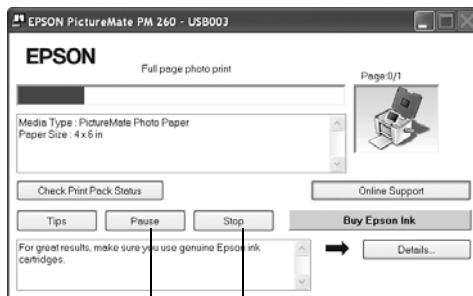

Pause or  
resume

Cancel

## Printing From a Macintosh

You can print your photos from any Macintosh imaging application.

- 1 Start your print program and open the photo you want to print.
- 2 From the File menu, select **Page Setup**.

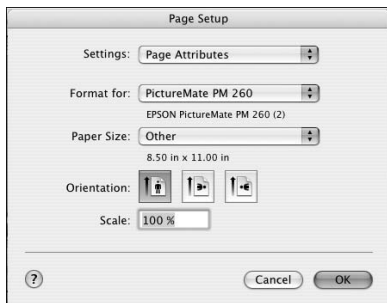



- 3 Select your **PictureMate** model from the Format for menu.
- 4 Open the Paper Size menu and place your cursor on the **4 × 6 in** option. You see extended options:



- Select **4 × 6 in (Borderless)** to print without any borders.
- Select **4 × 6 in (Borders)** to print with white borders all around.

Note: iPhoto® expands two sides of an image to the maximum print area, so you may see small borders in iPhoto prints.

- 5 Select the direction you want your photo to print ( for portrait,  for landscape facing right, or  for landscape facing left) as the Orientation.
- 6 Click **OK**.
- 7 Select **Print** from the File menu.

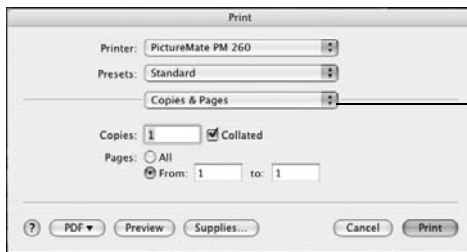

Select  
Print  
Settings

**8** Select **Print Settings** from the pop-up menu.



Tip: To check your Print Pack status, click the  maintenance icon. For more information about printer settings, click **?**.

**9** Choose from the following settings:

- Select **Enhance Fine Details** to bring out the fine details of a particularly intricate photo (printing may be slower).

- You can change the Color Option and see the effects on the sample photo (the changes don't affect your original).

**Sepia** changes the colors to brown for an old-fashioned look.

**Black & White** changes a color photo to black-and-white.

- Borderless prints are automatically expanded. If too much of your photo edges are cut off, set the Expansion slider to **Min**. If you see a white edge on your photo, select **Mid** or **Max**.

Note: iPhoto expands two sides of an image to the maximum print area, so you may see small borders in iPhoto prints.

**10** You can also choose other options in the pop-up menu, including:

- **Copies & Pages**, to select the number of copies or a page range
- **Summary**, to view a list of all your selections

**11** Click **Print**.



- 12** To monitor the progress of your print job, click the  **PictureMate** or **Print Center** icon when it appears in the dock.

If you clicked the Print Center icon, double-click your **PictureMate** model.

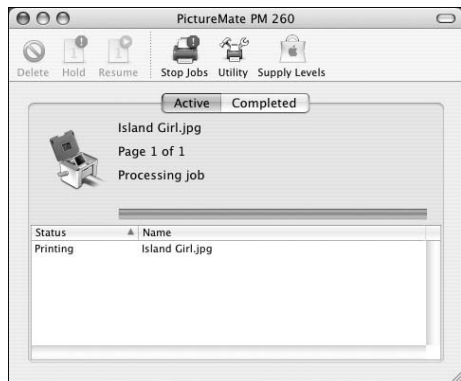

- 13** From this window, you can do the following:
- To cancel printing, click the print job and click **Delete**.
  - To pause printing, click the print job and click **Hold**.
  - To resume printing, click a print job marked “Hold” and click **Resume**.
  - If multiple print jobs are listed and you want one to print before the other(s), select the job and click the **Status** arrow to move it up.
- 14** When you’re finished, exit the PictureMate or Print Center program.

## Replace Print Pack

When PictureMate needs a new Print Pack, you will see a message on the photo viewer screen. The Print Pack contains a new photo cartridge and photo paper.

When you need a new Print Pack, see these sections:

- Buy a PictureMate 200 Series Print Pack (to the right)
- Replace the Print Pack (see page 50)

If you want to check the status of your Print Pack, see page 52.

Tip: If you see a replacement message while printing, you can replace the Print Pack and continue the current print job. Just replace it without turning off and unplugging PictureMate.

Note: Use your PictureMate 200 Series photo cartridge within six months of installing it and before the expiration date on the package.

Caution: To ensure good results, use a genuine PictureMate 200 Series photo cartridge and do not refill it. Other products may cause ink spills or other damage to your printer not covered by Epson's warranty.

## Buying a Print Pack



You can buy a PictureMate 200 Series Print Pack wherever PictureMate is sold or from retailers that sell printer supplies.

The following Print Packs are available:

Print Pack contents	Part number	Supported PictureMate models
Glossy photo paper (150 sheets) and photo cartridge	T5846	All PictureMate 200 Series models
Matte photo paper (100 sheets) and photo cartridge	T5845-M	

You can also buy a Print Pack and other PictureMate accessories from an Epson authorized reseller. To find the nearest reseller, call 800-GO-EPSON (800-463-7766). Or you can purchase online at [www.epsonstore.com](http://www.epsonstore.com) (U.S. sales) or [www.epson.ca](http://www.epson.ca) (Canadian sales).

## Replacing the Print Pack

Make sure you have a new PictureMate 200 Series Print Pack before you remove the old photo cartridge. Once you remove the cartridge, you must install the new one right away.

Caution: Before you replace the cartridge, read the "Photo Cartridge Safety Instructions" on page 71.

- 1 Make sure PictureMate is on but not printing.
- 2 Open the cartridge door on the back of PictureMate.

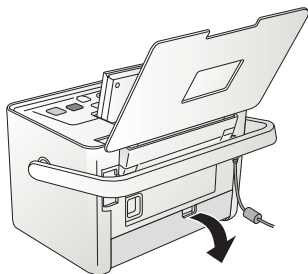

- 3 Slide the cartridge lever left, to the **Release** position.

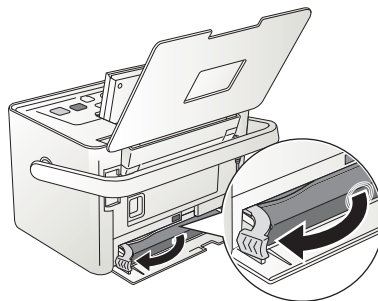

Caution: Do not try to pull out the cartridge without moving the lever.

- 4** Pull out the cartridge and dispose of it properly. (For appropriate disposal, check local resources for recycling guidelines.)

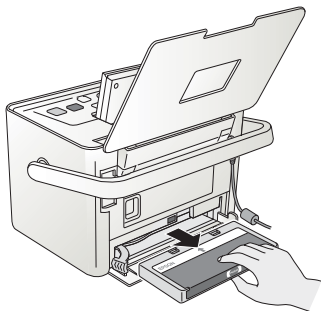

Warning: Keep photo cartridges out of the reach of children and do not drink the ink.

If ink gets on your hands, wash them thoroughly with soap and water. If ink gets in your eyes, flush them thoroughly with water. If discomfort or vision problems continue after flushing, see a doctor immediately.

Caution: Do not attempt to refill the photo cartridge. This could result in ink spills or other damage to PictureMate not covered by Epson's warranty.

- 5** Remove the new photo cartridge from its package.

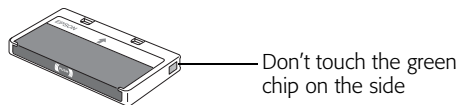

Caution: Don't touch the small green circuit board. Install the photo cartridge immediately. If you leave a cartridge unpacked for a long time before using it, normal printing may not be possible.

- 6** Slide the cartridge straight into the slot, label side up, until it clicks into place.

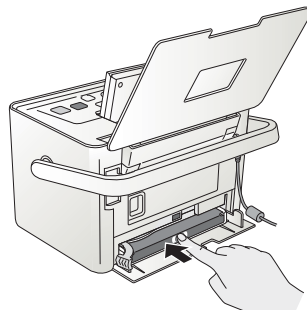

Note: The cartridge won't go in all the way. You need to use the cartridge lever to lock it in place.

- 7** Slide the lever all the way right, to the **Lock** position.

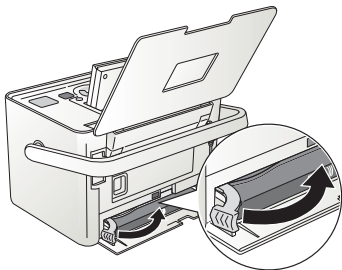

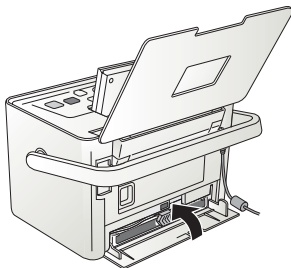

Caution: If the cartridge is not inserted correctly, PictureMate will not be able to print.

- 8** Close the cartridge door all the way.



## Checking Print Pack Status

You can check the status of your Print Pack at any time.

- 1** Press  **Menu**.
- 2** Press  or  to highlight **Maintenance**, then press **OK**.
- 3** Highlight **Check Print Pack Status** and press **OK**. You see the status displayed on the photo viewer screen:

The gray square represents the ink level

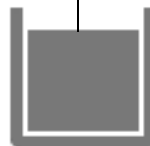

- 4** Press **OK** to exit.

Note: If the screen displays a **Print Pack low** message, you should buy a new PictureMate 200 Series Print Pack. See page 49 for details.

## Take PictureMate With You

PictureMate's handle makes it easy to carry short distances. If you have the optional battery, you can use PictureMate just about anywhere, even if an electrical outlet is not available.

Tip: You can order an optional PictureMate Carrying Case (part number PMBAG06) from Epson. See page 68 for details.

### ***Packing Your PictureMate***

If PictureMate is going to travel a longer distance, pack it carefully to help protect it from getting damaged.

Caution: Keep PictureMate out of the sun and don't leave it in your car or other location where it can get too hot or too cold. PictureMate may be damaged or ink may leak.

- 1** Remove the CD if you have one in the CD drive (PictureMate Zoom only).
- 2** Press the I/⏻ **On** button to turn PictureMate off.
- 3** Wait until the **On** light goes out, then unplug the power cable from the power outlet.
- 4** Remove all paper and printed photos.

- 5** Lower the screen, then close the paper support and output tray.

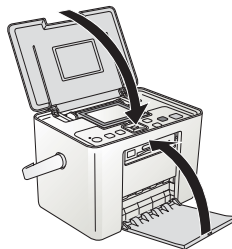

- 6** Unplug the power adapter and any connected USB cable or device. Place the power cable and adapter in the PictureMate accessory box.
- 7** Pack PictureMate in the box that it came in or the optional carrying case.

Caution: Make sure the photo cartridge is installed. Do not remove the photo cartridge before transporting. Don't place PictureMate on its side or upside down, or ink may leak.

Note: If your prints don't look as good after PictureMate has been moved, try aligning the print head (see page 62).

## Using the Optional Battery

To buy the optional battery, check with your PictureMate retailer or go to [www.MyPictureMate.com](http://www.MyPictureMate.com). See page 68 for more information on purchasing PictureMate supplies and accessories.

With a fully charged battery, you can print about 100 photos (or 60 photos when printing from PictureMate Zoom's built-in CD drive).

## Installing the Battery

- 1 Make sure PictureMate is turned off.
- 2 Unplug the AC adapter from PictureMate.
- 3 Release the latch and remove the battery cover from the back of the printer.

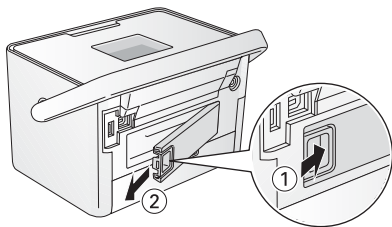

- 4 Insert the battery as shown until it clicks into place.

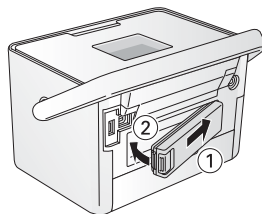

## Charging the Battery

After you install the battery, you need to charge it by connecting the AC adapter and plugging in the printer.

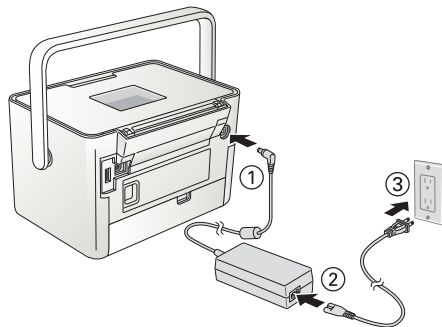

The power light flashes during charging when PictureMate is off. It takes about 2 hours to fully charge the battery when PictureMate is off. It takes longer when you use PictureMate while it is charging. The power light turns off when the battery is fully charged (if PictureMate is turned off).

The following battery status icons appear in the upper right corner of the photo viewer screen:



Flashing Charging



Green Low



Green Fully charged



Red Very low



Green Sufficient power



White Almost out

Note: If you are running PictureMate with the battery, the printer turns off automatically after 15 minutes if it is not being used (unless PictureMate is connected to a computer and a memory card is inserted). Press the **I/⏻ On** button to turn it back on.

## Removing the Battery

If there is a problem with your battery, or you want to replace it with one that is already charged, you need to remove the battery.

- 1 Make sure PictureMate is turned off.
- 2 Release the latch and remove the battery.

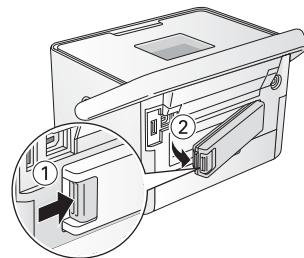

- 3 Replace the battery cover.



## Set PictureMate Preferences

You can change the way PictureMate works by using the Setup menu. You can set the following preferences:

- Turn the print preview screen off or on (on the right)
- Turn on a confirmation screen that allows you to continue making settings from the menu (see page 57)
- Change PictureMate's language to French, Portuguese, or Spanish (see page 57)
- Make settings for printing directly from your camera (see page 58)
- Make settings for Bluetooth printing (see page 58)
- Return the settings to their defaults (see page 59)

### Turning Print Preview Off or On

When you press the  **Print** button, you see a screen that lets you confirm your selected photos and settings, for example:

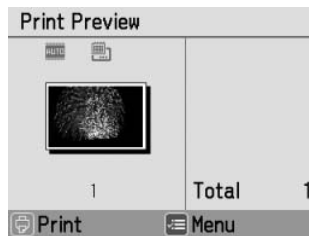

Then you press  **Print** again to start printing.

If you don't want to see this screen before printing, you can turn it off. You will only need to press  **Print** once to start printing.

- 1 Press  **Menu**.
- 2 Press  or  to highlight **Setup**, then press **OK**.

- 3 Press ▲ or ▼ to highlight **Confirm Print Preview**, then press **OK**.
- 4 Press ▲ or ▼ to choose **Off** or **On**, then press **OK**.

## Turning the Settings Confirmation On or Off

After you use the menu to change a print setting, PictureMate exits the menu. If you want to stay in the menu to adjust additional settings, you can have PictureMate display the following confirmation:

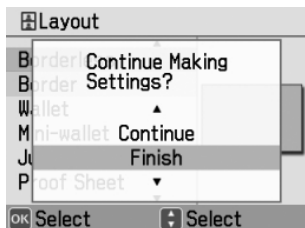

You can continue changing settings or select **Finish** to return to viewing photos.

Follow these steps to turn on the settings confirmation:

- 1 Press ☰ **Menu**.
- 2 Press ▲ or ▼ to highlight **Setup**, then press **OK**.
- 3 Press ▲ or ▼ to highlight **Confirm Print Settings**, then press **OK**.
- 4 Press ▲ or ▼ to choose **Off** or **On**, then press **OK**.

## Changing PictureMate's Language

You can change the language on PictureMate's screen to French, Portuguese, or Spanish.

- 1 Press ☰ **Menu**.
- 2 Press ▲ or ▼ to highlight **Setup**, then press **OK**.
- 3 Press ▲ or ▼ to highlight **Language**, then press **OK**.
- 4 Press ▲ or ▼ to choose the language you want, then press **OK**.

Caution: If you change the language, all the words on the screen will appear in the new language. Make sure you select the right language.

## Making Direct Camera Print Settings

When you print directly from your camera, you can't select settings the way you can when you print from a memory card. Instead, you can use the Direct Print Settings on the Setup Menu.

- 1 Press  **Menu**.
- 2 Press **▲** or **▼** to highlight **Setup**, then press **OK**.
- 3 Press **▲** or **▼** to highlight **Direct Print Settings**, then press **OK**.
- 4 Press **▲** or **▼** to select one of the following settings, then press **OK**.
  - Color Effect (see page 22)
  - Red-Eye (see page 18)
  - Brightness (see page 20)
  - Saturation (see page 20)
  - Sharpness (see page 20)

## Making Bluetooth Settings

If you have the optional Epson Bluetooth Photo Print Adapter, you can print wirelessly from your Bluetooth-enabled cell phone, PDA, or computer.

The Setup menu allows you to make communication and security settings for Bluetooth printing.

- 1 Press  **Menu**.
- 2 Press **▲** or **▼** to highlight **Setup**, then press **OK**.
- 3 Press **▲** or **▼** to highlight **Bluetooth**, then press **OK**.
- 4 Press **OK** again to select Bluetooth Setup. You see the following screen:

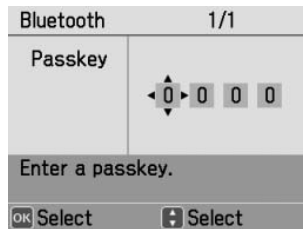

- 5 Press **▲** or **▼** to change the first digit, then press **▶** to move to the second digit.

**6** Repeat step 5 until you have entered a 4-digit number to use as your Bluetooth Passkey. Then press **OK**.

**7** At the confirmation screen, press OK again.

The passkey will be required if your Bluetooth Communication Mode is set to Pairing, or if Encryption is enabled. For more information about Bluetooth settings, see your on-screen *User's Guide*.

## ***Returning to Default Settings***

You can return all settings to the PictureMate original default settings.

**1** Press  **Menu**.

**2** Press **▲** or **▼** to highlight **Setup**, then press **OK**.

**3** Press **▲** or **▼** to highlight **Reset Default Settings**, then press **OK**. You see this message:

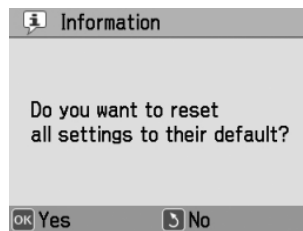

**4** Press **OK** to restore the original settings, or press  **Back** to go back to the menu without restoring the settings.

After you restore the default settings, you see a confirmation message.

**5** Press **OK** to confirm.

## Printer Care and Troubleshooting

If you have problems with your PictureMate, or you want to improve print quality, read these sections:

- Cleaning the print head (on the right)
- Aligning the print head (on page 62)
- Cleaning PictureMate (on page 63)
- Printing and operation problems (on page 63)
- Software installation problems (on page 65)
- Print quality problems (on page 65)
- Problems with paper feeding (on page 66)
- Miscellaneous printout problems (on page 67)
- Where to get help (on page 68)

### ***Cleaning the Print Head***

If your print quality is not as good as it used to be—if photos are too light, are missing colors, or have lines running through them—PictureMate's print head nozzles may need cleaning.

Note: If the screen displays a **Print Pack low** message, you may not be able to clean the print head until you replace the Print Pack.

Follow these steps to clean the print head:

- 1** Load paper in PictureMate so you can print a nozzle check pattern after cleaning the print head.
- 2** Press **Menu**.
- 3** Press **▲** or **▼** to highlight **Maintenance**, then press **OK**.
- 4** Press **▲** or **▼** to highlight **Auto Cleaning**, then press **OK**.

You see a confirmation screen:

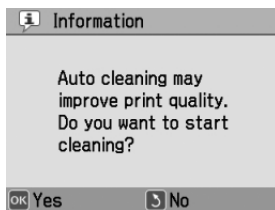

- 5 Press **OK** again to clean the print head. Cleaning takes about 60 seconds. PictureMate makes some noise and you see an **Auto Cleaning** message.

When cleaning is complete, PictureMate prints a nozzle check pattern and displays this screen:

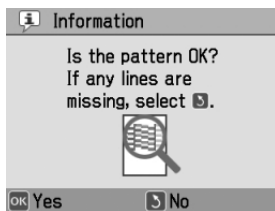

- 6 Check the pattern to see if there are any gaps or missing lines.

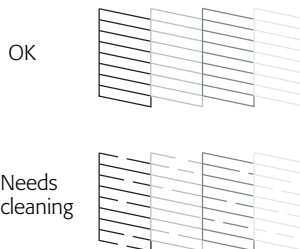

- If the pattern is OK, press **OK** to finish.
- If the pattern has gaps or missing lines, press **Back** to clean the print head again. You may need to clean it two or three times before the nozzles are clean.

If you don't see any improvement after cleaning three times, see "Print Quality Problems" on page 65.

Note: You can run a nozzle check before you clean the print head. Follow steps 1 through 3 on page 60. Then select **Nozzle Check**.

## Aligning the Print Head

If you have moved PictureMate and print quality is not as good as it used to be—if your prints look fuzzy or have light or dark lines running through them—you may need to align the print head.

- 1 Load paper in PictureMate so you can print the head alignment pattern.
- 2 Press **Menu**.
- 3 Press **▲** or **▼** to highlight **Maintenance**, then press **OK**.
- 4 Press **▲** or **▼** to select **Head Alignment**, then press **OK**. You see a confirmation screen:

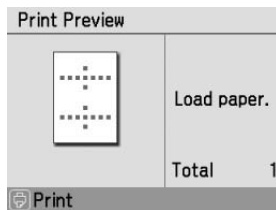

- 5 Press **Print**. The alignment pattern is printed:

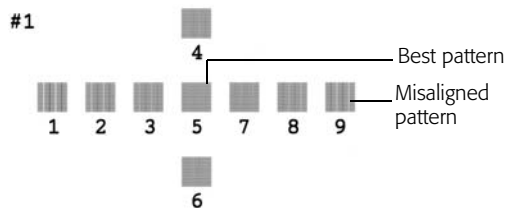

You see the Head Alignment screen:

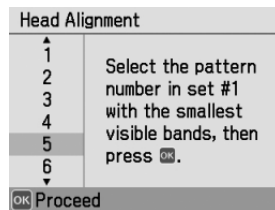

- 6 Look at the printed squares to determine which one is the most even, with no streaks or white lines. (You may need to use a magnifying glass.)
- 7 Press **▲** or **▼** to select the number for the best square (1 to 9) in set #1. Then press **OK**.

- 8 Press ▲ or ▼ to highlight the number for the best square (1 to 9) in set #2. Then press **OK**.

PictureMate aligns the print head and exits the Maintenance menu.

Note: The square you select becomes the middle square (#5) the next time you align the print head.

## ***Cleaning PictureMate***

To keep PictureMate working at its best, you should clean it several times a year. Follow these steps:

- 1 Turn off PictureMate, unplug the power cable, and disconnect the power adapter and any USB cable or device.
- 2 Remove all paper, then use a soft brush to clean any dust or dirt from the paper feeder and output tray.
- 3 Clean the PictureMate exterior with a soft, damp cloth.
- 4 Use a soft, dry cloth to clean the PictureMate photo viewer screen. Do not use liquid or chemical cleaners on it.

Caution: Never use a hard or abrasive brush, or alcohol or thinner for cleaning; they can damage the components and case.

Don't get water on the components and don't spray lubricants or oils inside PictureMate.

## ***Printing and Operation Problems***

**The On light and photo viewer screen don't turn on.**

- Press the I/⏻ **On** button to turn on PictureMate.
- Make sure the power cable and AC adapter are securely connected at both ends.
- Make sure your power outlet works and is not controlled by a wall switch or timer.
- If you're using the optional battery, it may not be charged. Connect the AC adapter and plug it into an electrical outlet to charge the battery.
- If you're using the optional battery, PictureMate automatically turns off after 15 minutes if it is not being used. Press the I/⏻ **On** button to turn it back on.



### **The photo viewer screen goes blank.**

The screen shuts off after 13 minutes if PictureMate is not used. Press any button to turn it back on.

### **PictureMate makes an unexpected noise after you install a photo cartridge.**

The first time you install the photo cartridge, PictureMate charges its print head for about three minutes. Wait until charging finishes before you turn it off, or it may charge improperly and use more ink the next time you turn it on.

### **Your PictureMate makes an unexpected noise when you turn it on or after it has been sitting for a while.**

PictureMate is performing routine maintenance.

### **PictureMate sounds as though it is printing, but nothing prints.**

- PictureMate may be preparing to print.
- The print head may need cleaning. See page 60.
- PictureMate won't work properly if it's tilted or at an angle. Place it on a flat, stable surface.

- Make sure paper is not jammed and is loaded correctly, and make sure the handle is not resting on the paper. See page 6.

### **The printer lid (paper support) snaps off.**

Replace the lid by inserting the hinges in the brackets.

### **Your memory card does not work correctly.**

- Insert only one card at a time.
- Make sure you are using a compatible memory card. See page 7.
- PictureMate recognizes and can print the first 999 photos on a memory card.
- Photos must be in JPEG or uncompressed TIFF format and taken with a DCF-compliant camera.
- PictureMate cannot read progressive-scan JPEG files or RAW files.
- Make sure to format your memory card in your camera.

### **Printing is too slow.**

- It takes a few moments for PictureMate to process your images before printing them.
- If PictureMate is in a hot or sunny location, move it to a cooler place and try printing again.

For faster printing, try these tips:

- Don't print more than 40 pictures at a time.
- Photos with borders print faster than borderless photos.
- Turn off special features such as color effects and red-eye reduction.
- JPEG photo files print faster than TIFF files.

### **Software Installation Problems**

- Follow the instructions beginning on page 34 to install your software. Don't connect PictureMate to your computer until you are instructed to.
- Close other programs, including screen savers and virus protection software, and try installing again.
- Make sure your system meets the requirements listed in your on-screen *User's Guide*.

- To print over a network, see the on-screen *User's Guide* for instructions on setting up printing.

### **Print Quality Problems**

#### **You see banding (light lines) in your prints.**

- The print head may need cleaning. See page 60.
- Be sure to print with the glossy or whiter side of the paper face up.
- The Print Pack may need replacing. See page 50.
- The print head may need aligning. See page 62.

#### **Your print is grainy.**

The print head may need aligning. See page 62.

#### **Your print is blurry or smeared.**

- Use PictureMate photo paper to ensure proper saturation, absorption of ink, and quality.
- Be sure to print with the glossy or whiter side of the paper face up.
- The print head may need cleaning. See page 60.
- The print head may need aligning. See page 62.

- Make sure your paper isn't damp or curled, or loaded face down (load it glossy or whiter side up). If it's damp or curled, load a new stack of paper.
- Remove each photo from the output tray after printing. Let each photo sit for a minute before handling it.

#### **Your print is faint or has gaps in the image.**

- The print head may need cleaning. See page 60.
- The photo cartridge may be old or low. See page 49 to replace it.
- Make sure your paper isn't damaged, old, dirty, or loaded face down. If it is, load new paper with the glossy or whiter side up.

#### **Colors in your photo are wrong or missing.**

- Make sure the Color Effect setting is not set to **Black & White** or **Sepia**. See page 22.
- The print head may need cleaning. See page 60.
- The photo cartridge may be old or low. See page 49 to replace it.
- Colors may change slightly after your print dries. Wait for 24 hours and check your photo again.

- Turn on the **Enhance** or **P.I.M.** setting. See page 19.
- Try manually adjusting the brightness, saturation, or sharpness. See page 20.

## ***Problems With Paper Feeding***

### **Paper doesn't eject fully or is wrinkled.**

The paper may be damp. Load new paper.

### **Paper doesn't feed correctly or jams.**

- If paper doesn't feed, remove it, separate the sheets slightly, and reload it between the edge guides. Slide the guides to the edge of the paper, but don't make them too tight. See page 6.
- If multiple pages feed at once, remove the paper, separate the sheets, and carefully reload it.
- If paper jams, remove any sheets loaded behind the jammed paper and press **OK** to eject the jammed paper. Don't pull out jammed paper from the top of PictureMate.
- Make sure the handle is not resting on the paper.

If paper loads incorrectly or jams frequently:

- Use new paper loaded with the glossy or whiter side up, and separate the sheets slightly.
- Load a maximum of 20 sheets.
- Make sure your paper is beneath the arrow on the edge guides.
- Don't load plain paper; this may damage PictureMate.
- Use only PictureMate photo paper or Epson Premium Photo Paper Glossy or Semigloss. (See page 4.)
- Store paper flat to help prevent curling.

## ***Miscellaneous Printout Problems***

### **PictureMate prints blank pages.**

The print head may need cleaning. See page 60.

### **The borders or layout are incorrect.**

- Select a different Layout setting. See page 17 (if printing directly from PictureMate) or page 39 (if printing from a computer).
- Crop your photo to enlarge and print only a part of it. See page 16.
- When you print borderless photos, PictureMate automatically expands your images. If your photos are cut off too much around the edges, you can adjust the amount of expansion. See page 21 (if printing directly from PictureMate) or page 39 (if printing from a computer).

## ***Where to Get Help***

### **Epson Technical Support**

Epson provides these technical support services:

#### **Internet Support**

Visit Epson's support website at [epson.com/support](http://epson.com/support) and select your product for solutions to common problems. You can download drivers and documentation, get FAQs and troubleshooting advice, or e-mail Epson with your questions.

#### **Speak to a Support Representative**

Before you call Epson for support, please have the following information ready:

- Product name (PictureMate Dash [PM 260] or PictureMate Zoom [PM 290])
- Product serial number (located on the bottom of PictureMate)
- Proof of purchase (such as a store receipt) and date of purchase
- Computer configuration
- Description of the problem

Then call:

- U.S.: (562) 276-7282, 6 AM to 8 PM, Pacific Time, Monday through Friday and 7 AM to 4 PM, Saturday.
- Canada: (905) 709-2567, 6 AM to 6 PM, Pacific Time, Monday through Friday.

Toll or long distance charges may apply.

### **Purchase Supplies and Accessories**

You can purchase genuine PictureMate 200 Series Print Packs and accessories from an Epson authorized reseller. To find the nearest reseller, call 800-GO-EPSON (800-463-7766). Or you can purchase online at [www.epsonstore.com](http://www.epsonstore.com) (U.S. sales) or [www.epson.ca](http://www.epson.ca) (Canadian sales).

### **Other Software Technical Support**

#### **ArcSoft PhotoImpression**

Telephone: (510) 440-9901, 8:30 AM to 5:30 PM, Pacific Time, Monday through Friday

Fax: (510) 440-1270

Online: [www.arcsoft.com](http://www.arcsoft.com)

E-mail: [support@arcsoft.com](mailto:support@arcsoft.com)

# Notices

## **Important Safety Instructions**

Before using your PictureMate, read the following safety instructions to make sure you use it safely and effectively:

- Be sure to follow all warnings and instructions marked on the printer.
  - If you use the printer in places where the use of printers is restricted, such as in airplanes or hospitals, follow all instructions in those places.
  - Do not insert objects through the slots in the printer.
  - Take care not to spill liquid on the printer and the AC adapter.
  - Do not put your hand inside the printer or touch the photo cartridge during printing.
  - Do not use aerosol products that contain flammable gases inside or around the printer. Doing so may cause fire.
  - Always turn the printer off using the I/⏻ **On** button. Do not unplug the printer or turn off the power to the outlet until the **On** light goes out.
  - Before transporting the printer, make sure that the photo cartridge is installed.
  - Leave the photo cartridge installed. Removing the cartridge can dehydrate the print head and may prevent the printer from printing or cause ink to leak out.
- Do not remove the memory card or turn off the printer while the computer and the memory card are communicating (when the memory card light is flashing).
  - The methods for using memory cards vary according to card type. Be sure to refer to the documentation packaged with your memory card for details.
  - Use only memory cards compatible with the printer (see page 8).
  - Place the printer on a flat, stable surface that extends beyond the base of the printer in all directions. The printer will not operate properly if it is tilted at an angle. If you place the printer by the wall, leave more than 4 inches (10 cm) between the back of the printer and the wall.
  - When storing or transporting the printer, do not tilt it, stand it on its side, or turn it upside down. Otherwise, ink may leak from the cartridge.
  - Leave enough space in front of the printer for the paper to be fully ejected.
  - Avoid places subject to rapid changes in temperature and humidity. Also, keep the printer and the AC adapter away from direct sunlight, strong light, water, or heat sources.

Caution: Keep PictureMate out of the sun and don't leave it in your car or other location where it can get too hot or too cold. Otherwise PictureMate may be damaged or ink may leak.



- Avoid places subject to dust, shock, or vibration.
- Leave enough room around the printer to allow for sufficient ventilation.
- Place the AC adapter near a wall outlet where the plug can be easily unplugged.
- Do not place or store the printer, the AC adapter, or the optional battery outdoors.
- Do not block or cover the vents and openings in the printer.
- Power supply cords should be placed to avoid abrasions, cuts, fraying, crimping, and kinking. Do not place objects on top of power-supply cords and do not allow the AC adapter or power-supply cords to be stepped on or run over. Be particularly careful to keep all power-supply cords straight at the ends and the points where they enter and leave the AC adapter.
- Use only the power-supply cord that comes with this product. Use of another cord may result in fire or electrical shock, or injury.
- The AC adapter model A381H is designed for use with the printer with which it was included. Do not attempt to use it with other electronic devices unless specified.
- Use only the type of power source indicated on the AC adapter's label, and always supply power directly from a standard domestic electrical outlet with the AC power cord that meets the relevant local safety standards.
- Avoid using outlets on the same circuit as photocopiers or air control systems that regularly switch on and off.
- Avoid using electrical outlets controlled by wall switches or automatic timers.
- Keep the entire computer system away from potential sources of electromagnetic interference, such as loudspeakers or the base units of cordless telephones.
- Do not use a damaged or frayed power cord, or the AC adapter or optional battery if damaged.
- If you use an extension cord with the printer, make sure that the total ampere rating of the devices plugged into the extension cord does not exceed the cord's ampere rating. Also, make sure that the total ampere rating of all devices plugged into the wall outlet does not exceed the wall outlet's ampere rating.
- Never disassemble, modify, or attempt to repair the AC adapter, power cord, printer, and options by yourself except as specifically explained in the printer's guides. Doing so may result in injury, electric shock, or fire.
- Unplug the printer and the AC adapter, remove the optional battery from the printer, and refer servicing to qualified service personnel under the following conditions:
  - The power cord or plug is damaged; liquid has entered the printer; the printer, the AC adapter, or the optional battery has been dropped or the casing damaged; the printer, the AC adapter, or the optional battery does not operate normally or exhibits a distinct change in performance. (Do not adjust controls that are not covered by the operating instructions.)
- Do not use with wet hands.

**WARNING:** The cords included with this product contain chemicals, including lead, known to the State of California to cause birth defects or other reproductive harm. **Wash hands after handling.** (Provided in accordance with Proposition 65 in Cal. Health & Safety Code §25249.5 et seq.)

### **Photo Cartridge Safety Instructions**

- Keep photo cartridges out of the reach of children and do not drink the ink.
- Do not shake the photo cartridge after removing it from the bag; this can cause leakage.
- Be careful when you handle used photo cartridges, as there may be some ink remaining around the ink supply ports. If ink gets onto your skin, wash the area thoroughly with soap and water. If ink gets into your eyes, flush them immediately with water. If discomfort or vision problems continue after a thorough flushing, see a doctor immediately.
- Do not remove or tear the label on the cartridge; this can cause leakage.
- Do not dismantle photo cartridges or try to refill them. This could damage the print head.
- Install the photo cartridge immediately after you remove it from its package. If you leave a cartridge unpacked for a long time before using it, normal printing may not be possible.
- Do not use a photo cartridge beyond the date printed on the cartridge carton; otherwise, it may result in reduced print quality. For best results, use up the photo cartridge within six months of installing it.
- After bringing a photo cartridge inside from a cold storage site, allow it to warm up at room temperature for at least three hours before using it.
- Store photo cartridges in a cool, dark place.
- Store each photo cartridge so that the bottom of its packaging faces down.
- Do not touch the green IC chip on the side of the cartridge. Doing so may prevent normal operation and printing.
- The IC chip on the photo cartridge retains a variety of cartridge-related information, such as the amount of ink remaining, so that the cartridge may be removed and reinstalled freely. However, each time the cartridge is inserted, some ink is consumed because the printer automatically performs a reliability check.
- If you remove the photo cartridge for later use, protect the ink supply ports from dirt and dust and store it in the same environment as the printer. A valve in the ink supply ports makes covers or plugs unnecessary, but the ink may stain items that come into contact with this area of the cartridge. Do not touch the ink supply ports or the surrounding area.



### ***Photo Viewer Screen Safety Instructions***

- The screen contains a few small bright or dark spots. These are normal and do not mean that the screen is damaged in any way.
- Only use a dry, soft cloth to clean the screen. Do not use liquid or chemical cleansers.
- If the screen is damaged, contact your dealer. If the liquid crystal solution gets on your hands, wash them thoroughly with soap and water. If the liquid crystal solution gets into your eyes, flush them immediately with water. If discomfort or vision problems remain after a thorough flushing, see a doctor immediately.
- Please consult your state and local regulations regarding disposal or recycling. Do not put in the trash.

### ***Battery Safety Instructions***

- If battery acid gets into your eyes or on your skin, immediately rinse the affected area thoroughly with water and seek medical treatment. If a battery is swallowed, seek medical treatment immediately.
- Use only an Epson Li-ion battery model D121A for this printer according to the directions in the user documentation. Replacing the battery with an incorrect model may cause an explosion.
- Use only AC adapter model A381H to charge the battery and operate the printer.
- Do not charge or use the battery with devices other than the specified product. Using the battery with other devices

may damage the battery or other devices, or may cause an explosion.

- To protect against short circuits, do not remove the outside case of the battery.
- Do not handle the battery with wet hands or use it near water.
- Do not expose the battery to water or high humidity.
- Do not drop, puncture, disassemble, mutilate, or short-circuit the battery.
- Do not place the battery near or into fire or water.
- Do not use a battery that is leaking or damaged in any way.
- Do not charge the battery on devices except this product.
- Do not charge the battery near open flame or in very hot locations.
- Keep the battery away from heat sources.
- Do not leave the battery in a vehicle to prevent the battery from overheating.
- Do not insert objects into any openings as they may touch dangerous voltage points or short-circuit components.
- Prevent the battery from coming into contact with metal objects that could short-circuit it, such as coins or keys.
- Do not solder wires or terminals directly to the battery.
- Do not touch battery terminals.
- Keep the battery away from open flame if it leaks or smells strange.
- If overheating, discoloration, or deformation occur, remove the battery from this product and do not use it.

- Charge the battery before using it if it has not been used for a long period.
- When not using the printer for a long period of time, remove the battery from the printer and store it separately to avoid over-discharging the battery.
- Do not store the battery where the temperature or humidity is very high.
- Store the battery out of children's reach.
- Before disposing of the battery, make sure you discharge it completely.

Warning: Do not dispose of batteries as ordinary refuse. Instead, dispose of them in a collection or recycle box in accordance with local laws. Do not incinerate or dispose of the battery in fire.



For users in the United States and Canada: This mark indicates that the battery will be recycled by RBRC. When you dispose of the battery, contact RBRC.

## ***Epson America, Inc. Limited Warranty***

**What Is Covered:** Epson America, Inc. ("Epson") warrants to the original retail purchaser that the Epson printer covered by this limited warranty statement, if purchased and operated only in the United States or Canada, will be free from defects in workmanship and materials for a period of one (1) year from the date of original purchase. For warranty service, you must provide proof of the date of original purchase.

**What Epson Will Do To Correct Problems:** Should your Epson printer prove defective during the warranty period, please call the Epson Connection<sup>SM</sup> at (562) 276-7282 (U.S.) or (905) 709-2567 (Canada) for warranty repair instructions and return authorization. An Epson service technician will provide telephone diagnostic service to determine whether the printer requires service. If service is needed, Epson will, at its option, exchange or repair the printer without charge for parts or labor. If Epson authorizes an exchange for the defective unit, Epson will ship a replacement printer to you, freight prepaid, so long as you use an address in Canada or the U.S. (excluding Puerto Rico and U.S. Possessions). Shipments to other locations will be made freight collect. You are responsible for securely packaging the defective unit and returning it to Epson within five (5) working days of receipt of the replacement. Epson requires a debit or a credit card number to secure the cost of the replacement printer in the event that you fail to return the defective one. If your printer is being repaired, Epson will direct you to send your printer to Epson or its authorized service center, where the printer will be fixed and sent back to you. You are responsible for packing the printer and for all costs to and from the Epson authorized service center. When warranty service involves the exchange of the printer or a part, the item replaced becomes Epson property. The replacement printer or part may be new or refurbished to the Epson standard of quality, and, at Epson's option, may be another model of like kind and quality. Epson's liability for replacement of the covered printer will not exceed the original retail selling price of the covered printer. Exchange products and parts assume the remaining warranty period of your original product covered by this limited warranty.

**What This Warranty Does Not Cover:** This warranty does not apply to refurbished or reconditioned products. This warranty covers only normal use in the United States and Canada. Using this product for continuous production or similar high duty purposes is not considered normal use; damage, maintenance or service from such use will not be covered under this warranty. This warranty is not transferable. This warranty does not cover any color change or fading of prints or reimbursement of materials or services required for reprinting. This warranty does not cover damage to the Epson product caused by parts or supplies not manufactured, distributed or certified by Epson. This warranty does not cover ribbons, ink cartridges or third party parts, components, or peripheral devices added to the Epson product after its shipment from Epson, e.g., dealer or user-added boards or components. Epson is not responsible for warranty service should the Epson label or logo or the rating label or serial number be removed or should the product fail to be properly maintained or fail to function properly as a result of misuse, abuse, improper installation, neglect, improper shipping, damage caused by disasters such as fire, flood, and lightning, improper electrical current, software problems, interaction with non-Epson products, or service other than by an Epson Authorized Servicer. If a claimed defect cannot be identified or reproduced, you will be held responsible for the costs incurred.

THE WARRANTY AND REMEDY PROVIDED ABOVE ARE EXCLUSIVE AND IN LIEU OF ALL OTHER EXPRESS OR IMPLIED WARRANTIES INCLUDING, BUT NOT LIMITED TO, THE IMPLIED WARRANTIES OF MERCHANTABILITY, NON-INFRINGEMENT OR FITNESS FOR A PARTICULAR PURPOSE. SOME LAWS DO NOT ALLOW THE EXCLUSION OF IMPLIED

WARRANTIES. IF THESE LAWS APPLY, THEN ALL EXPRESS AND IMPLIED WARRANTIES ARE LIMITED TO THE WARRANTY PERIOD IDENTIFIED ABOVE. UNLESS STATED HEREIN, ANY STATEMENT OR REPRESENTATIONS MADE BY ANY OTHER PERSON OR FIRM ARE VOID. EXCEPT AS PROVIDED IN THIS WRITTEN WARRANTY, NEITHER EPSON AMERICA, INC. NOR ITS AFFILIATES SHALL BE LIABLE FOR ANY LOSS, INCONVENIENCE, OR DAMAGE, INCLUDING DIRECT, SPECIAL, INCIDENTAL OR CONSEQUENTIAL DAMAGES, RESULTING FROM THE USE OR INABILITY TO USE THE EPSON PRODUCT, WHETHER RESULTING FROM BREACH OF WARRANTY OR ANY OTHER LEGAL THEORY.

In Canada, warranties include both warranties and conditions.

Some jurisdictions do not allow limitations on how long an implied warranty lasts, and some jurisdictions do not allow the exclusion or limitation of incidental or consequential damages, so the above limitations and exclusions may not apply to you. This warranty gives you specific legal rights and you may have other rights which vary from jurisdiction to jurisdiction.

To find the Epson Authorized Reseller nearest you, visit our website at: <http://www.epson.com>.

To find the Epson Customer Care Center nearest you, visit [epson.com/support](http://epson.com/support).

You can also write to: Epson America, Inc., P.O. Box 93012, Long Beach, CA 90809-3012

## ***How Many Photos Will I Get From a PictureMate Print Pack?***

Epson has packaged the PictureMate Photo Cartridge with a quantity of 4 × 6 PictureMate Photo Paper, so that purchasing supplies for PictureMate is convenient and affordable. The number of sheets of photo paper in your PictureMate Print Pack is stated on the Print Pack's box. The photo ink cartridge in the Print Pack contains enough ink to allow borderless, color printing of about the stated number of sheets.

Our estimate of the number of photos you can print with a PictureMate Print Pack is based on test printing with a range of 20 different color photos. Actual yields will vary based on images printed, print settings, paper type, frequency of use and temperature. For example, printing many copies of the same photo, or printing many black and white or sepia photos, may result in fewer photos per PictureMate Photo Cartridge. Also, the PictureMate Photo Cartridge once installed should be replaced with a new one within 6 months. For print quality, a variable amount of ink remains in the cartridge after the "Replace Print Pack" indicator comes on.

You may be able to print more photos with a PictureMate Photo Cartridge than the number of sheets of photo paper in your PictureMate Print Pack. In this case the cartridge monitor indicates the cartridge can still be used. You can continue printing with paper from another PictureMate Print Pack or Epson Premium Photo Paper Glossy in the 4 × 6 borderless size which is available from many resellers or [Epsonstore.com](http://Epsonstore.com). There are other photo papers available but most are not formulated to be fully compatible with the

PictureMate Photo Cartridge. Using other papers may result in poor color reproduction, print quality problems or more fading.

Both a PictureMate Photo Cartridge and some PictureMate Photo Paper were included in the box with your PictureMate printer. The included cartridge contains enough ink to allow borderless, color printing of about the number of included paper sheets. The other comments above also apply to the cartridge and paper included in the printer box.

## ***PictureMate Print Pack Satisfaction Guarantee***

If you are dissatisfied because you receive fewer prints than the number of sheets of paper stated on your PictureMate Print Pack, you can return the remaining sheets of paper with the dated sales receipt and UPC code from the PictureMate Print Pack packaging within one year of purchase and Epson will give you a pro-rated refund for the number of sheets returned, plus a maximum of \$1.10 for postage. The amount of the refund depends on the number of sheets stated on your Print Pack and the Print Pack's suggested retail price. For example, if you purchased a 150-sheet Print Pack of glossy photo paper with a suggested retail price of \$39.99, Epson will refund 27 cents per sheet returned (\$39.99 divided by 150 sheets equals 27 cents per sheet). This Satisfaction Guarantee is a prorated refund that covers only end-user claims in the U.S. and Canada. It does not cover use of any non-Epson ink or paper, commercial use of the printer, or paper consumed by proofs or printing errors.

This Satisfaction Guarantee also applies to the PictureMate Photo Cartridge and PictureMate Photo Paper which were included in the box with your PictureMate printer, if you are dissatisfied because you receive fewer prints with the cartridge than the number of sheets included. The per-sheet refund in that case is 27 cents.

### **Refund Procedure**

Please follow this refund procedure:

- 1** Print out the PictureMate Print Pack Satisfaction Guarantee Form, found on the web page below, or request this form to be mailed to you by calling (562) 276-1347 for U.S.A. and Puerto Rico or (905) 709-8676 for Canadian residents.

[www.mypicturemate.com/satisfactionguarantee](http://www.mypicturemate.com/satisfactionguarantee)

- 2** Send the following items to:

PictureMate Print Pack Satisfaction Guarantee  
P.O. Box 400067  
EL Paso, TX 88540-0067

- Fully completed PictureMate Print Pack Satisfaction Guarantee Form
- Original UPC code of PictureMate Print Pack
- Copy of PictureMate Print Pack receipt
- Remaining PictureMate Print Pack paper from the original PictureMate Print Pack.

If you are making a claim based on the number of prints you were able to make with the initial cartridge and paper which were included in the box with your PictureMate printer, please submit:

- Fully completed PictureMate Print Pack Satisfaction Guarantee Form
- Copy of Original UPC code of PictureMate printer
- Copy of PictureMate printer receipt
- Remaining paper which was included in the PictureMate printer box

Customer claim status inquiries: (800) 305-7305.

### ***Declaration of Conformity***

According to 47CFR, Part 2 and 15 for Class B Personal Computers and Peripherals; and/or CPU Boards and Power Supplies used with Class B Personal Computers:

We: Epson America, Inc.

Located at: MS: 3-13  
3840 Kilroy Airport Way  
Long Beach, CA 90806-2469  
Telephone: (562) 290-5254

Declare under sole responsibility that the product identified herein, complies with 47CFR Part 2 and 15 of the FCC rules as a Class B digital device. Each product marketed is identical to the representative unit tested and found to be compliant with the standards. Records maintained continue to reflect the equipment being produced can be expected to be within the variation accepted, due to quantity production and testing on

a statistical basis as required by 47CFR §2.909. Operation is subject to the following two conditions: (1) this device may not cause harmful interference, and (2) this device must accept any interference received, including interference that may cause undesired operation.

Trade Name: Epson

Type of Product: Ink Jet Printer

Model: B382D (PictureMate Zoom)  
B382C (PictureMate Dash)

## ***FCC Compliance Statement***

### **For United States Users**

This equipment has been tested and found to comply with the limits for a Class B digital device, pursuant to Part 15 of the FCC Rules. These limits are designed to provide reasonable protection against harmful interference in a residential installation. This equipment generates, uses, and can radiate radio frequency energy and, if not installed and used in accordance with the instructions, may cause harmful interference to radio or television reception. However, there is no guarantee that interference will not occur in a particular installation. If this equipment does cause interference to radio and television reception, which can be determined by turning the equipment off and on, the user is encouraged to try to correct the interference by one or more of the following measures:

- Reorient or relocate the receiving antenna.
- Increase the separation between the equipment and receiver.
- Connect the equipment into an outlet on a circuit different from that to which the receiver is connected.
- Consult the dealer or an experienced radio/TV technician for help.

**WARNING:** The connection of a non-shielded equipment interface cable to this equipment will invalidate the FCC Certification of this device and may cause interference levels which exceed the limits established by the FCC for this equipment. It is the responsibility of the user to obtain and use a shielded equipment interface cable with this device. If this equipment has more than one interface connector, do not leave cables connected to unused interfaces. Changes or modifications not expressly approved by the manufacturer could void the user's authority to operate the equipment.

### **For Canadian Users**

This Class B digital apparatus complies with Canadian ICES-003.

*Cet appareil numérique de la classe B est conforme à la norme NMB-003 du Canada.*

## ***Copyright Notice***

All rights reserved. No part of this publication may be reproduced, stored in a retrieval system, or transmitted in any form or by any means, electronic, mechanical, photocopying, recording, or otherwise, without the prior written permission

of Seiko Epson Corporation. The information contained herein is designed only for use with this Epson product. Epson is not responsible for any use of this information as applied to other printers.

Neither Seiko Epson Corporation nor its affiliates shall be liable to the purchaser of this product or third parties for damages, losses, costs, or expenses incurred by purchaser or third parties as a result of: accident, misuse, or abuse of this product or unauthorized modifications, repairs, or alterations to this product, or (excluding the U.S.) failure to strictly comply with Seiko Epson Corporation's operating and maintenance instructions.

Seiko Epson Corporation shall not be liable for any damages or problems arising from the use of any options or any consumable products other than those designated as Original Epson Products or Epson Approved Products by Seiko Epson Corporation.

### ***A Note Concerning the Responsible Use of Copyrighted Materials***

Epson encourages each user to be responsible and respectful of the copyright laws when using any Epson product. While some countries' laws permit limited copying or reuse of copyrighted material in certain circumstances, those circumstances may not be as broad as some people assume. Contact your legal advisor for any questions regarding copyright law.

### ***Trademarks***

Epson, PictureMate, PRINT Image Matching, and the PRINT Image Matching logo are registered trademarks, and Exceed Your Vision, PictureMate Dash, PictureMate Zoom, USB DIRECT-PRINT, and the USB DIRECT-PRINT logo are trademarks of Seiko Epson Corporation.

Epson Connection is a service mark of Epson America, Inc. SD is a trademark.

SDHC is a trademark.

Memory Stick, Memory Stick Duo, Memory Stick PRO, Memory Stick PRO Duo, Memory Stick Micro, MagicGate Memory Stick, and MagicGate Memory Stick Duo are trademarks of Sony Corporation.

xD-Picture Card is a trademark of Fuji Photo Film Co., Ltd.

DPOF is a trademark of CANON INC., Eastman Kodak Company, Fuji Photo Film Co., Ltd., and Matsushita Electric Industrial Co., Ltd.

The Bluetooth trademarks are owned by Bluetooth SIG, Inc., U.S.A. and licensed to Seiko Epson Corporation.

General Notice: Other product names used herein are for identification purposes only and may be trademarks of their respective owners. Epson disclaims any and all rights in those marks.

© 2007 Epson America, Inc. 7/07

CPD-23839R1 oss

# Index

## A

Accessories, 4, 30, 49, 53, 68

Adapter

Bluetooth, 30 to 32

memory card, 8

Aligning print head, 62 to 63

All photos, printing, 11 to 12

ArcSoft PhotoImpression, 37, 38, 39, 68

Auto Cleaning, 60 to 61, 65

Auto Correction, 19 to 21, 41, 44

Auto shutoff, 10, 55, 64

## B

Banding, fixing, 60 to 61, 65

Basic printing

Macintosh, 46 to 48

Windows, 39 to 45

Battery

charging, 54 to 55

installing, 54

removing, 55

safety instructions, 72 to 73

status, 55

Black-and-white printing, 22, 41, 44, 47

Blank pages, 67

Blank screen, 10, 55, 64

Bluetooth

connecting adapter, 31

disconnecting adapter, 32

printing using, 30 to 31

Blurry prints, 65 to 66

Border

layout, 17 to 18, 44, 46

problems, 67

Borderless

layout, 17 to 18, 44, 46

problems, 67



Borderless expansion, 21 to 22, 44, 47

Brightness, adjusting, 20 to 21

Button

Display, 10, 16, 23

Menu, 15 to 26

On, 7, 34, 38, 53, 63, 69

Open, 6, 7

Save, 26

## C

Cable

power, 53, 54

USB, 29, 30, 34, 36 to 37, 53

Camera

printing from, 28 to 29

printing text from, 24

selected photos (DPOF), 13

Cancelling printing

control panel, 12

Macintosh, 48

Windows, 42, 45

Care of photos, 14

Care of PictureMate, 60 to 63

Carrying PictureMate, 53

Cartridge, photo see Photo cartridge

Case, optional, 53

CD

ejecting, 33

installing software from, 34 to 39

printing from, 29 to 33

saving photos to, 25 to 27

selecting as source, 33

types, 25

CD Index layout, 17 to 18, 26, 33

Cell phone, printing from, 30 to 31

Charging

battery, 54 to 55

photo cartridge, 52, 64

Checking nozzles, 61

Choosing photos, 9 to 13

Cleaning

PictureMate, 63

print head, 60 to 61, 65

Color

effects, 22

fixing, 19 to 21, 41, 44

problems, 66

## Compatible

- memory cards, 8
- photo formats, 4

## Computer

- Bluetooth printing, 30 to 32
- connecting to PictureMate, 34 to 37
- installing software on, 34 to 39
- printing from, 39 to 48
- saving photo files to and from, 34
- software installation problems, 65

## Copies, number of

- control panel, 10 to 11
- Macintosh, 47
- Windows, 44

## Correcting photos, 19 to 21

## Cropping, 16, 21 to 22

## Customizing PictureMate, 56 to 59

## Cut-off photos, fixing, 21 to 22, 44, 47

## D

### Date stamp, 21

### Date, printing photos by, 12

### Decorations, 23

### Default settings, 59

### Digital Camera Correction setting, Windows, 44

### Digital Size layout, 17 to 18

### Direct Print Settings, 29

### Display button, 10, 16, 23

### Display preferences, 9

### Displaying prints, 14

### DOC (Declaration of Conformity), 76 to 77

### Door, cartridge, 50 to 52

### DPOF (Digital Print Order Format), 13

### Drive, built-in CD, see CD

### Drive, external, see External device

## E

### Effects, color, 22

### Enhance Fine Details setting, 44, 47

### Enhancing photos, 19 to 21

### Epson

- accessories, 4, 30, 49, 53, 68

- technical support, 68

### Exif Print, 20

### Expansion, borderless, 21 to 22, 44, 47

## External device

- port, 29 to 30
- printing from, 28 to 30
- selecting as source, 30

## F

- Faint prints, 66
- FCC compliance, 77
- File formats, 4
- Fixing photos, 19 to 21, 41, 44
- Flash memory drive, printing from, 29 to 30

## G

- Gaps in image, 60 to 61, 66
- Grainy prints, 65

## H

- Half-page photos, 17 to 18
- Help
  - control panel, 15
  - Epson, 68

## I

- Icons on screen, 55
- ID photos, 17 to 18
- Image
  - formats, 4
  - quality, 19 to 21
  - quality problems, 65 to 66
- Incorrect
  - colors, 66
  - margins, 21 to 22, 67
- Index, CD, 17 to 18, 26, 33
- Ink, *see* Photo cartridge
- Instructions, control panel, 15
- Internet support, 68

## J

- Jammed paper, 66 to 67
- JPEG, 4

## **L**

Landscape orientation, 46

Layout

Macintosh, 46

problems, 67

settings, 17 to 18

Windows, 44

Lever, cartridge, 50 to 52

License agreement, 35, 38

Lights

memory card, 7 to 8

On, 63, 69

Lines in photos, fixing, 60 to 61, 65

Loading paper, 6 to 7, 67

Lock, cartridge, 50 to 52

## **M**

Macintosh

basic printing, 46 to 48

Bluetooth printing, 31

cancelling printing, 48

installing software for, 37 to 39, 65

Printer Setup Utility, 38 to 39

Maintenance, 60 to 63

Manuals, 4, 36, 38

Margins

incorrect, 21 to 22, 67

selecting, 17 to 18

Memory card

adapters, 8

compatibility, 8

light, 7 to 8

problems, 64

removing, 8, 34

Menu button, 15 to 26

Mini-wallet photos, 17 to 18

Missing colors, 66

## **N**

Network installation, 65

Noise, PictureMate, 64

Nozzles

checking, 61

cleaning, 60 to 61, 65

## **O**

On button, 7, 34, 38, 53, 63, 69

On light, 63, 69

Open button, 6, 7

Orientation setting, Macintosh, 46

Output tray, 6, 53

## **P**

Packing PictureMate, 53

Page Setup window, 46

Paper

- buying, 4, 49, 68

- feeding problems, 66 to 67

- jam, 66 to 67

- loading, 6 to 7, 67

- orientation, 46

- output tray, 6, 53

- size, 7, 46

- storing, 14

- support, 6 to 7, 53

Passport photos, 17 to 18

PDA, printing from, 30 to 31

Photo

- choosing, 9 to 13

- correction, 19 to 21, 41, 44

- decorating, 23

- displaying, 14

- DPOF, 13

- fixing, 19 to 21, 41, 44

- fixing cut off, 21 to 22, 44, 47

- formats, 4

- paper, *see* Paper

- quality problems, 65 to 66

- quality, adjusting, 19 to 21, 41, 44

- remove red eye, 18

- rotating, 24

- saving to computer, 34

- slideshow, 13

- storing, 14

- viewing, 9 to 10, 13

## Photo cartridge

- buying, 4, 49, 68
- charging, 52
- door, 50 to 52
- information, 75 to 76
- lock, 50 to 52
- release lever, 50 to 52
- replacing, 49 to 52
- safety instructions, 71
- status, 52

## Photo viewer screen

- adjusting angle, 9
- blank, 10, 55, 64
- display options, 9
- icons, 55
- instructions on, 15
- problems, 64
- safety instructions, 72
- using, 9 to 63

PhotoImpression, ArcSoft, 37, 38, 39, 68

PictBridge camera, 28 to 29

Picture and Fax Viewer, Windows, 39 to 45

PIM (PRINT Image Matching), 20

Portrait orientation, 46

## Power

- battery, 54 to 55, 72 to 73
- problems, 63
- saving, 10, 55
- turning off, 53, 69
- turning on, 7, 34, 38, 63

Power cable, 53, 54

Preferences, setting, 56 to 59

Previewing printing, 11 to 13, 44

## Print

- preview, 11 to 13, 44
- speed, increasing, 65

## Print head

- aligning, 62 to 63
- cleaning, 60 to 61, 65

PRINT Image Matching, 20

## Print Pack

- buying, 4, 49, 68
- information, 75 to 76
- replacing, 49 to 52
- status, 52

Print quality problems, 65 to 66

Printer Setup Utility, Macintosh, 38 to 39

## Printing

- all photos, 11 to 12
- basic, 39 to 48
- black-and-white, 22, 41, 44, 47
- Bluetooth, 30 to 31
- cancelling, 12, 45, 48
- from camera, 28 to 29
- from CD, 29 to 33
- from external device, 28 to 30
- individual photos, 10 to 11
- Macintosh, 46 to 48
- photos by date, 12, 21
- preview, 11 to 13, 44
- problems, 63 to 65
- Windows, 39 to 45
- wireless, 30 to 31

## Problems

- border or layout, 67
- color, 66
- memory card, 64
- paper feeding, 66 to 67
- paper jam, 66 to 67
- photo viewer screen, 64
- power, 63
- print quality, 65 to 66
- printing, 63 to 65
- slow printing, 65
- software installation, 65
- Proof Sheet layout, 17 to 18

## Q

- Quality problems, 65 to 66
- Quality, adjusting, 19 to 21, 41, 44

## R

- Red-eye reduction, 18
- Release lever, 50 to 52
- Removing battery, 55
- Replacing photo cartridge, 49 to 52
- Resetting preferences, 56 to 59
- Resolution, 4
- Rotating photos, 24

## S

- Safety instructions, 69 to 73
- Saturation, adjusting, 20 to 21
- Save button, 26
- Saving power, 10, 55
- Screen
  - adjusting angle, 9
  - blank, 10, 55, 64
  - display options, 9
  - icons, 55
  - instructions on, 15
  - problems, 64
  - safety instructions, 72
  - using, 9 to 63
- Select All, 11 to 12

- Sepia, 22, 41, 44, 47
- Service, 68
- Settings, default, 59
- Several photos, selecting, 10 to 11
- Sharpness, adjusting, 20 to 21
- Size, paper, 7, 46
- Slideshow, 13
- Slow printing, 65
- Smeared prints, 65 to 66
- Software, installing, 34 to 39, 65
- Source, selecting, 30, 33
- Speed, increasing print, 65
- Stamp, date, 21
- Start Here sheet, 4
- Stopping printing
  - control panel, 12
  - Macintosh, 48
  - Windows, 42, 45
- Storing paper and prints, 14
- Supplies, 4, 30, 49, 53, 68
- Support, paper, 6 to 7, 53
- Support, technical, 68



## **T**

- Technical support, 68
- Thumb drive, printing from, 29 to 30
- TIFF, 4
- Transporting PictureMate, 53
- Troubleshooting, 60 to 67
- Turning printer on or off, 7, 34, 53, 63, 69

## **U**

- USB cable, 29, 30, 34, 36 to 37, 53
- USB DIRECT-PRINT camera, 28 to 29
- User's Guide, 4, 36, 38

## **W**

- Wallet-size photos, 17 to 18
- Warranty, 73 to 74
- Where to get help, 68
- Windows
  - basic printing, 39 to 45
  - Bluetooth printing, 31
  - cancelling printing, 45
  - installing software for, 34 to 37, 65
- Wireless printing, 30 to 31

## **Z**

- Zip disk, printing from, 29 to 30
- Zooming in and out, 16, 23

## Getting to Know PictureMate

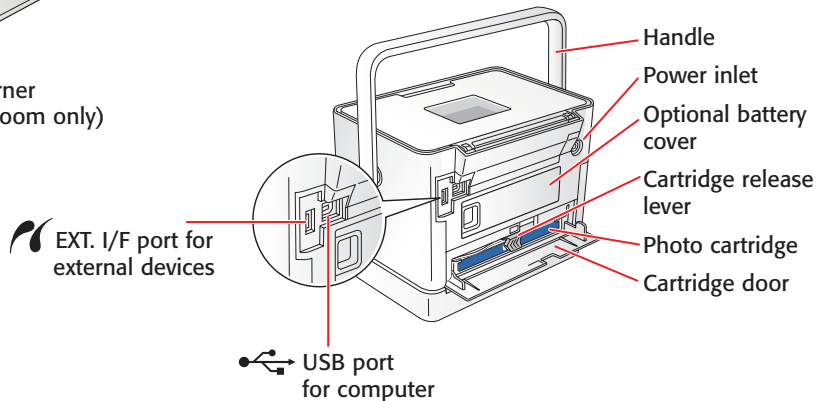
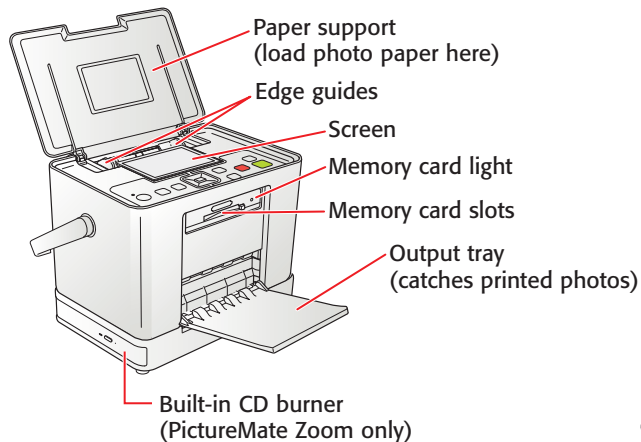

# Need a New Print Pack?

The PictureMate 200 Series Print Pack has everything you need to print in one box: photo paper and a photo cartridge.

The following Print Packs and accessories are available:



Product	Part Number
Glossy photo paper (150 sheets) and photo cartridge	T5846
Matte photo paper (100 sheets) and photo cartridge	T5845-M
PictureMate rechargeable battery	C12C831082
PictureMate carrying case	PMBAG06
Epson® Bluetooth® Photo Print Adapter	C12C824383

You can also buy a Print Pack and other PictureMate accessories from an Epson authorized reseller. To find the nearest reseller, call 800-GO-EPSON (800-463-7766). Or you can purchase online at [www.epsonstore.com](http://www.epsonstore.com) (U.S. sales) or [www.epson.ca](http://www.epson.ca) (Canadian sales).

For more PictureMate information, special offers, and related accessories, visit [www.MyPictureMate.com](http://www.MyPictureMate.com).