

EPSON®

EPSON STYLUS™ COLOR

600

User's Guide



Printed on recycled paper with at least 10% post-consumer content.

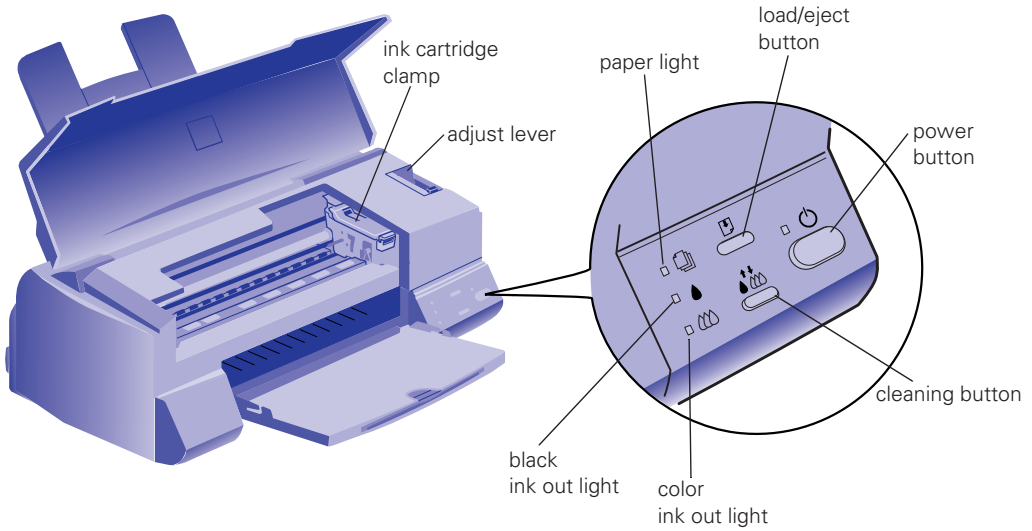
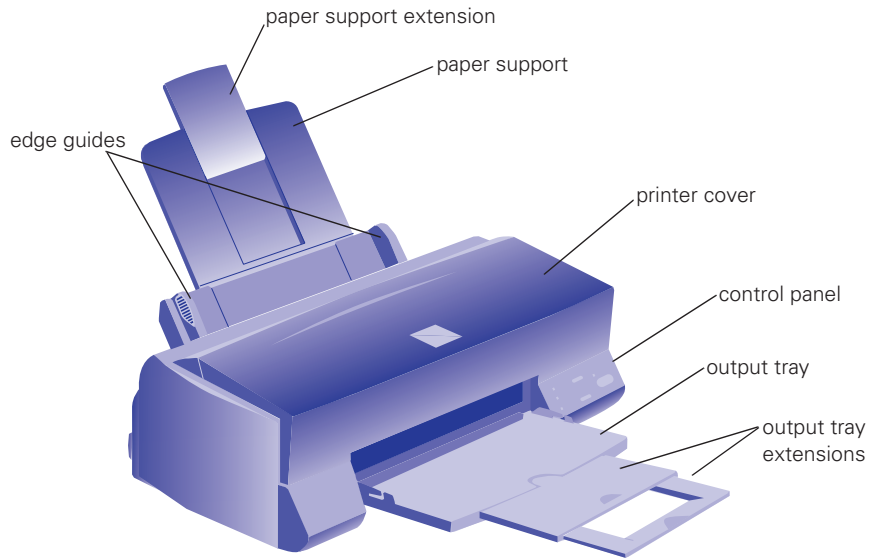

All rights reserved. No part of this publication may be reproduced, stored in a retrieval system, or transmitted in any form or by any means, electronic, mechanical, photocopying, recording, or otherwise, without the prior written permission of SEIKO EPSON CORPORATION. The information contained herein is designed only for use with this EPSON printer. EPSON is not responsible for any use of this information as applied to other printers.

Neither SEIKO EPSON CORPORATION nor its affiliates shall be liable to the purchaser of this product or third parties for damages, losses, costs, or expenses incurred by purchaser or third parties as a result of: accident, misuse, or abuse of this product or unauthorized modifications, repairs, or alterations to this product, or (excluding the U.S.) failure to strictly comply with SEIKO EPSON CORPORATION's operating and maintenance instructions.

SEIKO EPSON CORPORATION shall not be liable for any damages or problems arising from the use of any options or any consumable products other than those designated as Original EPSON Products or EPSON Approved Products by SEIKO EPSON CORPORATION.

EPSON, EPSON Stylus, and ESC/P are registered trademarks and ESC/P 2 is a trademark of SEIKO EPSON CORPORATION. EPSON SoundAdvice, EPSON FaxAdvice, and EPSON Perfect Picture are trademarks of Epson America, Inc.

General Notice: Other product names used herein are for identification purposes only and may be trademarks of their respective owners. EPSON disclaims any and all rights in those marks.

The ENERGY STAR emblem does not represent EPA endorsement of any product or service.

Copyright © 1997 by Epson America, Inc.

400667301D0
8/97

FCC Compliance Statement For United States Users

This equipment has been tested and found to comply with the limits for a Class B digital device, pursuant to Part 15 of the FCC Rules. These limits are designed to provide reasonable protection against harmful interference in a residential installation. This equipment generates, uses, and can radiate radio frequency energy and, if not installed and used in accordance with the instructions, may cause harmful interference to radio or television reception. However, there is no guarantee that interference will not occur in a particular installation. If this equipment does cause interference to radio and television reception, which can be determined by turning the equipment off and on, the user is encouraged to try to correct the interference by one or more of the following measures.

- Reorient or relocate the receiving antenna.
- Increase the separation between the equipment and receiver.
- Connect the equipment into an outlet on a circuit different from that to which the receiver is connected.
- Consult the dealer or an experienced radio/TV technician for help.

WARNING

The connection of a non-shielded equipment interface cable to this equipment will invalidate the FCC Certification of this device and may cause interference levels which exceed the limits established by the FCC for this equipment. It is the responsibility of the user to obtain and use a shielded equipment interface cable with this device. If this equipment has more than one interface connector, do not leave cables connected to unused interfaces. Changes or modifications not expressly approved by the manufacturer could void the user's authority to operate the equipment.

For Canadian Users

This Class B digital apparatus meets all requirements of the Canadian Interference-Causing Equipment Regulations.

Cet appareil numérique de la classe B respecte toutes les exigences du Règlement sur le matériel brouilleur du Canada.

Contents

Introduction

Windows System Requirements	2
Macintosh System Requirements	3
How To Use Your Manuals	4
Warnings, Cautions, Notes, and Tips	5
Where To Get Help	5
ENERGY STAR Compliance	6
Energy-saving Tips	7
Important Safety Instructions	7

1 Basic Printing

Printing from Windows	1-1
Setting Printer Options from Windows Applications	1-2
Setting Default Printer Options	1-4
Checking Printer Status	1-6
Printing from a Macintosh	1-7
Printing from DOS	1-9
Choosing Paper and Other Media	1-10
What To Do When the Printer Lights Flash	1-11
Using the Control Panel Buttons	1-12
Using Online Help	1-12
Accessing Help from Windows Applications	1-12
Accessing Help from Windows 95	1-13
Accessing Help from Windows 3.1	1-13
Accessing Help from Windows NT 4.0	1-13
Accessing Help from Macintosh Applications	1-13

2 *Custom Printing*

Using Predefined Advanced Settings	2-1
Customizing Print Quality and Special Effects	2-4
Customizing Color Settings	2-7
Using ColorSync on the Macintosh	2-9
Saving Custom Settings	2-11
Redefining Custom Settings	2-12
Deleting Custom Settings	2-12

3 *Printing on Special Media*

Using Special Media	3-1
Media Loading and Software Settings Guidelines	3-2
Additional Media Loading Guidelines	3-3
Letterhead, Pre-printed Forms, and Legal-size Paper	3-4
EPSON 360 dpi, High Quality, and Photo Quality Ink Jet Paper	3-4
EPSON Photo Quality Glossy Paper, Film, and Transparencies	3-5
EPSON Photo Paper	3-6
EPSON Photo Quality Ink Jet Cards	3-7
EPSON Photo Quality Self Adhesive Sheets	3-7
EPSON Iron-On Transfer Paper	3-8
Envelopes	3-8
Printing Banners and Other Custom Size Projects	3-9
Printing a Banner from Windows	3-10
Printing a Banner from a Macintosh	3-12

4 *Managing Print Jobs and Network Printing*

Managing Print Jobs in Windows 95 or 3.1	4-1
Using the Spool Manager	4-2
Using the Status Monitor	4-4
Managing Print Jobs with Windows NT 4.0	4-5
Managing Print Jobs on a Macintosh	4-6
Using Monitor2	4-6
Using the Macintosh Status Monitor	4-7
Network Printing on a PC	4-9
Network Printing with Windows NT 4.0	4-9
Using the Printer Software's Built-in Network Support	4-10

5 *Maintenance and Transportation*

Cleaning the Print Heads	5-1
Using the Head Cleaning Utility	5-2
Using the Control Panel	5-3
Examining the Nozzle Check Pattern	5-4
Replacing an Ink Cartridge	5-4
Removing an Empty Ink Cartridge	5-5
Installing the New Cartridge	5-6
Replacing an Outdated Ink Cartridge	5-7
Aligning the Print Heads	5-8
Cleaning the Printer	5-9
Transporting the Printer	5-10

6 *Troubleshooting*

Diagnosing Problems	6-1
Running a Printer Check	6-2
Improving Print Quality	6-3
Solving Printing Problems	6-7
Fixing Paper Problems	6-12
Solving Miscellaneous Printout Problems	6-14

A *Specifications*

Printing	A-1
Paper	A-3
Ink Cartridge	A-5
Mechanical	A-5
Electrical	A-6
Environmental	A-6
Safety Approvals	A-6
Interface	A-6
Default Settings	A-8
Built-in Fonts and Character Tables	A-8
Command List	A-9

Glossary

Index

Introduction

Your EPSON Stylus® COLOR 600 printer is the ideal output device for business graphics, single-page layout proofs, digital photography—or any project you create on your computer. With resolutions up to 1440 by 720 dpi, you get amazingly realistic photographic images and vivid graphics in color, superb grayscale images, and laser-sharp black printing for crisp text and detailed line art.

The printer software for Microsoft® Windows® and Macintosh® provides advanced color management, with adjustable levels of brightness, contrast, saturation, and ink colors. Support for ColorSync™ 2.01 and Windows ICM ensures printouts that match the colors on your monitor.

You can also perform many printer maintenance procedures right from your computer, such as cleaning and aligning the print heads. And EPSON's extensive online help can guide you through printer operations in real time.

With standard parallel and serial ports and simple network connectivity, setting up your printer is fast and easy. EPSON's specially formulated ink cartridges and wide variety of ink jet papers give you the best quality output and offer the most flexibility for getting the results you want.

Windows System Requirements

To use your printer and its software with a PC, your system should have:

- An IBM® compatible PC with at least a 386/25 MHz or faster processor
- DOS, Windows 3.1x, Windows for Workgroups 3.11, Windows 95, or Windows NT® 4.0
- At least 16MB of RAM
- At least 20MB of free hard disk space for storing images (50MB or more is recommended)
- VGA, Super VGA, or better display adapter and monitor
- Double-speed CD-ROM drive (quad-speed or faster recommended) for installing the printer software
- A shielded, twisted-pair parallel cable (6 to 10 feet long) to connect your computer to the printer; the cable must have a D-SUB, 25-pin, male connector for your computer and a 36-pin, Centronics® compatible connector for the printer.

To use the EPSON Answers online guide (not available for Windows NT or Macintosh), you need at least a 486/33 processor. You also should have at least 20MB of free hard disk space for full program installation or at least 8MB of free hard disk space to run EPSON Answers from the CD.

For system requirements for the EPSON Perfect Picture™ Software Suite, see your *Setup Guide*.

Macintosh System Requirements

To use your printer and its software with a Macintosh, your system should have:

- Any Macintosh or Power Macintosh model except the Macintosh +, Macintosh 512, Performa® 410, PowerBook® 100, and some early versions of the Macintosh, such as the II or Classic
- System 7.1 or later
- At least 8MB of built-in RAM (16MB or more is recommended)
- At least 20MB of free hard disk space for storing images (40MB or more is recommended)
- VGA, Super VGA, or better display adapter and monitor
- Double-speed CD-ROM drive (quad-speed or faster recommended) for installing the printer software
- Standard Apple® System Peripheral-8 cable or equivalent (RS-422, 8-pin mini DIN male/male)

For system requirements for the EPSON Perfect Picture™ Software Suite, see your *Setup Guide*.

How To Use Your Manuals

To set up your printer and install your printer software, see the *Setup Guide*. This *User's Guide* contains the following information:

Chapter 1, “Basic Printing,” covers the basics of printing with Windows or Macintosh.

Chapter 2, “Custom Printing,” tells you how to print special projects with custom settings for print quality and color management.

Chapter 3, “Printing on Special Media,” gives guidelines for selecting the right paper or other media for your print job and instructions for loading it in your printer.

Chapter 4, “Managing Print Jobs and Network Printing,” explains how to manage print jobs, check printer status, and set up your system for network printing.

Chapter 5, “Maintenance and Transportation,” gives instructions for replacing ink cartridges, cleaning and aligning the print heads, and cleaning and transporting the printer.

Chapter 6, “Troubleshooting,” provides solutions for any printing problems you may have.

The Appendix, “Specifications,” provides the technical details on your printer, ink cartridges, and EPSON media.

A Glossary and an Index are included at the end of the book.

Warnings, Cautions, Notes, and Tips

You'll find this information throughout your manual:



Warnings must be followed carefully to avoid bodily injury.



Cautions must be observed to avoid damage to your equipment.



Notes contain important information about your printer.



Tips contain additional hints for great printing.

Where To Get Help

EPSON provides customer support through the following services:

Electronic support services

Service	Access
World Wide Web	From the Internet, you can reach EPSON's Home Page at http://www.epson.com .
EPSON Internet FTP Site	If you have Internet FTP capability, use your Web browser (or other software for FTP downloading) to log onto ftp.epson.com with the user name anonymous and your e-mail address as the password.
EPSON Download Service	You can call the EPSON Download Service at (800) 442-2007 . Set your communications software to 8 data bits, 1 stop bit, no parity. Modem speed can be up to 28.8 Kbps.
EPSON Forum on CompuServe®	Members of CompuServe can type GO EPSON at the menu prompt to reach the Epson America Forum. For a free introductory CompuServe membership, call (800) 848-8199 and ask for representative #529.

Automated telephone services

Service	Access
EPSON SoundAdvice™	Pre-recorded answers to commonly asked questions about EPSON products 24 hours a day, seven days a week, call (800) 442-2110 .
EPSON FaxAdvice™	Access EPSON's technical information library by calling (800) 442-2110 . You must provide a return fax number to use this service.
EPSON Referral Service	For the location of your nearest Authorized EPSON Reseller or Customer Care Center, call (800) 442-2110 .



Note:

If you need help using software with an EPSON product, see the documentation for that program for technical support information.

EPSON also provides technical support and information on the installation, configuration, and operation of EPSON products. Dial **(800) 922-8911**, **(310) 782-2600** (U.S.), or **(905) 709-9475** (Canada), 6 A.M. to 6 P.M., Pacific Time, Monday through Friday.

Before you call, please have the following information ready:

- Product name
- Product serial number
- Computer configuration
- Description of the problem

You can purchase ink cartridges, paper, manuals, accessories, and parts from EPSON Accessories at **(800) 873-7766** (U.S. sales only). In Canada, please call **(800) 873-7766** for dealer referral.



ENERGY STAR Compliance

As an ENERGY STAR Partner, EPSON has determined that this product meets the ENERGY STAR guidelines for energy efficiency.

The EPA ENERGY STAR Office Equipment program is a voluntary partnership with the computer and office equipment industry to promote the introduction of energy-efficient personal computers, monitors, printers, fax machines, and copiers in an effort to reduce air pollution caused by power generation.

Energy-saving Tips

Here are a few tips you can use to be even more energy-wise:

- If your monitor isn't ENERGY STAR compliant, turn it off when you're not using it.
- Turn off your computer, printer, and monitor each day when you are done using them.
- Use the print preview option in your software so you can catch errors before you print something.
- Send e-mail rather than distributing memos. Not only is this faster, but you'll save paper and storage space too.

Important Safety Instructions

Before using your printer, read the following safety instructions to make sure you use the printer safely and effectively.

- Turn off and unplug the printer before cleaning. Clean with a damp cloth only. Do not spill liquid on the printer.
- Do not place the printer on an unstable surface or near a radiator or heating vent.
- Do not block or cover the openings in the printer's cabinet or insert objects through the slots.
- Use only the type of power source indicated on the printer's label.

- Connect all equipment to properly grounded power outlets. Avoid using outlets on the same circuit as photocopiers or air control systems that regularly switch on and off.
- Place the printer near a wall outlet where the plug can be easily unplugged.

Placez l'imprimante près d'une prise de contacte où la fiche peut être débranchée facilement.

- Do not let the power cord become damaged or frayed.
- If you use an extension cord with the printer, make sure the total ampere rating of the devices plugged into the extension cord does not exceed the cord's ampere rating. Also, make sure the total ampere rating of all devices plugged into the wall outlet does not exceed the wall outlet's ampere rating.
- Except as specifically explained in this *User's Guide*, do not attempt to service the printer yourself.
- Unplug the printer and refer servicing to qualified service personnel under the following conditions:

If the power cord or plug is damaged; if liquid has entered the printer; if the printer has been dropped or the cabinet damaged; if the printer does not operate normally or exhibits a distinct change in performance. Adjust only those controls that are covered by the operating instructions.

Even if you are familiar with other types of printers, be sure to read through the following list of precautions before operating your ink jet printer:

- Do not put your hand inside the printer or touch the cartridge during printing.
- Under normal circumstances, ink will not come out of the cartridges. If it does get on your skin, wash it off with soap and water. If it gets in your eyes, flush them immediately with water.
- Keep ink cartridges out of the reach of children.

- Do not dismantle the ink cartridges or try to refill them. This could result in damage to the print head.
- Once you install an ink cartridge, do not open the clamp or remove the cartridge except to replace it with a new one. The cartridge may become unusable otherwise.
- Install the ink cartridge immediately after you remove it from its package. Leaving the cartridge unpacked for a long time before use may result in reduced print quality.
- Do not use an ink cartridge beyond the date printed on the cartridge carton. For best results, use up the ink cartridges within six months of installing them.
- Do not shake an ink cartridge; this can cause leakage.
- Always turn the printer off using the ⏻ power button. When this button is pressed, the ⏻ power light flashes briefly then goes out. Do not unplug the printer or turn off the power to the outlet until the ⏻ power light is off.
- Before transporting the printer, make sure the print head is capped in the far right position and the ink cartridges are in place.

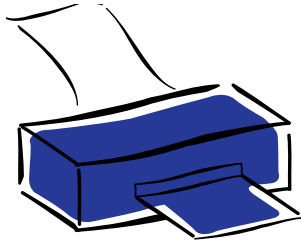

1

Basic Printing

It's easy to print all your color and black and white documents with your new EPSON Stylus COLOR 600. First you have to set up your printer and install the software, following the instructions in the *Setup Guide*. Then read this chapter to find out about the following:

- Printing from Windows
- Printing from a Macintosh
- Printing from DOS
- Choosing paper and other media
- What to do when the printer lights flash
- Using the control panel buttons
- Using online help

Printing from Windows

When you want to print from your Windows application, you click the print icon or choose **Print** from the File menu. You can then choose which pages to print, the number of copies, and other options. The settings that describe your print job—whether you want to use color or black ink, for example—are part of your printer driver software.

The following sections tell you how to set printer options from Windows applications, how to change the default printer settings, and how to check your printer's status.



Note:

The settings you select through your Windows application apply only until you exit that application. Then the driver settings return to the driver's default values or the values selected through the Windows 95 or Windows NT Printer Properties or Windows 3.1 Control Panel.



For more information about printer settings, click the Help button. In Windows 95 and Windows NT, you can right-click any item on the screen and then click What's This?

Setting Printer Options from Windows Applications

This section describes the preferences you'll need to set for all your everyday printouts. See Chapter 2 for information about advanced settings for special print jobs.

Follow these steps to check printer settings from your word processor or other Windows software:

1. Click the print icon or choose **Print** or **Print Setup** from the File menu. You see a printing dialog box.

If you choose **Print**, you first see a Print dialog box that contains the settings you change most often, including the number of copies and the pages you want printed.

2. Make sure your EPSON Stylus COLOR 600 printer is selected, and then click the **Printer**, **Setup**, **Properties**, or **Options** button. (You may have to click a combination of these buttons.) You see a dialog box like the following:

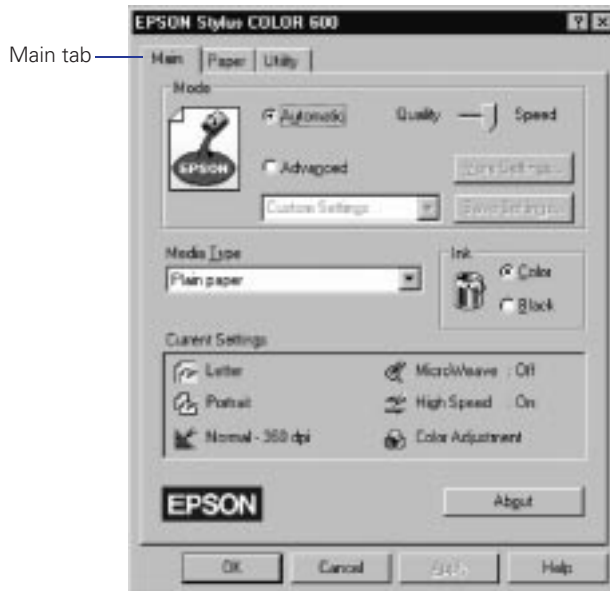

3. If you do not see the dialog box shown in step 2, click the **Main** tab.
4. Make sure the Mode option is set to **Automatic**. The printer software determines the best settings according to the Media Type and Ink settings you make. This is the easiest way to get good printing results for all kinds of documents, on all types of paper.
5. Choose the **Media Type** you want to print on from the following list (you may need to scroll through the list). If you are not sure which setting to select for your media, refer to the table on page 3-2.



For printing at the highest resolution (SuperFine quality at 1440 dpi), you need to use one of the photo quality media. For the best printing at any resolution, always use EPSON media.

- ▶ Plain paper
- ▶ 360 dpi Ink Jet Paper
- ▶ Photo Quality Ink Jet Paper
- ▶ Photo Quality Glossy Paper
- ▶ Photo Quality Glossy Film
- ▶ Ink Jet Transparencies

The type of media you choose determines the print quality or resolution you can use.

6. Choose **Color** or **Black** ink. If you are printing black text, a draft, or if you want colors to print as varying shades of gray, select **Black** for faster printing.
7. Set the slider to **Quality** or **Speed**. This lets you choose between the highest resolution or the fastest printing for the media you're using. (The slider is not available for certain media types.)

Once you've changed these basic settings as needed, check the Current Settings box on the bottom of the menu to see if the other settings are correct for your document. If you need to adjust them, use Advanced mode as described in Chapter 2.



Note:
To cancel your changes and exit the driver, click the Cancel button at the bottom of the menu at any time.

8. If necessary, click the **Paper** tab and choose your paper size, number of copies, orientation, and printable area. If your software application lets you control these settings, you don't need to use the **Paper** tab.
9. Click **OK** when you're finished checking your settings. The dialog box closes.
10. In the printing dialog box, click **Close**, **OK**, or **Print**. You may need to click a combination of these buttons.

While your document is printing, the EPSON Despooler dialog box appears, showing the printing progress and the status of your printer. If you're using Windows 95, this box also displays the Status Monitor. (See "Checking Printer Status," on page 1-6 for more information.)



Note:
Some application settings override driver settings (such as Paper Size or Orientation), so it's a good idea to check the settings in your application before you print.

Setting Default Printer Options

When you change printer settings through your software application, the settings apply only to the application you're using. If you want to adjust the default settings for all your Windows applications, you can access the dialog box through the Windows 95 or Windows NT Settings option or the Windows 3.1 Control Panel.

Make sure all your software applications are closed before you start. Otherwise, you'll have to close and then reopen them to have the new default settings take effect.

Setting Default Options in Windows 95

Follow these steps:

1. Click **Start**, point to **Settings**, and then select **Printers**.
2. Right-click the EPSON Stylus COLOR 600 icon.

3. Select **Properties**. Then click the **Main** tab.

You see the Main printer settings dialog box, as shown on page 1-2.

4. Change the settings you want and click **OK**.

Any changes you make will become the default settings for all your applications and documents.

Setting Default Options in Windows 3.1

Follow these steps:

1. Double-click the **Control Panel** icon in the Main group.
2. Double-click the **Printers** icon.
3. Select **EPSON Stylus COLOR 600** from the list of printers and click **Setup**.

You see the Main printer settings dialog box, as shown on page 1-2.

4. Change the settings you want and click **OK**.

Any changes you make will become the default settings for all your applications and documents.



Note:

You can access the default Windows NT printer software settings only if you have the appropriate network access privileges, such as Administrator or Power User.

Setting Default Options in Windows NT 4.0

1. Click **Start**, point to **Settings**, and then select **Printers**.
2. Click the **EPSON Stylus COLOR 600** icon.
3. Open the **File** menu and select **Document Defaults**. You see the Main printer settings dialog box.
4. Change the settings as described on page 1-2 and click **OK**. Any changes you make become the default settings for all your applications and documents.



Note:

If you don't want the Despooler dialog box to appear each time you print, you can turn it off. To do this, start Spool Manager, open the View menu, and select Show Despool Popup; the checkmark next to the option disappears.

Checking Printer Status

While your document is printing, the EPSON Despooler dialog box appears on your screen:

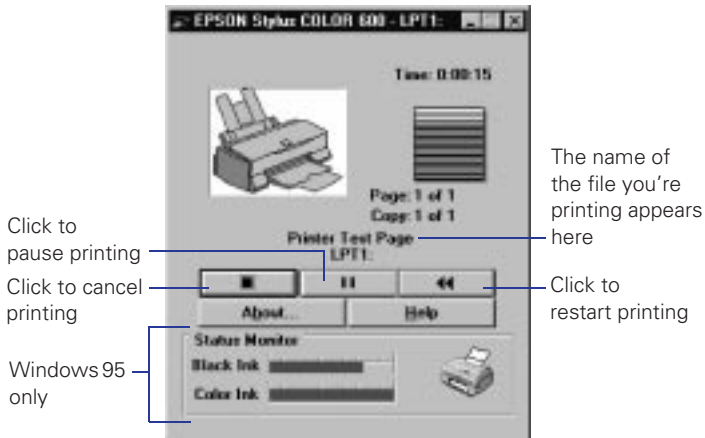

This dialog box shows the progress of your print job and the status of your printer. If you run out of paper while printing, for example, the Despooler warns you. You can use the buttons to cancel, pause, or restart your print job.

The Status Monitor at the bottom of the dialog box shows how much ink is left in your printer, along with these status icons:



Note:

The Status Monitor appears only if you're using Windows 95 and you're not printing over a network.

	Checking the printer status.
	A printing error has occurred and your printer cannot print. Check your printer or see Chapter 6 for troubleshooting information.
	The printer is ready to print.
	The printer is currently printing.
	The ink level is low or empty; check the or ink out light on the control panel and replace the cartridge if necessary.

Printing from a Macintosh

When you set up a new printer for your Macintosh, you need to check the printer driver settings for documents in each application you use. After you click the print icon or choose **Print** from the File menu, you see dialog boxes that let you choose the settings that describe your print job—such as whether you want to use color or black ink or the number of copies.

This section describes the preferences you'll need to set for all your everyday printouts. See Chapter 2 for information about advanced settings for special print jobs.

Follow these steps to check printer settings from your word processor or other Macintosh software:

1. Choose **Page Setup** from the File menu. You see the Page Setup dialog box.
2. Choose your paper size and other page setup options and click **OK**.
3. Choose **Print** from the File menu or click the print icon in your application. You see a dialog box like the following:



Note:

On the Macintosh, printer settings are saved with your document, but you can't save them from one application to another. You'll have to check your settings each time you print from a new application. If you want to reuse settings, you can create document templates for your favorite applications.

Click for more information about printer settings



Click to see list of media types

4. Choose the number of copies and indicate which pages you want to print.



For printing at the highest resolution (SuperFine quality at 1440 dpi), you need to use one of the photo quality media. For the best printing at any resolution, always use EPSON media.

5. Make sure the Mode option is set to **Automatic**. The printer software determines the best settings according to the Media Type and Ink settings you make. This is the easiest way to get good printing results for all kinds of documents, on all types of paper.
6. Choose the **Media Type** you want to print on from the following list. The type of media you choose determines the print quality or resolution you can use. If you are not sure which setting to select, refer to the table on page 3-2.
 - ▶ Plain Paper
 - ▶ 360 dpi Ink Jet Paper
 - ▶ Photo Quality Ink Jet Paper
 - ▶ Photo Quality Glossy Paper
 - ▶ Photo Quality Glossy Film
 - ▶ Ink Jet Transparencies
7. Choose **Color** or **Black** ink. If you are printing black text, a draft, or if you want colors to print as varying shades of gray, choose **Black** for faster printing.
8. Set the slider to **Quality** or **Speed**. This lets you choose between the highest resolution or fastest printing for the media you're using.
9. Click **Print** when you're finished checking your settings.

If you chose background printing when you set up your printer, you can continue working while your document is printing. See "Using Monitor2" in Chapter 4.

Printing from DOS

Most DOS software programs include software for EPSON ESC/P 2™ printers. You need to select the correct printer software to take advantage of your printer's advanced built-in scalable fonts and graphics handling.



Note:
The drivers for the printers listed do not provide all EPSON Stylus COLOR 600 features, such as 1440-dpi printing, 720-dpi printing, and MicroWeave.

Most DOS programs require you to select from a list of printers to install the printer software. If EPSON Stylus COLOR 600 is not included in the list, contact your software manufacturer to obtain updated software.

If updated software is not available, pick the first printer available in the lists below.

When printing black and color, select:

EPSON Stylus Pro
EPSON Stylus COLOR 500
EPSON Stylus COLOR II
LQ-860
LQ-2550

When printing black only, select:

LQ-870/1170
LQ-500
LQ-570(+)/1070(+)
SQ-870/1070
LQ-850

Choosing Paper and Other Media

You can use most plain paper with your printer and achieve good results. For better results, use EPSON specially coated ink jet paper because it provides the best surface for the ink used in your printer. EPSON offers specially designed media for EPSON ink jet printers, available in a choice of sizes. See Chapter 3 for more information on using special media.

Media name	Size	Part number
EPSON 360 dpi Ink Jet Paper	A4 Letter	S041059 S041060
EPSON High Quality Ink Jet Paper	A4 Letter	S041117 S041111
EPSON Photo Quality Ink Jet Paper	A4 Letter Legal	S041061 S041062 S041067
EPSON Photo Quality Glossy Paper	A4 Letter	S041126 S041124
EPSON Photo Paper	4 × 6	S041134
EPSON Photo Quality Glossy Film	A6 A4 Letter	S041107 S041071 S041072
EPSON Ink Jet Transparencies	A4 Letter	S041063 S041064
EPSON Photo Quality Ink Jet Cards	A6 8 × 10	S041054 S041122
EPSON Iron-On Transfer Paper	Letter	SE41001, SE41002
EPSON Photo Quality Self Adhesive Sheets	A4	S041106

To order EPSON papers and other media, contact your dealer or call EPSON Accessories at (800) 873-7766 (U.S. sales only). In Canada, please call (800) 873-7766 for dealer referral.

What To Do When the Printer Lights Flash

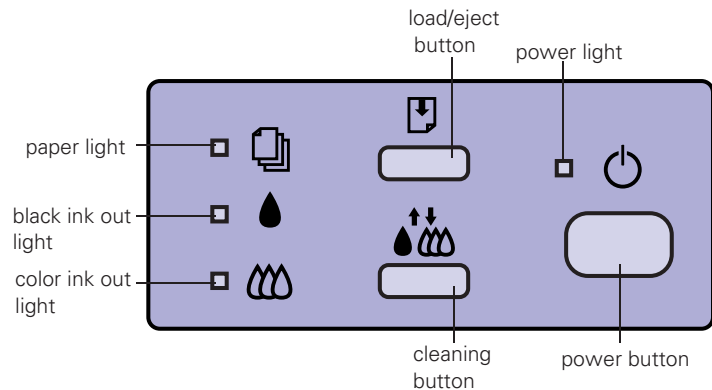

The four lights on your printer's control panel show the printer's status and alert you to problems like paper jams.



When the paper light comes on, your paper ran out or is incorrectly loaded. Load paper in the feeder and then press the  load/eject button.



When an ink out light comes on, you need to replace the ink cartridge. See Chapter 5 for instructions.



When an ink out light *flashes*, your ink supply is low. Make sure you have a replacement cartridge.



When the paper light *flashes* and the ink out lights are on, you have a paper jam. Turn off the printer and gently pull out all jammed paper. Reload the paper, then press the  load/eject button.



The power light is on when the printer is on. The power light *flashes* when the printer is receiving data or charging ink, or if you are replacing an ink cartridge or cleaning a print head.



When the power and paper lights *flash* and the ink out lights are on, your printer has a carriage error. Press the  button twice to reset the printer. See Chapter 6 for more information.



When all the lights *flash*, your printer may have an internal error. See Chapter 6 for more information.

Using the Control Panel Buttons

Follow these guidelines when using the control panel buttons:





Turns the printer on and off.



Resets the printer (clears its memory) if pressed twice within 10 seconds while the power is on.



Loads or ejects paper if pressed and released within two seconds. Resumes printing if pressed after a paper out error is corrected.



Moves the print head to the replacement position if pressed for about three seconds while the  or  ink out light is flashing or on. Returns the print head to its home position after ink cartridge replacement.

Performs print head cleaning if pressed for about three seconds when the  or  ink out light is off.

Using Online Help

For complete information about using the printer driver, you can easily access online help any time. It provides detailed descriptions of the different settings and options.

Accessing Help from Windows Applications

To access online help from your application, open the **File** menu and choose **Print** or **Print Setup**. Then click **Printer**, **Setup**, **Options**, or **Properties** (you may need to click a combination of these buttons) depending on the software you are using. Click the **Help** button at the bottom of the dialog box for help related to the items on that dialog box. Then select a help topic.

You can also access online help when you're not using the driver, as described below.

Accessing Help from Windows 95

Click the **Start** button, point to **Programs**, and **Epson**, and then click **EPSON Stylus COLOR 600 Help**. If you need instructions for how to use help, read the online "Quick Guide to Using Help."

While you're using the printer driver, you can get specific help related to any item in the menus by right-clicking the item and then clicking the **What's This?** prompt.

Accessing Help from Windows 3.1

To access online help from Program Manager, open the **EPSON** program group and click the **EPSON Stylus COLOR 600**. If you need instructions for how to use help, read the online "Quick Guide to Using Help."

Accessing Help from Windows NT 4.0

Click the **My Computer** icon, then click the **Printers** icon. Right-click the **EPSON Stylus COLOR 600** icon and select **Document Defaults** from the menu. In the printer software dialog box, click the **Help** button. If you need instructions for how to use help, read the online "Quick Guide to Using Help."

Accessing Help from Macintosh Applications

Choose **Print** from the **File** menu or click the print icon in your application. Click the **Help** button for help related to the items on that menu. To exit Help, click the **OK** button at the bottom of the Help screen.



With Windows NT, you can get specific help related to any item in the menus by right-clicking the item and then clicking the **What's This?** prompt.



2

Custom Printing

When you want to print presentation graphics, photographs, or other special projects, you can use the custom settings in your EPSON Stylus COLOR 600 software. You can choose predefined settings or adjust individual options like brightness, contrast, saturation, and halftoning. For professional-quality color accuracy, you can use Image Color Matching (ICM) under Windows 95 or ColorSync on the Macintosh.

This chapter includes the following information:

- Using predefined advanced settings
- Customizing print quality and special effects
- Customizing color settings
- Using ColorSync on the Macintosh
- Saving custom settings
- Redefining custom settings
- Deleting custom settings

Using Predefined Advanced Settings

Predefined settings provide an easy way to fine-tune your printer's operation for special projects. Follow these steps to print with predefined settings:

1. Create your document, image, or project in your application software.

2. Access the Main printer settings dialog box as described on page 1-2 (Windows) or page 1-7 (Macintosh).

You see one of the following dialog boxes:

Click **Advanced**, then click here to see a list of project types



Note:
When you use advanced settings, the Quality/Speed slider disappears.

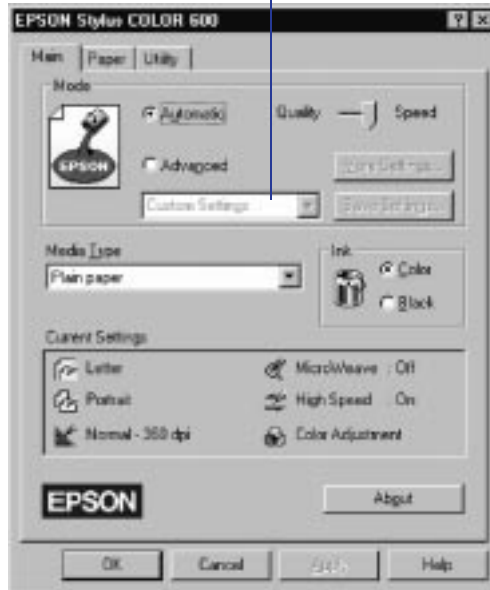

Windows



Macintosh

Click **Advanced**, then click here to see a list of project types

3. Select Color or Black Ink.



Note:

Always choose your Ink setting before you select a project setting from the Custom Settings list.

Selecting PhotoEnhance, ICM, or ColorSync automatically sets the Ink option to Color.

Printing with the PhotoEnhance setting may take longer, depending on your computer system and image.



The Photo setting and the PhotoEnhance setting have similar effects. However, PhotoEnhance intelligently analyzes your image data and its effect varies widely depending on your image. The Photo setting consistently increases contrast. You may have to experiment to choose the best setting for your needs.

4. Click **Advanced**, and then **Custom Settings**. You see the list of project types.
5. Follow these guidelines to choose the right one for your project:
 - **Photo**
For printing scanned photographs. Increases contrast in the image.
 - **Text/Graph**
For printing graphics-intensive documents like presentation pages with charts and graphs. Intensifies colors and lightens the midtones and highlights.
 - **PhotoEnhance**
For printing images captured using a video camera, digital camera, or scanner. Produces sharper images and more vivid colors by automatically adjusting the contrast, saturation, and brightness. Corrects for overall under- and over-exposure of the original image.
 - **Economy**
For rough drafts of text only, on plain paper. Saves ink.
 - **ICM (Windows 95 only)**
Automatically adjusts printout colors to match the colors on your screen.
 - **ColorSync (Macintosh only)**
Automatically adjusts printout colors to match the colors on your screen. For more information, see page 2-9.
6. Choose the **Media Type** you want to print on. (If you are not sure which setting to select, refer to the table on page 3-2.) The available media are limited by the project you choose. For example, you can't use plain paper or transparencies with the ICM or ColorSync settings.
7. Click **OK** or **Print**. If you're using Windows, click any other buttons that your application uses for printing.



Note:

After you customize your print settings for a special project, you can save them as a group. Then you can reuse them whenever you print a similar project. See page 2-11 for instructions.

Customizing Print Quality and Special Effects

If you need the maximum control over your project, or you want to experiment with special effects, you can adjust individual settings in your printer software. Follow these steps:

1. Create your document, image, or project in your application software.
2. Access the Main printer settings dialog box as described on page 1-2 (Windows) or page 1-7 (Macintosh).
3. Click **Advanced**, and then click **More Settings**. You see the More Settings dialog box:

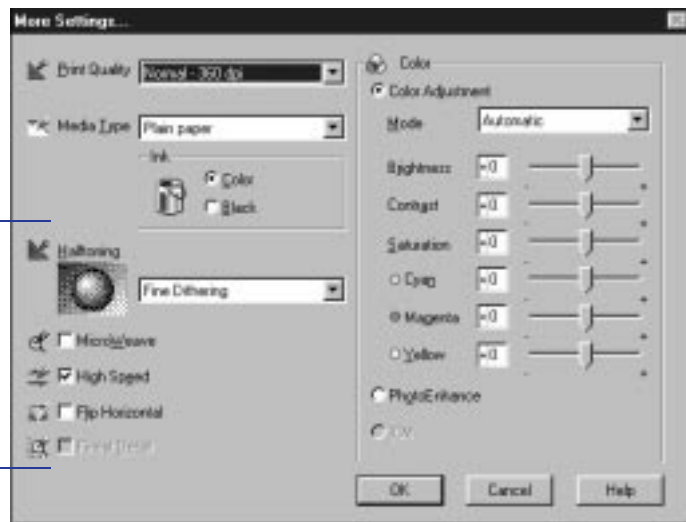

Some of these options are automatically set or disabled by other settings you choose

Windows

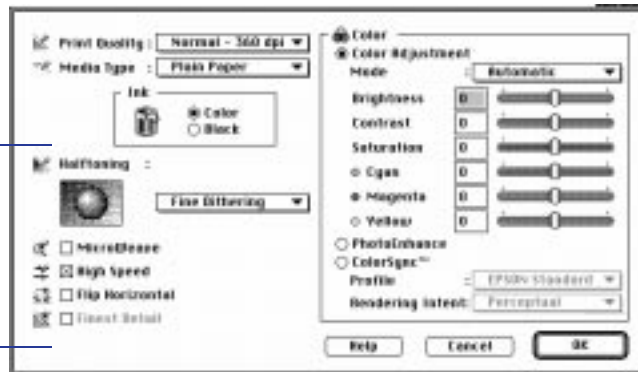

Some of these options are automatically set or disabled by other settings you choose

Macintosh



Note:

The Print Quality is selected automatically depending on the current Media Type. If you choose a Print Quality setting that is not appropriate for your media, the driver changes the Media Type setting. Be sure to check both of these settings.

4. Choose one of the following Print Quality options:
 - **Economy**
For low-resolution rough drafts on plain paper. Saves ink.
 - **Normal - 360 dpi**
For most documents on plain paper, transparencies, or 360 dpi Ink Jet paper.
 - **Fine - 720 dpi**
For high-resolution output. Works best on photo quality media.
 - **SuperFine - 1440 dpi**
For the highest-resolution output on photo quality media only.

5. Choose the **Media Type** and **Ink** settings you want to use, following the guidelines in Chapters 1 and 3.



Note:
In Automatic mode, the Halftoning setting is selected based on the data in your print job. In Advanced mode, Halftoning is preselected for each document type setting. No Halftoning is available only when you select Black as the Ink setting.



If vertical lines in your printout are misaligned when you use the High Speed setting, you may need to align the print heads. See Chapter 5 for instructions.

6. Choose one of the following Halftoning options:
 - **No Halftoning**
For printing black text only.
 - **Error Diffusion**
For printing photographic or video/digital camera images. Blends each dot of color with the surrounding dots.
 - **Fine Dithering, Coarse Dithering**
For printing charts, graphs, and other images that require precise, solid areas of bright colors. Arranges dots in orderly patterns. Use **Coarse** for images with more shading and less detail. Use **Fine** for images with more detail and less shading.

7. Choose any of the following options. Some of these settings are automatically selected or disabled by the **Print Quality** (resolution) you choose.
 - **MicroWeave**
For improved print quality. Prints graphic data in finer increments to eliminate unwanted banding effects (light horizontal lines). Always use for color printing.
 - **High Speed**
For fast, bidirectional printing at lower quality.
 - **Flip Horizontal**
Prints a mirror image of your document. Use for printing with iron-on transfer paper. When you iron the printout onto a T-shirt or other item, it will read correctly.
 - **Finest Detail**
For printing text, graphics, and line art with very sharp edges. Slows print speed and increases your system memory requirements.

8. Click **OK** if you're ready to print, or see the next section if you want to adjust your printer's color settings.

Customizing Color Settings

You can choose from several color adjustment modes or manually adjust brightness, contrast, and saturation. For professional color correction, you can set individual CMY color values. To achieve the maximum color accuracy, you can use Image Color Matching (ICM) under Windows 95, ColorSync on the Macintosh, or PhotoEnhance (Windows and Macintosh).

Follow these steps to customize your color settings:

1. Access the More Settings dialog box as described on page 2-4.

The color settings appear on the right side of the dialog box, as shown:

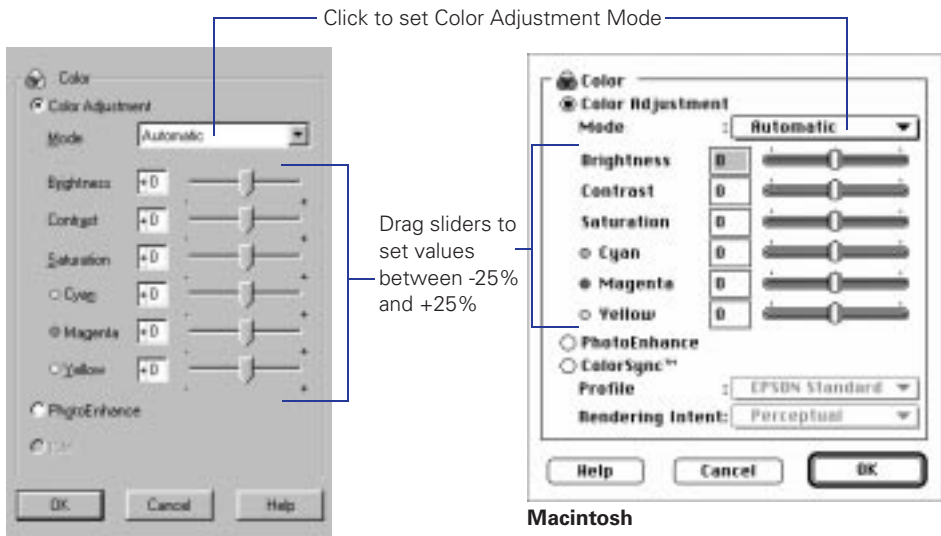

Windows
(ICM is available only for Windows 95)

2. Choose one of the following **Color Adjustment Modes**:
 - **Automatic**
Analyzes the color information in your project and optimizes color correction accordingly.
 - **Photo-realistic**
For printing color photographs.
 - **Vivid**
For printing graphics-intensive documents like presentation pages with charts and graphs. Intensifies colors and lightens the midtones and highlights.
 - **No Color Adjustment**
With Windows, disables the color adjustment features of the printer software so you can adjust colors using your application. On a Macintosh, choose this mode only if you're using ColorSync.

3. If you want to specify individual color correction values, use the scroll bars to increase (drag right) or decrease (drag left) the settings listed below. (If you use one of the options described in step 4, you won't be able to specify individual color correction values.)
 - **Brightness**
Makes your image lighter or darker.
 - **Contrast**
Increases or decreases the difference between the bright or dark parts of an image.
 - **Saturation**
Makes colors more vivid or less vivid.
 - **Cyan, Magenta, Yellow**
Increases or decreases the amount of the three ink colors that combine to make a full-color picture. Use to fine-tune the color balance in your printout.



Note:
When you choose PhotoEnhance, ICM, or ColorSync, all the other color options are preset.

The availability of ICM depends on your Print Quality, Media Type, and Halftoning settings.

4. For even more fine-tuning, choose **PhotoEnhance**, **ICM** (Windows 95), or **ColorSync** (Macintosh).
 - **PhotoEnhance**
Produces sharper images and more vivid colors by automatically adjusting the contrast, saturation, and brightness. Corrects for overall over- or under-exposure of the original photograph.
 - **ICM** (Windows 95 only)
Automatically adjusts printout colors to match colors on the screen.
 - **ColorSync** (Macintosh only)
Automatically adjusts printout colors to match colors on the screen. See “Using ColorSync on the Macintosh” for more information.
5. Click **OK** to return to the Main printer settings dialog box.
6. Click **Save Settings** if you want to save your custom settings as a group that you can reuse for special projects. See page 2-11 for more information about saving settings.
7. Click **OK** (Windows) or **Print** (Macintosh). If you’re using Windows, click any other buttons that your application uses for printing.

Using ColorSync on the Macintosh

Every device you use for viewing or producing colors—your monitor, scanner, and printer—uses a different color technology. That’s why it’s difficult to get printed colors to match the colors displayed on your monitor. The Macintosh ColorSync system calibrates your monitor so its colors match your printer’s as closely as possible.

ColorSync uses profile information from each device—including your EPSON Stylus COLOR 600—to achieve accurate color matching. First you have to make sure your monitor's profile is set. Then you can use your printer software to specify the exact method of color matching you want to use.

Follow these steps to set your monitor's ColorSync profile and use your printer software's ColorSync features:

1. Open **ColorSync System Profile** under **Control Panels** on the Apple menu.
2. Click the **Set Profile** button.
3. Select your monitor from the list, and then click **Select**.
4. Close **ColorSync System Profile**.
5. Access the **More Settings** dialog box as described on page 2-4.
6. Click **ColorSync**.
7. For **Profile**, choose **EPSON Standard**.
8. Choose one of the following options for **Rendering Intent**:
 - ▶ **Perceptual**
For printing photographs.
 - ▶ **Saturation**
For printing graphics-intensive documents like presentation pages with charts and graphs.
 - ▶ **Colorimetric**
For matching colors as precisely as possible.
Reproduces colors the way your eye distinguishes them.
9. Click **OK**, and then click **Print**.



Note:
The EPSON Standard profile is custom-designed for your printer. If you use a scanner or other color imaging equipment, you may have other profiles available.



Note:
You can save up to
10 groups of settings.

If you change the Media Type or Ink setting when your customized setting is selected, the setting selected in the list changes to Custom Settings. This does not affect your customized setting. To return to your customized setting, simply reselect it.

Saving Custom Settings

After you've fine-tuned your printer settings for a special project, you can save the settings as a group with a unique name and add it to the Custom Settings list. Then you can easily select the settings the next time you print a similar project. Follow these steps:

1. Customize your printer settings as described in this chapter.
2. Click the **Save Settings** button on the Main printer settings dialog box.

You see one of the following:



Windows

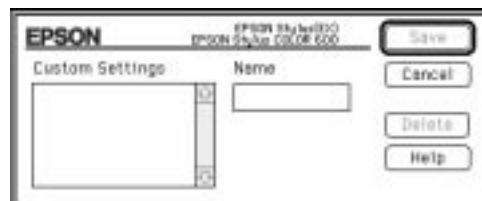

Macintosh

3. Type a unique name for your settings (up to 16 characters) and click the **Save** button.

The name you choose will now be available on the Main printer settings dialog box when you click **Advanced**, and then **Custom Settings**.

Redefining Custom Settings

To change the options in a customized setting group but keep the same name for it, follow these steps:

1. Select **Advanced** mode.
2. Select the name of the custom settings group you want to redefine in the Custom Settings list.
3. Change the printer settings as necessary. (If you change the Media Type and Ink settings, the custom settings group name reverts to Custom Settings; this doesn't affect your customized setting.)
4. Click **Save Settings**.
5. Select the name of the custom settings group you're redefining in the Custom Settings box.
6. If you're using Windows, click **Save**. You see the Save As dialog box. Click **OK** to save your redefined settings. (Click **Cancel** to cancel your changes.)

On a Macintosh, click the **Redefine** button. Then click **Replace** at the confirmation dialog box to save your redefined settings. (Click **Cancel** to cancel your changes.)

Deleting Custom Settings

If you no longer need your customized settings, follow these steps to delete them:

1. Select **Advanced** mode.
2. Click **Save Settings**.
3. Select the custom settings group in the Custom Settings box, and click **Delete**. (You cannot delete any of the predefined document types.)

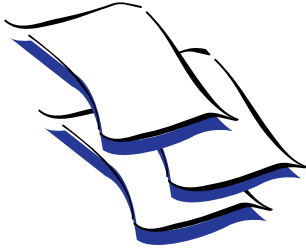

3

Printing on Special Media

Your EPSON Stylus COLOR 600 lets you print on just about any kind of paper you want to use. You can get great results printing on various sizes of plain paper, letterhead, and envelopes. You'll get even better results with specially coated ink jet paper. For the best output, use EPSON's photo quality media: ink jet paper, glossy paper, glossy film, index cards, and photo paper.

For special projects, you can use a variety of EPSON media designed for ink jet printers, ranging from transparencies to iron-on transfer paper. You can even set up your printer to use custom paper sizes to print large posters and banners. This chapter covers the following:

- Using special media
- Printing banners and other custom size projects

Using Special Media

The type of paper or other media you use is one of the most important factors in determining the quality of your printed output. For example, you can achieve the highest resolution (SuperFine quality at 1440 dpi) only when you use EPSON Photo Quality media. The following tips will help you get the best results on any type of paper or other media. For additional information, see the specific section for the media you are using.

Media Loading and Software Settings Guidelines

Whether you print on plain paper or special media, you need to load it according to the guidelines in the table below. You must also be sure to select the correct Media Type setting in your printer software to match the media you loaded. See page 3-3 for additional guidelines.

When you load media with this name . . .	Load a maximum of this many sheets . . .	Then select this Media Type setting in your printer software . . .
Plain paper (single sheets)	100 letter size	Plain paper
Envelopes (remember to set the adjust lever forward)	10 ¹	
Labels (single sheets)		
EPSON 360 dpi Ink Jet Paper	70 letter size	360 dpi Ink Jet Paper
EPSON Special Coated Paper for 360 dpi Printing	30 legal size	
EPSON High Quality Ink Jet Paper	70 letter size	Photo Quality Ink Jet Paper
EPSON Photo Quality Ink Jet Paper	30 legal size	
EPSON Special Coated Paper for 720 dpi Printing		
EPSON Photo Quality Ink Jet Cards	30 cards ¹	
EPSON 720 dpi Index Cards		
EPSON Photo Quality Self Adhesive Sheets	1	
EPSON Photo Quality Glossy Paper	20 letter size	Photo Quality Glossy Paper
EPSON Photo Paper	20 ¹	

When you load media with this name . . .	Load a maximum of this many sheets . . .	Then select this Media Type setting in your printer software . . .
EPSON Photo Quality Glossy Film (use with support sheet)	30 letter size	Photo Quality Glossy Film
EPSON High Quality Glossy Paper (use with support sheet)	30 letter size	
EPSON Ink Jet Transparencies (use with support sheet)	10 letter size	Ink Jet Transparencies
EPSON Iron-On Transfer Paper ²	1 sheet	

¹ Load with the short edge leading into the feeder.

² Use the Flip Horizontal option to reverse your image before you print it—especially if it includes text—so the image will appear correctly when it’s transferred. See Chapter 2 for instructions.

Additional Media Loading Guidelines

- D If the corresponding Media Type option for your paper is not shown in the Media Type list, change the **Print Quality** setting in the More Settings dialog box, select **Automatic** as the Mode setting, or change the predefined setting in the Custom Settings list on the Main menu. See Chapter 2 for more information.
- D In addition to the **Media Type** option, remember to select the correct **Paper Size** for your media.
- D Some special media have a cut corner that you need to position correctly; follow any instructions in the package. Always handle sheets by the edges, and don’t touch the printable surface.

If the special media has protective sheets between each sheet of media, be sure to remove the protective sheets before printing.

- D Be sure to load the printable side of the media face up with the top edge leading into the printer.
- D Use ink jet papers within one year of purchase. Use glossy media and transparencies within six months. Return

unused sheets and envelopes to their original packages as soon as possible. See the Appendix for more media storage information.

- ▶ Some EPSON media include a cleaning sheet. **Do not** use the cleaning sheets with this printer. They may damage the printer.

Letterhead, Pre-printed Forms, and Legal-size Paper

Always load the top edge first. If you are loading long paper, pull out the paper support extension and both output tray extensions. Don't load it more than half way to the arrow mark on the left edge guide.

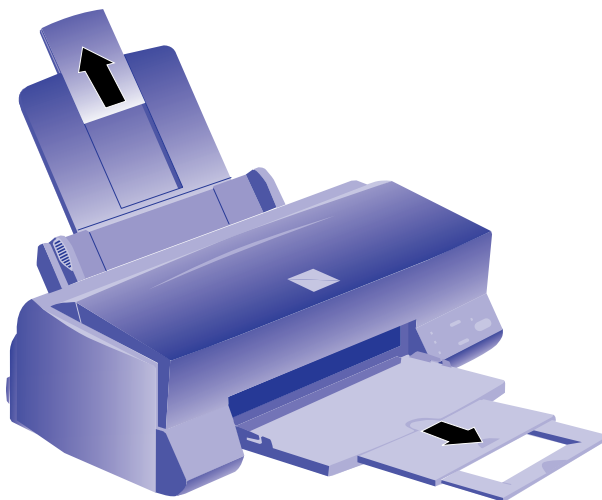

EPSON 360 dpi, High Quality, and Photo Quality Ink Jet Paper

You can load paper up to the arrow mark on the left edge guide. If you use legal-size ink jet paper, don't load it more than half way to the arrow mark.

EPSON Photo Quality Glossy Paper, Film, and Transparencies

To print on transparencies, remove the paper support and reinstall it in the rear paper support slot. For glossy paper and film, leave the paper support in the normal position.

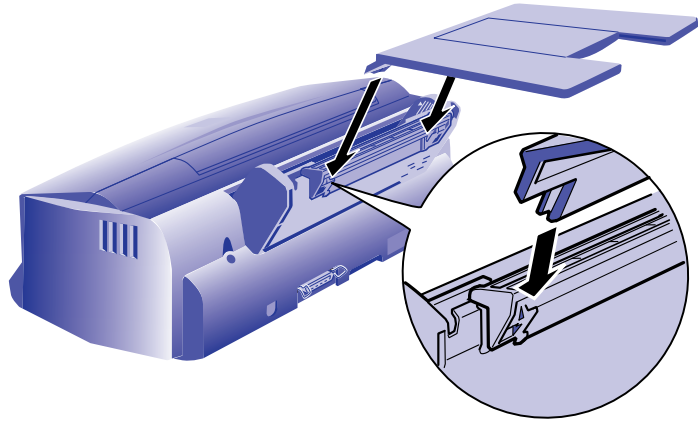

Note:
Use ink jet papers within one year of purchase. Use glossy media and transparencies within six months. Return unused sheets and envelopes to their original package as soon as possible. See the Appendix for more storage information.

Before you load glossy film or transparencies, put a support sheet (packed with the media) or a plain paper sheet beneath the stack. **Do not** use a support sheet with Photo Quality Glossy Paper.

You can load up to 20 sheets of glossy paper, up to 30 sheets of glossy film, or up to 10 transparencies. However, you may get better results by loading one sheet at a time. With multiple sheets loaded, the minimum top margin you can use is 1.2 inches. If you want to use a smaller top margin, load and print one sheet at a time.

Remove each sheet from the output tray immediately after it's printed. Make sure each sheet is dry before stacking it. If your media package included protective sheets, cover the printed side of your media with these sheets before stacking.

EPSON Photo Paper

You can use these cards to print photographs that look almost as good as the ones you get from film processing. EPSON Photo Paper (4 × 6 inches) is perforated around the edges, so you can trim your printouts and “bleed” the photo—extend it to the edge of the paper—on all sides.

You can load up to 20 sheets of EPSON Photo Paper at a time. Make sure you place the included support sheet beneath the stack, but don't print on it. Keep the following in mind when using EPSON Photo Paper:

- Load the paper with the whiter side facing up and the perforated margins positioned as shown:

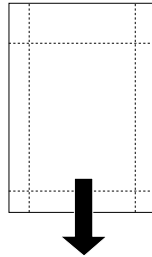

- When you create the image in your application software, size it to 4.25 × 6.25 inches. Note that the outside edges of your image will be cut off when you remove the perforated margins.

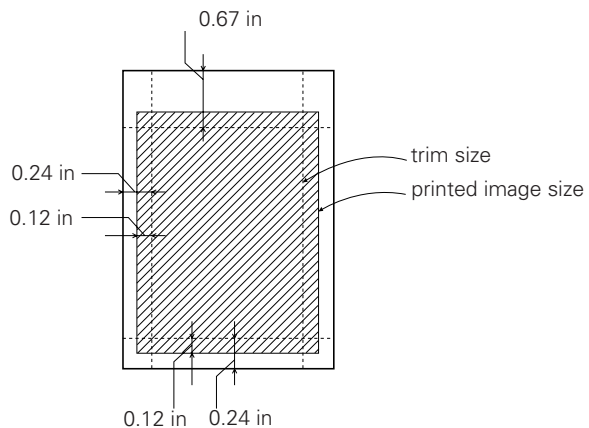

- ▶ Choose **EPSON Photo Paper 4 × 6 in** as the **Paper Size** setting and **Maximum** as the **Printable Area** setting.
- ▶ Choose **Photo Quality Glossy Paper** as the **Media Type** setting.
- ▶ After you print your picture, fold the paper back and forth along the perforations and carefully tear the margins off.

You can use the EPSON Photo Paper like a postcard. Simply print your image on the glossy side of the paper using the **Photo Quality Glossy Paper Media Type** setting and let your image dry. Then print your message on the uncoated side of the paper using the **360 dpi Ink Jet Paper Media Type** setting.

To keep your printouts looking their best, store them in a resealable plastic bag or other airtight covering and protect them from heat, humidity, and direct sunlight.

EPSON Photo Quality Ink Jet Cards

You can load up to 30 cards at a time with a support sheet (packed with the cards) or a sheet of plain paper beneath the stack. When you're ready to print, use your software to set the **Paper Size** option for the size card you're using.

If ink smears on the cards, set the adjust lever to the + position as shown on page 3-9.

EPSON Photo Quality Self Adhesive Sheets

Use these sheets to print labels or stickers. You should load these media one sheet at a time. Make sure your adhesive sheets are fully adhered to their backing sheet before you load them.



For iron-on transfers, make sure you reverse your image before you print it, especially if it includes text. Then the text will read correctly when it's transferred. You can use the Flip Horizontal option in your printer software, as described in Chapter 2.

EPSON Iron-On Transfer Paper

You can print photos, company logos, or anything else you want on this paper, and then transfer your images to T-shirts or other cloth items. Load one sheet of transfer paper at a time and select **Ink Jet Transparencies** as your media type in your printer software. After you print, follow the instructions that came with the paper to iron the image onto the shirt or other item.

Envelopes

You can load up to 10 envelopes as shown below:





Note:

Be sure to load the envelope flap edge first and printable side up.

In the printer driver, set the Paper Size to the correct envelope size.

If ink smears when you print on envelopes or other thick media, set the adjust lever to the + position. Open the printer cover and position the lever as shown below. Then close the cover and print. (Make sure you return the lever to the 0 position before you print on thin media.)

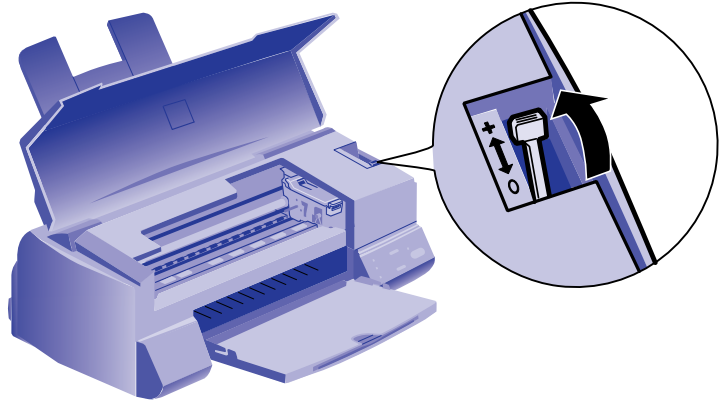

Printing Banners and Other Custom Size Projects

You can use banner paper or ordinary (continuous-form) computer paper to print a banner up to 44 inches long. You can also print on any size paper that fits into the printer (at least 3.94×3.94 inches), by using the custom page size feature of your printer software on either a Windows computer or a Macintosh.

1. To make a 44-inch banner with continuous-form computer paper, first tear off four sheets and remove the perforations at the edges. If you are using banner paper, cut the paper to the length you want for easier handling.

2. Insert the paper in the printer as shown. The right edge of the paper should be against the right edge guide:

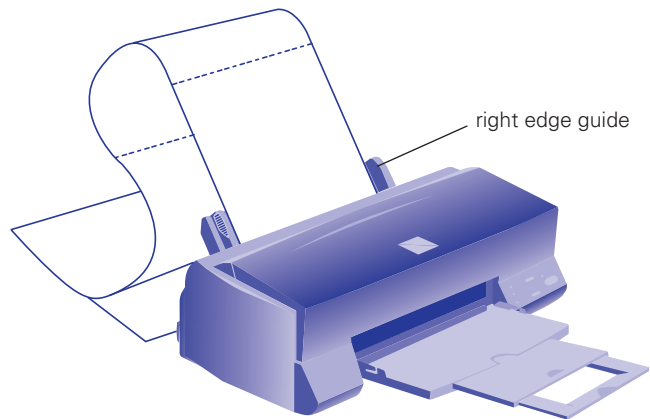

3. Slide the left edge guide next to the left edge of the paper.
4. Follow the instructions in the next sections to print your banner on either a Windows computer or a Macintosh.

Printing a Banner from Windows

Follow these steps to print a banner or other custom-size document on a Windows computer:

1. Create the document in your word processor or other application software. You can create a banner in either portrait or landscape orientation.
2. Click the print icon or choose **Print** or **Print Setup** from the File menu. You see a printing dialog box.
3. Make sure your printer is selected, and then click the **Printer, Setup, Properties, or Options** button. (You may have to click a combination of these buttons.) You see the Main printer settings dialog box, as shown on page 1-2.

4. Click the **Paper** tab. You see a dialog box like the following:

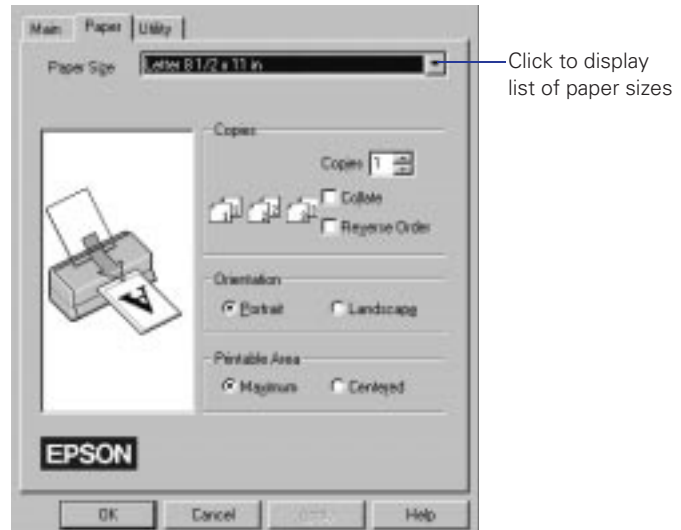

5. Choose the paper you want to use from the **Paper Size** list. If you want to print a banner or other custom-size document, choose **User Defined**.

If you choose **User Defined**, the following dialog box appears:

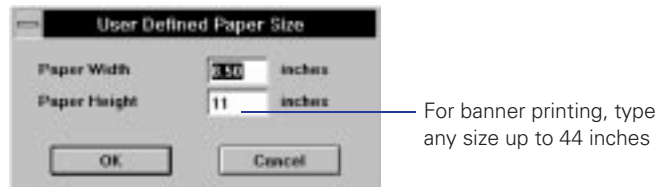

6. To print a banner, type **8.5 inches** for the **Paper Width** and **44 inches** for the **Paper Height**. (This works for both “landscape” and “portrait” style banners.) Click **OK**.
7. Choose **Portrait** or **Landscape** if you haven’t already specified the orientation in your application software. Set the printable area if necessary.

8. Click the **Main** tab to return to the Main printer settings dialog box. Make sure you choose **Plain paper** and the other settings you want to use, and then click **OK**.
9. Click **Close**, **OK**, or **Print** to print your banner. You may need to click a combination of these buttons.

Printing a Banner from a Macintosh

Follow these steps to print a banner or other custom-size document on a Macintosh:

1. Create the document in your word processor or other application software. You can create a banner in either portrait or landscape orientation.
2. Choose **Page Setup** from the File menu.

You see a dialog box like the following:

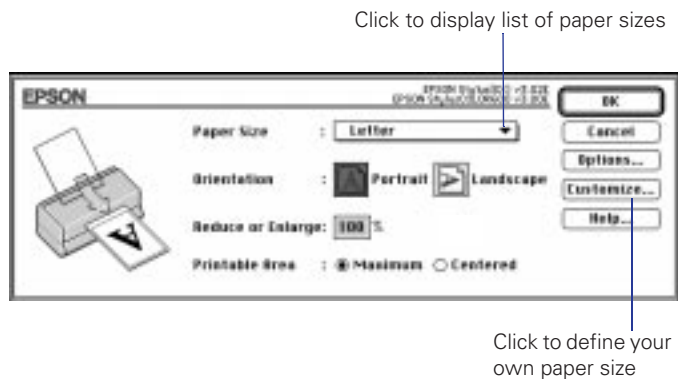

3. Choose **Portrait** or **Landscape**, depending on the orientation of the banner or document you created. Set the printable area if necessary.

4. Choose the paper you want to use from the **Paper Size** list. If you want to print a banner or other custom-size project, click the **Customize** button. The following dialog box appears:



5. Click the **New** button. The dialog box changes:



You can create up to eight custom paper sizes. If you give each one a unique name, you'll be able to reuse them by selecting them from the Paper Size list in the Page Setup dialog box.

6. Type a name for your custom size in the **New Paper Size** box.
7. To print a banner, type 8.5 inches for the **Width** and 44 inches for the **Height**. (This works for both “landscape” and “portrait” style banners.) Click **OK**, then **OK** again.
8. Choose **Print** from the **File** menu or click the print icon in your application. You see a printer settings dialog box like the one shown on page 1-7.
9. Make sure you choose **Plain Paper** and the other settings you want to use, and then click **Print** to print your banner.

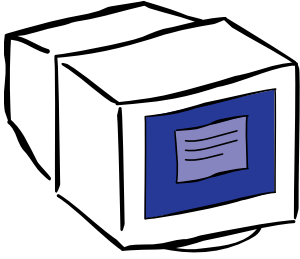

4

Managing Print Jobs and Network Printing

Your printer software includes several utilities for managing print jobs. You can use them to monitor your printer's status, set up large jobs to print later, and handle network printing. If you're using your printer on a network, you need to follow the special setup procedures in this chapter.

This chapter provides instructions for the following:

- Managing print jobs in Windows 95 or 3.1
- Managing print jobs in Windows NT 4.0
- Managing print jobs on a Macintosh
- Network printing on a PC

Managing Print Jobs in Windows 95 or 3.1

Your Windows printer software includes two management utilities: the Spool Manager and Status Monitor.

- The Spool Manager starts automatically when you send a job to the printer. It allows you to print in the background while you continue to work on your computer and to hold jobs to print at a later time. If you're using your printer on a network, it also handles multiple print jobs that come in at the same time.



Note:
The Status Monitor doesn't appear if you're printing over a network.

In Windows 3.1, you may not see the Spool Manager icon if the Program Manager or current window is maximized. Make the window smaller to see the Spool Manager icon.

- The Status Monitor, which is available only if you're using Windows 95, also starts automatically when you send a job to the printer. It displays on your screen to alert you about printer and ink status, as described on page 1-6.

Using the Spool Manager

The Spool Manager works like the Windows Print Manager. When you send a job to your printer, your printer software creates a temporary print job file, stores it in the C:\TEMP or C:\WINDOWS\TEMP folder or directory, and assigns it to a print queue. The software then sends the file to your printer at the right time.

- To open the Spool Manager while you're printing, click the **Spool Manager** icon that appears on the Taskbar (Windows 95) or at the bottom of your desktop (Windows 3.1).
- To open it at any time, double-click the **Spool Manager4** icon in the EPSON program group or folder.

You see the Spool Manager window:

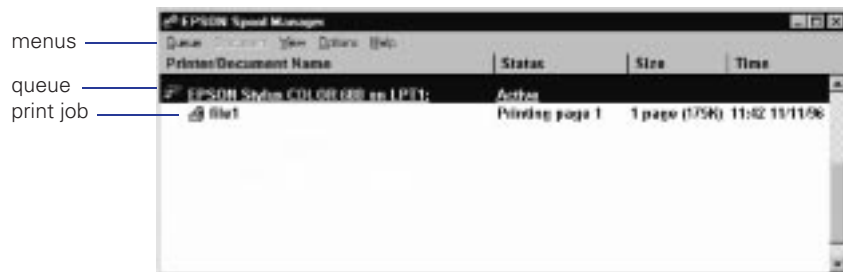

The Spool Manager window displays the status of your print queues and print job files and lets you control them. Here are some of the things you can do:

- Hold or release a queue
- Send print jobs to your printer over a network
- Hold, re-queue, or delete a print job



For information about any of these procedures, use the Spool Manager Help menu.

- ▶ Select the information you want to see in the Spool Manager window
- ▶ Prevent the Despooler popup window from appearing on your screen whenever you print
- ▶ Change your default spool directory

Deleting a Stalled Print Job

If you're having trouble printing, it may be because of a stalled print job. Follow these steps to delete it so you can continue printing:

1. Open the Spool Manager as described on page 4-2.
2. Click on any print jobs marked **Held**, then open the Document menu and click **Delete**.
3. Click **Yes**.
4. Exit Spool Manager and try printing again.

Changing the Default Spool Directory

If you get an error message when you try to print, or printing is very slow, you can try changing your default spool directory. Follow these steps:

1. Make a directory on your hard disk where you want Spool Manager to store print jobs, for example, C:\SPLTEMP.
2. Open the Spool Manager as described on page 4-2.
3. Make sure EPSON Stylus COLOR 600 is selected, and then choose **Setup** from the Queue menu. The Queue Setup dialog box appears.

4. Make sure the spool directory is the one you created in step 1. Also make sure **Use Print Manager for this port** is checked. Then click **OK**. (If you are using Windows 95 and don't see the Status Monitor when you print, make sure it's unchecked.)
5. Choose **Default Spool Directory** from the Options menu.
6. In the dialog box, change the spool directory to the one you created in step 1. Then click **OK**.
7. Close Spool Manager.

Using the Status Monitor

The Status Monitor, available only if you're using Windows 95, displays automatically when you send a job to the printer. However, you can use it at any time to see how much ink you have left. Follow these steps:

1. Access the Main printer settings dialog box as described on page 1-2 (Windows) or page 1-7 (Macintosh).
2. Click the **Utility** tab. You see the Utility menu:



Note:
The Status Monitor is not available if you are printing over a network or if the Use Print Manager for this Port option is selected in the Control Panel, Printers window.

For information about these three utilities, see Chapter 5

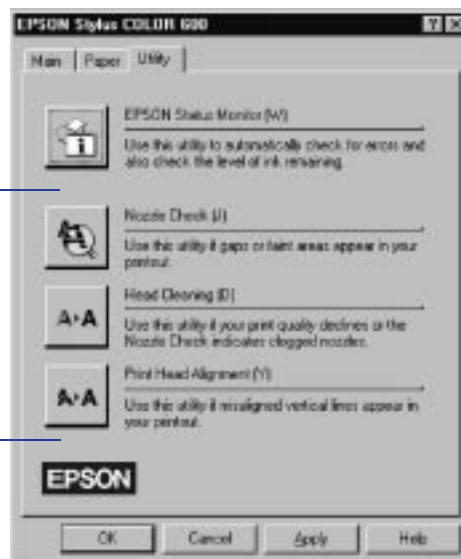

3. Click the EPSON Status Monitor icon. You see the Despooler window with the Status Monitor at the bottom:



4. Check the amount of ink you have left. For more information about the Despooler window, see page 1-6.

Managing Print Jobs with Windows NT 4.0

Windows NT 4.0 servers and workstations include a messenger service to alert you to printer errors or let you know when a print job is finished. If you have appropriate network access privileges or you're controlling printing from the server, you can also cancel, pause, or restart print jobs and set the sharing, security, scheduling, and port options. See your Windows NT documentation for details.

Managing Print Jobs on a Macintosh

Your Macintosh printer software includes two management utilities: Monitor2 and Status Monitor.

- ▶ If you're using background printing, Monitor2 starts automatically when you send a job to the printer. It handles printing while you continue to work on your Macintosh and lets you track documents that are waiting to be printed.
- ▶ The Status Monitor alerts you to any problems that occur during printing. You can also use it at any time to see how much ink you have left.

Using Monitor2

The Monitor2 utility lets you continue to work on your Macintosh while your document is printing. However, background printing is slower and may also slow down your system.

If you want to use this utility, you need to turn on background printing in the Chooser and increase the memory allocation for Monitor2. Follow these steps:

1. Open the Chooser from the Apple menu and select the EPSON Stylus(EX) icon. Then click either the printer or modem icon.
2. Under Background Printing, click On and close the Chooser.
3. To increase the memory allocated to Monitor2, select EPSON Monitor2 in the Extensions folder in your System folder.

4. Choose **Get Info** from the File menu.
5. Set the Memory Requirements to 2000K or 3000K, depending on your system's available RAM.
6. While you're printing, click the **EPSON Monitor2** icon on the Application menu at the right end of the menu bar. You see a dialog box like the following:

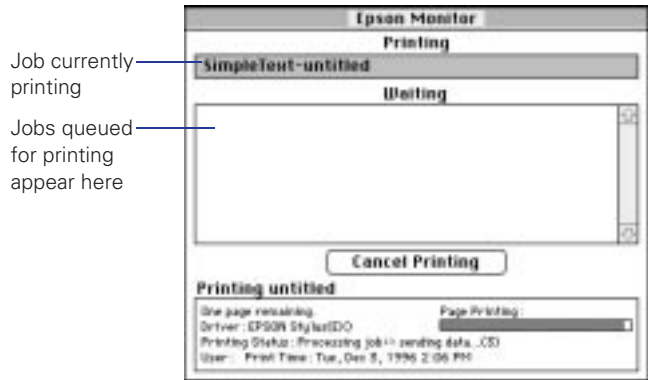

7. You can select a job and cancel it or just use this window to track the printer's progress.

Using the Macintosh Status Monitor

You can use the Status Monitor to check the level of ink in your printer and to control the way your software warns you about printer problems. Follow these steps:

1. Choose **Print** from the File menu or click the print icon in your application. You see the printer settings dialog box.

2. Click the Utility button. You see the Utility menu:

For information about these three utilities, see Chapter 5



3. Click the EPSON Status Monitor icon. The software checks the amount of ink remaining in the printer and displays the Status Monitor window:

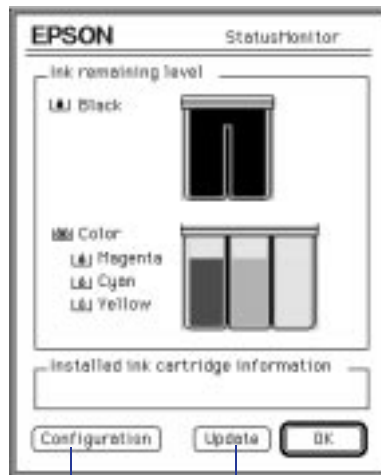

Click to control messages and warnings

Click to recheck ink level

4. If you want to change printer messages and warnings, click the **Configuration** button.

You see the following dialog box:

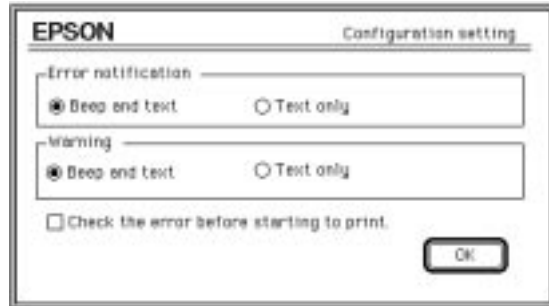

5. Choose the options you want and click OK.

Network Printing on a PC

You can use your printer on a network under Windows NT, Windows 95, or other network operating systems. First you need to set up your printer using either the network's printer setup functions or your printer software's built-in network support.

For instructions on using the printer software's network support, see "Using the Printer Software's Built-in Network Support."

Network Printing with Windows NT 4.0

If you connected the printer directly to a Windows NT 4.0 server, see your Windows NT documentation for instructions on configuring your printer for the network.

Using the Printer Software's Built-in Network Support

To use your printer software's built-in network support, you first need to install the printer driver software on all the network computers that will use the printer. See the *Setup Guide* for instructions. Once the printer software is installed, you can set up Spool Manager to send print job files from each computer to a shared directory on the computer connected to the printer.

Follow the steps in the next sections to set up a print job directory on the system connected to the printer (the host system) and each remote system (client) on the network. For Windows 95, you also need to specify the port and network path to the printer, as described on page 4-11.

Setting Up the Host System

Follow these steps to set up the computer connected to the printer:

1. Create an icon for the EPSON Spool Manager4 (EPSPMGR4.EXE in the \WINDOWS\SYSTEM folder or directory).
2. Place this icon in the Startup folder.
3. Double-click the EPSON Spool Manager4 icon to open the Spool Manager window.
4. Double-click the EPSON Stylus COLOR 600 print queue. The Queue Setup dialog box appears.
5. Click the **Remote Despool** tab and then click the **Printing from remote queues** option.
6. Click the **Browse** button and select the remote server directory that will receive print job files.
7. Click **OK** and minimize the Spool Manager window.

Setting Up Remote Systems

Follow these steps to set up the client computers on the network:

1. Open the Spool Manager window as described on page 4-2.
2. In the Spool Manager window, double-click the EPSON Stylus COLOR 600 print queue. The Queue Setup dialog box appears.
3. Click the **Spool to remote printer** button.
4. Click the **Browse** button and select the directory you're using for print job files on the host system.
5. Click **OK** and minimize the Spool Manager window.

Setting Up Your Network Path in Windows 95

If you want to use your printer on a network running Windows 95, you need to set up the port and network path on the computer connected to the printer. Follow these steps:

1. Double-click **My Computer**.
2. Double-click the **Printers** folder.
3. Right-click the EPSON Stylus COLOR 600 icon and choose **Properties**.

- Click the **Details** tab. The following dialog box appears:



Note:

If you want to print from DOS applications as well as from Windows applications, click the **Capture Printer Port** button instead of the **Add Port** button. In the **Device** box, select the printer port your printer is connected to, then specify the network path to the printer. Make sure **Reconnect at logon** is selected, then click **OK**.

- Click the **Add Port** button, then specify the network path to the printer and click **OK**.
- Open the **Spool Manager** window as described on page 4-2.
- In the **Spool Manager** window, double-click your printer's queue. The **Queue Setup** dialog box appears.
- Make sure the **Use Print Manager for this port** option is checked. Then click **OK**.

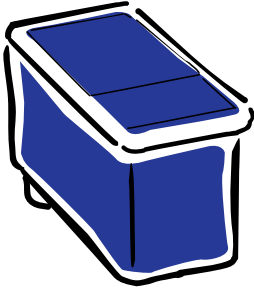

5

Maintenance and Transportation

It's easy to keep your EPSON Stylus COLOR 600 printer working at its best. Just follow the simple instructions in this chapter for replacing ink cartridges, moving the printer, and performing routine maintenance.

This chapter covers the following procedures:

- ▶ Cleaning the print heads
- ▶ Replacing an ink cartridge
- ▶ Aligning the print heads
- ▶ Cleaning the printer
- ▶ Transporting the printer

Cleaning the Print Heads

If your printed image is unexpectedly light or faint, or dots are missing from the image, you may need to clean the print heads. This unclogs the nozzles so they can deliver ink properly.

Cleaning the print heads uses ink, so clean them only if print quality declines. You can use either of the following to clean the print heads:

- ▶ The Head Cleaning utility in your printer software
- ▶ The printer's control panel buttons.



Note:
Wait until your printer has finished printing before using this utility.

Do not use this utility with printers on a network.







Caution:
Never turn off the printer while the  power light is flashing.

If however, the  power light is still flashing after 10 minutes and the printer is not moving or making noise, you may turn off the printer.

Using the Head Cleaning Utility





Follow these steps to run the utility from a Windows computer or a Macintosh:

1. Make sure the printer is turned on but not printing, and the  black and  color ink out lights are off.
2. Access the Main printer settings dialog box as described in Chapter 1.
3. Click the **Utility** tab (Windows) or the **Utility** button (Macintosh). You see the Utility menu.
4. Click the **Head Cleaning** icon.
5. Follow the instructions on the screen to clean the print heads. Cleaning each head takes about two minutes, during which the printer makes some noise and the  power light flashes.

When the  power light stops flashing, you need to run a nozzle check to test the print quality and reset the cleaning cycle.
6. Make sure paper is loaded in the printer and click **Print nozzle check pattern** (Windows) or **Confirmation** (Macintosh), and then click **Next**. See page 5-4 for instructions on examining the nozzle check pattern.

If your print quality has not improved, repeat the steps above. If you don't notice any improvement after doing this two or three times, check the print quality solutions in Chapter 6.

Using the Control Panel

1. Make sure the printer is turned on and not printing, and that the  black and  color ink out lights are off.
2. Press the  cleaning button and hold it for three seconds. Cleaning takes about two minutes, during which the printer makes some noise and the  power light flashes.
3. After the cleaning cycle is complete and the  power light stops flashing, you need to print a test page to test the print quality and reset the cleaning cycle.

If you're using DOS, open an application and print a document containing black and color data. Then go to step 7.

Otherwise, run a nozzle check. Go to step 4.

4. Access the Main printer settings dialog box as described in Chapter 1.
5. Click the **Utility** tab (Windows) or the **Utility** button (Macintosh), and then click **Next**. You see the Utility menu.
6. Click the **Nozzle Check** icon. See the next section for instructions on examining the nozzle check pattern.
7. If your print quality has not improved, repeat the steps above. If you don't notice any improvement after doing this two or three times, check the print quality solutions in Chapter 6.

Examining the Nozzle Check Pattern

Examine the nozzle check pattern you print. It should look something like this, with the lower pattern colored cyan, magenta, and yellow:

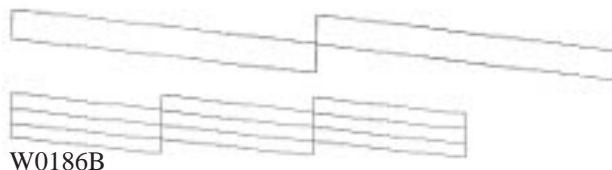

Each staggered horizontal and straight vertical line should be complete, with no gaps in the dot pattern. If your printout looks okay, you're done. If any dots are missing, clean the print heads again, as explained in the previous sections.





Caution:

For best results, don't replace an ink cartridge unless its ink out light is flashing or on.

If ink runs out, you can't continue printing, even if ink remains in the other cartridge.

To ensure good results, use genuine EPSON cartridges and do not refill them. Other products may cause damage to your printer not covered by EPSON's warranty.

Replacing an Ink Cartridge

When a  black or  color ink out light flashes, the indicated cartridge is low on ink. This is a good time to make sure you have a new cartridge. When the light stays on, the cartridge is empty and you need to replace it.

Use these EPSON ink cartridges within six months of installing them and before the expiration date on the package:

Black ink cartridge S020093

Color ink cartridge S020089

When you need new ink cartridges, contact your dealer or call EPSON Accessories at (800) 873-7766 (U.S. only). In Canada, please call (800) 873-7766 for dealer referral.

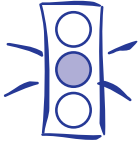

Caution:

If you press the  cleaning button when no ink out light is flashing or on, the printer cleans the print heads as described on page 5-8.

If you need to replace an ink cartridge before the lights flash (because the ink is too old, for example) follow the instructions on page 5-7.

Leave the old cartridge installed until you are ready to replace it with a new one. Attempting to print without a cartridge installed can damage your printer.



Once you remove an ink cartridge, it becomes unusable and cannot be reinstalled.





Warning:

If ink gets on your hands, wash them thoroughly with soap and water. If ink gets into your eyes, flush them immediately with water.

Removing an Empty Ink Cartridge

You can replace a cartridge when the  black or  color ink out light is either flashing or on. Follow these steps:

1. Make sure the printer is turned on and not printing.
2. Determine which cartridge needs to be replaced.
3. Lower the output tray and raise the printer cover.
4. Press the  cleaning button and hold it for three seconds.

The print heads move slightly left and the  power light begins flashing. (The print heads return to their home position if you don't proceed to step 5 within 60 seconds.)

5. Pull up the ink cartridge clamp. The cartridge rises up from its holder. (Although the illustration shows the color ink cartridge, the procedure is the same for replacing the black ink cartridge.)

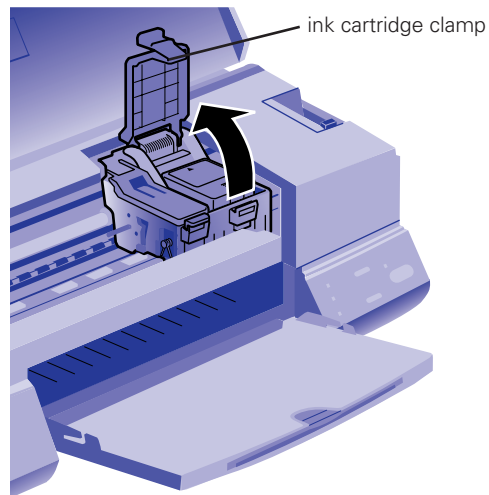

6. Lift the cartridge out of the printer and dispose of it carefully.
7. Follow the steps in the next section to install the new ink cartridge.

Installing the New Cartridge

Once you have removed the empty cartridge, you're ready to install the new one. Follow these steps:

1. Remove the new ink cartridge from its packaging.
2. Remove the yellow tape seal as shown:



Caution:
You must remove the yellow tape seal from the top of the cartridge; leaving the tape on will permanently damage it. Do not remove the clear seal from the bottom of the cartridge; ink will leak.

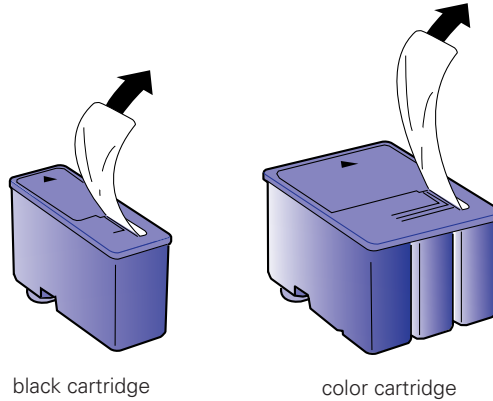

3. Lower the ink cartridge into its holder with the label facing up and the arrow pointing to the back of the printer. The larger cartridge (color) goes on the right, the black ink cartridge on the left.



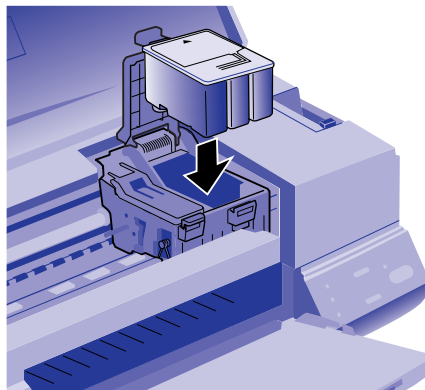

Caution:
Don't open the clamp or remove a cartridge except to replace it with a new one. Once you remove a cartridge, you can't reuse it, even if it contains ink.



4. Press down the ink cartridge clamp until it locks in place.



Caution:
Never turn off the printer while the  power light is flashing.

If however, the  power light is still flashing after 10 minutes and the printer is not moving or making noise, you may turn off the printer.



5. If you need to replace the other ink cartridge, remove it as described in “Removing an Empty Ink Cartridge” on page 5-5. Then follow steps 1 through 4 in this section.
6. Press the  cleaning button and close the printer cover.

The printer moves the print heads and begins charging the ink delivery system. (Even if you don't press the button, ink charging begins 60 seconds after you close the clamp.)

The  power light flashes and the printer makes various sounds. Charging takes about two minutes. When it's finished, you can print again.

Replacing an Outdated Ink Cartridge

If an ink cartridge is more than six months old, you may need to replace it. How can you tell? You may notice that your printouts don't look as good as they used to. If print quality doesn't improve after cleaning and aligning the print heads, you can replace one or both cartridges.

Follow these steps to replace an ink cartridge before the  black or  color ink out light is flashing or on:

1. Make sure the printer is turned on and not printing.
2. Lower the output tray and raise the printer cover.
3. Press the  load/eject button and hold it down for a few seconds until the print heads move to the left.
4. Pull up the ink cartridge clamp. The cartridge rises up from its holder.
5. Lift the cartridge out of the printer and dispose of it carefully.
6. Follow the steps in the previous section, “Installing the New Cartridge,” to install the new ink cartridge.



Caution:
To avoid damaging the printer, never move the print heads by hand.



Caution:

Load paper that's at least 8.3 inches wide so ink doesn't spray onto the platen.



Note:

Wait until your printer has finished printing before using this utility.

Do not use this utility with printers on a network.

Aligning the Print Heads

If your printouts contain misaligned vertical lines, you may need to align the print heads. Follow these steps:

1. Make sure the printer is turned on and paper is loaded.
2. Access the Main printer settings dialog box as described in Chapter 1.
3. Click the **Utility** tab (Windows) or the **Utility** button (Macintosh). You see the Utility menu.
4. Click the **Print Head Alignment** icon.
5. Follow the instructions on the screen to print a test page and select the correct alignment.



Caution:
Don't touch the gears
inside the printer.

Never use alcohol or
thinner for cleaning; they
can damage the printer
components and case.

Don't use a hard or
abrasive brush.

Don't get water on the
printer components.

Don't spray lubricants or
oils inside the printer.

Cleaning the Printer

To keep your printer working at its best, you should clean it several times a year, following these steps:

1. Turn off the printer, unplug the power cord, and disconnect the printer cable.
2. Remove all the paper from the sheet feeder.
3. Clean the exterior of the printer with a soft, damp cloth. Keep the printer cover closed so water doesn't get inside.
4. Clean ink out of the printer's interior with a soft, damp cloth.



Caution:
To avoid damage,
always leave the ink
cartridges installed when
transporting the printer.

Transporting the Printer

If you want to move your printer some distance, you need to prepare it for transportation and repack it in the original box. Follow these steps:

1. Turn on the printer and wait until the print heads lock in the far right position. Then turn off the printer.
2. Unplug the power cord from the electrical outlet. Then disconnect the interface cable from the printer.
3. Remove any paper from the sheet feeder and remove the paper support.
4. Push in the output tray extensions and close the tray.
5. Repack the printer and attachments in the original box using the protective materials that came with it. See the Notice Sheet that was packed with the printer.

Be sure to keep the printer level as you transport it. If you notice a decline in print quality after transporting the printer, clean the print heads; if output is misaligned, align the print heads. See the instructions in this chapter.

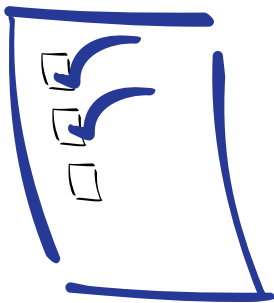

6

Troubleshooting

As you use your printer, you may occasionally experience a paper jam or other problem. The first thing you should do is diagnose the problem, following the guidelines in this chapter. Then try the most likely solutions until the problem is fixed.

This chapter tells you everything you need to know about the following:

- Diagnosing problems
- Improving print quality
- Solving printing problems
- Fixing paper jams and other paper problems
- Solving miscellaneous printout problems

Diagnosing Problems

Your printer includes a number of ways to help you diagnose problems:

- To identify the most common problems, check the lights on the printer's control panel. See "What To Do When the Printer Lights Flash" on page 1-11.
- You can also use the Status Monitor utility to identify common problems. For instructions, see page 4-4 (Windows 95) or page 4-7 (Macintosh).



- ▶ To determine whether the problem is caused by the printer itself, run a printer operation check. See “Running a Printer Check” for instructions.
- ▶ For the latest information, check the EPSON Stylus COLOR 600 Help program and the ReadMe file in the EPSON program group or folder.
- ▶ If none of the suggested solutions in this chapter solve your problem, contact EPSON as described under “Where to Get Help” in the Introduction.

Running a Printer Check

You can run a printer check to determine whether the problem comes from the printer itself or some other source.

- ▶ If the results are satisfactory, the problem lies in software settings, the interface cable, or your computer.
- ▶ If the printer check does not print correctly, you have a problem with your printer. See the suggestions in this chapter for possible solutions.

Follow these steps to check the printer:

1. Make sure both the printer and computer are turned off.
2. Disconnect the interface cable from the printer.
3. Make sure paper is loaded in the printer.
4. Hold down the  load/eject button and press the  power button to turn on the printer. Then release both buttons.

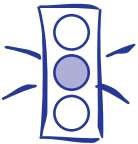

Caution:

Use paper that's at least 8.2 inches wide.

Otherwise the print head will spray ink directly onto the platen.

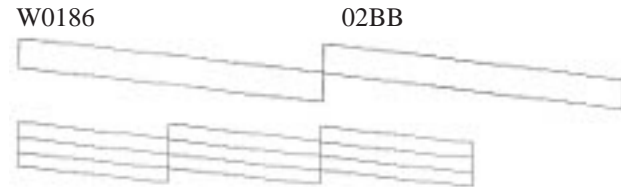

The printer prints one page containing a nozzle check pattern and the printer's ROM version. The following sample is in black and white, but the actual printout is in color.



5. After it prints the page, turn off the printer. Remember to reconnect the interface cable, then turn on the printer and your computer.



Improving Print Quality

You can often improve print quality by doing one of the following:

- Clean the print heads (see Chapter 5 for instructions).
- Use higher quality paper appropriate for your print job (see Chapter 3 for a list of EPSON papers).
- Match the **Media Type** setting in the printer software to the type of media you loaded in the printer (see Chapter 3 for details).
- Turn off **High Speed** mode in the More Settings dialog box (see Chapter 2 for details).
- Make sure **Economy** mode is off in the printer driver.
- Replace the ink cartridges. (Check the status of the  black and  color ink out lights first. See Chapter 5 for instructions.)

Here are some detailed solutions to specific print quality problems.

Printed image has horizontal banding



Possible cause	Solution
The Media Type setting doesn't match the loaded paper.	Make sure the Media Type setting matches the loaded paper or other media. Then the printer software can automatically select other settings for the best quality. See Chapters 1 and 3.
The printable side of the paper is face down.	Remove the paper and reload it with the printable side face up. See Chapter 3 for instructions.
The print head nozzles are clogged.	Clean the print heads. See Chapter 5 for instructions.
The ink cartridges are low on ink.	Check the  black and  color ink out lights to see which cartridge you may need to replace. See Chapter 5.
The MicroWeave option is not set.	Turn on MicroWeave in the advanced printer settings dialog box. See Chapter 2 for more information.

Vertical lines are misaligned or vertical banding appears



Possible cause	Solution
The print head nozzles are clogged.	Clean the print heads. See Chapter 5 for instructions.
High Speed mode is turned on.	Turn off High Speed mode if vertical lines are misaligned. See Chapter 2 for information.
The print heads are misaligned.	Run the Print Head Alignment utility. See Chapter 5 for instructions.

The printed image has incorrect or missing colors

Possible cause	Solution
The Ink option is set to Black .	Change the Ink setting to Color . See Chapter 1 for instructions.
The Media Type setting doesn't match the loaded paper.	Make sure the Media Type setting matches the paper or media you're using. Then the printer software can automatically select other settings for the best quality. See Chapters 1 and 3.
The printable side of the paper is face down.	Remove the paper and reload it with the printable side face up. See Chapter 3 for instructions.

Possible cause	Solution
The Halftoning and Color Adjustment Mode options are set incorrectly for your document type.	Use the correct settings for the project you are printing, following the instructions in Chapter 2.
The print head nozzles are clogged.	Clean the print heads. See Chapter 5 for instructions.
The ICM (Windows 95) or ColorSync (Macintosh) settings are incorrect for your document.	Use the Automatic mode setting or choose a different Rendering Intent setting (Macintosh). See Chapter 2 for more information.
The ink cartridges are low on ink or one or more ink colors are empty.	Check the  black and  color ink out lights to see which cartridge you may need to replace. See Chapter 5 for instructions.
The colors displayed on your monitor don't match the printed colors.	Because your monitor and printer use different technologies to represent colors, your printed colors cannot exactly match the colors you see on your monitor screen. Use the ICM (Windows 95) or ColorSync (Macintosh) settings. See Chapter 2 for more information.
The color settings in your application software need adjustment.	You may be able to adjust various color settings in your application software. See your software documentation for more information.

The printed image is faint or has gaps

Possible cause	Solution
The print head nozzles are clogged.	Clean the print heads. See Chapter 5 for instructions.
The Media Type setting doesn't match the loaded paper.	Make sure the Media Type setting matches the loaded paper or other media. Then the printer software can automatically select other settings for the best quality. See Chapters 1 and 3.
The loaded paper is damaged, old, or dirty.	Remove the paper and reload a new stack with the printable side face up. See Chapter 3 for instructions.
The ink cartridges are low on ink.	Check the  black and  color ink out lights to see which cartridge you may need to replace. See Chapter 5 for instructions.

The printed image is blurry or smeared

Possible cause	Solution
The printer's adjust lever is in the 0 position.	Set the adjust lever to the + position and try printing again. See Chapter 3 for instructions.
The paper is damp or the printable side is face down.	Remove the paper and reload a new stack with the printable side face up. See Chapter 3 for instructions.
You loaded special media without a support sheet.	Follow the special media loading instructions in Chapter 3 and on the paper packaging for media that require support sheets. Also try loading your media one sheet at a time.
You tried to print on cardboard or other non-recommended media.	Make sure your paper or media meets the specifications listed in the Appendix. If your printouts are still blurry after you change paper, clean the print heads as described in Chapter 5.
The Media Type setting does not match the loaded paper.	Make sure the Media Type setting matches the media you loaded. Then the printer software can automatically select other settings for the best quality. See Chapter 3 for information.
The sheets entering the output tray are smearing the ink on ejected pages.	Remove each sheet from the output tray as soon as it is printed to prevent smearing, especially if you use transparencies.
Ink has leaked inside the printer.	Clean carefully inside the printer to remove spilled ink. See Chapter 5 for instructions.
The color ink cartridge is empty.	Replace the color ink cartridge following the instructions in Chapter 5 or choose Black ink in your printer software.
You're using the High Speed and MicroWeave settings with a misaligned print head.	Turn off High Speed following the instructions in Chapter 2. Run the Print head Alignment utility following the instructions in Chapter 5.

Photographic images look grainy or rough

Possible cause	Solution
The print heads are misaligned.	Run the Print Head Alignment utility. See Chapter 5 for instructions.
The resolution of your image may be too low.	Increase the image resolution using your image-editing software, or decrease the size of the image.

Color documents print in black and white

Possible cause	Solution
Your printer is not selected in your application.	Select your printer and port in your software application.
Color printing is not selected.	Select color printing in your application and the printer driver.

Solving Printing Problems

If the printer won't print, first check that:

- ▶ The printer is turned on and the ⏻ power light is on.
- ▶ Paper is loaded in the printer.
- ▶ The printer is plugged into a working electrical outlet that's not controlled by a switch or timer.
- ▶ The interface cable is securely connected to the printer and computer and both are turned on.

If you still can't print, check the following solutions.

All lights are off

Possible cause	Solution
The printer is not receiving power.	Try these solutions: <ul style="list-style-type: none"> ▶ Make sure the printer is turned on. ▶ Turn off the power and plug in the power cord securely. ▶ Make sure the outlet is not controlled by a switch or timer and is operable.

Only the ⏻ power light is on, but nothing prints

Possible cause	Solution
The interface cable is not connected securely.	Turn off your printer and computer. Then make sure the cable is connected securely and meets the printer's specifications. Try printing again.
The printer has an internal problem.	Turn off the printer and computer, disconnect the interface cable, and run a printer check as described on page 6-2.

Possible cause	Solution
Your printer or application software is installed incorrectly.	If the printer check prints correctly, check your printer and application software for correct installation. If you're printing on a Windows 95 network, you may need to set up your printer for network printing, as described in Chapter 4.
Your computer doesn't have enough memory to handle the data in the file you are printing.	Try one of the following: <ul style="list-style-type: none">▶ Reduce the resolution of your image.▶ Select fewer colors or a lower resolution for your monitor.▶ Add more memory to your computer.
Printing is stalled in Spool Manager (Windows).	Delete the stalled print jobs in Spool Manager and resume printing; see Chapter 4 for instructions.
Printing is stalled in Monitor2 (Macintosh).	Open the Extensions folder, EPSON folder, and Spool folder. Then delete any queued files.
The print heads are clogged or the ink cartridges are too old.	If the printer sounds like it's trying to print but doesn't feed paper, clean the print heads; see Chapter 5 for instructions. If cleaning doesn't help, replace the cartridges. For information on cartridge life and replacement instructions, see Chapter 5.

The  paper out light is flashing or on

Possible cause	Solution
If flashing, paper is jammed.	Remove the paper and follow the guidelines for preventing jams on page 6-13.
If on, paper is not loaded or is loaded incorrectly.	Load paper or remove the stack and reload it as described in the <i>Setup Guide</i> or Chapter 3. Then press the  load/eject button to turn off the light and resume printing.

A  black or  color ink out light is flashing or on

Possible cause	Solution
If flashing, the ink supply is getting low.	You need to replace the indicated ink cartridge soon. Make sure you have a new cartridge, then see Chapter 5 for instructions.
If on, the ink cartridge is empty.	You must replace the indicated ink cartridge; see Chapter 5 for instructions.

The  paper and  power lights are flashing

Possible cause	Solution
A carriage error has occurred.	Remove any paper in the printer. Press the  load/eject button for about 30 seconds. Then press it again. Turn the printer off, wait a few seconds, and then turn it on and try printing again. If the error is not cleared, contact EPSON as described in the Introduction.

All the lights are flashing

Possible cause	Solution
You haven't removed all the packing material from the printer.	Remove the packing material, following the instructions on the Notice Sheet in the box.
An internal error may have occurred.	Turn off your printer, wait a few seconds, and turn it on again. If the lights still flash or stay on, contact EPSON as described in the Introduction.

The printer has finished charging the ink cartridge, but the  power light is still flashing

Possible cause	Solution
The ink cartridge clamp isn't locked down.	Press down on the clamp to lock it into place.
Packing material remains in the printer.	Remove the packing material, following the instructions on the Notice Sheet in the box.
The printer needs to initialize.	If the printer is not moving or making noise, but the light is still flashing for more than 10 minutes, turn the printer off. If the light is still flashing when you turn it back on, contact EPSON as described in the Introduction.

The printer software installed with Windows 3.1 does not work correctly after you upgrade to Windows 95

Possible cause	Solution
Your printer software is not set up correctly for Windows 95.	Reinstall the printer software after installing Windows 95, as described in the <i>Setup Guide</i> .

After you install your printing software, you see the Windows 95 New Hardware Found window

Possible cause	Solution
An operating system error has occurred.	Click Do not install a driver , and then click OK .

You see a spooling error message (Windows)

Possible cause	Solution
Spooling error messages or very slow printing may be caused by temporary files.	Change the Spool Manager default directory, following the instructions in Chapter 4.
Your hard drive is too full.	Delete unnecessary files to make room on the drive.
Your computer doesn't have enough memory for the file you're printing.	Try one of the following: <ul style="list-style-type: none">▶ Reduce the resolution of your image.▶ Select fewer colors or a lower resolution for your monitor.▶ Add more memory to your computer.

In Windows 95, the Status Monitor box does not appear with the Despooler

Possible cause	Solution
The Windows Print Manager is interfering with the Status Monitor.	Make sure Use Print Manager for this port is not checked in the Spool Manager Queue setup. Then check your bidirectional spool settings. See Chapter 4 for instructions.

You see a memory error message (Macintosh)

Possible cause	Solution
You may need to increase the memory allocation for your application, EPSON Monitor2, or both.	Choose Get Info from the File menu when your application is active and increase the memory requirements. See Chapter 4 for more information. Or turn off background printing (you won't be able to use Monitor2).

A portion of your image doesn't print (Macintosh)

Possible cause	Solution
Your system doesn't have enough available memory.	Close any other applications you are running or turn off background printing.
You may need to increase the memory allocation for your application, EPSON Monitor2, or both.	Choose Get Info from the File menu when your application is active and increase the memory requirements. See Chapter 4 for more information. Or turn off background printing (you won't be able to use Monitor2).

Printing is too slow

Possible cause	Solution
Your printer software options are set incorrectly.	For faster printing, try the following: <ul style="list-style-type: none"> ▶ Set Print Quality to Economy. ▶ Turn MicroWeave off. ▶ Turn High Speed on. ▶ Choose Black ink. ▶ Choose No Halftoning. See Chapters 1 and 2 for more information.
Your system doesn't have enough resources.	<ul style="list-style-type: none"> ▶ Clear space on your hard disk drive or run a defragmentation utility. ▶ Don't run too many applications at the same time. ▶ Turn off virtual memory. ▶ Increase your system's memory (RAM).
You're using background printing on a Macintosh.	Choose Get Info from the File menu when your application is active and increase the memory requirements. See Chapter 4 for more information. Or turn off background printing (you won't be able to use Monitor2).
Your port settings are incorrect in Windows 95.	Change your default spool directory and disable port settings as described in Chapter 4.

Your printer switches to the modem port or won't confirm on the printer port (Macintosh)

Possible cause	Solution
Your system has extension conflicts.	Make sure AppleTalk [®] is inactive. In the Extensions Manager, disable the AppleShare, FileShare, and PrinterShare extensions. Set your printer and any unused printers to the printer port. Then restart your system.
You're using an AppleTalk cable.	Make sure you're using a standard Apple System Peripheral-8 cable.

The “Sorry, EPSON Stylus COLOR cannot be used” message appears (Macintosh)

Possible cause	Solution
The printer driver has been corrupted.	Remove and reinstall the driver: <ol style="list-style-type: none">1. From the printer software CD-ROM or floppy disk, click Installer, click Continue, and select Custom Remove from the pop-up list that displays “Easy Install.”2. Select EPSON Stylus Series Printer Driver, and click Remove. Click Continue, if necessary, and click Restart.3. See the <i>Setup Guide</i> for instructions on installing the printer driver.4. In the Extensions Manager, make sure Quick Draw GX is not loaded.5. Make sure EPSON Monitor2 and EPSON Stylus Color(EX) are enabled, then restart your Macintosh.

Your printer icon doesn't appear in the Chooser (Macintosh)

Possible cause	Solution
Your system has extension conflicts.	In the Extensions Manager, disable Quick Draw GX. Make sure EPSON Monitor2 and EPSON Stylus Color are enabled, then restart your Macintosh.

Fixing Paper Problems

You can avoid most paper handling problems by doing the following:

- Use smooth, high-quality media designed for ink jet printers that meets the media specifications in the Appendix.
- Follow all loading and handling instructions included with the media.
- Load the media with the printable side face up, as described in the *Setup Guide* or Chapter 3.

If you have problems with paper feeding, paper jams, or ejected paper, check here for solutions.

Paper doesn't feed

Try this	Then do this
Remove the stack of paper from the sheet feeder.	<p>Check that the paper:</p> <ul style="list-style-type: none"> ▶ Isn't curled or creased. ▶ Isn't too old (see Chapter 3 or your paper packaging for more information). ▶ Isn't loaded above the arrow on the left edge guide. ▶ Isn't jammed inside the printer. (If the  paper out light is flashing, paper is jammed.) <p>Then reload the paper as described in Chapter 3, making sure the left edge guide is adjusted to fit the paper's width.</p>

Multiple pages feed at the same time

Try this	Then do this
Remove the stack of paper.	<ul style="list-style-type: none"> ▶ Make sure the paper isn't too thin (see the paper specifications in the Appendix). ▶ Fan the edges of the stack of paper to separate the sheets. ▶ Reload the paper as described in the <i>Setup Guide</i> and Chapter 3. ▶ If more copies of a page or document are printing than you expected, check the Copies settings in both the printer settings dialog box and your application program. See Chapter 1 for information.

Paper jams inside the printer

Try this	Then do this
Turn off your printer, open the cover, and remove all the paper that's inside, including any little pieces that may have torn off.	<p>Reload the paper as described in the <i>Setup Guide</i> and Chapter 3.</p> <p>If your paper jams frequently, make sure you:</p> <ul style="list-style-type: none"> ▶ Use smooth, high-quality paper, loaded printable side up. ▶ Fan the stack and then even the edges before loading it. ▶ Don't load paper above the arrow mark on the left edge guide. ▶ Adjust the left edge guide to fit the width of your paper.

Paper doesn't eject fully or is wrinkled

Possible cause	Solution
If the paper doesn't eject fully, you may have set the wrong paper size.	Press the  load/eject button to eject the paper. Then make sure you select the correct paper size in your application or printer software. (See the paper specifications in the Appendix for the paper sizes you can print with.)
If it's wrinkled when it comes out, the paper may be damp or too thin.	See the paper specifications in the Appendix for paper thicknesses you can print with, as well as environmental requirements for storage.

Solving Miscellaneous Printout Problems

If your printout results are not what you expected, try these solutions.

Characters are incorrect or garbled

Possible cause	Solution
Your printer is not the Windows default printer.	Select your printer as the default Windows printer. See your Windows documentation or online help for instructions.
Your printer is not selected in the Macintosh Chooser.	Open the Chooser and select your printer. See the <i>Setup Guide</i> for instructions.
Printing is stalled in Spool Manager (Windows).	Delete the stalled print jobs in Spool Manager following the instructions in Chapter 4. Then try printing again.
If you're using background printing on a Macintosh, spooled data may be corrupted.	Open the Extensions folder, EPSON folder, and Spool folder. Then delete any queued files. Increase the memory requirements for EPSON Monitor2.
The interface cable is not securely connected.	Turn off your printer and computer. Then make sure the cable is connected securely and meets the printer's specifications.
Your video driver may be conflicting with the EPSON driver (Windows 3.1 only).	Try using a standard VGA video driver (see your computer or video card documentation for instructions on changing video drivers). If your printout is correct, your video driver is interfering with the printer driver. Contact your computer or video card manufacturer to see if an updated driver is available.

The margins are incorrect

Possible cause	Solution
Margins are set incorrectly in your software application.	Check your software documentation for instructions on selecting the correct margins for your paper size. Make sure the margins are within the printable area of the page. See the Appendix for more information.
Paper settings in the printer software are incorrect for your paper size.	Select the correct paper settings for your paper size. See Chapter 1 for more information.

The image is inverted as if viewed in a mirror

Possible cause	Solution
You used a Flip Horizontal option in your application software or the printer software.	Turn off the Flip Horizontal or mirror setting in your application software or the printer software. See Chapter 2 for information.

The printer prints blank pages

Possible cause	Solution
Your printer is not the Windows default printer.	Select your printer as the default Windows printer. See your Windows documentation or online help for instructions.
Your printer is not selected in the Macintosh Chooser.	Open the Chooser and select your printer. See the <i>Setup Guide</i> for instructions.
Paper settings in the printer software are incorrect for your paper size.	Select the correct paper settings for your paper size. See Chapter 1 for more information.
The print head nozzles are clogged.	Clean the print heads following the instructions in Chapter 5.

A

Specifications

Printing

Printing method On-demand ink jet

Nozzle configuration Monochrome (black) 64 nozzles (32 × 2 staggered)
Color (cyan, magenta, yellow) 32 nozzles × 3

Printable columns and printing speeds

Character mode

Character pitch (characters per inch)	Printing column	Draft speed	LQ printing speed
10	80	400 cps	200 cps
12	96	480 cps	240 cps
15	120	600 cps	300 cps
17 (10 condensed)	137	684 cps	342 cps
20 (12 condensed)	160	800 cps	400 cps

cps = characters per second

Resolution Maximum 1440 dpi × 720 dpi

Print direction Bidirectional with logic seeking for text and graphics. (Auto print direction can be set in the default-setting mode.)

Control code ESC/P 2 and expanded raster graphics code

Line spacing 1/6 inch, 1/8 inch, or programmable in 1/360-inch increments

Paper feed speed 66.6 milliseconds per 1/6-inch line

Input buffer 32KB

Specifications

Fonts

Bitmap fonts

Font	10 cpi	12 cpi	15 cpi	Proportional
EPSON Roman	x	x	x	x
EPSON Sans Serif	x	x	x	x
EPSON Courier	x	x	x	
EPSON Prestige	x	x	x	
EPSON Script	x	x	x	

Select other font/pitch combinations using ESC/P 2 commands.
See the Command List on page A-9.

Scalable fonts

Font	Minimum point size	Maximum point size	Increments
EPSON Roman	8	32	2
EPSON Sans Serif	8	32	2
EPSON Roman T	8	32	2
EPSON Sans Serif H	8	32	2

Each font has four variations: normal, bold, italic, and bold italic.



Note:

The printer always uses the fonts you selected with your software application. You need to use the printer's internal fonts only if your application doesn't allow you to select fonts.

Character tables

These character tables are selected with the default setting mode (see page A-8 for instructions) or by using software commands.

- PC437 (U.S./Standard Europe)
- PC850 (Multilingual)
- PC860 (Portuguese)
- PC861 (Icelandic)
- PC863 (Canadian-French)
- PC865 (Nordic)
- Abicomp
- BRASCII
- Roman 8
- ISO Latin 1
- Italic

Character sets

14 international character sets and 1 legal character set

Paper

Paper type	Size	Paper types	Thickness	Weight
Single sheets	Letter (8.5 × 11 inches) A4 (210 × 297 mm) A5 (148 × 210 mm) B5 (182 × 257 mm) Legal (8.5 × 14 inches) Statement (5.5 × 8.5 inches) Executive (7.5 × 10 inches)	Plain bond paper and special ink jet papers distributed by EPSON	0.003 to 0.004 inch (0.08 to 0.11 mm)	17 to 24 lb (64 to 90 g/m ²)
Transparencies, Glossy film, Glossy paper, Photo paper	Letter (8.5 × 11 inches) A4 (210 × 297 mm) A6 (105 × 148 mm, glossy film only) 4 × 6 inches (102 × 152 mm photo paper only)	Transparencies, glossy paper, glossy film, and photo paper distributed by EPSON	Glossy film and transparencies: 0.005 to 0.006 inch (0.13 to 0.15 mm) glossy paper: 0.0066 to 0.0070 inch (0.17 to 0.18 mm)	
Self adhesive sheet	A4 (210 × 297 mm)	Self adhesive sheets distributed by EPSON		
Envelopes	No. 10 9.5 × 4.1 inches (240 × 104 mm) DL 8.7 × 4.3 inches (220 × 110 mm) C6 4.4 × 6.4 inches (114 × 162 mm)	Plain bond paper or air mail paper	0.006 to 0.017 inch (0.16 to 0.43 mm)	12 to 20 lb (45 to 75 g/m ²)
Index cards	A6 (105 × 148 mm) 10 × 8 inches (254 × 203 mm)	Ink jet cards distributed by EPSON	0.0091 inch (0.23 mm)	50.7 lb (188 g/m ²)



Note:

Since the quality of any particular brand or type of paper may be changed by the manufacturer at any time, EPSON cannot attest to the quality of any non-EPSON brand or type of paper. Always test samples of paper stock before purchasing large quantities or printing large jobs.

Poor quality paper may reduce print quality and cause paper jams and other problems. If you encounter problems, switch to a higher grade of paper.

Do not load curled or folded paper.

Ink jet paper, envelopes, glossy film, glossy paper, and transparencies are usable only under normal conditions:

Temperature: 59 to 77 °F (15 to 25 °C)
Humidity: 40 to 60% RH

EPSON Photo Quality Glossy Paper and Photo Quality Self Adhesive Sheets should be stored under the following conditions:

Temperature: 59 to 86 °F (15 to 30 °C)
Humidity: 20 to 60% RH

Specifications

Printable area

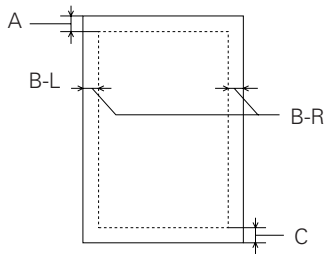

Single sheet

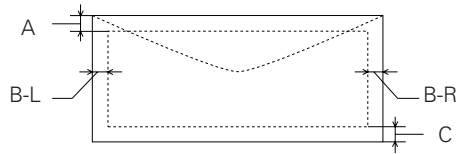

Envelope

A: The minimum top margin is 0.12 inch (3.0 mm).

When loading multiple sheets of EPSON Photo Quality Glossy Film, the minimum top margin is 1.2 inches (30 mm).

B-L: The minimum left margin is 0.12 inch (3.0 mm).

B-R: The minimum right margin for single sheet paper is 0.12 inch (3.0 mm) except for letter and legal size paper. The minimum right margin for letter and legal size paper is 0.35 inch (9.0 mm).

The minimum right margin for envelopes is as follows:

0.28 inch (7.0 mm) for DL envelopes.

1.10 inches (28.0 mm) for No. 10 envelopes.

0.12 inch (3.0 mm) for C6 envelopes.

C: The minimum bottom margin is 0.54 inch (14.0 mm)

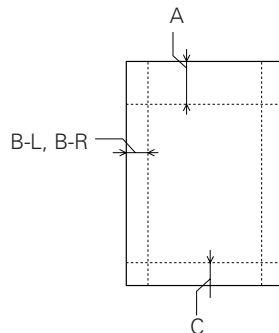

EPSON Photo Paper
(dotted lines indicate
perforations)

A: The maximum top margin is 0.67 inch (17.0 mm).

B-L,

B-R: The maximum left and right margin is 0.24 inch (6.1 mm).

C: The maximum bottom margin is 0.24 inch (6.1 mm).



Note:

Always load paper into the sheet feeder short edge first. However, envelopes should be loaded long edge first.

Ink Cartridge

Specification	Black ink cartridge (S020093)	Color ink cartridge (S020089)
Color(s)	Black	Cyan, Magenta, and Yellow
Print capacity*	540 pages/A4 (ISO/IEC 10561 Letter Pattern at 360 dpi)	300 pages (A4, 360 dpi, 5% duty each color)
Cartridge life	2 years from production date (if unopened) (within 6 months after opening package, at 77 °F (25 °C))	
Storage temperature	-4 to 104 °F (-20 to 40 °C) 1 month at 104 °F (40 °C)	
Transit temperature	-22 to 140 °F (-30 to 60 °C) 1 month at 104 °F (40 °C) 120 hours at 140 °F (60 °C)	
Freezing temperature**	3.2 °F (-16 °C)	-0.4 °F (-18 °C)
Dimensions	0.7 (W) × 2.1 (D) × 1.5 (H) inches 19.8 (W) × 52.7 (D) × 38.5 (H) mm	1.7 (W) × 2.1 (D) × 1.5 (H) inches 42.9 (W) × 52.7 (D) × 38.5 (H) mm

* The print capacity may vary, depending on how often you use the print head cleaning function.

** It thaws and is usable after approximately 3 hours at 77 °F (25 °C).



Caution:

To ensure good results, use genuine EPSON ink cartridges. Other products may cause damage to your printer not covered by EPSON's warranty.

Don't use an ink cartridge if the date on the package has expired.

Mechanical

Paper feed method	Friction
Paper path	Sheet feeder, rear entry
Sheet feeder capacity	100 sheets at 17 lb (64 g/m ²) paper
Total print volume	75,000 pages (A4, Text)
Dimensions	
Storage	Width: 16.9 inches (429 mm) Depth: 10.8 inches (275 mm) Height: 6.6 inches (168 mm)
Printing	Width: 16.9 inches (429 mm) Depth: 24.1 inches (613 mm) 27.4 inches (695 mm) when printing transparencies Height: 12.2 inches (309 mm) 7.7 inches (196 mm) when printing transparencies
Weight	11.5 lb (5.2 kg) without the ink cartridges

Electrical

Specification	120V Model	220–240V Model
Input voltage range	103.5 to 132V	198 to 264V
Rated frequency range	50 to 60 Hz	
Input frequency range	49.5 to 60.5 Hz	
Rated current	0.4A	0.2A
Power consumption	Approx. 15W (ISO/IEC 10561 Letter Pattern)	



Note:
Check the label on the back of the printer for the voltage of your printer.

Environmental

Temperature
Operation: 50 to 95 °F (10 to 35 °C)
Storage: -4 to 140 °F (-20 to 60 °C), stored in shipping container
1 month at 104 °F (40 °C)
120 hours at 140 °F (60 °C)

Humidity
Operation: 20 to 80% RH
Storage: 5 to 85% RH (stored in shipping container, without condensation)

Safety Approvals

Safety standards UL 1950 with D3, CSA C22.2 No.950 with D3
EMC FCC part 15 subpart B class B, CSA C108.8 class B

Interface

Your printer is equipped with an 8-bit parallel interface and a serial interface.

Parallel interface The built-in parallel interface has the following characteristics:

Forward channel

Data format: 8-bit parallel, IEEE-1284 compatibility mode

Synchronization: $\overline{\text{STROBE}}$ pulse

Handshake timing: BUSY and $\overline{\text{ACKNLG}}$ signals

Signal level: TTL compatible

Connector: 57-30360 Amphenol connector or equivalent

Reverse channel

Transmission mode: IEEE-1284 Nibble mode

Adaptable connector: 57-30360 Amphenol Connector or equivalent

Synchronization: Refer to the IEEE-1284 specification

Serial interface

Handshaking: Refer to the IEEE-1284 specification

Signal level: IEEE-1284 Level 1 device

Data transmission timing: Refer to the IEEE-1284 specification

The printer's built-in serial interface is based on the RS-423 standard. This interface has the following characteristics:

Standard: Based on RS-423

Synchronization: Synchronous

Bit rate: Approx. 900 Kbps

Handshaking: X-ON/X-OFF DTR protocol

Word format:

Data bit: 8 bits

Parity bit: None

Start bit: 1 bit

Stop bit: 1 bit

Connector: 8-pin mini-circular connector

Recommended cable: Apple System Peripheral-8 cable (Part number M0197)

Initialization

The printer can be initialized (returned to a fixed set of conditions) in these ways:

Hardware initialization	* The printer is turned on. * The printer receives an $\overline{\text{INIT}}$ signal from the parallel interface.
Software initialization	* Software sends the ESC @ (initialize the printer) command. The last panel settings are kept.

Hardware initialization

When the printer is turned on, the printer mechanism is initialized, the input and print buffers are cleared, and all settings return to their default values. However, the printer mechanism is not initialized if the printer is turned on within 10 seconds after being turned off. In this case, the printer caps the print head, and ejects any paper in the paper path.

Software initialization

Software initialization clears the print buffer and returns all settings to their default values, as shown below.

Default Settings

The table below shows the default settings that take effect when the printer is initialized. To change these settings, follow the instructions in “Built-in Fonts and Character Tables.”

Item	Default setting
Top-of-form position	Current paper position
Page length	Single sheets: 22 inches
Left and right margins	Cancelled
Line spacing	1/6-inch line spacing
Character pitch	Last font selected using default setting mode
Vertical tab position	Cleared
Horizontal tab positions	Every eight characters
Font selection	Last font selected using default setting mode
Special printing effects	Cancelled (except condensed and economy printing)
User-defined character set	Hardware/control panel initialization: cleared Software initialization: deselected only

Built-in Fonts and Character Tables



Your printer has eight built-in fonts and eleven character tables that you can select using the printer’s default setting mode as described below. The setting you choose takes effect each time you turn on the printer. Available fonts and character tables are listed on page A-2.



Note:

The font and character table selections you make with your software override the settings you make using the default setting mode. For best results, use your software to make these settings.

To change the default font or character table, follow these steps:

1. Make sure the printer is turned off and paper is loaded in the sheet feeder. (Use paper at least 8.3 inches wide. Otherwise the print heads will spray ink directly onto the platen.)
2. Hold down the  cleaning button and turn on the printer.
The printer loads a sheet of paper and prints a brief summary and instructions.
3. Follow the instructions on the sheet and press the  cleaning button until the control panel lights indicate the language of your choice.

4. Press the  load/eject button to print the default font and character table and the next page of instructions.

The instruction sheet lists all of the fonts and character tables you can select.

5. Select the font and character table you want to use.
6. Exit the default setting mode by turning off the printer.

If you want to check the current default font and character table, enter the default setting mode again and print the current settings, which are indicated by arrows.



Note:

You may exit default setting mode any time by turning off the printer. Any changes you made remain in effect until you change them again.

Command List

This section lists the available printer commands by topic. Your printer works with the following commands.

ESC/P 2 control codes

Selecting EPSON ESC/P 2 printer in your software allows you to use the most advanced font and graphics handling available. See the *ESC/P® Reference Manual* for details.

General operation	ESC @, ESC U, ESC EM
Paper feeding	CR, FF, LF, ESC 0, ESC 2, ESC 3, ESC +
Page format	ESC (C, ESC C, ESC C0, ESC Q, ESC I, ESC (c, ESC N, ESC O
Print position motion	ESC \$, ESC \, ESC (V, ESC (v, ESC D, HT, ESC B, VT, ESC J
Font selection	ESC k, ESC x, ESC X, ESC P, ESC M, ESC g, ESC p, ESC 4, ESC 5, ESC E, ESC F, ESC !
Font enhancement	ESC W, DC4, SO, DC2, SI, ESC w, ESC G, ESC H, ESC T, ESC S, ESC -, ESC (-, ESC q
Spacing	ESC Space, ESC c, ESC (U
Character handling	ESC t, ESC (t, ESC R, ESC %, ESC &, ESC :, ESC 6, ESC 7, ESC (^
Bit image	ESC *
Graphics	ESC (G, ESC ., ESC (i, ESC (e, ESC (\, ESC (s
Color	ESC r, ESC (r
Printing mode	ESC (K

Glossary

- banding** The horizontal lines that sometimes appear when printing graphics. See also *MicroWeave*.
- buffer** The portion of the printer's memory used to store data before printing it.
- character table** A collection of letters, numbers, and symbols that provides you with the characters used in a particular language.
- characters per inch (dpi)** A measure of the size of text characters, sometimes referred to as pitch.
- CMYK** Cyan (blue-green), magenta, yellow, and black. These colored inks are used to create the subtractive system array of printed colors.
- ColorSync** Macintosh software that is designed to help you get WYSIWIG (what you see is what you get) output. This software prints colors as you see them on your screen.
- default** A value or setting that takes effect when the equipment is turned on, reset, or initialized.
- dithering** A halftoning method in which dots are arranged in an orderly pattern. Dithering works best for printing images with solid colors, such as charts and graphs. See also *halftoning*.
- dpi** Dots per inch. The dpi measures the resolution. See also *resolution*.
- driver** A software program that sends instructions to a computer device to tell it what to do. For example, your printer driver accepts print data from your word processing application and sends instructions to the printer on how to print this data.

- Error Diffusion** This halftoning setting smooths out edges by randomly placing dots of varying colors. This has the opposite effect of the Finest Detail setting.
- ESC/P** Abbreviation for Epson Standard Code for Printers. This system of commands gives you control of your printer from your computer. It is standard for all EPSON printers and supported by most application programs for personal computers.
- ESC/P 2** The enhanced version of the ESC/P printer command language. Commands in this language produce laser-like features, such as scalable fonts and enhanced graphics printing.
- Finest Detail** This printer driver setting automatically makes your printed images sharper and clearer. This has the opposite effect of the Error Diffusion setting. Be aware that this may increase the time required for printing.
- font** A style of type designated by a name.
- grayscale** A scale of shades of gray from black to white. Grayscale is used to represent colors when printing with black ink only.
- halftoning** A method of using dot patterns to represent an image. Halftoning makes it possible to produce varying shades of gray using only black dots, or a nearly infinite array of colors using only a few colors of dots.
- initialization** Returns the printer to its defaults (fixed set of conditions). This happens every time you turn on or reset the printer.
- ink jet** A method of printing in which each letter or symbol is formed by precisely spraying ink onto paper.
- interface** The connection between the computer and a peripheral such as a printer. Some printers have two interfaces, parallel and serial. A parallel interface transmits data one byte, or eight bits, at a time. A serial interface transmits data one bit at a time.
- ips** Inches per second. This scale is used to measure the printing speed.

media	Materials upon which data is printed, such as envelopes, plain paper, special paper, and transparencies.
MicroWeave	Printing technology that produces images in fine increments to reduce the possibility of banding. See also <i>banding</i> .
monochrome	This means printing with only one color of ink, which is generally black ink.
parallel interface	See <i>interface</i> .
print queue	Print jobs that are sent to the printer while it is busy are stored in a waiting line, or print queue, until they can be printed.
print server	The computer connected to the printer. It receives the jobs and then distributes them to the assigned printer. It also holds extra print jobs while the printer is busy. See also <i>print queue</i> .
printable area	The area of a page on which the printer can print. It is smaller than the physical size of the page due to margins.
printer driver	See <i>driver</i> .
proportional printing	Printing in which the width of the character varies from character to character. For example, a capital <i>W</i> receives much more space than a lowercase <i>i</i> . The result looks more like a typeset book than a typewritten draft.
reset	To return a printer to its defaults either by sending a command, an $\overline{\text{INIT}}$ signal or by turning the printer off and then back on.
resolution	The number of dots per inch used to represent an image.
RGB	Red, green, and blue. These colors, in phosphors irradiated by the computer monitor's electron gun, are used to create the additive array of screen colors.
scalable fonts	Fonts that can be enlarged or reduced. Non-scalable fonts are called bitmap fonts and can't change in size.
screen pattern	This feature prints shaded areas as they appear on screen, instead of printing them as halftones.

- serial interface** See *interface*.
- spool** The process by which the printer driver converts the print data into codes that your printer understands. This data is then sent to the printer directly or to the print server.
- Spool Manager** An EPSON software program that converts print data into codes that your printer understands. See also *spool*.
- Status Monitor** An EPSON software program that displays the printer's status, such as paper out or the amount of ink remaining before printing.
- subtractive colors** Colors produced by pigments that absorb some colors of light and reflect others. See also *CMYK*.

Index

- A**
- Adjust lever, 3-9
 - Advanced mode and halftoning, 2-6
 - Advanced mode, selecting, 2-1 to 2-3
 - Advanced settings
 - custom, 2-4 to 2-12
 - predefined, 2-1 to 2-3
 - Aligning print heads, 5-8, 6-4
 - Automatic mode, 1-3, 1-8, 3-3
- B**
- Background printing, Macintosh, 4-6
 - Banding, 6-4
 - Banners
 - loading paper, 3-9 to 3-10
 - printing from Macintosh, 3-12 to 3-13
 - printing from Windows, 3-10 to 3-12
 - Blank pages, 6-15
 - Blurry printouts, 6-6
 - Brightness setting, 2-8
 - Built-in fonts, A-8
- C**
- Cards, *see* Photo Quality Ink Jet Cards
 - Character tables, A-8
 - Characters, garbled, 6-14
 - Cleaning
 - print heads, 5-1 to 5-3
 - printer, 5-9
 - sheets, special media, 3-4
 - Color Adjustment modes, 2-8
 - Color problems, 6-4
 - Colorimetric setting, 2-10
 - ColorSync, 2-3, 2-9 to 2-10
 - CompuServe, 5
 - Contrast setting, 2-8
 - Control codes, A-1, A-9
 - Control panel
 - buttons, 1-12
 - lights, 1-11
 - using, 1-11 to 1-12, 6-1 to 6-2, 6-7 to 6-9
 - Copies setting, 1-4
 - Custom paper size, 3-9, 3-11, 3-13
 - Custom settings
 - changing, 2-12
 - color, 2-7 to 2-9
 - deleting, 2-12
 - print quality, 2-4 to 2-6
 - project types, 2-3
 - refining, 2-12
 - saving, 2-11
 - special effects, 2-4 to 2-6
 - Cyan setting, 2-8
- D**
- Default printer options, setting, 1-4 to 1-5
 - Deleting print job, 4-3
 - Despooler, 1-6, 4-5
 - Dithering, 2-6
 - DOS, printing from, 1-9
 - Draft printing, 2-3
 - Driver, help, 1-12 to 1-13

- E** Economy setting, 2-3
Electrical specifications, A-6
ENERGY STAR, 6 to 7
Energy-saving tips, 7
Envelopes
 printing, 3-8
 printing on, 3-2
 specifications, A-3, A-4
Environmental specifications, A-6
EPSON
 Answers, 2
 Customer Care Centers, 5
 Electronic support services,
 5 to 6
 help, 5 to 6
 media, 1-10, 3-1 to 3-9
 World Wide Web site, 5
ESC/P 2, 1-9, A-9
- F** Faint printouts, 6-5, 6-6
Film, *see* Photo Quality Glossy
 Film
Flip Horizontal setting, 2-6, 3-3,
 6-15
Fonts, A-2
Forms, printing, 3-4
FTP, 5
- G** Glossy media
 choosing, 1-10
 printing on, 3-5
 specifications, A-3
- H** Halftoning setting, 2-5, 2-6
Head Cleaning utility, 5-2
Help, EPSON, 5 to 6
Help, online, 1-12 to 1-13
High quality glossy paper, *see*
 Photo Quality Glossy Film
- High Quality Ink Jet Paper
 choosing, 1-10
 printing on, 3-2, 3-4
 specifications, A-3
Horizontal banding, 6-4
Host system, network setup, 4-10
- I** ICM (Image Color Matching), 2-3,
 2-7 to 2-9
Index cards, *see* Photo Quality Ink
 Jet Cards
Initialization, A-7
Ink cartridge
 replacing, 5-4 to 5-7
 specifications, A-5
Ink jet cards
 choosing, 1-10
 printing on, 3-2, 3-7
 specifications, A-3
Ink jet paper
 choosing, 1-10
 printing on, 3-2, 3-4
 specifications, A-3
Ink jet transparencies
 choosing, 1-10
 printing on, 3-3
 specifications, A-3
Ink setting, 2-5
Ink, monitoring level, 1-6, 4-5, 4-8
Interface specifications
 parallel, A-6
 serial, A-7
Internet, 5
Iron-On Transfer Paper
 choosing, 1-10
 printing on, 2-6, 3-3, 3-8
- J** Jammed paper, 1-11, 6-13

- L** Labels
 printing on, 3-2
 specifications, A-3
 Legal-size paper, 3-4
 Letterhead, 3-4
 Lever, adjust, 3-9
 Lights, using, 1-11, 6-1, 6-7 to 6-9
- M** Macintosh
 interface specifications, A-7
 managing print jobs from,
 4-6 to 4-9
 Monitor2, 4-6
 printing from, 1-7 to 1-8
 problems, 6-8, 6-10 to 6-12
 Magenta setting, 2-8
 Maintaining printer, 5-1 to 5-9
 Managing print jobs
 Macintosh, 4-6 to 4-9
 Windows, 4-1 to 4-5
 Margins
 problems, 6-15
 specifications, A-4
 with multiple sheets, 3-5
 Mechanical specifications, A-5
 Media Type setting, 1-3, 2-5, 3-2
 Messenger service, Windows NT,
 4-5
 MicroWeave setting, 2-6
 Mirror images, 2-6, 3-3
 Monitor2, 4-6, 6-8
 Moving printer, 5-10
- N** Network
 path, 4-11 to 4-12
 printing, 4-9 to 4-12
 Nozzle Check
 pattern, 5-4, 6-3
 utility, 5-2 to 5-4
- O** Online driver help, 1-12 to 1-13
 Orientation setting, 1-4
- P** Paper
 adjust lever, 3-9
 handling problems,
 6-12 to 6-14
 jams, 1-11, 6-13
 legal, 3-4
 letterhead, 3-4
 loading guidelines, 3-2 to 3-9
 menu, 1-4
 specifications, A-3 to A-4
 support, 3-5
 thickness lever, *see* Adjust lever
 Paper size, custom, 3-9
 Perceptual setting, 2-10
 Perfect Picture Software Suite, 2, 3
 Photo Paper, EPSON
 choosing, 1-10
 printing on, 3-2, 3-6 to 3-7
 specifications, A-3
 Photo Quality Glossy Film
 choosing, 1-10
 printing on, 3-3, 3-5
 specifications, A-3
 Photo Quality Glossy Paper
 choosing, 1-10
 printing on, 3-2, 3-5
 specifications, A-3
 Photo Quality Ink Jet Cards
 choosing, 1-10
 printing on, 3-2, 3-7
 specifications, A-3
 Photo Quality Ink Jet Paper
 choosing, 1-10
 printing on, 3-2, 3-4
 specifications, A-3
 Photo Quality Self Adhesive Sheets
 choosing, 1-10
 printing on, 3-2
 specifications, A-3
 Photo setting, 2-3
 PhotoEnhance setting, 2-3, 2-9
 Predefined advanced settings,
 2-1 to 2-3
 Print Head Alignment utility, 5-8,
 6-4
 Print job, deleting, 4-3
 Print quality problems, 6-3 to 6-7

- Print Quality setting, 2-5
- Print queue, 4-2
- Printable area, A-4
- Printer driver, accessing
 - Control Panel, 1-4 to 1-5
 - Windows applications, 1-2
- Printer operation check, 6-2
- Printer software, using,
 - 1-12 to 1-13
- Printer status, Windows, 1-6
- Problems
 - diagnosing, 6-1 to 6-2
 - paper handling, 6-12 to 6-14
 - print quality, 6-3 to 6-7
 - printing, 6-7 to 6-12
 - solving, 6-1 to 6-15
 - unexpected printout results,
 - 6-14 to 6-15

Q Quality/Speed slider, 1-3

R Remote systems, network setup,

- 4-11

Removing driver, 6-12
Rendering Intent setting, 2-10
Replacing ink cartridges, 5-4 to 5-7
Resolution, 2-5, A-1

S Safety

- approvals, A-6
- instructions, 7 to 9

Saturation setting, 2-8, 2-10
Self adhesive sheets

- choosing, 1-10
- printing on, 3-2, 3-7
- specifications, A-3

Self test, *see* Printer operation check
Service, 5 to 6
Single sheets, printing, 3-2
Smears, 3-9

Specifications

- electrical, A-6
- environmental, A-6
- ink cartridge, A-5
- interface, A-6
- mechanical, A-5
- paper, A-3 to A-4
- printing, A-1 to A-2

Spool directory, 4-3
Spool Manager

- problems, 6-8, 6-10, 6-14
- Windows, 4-1 to 4-4

Status Monitor

- Macintosh, 4-7
- problems, 6-1, 6-10
- Windows, 1-6, 4-4

Support, 5 to 6
System requirements

- Macintosh, 3
- Windows, 2

T Technical specifications,

- A-1 to A-7

Testing printer, 6-2
Text/Graph setting, 2-3
Transfer paper

- choosing, 1-10
- printing on, 2-6, 3-3, 3-8

Transparencies

- choosing, 1-10
- printing on, 3-3, 3-5
- specifications, A-3

Transporting printer, 5-10
Troubleshooting, 6-1 to 6-15

U User Defined paper size, 3-11
Utilities

- Head Cleaning, 5-2
- Nozzle Check, 5-2 to 5-4
- Print Head Alignment, 5-8

- W** What's This prompt, 1-13
- Windows
 - managing print jobs from, 4-1 to 4-5
 - network printing, 4-9 to 4-12
 - printing from, 1-1 to 1-4
- Windows 95
 - ICM, 2-7 to 2-9
 - Spool Manager, 4-1 to 4-4
- Windows NT
 - online help, 1-13
 - setting default printer options, 1-5
- World Wide Web, 5

- Y** Yellow setting, 2-8