



WF-5620 User's Guide

Contents

WF-5620 User's Guide	13
Product Basics	14
Using the Control Panel	14
Control Panel Buttons and Lights	14
Status Icon Information	15
Status Button Information	17
Setting a Password and Locking the Control Panel	17
Entering Characters on the LCD Screen.....	19
Using Presets.....	20
Changing LCD Screen Language.....	22
Adjusting Control Panel Sounds	23
Adjusting the Screen Brightness.....	23
Turning Off the Operation Time Out Setting	24
Product Parts Locations	25
Product Parts - Top.....	26
Product Parts - Inside	28
Product Parts - Back.....	29
Using Eco Mode and Other Power Saving Settings	30
Changing the Eco Settings	30
Changing the Sleep Timer Settings	31
Changing the Power Off Timer Settings	32
Epson Connect Solutions for Smartphones, Tablets, and More	33
Using Epson Email Print	33
Using the Epson iPrint Mobile App	33
Using Epson Remote Print	34
Using Epson Scan to Cloud.....	34
Using AirPrint	35
Using Google Cloud Print.....	35
Wi-Fi or Wired Networking	37
Wi-Fi Infrastructure Mode Setup.....	37

Selecting Wireless Network Settings From the Control Panel	38
Wi-Fi Direct Mode Setup	41
Enabling Wi-Fi Direct Mode	42
Wi-Fi Protected Setup (WPS).....	44
Using WPS to Connect to a Network	45
Printing a Network Status Sheet.....	46
Changing or Updating Network Connections	48
Accessing the Web Config Utility	48
Changing a USB Connection to a Wi-Fi Connection.....	48
Changing a Wi-Fi Connection to a Wired Network Connection.....	49
Connecting to a New Wi-Fi Router	49
Disabling Wi-Fi Features	50
Loading Paper	51
Loading Paper in the Cassette	51
Loading Paper and Envelopes in the Rear Paper Feed Slot	55
Paper Loading Capacity	60
Available Epson Papers	61
Selecting the Paper Settings for Each Source - Control Panel	63
Paper Type Settings	64
Selecting Default Paper Settings - Administrator.....	65
Selecting the Default Printer Settings	65
Paper Source Settings Options.....	67
Setting the Universal Print Settings	67
Universal Print Settings Options	69
Installing and Enabling the Optional Second Paper Cassette	69
Installing the Optional Second Paper Cassette	70
Placing Originals on the Product	71
Placing Originals on the Scanner Glass	71
Placing Originals in the Automatic Document Feeder	72
Copying	75
Copying Documents or Photos.....	75
Copying Options.....	76

Printing from a Computer	79
Printing with Windows	79
Selecting Basic Print Settings - Windows	79
Paper Source Options - Windows	81
Print Quality Options - Windows	82
Multi-Page Printing Options - Windows.....	82
Selecting Double-sided Printing Settings - Windows	83
Double-sided Printing Options - Windows.....	85
Print Density Adjustments - Windows	86
Selecting Additional Layout and Print Options - Windows	87
Custom Color Correction Options - Windows.....	89
Image Options and Additional Settings - Windows.....	90
Header/Footer Settings - Windows	90
Selecting a Printing Preset - Windows.....	91
Selecting Extended Settings - Windows	93
Extended Settings - Windows	94
Printing Your Document or Photo - Windows.....	95
Selecting Default Print Settings - Windows.....	96
Changing the Language of the Printer Software Screens	97
Changing Automatic Update Options	98
Printing with OS X	99
Selecting Basic Print Settings - OS X	100
Paper Source Options - Mac OS X.....	103
Print Quality Options - OS X.....	103
Print Options - OS X.....	104
Selecting Page Setup Settings - OS X.....	104
Selecting Print Layout Options - OS X.....	105
Selecting Double-sided Printing Settings - OS X	106
Double-sided Printing Options and Adjustments - OS X	107
Managing Color - OS X.....	108
Color Matching and Color Options - OS X.....	109
Selecting Printing Preferences - OS X.....	110
Printing Preferences - OS X.....	111

Printing Your Document or Photo - OS X.....	112
Checking Print Status - OS X.....	113
Cancelling Printing Using a Product Button.....	114
Scanning.....	115
Starting a Scan.....	115
Starting a Scan Using the Product Control Panel	115
Adding and Assigning Scan Jobs.....	117
Starting a Scan with Document Capture Pro or Document Capture	118
Starting a Scan Using the Epson Scan Icon	121
Starting a Scan from a Scanning Program.....	123
Selecting Epson Scan Settings	125
Scan Modes.....	125
Selecting the Scan Mode.....	125
Scanning in Office Mode.....	126
Available Document Source Settings - Office Mode.....	129
Selecting a Scan Area - Office Mode	129
Available Image Adjustments - Office Mode	132
Scanning in Professional Mode	133
Available Document Source Settings - Professional Mode	136
Available Image Types - Professional Mode	136
Selecting a Scan Area - Professional Mode	137
Available Image Adjustments - Professional Mode	140
Selecting a Scan Size - Professional Mode.....	142
Image Preview Guidelines.....	145
Scan Resolution Guidelines	145
Selecting Scan File Settings.....	146
Available Scanned File Types and Optional Settings.....	148
Scanning with OS X Using Image Capture.....	149
Available Scan Settings - OS X Image Capture.....	151
Scanning Special Projects.....	152
Scanning to a SharePoint Server or Cloud Service	152
Scanning Multi-Page Originals as Separate Files.....	154

Faxing	156
Connecting a Telephone or Answering Machine	156
Setting Up Fax Features	159
Setting Up Basic Fax Features	160
Selecting Your Country or Region.....	160
Selecting the Date and Time.....	161
Using the Fax Setup Wizard	164
Selecting the Line Type.....	166
Setting the Number of Rings to Answer	168
Selecting Advanced Fax Settings.....	170
User Default Settings - Fax.....	172
Send Settings - Fax.....	174
Receive Settings - Fax.....	174
Output Settings - Fax	175
Basic Settings - Fax	177
Security Settings - Fax.....	178
Setting Up Fax Features Using the Fax Utility - Windows.....	179
Setting Up Fax Features Using the Fax Utility - OS X.....	181
Setting Up Contacts and Contact Groups.....	183
Setting Up Contacts Using the Product Control Panel.....	183
Creating a Contact.....	183
Editing or Deleting a Contact	186
Creating a Contact Group	187
Editing or Deleting a Contact Group.....	189
Setting Up Speed/Group Dial Lists Using the Fax Utility - Windows.....	191
Setting Up Speed/Group Dial Lists Using the Fax Utility - OS X.....	195
Sending Faxes	197
Sending Faxes from the Product Control Panel.....	197
Sending a Fax Using the Keypad, Contact List, or History	197
Fax Sending Options	199
Sending a Fax at a Specified Time	201
Sending a Fax on Demand	202
Sending a Stored Fax	203

Dialing Fax Numbers from a Connected Telephone	205
Sending Faxes Using the Fax Utility - Windows	205
Sending Faxes Using the Fax Utility - OS X.....	208
Receiving Faxes.....	211
Fax Reception	211
Receiving Faxes Automatically	212
Receiving Faxes Manually.....	212
Receiving a Fax by Polling	213
Viewing a Fax on the LCD Screen.....	213
Checking Fax Status	214
Printing Fax Reports.....	215
Fax Report Options	216
Using USB Flash Drives With Your Product	217
Inserting a USB Flash Drive	217
USB Device Photo File Specifications	217
Removing a USB Flash Drive.....	217
Viewing and Printing From the LCD Screen	218
Printing JPEG Photos.....	218
Printing TIFF Files	220
Photo Adjustment Options - Device Mode	220
Print Setting Options - Device Mode.....	221
Transferring Files on a USB Flash Drive	222
Setting Up File Sharing for File Transfers From Your Computer	222
Transferring Files from a USB Flash Drive to Your Computer	223
Replacing Ink Cartridges and Maintenance Boxes.....	225
Check Cartridge and Maintenance Box Status.....	225
Checking Cartridge Status on the LCD Screen.....	225
Checking Cartridge and Maintenance Box Status with Windows	226
Checking Cartridge and Maintenance Box Status with OS X.....	229
Purchase Epson Ink Cartridges and Maintenance Box	230
Ink Cartridge and Maintenance Box Part Numbers.....	230
Removing and Installing Ink Cartridges.....	231
Printing With Black Ink and Expended Color Cartridges.....	235

Printing With Expended Color Cartridges - Windows.....	235
Printing With Expended Color Cartridges - OS X.....	236
Conserving Low Black Ink with Windows	238
Replacing the Maintenance Box.....	238
Adjusting Print Quality.....	242
Print Head Maintenance.....	242
Print Head Nozzle Check.....	242
Checking the Nozzles Using the Product Control Panel	242
Checking the Nozzles Using a Computer Utility	245
Print Head Cleaning	246
Cleaning the Print Head Using the Product Control Panel	247
Cleaning the Print Head Using a Computer Utility.....	248
Print Head Alignment	251
Aligning the Print Head Using the Product Control Panel	251
Aligning the Print Head Using a Computer Utility.....	253
Cleaning the Paper Guide	255
Cleaning and Transporting Your Product	257
Cleaning Your Product	257
Transporting Your Product	259
Solving Problems	260
Checking for Software Updates.....	260
Product Status Messages	261
Status Menu Error Codes.....	262
Running a Product Check	265
Resetting Control Panel Defaults	267
Solving Setup Problems	268
Noise After Ink Installation.....	268
Software Installation Problems	268
Solving Network Problems	269
Product Cannot Connect to a Wireless Router or Access Point	269
Network Software Cannot Find Product on a Network.....	270
Product Does Not Appear in OS X Printer Window.....	271
Cannot Print Over a Network.....	271

Cannot Scan Over a Network	273
Solving Copying Problems	274
Product Makes Noise, But Nothing Copies	274
Product Makes Noise When It Sits for a While.....	274
Solving Paper Problems	274
Paper Feeding Problems	275
Paper Jam Problems Inside the Product	275
Paper Jam Problems in the Cassette	277
Paper Jam Problems in the Duplexer (Rear Cover).....	279
Document Jams in the Automatic Document Feeder.....	281
Paper Ejection Problems	284
Solving Problems Printing from a Computer.....	284
Nothing Prints	285
Product Icon Does Not Appear in Windows Taskbar	285
Printing is Slow	286
Solving Page Layout and Content Problems	287
Inverted Image.....	288
Too Many Copies Print	288
Blank Pages Print	288
Incorrect Margins on Printout.....	289
Incorrect Characters Print.....	289
Incorrect Image Size or Position	290
Slanted Printout	290
Solving Print Quality Problems	291
White or Dark Lines in Printout	291
Blurry or Smearred Printout	292
Faint Printout or Printout Has Gaps	293
Grainy Printout.....	294
Incorrect Colors	295
Solving Scanning Problems	296
Scanning Software Does Not Operate Correctly	296
Cannot Start Epson Scan	297
Solving Scanned Image Quality Problems	298

Image Consists of a Few Dots Only.....	298
Line of Dots Appears in All Scanned Images.....	298
Straight Lines in an Image Appear Crooked.....	299
Image is Distorted or Blurry.....	299
Image Colors are Patchy at the Edges.....	299
Image is Too Dark.....	300
Back of Original Image Appears in Scanned Image.....	300
Ripple Patterns Appear in an Image.....	300
Scanned Image Colors Do Not Match Original Colors.....	300
Scan Area is Not Adjustable in Thumbnail Preview.....	301
Scanned Image Edges are Cropped.....	301
Solving Faxing Problems.....	301
Cannot Send or Receive Faxes.....	302
Cannot Receive Faxes with a Telephone Connected to Your Product.....	303
When to Uninstall Your Product Software.....	303
Uninstalling Product Software - Windows.....	304
Uninstalling Product Software - OS X.....	305
Where to Get Help.....	305
Technical Specifications.....	307
Windows System Requirements.....	307
OS X System Requirements.....	308
Printing Specifications.....	308
Scanning Specifications.....	309
Automatic Document Feeder (ADF) Specifications.....	309
Fax Specifications.....	310
Paper Specifications.....	310
Printable Area Specifications.....	311
Ink Cartridge Specifications.....	313
Dimension Specifications.....	314
Electrical Specifications.....	314
Environmental Specifications.....	315
Interface Specifications.....	315
Network Interface Specifications.....	315

Safety and Approvals Specifications	317
Notices	318
General Product Safety Instructions.....	318
Ink Cartridge Safety Instructions.....	320
LCD Screen Safety Instructions.....	321
Wireless Connection Safety Instructions	321
Telephone Equipment Safety Instructions	321
FCC Compliance Statement.....	322
Software Notice.....	324
Trademarks.....	327
Copyright Notice.....	327
libTIFF Software Acknowledgment.....	328
A Note Concerning Responsible Use of Copyrighted Materials.....	329
Default Delay Times for Power Management for Epson Products	329
Copyright Attribution	329

WF-5620 User's Guide

Welcome to the *WF-5620 User's Guide*.

For a printable PDF copy of this guide, [click here](#).

Product Basics

See these sections to learn about the basic features of your product.

[Using the Control Panel](#)

[Product Parts Locations](#)

[Using Eco Mode and Other Power Saving Settings](#)

[Epson Connect Solutions for Smartphones, Tablets, and More](#)

[Using AirPrint](#)

[Using Google Cloud Print](#)

Using the Control Panel

See these sections to learn about the control panel and select control panel settings.

[Control Panel Buttons and Lights](#)

[Setting a Password and Locking the Control Panel](#)

[Changing LCD Screen Language](#)

[Adjusting Control Panel Sounds](#)







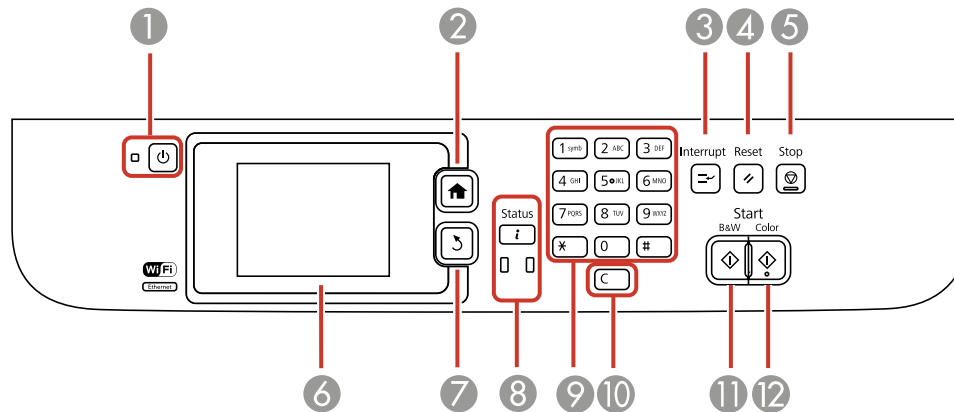

[Adjusting the Screen Brightness](#)

[Turning Off the Operation Time Out Setting](#)

Parent topic: [Product Basics](#)

Control Panel Buttons and Lights



- 1 The  power button and light
- 2 The  home button
- 3 The  **Interrupt** button
- 4 The  **Reset** button
- 5 The  **Stop** button
- 6 The LCD screen
- 7 The  back button
- 8 The **i Status** button and lights
- 9 The numeric keypad
- 10 The **C** clear button
- 11 The  **B&W** button
- 12 The  **Color** button



[Status Icon Information](#)













[Status Button Information](#)



Parent topic: [Using the Control Panel](#)

Status Icon Information

Your product may display status icons on the LCD screen for certain product status conditions. Press  to view or change the current network settings.

Icons	Description
	Displays additional information or instructions, such as on loading paper or placing a document.
	A document is in the Automatic Document Feeder (ADF).
	One or more of the ink cartridges are running low on ink or the maintenance box is nearly full. Press the i Status button to open the Status Menu, select Printer Information , and check the status of the consumables.

Icons	Description
	<p>One or more of the ink cartridges are expended or the maintenance box is full.</p> <p>Press the i Status button to open the Status Menu, select Printer Information, and check the status of the consumables.</p>
	<p>Unread or unprinted fax data is stored in the product. If you have set up the product to save received faxes on a computer or external storage device, this icon may also indicate that received faxes have not been saved on the computer or storage device.</p>
	<p>Fax memory usage.</p>
	<p>Fax memory is full. Delete received faxes you have already read or printed. If you have set up the product to save received faxes on a computer or external storage device, turn on the computer or connect the storage device to the product.</p>
	<p>A Wi-Fi or an Ethernet connection is being processed.</p>
	<p>No Ethernet connection.</p>
	<p>An Ethernet connection has been established.</p>
	<p>No Wi-Fi connection.</p>
	<p>A Wi-Fi network error has occurred or the product is searching for a connection.</p>
	<p>A Wi-Fi connection has been established. The number of bars indicates the connection's signal strength.</p>
	<p>An Ad hoc connection has been established.</p>
	<p>A Wi-Fi Direct mode connection has been established.</p>
	<p>A Simple AP mode connection has been established.</p>

Icons	Description
	Access to the product's functions are restricted to authorized users. Press the icon to log in to the printer. (You need to enter a user name and password.) Contact your administrator if you do not know the login information.
	Access to the product's functions are restricted to authorized users and a user is currently logged in. Press the icon to log out.

Parent topic: [Control Panel Buttons and Lights](#)

Status Button Information

Press the **i Status** button on the control panel to view the current product and job status.

Function	Description
Printer	Displays the status of consumables and any errors that have occurred with the product. Select the error from the list to display the error message.
Job Monitor	Displays the current job and any jobs waiting to be processed.
Job History	Displays the job history and any error codes for failed jobs in the history.
Job Storage	Select Inbox to display received faxes stored in the product's history.
Confidential Job	Displays jobs that require a password to print.

Parent topic: [Control Panel Buttons and Lights](#)

Setting a Password and Locking the Control Panel

You can set an administrator password to lock the following settings and prevent them from being changed:

- System Administration Setup settings
- Eco mode settings
- Presets
- Contacts

Note: For more information on administration settings, see the [Administrator's Guide](#).

1. Press the  home button, if necessary.
2. Select **Setup**.

You see a screen like this:



3. Scroll down and select **Admin Settings**.
4. Select **Admin Password**.
5. Select **Register**.

You see a screen like this:



6. Use the displayed keyboard to enter a password, and press .
7. Enter your password again to confirm.
8. Select **OK**.
9. Select **Lock Setting** and select **On**.

When the control panel is locked, you must enter the password to access any of the locked settings.

Note: If you forget your password, contact Epson for assistance.





[Entering Characters on the LCD Screen](#)
[Using Presets](#)

Parent topic: [Using the Control Panel](#)

Entering Characters on the LCD Screen

Follow these guidelines to enter characters for passwords and other settings.



- To move the cursor, select  or .
- To change the case of letters, select .
- To delete the previous character, select .
- To enter numbers or symbols, select .

- To enter a space, select .

Parent topic: [Setting a Password and Locking the Control Panel](#)

Related topics

[Wi-Fi or Wired Networking](#)

Using Presets

You can save frequently used copy, fax, and scan settings as presets. This lets you easily reuse them whenever necessary.

Note: Presets can be locked by an administrator. If you cannot access or change presets, contact your administrator for assistance.

1. Press the  home button, if necessary.
2. Select **Presets**. Enter the Administrator password, if necessary.

You see a screen like this:



3. Select **Add New**.
4. Select the function for which you want to set up a preset.

You see the main screen for that function, such as the Copy screen:

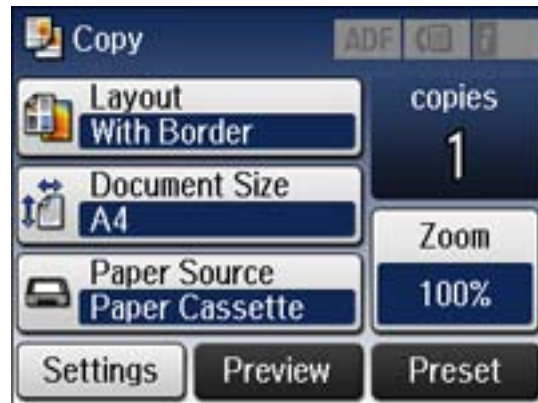

5. Select the settings you want to save, and select **Save**.

You see a screen like this:



6. Use the displayed keyboard to enter a name for the preset, and press .
7. Select **Save**.

When you copy, fax, or scan, you can use the preset by selecting **Presets** and selecting your preset from the list.

Parent topic: [Setting a Password and Locking the Control Panel](#)

Related tasks

[Entering Characters on the LCD Screen](#)

Changing LCD Screen Language

You can change the language used on the LCD screen.

Note: This setting can be locked by an administrator. If you cannot access or change this setting, contact your administrator for assistance.

1. Press the  home button, if necessary.
2. Select **Setup**.

You see a screen like this:

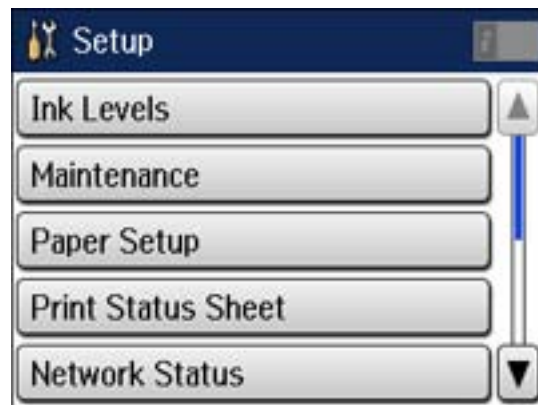

3. Scroll down and select **System Administration**.
4. Select **Common Settings**.
5. Scroll down and select **Language**.
6. Select a language.

Parent topic: [Using the Control Panel](#)

Adjusting Control Panel Sounds



You can adjust the sound level heard when you press buttons on the control panel.

Note: This setting can be locked by an administrator. If you cannot access or change this setting, contact your administrator for assistance.

1. Press the  home button, if necessary.
2. Select **Setup**.

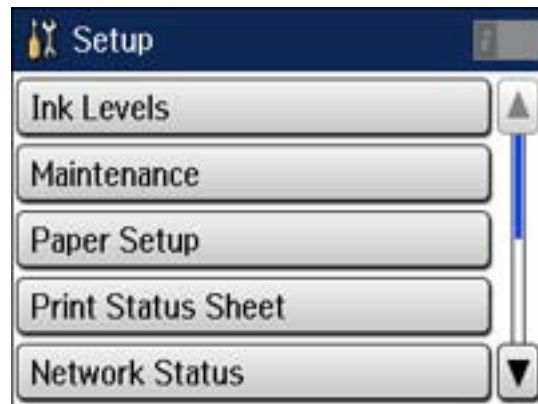
You see a screen like this:



3. Scroll down and select **System Administration**.
4. Select **Common Settings**.
5. Select **Sound**.
6. Select **Button Press**.
7. Press  to decrease or  to increase the sound.
8. Select **OK** to exit.

Parent topic: [Using the Control Panel](#)

Adjusting the Screen Brightness

You can adjust the brightness of the LCD screen.

1. Press the **⬆️** home button, if necessary.
2. Select **Setup**.

You see a screen like this:

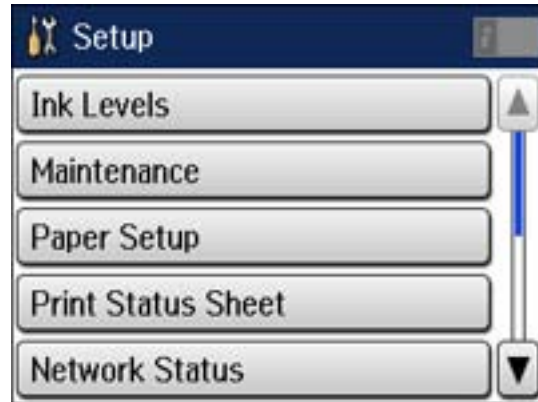

3. Scroll down and select **System Administration**.
4. Select **Common Settings**.
5. Select **LCD Brightness**.
6. Adjust the screen brightness by selecting a brightness level or by pressing the left and right arrow buttons.
7. Select **OK** to exit.

Parent topic: [Using the Control Panel](#)

Turning Off the Operation Time Out Setting

The Operation Time Out setting causes the LCD screen to return to the Home screen after a few minutes of inactivity. This feature is enabled by default, but you can turn it off.

Note: This setting can be locked by an administrator. If you cannot access or change this setting, contact your administrator for assistance.

1. Press the **⬆️** home button, if necessary.
2. Select **Setup**.

You see a screen like this:

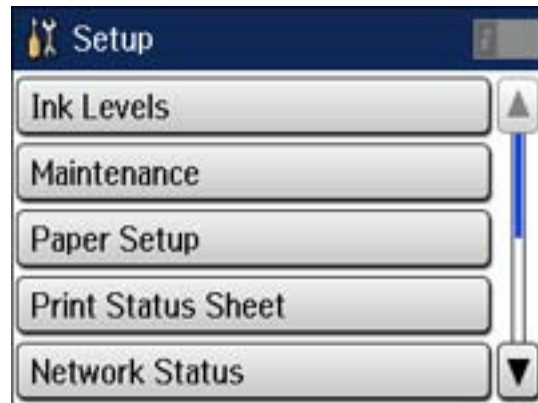

3. Scroll down and select **System Administration**.
4. Select **Common Settings**.
5. Scroll down and select **Operation Time Out**.
6. Select **Off**.

Parent topic: [Using the Control Panel](#)

Product Parts Locations

See these sections to identify the parts on your product.

[Product Parts - Top](#)

[Product Parts - Inside](#)

[Product Parts - Back](#)

Parent topic: [Product Basics](#)

Product Parts - Top

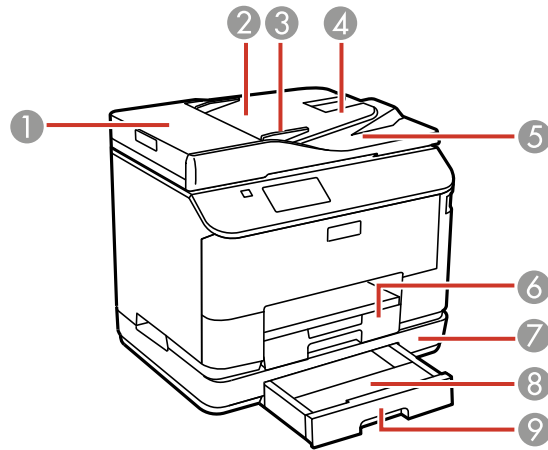

- 1 ADF cover
- 2 Automatic Document Feeder (ADF)
- 3 Edge guide
- 4 ADF input tray
- 5 ADF output tray
- 6 Paper cassette 1
- 7 Optional paper cassette unit
- 8 Optional paper cassette cover
- 9 Optional paper cassette 2

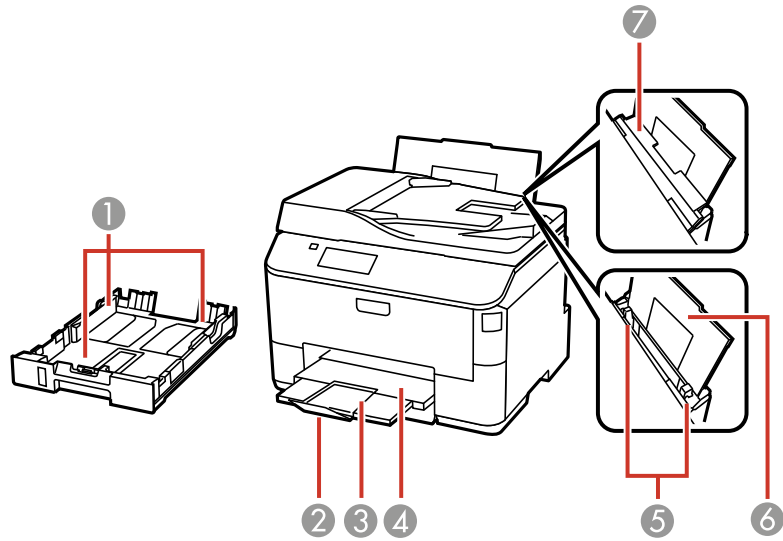

- 1 Edge guides
- 2 Paper stopper
- 3 Output tray extension
- 4 Output tray
- 5 Edge guides
- 6 Rear paper feed slot
- 7 Feeder guard

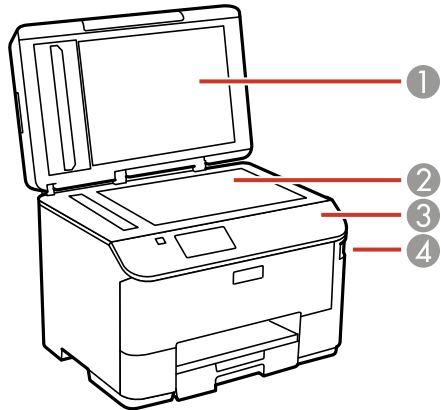

- 1 Document cover
- 2 Scanner glass
- 3 Control panel
- 4 USB Type A port for external devices

Parent topic: [Product Parts Locations](#)

Product Parts - Inside

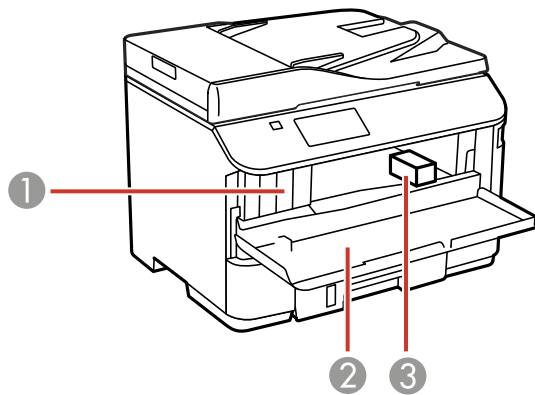

- 1 Ink cartridge slots
- 2 Front cover
- 3 Print head

Parent topic: [Product Parts Locations](#)

Product Parts - Back

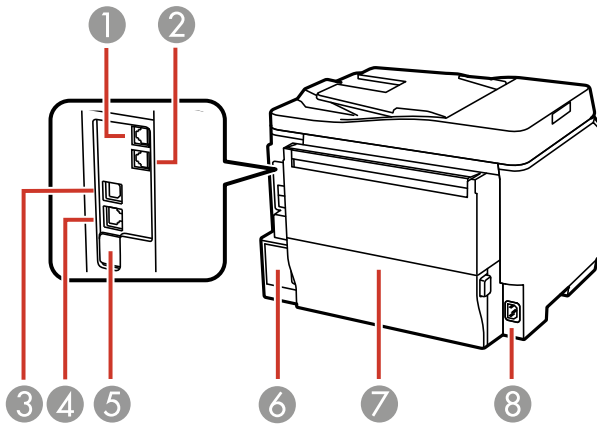

- 1 **Line** port
- 2 **EXT** port
- 3 **USB** port
- 4 **LAN** port
- 5 Service USB port (do not remove sticker)
- 6 Maintenance box
- 7 Rear cover
- 8 AC inlet

Parent topic: [Product Parts Locations](#)

Using Eco Mode and Other Power Saving Settings

Your product enters sleep mode automatically and turns off the LCD screen if it is not used for a period of time. You can make the time period shorter and select other options to save energy and resources.

[Changing the Eco Settings](#)

[Changing the Sleep Timer Settings](#)

[Changing the Power Off Timer Settings](#)

Parent topic: [Product Basics](#)

Changing the Eco Settings

You can use the product's control panel to change the Eco settings.

Note: The Sleep Timer setting in Eco Mode overrides the Sleep Timer setting in the Common Settings menu. If you turn on Eco Mode, 2-sided copying is selected by default. The Eco Mode setting can be locked by an administrator. If you cannot access or change this setting, contact your administrator for assistance.

1. Press the  home button, if necessary.
2. Select **Eco Mode**. Enter the administrator password, if necessary.

You see a screen like this:



3. Select **On**.

4. Select **Configure**.
5. Change any settings as necessary.
6. Select **OK** to exit.

Parent topic: [Using Eco Mode and Other Power Saving Settings](#)

Changing the Sleep Timer Settings

You can adjust the time period before your product enters sleep mode and turns off the LCD screen.

Note: This setting can be locked by an administrator. If you cannot access or change this setting, contact your administrator for assistance. The Sleep Timer setting in Eco Mode overrides this Sleep Timer setting.

1. Press the  home button, if necessary.
2. Select **Setup**.
3. Scroll down and select **System Administration**. Enter the administrator password, if necessary.
4. Select **Common Settings**.
5. Select **Sleep Timer**.

You see a screen like this:

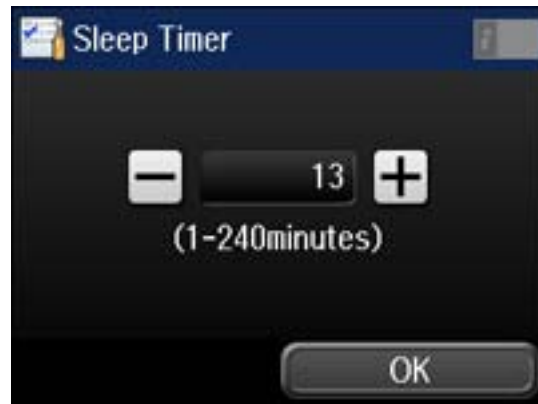

6. Do one of the following:
 - Press the – or + icons to reduce or increase the number of minutes.

- Press the number of minutes on the LCD screen, select the number of minutes from the on-screen keypad, then press .

7. Select **OK**.

Parent topic: [Using Eco Mode and Other Power Saving Settings](#)

Changing the Power Off Timer Settings

You can have the product turn off automatically if it is not used for a specified period of time.

Note: This setting can be locked by an administrator. If you cannot access or change this setting, contact your administrator for assistance.

1. Press the  home button, if necessary.
2. Select **Setup**.

You see a screen like this:

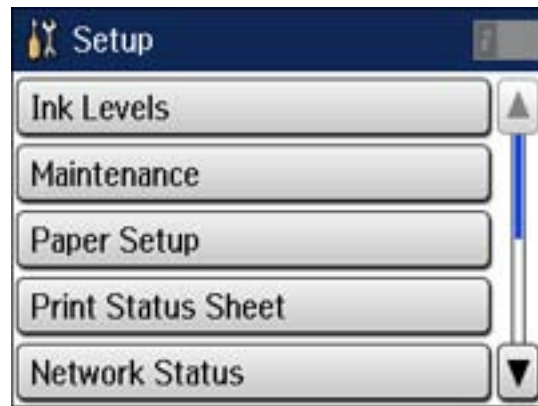

3. Scroll down and select **System Administration**. Enter the administrator password, if necessary.
4. Select **Common Settings**.
5. Select **Power Off Timer**.
6. Select a time period between **30minutes** and **12h** (12 hours).

Parent topic: [Using Eco Mode and Other Power Saving Settings](#)

Epson Connect Solutions for Smartphones, Tablets, and More

You can print documents, photos, emails, and web pages from your home, office, or even across the globe. You can use your smartphone, tablet, or computer. Epson offers these solutions to print and scan from anywhere: Epson Email Print, Epson iPrint Mobile App, Epson Remote Print, and Epson Scan to Cloud.

[Using Epson Email Print](#)

[Using the Epson iPrint Mobile App](#)

[Using Epson Remote Print](#)

[Using Epson Scan to Cloud](#)

Parent topic: [Product Basics](#)

Using Epson Email Print

With Epson Email Print, you can print from any device that can send email, such as your smartphone, tablet, or laptop. Just activate your product's unique email address. When you want to print, attach a PDF, Microsoft Office document, or photo to an email and send it to your product.

1. Set up your product for network printing as described in this manual. See the link below.
2. If you did not already set up Email Print when you installed your product software, visit epson.com/connect to learn more about Email Print, check compatibility, and get detailed setup instructions.
3. Send an email with attachments to your product's Email Print address.

Note: Both the email and any attachments print by default. You can change these printing options by logging into your Epson Connect account.

Parent topic: [Epson Connect Solutions for Smartphones, Tablets, and More](#)

Related topics

[Wi-Fi or Wired Networking](#)

Using the Epson iPrint Mobile App

Use this free Apple and Android app to print to nearby Epson networked products. The Epson iPrint Mobile App lets you print PDFs, Microsoft Office documents, photos, and web pages over a wireless network. You can even scan and save a file on your device, send it as an email, or upload it to an online service such as Box, Dropbox, Evernote, or Google Drive.

1. Set up your product on a network as described in this manual. See the link below.

2. Visit epson.com/connect to learn more about Epson iPrint and check the compatibility of your mobile device.
3. Download Epson iPrint from the Apple App Store or Google Play.
4. Connect your mobile device to the same wireless network that your product is using.
5. Print from your mobile device to your Epson product.

Parent topic: [Epson Connect Solutions for Smartphones, Tablets, and More](#)

Related topics

[Wi-Fi or Wired Networking](#)

Using Epson Remote Print

With Epson Remote Print software on your Windows computer or laptop, you can print to an Epson Email-enabled product anywhere in the world.

1. Set up your product for network printing as described in this manual. See the link below.
2. Visit epson.com/connect to learn more about Remote Print and how to download the software.
3. Download and install the Remote Print software.
4. Obtain the email address and optional access key of the Epson product you want to use for printing, and enter this address during Remote Print setup.
5. Select the print command in your application and choose the Remote Print driver for your Epson product.

Parent topic: [Epson Connect Solutions for Smartphones, Tablets, and More](#)

Related topics

[Wi-Fi or Wired Networking](#)

Using Epson Scan to Cloud

The Epson Scan to Cloud service sends your scanned files to a destination that you have registered with Epson Connect.

1. Set up your product for network scanning as described in this manual. See the link below.
2. Visit epson.com/connect for instructions on registering an account and your product with Epson Connect.
3. After registering, sign in to the Epson Connect web page with the email address and password you selected.
4. Select **Destination List** for Scan to Cloud.

5. Click **Add**, then follow the instructions on the screen to create your destination list.
6. When you're ready to scan, select the setting for the Scan to Cloud service on your product control panel.

Parent topic: [Epson Connect Solutions for Smartphones, Tablets, and More](#)

Related topics

[Wi-Fi or Wired Networking](#)

Using AirPrint

AirPrint allows you to wirelessly print to your AirPrint-enabled product from iPhone, iPad, and iPod touch running the latest version of iOS.



1. Set up your product for wireless printing as described in this manual. See the link below.
2. Connect your Apple device to the same wireless network that your product is using.
3. Print from your iPad, iPhone, or iPod touch to your product.

Parent topic: [Product Basics](#)

Related topics

[Wi-Fi or Wired Networking](#)

Using Google Cloud Print

With a Google Account, you can print from your Apple or Android device to your Epson product. You can also print from Chromebooks and the Google Chrome browser without drivers or cables.

Set up your Epson product for network printing as described in this manual. See the link below.

Note: Make sure your Epson printer and computer are connected to the same network before starting the Google Cloud Print setup.

1. Connect your device to the same network that your Epson product is using.
2. Print a network status sheet.

3. Locate your product's IP address on the network status sheet.
4. Enter the IP address into the address bar of a web browser.
5. Select the **Google Cloud Print Services** option.

Note: If you don't see the **Google Cloud Print Services** option, turn your product off and back on. If the option still doesn't appear, select the **Firmware Update** option and follow the on-screen instructions to update your product.

6. Click **Register**.
7. Select the checkbox to agree to the Usage Advisory and click **Next**.
8. Click **OK** to launch the sign-in page.

A separate browser window opens.

9. Enter your Google Account username and password and click **Sign in**, or, if you don't have an account, click **Sign up for a new Google Account** and follow the on-screen instructions.
10. Click **Finish printer registration** to complete setup and print a test page.

Your product is now linked to your Google Account and can be accessed from any Chromebook, computer, Apple or Android device with internet access. Visit [Epson Support](#) for more information on using Google Cloud Print, or the [Google Cloud Print](#) website for a list of [supported apps](#).

Parent topic: [Product Basics](#)

Related topics

[Wi-Fi or Wired Networking](#)

Wi-Fi or Wired Networking

See these sections to use your product on a Wi-Fi or wired network.

[Wi-Fi Infrastructure Mode Setup](#)

[Wi-Fi Direct Mode Setup](#)

[Wi-Fi Protected Setup \(WPS\)](#)

[Printing a Network Status Sheet](#)

[Changing or Updating Network Connections](#)

Wi-Fi Infrastructure Mode Setup

You can set up your product to communicate with your computer using a wireless router or access point. The wireless router or access point can be connected to your computer over a wireless or wired network.

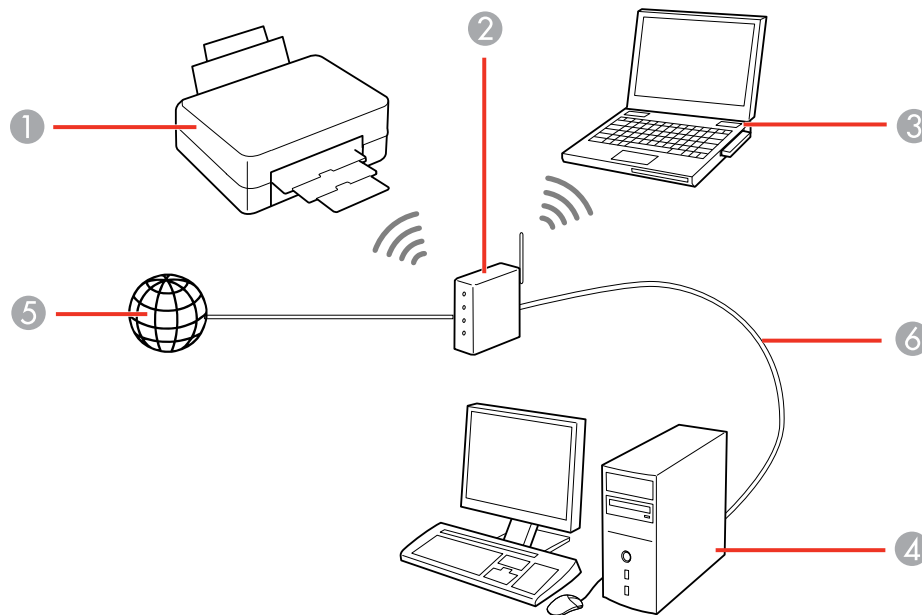

- 1 Epson product
- 2 Wireless router or access point

- 3 Computer with a wireless interface
- 4 Computer
- 5 Internet
- 6 Ethernet cable (used only for wired connection to the wireless router or access point)



[Selecting Wireless Network Settings From the Control Panel](#)

Parent topic: [Wi-Fi or Wired Networking](#)

Selecting Wireless Network Settings From the Control Panel

You can select or change wireless network settings using your product control panel.

To install your product on a wireless network, follow the instructions on the *Start Here* sheet and install the necessary software. The installer program guides you through network setup.

1. Press the  home button, if necessary.
2. Press .
3. Select **Wi-Fi Setup**.

You see a screen like this:



4. Select **Wi-Fi Setup Wizard**.

Note: If you need to disable the wireless network to set up your product on an Ethernet network, scroll down and select **Disable Wi-Fi** instead. Then follow the instructions on changing to a wired network connection in this guide.







5. Select the name of your wireless network or enter the name manually.

Note: To enter the wireless network name manually, select **Other Networks** and select the **Network (SSID)** field. Use the displayed keypad to enter your network name.

6. Select the **Password** field and enter your wireless password using the displayed keypad.





Note: The network name and password are case sensitive. Be sure to correctly enter uppercase and lowercase letters, and numeric or special characters.

- Press  or  to move the cursor.
- Press  to change the case of letters.
- Press  to delete the previous character.
- Press  to enter numbers and symbols.
- Press  to enter a space.

7. Press  when you finish entering your password and select **Proceed**.
8. Confirm the displayed network settings and select **OK** to save them.

Note: If you need to change a setting, press the  back button.

9. If you want to print a network setup report, press one of the  buttons. (Otherwise, select **Done**.)
10. Press the  home button to return to the Home screen.

If the network connection is successful, the Wi-Fi icon in the upper-right corner of the LCD screen is lit as shown.



Parent topic: [Wi-Fi Infrastructure Mode Setup](#)

Related references

[Control Panel Buttons and Lights](#)

Wi-Fi Direct Mode Setup

You can set up your product to communicate directly with your computer or another device without requiring a wireless router or access point.

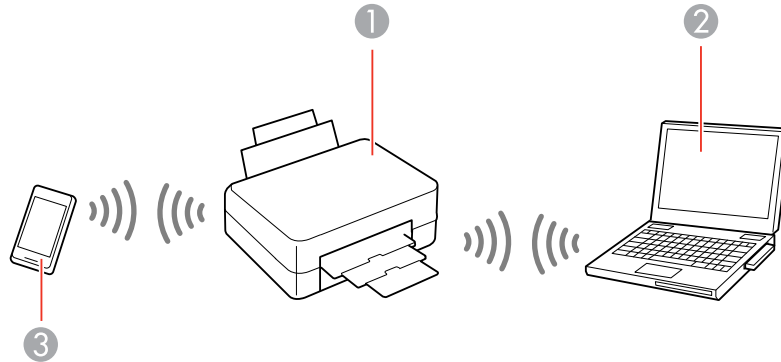

- 1 Epson product
- 2 Computer with a wireless interface
- 3 Other wireless device

Your product automatically selects one of these modes to communicate with your computer or device:

Access point mode

If your product is not already connected to a wireless network, it enters access point mode and the product itself acts as the network access point for up to 4 devices. When operating in this mode, your product displays an **AP** connection symbol on the LCD screen.

Peer-to-peer mode

If your product is already connected to a wireless network, it enters peer-to-peer mode and disconnects from any other networks. This also disables any other product features requiring access to the Internet. When operating in this mode, your product displays a **Direct** or **D** connection symbol on the LCD screen.



Note: To disconnect a peer-to-peer mode connection, release the connection to your product from your computer or other device. Your product will reconnect to the previously used network.

[Enabling Wi-Fi Direct Mode](#)

Parent topic: [Wi-Fi or Wired Networking](#)

Enabling Wi-Fi Direct Mode

You can enable Wi-Fi Direct mode to allow direct communication between your product and computer or other devices without a wireless router or access point.

1. Press the  home button, if necessary.
2. Press .
3. Select **Wi-Fi Setup**.

You see a screen like this:









4. Scroll down and select **Wi-Fi Direct Setup**.
5. Select **Connection Setup**.
6. Select **Change Password** and select **Yes**.

Note: If you have already connected devices or computers to your product via Wi-Fi Direct, they are disconnected when you change the password.

7. Enter your Wi-Fi Direct password.



Note: Your password must be at least 8 and no more than 22 characters long.

- Press  or  to move the cursor.
 - Press  to change the case of letters.
 - Press  to delete the previous character.
 - Press  to enter numbers and symbols.
 - Press  to enter a space.
8. Press  when you finish entering your password.

You see a screen like this:



9. Scroll down to view the SSID (Wi-Fi network name) and password.
10. Use your computer or wireless device to select the Wi-Fi network name (SSID) displayed on the LCD screen, then enter the password shown.
11. Press the  home button to return to the Home screen.

You see either an **AP** or **Direct** connection symbol on the LCD screen and should be able to print directly to your product from your computer or device.

Note: If the **AP** or **Direct** connection symbol is not displayed on the LCD screen, Wi-Fi Direct mode is not enabled. Repeat these steps to try again.

Parent topic: [Wi-Fi Direct Mode Setup](#)

Related references

[Control Panel Buttons and Lights](#)

Related tasks

[Entering Characters on the LCD Screen](#)

Wi-Fi Protected Setup (WPS)

If your network uses a WPS-enabled wireless router or access point, you can quickly connect your product to the network using Wi-Fi Protected Setup (WPS).



Note: To check if your router is WPS-enabled, look for a button labeled **WPS** on your router or access point. If there is no hardware button, there may be a virtual WPS button in the software for the device. Check your network product documentation for details.

[Using WPS to Connect to a Network](#)

Parent topic: [Wi-Fi or Wired Networking](#)

Using WPS to Connect to a Network

If you have a WPS-enabled wireless router or access point, you can use Wi-Fi Protected Setup (WPS) to connect your product to the network.

1. Press the  home button, if necessary.
2. Press .
3. Select **Wi-Fi Setup**.

You see a screen like this:



4. Select **Push Button Setup (WPS)**.
5. Follow the instructions on the LCD screen to complete WPS setup.
6. Press the  home button to return to the Home screen.

If the network connection is successful, the Wi-Fi icon in the upper-right corner of the LCD screen is lit as shown.



Parent topic: [Wi-Fi Protected Setup \(WPS\)](#)

Printing a Network Status Sheet

You can print a network status sheet to help you determine the causes of any problems you may have using your product on a network.

1. Press the  home button, if necessary.
2. Select **Setup**.

You see a screen like this:



3. Select **Network Status**.
4. Select **Wi-Fi/Network Status**.

You see a screen like this:



Note: If you are connected to a wireless network, the signal strength is also displayed.

5. Select **Print**.
6. Press one of the  buttons to print the network status sheet.

Examine the settings shown on the network status sheet to diagnose any problems you have.

Parent topic: [Wi-Fi or Wired Networking](#)

Changing or Updating Network Connections

See these sections to change or update how your product connects to a network.

[Accessing the Web Config Utility](#)

[Changing a USB Connection to a Wi-Fi Connection](#)

[Changing a Wi-Fi Connection to a Wired Network Connection](#)

[Connecting to a New Wi-Fi Router](#)

[Disabling Wi-Fi Features](#)

Parent topic: [Wi-Fi or Wired Networking](#)

Accessing the Web Config Utility

You can select your product's network settings and confirm its operating status using a web browser. You do this by accessing your product's built-in Web Config utility from a computer or other device that is connected to the same network as your product.

Note: For more information on the Web Config utility see the [Administrator's Guide](#).

1. Print a network status sheet.
2. Locate the IP Address for your product that is listed on the network status sheet.
3. On a computer or other device connected to the same network as your product, open a web browser.
4. Enter your product's IP address into the address bar.

You see the available Web Config utility options.

Parent topic: [Changing or Updating Network Connections](#)

Related tasks

[Printing a Network Status Sheet](#)

Changing a USB Connection to a Wi-Fi Connection

If you have already connected your product to your computer using a USB connection, you can change to a Wi-Fi connection or add a Wi-Fi connection to print wirelessly.

1. Do one of the following:
 - If you want to use only a Wi-Fi connection, disconnect the USB cable from your product. With Windows, also uninstall your product software.
 - If you want to add a Wi-Fi connection in addition to a USB connection, leave the USB cable connected to your product.
2. Download and install your product software from the Epson website using the instructions on the *Start Here* sheet.

Parent topic: [Changing or Updating Network Connections](#)

Changing a Wi-Fi Connection to a Wired Network Connection

If you have already connected your product to your computer wirelessly, you can change to a wired network connection if necessary.

1. Disable your product's Wi-Fi features.
2. Connect one end of an Ethernet network cable to the product's **LAN** port.
3. Connect the other end to any available LAN port on your router or access point.
4. Download and install your product software from the Epson website.
5. Follow the on-screen instructions to install the software.
6. When you see the Select Your Connection screen, select **Wired network connection**.
7. If you see a Select Setup Option screen, select **Setup printer for the first time**.
8. Continue following the rest of the on-screen instructions.

Parent topic: [Changing or Updating Network Connections](#)

Related tasks

[Disabling Wi-Fi Features](#)

Connecting to a New Wi-Fi Router

If you change the wireless router you have been using on your network, you can update your product's Wi-Fi connection to the new router.

1. Do one of the following:
 - **Windows:** Uninstall your product software.
 - **OS X:** Go to the next step.

2. Download and install your product software from the Epson website using the instructions on the *Start Here* sheet.

Parent topic: [Changing or Updating Network Connections](#)



Related tasks

[Uninstalling Product Software - Windows](#)

Disabling Wi-Fi Features

You may need to disable your product's Wi-Fi features if you change your network connection type or need to solve a problem with your network connection.

Note: Before disabling Wi-Fi features, make a note of your product's SSID (network name) and password, and any network settings selected for the Epson Connect services you may use.

1. Press the  home button, if necessary.
2. Press .
3. Select **Wi-Fi Setup**.

You see this screen:



4. Scroll down and select **Disable Wi-Fi**.
5. Select **Yes** to disable Wi-Fi.

Parent topic: [Changing or Updating Network Connections](#)

Loading Paper

Before you print, load paper for the type of printing you will do.

[Loading Paper in the Cassette](#)

[Loading Paper and Envelopes in the Rear Paper Feed Slot](#)

[Paper Loading Capacity](#)

[Available Epson Papers](#)

[Selecting the Paper Settings for Each Source - Control Panel](#)

[Selecting Default Paper Settings - Administrator](#)

[Installing and Enabling the Optional Second Paper Cassette](#)

Loading Paper in the Cassette

You can load plain paper in these sizes in the paper cassette:

- Letter (8.5 × 11 inches [216 × 279 mm])
- A4 (8.3 × 11.7 inches [210 × 297 mm])
- Legal (8.5 × 14 inches [216 × 357 mm])

1. Close the paper stopper and output tray, if necessary.

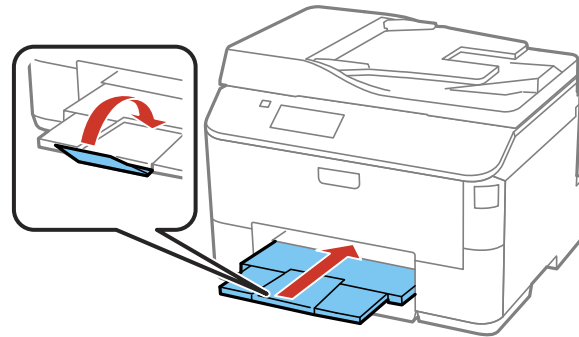

2. Pull out the paper cassette. If you are loading paper in the optional cassette, remove the paper cassette cover.

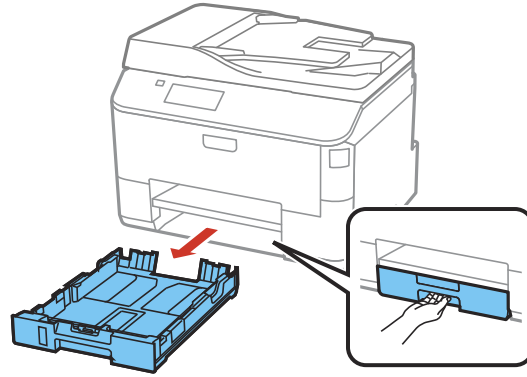

3. Slide the edge guides outward.

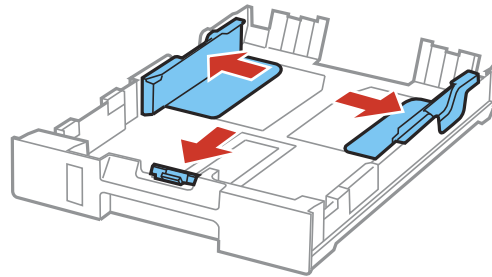

Note: If you are using legal-size paper, squeeze the tab and extend the paper cassette.

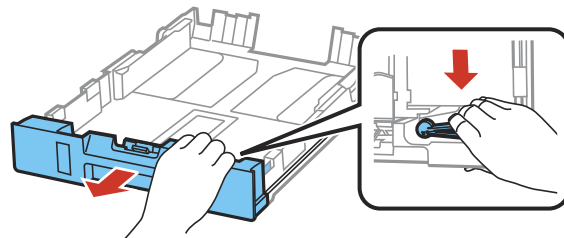

4. Set the front edge guide to the paper size you are using.

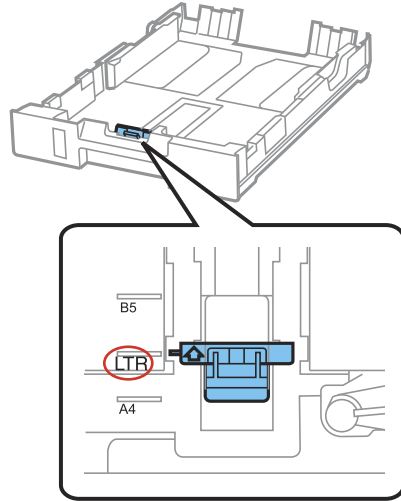

5. Load a stack of paper, printable side down, against the edge guide as shown.

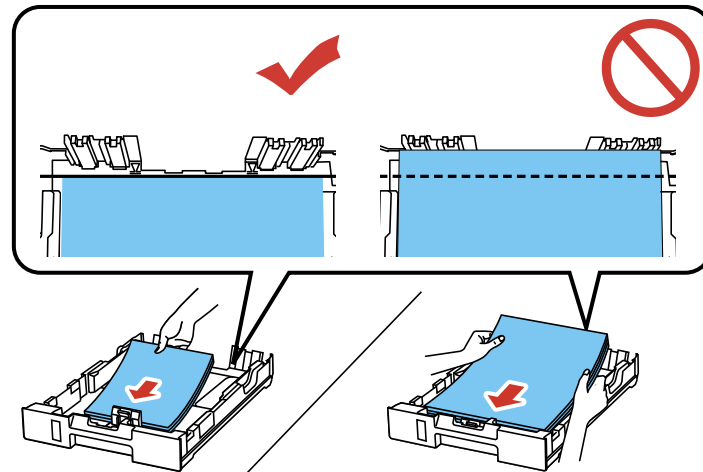

Note: Make sure the paper is loaded against the edge guide and not sticking out from the end of the cassette.

- Slide the edge guides against the paper, but not too tightly. If you are loading paper in the optional cassette, reattach the paper cassette cover.

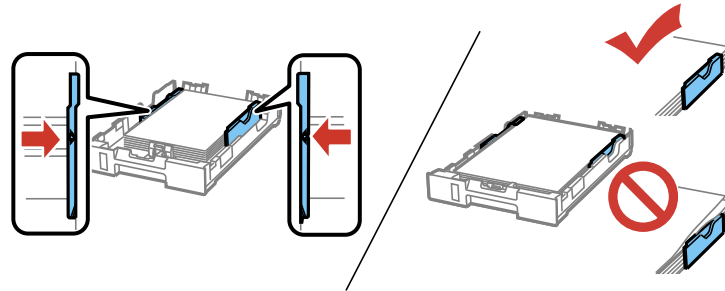

Note: Make sure the paper fits beneath the top edges of the guide.

Caution: To prevent paper feeding problems, make sure you do not load too much paper in the cassette.

- Keep the cassette flat as you gently insert it.

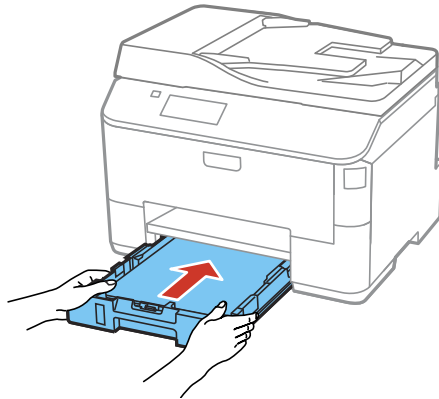

- Select the size and type of paper you just loaded on the product LCD screen.

9. Extend the output tray and open the paper stopper.

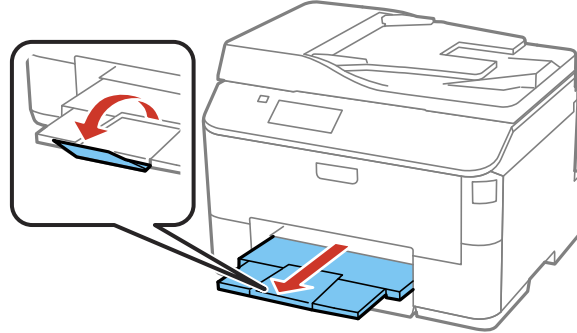

Note: If you are using legal-size or longer paper, do not open the paper stopper. Do not remove or insert the paper cassette during printing.

Always follow these paper loading guidelines:

- Load only the recommended number of sheets.
- Load paper short edge first, no matter which way your document faces.
- Load the printable side facedown.
- Load letterhead or pre-printed paper top edge first.
- Do not load paper above the arrow mark inside the edge guides.
- Check the paper package for any additional loading instructions.

Parent topic: [Loading Paper](#)

Related references

[Paper Loading Capacity](#)

Related tasks

[Loading Paper and Envelopes in the Rear Paper Feed Slot](#)

Loading Paper and Envelopes in the Rear Paper Feed Slot

You can print envelopes or documents in a variety of paper types and sizes in the rear paper feed slot.

1. Extend the output tray and open the paper stopper.

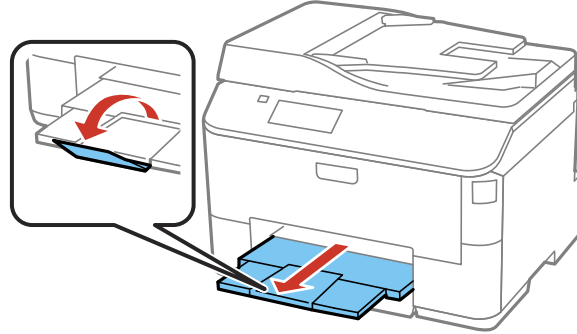

Note: If you are using legal-size or longer paper, do not open the paper stopper.

2. Pull up the paper support for the rear paper feed slot.

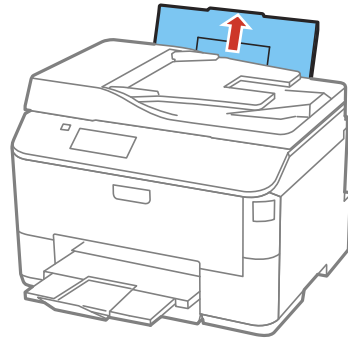

3. Flip the feeder guard forward, then slide the edge guides outward.

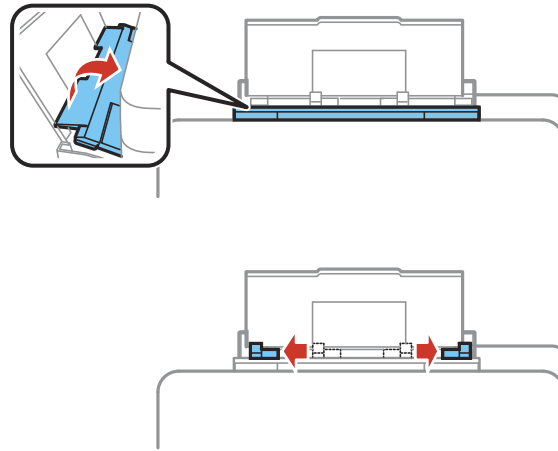

4. If you are inserting a stack of paper, fan the sheets first and tap the stack on a flat surface to even the edges.

Note: You can load one sheet of binder paper with holes on one of the long edges as shown. Do not select automatic 2-sided printing for this type of paper.

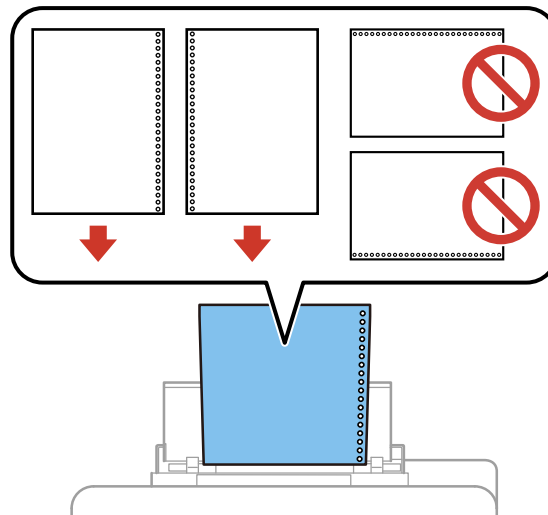

5. Do one of the following:

- Insert paper, glossy or printable side up and short edge first, in the center of the tray.

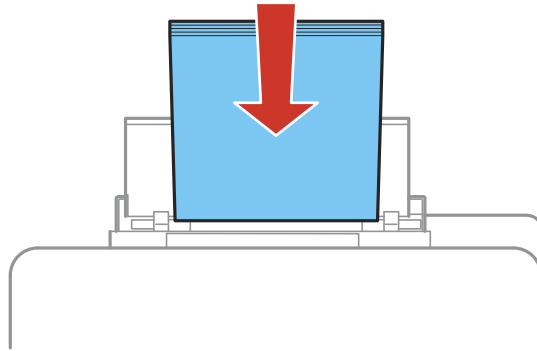

Caution: To prevent paper feeding problems, make sure you do not load too much paper in the slot.

- Load envelopes short edge first, with the flap facing down and the flap edge to the left, in the center of the slot.

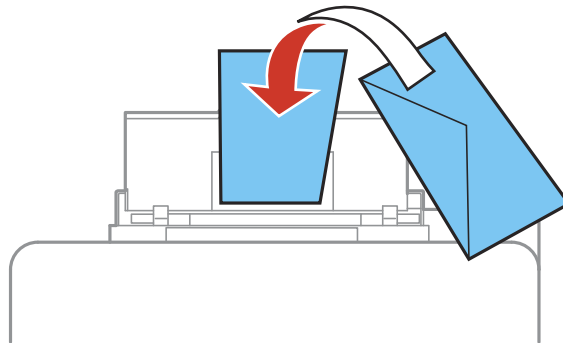

6. Slide the edge guides against the paper, but not too tightly.

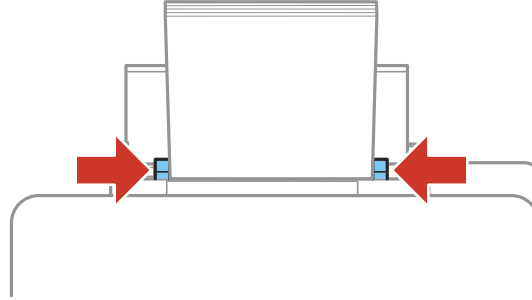

7. Select the size and type of paper you just loaded in the **Paper Setup** menu.

Always follow these paper loading guidelines:

- Load only the recommended number of sheets.
- Load paper short edge first, no matter which way your document faces.
- Load the printable side faceup.
- Load letterhead or pre-printed paper top edge first.
- Do not load paper above the arrow mark inside the edge guides.
- If you have trouble loading a stack of envelopes, press each envelope flat before loading it or load one envelope at a time.
- If print quality declines when printing multiple envelopes, try loading one envelope at a time.
- Do not load envelopes that are curled, folded, or too thin.
- Check the paper package for any additional loading instructions.

Parent topic: [Loading Paper](#)

Related references

[Paper Loading Capacity](#)

Related tasks

[Loading Paper in the Cassette](#)

Paper Loading Capacity

Paper type	Loading capacity - paper cassette	Loading capacity - rear paper feed slot
Plain paper	250 sheets Letter (8.5 × 11 inches [216 × 279 mm]) and A4 (8.3 × 11.7 inches [210 × 297 mm])	80 sheets
	250 sheets Legal (8.5 × 14 inches [216 × 357 mm])	1 sheet
Epson Bright White Paper	200 sheets	50 sheets 20 sheets for manual two-sided printing
Epson Presentation Paper Matte	—	80 sheets
Thick paper (cardstock up to 68 lb [256 g/m ²])	—	10 sheets Letter (8.5 × 11 inches [216 × 279 mm]) and A4 (8.3 × 11.7 inches [210 × 297 mm]) 5 sheets for manual two-sided printing
	—	1 sheet Legal (8.5 × 14 inches [216 × 357 mm])

Paper type	Loading capacity - paper cassette	Loading capacity - rear paper feed slot
Epson Premium Presentation Paper Matte	—	20 sheets
Epson Premium Presentation Paper Matte Double-sided		
Epson Ultra Premium Presentation Paper Matte		
Epson Brochure & Flyer Paper Matte Double-sided		
Epson Photo Paper Glossy		
Epson Premium Photo Paper Glossy		
Epson Ultra Premium Photo Paper Glossy		
Epson Premium Photo Paper Semi-gloss		
Envelopes	—	10 envelopes

Parent topic: [Loading Paper](#)

Available Epson Papers

You can purchase genuine Epson ink and paper at Epson Supplies Central at epson.com/ink3 (U.S. sales) or epson.ca (Canadian sales). You can also purchase supplies from an Epson authorized reseller. To find the nearest one, call 800-GO-EPSON (800-463-7766).

Paper Type	Size	Part number	Sheet count
Epson Bright White Paper	Letter (8.5 × 11 inches [216 × 279 mm])	S041586	500
Epson Brochure & Flyer Paper Matte Double-sided	Letter (8.5 × 11 inches [216 × 279 mm])	S042384	150

Paper Type	Size	Part number	Sheet count
Epson Presentation Paper Matte	Letter (8.5 × 11 inches [216 × 279 mm])	S041062	100
	Legal (8.5 × 14 inches [216 × 357 mm])	S041067	100
Epson Premium Presentation Paper Matte	8 × 10 inches (203 × 254 mm)	S041467	50
	Letter (8.5 × 11 inches [216 × 279 mm])	S041257 S042180	50 100
Epson Premium Presentation Paper Matte Double-sided	Letter (8.5 × 11 inches [216 × 279 mm])	S041568	50
Epson Ultra Premium Presentation Paper Matte	Letter (8.5 × 11 inches [216 × 279 mm])	S041341	50
Epson Photo Paper Glossy	4 × 6 inches (102 × 152 mm)	S041809 S042038	50 100
	Letter (8.5 × 11 inches [216 × 279 mm])	S041141	20
		S041649 S041271	50 100
Epson Premium Photo Paper Glossy	4 × 6 inches (102 × 152 mm)	S041808	40
		S041727	100
	5 × 7 inches (127 × 178 mm)	S041464	20
	8 × 10 inches (203 × 254 mm)	S041465	20
Letter (8.5 × 11 inches [216 × 279 mm])	S042183	25	
	S041667	50	
Epson Ultra Premium Photo Paper Glossy	4 × 6 inches (102 × 152 mm)	S042181	60
		S042174	100
	5 × 7 inches (127 × 178 mm)	S041945	20
	8 × 10 inches (203 × 254 mm)	S041946	20
Letter (8.5 × 11 inches [216 × 279 mm])	S042182	25	
	S042175	50	

Paper Type	Size	Part number	Sheet count
Epson Premium Photo Paper Semi-gloss	4 x 6 inches (102 x 152 mm)	S041982	40
	Letter (8.5 x 11 inches [216 x 279 mm])	S041331	20

Parent topic: [Loading Paper](#)

Selecting the Paper Settings for Each Source - Control Panel

You can change the default paper size and paper type for each source using the control panel on the product.

1. Press the  home button, if necessary.
2. Select **Setup**.

You see a screen like this:

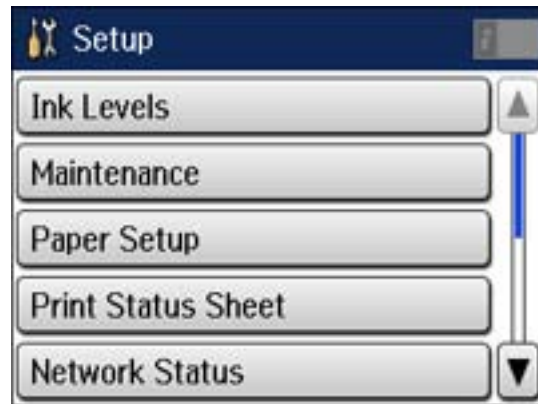

3. Select **Paper Setup**.
4. Select the paper source you want to change.

You see a screen like this:

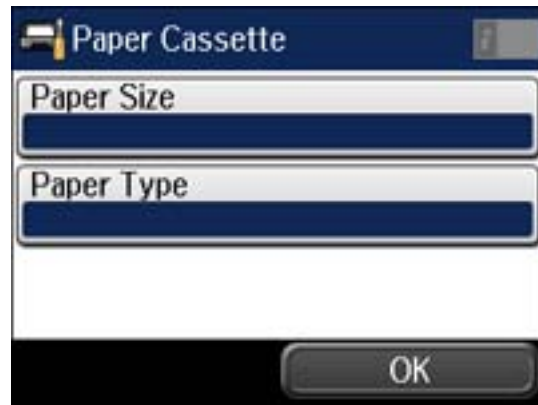

5. Select **Paper Size** .
6. Select the paper size you loaded.
7. Select **Paper Type** .
8. Select the paper type you loaded.
9. Select **OK** .
10. Select another paper source to change or press  home to return to the Home screen.

[Paper Type Settings](#)

Parent topic: [Loading Paper](#)

Paper Type Settings

For this paper	Select this Paper Type or Media Type setting
Plain paper	Plain Paper
Epson Bright White Paper	
Epson Presentation Paper Matte	
Epson Iron-on Cool Peel Transfer paper	
Epson Photo Quality Self-adhesive Sheets	

For this paper	Select this Paper Type or Media Type setting
Letterhead paper	Letterhead
Recycled paper	Recycled
Color paper	Color
Preprinted paper	Preprinted
Envelopes	Envelope
Epson Ultra Premium Photo Paper Glossy	Ultra Glossy
Epson Premium Photo Paper Glossy	Prem. Glossy
Epson Photo Paper Glossy	Glossy
Epson Premium Photo Paper Semi-gloss	Prem. Semi-Gloss
Epson Premium Presentation Paper Matte Epson Premium Presentation Paper Matte Double-sided Epson Ultra Premium Presentation Paper Matte Epson Brochure & Flyer Paper Matte Double-sided	Prem. Matte
Cardstock up to 68 lb	Card Stock

Parent topic: [Selecting the Paper Settings for Each Source - Control Panel](#)

Selecting Default Paper Settings - Administrator

You can adjust default paper settings as an administrator that apply to all print jobs sent to the product.

Note: These settings can be locked by an administrator. If you cannot access these settings, contact your administrator for assistance.

[Selecting the Default Printer Settings](#)

[Setting the Universal Print Settings](#)

Parent topic: [Loading Paper](#)

Selecting the Default Printer Settings

You can change default printer settings using the control panel on the product.

Note: These settings can be locked by an administrator. If you can't access these settings, contact your administrator for assistance.

1. Press the  home button, if necessary.
2. Select **Setup**.

You see a screen like this:



3. Scroll down and select **System Administration**. Enter the administrator password, if necessary.

You see a screen like this:

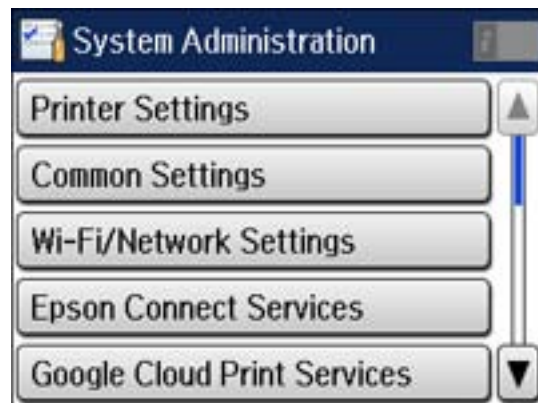

4. Select **Printer Settings** .
5. Select the **Paper Source Settings** options you want to use.
6. Select one of these **Auto Error Resolver** options:
 - Turn on this setting to display a warning and print on one side of paper only when a 2-sided printing error occurs, or to print the data that the printer could process when a memory full error occurs.
 - Turn off this setting to display an error message and stop printing if an error occurs.
7. When you are finished, press the  home button to return to the Home screen.

[Paper Source Settings Options](#)

Parent topic: [Selecting Default Paper Settings - Administrator](#)

Paper Source Settings Options

Select the **Paper Source Settings** options you want to use for your printed jobs.

Paper Source Settings option	Available settings	Description
Rear Paper Feed Priority	Normal	Select Normal to give printing priority to paper loaded in the rear paper feed slot.
	Last	
A4/Letter Auto Switching	On	Select On to switch the selected paper size to match the loaded paper (Letter or A4) if the wrong size is selected.
	Off	
Auto Select Settings	Copy	Select On for any of these settings to automatically print on paper from any source containing paper that matches your paper settings.
	Fax	
	Other	
Error Notice	Paper Size Notice	Select On for either of these settings to display an error message when the selected paper type or size does not match the loaded paper.
	Paper Type Notice	

Parent topic: [Selecting the Default Printer Settings](#)

Setting the Universal Print Settings

You can change the default universal print settings using the control panel on the product.

Note: These settings can be locked by an administrator. If you can't access these settings, contact your administrator for assistance.

1. Press the  home button, if necessary.
2. Select **Setup**.

You see this screen:

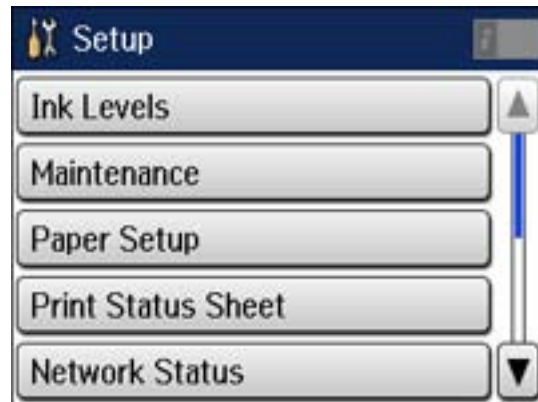

3. Scroll down and select **System Administration**. Enter the administrator password, if necessary.

You see this screen:

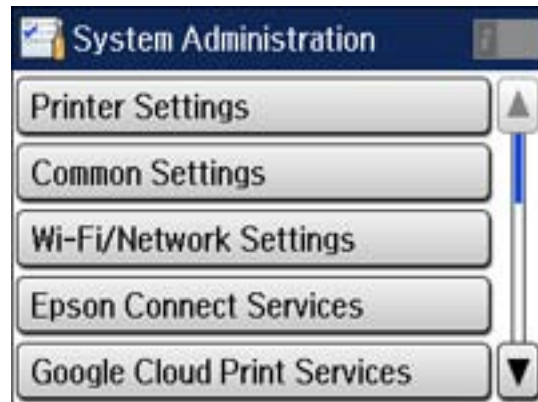

4. Select **Universal Print Settings** .
5. Adjust the settings as necessary.
6. When you are finished, press the  home button to return to the Home screen.

[Universal Print Settings Options](#)

Parent topic: [Selecting Default Paper Settings - Administrator](#)

Universal Print Settings Options

Select the **Universal Print Settings** you want to use.

Universal Print Settings option	Available settings	Description
Top Offset	—	Adjusts the top or left margin.
Left Offset	—	
Top Offset in Back	—	Adjusts the top or left margin of the back page when performing double-sided printing.
Left Offset in Back	—	
Check Paper Width	On	Select On to check the paper width before printing. This prevents printing beyond the edges of the paper when the paper size settings are incorrect, but may reduce the printing speed.
	Off	
Dry Time	Standard	Select the ink drying time you want to use when performing double-sided printing.
	Long	
	Longer	
Skip Blank Page	On	Select On to skip printing of blank pages automatically.
	Off	

Parent topic: [Setting the Universal Print Settings](#)

Installing and Enabling the Optional Second Paper Cassette

Follow these instructions to add the optional paper cassette to your product.

[Installing the Optional Second Paper Cassette](#)

Parent topic: [Loading Paper](#)

Installing the Optional Second Paper Cassette

You can install the optional paper cassette to provide more paper capacity.

1. Turn off the product and unplug the power cord and any connected cables.

Warning: To avoid electric shock, make sure you unplug the power cord.

2. Remove the paper cassette from its carton and place it where you want to set up the product.
3. Carefully lift the product as shown, then gently lower it onto the paper cassette. Make sure the connectors and pins align correctly.

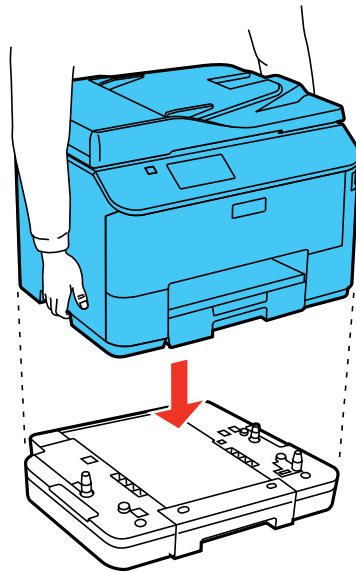

4. Reconnect the power cord and other connection cables, and plug in the product.
5. Turn on the product.

Parent topic: [Installing and Enabling the Optional Second Paper Cassette](#)

Placing Originals on the Product

Follow the instructions here to place your original documents or photos on the product.

Caution: Do not place anything on top of your product or use its cover as a writing surface to avoid damaging it.

[Placing Originals on the Scanner Glass](#)

[Placing Originals in the Automatic Document Feeder](#)

Placing Originals on the Scanner Glass

You can place originals up to this size on the scanner glass: Letter (8.5 × 11 inches [216 × 279 mm]) or A4 (8.3 × 11.7 inches [210 × 297 mm]).

1. Open the document cover.
2. Place your original facedown on the scanner glass with the top facing as shown. Slide the original to the edges of the indicated corner.

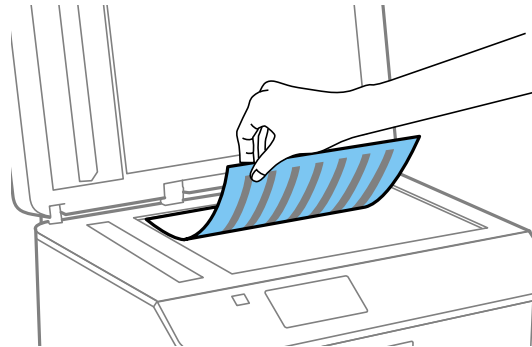

Note: You can place multiple originals on the scanner glass. Just make sure they are at least 0.8 inch (20 mm) away from each other.

3. Close the document cover gently to keep your original in place.

Parent topic: [Placing Originals on the Product](#)

Related topics

[Copying](#)

[Scanning](#)

[Faxing](#)

Placing Originals in the Automatic Document Feeder

You can place multi-page original documents in the Automatic Document Feeder (ADF). You can also use the ADF to scan both sides of a 2-sided document. Make sure the originals meet the Automatic Document Feeder specifications before loading them.

Caution: Make sure your originals are not creased or folded, and do not contain holes, staples, tape, or other materials that could obstruct the feeder.

1. Slide the ADF edge guide outward.

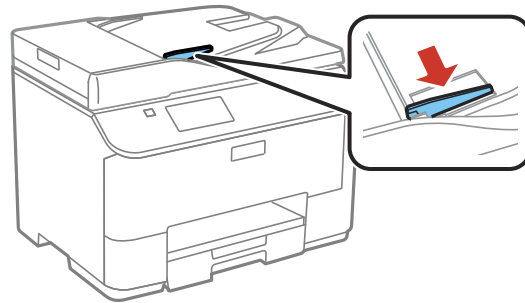

2. Fan your stack of originals and tap them gently on a flat surface to even the edges.

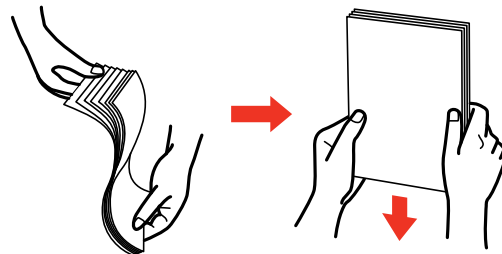

3. Insert the originals into the ADF faceup and top-edge first.



The **ADF** icon on the control panel lights up.

4. Slide the ADF edge guide against the originals, but not too tightly.

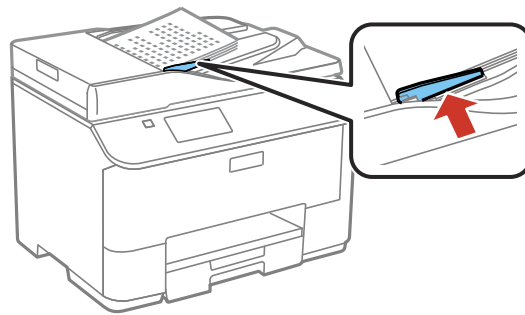

Note: If you are copying two originals onto one sheet, make sure the originals are loaded as shown:

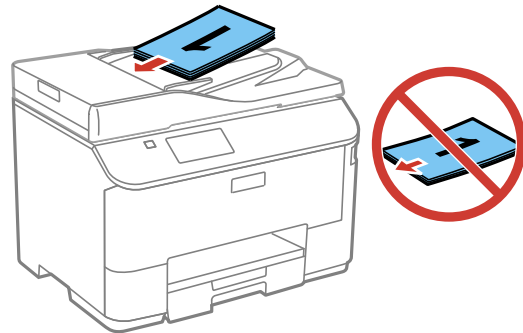
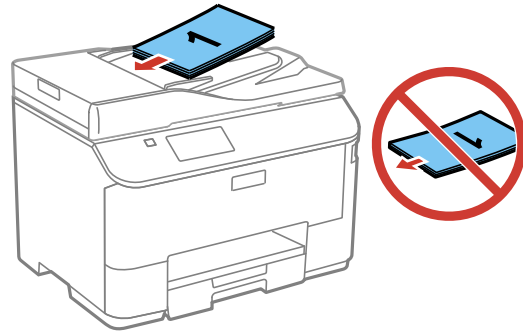

Parent topic: [Placing Originals on the Product](#)

Related topics

[Copying](#)

[Scanning](#)

[Faxing](#)

Copying

See the information here to copy documents or photos using your product.

Note: Copies may not be exactly the same size as your originals.

[Copying Documents or Photos](#)

[Copying Options](#)

Copying Documents or Photos

You can copy documents or photos onto various sizes and types of paper, including Epson special papers.

1. Place your original document or photo on the scanner glass, or place multi-page documents in the ADF.
2. Load the paper you want to print on.
3. Press the  home button, if necessary.
4. Select **Copy**.

You see a screen like this:

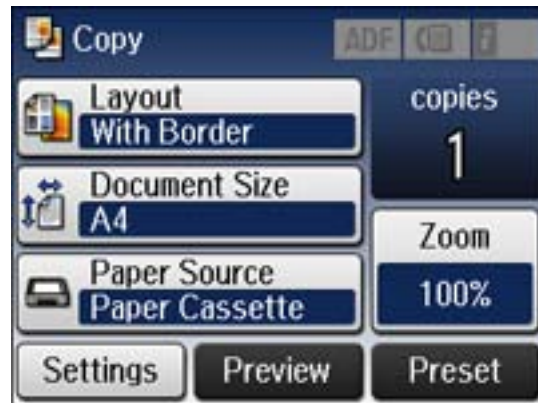

5. To print more than one copy, press a number key on the product's control panel, or select **copies** and use the displayed keypad to enter the number of copies.

6. Change any of the displayed settings as necessary.
7. Select **Settings** to view and change additional copy settings, if necessary. Then press the ↵ back button
8. Select **Preview** to preview your copy on the LCD screen.
9. Select **Preset** to save your copy settings.

Note: Presets can be locked by an administrator. If you can't access or change this setting, contact your administrator for assistance.

10. When you are ready to copy, press one of the ⬠ buttons.

Note: To cancel printing, press the ⏹ **Stop** button or select **Cancel**.

Parent topic: [Copying](#)

Copying Options

Select the copying options you want to use for your copies.

Note: Not all options or settings may be available, depending on other copying settings.

Copying option	Available settings	Description
Layout	With Border	Leaves a small margin around the image or document
	2-up Copy	Copies multiple page documents onto one sheet. Also, select Settings and change the Document Orientation and Layout Order settings as necessary.
	4-up	
	ID Card	Copies both sides of an ID card onto one side of a sheet of paper
Document Size	Various sizes	Select the document size of your original
Paper Source	Various sources	Select the paper source that you want to use. If you select Auto , paper is fed automatically depending on the paper settings you selected for the paper sources.

Copying option	Available settings	Description
Zoom	Custom Size	Automatically sizes the image by the percentage you select
	Actual Size	Copies at 100% size
	Auto Fit Page	Automatically sizes the image to fit the paper size you selected
	Letter->4x6in and other conversions	Automatically converts from one size to another
2-Sided	Off	Select to make 2-sided copies. When you select 1>2-Sided or 2>1-Sided , also select Advanced and select the binding edge for your originals or copies.
	2>2-Sided	
	1>2-Sided	
	2>1-Sided	
Document Orientation	Portrait	Specifies the orientation of your originals
	Landscape	
Quality	Text	Specifies the document type of your originals and adjusts the quality of your copies
	Text(Best)	
	Text & Image	
	Text & Image(Best)	
	Photo	
Density	Varying levels	Adjusts the lightness or darkness of copies
Remove Shadow	Off	Select On to erase the shadows that appear in the center of a document when copying a book or that appear around a document when copying thick paper
	On	
Remove Punch Holes	Off	Select On to erase the binding holes on a document
	On	
Collate Copy	Off	Select On to print multiple copies of a multi-page document both in order and sorted into sets
	On	

Copying option	Available settings	Description
Dry Time	Standard	Select to adjust the drying time for 2-sided copies, if smudges or marks appear on the front of the paper when you print on the second side
	Long	
	Longer	
Advanced Settings	Various settings	Select advanced settings such as Saturation and Sharpness

Parent topic: [Copying](#)

Printing from a Computer

Before printing from your computer, make sure you have set up your product and installed its software as described on the *Start Here* sheet.

Note: If you have an Internet connection, it is a good idea to check for updates to your product software on Epson's support website. If you see a Software Update screen, select **Enable automatic checking** and click **OK**. The update scans your system to see if you have the latest product software. Follow the on-screen instructions.

[Printing with Windows](#)

[Printing with OS X](#)

[Cancelling Printing Using a Product Button](#)

Printing with Windows

You can print with your product using any Windows printing program, as described in these sections.

[Selecting Basic Print Settings - Windows](#)

[Selecting Double-sided Printing Settings - Windows](#)

[Selecting Additional Layout and Print Options - Windows](#)

[Selecting a Printing Preset - Windows](#)

[Selecting Extended Settings - Windows](#)

[Printing Your Document or Photo - Windows](#)

[Selecting Default Print Settings - Windows](#)

[Changing Automatic Update Options](#)

Parent topic: [Printing from a Computer](#)

Selecting Basic Print Settings - Windows

Select the basic settings for the document or photo you want to print.

1. Open a photo or document for printing.
2. Select the print command in your application.

Note: You may need to select a print icon on your screen, the **Print** option in the **File** menu, or another command. See your application's help utility for details.

3. If necessary, select your product name as the printer you want to use.

Note: You may also need to select **Properties** or **Preferences** to view your print settings.

You see the Main tab of your printer settings window:

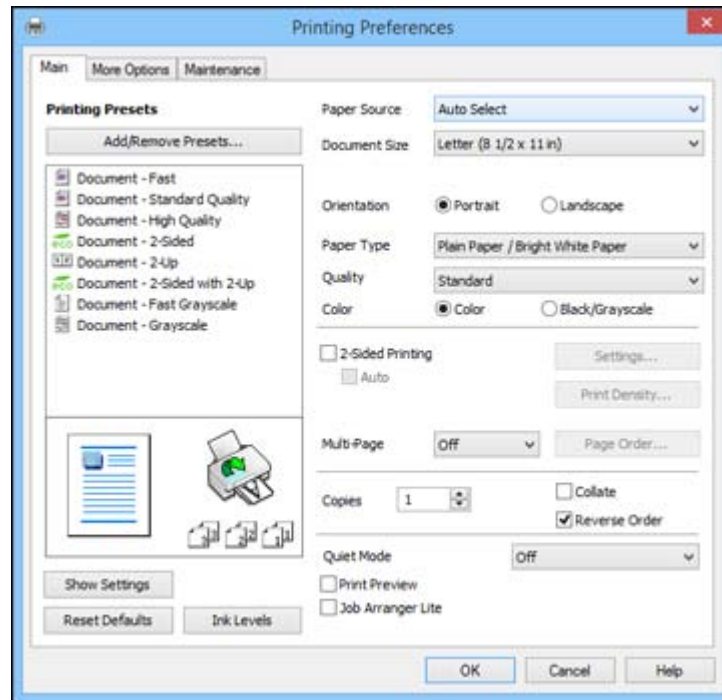

4. For the **Paper Source** setting, select where you loaded the paper you want to print on.
5. Select the size of the paper you loaded as the **Document Size** setting.
6. Select the orientation of your document.

Note: If you are printing an envelope, select **Landscape**.

7. Select the type of paper you loaded as the **Paper Type** setting.

Note: The setting may not exactly match the name of your paper. Check the paper type settings list for details.

8. Select the **Quality** setting that matches the print quality you want to use.
9. Select a Color option:
 - To print a color document or photo, select the **Color** setting.
 - To print text and graphics in black or shades of gray, select the **Black/Grayscale** setting.
10. To print on both sides of the paper, select the **2-Sided Printing** checkbox and select the options you want.
11. To print multiple pages on one sheet of paper, or print one image on multiple sheets of paper, select one of the settings in the **Multi-Page** menu and select the printing options you want.
12. To print multiple copies and arrange their print order, select the **Copies** options.
13. To preview your job before printing, select **Print Preview**.
14. To save your print job as a project that can be modified and combined with other print jobs, select **Job Arranger Lite**.
15. To reduce noise during printing when you select **Plain Paper/Bright White Paper**, select **On** in the Quiet Mode menu.

[Paper Source Options - Windows](#)

[Print Quality Options - Windows](#)

[Multi-Page Printing Options - Windows](#)

Parent topic: [Printing with Windows](#)

Related references

[Paper Type Settings](#)

Related tasks

[Selecting Double-sided Printing Settings - Windows](#)

[Printing Your Document or Photo - Windows](#)

Paper Source Options - Windows

You can select any of the available options in the Paper Source menu to print on the paper loaded in that source.

Note: Paper Cassette 2 is available only if your product has two cassettes.

Auto Select

Automatically selects the paper source based on the selected paper size.

Paper Cassette 1

Selects the paper in cassette 1 as the paper source.

Paper Cassette 2

Selects the paper in cassette 2 as the paper source.

Rear Paper Feed Slot

Selects the paper in the rear feed slot as the paper source.

Parent topic: [Selecting Basic Print Settings - Windows](#)

Print Quality Options - Windows

You can select any of the available Quality options to fine-tune the quality of your print. Some settings may be unavailable, depending on the paper type and border setting you have chosen.

Draft

For draft printing on plain paper.

Standard

For everyday text and image printing.

Standard - Vivid

For text and graphics with good quality and print speed.

High

For photos and graphics with high print quality.

More Settings

Opens a window that lets you choose among levels of speed and quality.

Parent topic: [Selecting Basic Print Settings - Windows](#)

Multi-Page Printing Options - Windows

You can select any of the available options in the Multi-Page menu to set up your multi-page print job.

2-Up and 4-Up

Prints 2 or 4 pages on one sheet of paper. Click the **Page Order** button to select page layout and border options.

2x1 Poster, 2x2 Poster, 3x3 Poster, 4x4 Poster

Prints one image on multiple sheets of paper to create a larger poster. Click the **Settings** button to select image layout and guideline options.

Parent topic: [Selecting Basic Print Settings - Windows](#)

Selecting Double-sided Printing Settings - Windows

You can print on both sides of the paper by selecting the **2-Sided Printing** checkbox on the Main tab.



Note: Some options may be pre-selected or unavailable, depending on other settings you have chosen or if you are accessing the product over a network.

1. Select the **2-Sided Printing** checkbox.
2. If the Auto checkbox is not automatically selected, do one of the following:
 - Select the **Auto** checkbox to automatically print your double-sided print job.
 - Deselect the **Auto** checkbox to print your double-sided print job manually by printing one side and flipping the paper over to print the other side (recommended for paper types that do not support automatic duplexing).
3. Click the **Settings** button.

You see this window:

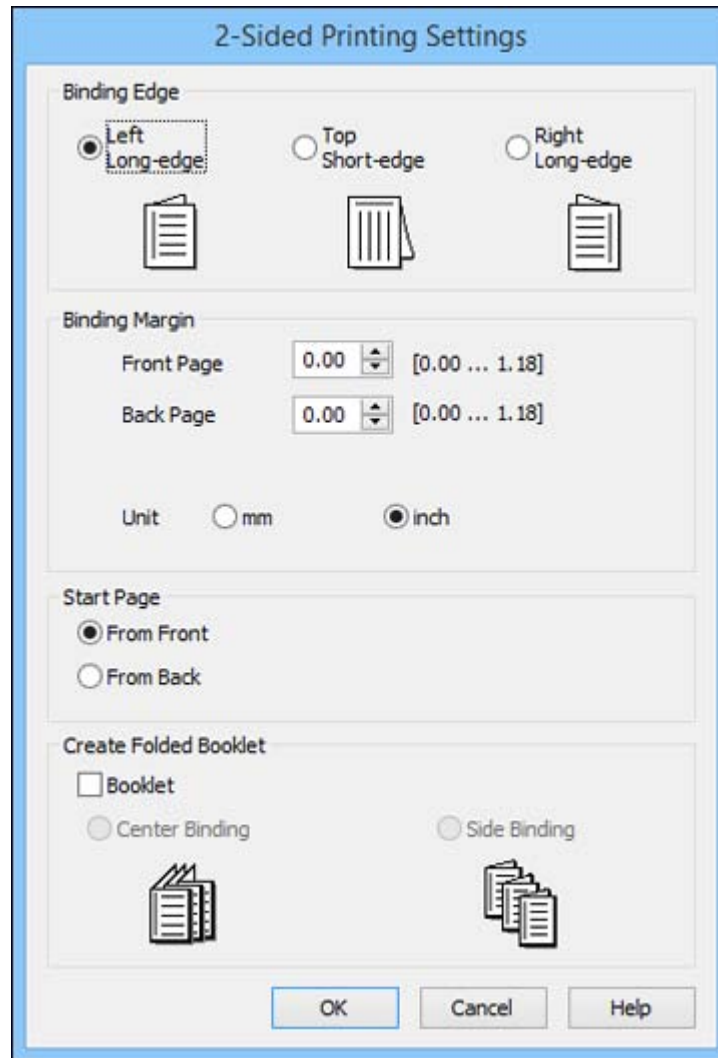

4. Select the double-sided printing options you want to use.
5. Click **OK** to return to the Main tab.
6. Click the **Print Density** button.

You see this window:

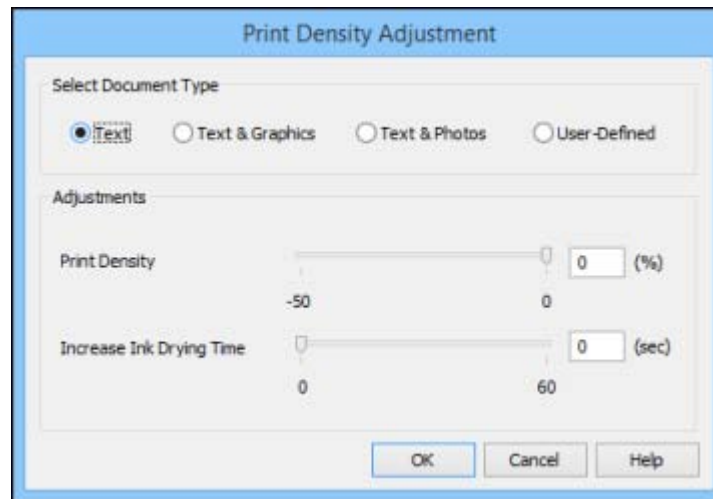

7. Select the type of document you are printing as the Document Type setting. The software automatically sets the **Adjustments** options for that document type.
8. If necessary, select the **Adjustments** options you want to use.
9. Click **OK** to return to the Main tab.
10. Print a test copy of your double-sided document to test the selected settings.
11. Follow any instructions displayed on the screen during printing.

[Double-sided Printing Options - Windows](#)

[Print Density Adjustments - Windows](#)

Parent topic: [Printing with Windows](#)

Related tasks

[Selecting Basic Print Settings - Windows](#)

Double-sided Printing Options - Windows

You can select any of the available options on the 2-Sided Printing Settings window to set up your double-sided print job.

Binding Edge Options

Select a setting that orients double-sided print binding in the desired direction.

Binding Margin Options

Select options that define a wider margin to allow for binding.

Start Page

Selects whether printing starts on the front or back page.

Create Folded Booklet Options

Select the **Booklet** checkbox and a binding option to print double-sided pages as a booklet.

Parent topic: [Selecting Double-sided Printing Settings - Windows](#)

Print Density Adjustments - Windows

You can select any of the available options on the Print Density Adjustment window to adjust the print quality of your double-sided print job.

Print Density

Sets the level of ink coverage for double-sided printing.

Increase Ink Drying Time

Sets the amount of time required for drying ink after printing on one side of the paper before printing the other side in double-sided printing to prevent ink smearing.

Parent topic: [Selecting Double-sided Printing Settings - Windows](#)

Selecting Additional Layout and Print Options - Windows

You can select a variety of additional layout and printing options for your document or photo on the More Options tab.

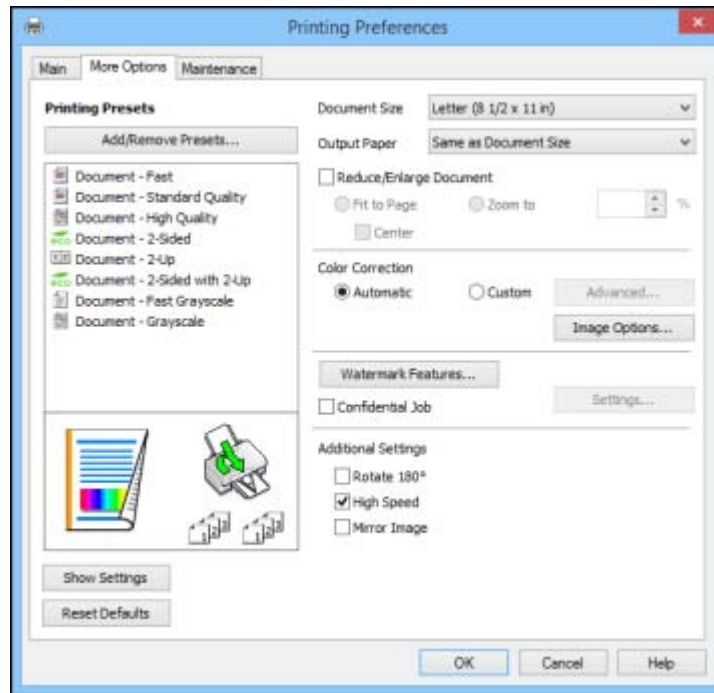

1. To change the size of your printed document or photo, select the **Reduce/Enlarge Document** checkbox and select one of these sizing options:
 - Select the **Fit to Page** option to size your image to fit the paper you loaded. Select the size of the your document or photo as the **Document Size** setting, and the size of your paper as the **Output Paper** setting. If you want to center your image on the paper, select the **Center** option.
 - Select the **Zoom to** option to reduce or enlarge your document or photo by a specific percentage. Select the percentage in the % menu.
2. Select one of the following Color Correction options:
 - Select **Automatic** to automatically adjust the sharpness, brightness, contrast, and color saturation for your image.

- Select **Custom** and click the **Advanced** button to manually adjust the color correction settings or turn off color management in your printer software.
 - Select **Image Options** to access additional settings for improving printed images.
3. To add the following features, click the **Watermark Features** button:
- **Anti-Copy Pattern**: adds a watermark that only appears when your printout is copied.
 - **Watermark**: adds a visible watermark to your printout.
 - **Header/Footer**: adds information such as the date and time to the top or bottom of your printout.

Note: Click the **Settings** button to customize the text and location of the header or footer.

4. To add a password to your print job, select the **Confidential Job** checkbox, then enter a password. Confidential jobs are stored in the product's memory without being printed. To print the job, enter the password for the confidential job on the product's control panel.

Note: Confidential print jobs are cleared from the product's memory after printing.

5. Select any of the Additional Settings options to customize your print.

[Custom Color Correction Options - Windows](#)

[Image Options and Additional Settings - Windows](#)

[Header/Footer Settings - Windows](#)

Parent topic: [Printing with Windows](#)

Related tasks

[Printing Your Document or Photo - Windows](#)

Custom Color Correction Options - Windows

You can select any of the available options in the Color Correction window to customize the image colors for your print job.

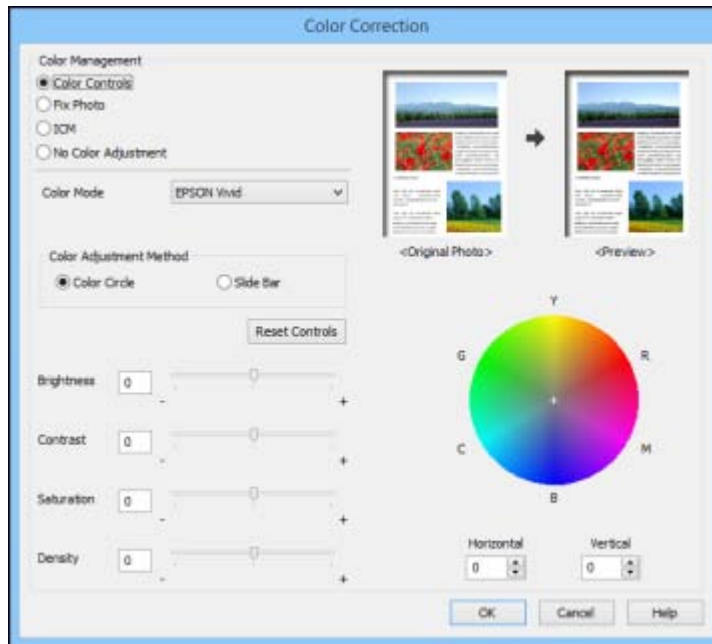

Color Controls

Lets you select a **Color Mode** setting, individual settings for **Brightness**, **Contrast**, **Saturation**, and **Density**, and individual color tones. Depending on the selected color mode, you can also adjust the midtone density using the **Gamma** setting.

Fix Photo

Improves the color, contrast, and sharpness of flawed photos.

Note: Fix Photo uses a sophisticated face recognition technology to optimize photos that include faces. For this to work, both eyes and the nose must be visible in the subject's face. If your photo includes a face with an intentional color cast, such as a statue, you may want to turn off **Fix Photo** to retain the special color effects.

ICM

Lets you manage color using installed color printing profiles.

No Color Adjustment

Turns off color management in your printer software so you can manage color using only your application software.

Parent topic: [Selecting Additional Layout and Print Options - Windows](#)

Image Options and Additional Settings - Windows

You can select any of the Image Options and Additional Settings to customize your print. Some options may be pre-selected or unavailable, depending on other settings you have chosen.

Image Options**Emphasize Text**

Adjusts the weight of printed text to increase readability.

Emphasize Thin Lines

Adjusts the weight of printed lines to increase visibility.

Edge Smoothing

Smooths jagged edges in low-resolution images such as screen captures or images from the Web.

Fix Red-Eye

Reduces or removes red-eye in photos.

Additional Settings Options**Rotate 180°**

Prints the image rotated 180° from its original orientation.

High Speed

Speeds up printing, but may reduce print quality.

Mirror Image

Flips the printed image left to right.

Parent topic: [Selecting Additional Layout and Print Options - Windows](#)

Header/Footer Settings - Windows

You can select any of the Header/Footer Settings options to add headers or footers when you print. The items are available to print at the top or bottom of your pages, in either the left, right, or center of the page.

Note: These settings are not saved with your document.

Top Left	Top Center	Top Right
User Name	None	Date/Time
Bottom Left	Bottom Center	Bottom Right
None	None	None

Reset Defaults OK Cancel Help

You can select to print the following information:

- User Name
- Computer Name
- Date
- Date/Time
- Collate Number (copy number)

Note: The user name, computer name, date, and time come from the Windows Control Panel on your computer.

Parent topic: [Selecting Additional Layout and Print Options - Windows](#)

Selecting a Printing Preset - Windows

For quick access to common groups of print settings, you can select a printing preset on the Main or More Options tab.

Note: You can create your own preset by clicking the **Add/Remove Presets** button.

1. Click the **Main** or **More Options** tab.

You see the available **Printing Presets** on the left:

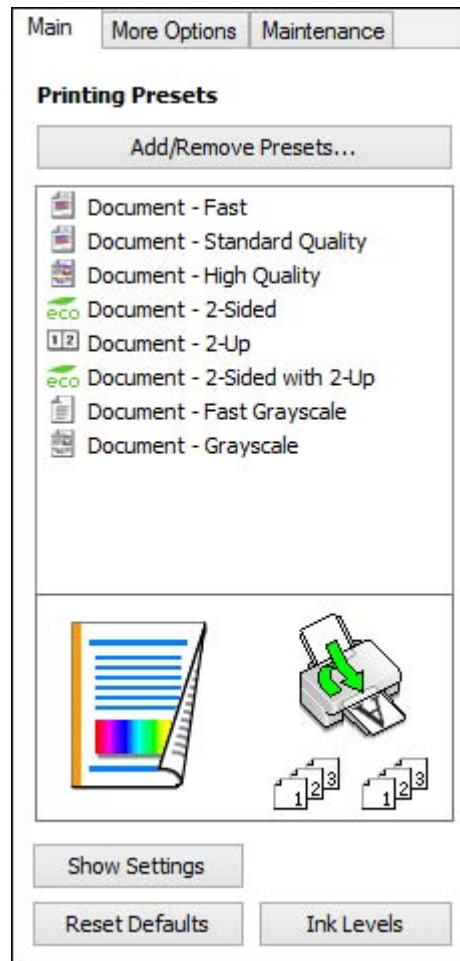

2. Place your cursor over one of the **Printing Presets** to view its list of settings.
3. Use any of the available options on the screen to control your printing presets.
4. To choose an option for printing, select it.
5. Click **OK**.

Parent topic: [Printing with Windows](#)

Selecting Extended Settings - Windows

You can select additional settings that apply to all the print jobs you send to your product.

1. Access the Windows Desktop and right-click the product icon in the Windows taskbar.
2. Select **Printer Settings**.
3. Click the **Maintenance** tab.

You see the maintenance options:

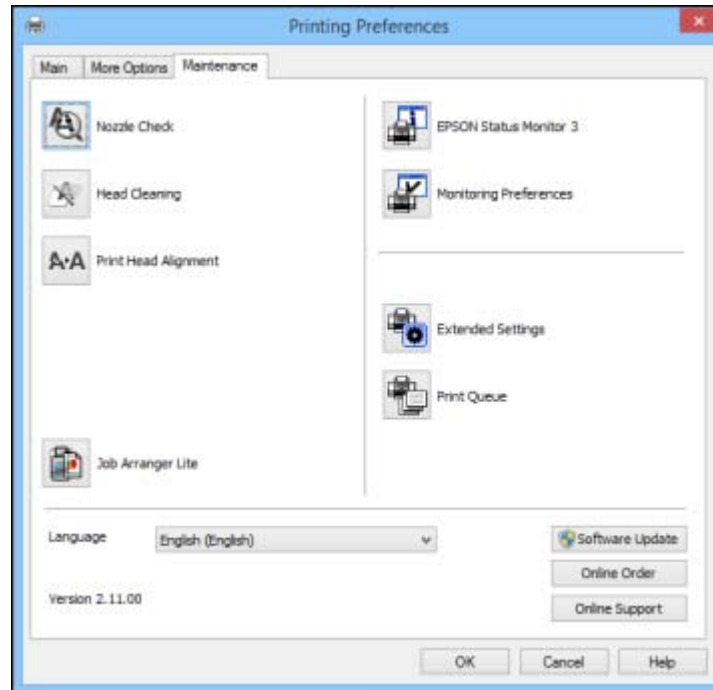

4. Click the **Extended Settings** button.

You see this window:

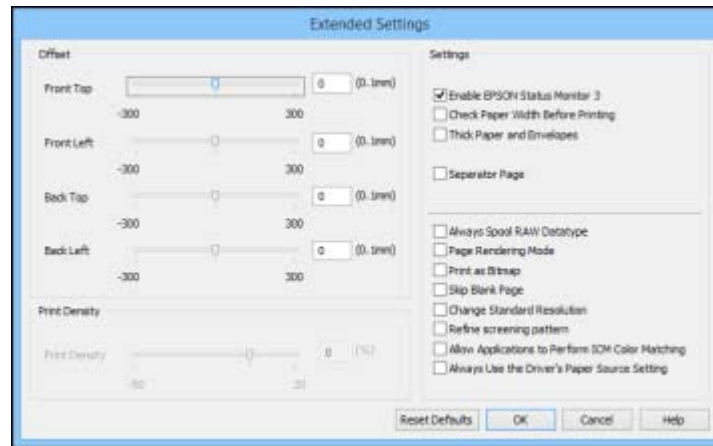

5. Select any of the extended settings to customize your print.
6. Click **OK** to close the Extended Settings window.
7. Click **OK** to close the printer software window.

[Extended Settings - Windows](#)

Parent topic: [Printing with Windows](#)

Extended Settings - Windows

You can select from these settings on the Extended Settings window.

Enable EPSON Status Monitor 3

Enables product monitoring for ink and paper supplies and other issues.

Check Paper Width Before Printing

Prevents printing beyond the edges of the paper if the paper size setting is incorrect, but may reduce print speed.

Thick paper and envelopes

Prevents ink from smearing when you print on envelopes or other thick paper.

Separator Page

Before each document, prints a separator page containing the title, user, date, and time.

Always Spool RAW Datatype

Increases print speed and may solve other printing problems.

Page Rendering Mode

Increases print speed when printing is extremely slow or the print head stops during printing.

Print as Bitmap

Increases print speed when printing is extremely slow or the print head stops during printing, and other settings do not help.

Skip Blank Page

Ensures that your product does not print pages that contain no text or images.

Change Standard Resolution

Reduces the resolution of print data to correct printing problems.

Refine screening pattern

Prints graphics with a finer screening pattern.

Allow Applications to Perform ICM Color Matching

Allows applications to perform ICM color matching.

Always Use the Driver's Paper Source Setting

Prints using the paper source setting in the printer driver, rather than the setting in your application.

Parent topic: [Selecting Extended Settings - Windows](#)

Printing Your Document or Photo - Windows

Once you have selected your print settings, you are ready to save your settings and print.

1. Click **OK** to save your settings.

You see your application's Print window, such as this one:

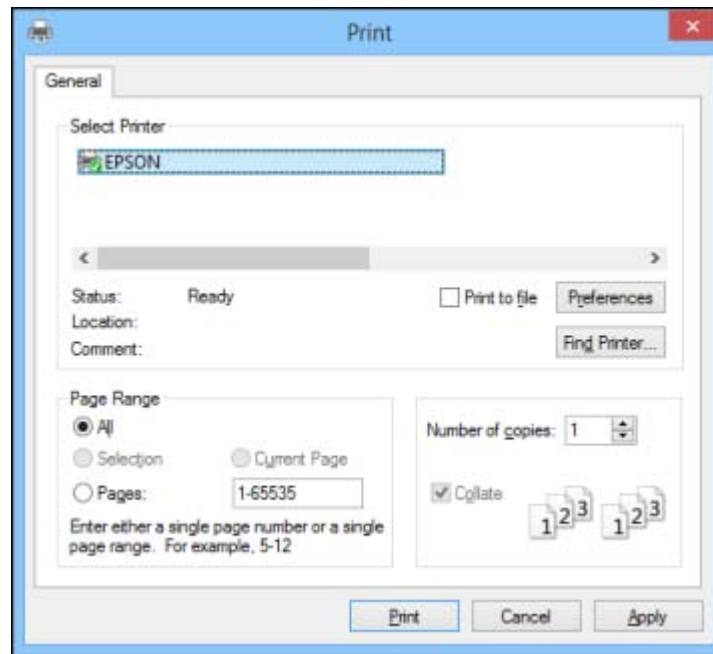

2. Click **OK** or **Print** to start printing.

Parent topic: [Printing with Windows](#)

Selecting Default Print Settings - Windows

When you change your print settings in a program, the changes apply only while you are printing in that program session. If you want to change the print settings you use in all your Windows programs, you can select new default print settings.

1. Access the Windows Desktop and right-click the product icon in the Windows taskbar.
2. Select **Printer Settings**.

You see the printer settings window:

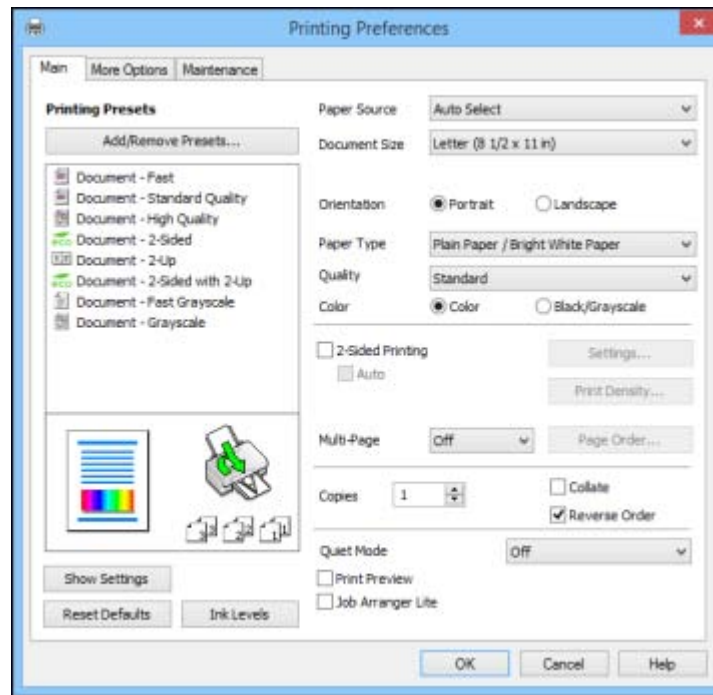

3. Select the print settings you want to use as defaults in all your Windows programs.
4. Click **OK**.

These settings are now the defaults selected for printing. You can still change them as needed for printing in any program session.

[Changing the Language of the Printer Software Screens](#)

Parent topic: [Printing with Windows](#)

Changing the Language of the Printer Software Screens

You can change the language used on the Windows printer software screens.

1. Access the Windows Desktop and right-click the product icon in the Windows taskbar.
2. Select **Printer Settings**.

You see the printer settings window.

3. Click the **Maintenance** tab.
You see the maintenance options:

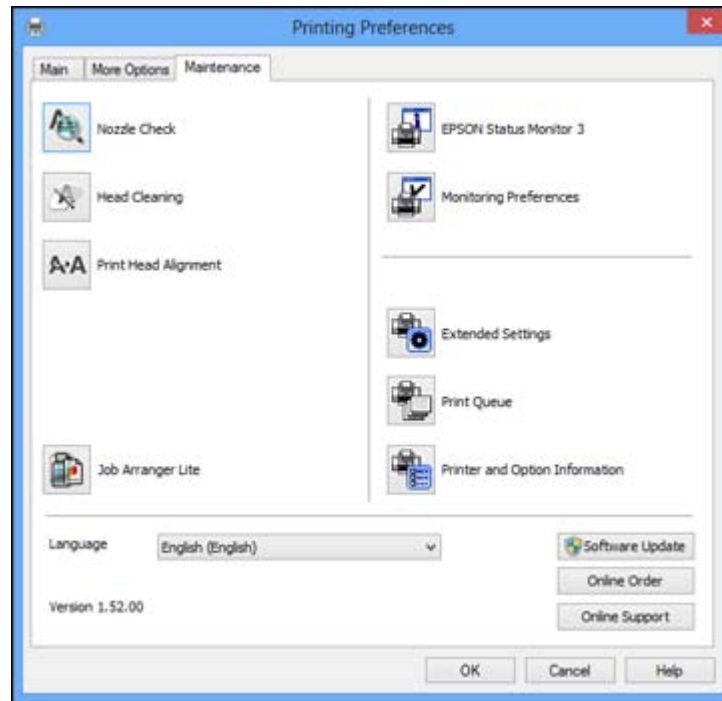

4. Select the language you want to use as the **Language** setting.
5. Click **OK** to close the printer software window.

The printer software screens appear in the language you selected the next time you access them.

Parent topic: [Selecting Default Print Settings - Windows](#)

Changing Automatic Update Options

Your printer software for Windows automatically checks for updates to the product software. You can change how often the software checks for updates or disable this feature.

1. Access the Windows Desktop and right-click the product icon in the Windows taskbar.
2. Select **Software Update Settings**.

You see this window:

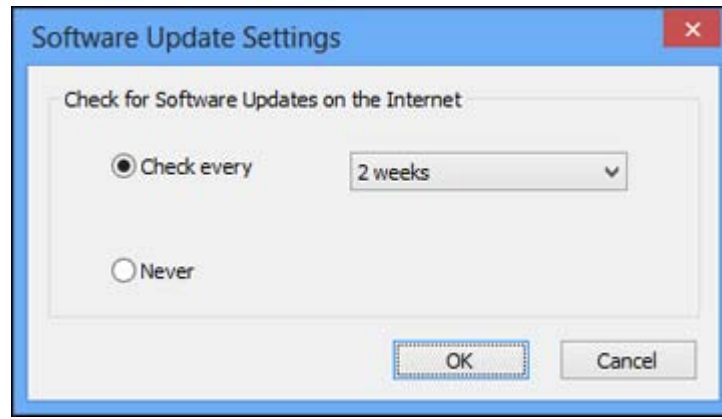

3. Do one of the following:
 - To change how often the software checks for updates, select a setting in the **Check every** menu.
 - To disable the automatic update feature, select the **Never** option.
4. Click **OK** to exit.

Note: If you choose to disable the automatic update feature, you can check for updates manually.

Parent topic: [Printing with Windows](#)

Related tasks

[Checking for Software Updates](#)

Printing with OS X

You can print with your product using any OS X printing program, as described in these sections.

Note: If you have an Internet connection, it is a good idea to check for updates to your product software on Epson's support website.

[Selecting Basic Print Settings - OS X](#)

[Selecting Page Setup Settings - OS X](#)

[Selecting Print Layout Options - OS X](#)

[Selecting Double-sided Printing Settings - OS X](#)

[Managing Color - OS X](#)

[Selecting Printing Preferences - OS X](#)

[Printing Your Document or Photo - OS X](#)

Parent topic: [Printing from a Computer](#)

Selecting Basic Print Settings - OS X

Select the basic settings for the document or photo you want to print.

1. Open a photo or document for printing.
2. Select the print command in your application.

Note: You may need to select a print icon on your screen, the **Print** option in the File menu, or another command. See your application's help utility for details.

3. Select your product as the **Printer** setting.

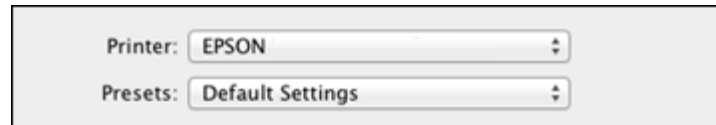

4. If necessary, click the arrow next to the Printer setting or the **Show Details** button to expand the print window.

You see the expanded printer settings window for your product:

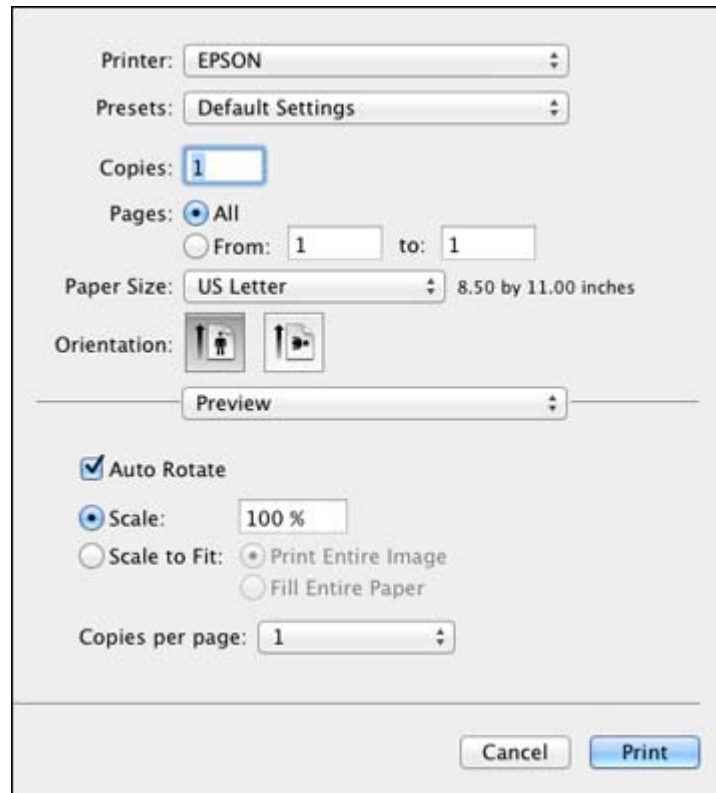

Note: The print window may look different, depending on the version of OS X and the application you are using.

5. Select the **Copies** and **Pages** settings as necessary.

Note: If you do not see these settings in the print window, check for them in your application before printing.

6. Select the page setup options: **Paper Size** and **Orientation**.

Note: If you do not see these settings in the print window, check for them in your application before printing. They may be accessible by selecting **Page Setup** from the File menu.

7. Select any application-specific settings that appear on the screen, such as those shown in the image above for the Preview application.
8. Select **Print Settings** from the pop-up menu.

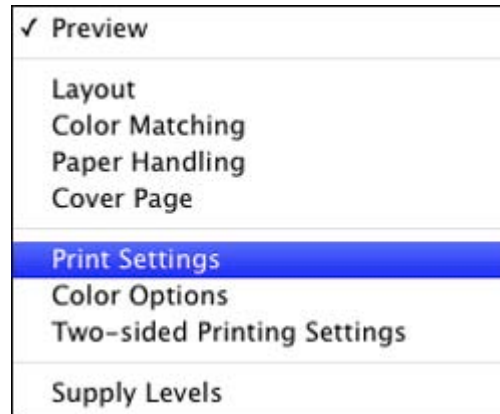

You see these settings:

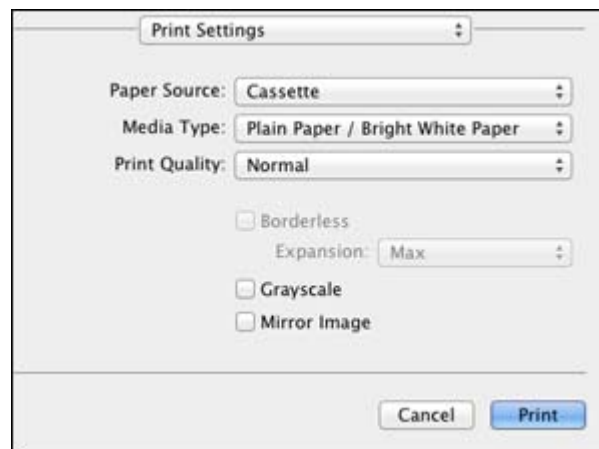

9. Select the **Paper Source** you wish to print from.
10. Select the type of paper you loaded as the **Media Type** setting.

Note: The setting may not exactly match the name of your paper. Check the paper type settings list for details.

11. Select the **Print Quality** setting you want to use.
12. Select any of the available print options.

[Paper Source Options - Mac OS X](#)

[Print Quality Options - OS X](#)

[Print Options - OS X](#)

Parent topic: [Printing with OS X](#)

Related references

[Paper Type Settings](#)

Related tasks

[Printing Your Document or Photo - OS X](#)

[Selecting Page Setup Settings - OS X](#)

Paper Source Options - Mac OS X

You can select any of the available options in the Paper Source menu to print on the paper loaded in that source.

Auto Select

Automatically selects the paper source based on the selected paper size.

Cassette 1

Selects the paper in cassette 1 as the paper source.

Cassette 2

Selects the paper in cassette 2 as the paper source.

Rear Paper Feed Slot

Selects the paper in the rear feed slot as the paper source.

Parent topic: [Selecting Basic Print Settings - OS X](#)

Print Quality Options - OS X

You can select any of the available Print Quality options to fine-tune the quality of your print. Some settings may be unavailable, depending on the paper type setting you have chosen.

Draft

For draft printing on plain paper.

Normal

For everyday text and image printing.

Normal - Vivid

For everyday text and image printing with good quality and print speed.

Fine

For text and graphics with good quality and print speed.

Quality

For text and graphics with increased quality and print speed.

Best Quality

For the best print quality, but the slowest print speed.

Parent topic: [Selecting Basic Print Settings - OS X](#)

Print Options - OS X

You can select any of the print options to customize your print. Some options may be unavailable, depending on other settings you have chosen.

Grayscale

Prints text and graphics in black or shades of gray.

Mirror Image

Lets you flip the printed image horizontally.

Parent topic: [Selecting Basic Print Settings - OS X](#)

Selecting Page Setup Settings - OS X

Depending on your application, you may be able to select the paper size and orientation settings from the print window.

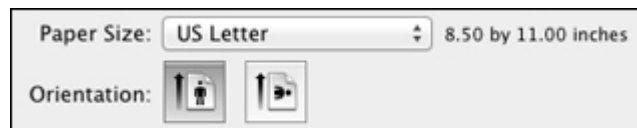

Note: If you do not see these settings in the print window, check for them in your application before printing. They may be accessible by selecting **Page Setup** from the File menu.

1. Select the size of the paper you loaded as the **Paper Size** setting.
2. Select the orientation of your document or photo as shown in the print window.

Note: If you are printing an envelope, select the  icon.

Note: You can reduce or enlarge the size of the printed image by selecting **Paper Handling** from the pop-up menu and selecting a scaling option.

Parent topic: [Printing with OS X](#)

Selecting Print Layout Options - OS X

You can select a variety of layout options for your document or photo by selecting **Layout** from the pop-up menu on the print window.

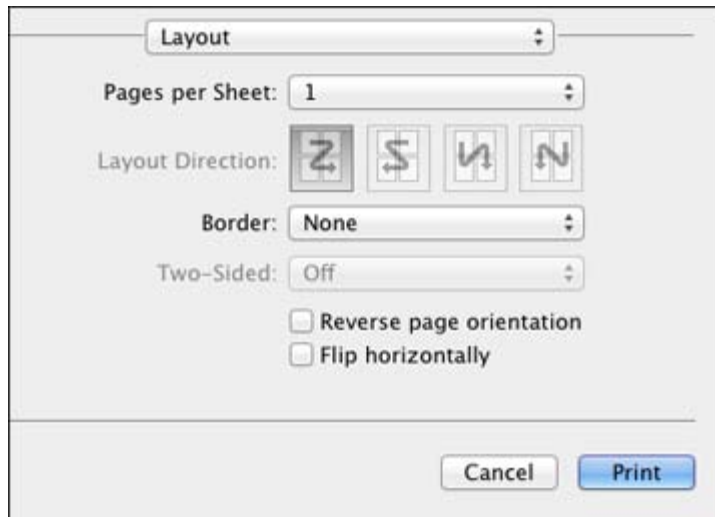

- To print multiple pages on one sheet of paper, select the number of pages in the **Pages per Sheet** pop-up menu. To arrange the print order of the pages, select a **Layout Direction** setting.
- To print borders around each page on the sheet, select a line setting from the **Border** pop-up menu.
- To invert or flip the printed image, select the **Reverse page orientation** or **Flip horizontally** settings.

Parent topic: [Printing with OS X](#)

Selecting Double-sided Printing Settings - OS X

You can print on both sides of the paper by selecting **Two-sided Printing Settings** from the pop-up menu on the print window.

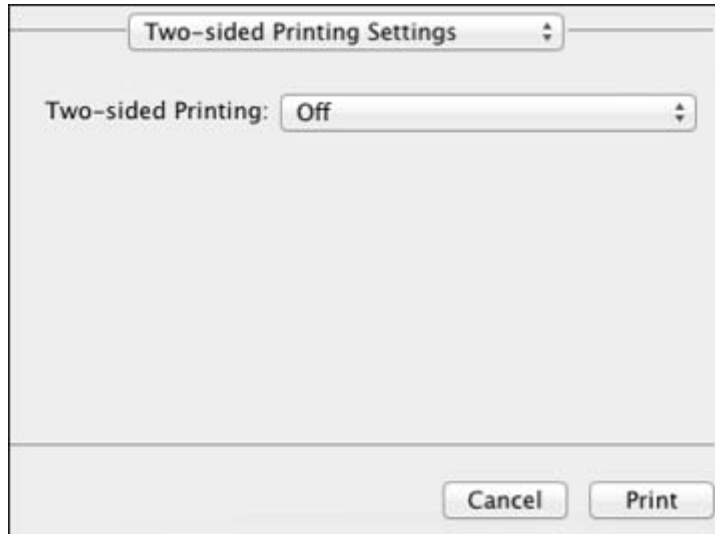

Note: Some options may be pre-selected or unavailable, depending on other settings you have chosen or if you are accessing the product over a network. This screen may be different, depending on the version of OS X you are using.

1. Select one of the **Two-sided Printing** options.

2. Select the type of document you are printing as the **Document Type** setting. The software automatically sets the Adjustments options for that document type.

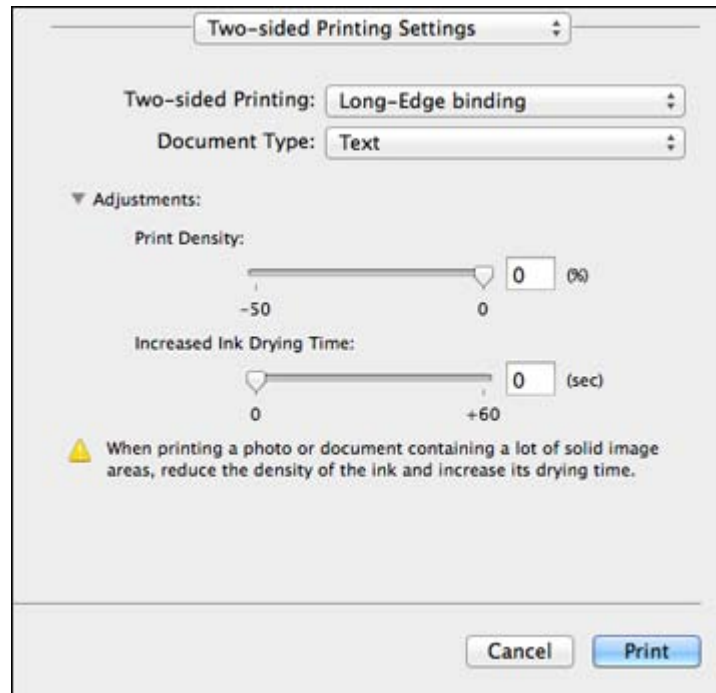

3. If necessary, customize the Adjustments settings as instructed on the screen.
4. Print a test copy of your double-sided document to test the selected settings.
5. Follow any instructions displayed on the screen during printing.

[Double-sided Printing Options and Adjustments - OS X](#)

Parent topic: [Printing with OS X](#)

Double-sided Printing Options and Adjustments - OS X

You can select any of the available options in the **Two-sided Printing Settings** or **Output Settings** pop-up menu to set up your double-sided print job.

Two-sided Printing Options

Long-Edge binding

Orients double-sided printed pages to be bound on the long edge of the paper.

Short-Edge binding

Orients double-sided printed pages to be bound on the short edge of the paper.

Adjustments

Print Density

Sets the level of ink coverage for double-sided printing.

Increased Ink Drying Time

Sets the amount of time required for drying ink after printing on one side of the paper before printing the other side in double-sided printing.

Parent topic: [Selecting Double-sided Printing Settings - OS X](#)

Managing Color - OS X

You can adjust the Color Matching and Color Options settings to fine-tune the colors in your printout, or turn off color management in your printer software.

1. Select **Color Matching** from the pop-up menu in the print window.

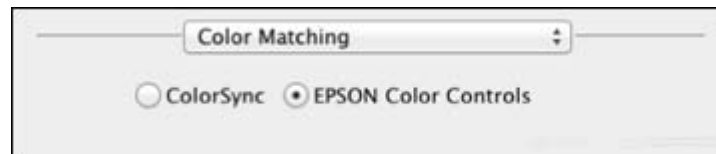

2. Select one of the available options.

3. Select **Color Options** from the pop-up menu in the print window.

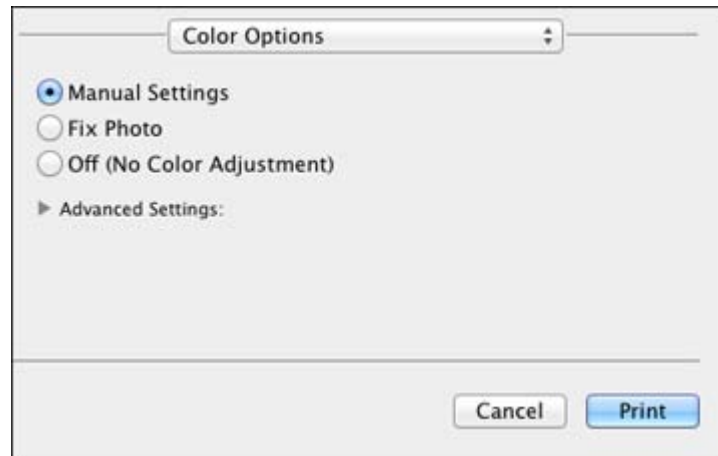

Note: The available settings on the Color Options menu depend on the option you selected on the Color Matching menu.

4. Select one of the available options.

[Color Matching and Color Options - OS X](#)

Parent topic: [Printing with OS X](#)

Color Matching and Color Options - OS X

You can select from these settings on the **Color Matching** and **Color Options** menus.

Color Matching Settings

EPSON Color Controls

Lets you manage color using controls in your printer software, or turn off color management.

ColorSync

Prints using standard color profiles for your product and paper to help match image colors. You can customize the conversion method and filter settings on the ColorSync pop-up menu in the print window.

Color Options Settings

Manual Settings

Lets you select manual color adjustments. Click the arrow next to **Advanced Settings** and select settings for **Brightness**, **Contrast**, **Saturation**, and individual color tones. You can also select a color **Mode** setting for printing photos and graphics and the **Fix Red-Eye** setting to reduce or remove red-eye in photos. Depending on the selected color mode, you can also adjust the midtone density using the **Gamma** setting.

Fix Photo

Improves the color, contrast, and sharpness of flawed photos. Click the arrow next to **Advanced Settings** and select the **Fix Red-Eye** setting to reduce or remove red-eye in photos.

Note: Fix Photo uses a sophisticated face recognition technology to optimize photos that include faces. For this to work, both eyes and the nose must be visible in the subject's face. If your photo includes a face with an intentional color cast, such as a statue, you may want to turn off **Fix Photo** to retain the special color effects.

Off (No Color Adjustment)

Turns off color management in your printer software so you can manage color using only your application software.

Parent topic: [Managing Color - OS X](#)

Selecting Printing Preferences - OS X

You can select printing preferences that apply to all the print jobs you send to your product.

1. In the Apple menu or the Dock, select **System Preferences**.
2. Select **Print & Fax**, **Print & Scan**, or **Printers & Scanners**, select your product, and select **Options & Supplies**.
3. Select **Driver** or **Options**.

You see a screen like this:

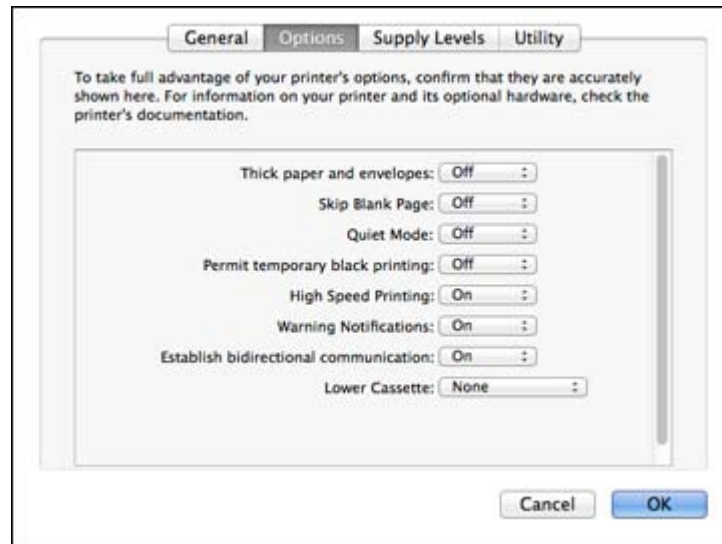

4. Select any of the available printing preferences.
5. Click **OK**.

[Printing Preferences - OS X](#)

Parent topic: [Printing with OS X](#)

Printing Preferences - OS X

You can select from these settings on the Options or Driver tab.

Note: Automatic Cassette Switching is available only if your product has two cassettes.

Thick paper and envelopes

Prevents ink from smearing when you print on envelopes or other thick paper.

Skip Blank Page

Ensures that your product does not print pages that contain no text or images.

Quiet Mode

Lessens noise during printing but may decrease print speed.

Permit temporary black printing

Allows you to print using black ink when a color ink cartridge is expended.

Automatic Cassette Switching

Automatically switches to the other cassette when one of the cassettes runs out of paper.

High Speed Printing

Speeds up printing, but may reduce print quality.

Warning Notifications

Lets you choose whether or not to receive warning notifications from the printer software for various operating conditions.

Establish bidirectional communication

Allows the product to communicate with the computer. Do not change the default setting unless you experience issues when using a shared printing pool.

Lower Cassette

Specifies whether the optional cassette is present.

Parent topic: [Selecting Printing Preferences - OS X](#)

Printing Your Document or Photo - OS X

Once you have selected your print settings, you are ready to print.

Click **Print** at the bottom of the print window.

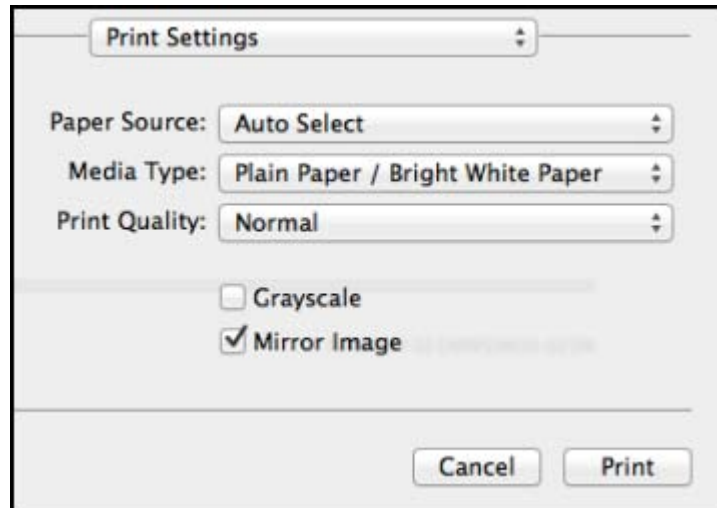

Checking Print Status - OS X

Parent topic: [Printing with OS X](#)

Checking Print Status - OS X

During printing, you can view the progress of your print job, control printing, and check ink cartridge status.

1. Click the printer icon when it appears in the Dock.

You see the print status window:

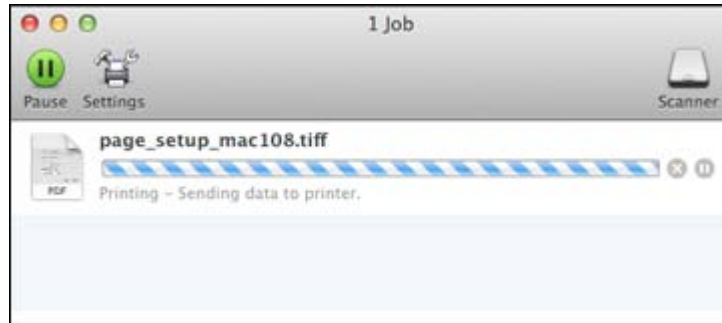



2. Select the following options as necessary:

OS X 10.5/10.6/10.7:

- To cancel printing, click the print job and click the **Delete** icon.
- To pause a print job, click the print job and click the **Hold** icon. To resume a print job, click the print job marked "Hold" and click the **Resume** icon.
- To pause printing for all queued print jobs, click the **Pause Printer** icon.
- To check ink status, click the **Supply Levels** icon.

OS X 10.8/10.9:

- To cancel printing, click the  button next to the print job.
- To pause a print job, click the  button next to the print job. To resume a print job, click the  button.
- To pause printing for all queued print jobs, click the large **Pause** button.
- To check ink status, click the **Settings** icon, then click the **Supply Levels** tab.

Parent topic: [Printing Your Document or Photo - OS X](#)

Cancelling Printing Using a Product Button

If you need to cancel printing, press the  **Stop** button on your product.

Parent topic: [Printing from a Computer](#)

Scanning

You can scan original documents or photos and save them as digital files.

[Starting a Scan](#)

[Selecting Epson Scan Settings](#)

[Scanning with OS X Using Image Capture](#)

[Scanning Special Projects](#)

Starting a Scan

After placing your original documents or photos on your product for scanning, start scanning using one of these methods.

[Starting a Scan Using the Product Control Panel](#)

[Starting a Scan with Document Capture Pro or Document Capture](#)

[Starting a Scan Using the Epson Scan Icon](#)

[Starting a Scan from a Scanning Program](#)

Parent topic: [Scanning](#)

Related topics

[Placing Originals on the Product](#)

Starting a Scan Using the Product Control Panel

You can scan an image to a memory device or to your computer using your product's control panel.

1. Make sure you installed the product software and connected the product to your computer or network.

Note: Restart your computer after installing the product software to enable scanning from the control panel. Also make sure the Event Manager program is not being blocked by your firewall or security software.

2. Place your original on the product for scanning.

Note: To scan a double-sided document, place it in the ADF and select the **2-Sided** setting.

3. Press the  home button, if necessary.

4. Select **Scan**.

You see a screen like this:



5. Select one of the following **Scan to** options:

- **Memory Device** saves your scan file on a memory or USB device and lets you select the file format, quality, and other settings.
- **Cloud** sends your scanned files to a destination that you have registered with Epson Connect.
- **Document Capture Pro** allows you to scan over a network using your saved job settings in Document Capture Pro or Document Capture.
- **Computer (WSD)** lets you manage network scanning in Windows 8, Windows 7, or Windows Vista (English only). To use this feature, you must first set up WSD (Web Services for Devices) on the computer.

6. Select **Preset** to save your scan settings.

Note: Presets can be locked by an administrator. If you cannot access or change this setting, contact your administrator for assistance.

7. Do one of the following:

- If you are scanning to a computer, select the target computer, and select the format and 2-sided setting, if necessary.
- If you are scanning to a memory device, select **Settings** to display additional scanning options.

[Adding and Assigning Scan Jobs](#)

Parent topic: [Starting a Scan](#)

Related tasks

[Using Epson Scan to Cloud](#)

[Using Presets](#)

Related topics

[Placing Originals on the Product](#)

Adding and Assigning Scan Jobs

You can view, change, or add available default scan settings when you scan using the Document Capture Pro option on the product control panel. You do this by accessing the scan jobs in the Document Capture Pro (Windows) or Document Capture (OS X) program.

1. Start Document Capture Pro or Document Capture on a computer connected to the product.

2. Click the  Manage Job icon from the toolbar at the top of the window.

You see a window showing the current scan job list.

3. If you want to add a scan job, click **Add** or the **+** icon, enter a name for the new job, select settings as necessary, and click **OK**.

You can now use the new scan job when you scan with Document Capture Pro or Document Capture.

Note: See the Help information in Document Capture Pro or Document Capture for details.

4. If you want to assign scan jobs to the selection list on the product control panel, do one of the following:

- **Windows:** Click **Event Settings**.

- **OS X:** Click the  icon at the bottom of the window, then click **Event Settings**.

5. Select the jobs that you want to assign to any of the pull-down menus, click **OK**, then click **OK** again.

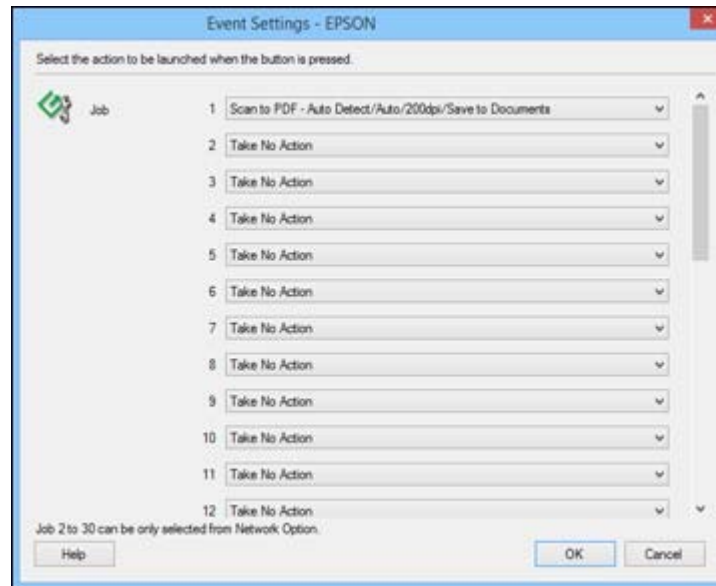

You can now use the added scan jobs when you scan from the product control panel.

Parent topic: [Starting a Scan Using the Product Control Panel](#)

Starting a Scan with Document Capture Pro or Document Capture

When you scan with Document Capture Pro (Windows) or Document Capture (OS X), the program automatically saves your scanned file on your computer in the folder you specify. You can select settings, preview, and change the scanned file settings as necessary.

1. Do one of the following to start Document Capture Pro or Document Capture:
 - **Windows 8.x:** Navigate to the **Apps** screen and select **Document Capture Pro**.
 - **Windows (other versions):** Click  or **Start**, and select **All Programs** or **Programs**. Select **EPSON Software**, then select **Document Capture Pro**.
 - **OS X:** Open the **Applications** folder, select the **Epson Software** folder, and select **Document Capture**. Select your product and click **OK**, if necessary.

You see a window like this:

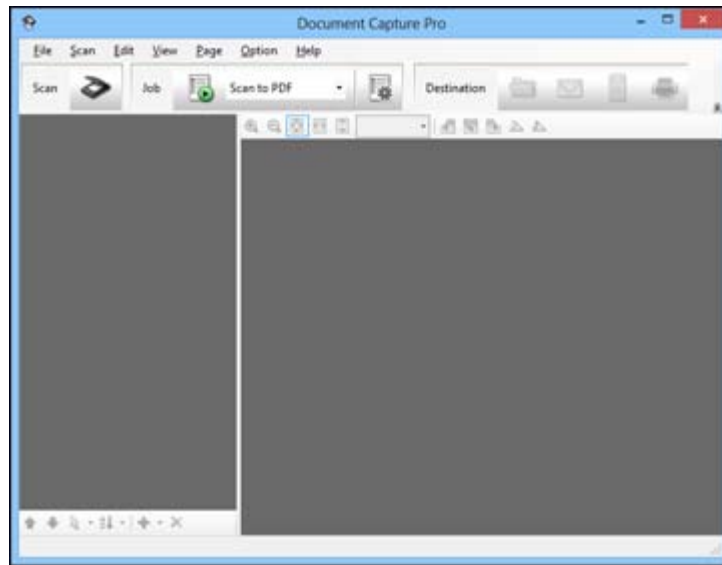

2. Click the  Scan icon.

You see a window like this:

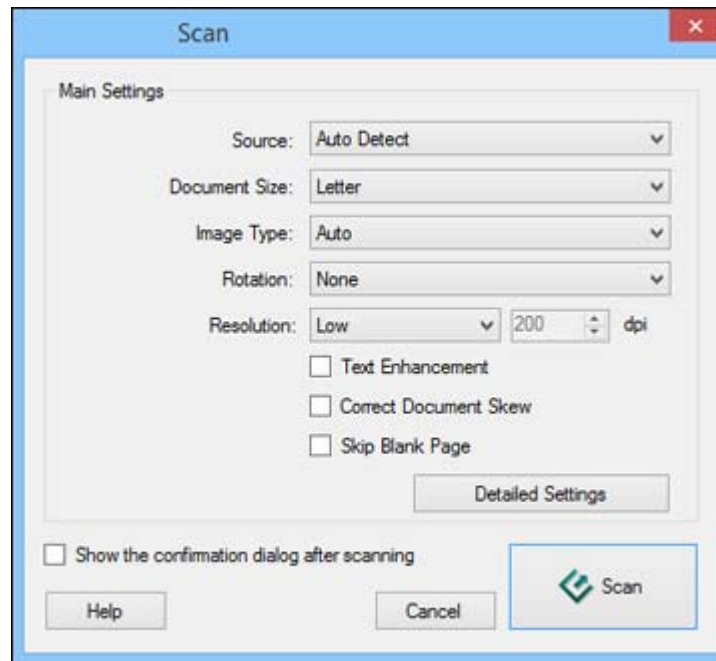

Note: With OS X 10.6, 10.7, 10.8, or 10.9, you can download and install Epson Scan scanning software, which will provide additional image adjustment features within Document Capture. To download Epson Scan, visit Epson's driver download site ([U.S. downloads](#) or [Canadian downloads](#)).

Note: If you want to use a scan job that you created instead, select it from the Job list in the Document Capture Pro or Document Capture window, click the  Start Job button, and skip the rest of these steps.

3. Select any displayed scan settings you want to use.

Note: See the Help information in Document Capture Pro or Document Capture for details.

4. If you want to select detailed scan settings, do one of the following:
 - **Windows:** Click **Detailed Settings**. Select any displayed scan settings you want to use and click **OK**.

- **OS X:** If you installed Epson Scan, close the Scan Settings window, open the **Scan** menu at the top of the screen and select **Displays the EPSON Scan Setup Screen**. Click the  Scan icon. Select any displayed scan settings you want to use and click **OK**.
5. Click **Scan**.
You see a preview of your scan in the Document Capture Pro or Document Capture window.
 6. Check the scanned images and edit them as necessary.
 7. Click one of the Destination icons to choose where to save your scanned file.



Note: You may need to click the arrow next to the icons in order to see all of them. The available icons may vary, depending on the software version you are using.

8. Select settings as necessary, then click **OK**, **Send**, or **Print** to save the scanned file.

Parent topic: [Starting a Scan](#)

Starting a Scan Using the Epson Scan Icon

You can start the Epson Scan program to select scan settings, scan, and save the scanned image to a file.

- **Windows 8.x:** Navigate to the **Apps** screen and select **EPSON Scan** under **EPSON** or **EPSON Software**.
- **Windows (other versions):** Click  or **Start**, and select **All Programs** or **Programs**. Select **EPSON** or **EPSON Software** and click **EPSON Scan**.
- **OS X:** Open the **Applications** folder, open the **Epson Software** folder, and double-click the **EPSON Scan** icon.

Note: With OS X 10.6, 10.7, 10.8, or 10.9, in addition to scanning with Image Capture, you can download and install Epson Scan scanning software. Epson Scan provides additional image adjustment and photo correction features for enhancing scanned images, and provides an interface for TWAIN-compliant OCR scanning software, such as ABBYY FineReader. To download Epson Scan, visit Epson's driver download site ([U.S. downloads](#) or [Canadian downloads](#)).

You see an Epson Scan window like this:

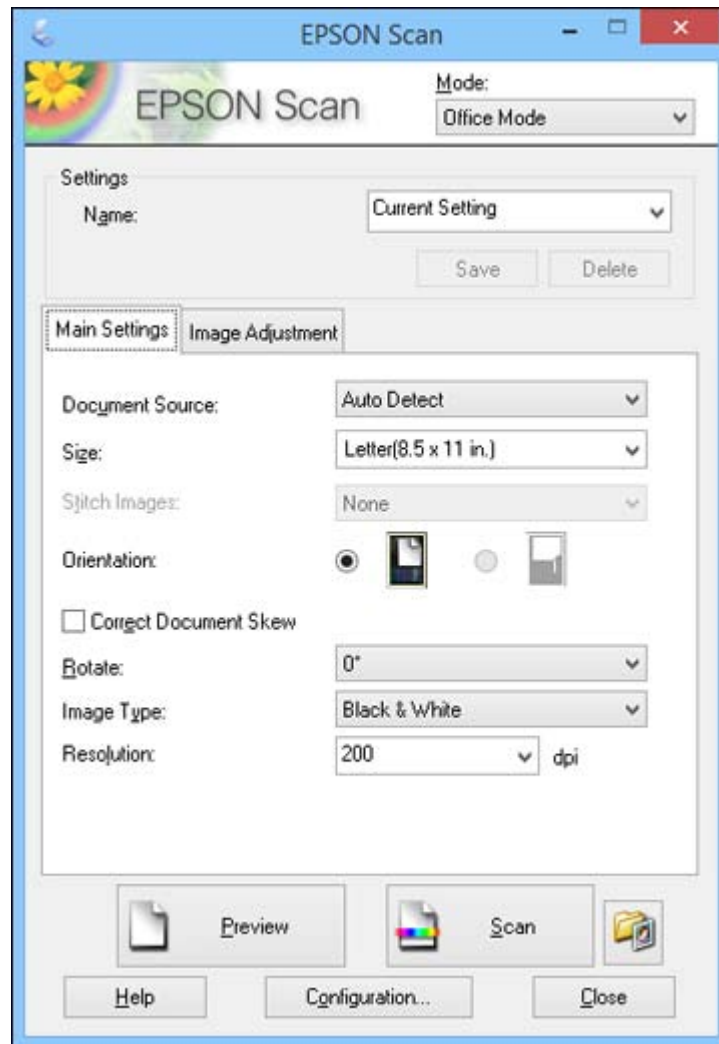

Parent topic: [Starting a Scan](#)

Related tasks

[Scanning with OS X Using Image Capture](#)

Related topics

[Placing Originals on the Product](#)

[Selecting Epson Scan Settings](#)

Starting a Scan from a Scanning Program

You can start Epson Scan from a scanning program to select scan settings, scan, and open the scanned image in the program.

Note: With OS X 10.6, 10.7, 10.8, or 10.9, in addition to scanning with Image Capture, you can download and install Epson Scan scanning software. Epson Scan provides additional image adjustment and photo correction features for enhancing scanned images, and provides an interface for TWAIN-compliant OCR scanning software, such as ABBYY FineReader. To download Epson Scan, visit Epson's driver download site ([U.S. downloads](#) or [Canadian downloads](#)).

1. Open your scanning program and select its scanning option. (See your scanning program help for instructions.)
2. Select your product.

Note: In certain programs, you may need to select your product as the "source" first. If you see a **Select Source** option, choose it and select your product. With Windows, do not select a **WIA** option for your product; it will not work correctly.

You see an Epson Scan window like this:

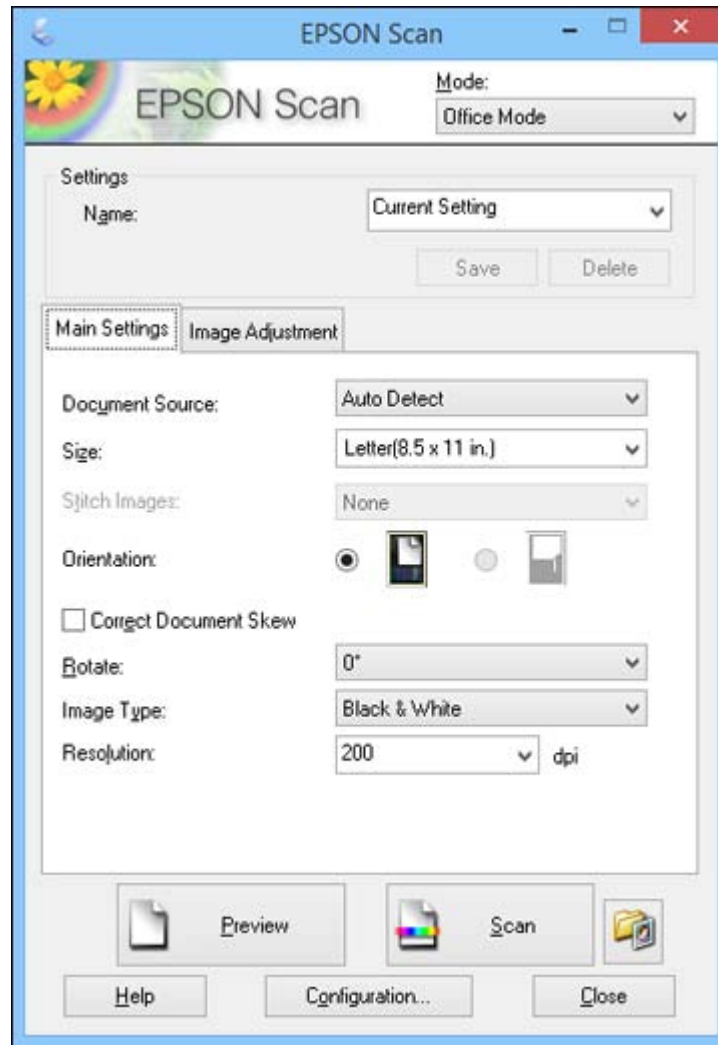

Note: Epson Scan may start in a different mode when you first access it.

Parent topic: [Starting a Scan](#)

Related topics

[Placing Originals on the Product](#)

Selecting Epson Scan Settings

After starting Epson Scan, you can select settings in various modes to customize your scan.

[Scan Modes](#)

[Selecting the Scan Mode](#)

[Scanning in Office Mode](#)

[Scanning in Professional Mode](#)

[Image Preview Guidelines](#)

[Scan Resolution Guidelines](#)

[Selecting Scan File Settings](#)

Parent topic: [Scanning](#)

Scan Modes

Epson Scan provides a choice of scan modes with different levels of control over your settings.

Office Mode

You can quickly scan text documents and adjust them on a preview screen. You can also select various image adjustment options and preview your scanned image.

Professional Mode

You can manually customize all available settings, and preview and size your scanned image.

Parent topic: [Selecting Epson Scan Settings](#)

Selecting the Scan Mode

Select the Epson Scan mode you want to use from the Mode box in the upper right corner of the Epson Scan window:

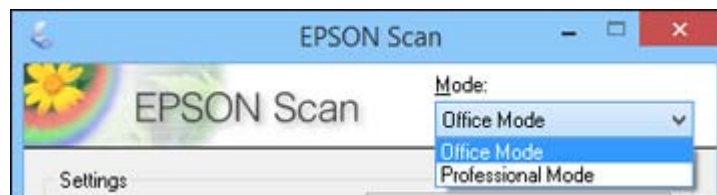

Parent topic: [Selecting Epson Scan Settings](#)

Scanning in Office Mode

When you scan in Office Mode, Epson Scan automatically saves your scanned file in PDF format in your operating system's Documents or My Documents folder, or opens it in your scanning program. You can select settings, preview, and change the scanned file settings as necessary.

1. Start Epson Scan and select **Office Mode** as the Mode setting.

You see this window:

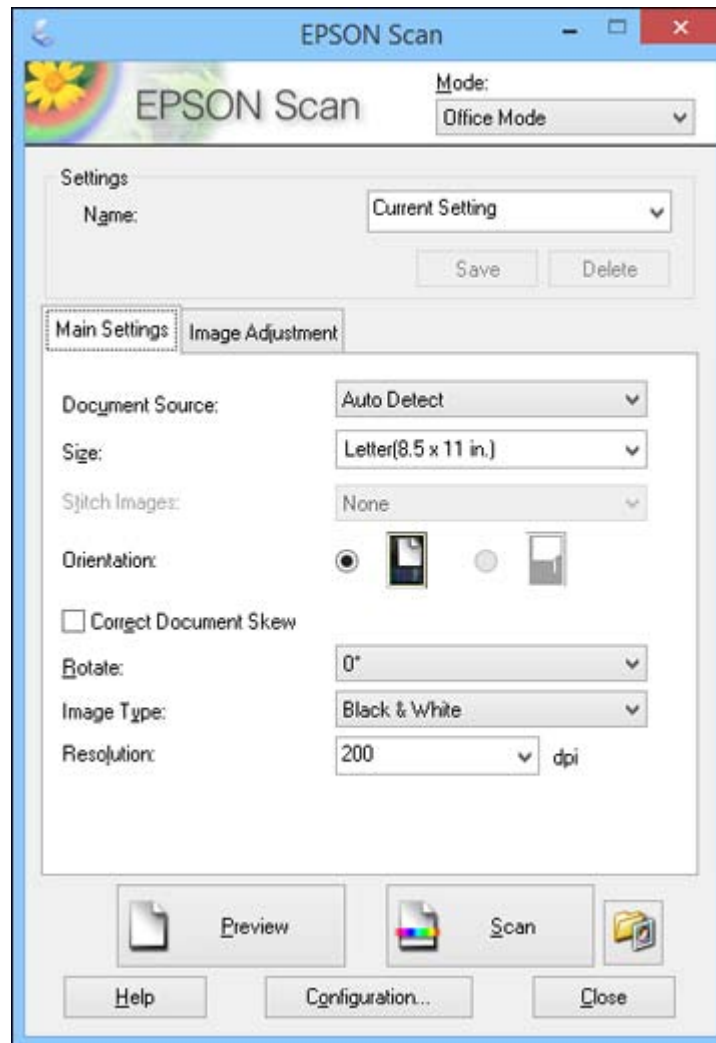

2. Select the **Document Source** setting indicating where you placed your original. To scan a 2-sided document in the ADF, select **ADF-Double-sided**.

Note: If you are using the ADF, remove any documents from the scanner glass.

3. Select the **Size** and **Orientation** settings that match your original.
4. To scan both sides of a 2-sided original into one image, select a **Stitch Images** setting.

Note: To use the Stitch Images setting, you must select **ADF-Double-sided** as the **Document Source** setting.

5. To allow Epson Scan to detect and correct any skew in your original, select **Correct Document Skew**.
6. To rotate your original in your scan, select a **Rotate** setting.
7. Select the **Image Type** setting that matches your original.
8. Select the **Resolution** setting you want to use for your scan.
9. Click the **Preview** button.

Epson Scan previews your original and displays the result in a separate Preview window.

10. If you are using the ADF, reinsert your original into the ADF.
11. If desired, select the area in your preview image that you want to scan (scan area).

Note: You cannot select a scan area if you chose **ADF-Double-sided** as the **Document Source** setting.

12. Click the **Image Adjustment** tab and select any of the image adjustment settings you want to use. Before making adjustments, click the image or scan area in the Preview window.
13. Click **Scan**.

You see the File Save Settings window.

14. Change any of the necessary file save settings and click **OK**.

Epson Scan scans your original, and saves the file in the selected folder or opens it in your scanning program. If the file was saved directly to your computer, you see the file in the Windows Explorer or OS X Finder, where you can view and print the image, if desired.

[Available Document Source Settings - Office Mode](#)

[Selecting a Scan Area - Office Mode](#)

[Available Image Adjustments - Office Mode](#)

Parent topic: [Selecting Epson Scan Settings](#)

Related concepts

[Scan Resolution Guidelines](#)

[Image Preview Guidelines](#)

Related tasks

[Selecting Scan File Settings](#)

[Scanning in Professional Mode](#)

Available Document Source Settings - Office Mode

You can select these Document Source options in Epson Scan Office Mode.

Scanner Glass

Selects the scanner glass as the location where the originals are placed on your product for scanning.

ADF - Single-sided

Selects the Automatic Document Feeder as the location where the originals are placed on your product for single-sided scanning.

ADF - Double-sided

Selects the Automatic Document Feeder as the location where the originals are placed on your product for double-sided scanning.

Auto Detect

Automatically detects where the originals are placed on your product for scanning.

Parent topic: [Scanning in Office Mode](#)

Selecting a Scan Area - Office Mode

You can select a specific area in your preview image to include in your scanned image. You can select the entire image area or a portion of it. You can even select multiple scan areas to create multiple scanned images of different areas.

You can also use the scan area to select specific Image Adjustments settings for a scanned image. Just be sure to click inside the scan area before selecting the settings.

1. In the Preview window, click the  Auto Locate icon to create a marquee (dotted line) on the preview image.

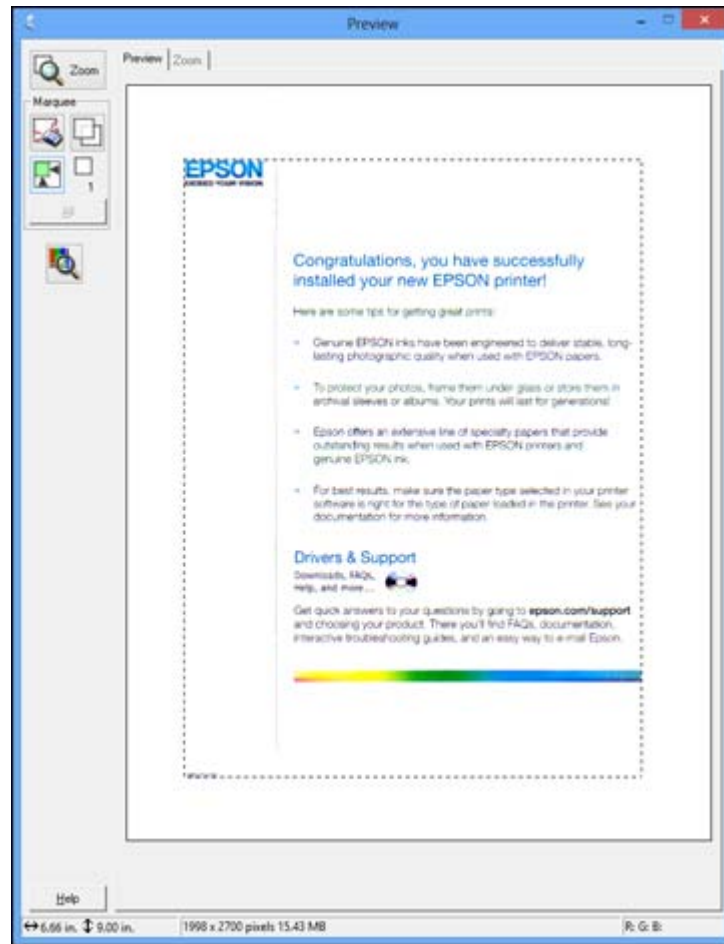

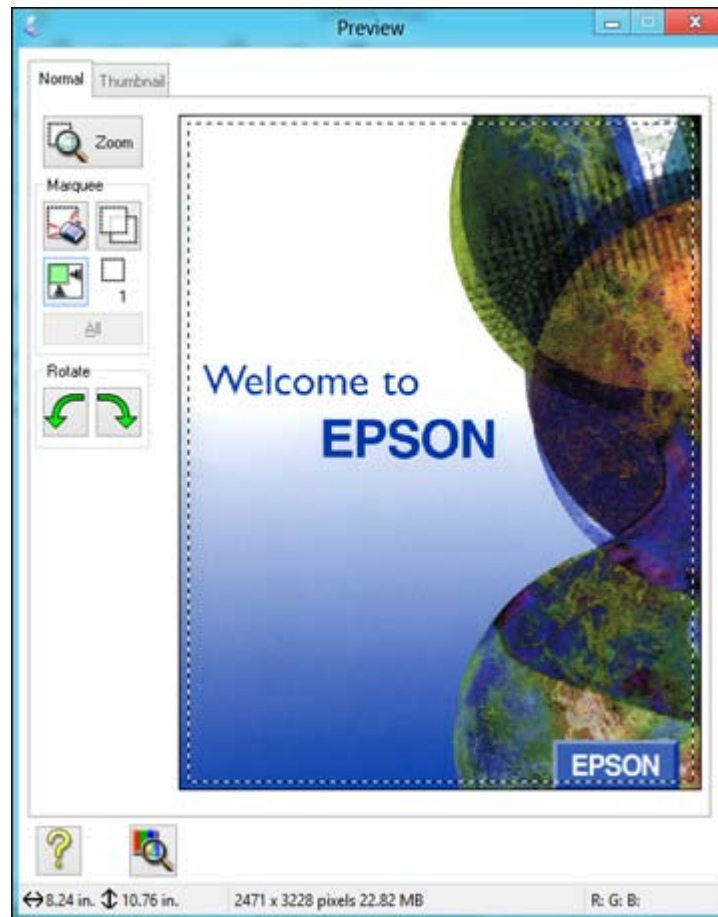

2. Do the following, as necessary, to work with the selected scan area:
 - If the marquee is correct, continue with the next step.
 - To move the marquee, click inside the scan area and drag the marquee where you want it.
 - To resize the scan area, place your cursor over the edge or corner of the marquee, then click and drag the edges where you want them. (Hold down the **Shift** key as you resize the marquee to retain the same width/height proportions.)
 - To create additional marquees (up to 50, if available), click the  Copy Marquee icon to copy the existing marquee and paste it on the preview image.

Note: If you draw multiple marquees, make sure you select the **All** button in the Preview window before you scan. Otherwise, only the area inside the currently selected marquee will be scanned.

- To delete a marquee, click the marquee, then click the  Delete Marquee icon.
 - To rotate your original in your scan, click one of the **Rotate** icons.
3. Click inside each scan area and make any necessary settings in the Epson Scan window.

Parent topic: [Scanning in Office Mode](#)

Related concepts

[Image Preview Guidelines](#)

[Scan Resolution Guidelines](#)

Related tasks

[Selecting Scan File Settings](#)

Available Image Adjustments - Office Mode

You can select these Image Adjustments options in Epson Scan Office Mode. Not all adjustment settings may be available, depending on other settings you have chosen.

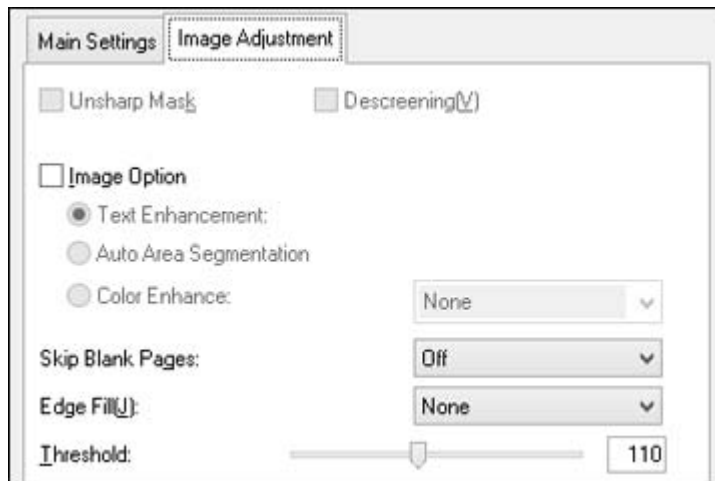

Note: Select the **Image Option** checkbox if you need to set any of the grayed-out image adjustments beneath the checkbox.

Unsharp Mask

Makes the edges of certain image areas clearer. Turn off this option to leave softer edges.

Descreening

Removes the ripple pattern that might appear in subtly shaded image areas, such as skin tones. This option improves results when scanning magazines or newspapers. (The results of descreening do not appear in the preview image, only in your scanned image.)

Text Enhancement

Sharpens the appearance of letters in text documents.

Auto Area Segmentation

Makes grayscale images clearer and text recognition more accurate by separating the text from the graphics.

Color Enhance

Enhances the red, green, or blue shades in the scanned image.

Skip Blank Pages

Ensures that your product does not scan pages that contain no text or images.

Edge Fill

Corrects shadowing around the edges of the image by filling the shadows with the color you select.

Brightness

Adjusts the overall lightness and darkness of the scanned image.

Contrast

Adjusts the difference between the light and dark areas of the overall scanned image.

Threshold

Adjusts the level at which black areas in text and line art are delineated, improving text recognition in OCR (Optical Character Recognition) programs.

Parent topic: [Scanning in Office Mode](#)

Scanning in Professional Mode

When you scan in Professional Mode, Epson Scan automatically saves your scanned file in PDF format in your operating system's Documents or My Documents folder, or opens it in your scanning program. You can select settings, preview, and change the scanned file settings as necessary.

1. Start Epson Scan and select **Professional Mode** as the Mode setting.

You see this window:

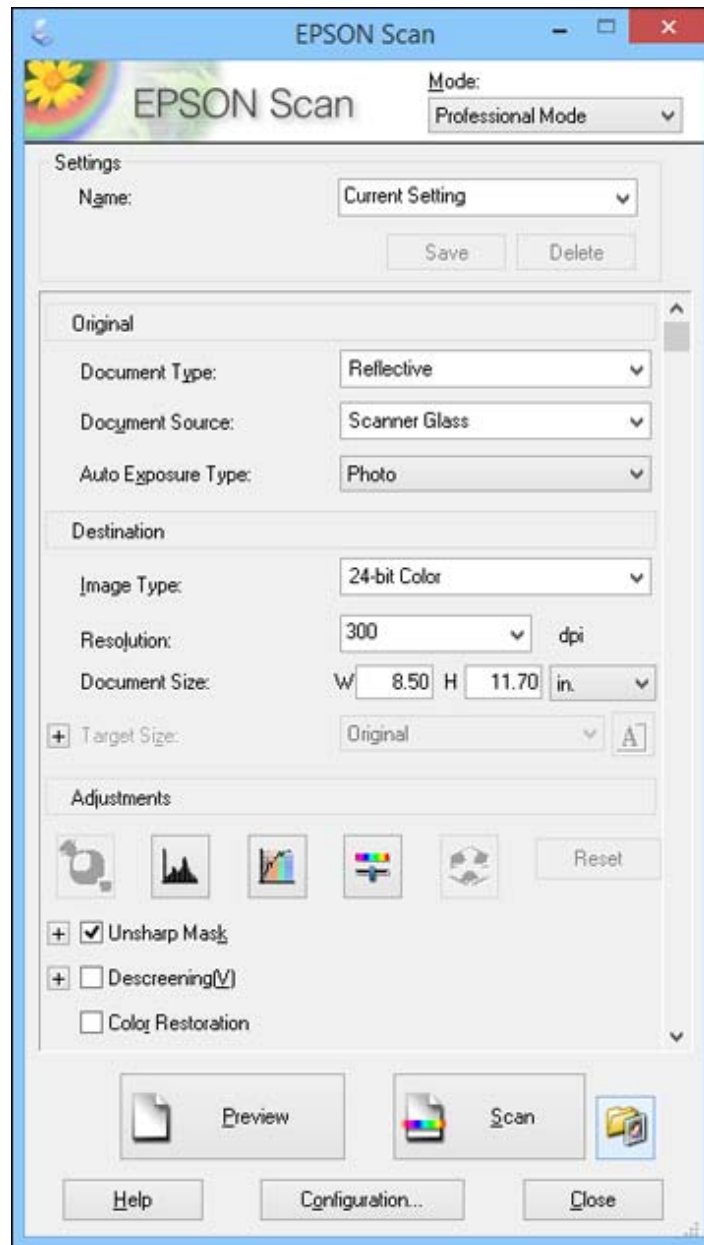

2. Select the **Document Type** setting that matches your original, such as **Reflective** for documents or photos.
3. Select the **Document Source** setting indicating where you placed your original. To scan a 2-sided document in the ADF, select **ADF - Double-sided**.

Note: If you are using the ADF, remove any documents from the scanner glass.

4. Select the specific type of original you are scanning as the **Auto Exposure Type** setting: **Document** or **Photo**.
5. Select the details of your original and how you want it scanned as the **Image Type** setting.
6. Select the **Resolution** setting you want to use for your scan.
7. Click the **Preview** button.

Epson Scan previews your original and displays the result in a separate Preview window.

8. If you are using the ADF, reinsert your original into the ADF.
9. If desired, select the area in your preview image that you want to scan (scan area).

Note: You cannot select a scan area if you chose **ADF-Double-sided** as the **Document Source** setting.

10. Select any of the image adjustment settings you want to use. Before making adjustments, click the image or scan area in the Preview window.
11. If you want to reduce or enlarge your image as you scan, select the **Target Size** setting you want to use.

Note: You cannot select a target size if you chose **ADF-Double-sided** as the **Document Source** setting.

12. Click **Scan**.

You see the File Save Settings window.

13. Change any of the necessary file save settings and click **OK**.

Epson Scan scans your original, and saves the file in the selected folder or opens it in your scanning program. If the file was saved directly to your computer, you see the file in the Windows Explorer or OS X Finder, where you can view and print the image, if desired.

[Available Document Source Settings - Professional Mode](#)

[Available Image Types - Professional Mode](#)
[Selecting a Scan Area - Professional Mode](#)
[Available Image Adjustments - Professional Mode](#)
[Selecting a Scan Size - Professional Mode](#)

Parent topic: [Selecting Epson Scan Settings](#)

Related concepts

[Image Preview Guidelines](#)
[Scan Resolution Guidelines](#)

Related tasks

[Selecting Scan File Settings](#)
[Scanning in Office Mode](#)

Available Document Source Settings - Professional Mode

You can select these Document Source options in Epson Scan Professional Mode.

Scanner Glass

Selects the scanner glass as the location where the originals are placed on your product for scanning.

ADF - Single-sided

Selects the Automatic Document Feeder as the location where the originals are placed on your product for single-sided scanning.

ADF - Double-sided

Selects the Automatic Document Feeder as the location where the originals are placed on your product for double-sided scanning.

Parent topic: [Scanning in Professional Mode](#)

Available Image Types - Professional Mode

You can select these Image Type options in Epson Scan Professional Mode.

24-bit Color

Select this setting for color photos.

Color Smoothing

Select this setting for color graphic images, such as charts or graphs.

8-bit Grayscale

Select this setting for black-and-white photos.

Black & White

Select this setting for black text documents or line art.

Parent topic: [Scanning in Professional Mode](#)

Selecting a Scan Area - Professional Mode

You can select a specific area in your preview image to include in your scanned image. You can select the entire image area or a portion of it. You can even select multiple scan areas to create multiple scanned images of different areas (Normal Preview mode only).

You can also use the scan area to select specific Image Adjustments settings for a scanned image. Just be sure to click inside the scan area before selecting the settings.

Note: In Professional Mode, the default Preview mode is Normal mode. To use Thumbnail Preview mode instead, click the **Thumbnail** tab.

1. Do one of the following to select your scan area in the Preview image:

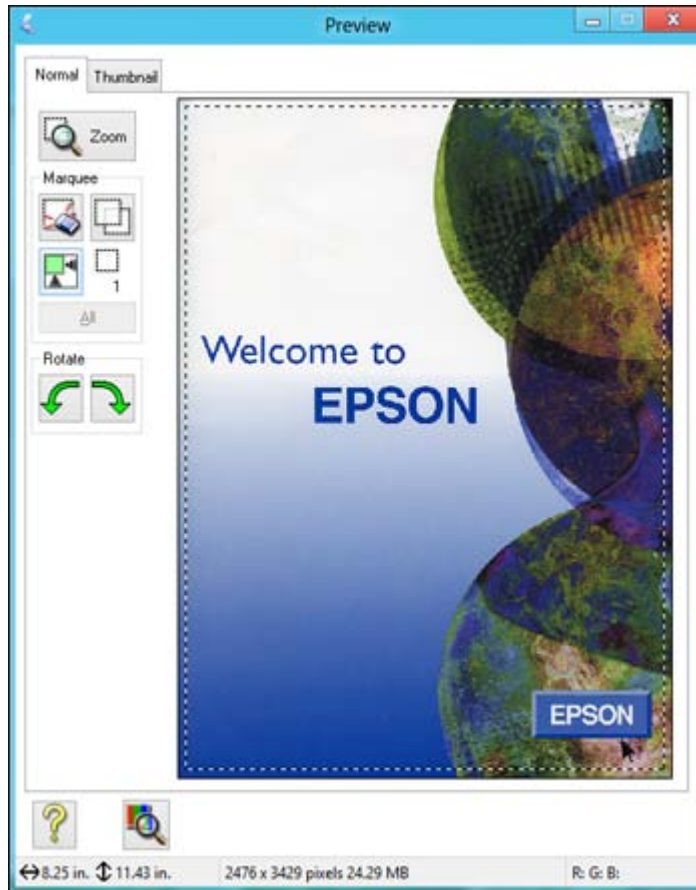

- **Normal preview:** Click the  Auto Locate icon to create a marquee (dotted line) on the preview image.

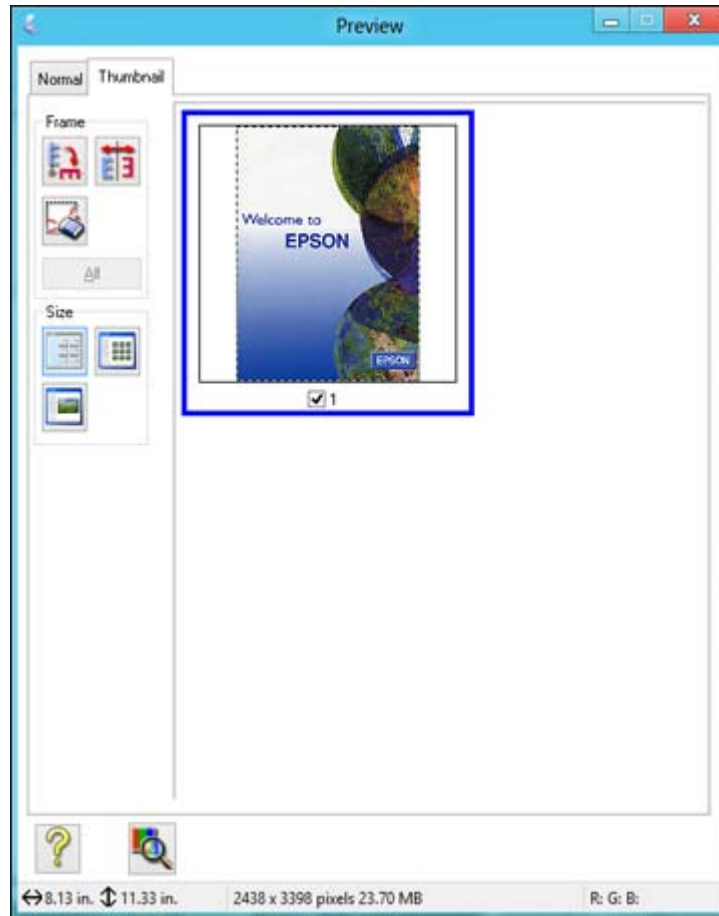

- **Thumbnail preview:** Your scan area is selected automatically, but you can change it. Place your cursor in one corner of the desired scan area, then click and drag the cursor to the opposite corner to create a marquee (dotted line) on the preview image.



2. Do the following, as necessary, to work with the selected scan area:
 - If the marquee is correct, continue with the next step.
 - To move the marquee, click inside the scan area and drag the marquee where you want it.

- To resize the scan area, place your cursor over the edge or corner of the marquee, then click and drag the edges where you want them. (Hold down the **Shift** key as you resize the marquee to retain the same width/height proportions.)
- **Normal preview:** To create additional marquees (up to 50, if available), click the  Copy Marquee icon to copy the existing marquee and paste it on the preview image.
- To delete a marquee, click the marquee, then click the  Delete Marquee icon.
- **Thumbnail preview:** To change the preview style, click one of the **Size** icons.

Note: If you draw multiple marquees, make sure you select the **All** button in the Preview window before you scan. Otherwise, only the area inside the currently selected marquee will be scanned.

3. Click inside the scan area and make any necessary settings in the Epson Scan window.

Parent topic: [Scanning in Professional Mode](#)

Available Image Adjustments - Professional Mode

You can select these Adjustments options in Epson Scan Professional Mode. Not all adjustment settings may be available, depending on other settings you have chosen.

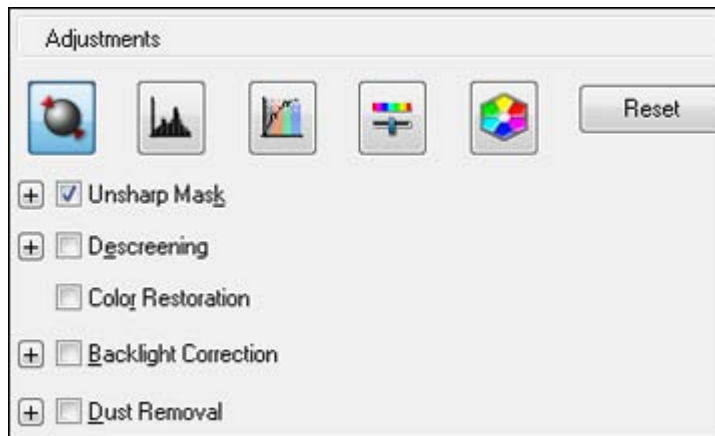

Note: Select the **Image Option** checkbox if you need to set any of the grayed-out image adjustments beneath the checkbox.

Click the  image adjustment icon to access additional settings.

Click the + (Windows) or ► (OS X) icon next to a setting to change the level of adjustment.

Unsharp Mask

Makes the edges of certain image areas clearer. Turn off this option to leave softer edges.

Descreening

Removes the ripple pattern that might appear in subtly shaded image areas, such as skin tones. This option improves results when scanning magazines or newspapers. (The results of descreening do not appear in the preview image, only in your scanned image.)

Color Restoration

Restores the colors in faded photos automatically.

Backlight Correction

Removes shadows from photos that have too much background light.

Dust Removal

Removes dust marks from your originals automatically.

Color Enhance

Enhances the red, green, or blue shades in the scanned image.

Edge Fill

Corrects shadowing around the edges of the image by filling the shadows with the color you select.

Auto Exposure

Automatically adjusts the image exposure settings when you click the  Auto Exposure icon. To automatically adjust image exposure settings continuously, click the **Configuration** button, click the **Color** tab, and select **Continuous auto exposure**. You can adjust the level of auto exposure using a slider.

Histogram Adjustment

Provides a graphical interface for adjusting highlight, shadow, and gamma levels individually. (For advanced users only.) Click the  histogram icon to access the settings.

Tone Correction

Provides a graphical interface for adjusting tone levels individually. (For advanced users only.) Click the  tone correction icon to access the settings.

Brightness

Adjusts the overall lightness and darkness of the scanned image.

Contrast

Adjusts the difference between the light and dark areas of the overall scanned image.

Saturation

Adjusts the density of colors in the overall image.

Color Balance

Adjusts the balance of colors in the overall image.

Color Palette

Provides a graphical interface for adjusting mid-tone levels, such as skin tones, without affecting the highlight and shadow areas of the image. (For advanced users only.) Click the  Color Palette icon to access the settings.

Threshold

Adjusts the level at which black areas in text and line art are delineated, improving text recognition in OCR (Optical Character Recognition) programs.

Parent topic: [Scanning in Professional Mode](#)

Selecting a Scan Size - Professional Mode

You can reduce or enlarge the size of your image as you scan. You can also select a specific scan size, such as a common photo size like 4 × 6 inches (102 × 152 mm). This places a scan area of that size on the preview image so you can use it to help crop the image in the correct proportions.

1. Click the **Preview** button to preview your image.
2. In the Epson Scan window, select the size you want your scanned image to be from the **Target Size** list.



Note: If you need to rotate the orientation of the target size for your image, click the  orientation icon.

A marquee (dotted line) appears on your preview image proportioned for the size you selected.

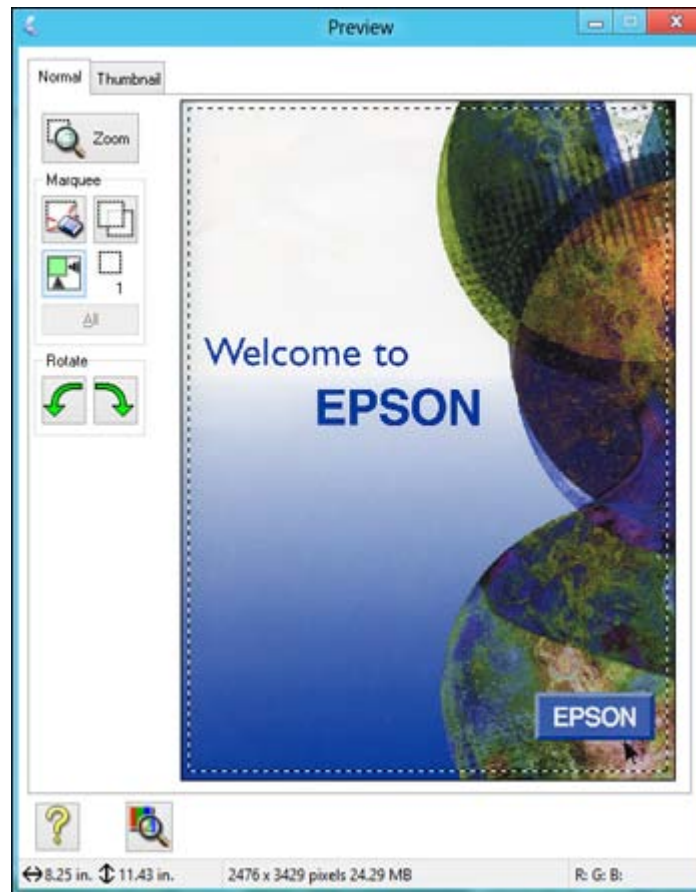

3. Do the following, as necessary, to work with the selected scan area:
 - To move the marquee, click inside the scan area and drag the marquee where you want it.
 - To resize the scan area, place your cursor over the edge or corner of the marquee, then click and drag the edge where you want it.

Note: Manually adjusting the marquee will not change the target size of the scanned file. The marquee only indicates the area of the image that will be scanned.

4. To create a scanned image size that is not available in the Target Size list, click the **Customize** option.

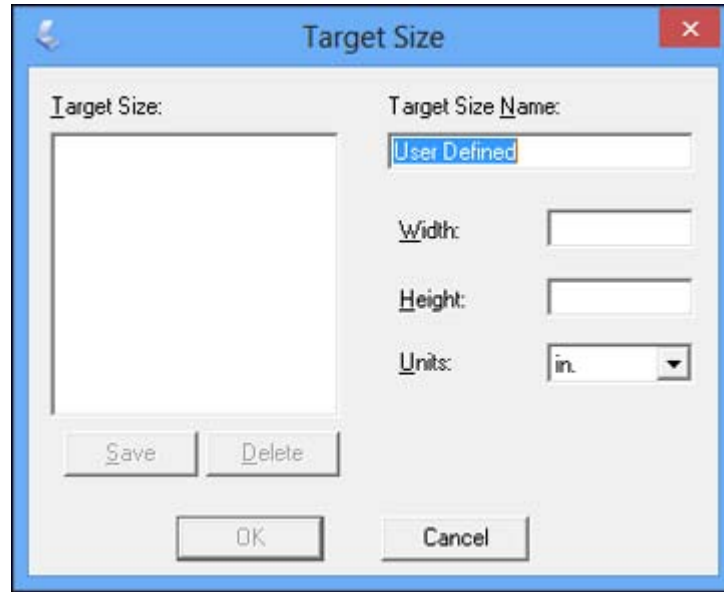

5. Name the custom size, enter the size, click **Save**, and click **OK**. Then create a scan area on the preview image.
The marquee is automatically proportioned for your custom scan size.
6. To use additional sizing tools, click the + (Windows) or ► (OS X) icon next to the Target Size setting and select options as desired.

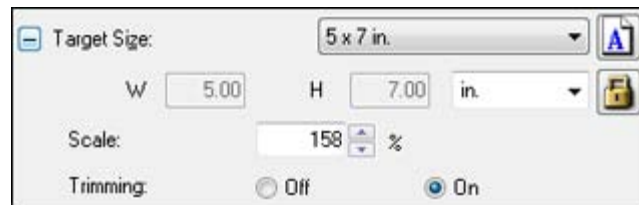

- **Scale:** Reduces or enlarges your image by the percentage you enter.

- **Trimming:** Turns automatic image cropping on or off.
-  Unlock icon: Unlocks the width/height proportions of the scanned image size so you can adjust it without constraint.

Parent topic: [Scanning in Professional Mode](#)

Image Preview Guidelines

You can preview your scanned image so you can adjust the scan settings using the preview as a guide. There are two types of preview available, depending on the scan mode and selected settings:

Thumbnail preview

A thumbnail preview displays your previewed images as thumbnails with the scanned image area and exposure automatically selected.

Normal preview

A normal preview displays your previewed images in their entirety so you can select the scanned image area and other settings manually.

Parent topic: [Selecting Epson Scan Settings](#)

Scan Resolution Guidelines

If you plan to enlarge a scanned image so you can print it at a larger size, you may need to increase the resolution from the default resolution set by Epson Scan. Follow these guidelines to determine the resolution setting you need:

- You will enlarge the image as you scan it.
If you will enlarge the image using Epson Scan's Target Size setting, you do not need to increase the Resolution setting.
- You will scan the image at its original size, but enlarge it later in an image-editing program.
Increase Epson Scan's Resolution setting in your scan. Increase the resolution by the same amount you will increase the image size to retain a high image quality. For example, if the resolution is 300 dpi (dots per inch) and you will double the image size later, change the Resolution setting to 600 dpi.
- You will scan the image at 100% or smaller size.
Select Epson Scan's Resolution setting based on how you will use the scanned image:
 - Email/view on a computer screen/post on the web: 96 to 150 dpi
 - Print/convert to editable text (OCR): 300 dpi
 - Fax: 200 dpi

Parent topic: [Selecting Epson Scan Settings](#)

Selecting Scan File Settings

You can select the location, name, and format of your scan file on the File Save Settings window. You can also select various optional settings that control how Epson Scan behaves when you scan and save files.

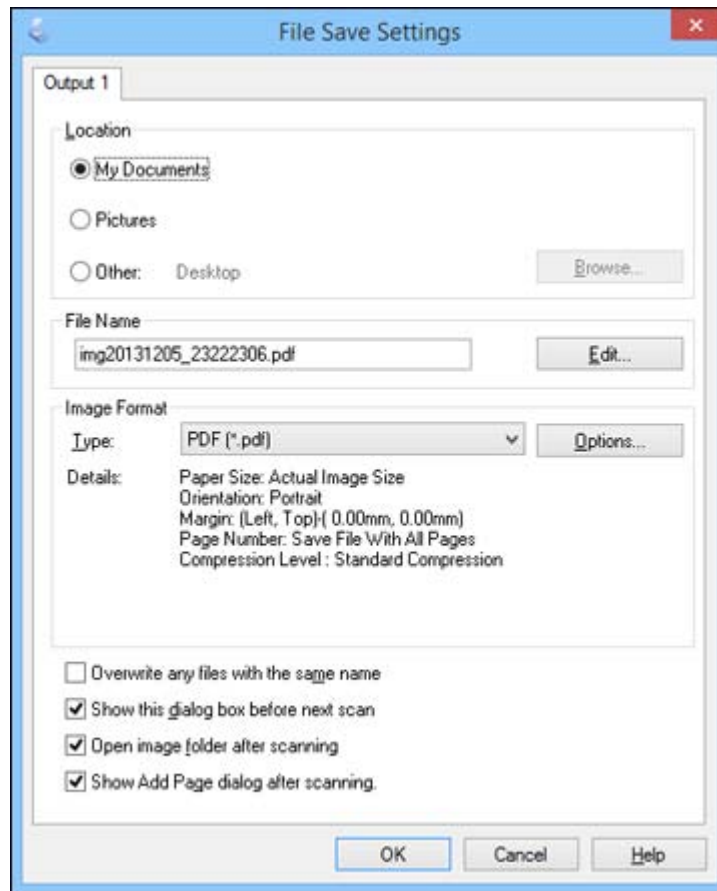

The File Save Settings window may appear after you click **Scan** on the Epson Scan window. You may also be able to access the window by clicking the  icon on the Epson Scan window.

1. Do one of the following to select the folder in which you want to save your scanned image:
 - Click the button for one of the displayed folders.
 - Click the **Other** button, click the **Browse** or **Choose** button, and select a folder.
2. If you want to change the default name for your scanned image, click **Edit** and select the options you want.
3. Select the file format you want to use in the Image Format **Type** menu.
4. If your file format provides optional settings, click the **Options** button to select them.
5. Choose any of the optional settings you want to use by selecting their checkboxes.
6. Click **OK**.

If you selected **PDF** or **Multi-TIFF** as the **Type** setting, you see this window after Epson Scan scans your document:

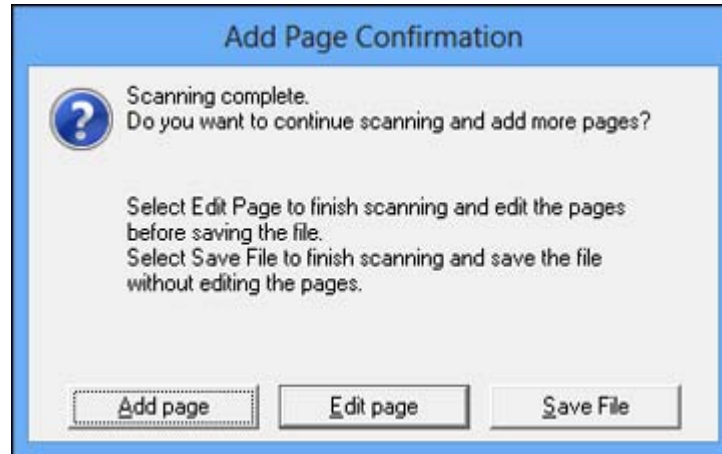

7. Choose one of the following options on the screen:
 - If you are scanning only one page, click **Save File**.
 - If you need to scan additional pages in a document, click **Add page**. Place additional pages on the product for scanning, click **Scan**, and repeat until you have scanned all the pages. When you are finished, click **Save File**.

- If you need to delete or reorder the scanned pages, click **Edit page**. Delete or reorder the pages using the icons that appear on the bottom of the editing window. When you are finished, click **OK**.

Note: If you installed an OCR (Optical Character Recognition) program, you may see a screen indicating the program is converting your page to text. Wait until the program re-scans the page and close the program, if necessary.

[Available Scanned File Types and Optional Settings](#)

Parent topic: [Selecting Epson Scan Settings](#)

Available Scanned File Types and Optional Settings

You can select from a variety of scanned file types and optional settings on the File Save Settings window in Epson Scan.

File Formats

Bitmap (*.bmp)

A standard image file format for most Windows programs.

JPEG (*.jpg)

An image format that lets you highly compress image data. However, the higher the compression, the lower the image quality. (The Tiff format is recommended when you need to modify or retouch your scanned image.)

Multi-TIFF (*.tif)

A Tiff file format when multiple pages are saved to the same file, allowing you to edit the images using a compatible program.

PDF (*.pdf)

A document format that is readable by Windows and OS X systems using Adobe Reader, Acrobat, or other programs. You can save multi-page documents in one PDF file.

PICT (*.pct)

A standard image file format for most OS X programs.

PRINT Image Matching II (*.jpg or *.tif)

File formats that include Epson PRINT Image Matching II data for enhanced quality and a wider color range (does not affect the way the image displays on the screen).

TIFF (*.tif)

A file format created for exchanging data between many programs, such as graphic and DTP software.

Optional Settings

Overwrite any files with the same name

Select to overwrite previous files with the same names.

Show this dialog box before next scan

Select to have the File Save Settings window appear automatically before you scan.

Open image folder after scanning

Select to have Windows Explorer or OS X Finder automatically open to the folder where your scanned image is saved after scanning.

Show Add Page dialog after scanning

If you are scanning a multi-page document using the PDF or Multi-Tiff format, select to display a prompt for scanning additional pages after the first page is scanned.

Parent topic: [Selecting Scan File Settings](#)

Scanning with OS X Using Image Capture

With OS X 10.6/10.7/10.8/10.9, you can scan with your product using an image-editing application such as Image Capture.

Note: With OS X 10.6, 10.7, 10.8, or 10.9, in addition to scanning with Image Capture, you can download and install Epson Scan scanning software. Epson Scan provides additional image adjustment and photo correction features for enhancing scanned images, and provides an interface for TWAIN-compliant OCR scanning software, such as ABBYY FineReader. To download Epson Scan, visit Epson's driver download site ([U.S. downloads](#) or [Canadian downloads](#)).

1. Open an image editing application, such as Image Capture.
2. Select your Epson product from the **DEVICES** or **SHARED** list, if necessary. (You may need to hover over the **DEVICES** or **SHARED** list, click **Show**, and select your product.)
3. If you see the **Show Details** button, click it.
If you are scanning an item on the scanner glass, your product begins a preview scan.

4. Select the **Scan Mode** setting indicating where you placed your original (if available). Select any other scan settings as necessary.

The image shows a scan settings dialog box with the following configuration:

- Scan Mode: Document Feeder
- Kind: Color
- Resolution: 300 dpi
- Size: US Letter
- Orientation: Portrait (indicated by the person icon)
- Duplex
- Scan To: Pictures
- Name: Scan
- Format: PDF
- Combine into single document
- Image Correction: None
- Unsharp Mask: None
- Descreening: None
- Backlight Correction: None
- Dust Removal: None
- Color Restoration
- Quiet Mode

Buttons at the bottom: Hide Details (left), Scan (right).

Note: If you are scanning a multi-page document in the ADF, you can have Image Capture combine all the pages into a single document. After all pages have been scanned, you see the message **No document loaded. . . .**

5. Select the folder in which you want to save your scanned file in the **Scan To** pop-up menu.
6. Click **Scan**.

Your scanned file is saved in the folder you selected.

[Available Scan Settings - OS X Image Capture](#)

Parent topic: [Scanning](#)

Related topics

[Placing Originals on the Product](#)

Available Scan Settings - OS X Image Capture

You can select these scan settings in your imaging editing application for OS X.

Image Correction

Provides a graphical interface for adjusting brightness, tint, temperature, and saturation.

Unsharp Mask

Makes the edges of certain image areas clearer. Turn off this option to leave softer edges.

Descreening

Removes the ripple pattern that might appear in subtly shaded image areas, such as skin tones. This option improves results when scanning magazines or newspapers. (The results of descreening do not appear in the preview image, only in your scanned image.)

Backlight Correction

Removes shadows from photos that have too much background light.

Dust Removal

Removes dust marks from your originals automatically.

Color Restoration

Restores the colors in faded photos automatically.

Quiet Mode

Reduces noise during scanning and may reduce scan speed.

Parent topic: [Scanning with OS X Using Image Capture](#)

Scanning Special Projects

Your product's scanning software offers various options to help you quickly complete special scan projects.

[Scanning to a SharePoint Server or Cloud Service](#)

[Scanning Multi-Page Originals as Separate Files](#)

Parent topic: [Scanning](#)

Scanning to a SharePoint Server or Cloud Service

You can use Document Capture Pro to upload scanned images to a SharePoint server or a cloud service.

1. Do one of the following to start Document Capture Pro:
 - **Windows 8.x:** Navigate to the **Apps** screen and select **Document Capture Pro**.
 - **Windows (other versions):** Click  or **Start**, and select **All Programs** or **Programs**. Select **EPSON Software**, then select **Document Capture Pro**.
 - **OS X:** Open the **Applications** folder, select the **Epson Software** folder, and select **Document Capture**. Select your product and click **OK**, if necessary.



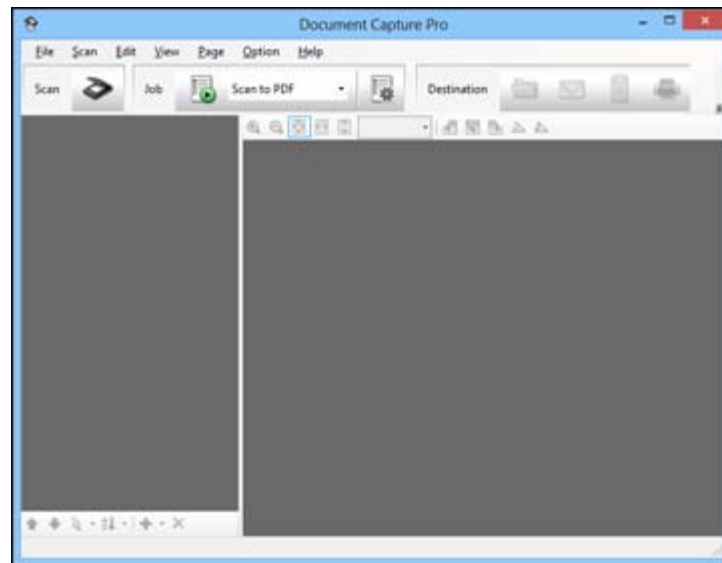

You see a window like this:



2. Click the  **Scan** icon.
3. Select any displayed scan settings you want to use.

Note: See the Help information in Document Capture Pro or Document Capture for details.

4. Click **Scan**.
You see a preview of your scan in the Document Capture Pro or Document Capture window.
5. Click one of the cloud service Destination icons to choose where to save your scanned file.

-  Web Folder (WebDAV)
-  Evernote (Windows only)
-  Google Drive
-  SugarSync
-  Microsoft SharePoint server (Windows only)

Note: You may need to click the arrow next to the icons in order to see all of them. The available icons may vary, depending on the software version you are using.

6. Select your Destination settings.

Note: The settings may vary, depending on the software version you are using. See the Help information in Document Capture Pro or Document Capture for details.

7. Select any other scan settings as necessary, and click **Send**.
Your originals are scanned and uploaded to the indicated server.

Note: You can also create a scan job for uploading scanned images to a SharePoint server or a cloud service. You can use the scan job when you scan with Document Capture Pro or Document Capture or when you scan using the Document Capture Pro option on the product control panel.

Parent topic: [Scanning Special Projects](#)

Scanning Multi-Page Originals as Separate Files

You can use Document Capture Pro (Windows only) to scan multi-page originals as separate scanned files. You indicate where you want the new scanned files to start by inserting a blank page or barcode between the pages of your original.

Note: The settings may vary, depending on the software version you are using. See the Help information in Document Capture Pro for details.

1. Load a multi-page original with blank pages or barcodes inserted where you want to start a new scanned file.
2. Do one of the following to start Document Capture Pro:
 - **Windows 8.x:** Navigate to the **Apps** screen and select **Document Capture Pro**.
 - **Windows (other versions):** Click  or **Start**, and select **All Programs** or **Programs**. Select **EPSON Software**, then select **Document Capture Pro**.

You see this window:

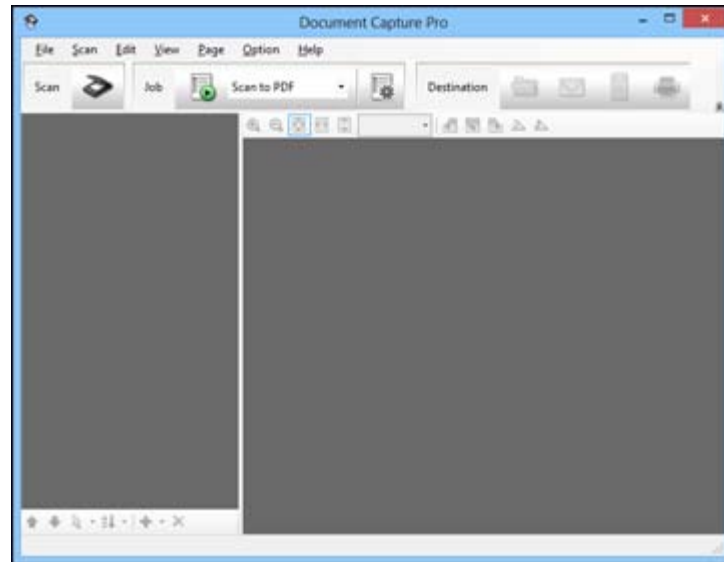

3. Click the  **Scan** icon.

4. Select any displayed scan settings you want to use.

Note: See the Help information in Document Capture Pro for details.

5. Click **Scan**.

You see a preview of your scan in the Document Capture Pro window.

6. Open the **File** menu and select **Batch Save**.
7. Click **File Name Settings**.
8. Select **Apply Job Separation** and click **Separation Settings**.
9. Select the method you used to separate the originals, select a folder name specification and click **OK**.
10. Select any other settings from the File Name settings window as necessary and click **OK**.
11. Select any other settings from the Batch Save window as necessary and click **OK**.

Your originals are saved into separate files as specified.

Note: You can also create a scan job for scanning multi-page originals as separate scanned files. You can use the scan job when you scan with Document Capture Pro or when you scan using the Document Capture Pro option on the product control panel.

Parent topic: [Scanning Special Projects](#)

Faxing

See these sections to fax using your product.

Note: This product allows you to store names, telephone numbers, and fax data in its memory even when the power is turned off. Make sure you restore all of the default settings if you give away or dispose of the product. This will erase all of your network settings and fax data.

[Connecting a Telephone or Answering Machine](#)

[Setting Up Fax Features](#)

[Setting Up Contacts and Contact Groups](#)

[Sending Faxes](#)

[Receiving Faxes](#)

[Checking Fax Status](#)

[Printing Fax Reports](#)

Connecting a Telephone or Answering Machine

You must connect your product to a telephone wall jack to send or receive faxes. If you want to use the same telephone line to receive calls, you can connect a telephone or answering machine to your product using an additional phone cable.

Note: If you do not connect a telephone to your product, make sure Receive Mode is set to **Auto**. Otherwise, you cannot receive faxes.

1. Connect a phone cable to your telephone wall jack and to the **LINE** port on your product.

Note: If you have a DSL or ISDN connection, you must connect the appropriate DSL filter, or ISDN terminal adapter or router to the wall jack to be able to use the line for faxing or voice calls using your product. Contact your DSL or ISDN provider for the necessary equipment.

DSL connection

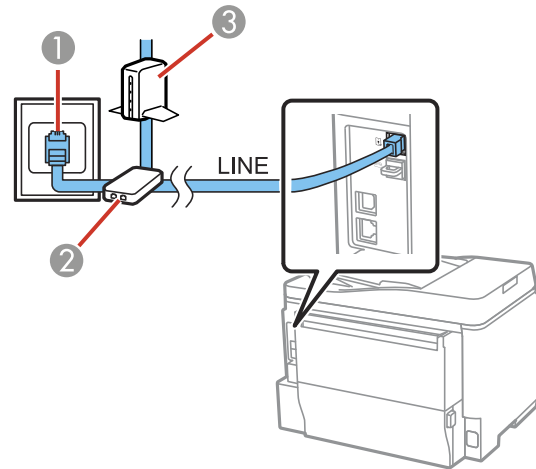

- 1 Telephone wall jack
- 2 DSL filter
- 3 DSL modem

ISDN connection (one phone number)

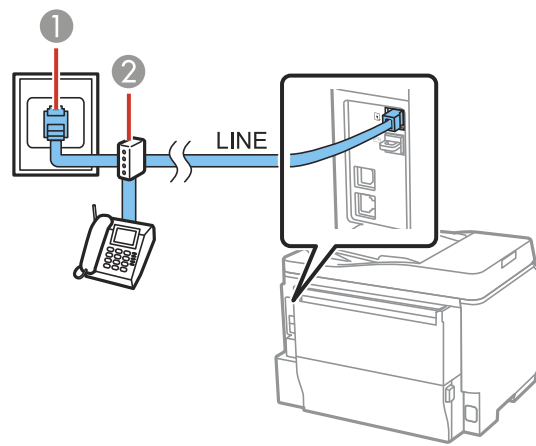

- 1 ISDN wall jack
- 2 Terminal adapter or ISDN router

ISDN connection (two phone numbers)

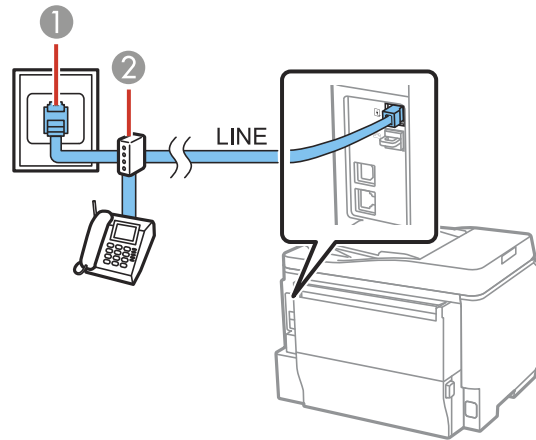

- 1 ISDN wall jack
- 2 Terminal adapter or ISDN router

2. If you are connecting a telephone or answering machine to your product using a second phone cable, remove the cap from the **EXT** port on your product.

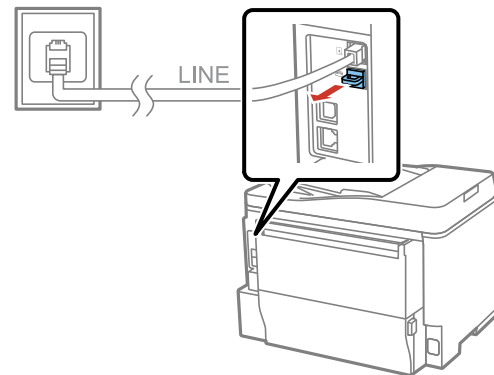

3. Connect a second phone cable to your telephone or answering machine and to the **EXT** port on your product.

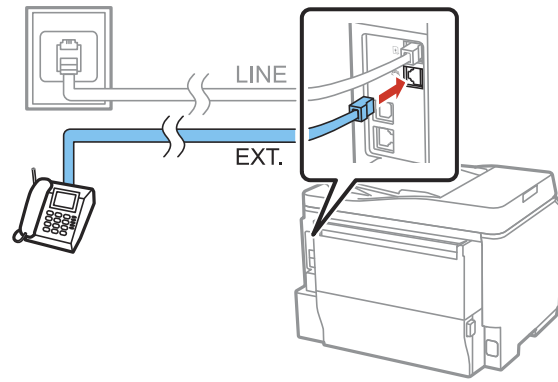

Note: If you connect an answering machine and Receive Mode is set to **Auto**, set the number of rings before your product answers a call to a number that is higher than your answering machine's setting for the number of rings.

Any phone or answering machine must be connected to the **EXT** port for your product to detect an incoming fax call when the phone is picked up. Epson cannot guarantee compatibility with VoIP, cable phone systems, or fiberoptic digital services such as FIOS.

Parent topic: [Faxing](#)

Related tasks

[Receiving Faxes Automatically](#)

Setting Up Fax Features

Before faxing with your product, set up your fax header and select the fax features you want to use.

Note: If you leave your product unplugged for a long period of time, you may need to reset the date and time settings for faxes.

[Setting Up Basic Fax Features](#)

[Selecting Advanced Fax Settings](#)

[Setting Up Fax Features Using the Fax Utility - Windows](#)

[Setting Up Fax Features Using the Fax Utility - OS X](#)

Parent topic: [Faxing](#)

Setting Up Basic Fax Features

See these sections to select the basic settings you need to use the product's fax features.

[Selecting Your Country or Region](#)

[Selecting the Date and Time](#)

[Using the Fax Setup Wizard](#)

[Selecting the Line Type](#)

[Setting the Number of Rings to Answer](#)

Parent topic: [Setting Up Fax Features](#)

Related tasks

[Setting Up Fax Features Using the Fax Utility - Windows](#)

[Setting Up Fax Features Using the Fax Utility - OS X](#)

Selecting Your Country or Region

Before faxing, select the country or region in which you are using your product.

Note: If you change the country or region, your fax settings return to their defaults and you must select them again. This setting can be locked by an administrator. If you can't access or change this setting, contact your administrator for assistance.

1. Press the  home button, if necessary.
2. Select **Setup**.

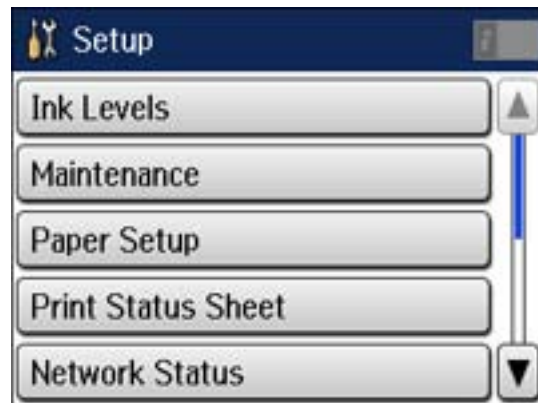

3. Scroll down and select **System Administration**. Enter the administrator password, if necessary.

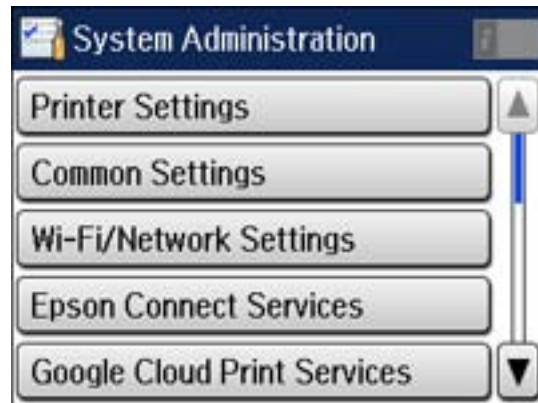

4. Select **Common Settings**.
5. Scroll down and select **Country/Region**.
6. Scroll up or down, if necessary, then select your country or region.
You see a confirmation screen.
7. If the setting is correct, select **Yes**. (If not, select **No** and retry.)

Note: Changing the country or region restores the fax settings to the default settings.

Parent topic: [Setting Up Basic Fax Features](#)

Selecting the Date and Time

Before faxing, select the current date, time, and daylight saving phase in your area, and choose your preferred date and time format.

Note: This setting can be locked by an administrator. If you can't access or change this setting, contact your administrator for assistance.

1. Press the  home button, if necessary.

2. Select **Setup**.



3. Scroll down and select **System Administration**. Enter the administrator password, if necessary.

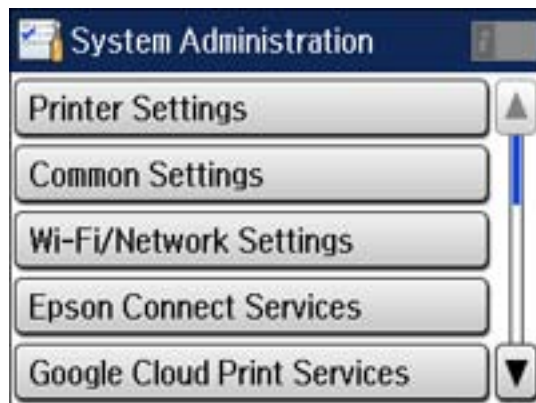

4. Select **Common Settings**.



5. Select **Date/Time Settings**.

You see a screen like this:



6. Select **Daylight Saving Time**.
7. Select the setting that applies to your area:
 - **Winter**: it is winter or your region does not use Daylight Saving Time (DST)

- **Summer:** it is spring or summer and your region uses Daylight Saving Time (DST)

Note: If your region uses Daylight Saving Time (DST), you must change this setting to match the season. When you change from **Winter** to **Summer**, your product automatically sets its clock ahead one hour. When you change from **Summer** to **Winter**, it sets its clock back one hour.

8. Select **Date/Time**.
9. Select the date format you want to use.
10. Use the numeric keypad to enter the current date.
11. Select the time format you want to use.
12. Use the numeric keypad to enter the current time.

Parent topic: [Setting Up Basic Fax Features](#)

Using the Fax Setup Wizard

You can setup the product's basic fax settings using the Fax Setting Wizard. This wizard is automatically displayed when the product is turned on for the first time. You can also change these settings individually from the Fax Settings menu.

Note: These settings can be locked by an administrator. If you can't access or change these setting, contact your administrator for assistance.

1. Press the  home button, if necessary.
2. Select **Setup**.

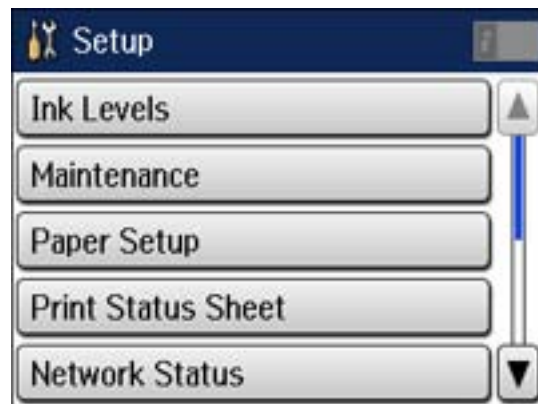

3. Scroll down and select **System Administration**. Enter the administrator password, if necessary.

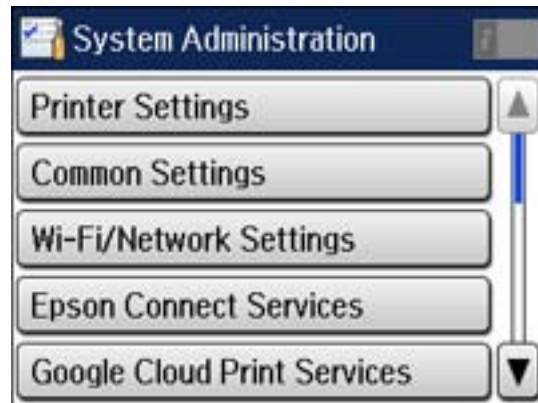

4. Scroll down and select **Fax Settings**.
5. Scroll down and select **Fax Setting Wizard**.
The Fax Setting Wizard screen appears.
6. Select **Start**.
7. On the Fax Header screen, use the displayed keypad to enter the sender name for your fax source, such as your name or a business name. You can enter up to 40 characters.
8. On the Your Phone Number screen, use the displayed keypad to enter your fax number, up to 20 characters.

Note: The name and phone number in the fax header identifies the source of the faxes you send.

9. On the Distinctive Ring Setting screen, do one of the following:
 - If you have subscribed to a distinctive ring service from your telephone company, select **Proceed**. Select the ring pattern to be used for incoming faxes or select **On**. Go to step 12.
 - If you do not have a distinctive ring service, select **Skip** and go to the next step.

Note: Distinctive ring services allows you to have several phone numbers on one phone line. Each number is assigned a different ring pattern. You can use one number for voice calls and another for fax calls. Select the ring pattern assigned to fax calls in the DRD Setting. If you select **On** or a ring pattern other than **All**, Receive Mode is automatically set to **Auto**.

10. On the Receive Mode Setting screen, do one of the following:
 - If you have connected an external telephone or answering machine to the product, select **Yes** and go to the next step.
 - If you did not connect an external telephone or answering machine, select **No** and go to step 12. (Receive Mode is automatically set to **Auto**; otherwise you cannot receive faxes.)
11. On the next Receive Mode Setting screen, select **Yes** to receive faxes automatically or select **No** to receive faxes manually.

Note: If you connect an external answering machine and select to receive faxes automatically, make sure the **Rings to Answer** setting is correct. If you select to receive faxes manually, you need to answer every call and operate the product's control panel or your phone to receive faxes.

12. On the Confirm Settings screen, confirm the displayed settings and select **Proceed**, or press **↩** back to change the settings.
13. On the Run Check Fax Connection screen, select **Start** and follow the on-screen instructions to check the fax connection and print a report of the check result. If there are any errors reported, try the solutions on the report and run the check again.

Note:

- If the Select Line Type screen appears, select the correct line type.
- If the Select Dial Tone Detection screen appears, select **Disable**. However, disabling the dial tone detection function may drop the first digit of a fax number and send the fax to the wrong number.

Parent topic: [Setting Up Basic Fax Features](#)

Related tasks

[Entering Characters on the LCD Screen](#)

Selecting the Line Type

If you connect the product to a PBX phone system or terminal adapter, you must change the product's line type. PBX (Private Branch Exchange) is used in office environments where an external access code such as "9" must be dialed to call an outside line. The default Line Type setting is PSTN (Public Switched Telephone Network), which is a standard home phone line.

Note: This setting can be locked by an administrator. If you can't access or change this setting, contact your administrator for assistance.

1. Press the  home button, if necessary.
2. Select **Setup**.

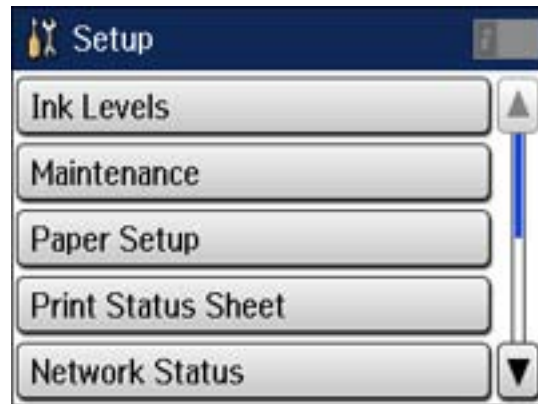

3. Scroll down and select **System Administration**. Enter the administrator password, if necessary.

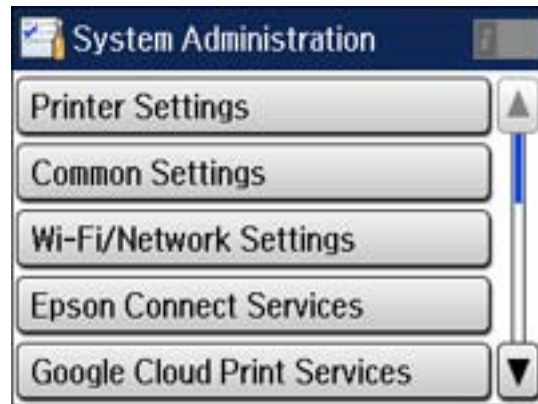

4. Scroll down and select **Fax Settings**.
5. Select **Basic Settings**.
6. Select **Line Type**.
7. Select **PBX**.

You see a screen like this:



8. Select **Use**.
9. Select **Access Code**.
10. Use the displayed keypad to enter the access code such as 9, and select **OK**.

Parent topic: [Setting Up Basic Fax Features](#)

Setting the Number of Rings to Answer

If you connect an external answering machine and select to receive faxes automatically, make sure the Rings to Answer setting is correct. The number of rings should be higher than the number of rings your answering machine is set to for answering a call.

Note: This setting can be locked by an administrator. If you can't access or change this setting, contact your administrator for assistance.

1. Press the  home button, if necessary.

2. Select **Setup**.

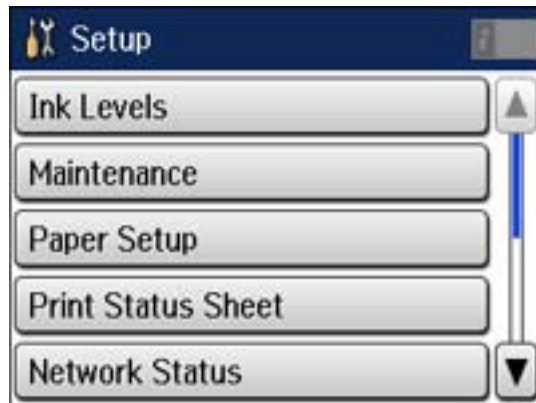

3. Scroll down and select **System Administration**. Enter the administrator password, if necessary.

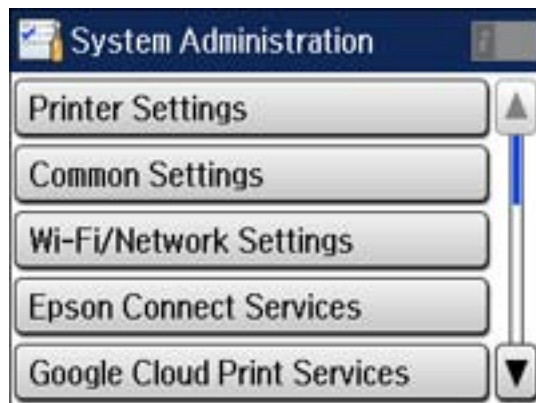

4. Scroll down and select **Fax Settings**.
5. Select **Receive Settings**.

6. Select **Rings to Answer**.



7. Select the number of rings, and select **OK**. Make sure to select a number higher than the number of rings your answering machine is set to for answering a call.

Note: An answering machine picks up every call faster than the product, but the product can detect fax tones and start receiving faxes. If you answer the phone and hear a fax tone, check that the product has started receiving the fax, then hang up the phone.

Parent topic: [Setting Up Basic Fax Features](#)

Selecting Advanced Fax Settings

You can select a variety of advanced fax settings.

Note: These settings can be locked by an administrator. If you can't access or change these setting, contact your administrator for assistance.

1. Press the  home button, if necessary.

2. Select **Setup**.



3. Scroll down and select **System Administration**. Enter the administrator password, if necessary.

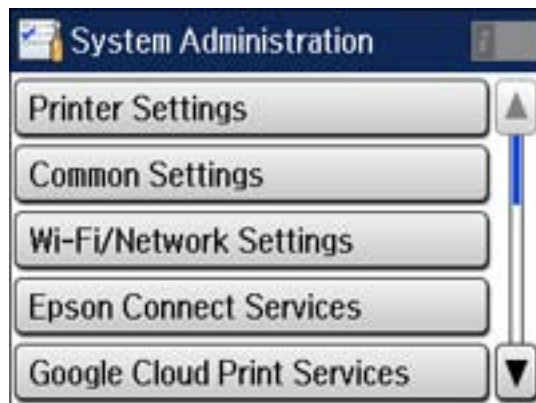

4. Scroll down and select **Fax Settings**.

You see a screen like this:



5. Select the group of settings you want to change.

[User Default Settings - Fax](#)

[Send Settings - Fax](#)

[Receive Settings - Fax](#)

[Output Settings - Fax](#)

[Basic Settings - Fax](#)

[Security Settings - Fax](#)

Parent topic: [Setting Up Fax Features](#)

Related topics

[Setting Up Basic Fax Features](#)

[Sending Faxes](#)

[Sending Faxes](#)

[Receiving Faxes](#)

User Default Settings - Fax

Set the default settings you want to use for faxing.

Setting	Options	Description
Resolution	Standard	Adjusts the scan resolution and print quality of outgoing faxes.
	Fine	
	Super Fine	
	Ultra Fine	
	Photo	
Density	Auto	Automatically adjusts the darkness of outgoing faxes. Select this option when sending black-and-white text documents.
	Manual	Lets you select from various density levels.
Document Size (Glass)	Half Letter	Sets the size for a document placed on the scanner glass.
	A5	
	Letter	
	A4	
ADF 2-Sided	Off	Select On to enable 2-sided faxing from the ADF. The Direct Send option and color faxing are disabled when you turn on this setting.
	On	
Direct Send	Off	Select On to send black-and-white faxes to a single recipient as soon as the connection is made, without saving the scanned image to memory. You cannot use this setting when sending a color fax or sending a fax to multiple recipients.
	On	
Continuous Scan from ADF	Off	Select On to have the product to ask if you want to scan another page after a document in the ADF has finished scanning.
	On	
Transmission Report	Print on Error	Lets you select when to print transmission reports.
	Print	
	Do Not Print	

Parent topic: [Selecting Advanced Fax Settings](#)

Send Settings - Fax

Set the send options you want to use for outgoing faxes.

Setting	Options	Description
Batch Send	Off	Sorts outgoing faxes by recipient in the product's memory, and then sends them as a batch.
	On	
Save Failure Data	Off	Saves faxes that failed to be sent in the product's memory. You can resend the faxes from the product's Status Menu.
	On	

Parent topic: [Selecting Advanced Fax Settings](#)

Receive Settings - Fax

Set the receive options you want to use for incoming faxes.

Setting	Options	Description
Receive Mode	Manual	Lets you confirm whether an incoming fax should be printed; a telephone must be connected to the product
	Auto	Automatically receives and prints faxes.
Distinctive Ring	All	If you are using a Distinctive Ring Service on your phone line, your telephone company can assign two or more phone numbers to the same line and assign different ring patterns to each. If you use this service, select the number of rings for your fax number so your product can receive faxes on the correct number of rings. Select All for phones lines that do not use this service.
	Single	
	Double	
	Triple	
Double&Triple		
Rings to Answer	1 to 9	Sets the number of rings before your product receives a fax. If Receive Mode is set to Auto and an answering machine is connected to the product, make sure this setting is set higher than the number of rings your answering machine is set to answer a call.

Setting	Options	Description
Remote Receive	Off	Lets you start receiving faxes using your phone instead of operating the product (if the Receive Mode is set to Auto). When you select On , you must also set a Start Code . If you are using a cordless handset with its base connected to the product, you can start receiving the fax by entering the code using the handset.
	On	
	Start Code	

Parent topic: [Selecting Advanced Fax Settings](#)

Output Settings - Fax

Set the output options you want to use for incoming faxes.

Note: If you select **Save to Inbox**, faxes are saved in the product's memory. Delete faxes after viewing or printing to prevent the memory from filling up. Even if you select other options for saving faxes, they may be saved temporarily in the product's memory.

Setting	Options	Description
Fax Output	Other Settings	Lets you create a folder for saving faxes on a memory device and select settings for forwarding faxes.
	Save to Inbox	Saves incoming faxes in the product's memory. You can view the faxes on the LCD screen and print if needed.
	Save to Computer	To use this option, you must use the Epson FAX Utility. Select Yes and Print to have faxes saved to your computer and printed automatically.
	Save to Memory Device	Saves incoming faxes to a connected memory device or USB storage device. Select Yes and Print to have faxes saved to the memory device and printed automatically. Note: Received faxes are saved as PDF files and cannot be printed directly from the control panel.
	Forward	Forwards incoming faxes to as many as 5 numbers in your contact list. Select Yes and Print to have faxes forwarded and printed automatically. Note: Color faxes cannot be forwarded.
Auto Reduction	On	Select to reduce the size of large received faxes to fit on the paper size in the selected paper source.
	Off	Select to print large incoming faxes at their original size on multiple sheets, if necessary.
Auto Rotation	On	If you have loaded A5-size paper, select On to rotate landscape-oriented incoming faxes so that they print correctly on the paper.
	Off	
Collation Stack	On	Select On to print incoming faxes so that the pages are stacked in the correct page order. (When the product is low on memory, this option may not be available.)
	Off	

Setting	Options	Description
Print Suspend Time	Off	Select On to set a time period to stop automatic printing of faxes or reports and save received faxes in the product's memory. (Make sure there is enough free memory before using this function.)
	On	
	Time to Stop	
	Restart Time	
Forwarding Report	Print on Error	Selects whether or when to print a report after an incoming fax is forwarded.
	Print	
	Do Not Print	
Attach Image to Report	Off	Does not include an image of the fax on transmission reports.
	On(Small Image)	Prints transmission reports with an image of the first faxed page. (Does not work when you select Direct Send .)
	On(Large Image)	
Fax Log Auto Print	Off	Does not print the fax log.
	On(Every 30)	Prints the fax log after 30 faxes are sent or received.
	On(Time)	Prints the fax log at a time you select using the numeric keypad displayed on the LCD screen.
Report Format	Simple	Selects the amount of information on fax reports.
	Detail	

Parent topic: [Selecting Advanced Fax Settings](#)

Basic Settings - Fax

Set the basic options you want to use for incoming and outgoing faxes.

Setting	Options	Description
Fax Speed	Fast(33,600bps)	Sets the speed at which you send and receive faxes.
	Medium(14,400bps)	
	Slow(9,600bps)	

Setting	Options	Description
ECM	On	Turns on Error Correction Mode (ECM) to automatically correct errors in sent or received fax data.
	Off	Turns off Error Correction Mode (ECM); color faxes cannot be sent or received.
Dial Tone Detection	On	Automatically dials the number you enter for faxing when the product detects a dial tone.
	Off	Turns off automatic dial tone detection, which may be necessary if the product is connected to a PBX (Private Branch Exchange) or a TA (Terminal Adapter). However, turning this setting off may cause the product to drop the first digit of a fax number.
Line Type	PSTN	Selects a standard phone line (Public Switched Telephone Network).
	PBX	Selects Private Branch Exchange, the type of phone line used in office environments where an access code such as 9 must be used to call an outside line.
Header	Fax Header	Select to enter the header information and your phone number for inclusion on outgoing faxes.
	Your Phone Number	

Parent topic: [Selecting Advanced Fax Settings](#)

Security Settings - Fax

Set the security options you want to use for fax data.

Setting	Options	Description
Direct Dialing Restrictions	Off	Does not restrict dialed fax numbers.
	On	Allows faxing only to numbers stored in the contacts list or history.
	Enter Twice	Requires you to enter fax numbers twice to prevent errors.

Setting	Options	Description
Confirm Address List	Off	Selects whether or not to display a recipient confirmation screen before a fax is sent.
	On	
Inbox Password Settings	Register	Select to set a password for viewing incoming faxes.
Backup Data Auto Clear	Off	Automatically erases sent or received fax data from your product's memory.
	On	
Clear Backup Data	—	Deletes all sent or received fax data remaining in your product's memory; run this function if you are giving away or disposing of your product.

Parent topic: [Selecting Advanced Fax Settings](#)

Setting Up Fax Features Using the Fax Utility - Windows

You can set up your fax header and select your fax settings using the FAX Utility for Windows.

1. Do one of the following:
 - **Windows 8.x:** Navigate to the **Apps** screen.
 - **Windows (other versions):** Click  or **Start > Programs** or **All Programs > EPSON Software**.
2. Select **FAX Utility**.

You see this window:



3. Select **Fax Settings for Printer**. (Select your product, if prompted.)

You see this window:



4. Select **Fax Settings**.
5. Follow the prompts that appear on the screen to enter your fax header information and select your fax settings.

Note: For detailed information, select the FAX Utility **Help** option.

Parent topic: [Setting Up Fax Features](#)

Related topics

[Setting Up Fax Features](#)

Setting Up Fax Features Using the Fax Utility - OS X

You can set up your fax header and select your fax settings using the FAX Utility for OS X.

1. Do one of the following:
 - **OS X 10.6/10.7/10.8/10.9:** In the Apple menu or the Dock, select **System Preferences**. Select **Print & Fax**, **Print & Scan**, or **Printers & Scanners**, select the **FAX** option for your product, and select **Options & Supplies**. Select **Utility** and select **Open Printer Utility**.
 - **OS X 10.5:** In the Apple menu or the Dock, select **System Preferences**. Select **Print & Fax**, select the **FAX** option for your product, and select **Open Print Queue**. Select **Utility**.
2. Double-click **FAX Utility**, if necessary.

You see this window:



3. Select your **FAX** product in the Printer list.
4. Select **Fax Settings**.
5. Follow the prompts that appear on the screen to enter your fax header information and select your fax settings.

Note: For detailed information, select the FAX Utility ? icon.

Parent topic: [Setting Up Fax Features](#)

Related topics

[Setting Up Fax Features](#)

Setting Up Contacts and Contact Groups

You can set up a list of contacts and their fax numbers so you can quickly select them for faxing. You can also set up contact groups to send a fax message to multiple contacts.

[Setting Up Contacts Using the Product Control Panel](#)

[Setting Up Speed/Group Dial Lists Using the Fax Utility - Windows](#)

[Setting Up Speed/Group Dial Lists Using the Fax Utility - OS X](#)

Parent topic: [Faxing](#)

Setting Up Contacts Using the Product Control Panel

You can set up your contacts and contact groups using the control panel on your product.

Note: Contacts can be locked by an administrator. If you cannot access or change contacts, contact your administrator for assistance.

[Creating a Contact](#)

[Editing or Deleting a Contact](#)

[Creating a Contact Group](#)

[Editing or Deleting a Contact Group](#)

Parent topic: [Setting Up Contacts and Contact Groups](#)

Related tasks

[Setting Up Speed/Group Dial Lists Using the Fax Utility - Windows](#)

[Setting Up Speed/Group Dial Lists Using the Fax Utility - OS X](#)

Creating a Contact

You can create a list of contacts to save frequently used fax numbers.

Note: You can create up to 100 contacts and contact groups combined.

1. Press the  home button, if necessary.
2. Select **Fax**.

You see a screen like this:



3. Select **Contacts**. Enter the administrator password, if necessary.

You see a screen like this:



4. Select **Menu**.

You see a screen like this:





Note: You can print your list of contacts and groups if necessary.

5. Select **Add Entry**.
6. Select the number you want to use for the contact you are adding.

You see a screen like this:



7. Select the **Name** field, use the displayed keyboard to enter the contact name (up to 30 characters), and press .

8. Select the **Index Word** field, use the displayed keyboard to enter a word to use when searching for an entry (up to 30 characters), and press . (This field is optional.)
9. Select the **Fax Number** field, and use the numeric keypad on the LCD screen or the buttons on the product to enter the fax number. You can enter up to 64 characters.

Note: If necessary, enter an outside line access code (such as **9**) at the beginning of the fax number. If the access code has been set up in the **Line Type** setting, enter the **#** pound sign instead of the code.

10. Set the **Fax Speed**, if necessary.
11. Select **Save**.

Parent topic: [Setting Up Contacts Using the Product Control Panel](#)

Editing or Deleting a Contact

You can edit or delete any of the contacts on your list.

1. Press the  home button, if necessary.
2. Select **Fax**.

You see a screen like this:



3. Select **Contacts**. Enter the administrator password, if necessary.
4. Select the contact you want to edit or delete.

You see a screen like this:



5. Do one of the following:
 - To delete the contact, select **Delete** and select **Yes** on the confirmation screen.
 - To edit the contact, select **Edit**, select the item you want to change, enter the correct information, and select . When you are finished editing, select **Save**.

Parent topic: [Setting Up Contacts Using the Product Control Panel](#)

Creating a Contact Group

You can create a group of contacts so that you can easily send faxes to multiple recipients.

Note: You can create up to 100 contacts and contact groups combined.

1. Press the  home button, if necessary.
2. Select **Fax**.

You see a screen like this:



3. Select **Contacts**. Enter the administrator password, if necessary.
4. Select **Menu**.

You see a screen like this:





Note: You can print your list of contacts and groups if necessary.

5. Select **Add Group**.
6. Select the number you want to use for the group you are adding.

You see a screen like this:



The screenshot shows a dialog box titled "Add Group". It has a title bar with a home icon on the left and a question mark icon on the right. Below the title bar, there are two text input fields. The first field is labeled "Name" and contains the text "Not Entered". The second field is labeled "Index Word" and also contains the text "Not Entered". At the bottom of the dialog, there are two buttons: "Cancel" on the left and "Proceed" on the right.

7. Select the **Name** field, use the displayed keyboard to enter the group name (up to 30 characters), and press .
8. Select the **Index Word** field, use the displayed keyboard to enter a word to use when searching for a group (up to 30 characters), and press . (This field is optional.)
9. Select **Proceed**.
You see your contacts list.
10. Select the number next to each contact you want to include in your group.
A check mark appears next to each selected contact.
11. Select **Save**.

Parent topic: [Setting Up Contacts Using the Product Control Panel](#)

Editing or Deleting a Contact Group

You can edit an existing contact group to add or delete entries. You can also delete the entire contact group.

1. Press the  home button, if necessary.
2. Select **Fax**.

You see a screen like this:



3. Select **Contacts**. Enter the administrator password, if necessary.

You see a screen like this, showing both individual contacts and contact groups:



4. Select the group you want to edit.

You see a screen like this:

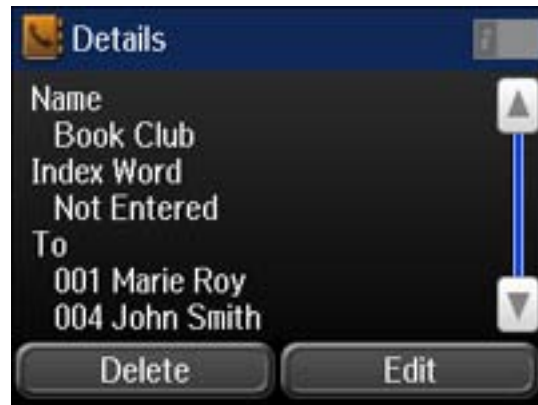

Note: If you want to delete the entire group, select **Delete**.

5. To edit the group, select **Edit**.
6. Select **Proceed**.
You see a list of the contacts in your group.
7. To add or delete a contact, select the number next to it.
8. Select **Save**.

Parent topic: [Setting Up Contacts Using the Product Control Panel](#)

Setting Up Speed/Group Dial Lists Using the Fax Utility - Windows

You can set up your speed dial and group dial lists using the FAX Utility for Windows. The utility also lets you import fax numbers from the Windows Address Book and back up fax numbers stored in your product's memory.

Note: You can create up to 60 speed dial and group dial entries combined.

1. Do one of the following:
 - **Windows 8.x:** Navigate to the **Apps** screen.
 - **Windows (other versions):** Click  or **Start > Programs** or **All Programs > EPSON Software**.

2. Select **FAX Utility**.
You see this window:



3. Select **Fax Settings for Printer**. (Select your product, if prompted.)

You see this window:

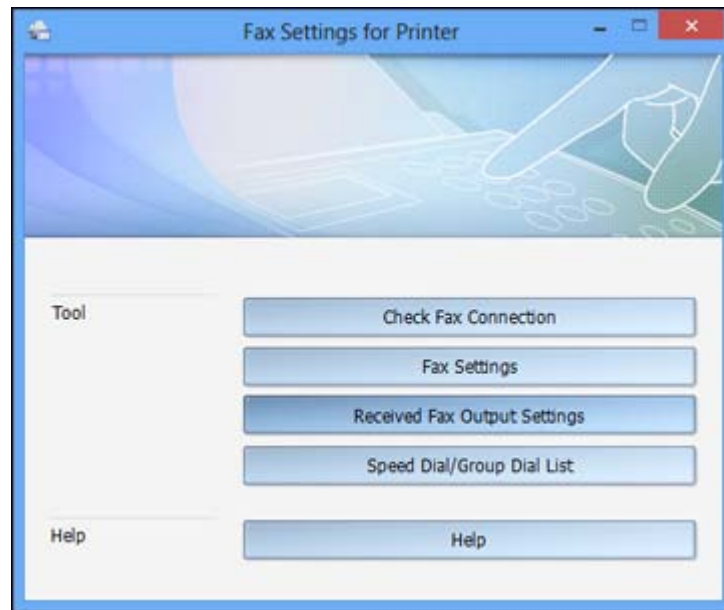

4. Select **Speed Dial/Group Dial List**.

You see this window:

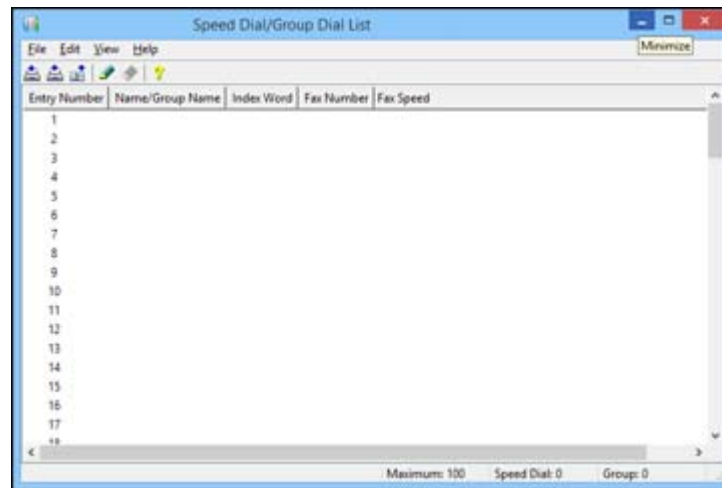

5. Select an empty entry and click the  icon.

Note: To edit an entry, select it and click the  icon. To delete an entry, select it and click the  icon.

6. Do one of the following:
 - To create a speed dial entry, select **Speed Dial**, enter a name and fax number, and click **OK**.
 - To create a group dial entry, select **Group**, enter a name, select your desired fax numbers, and click **OK**.
7. Repeat the previous steps as necessary to add all your speed dial or group dial entries.
8. When you are finished, click the  icon to save the entries to your product's memory.

Parent topic: [Setting Up Contacts and Contact Groups](#)

Related topics

[Setting Up Contacts Using the Product Control Panel](#)

Setting Up Speed/Group Dial Lists Using the Fax Utility - OS X

You can set up your speed dial and group dial lists using the FAX Utility. The utility also lets you import fax numbers from the MacAddress Book and back up fax numbers to your product's memory.

Note: You can create up to 60 speed dial and group dial entries combined.

1. Do one of the following:
 - **OS X 10.6/10.7/10.8/10.9:** In the Apple menu or the Dock, select **System Preferences**. Select **Print & Fax**, **Print & Scan**, or **Printers & Scanners**, select the **FAX** option for your product, and select **Options & Supplies**. Select **Utility** and select **Open Printer Utility**.
 - **OS X 10.5:** In the Apple menu or the Dock, select **System Preferences**. Select **Print & Fax**, select the **FAX** option for your product, and select **Open Print Queue**. Select **Utility**.
2. Double-click **FAX Utility**, if necessary.

You see this window:



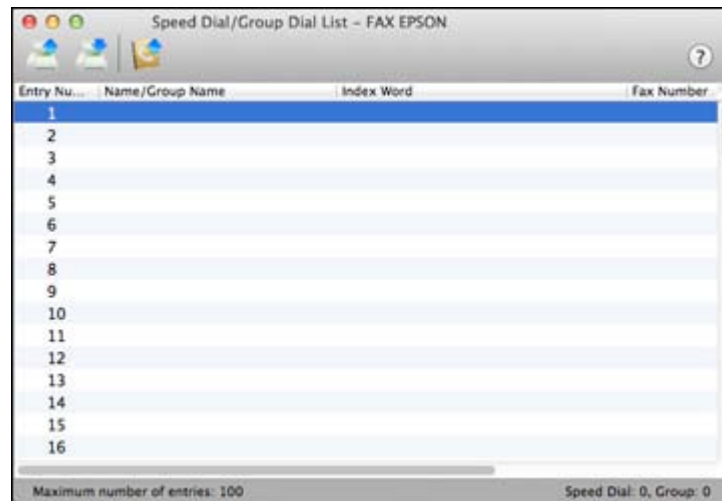

3. Select your **FAX** product in the Printer list.
4. Select **Speed Dial/Group Dial List**.

You see this window:



5. To add an entry, double-click an empty entry.

Note: To edit an entry, select it and change the information. To delete an entry, select it and press the **Delete** key on your keyboard.

6. Do one of the following:
 - To create a speed dial entry, select **Speed Dial**, enter a name and fax number, and click **OK**.
 - To create a group dial entry, select **Group Dial**, enter a name, select your desired fax numbers, and click **OK**.
7. Repeat the previous steps as necessary to add all your speed dial or group dial entries.
8. To import entries from your MacAddress book, click the  icon.
9. When you are finished, click the  icon to save the entries to your product's memory.

Parent topic: [Setting Up Contacts and Contact Groups](#)

Related topics

[Setting Up Contacts Using the Product Control Panel](#)

Sending Faxes

See these sections to send faxes using your product.

[Sending Faxes from the Product Control Panel](#)

[Sending Faxes Using the Fax Utility - Windows](#)

[Sending Faxes Using the Fax Utility - OS X](#)

Parent topic: [Faxing](#)

Sending Faxes from the Product Control Panel

See these sections to send faxes using the product's control panel.

[Sending a Fax Using the Keypad, Contact List, or History](#)

[Fax Sending Options](#)

[Sending a Fax at a Specified Time](#)

[Sending a Fax on Demand](#)

[Sending a Stored Fax](#)

[Dialing Fax Numbers from a Connected Telephone](#)

Parent topic: [Sending Faxes](#)

Related tasks

[Selecting the Line Type](#)

[Using Presets](#)

Related topics

[Setting Up Contacts Using the Product Control Panel](#)

[Placing Originals on the Product](#)

Sending a Fax Using the Keypad, Contact List, or History

You can send a fax from your product control panel by entering the fax number, or selecting the number from either the contact list or fax history.

Note: You can send a black-and-white fax to up to 200 recipients at a time, or send a color fax to one recipient at a time. If your recipient's fax machine does not print in color, your fax is automatically sent in black-and-white.

Note: The product can queue up to 50 black-and-white fax jobs. You can check or cancel fax jobs in the queue using the Status Menu.

1. Place your original on the product for faxing.
2. Press the **Home** button, if necessary.
3. Select **Fax**.



Note: To fax a double-sided document, place your document in the ADF and turn on the **ADF 2-Sided** setting. (You cannot fax double-sided documents in color.)

4. Do one of the following to select fax recipients:
 - **Manually enter a fax number:** Press the **Enter a Fax Number** field and enter a fax number. Press **Enter** when done. To add another fax number, repeat the same steps. You can also use the numeric keypad on the control panel to enter a fax number.

Note: If direct dialing has been restricted, you can only select the number from the contact list or fax history. If necessary, enter an outside line access code (such as 9) at the beginning of the fax number. If the access code has been set up in the **Line Type** setting, enter the # pound sign instead of the code.
 - **Select from the contact list:** Select **Contacts** to display the contact list screen. Select the checkbox next to one or more contact (select the checkbox again to deselect it). You can also select the **Search** field to search for recipients by name, index name, or entry number. Select **Proceed** when you are finished.

- **Select from the sent fax history:** Select **History** to display the sent fax history. Select a recipient from the list, select **Menu**, and select **Send to this number**.

Note: To delete entered recipients, select the **Enter a Fax Number** field, select the recipient you want to delete, and select **Delete from the List**.

5. If you need to change any fax settings, select **Menu**, select **Fax Send Settings**, and select your settings.
6. If you want to preview your fax in black-and-white on the LCD, select **Preview**. (If the preview looks incorrect, select **Retry**, reposition the document or change the fax settings, and repeat this step.)

Note: If you do not touch the preview screen for 20 seconds, your product sends the fax automatically. You cannot preview images when the Direct Send setting is turned on.

7. If you want to save your fax settings for later use, select **Presets** and add a new entry.
8. Press one of the \diamond buttons.

Note: To cancel faxing, press the ⏏ **Stop** button. You can also cancel the job or check the job status from the Status Menu.

Your product scans your original and prompts you to place additional pages, if necessary.

After scanning your originals, your product dials the number and sends the fax.

Note: Your product does not save sent color faxes to its memory. If the Save Failure Data option is enabled, faxes that failed to be sent are stored to the product's memory and you can resend them from the Status Menu screen.

Parent topic: [Sending Faxes from the Product Control Panel](#)

Fax Sending Options

While sending a fax, you can select **Menu** and select these options from the Fax Send Settings menu.

Note: You can also select these options in the User Default Settings menu.

Setting	Options	Description
Resolution	Standard	Adjusts the scan resolution and print quality of outgoing faxes.
	Fine	
	Super Fine	
	Ultra Fine	
	Photo	
Density	Auto	Automatically adjusts the darkness of outgoing faxes. Select this option when sending black-and-white text documents.
	Manual	Lets you select from various density levels.
Document Size (Glass)	Half Letter	Sets the size for a document placed on the scanner glass.
	A5	
	Letter	
	A4	
ADF 2-Sided	Off	Select On to enable 2-sided faxing from the ADF. The Direct Send option and color faxing are disabled when you turn on this setting.
	On	
Direct Send	Off	Select On to send black-and-white faxes to a single recipient as soon as the connection is made, without saving the scanned image to memory. You cannot use this setting when sending a color fax or sending a fax to multiple recipients.
	On	
Priority Send	Off	Select On to send the current fax before other faxes waiting to be sent.
	On	
Continuous Scan from ADF	Off	Select On to have the product to ask if you want to scan another page after a document in the ADF has finished scanning.
	On	
Transmission Report	Print on Error	Lets you select when to print transmission reports.
	Print	
	Do Not Print	

Parent topic: [Sending Faxes from the Product Control Panel](#)

Sending a Fax at a Specified Time

You can send a fax at a time of your choice.

Note: Make sure the product's date and time settings are correct. You can only send faxes in black-and-white when you use this option.

1. Place your original on the product for faxing.
2. Press the  home button, if necessary.
3. Select **Fax**.



Note: To fax a double-sided document, place your document in the ADF and turn on the **ADF 2-Sided** setting.

4. Enter a fax number or select a number from the Contacts list or History.
5. Select **Menu**.
6. Select **Send Fax Later**.
7. Select **On**.
8. Select **Time**, use the displayed keypad on the LCD screen to enter your desired time, and select **OK**.

9. Press one of the  buttons.

Note: To cancel faxing, press the  **Stop** button.

After scanning your originals, your product dials the number and sends the fax at the specified time.

Note: If the product is turned off at the specified time, the fax is sent when it is powered on.

Parent topic: [Sending Faxes from the Product Control Panel](#)

Related references

[Fax Sending Options](#)

Related topics

[Placing Originals on the Product](#)

[Setting Up Contacts and Contact Groups](#)

Sending a Fax on Demand

You can store one scanned document (up to 100 black-and-white pages) and have it sent automatically when another fax machine requests it. Other fax users can receive the document by calling your fax number and using the polling receive function on their fax machines.

1. Place your original on the product for faxing.
2. Press the  home button, if necessary.
3. Select **Fax**.



4. Select **Menu**.
5. Select **Polling Send** and select **On**.
6. If you need to change any fax settings, select **Menu**, select **Fax Send Settings**, and select your settings.
7. Press the **B&W** button.

Your document is scanned and stored until you overwrite or delete it.

You can store only one document at a time. Subsequent documents overwrite the existing document. You can also delete a stored document from the Status Menu.

Parent topic: [Sending Faxes from the Product Control Panel](#)

Related references

[Fax Sending Options](#)

Related topics

[Placing Originals on the Product](#)

Sending a Stored Fax

You can store one black-and-white scanned document (up to 100 pages) and send it whenever necessary.

1. Place your original on the product for faxing.
2. Press the **home** button, if necessary.
3. Select **Fax**.



4. Select **Menu**.
5. Select **Store Fax Data** and select **On**.
6. If you need to change any fax settings, select **Menu**, select **Fax Send Settings**, and select your settings.
7. Press the **B&W** button.
Your document is scanned, stored, and briefly previewed.
8. When you are ready to send the document, press the **i Status** button.
You see a screen like this:



9. Select **Job Monitor**.
10. Select **Communication Job**.
11. Select the stored fax job you want to send.
12. Select **Send/View** and select **Send**.

You can store only one document at a time. Subsequent documents overwrite the existing document. You can also delete a stored document from the Status Menu.

Parent topic: [Sending Faxes from the Product Control Panel](#)

Related references

[Fax Sending Options](#)

Related topics

[Placing Originals on the Product](#)

Dialing Fax Numbers from a Connected Telephone

If you have connected a telephone to the **EXT** port on your product, you can send a fax by dialing the fax number from the connected telephone. If the recipient's phone number and fax number are the same, you can speak to the recipient before sending the fax.

1. Place your original on the product for faxing.
2. Press the  home button, if necessary.
3. Dial the fax number from the connected telephone. Speak to the recipient if necessary.
4. Select **Start Fax** on the LCD screen.
5. Select **Send**.

Note: Your product now communicates with the recipient's fax machine. Do not hang up the telephone.

6. When you hear a fax tone, press one of the  buttons to start sending the fax.

Note: If your recipient's fax machine does not print in color, your fax is automatically sent in black-and-white.

7. Hang up the telephone.

Parent topic: [Sending Faxes from the Product Control Panel](#)

Related references

[Fax Sending Options](#)

Related topics

[Placing Originals on the Product](#)

Sending Faxes Using the Fax Utility - Windows

You can send a fax from a printing program in Windows. You can fax up to 100 pages at a time, including a cover sheet.

1. Open the file you want to fax and select the print command.

You see a window like this:

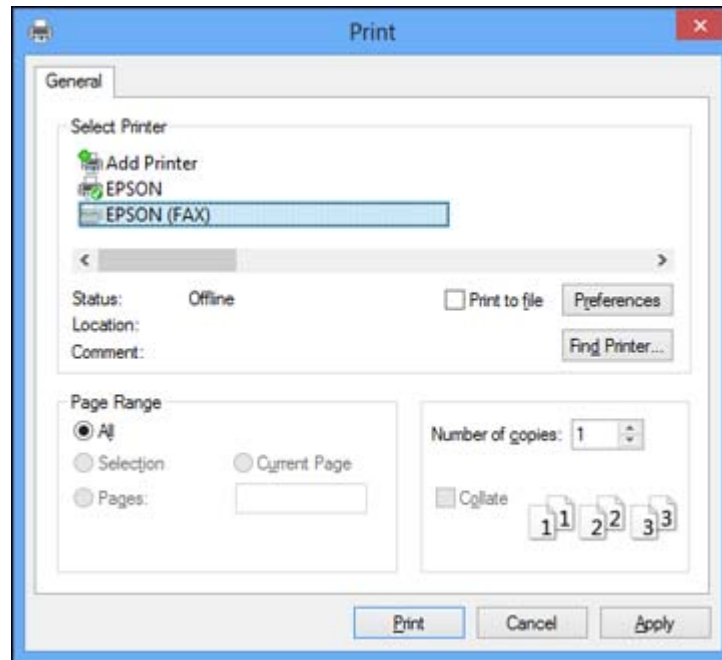

2. Select your product with the **FAX** option as the printer.
3. To change the Paper Size, Orientation, Color, Image Quality, or Character Density settings, click the **Preferences** or **Properties** button.

Note: If you see a **Setup**, **Printer**, or **Options** button, click it. Then click **Preferences** or **Properties** on the next screen. For more information about selecting fax print settings, click **Help**.

4. Select the Page Range as necessary. (Leave the Number of copies set to 1.)
5. Click **Print**.

If you're faxing for the first time, you see a window like this one:

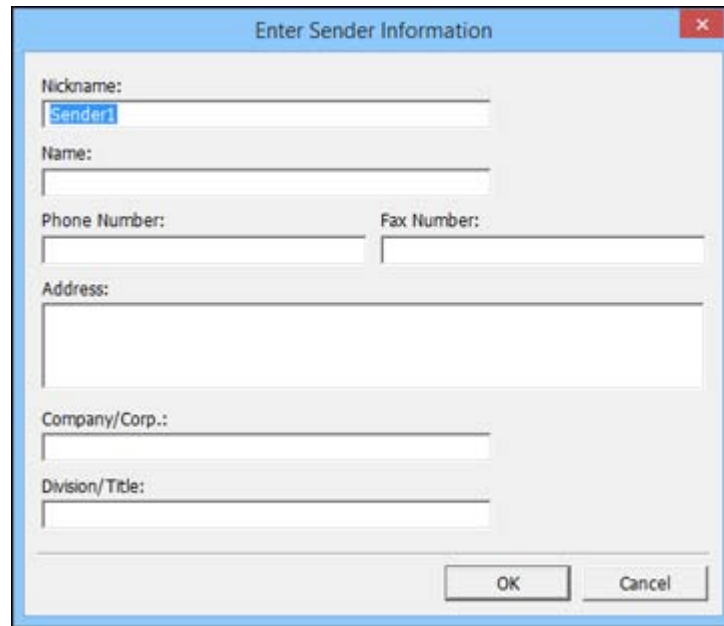

The image shows a dialog box titled "Enter Sender Information" with a red close button in the top right corner. The dialog contains several input fields: "Nickname:" with a text box containing "Sender1"; "Name:" with an empty text box; "Phone Number:" and "Fax Number:" with two separate text boxes; "Address:" with a larger text area; "Company/Corp.:" with a text box; and "Division/Title:" with a text box. At the bottom right, there are "OK" and "Cancel" buttons.

6. Enter your sender information so that recipients can identify the origin of the fax. Then click **OK** to save the sender information.

You see a window like this:

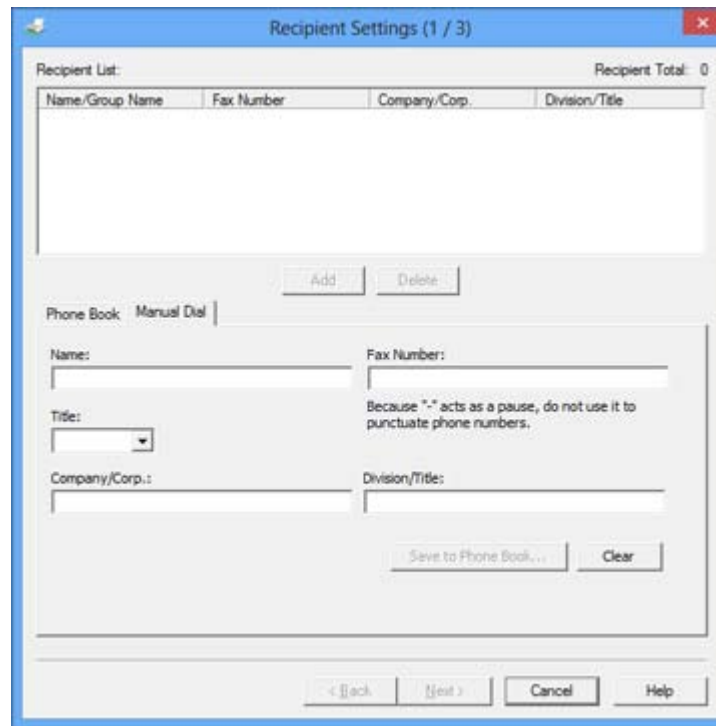

7. Enter the recipient's name and fax number or select a recipient from the phonebook, then click **Next**.

Note: For detailed instructions on using the Epson FAX Utility, click **Help**.

8. Select a cover sheet and enter a subject and message, then click **Next**.
9. Click **Send** to transmit your fax.

Parent topic: [Sending Faxes](#)

Sending Faxes Using the Fax Utility - OS X

You can send a fax from a OS X printing program using the FAX Utility. You can fax up to 100 pages at a time, including a cover sheet.

1. Open the file you want to fax.

2. Select the print command in your application.

Note: You may need to select a print icon on your screen, the **Print** option in the **File** menu, or another command. See your application's help utility for details.



3. Select your product **FAX** option as the **Printer** setting.
4. If necessary, click the arrow next to the Printer setting or the **Show Details** button to expand the print window.
5. Select the number of pages you are faxing as the **Pages** setting.

Note: Leave the **Copies** setting set to **1**.

6. Select **Recipient Settings** from the pop-up menu.

You see this window:

The image shows a dialog box titled "Recipient Settings". At the top, there is a title bar with the text "Recipient Settings" and a small blue icon with a double-headed arrow. Below the title bar, the dialog is divided into several sections. The first section is labeled "Recipient List:" and contains a table with three columns: "Name", "Company/Corp.", and "Fax Number". The table is currently empty. Below the table, there is a small icon of a person, a plus sign (+), and a minus sign (-). The second section is labeled "Add:" and contains three text input fields: "Name:", "Company/Corp.:", and "Fax Number:". Below these fields, there is a note: "A hyphen (-) is available only at the beginning of the phone number because it acts as a pause in dialing." At the bottom of the dialog, there is a text input field labeled "External Access Prefix:". At the very bottom, there are two buttons: "Cancel" and "Fax".

7. Do one of the following to choose your recipient:
 - Select a name or group from the **Recipient List**.
 - Enter a name, company, and fax number and click the **+** button.
 - Click the  icon and select a recipient from your address book.
8. Select **Fax Settings** from the pop-up menu.

You see this window:

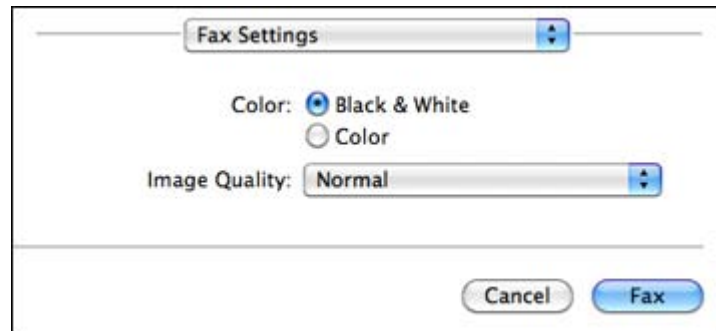

9. Select the **Color** and **Image Quality** settings you want to use for your fax.
10. Click **Fax**.

Parent topic: [Sending Faxes](#)

Receiving Faxes

See these sections to receive faxes with your product.

[Fax Reception](#)

[Receiving Faxes Automatically](#)

[Receiving Faxes Manually](#)

[Receiving a Fax by Polling](#)

[Viewing a Fax on the LCD Screen](#)

Parent topic: [Faxing](#)

Fax Reception

Your product will automatically receive and print faxes when you set the Receive Mode to **Auto**.

If you connected a telephone to your product so you can use the same phone line for faxes and voice calls, you can also set your product to receive faxes manually. This allows you to check for a fax tone using the telephone and press a button on your product to receive the fax.

Make sure to load paper in your product and select your fax settings before receiving a fax.

Note: If you run out of paper during fax printing, load more paper and press the button indicated on your product's LCD screen to continue.

Parent topic: [Receiving Faxes](#)

Receiving Faxes Automatically

To receive faxes automatically, make sure Receive Mode is set to **Auto** (the default setting for the product).

To change the Receive Mode if necessary, select **Setup > System Administration > Fax Settings > Receive Settings > Receive Mode**.

If an answering machine is connected, make sure the product's **Rings to Answer** setting is set higher than the number of rings your answering machine is set to answer a call. For example, if the answering machine is set to pick up on the fourth ring, set the product to pick up on the fifth ring or later.

Parent topic: [Receiving Faxes](#)

Related concepts

[Fax Reception](#)

Related tasks

[Receiving Faxes Manually](#)

Receiving Faxes Manually

You can set up your product to receive faxes manually by setting the Receive Mode to **Manual**. This lets you check for a fax tone on the connected telephone before receiving a fax.

1. To change the Receive Mode, select **Setup > System Administration > Fax Settings > Receive Settings > Receive Mode** and select **Manual**.
2. When the connected telephone rings, answer the call.
3. If you hear a fax tone, select **Start Fax** on the LCD display.
4. Select **Receive**.
5. Press one of the  buttons to start receiving the fax.
6. Hang up the telephone.

Parent topic: [Receiving Faxes](#)

Related concepts

[Fax Reception](#)

Related tasks

[Receiving Faxes Automatically](#)

Receiving a Fax by Polling

You can use polling to receive a fax from another fax machine (such as a fax information service).

1. Press the **Home** button, if necessary.
2. Select **Fax**.

You see a screen like this:





3. Select **Menu**.
4. Select **Polling Receive** and select **On**.
5. Enter the fax number you expect to receive the fax from.
6. Press one of the **Start** buttons to start receiving the fax.

Parent topic: [Receiving Faxes](#)

Viewing a Fax on the LCD Screen

You can save received faxes in your product's memory and view them on the LCD screen.

Note: To use this feature, you must first enable Save to Inbox from the Output Settings menu. The Inbox can be locked by an administrator. If you cannot access the Inbox, contact your administrator for assistance.

1. Press the  home button, if necessary.
2. Check the  icon on the LCD screen. It turns on if there are any unread or unprinted faxes in the product's memory.
3. Select **Fax**.
4. Select **Open Inbox**. Enter the administrator password, if necessary.
5. Select the fax you want to view.
You see the fax displayed on the screen.
6. Select **Menu**.
7. Select one of the printer/deleting options and follow the on-screen instructions.

Note: Delete faxes after you print or view them to prevent the product's memory from filling up. When the memory is full, you cannot receive or send faxes.

Parent topic: [Receiving Faxes](#)

Checking Fax Status

You can use the **i Status** button to check the status of current fax jobs, or faxes that have been received or sent.

1. Press the **i Status** button.
You see a screen like this:

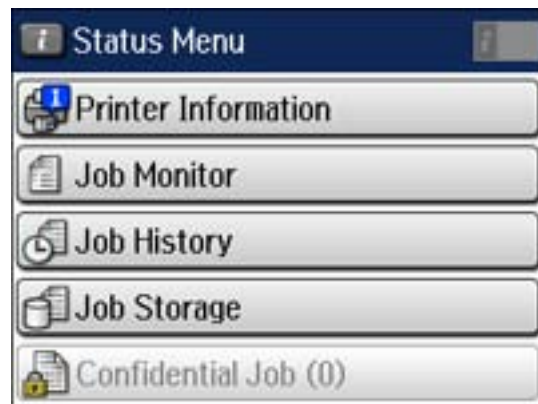

2. Do one of the following:
 - To check the status of current fax jobs, select **Job Monitor**, select **Communication Job**, and select the fax job you want to check.
 - To check the history of faxes that have been sent or received, select **Job History**, select **Receive Job** or **Send Job**, and select the job you want to check.
 - To check received faxes that have been saved in the product's memory, select **Job Storage** and select **Inbox**.

Parent topic: [Faxing](#)

Printing Fax Reports

You can select from several fax reports to print whenever necessary. You can also have the fax log printed automatically by turning on **Fax Log Auto Print**.

1. Press the  home button, if necessary.
2. Select **Fax**.

You see a screen like this:



3. Select **Menu**, select **Fax Report**, and select the report you want to print.

[Fax Report Options](#)

Parent topic: [Faxing](#)

Fax Report Options

Select the fax report or list you want to print.

Fax Settings List

Print a list of the current fax communication settings.

Fax Log

View or print a report on recent fax transmissions.

Last Transmission

Print a report on the previous fax that was sent or received through polling.

Stored Fax Documents

Print a list of the fax jobs currently stored in the product's memory.

Protocol Trace

Print a detailed report for the previous sent or received fax.

Parent topic: [Printing Fax Reports](#)

Using USB Flash Drives With Your Product

Follow the instructions here to work with a USB flash drive inserted into your product.

[Inserting a USB Flash Drive](#)

[Removing a USB Flash Drive](#)

[Viewing and Printing From the LCD Screen](#)

[Transferring Files on a USB Flash Drive](#)

Inserting a USB Flash Drive

Insert your USB flash drive into the USB port on the front of the product.

Note: Epson cannot guarantee the compatibility of your device. Make sure the files on the device are compatible with the product.

[USB Device Photo File Specifications](#)

Parent topic: [Using USB Flash Drives With Your Product](#)

USB Device Photo File Specifications

You can use USB devices with your product containing files that meet these specifications.

File format	JPEG with the Exif version 2.3 standard TIFF 6.0-compliant uncompressed images: RGB full-color or binary (not CCITT-encoded)
Image size	80 × 80 pixels to 10200 × 10200 pixels
File size	Up to 2GB
Number of files	JPEG: Up to 9990 TIFF: Up to 999

Parent topic: [Inserting a USB Flash Drive](#)

Removing a USB Flash Drive

After you finish working with a USB flash drive, follow these steps to remove it.

1. If your product is connected to your computer using a USB cable, do one of the following:
 - **Windows:** Open the **My Computer**, **Computer**, or **Windows Explorer** utility. Then right-click the name of your flash drive (listed as a removable disk) and select **Eject**.
 - **OS X:** Drag the removable disk icon for your flash drive from the desktop into the trash.

Caution: Do not remove a flash drive before completing the procedure above or you may lose data from the flash drive.

2. Pull the flash drive out of the USB port on the front of the product.

Parent topic: [Using USB Flash Drives With Your Product](#)

Viewing and Printing From the LCD Screen

See these sections to view and print photos or other files displayed on your product's LCD screen.

[Printing JPEG Photos](#)

[Printing TIFF Files](#)

[Photo Adjustment Options - Device Mode](#)

[Print Setting Options - Device Mode](#)

Parent topic: [Using USB Flash Drives With Your Product](#)

Printing JPEG Photos

You can select JPEG photos for printing as you view them on the LCD screen.

1. Press the  home button, if necessary.
2. Select **Memory Device**.
3. Select **JPEG**.

You see a screen like this:



Note: If you have more than 999 JPEG images on your device, the images are divided into groups, and you must first select the group you want to display.

4. Do one of the following to select your photos:
 - To select individual photos, select the thumbnail image of the photo you want to print, then use the numeric keypad on the control panel or press **+** or **-** on the LCD screen to select the number of copies (up to 99). Press the left or right arrow buttons to scroll through and select additional photos, or press the **↶** back button to return to the thumbnail image view and select another photo.
 - To select all photos, select **Options** > **Select Images** > **Select All Images**.
5. To adjust a photo (adjustments modify only your printed copy, not the original file), select its thumbnail image, and select **Adjustments**. Make the necessary adjustments and press the **↶** back button.
6. To change the print settings, select **Settings**, and select the necessary settings. When you are finished, press the **↶** back button.
7. When you are ready to print, press one of the **⬠** buttons.

Note: To cancel printing, press the **⏹** **Stop** button or select **Cancel**.



Parent topic: [Viewing and Printing From the LCD Screen](#)

Related references

[Photo Adjustment Options - Device Mode](#)

Printing TIFF Files

You can select and print files in the TIFF format from a USB flash drive or other device.

1. Press the  home button, if necessary.
2. Select **Memory Device**.
3. Select **TIFF**.
You see a list of the available files.
4. Select the file you want to print.
You see information about the file.
5. Select **Proceed**.
6. Do the following as necessary:
 - To print more than one copy, use the numeric keypad on the control panel or press + or – on the LCD screen to select the number of copies (up to 99).
 - To change the print settings, select **Settings**, and select the necessary settings. When you are finished, press the  back button.
7. Select **Proceed**.
8. When you are ready to print, press one of the  buttons.

Note: To cancel printing, press the  **Stop** button or select **Cancel**.

Parent topic: [Viewing and Printing From the LCD Screen](#)

Photo Adjustment Options - Device Mode

Select the **Image Adjustments** you want to use when viewing and printing photos displayed on the LCD screen.

Photo adjustment settings	Available options	Description
Fix Photo	On	Automatically adjusts the brightness, contrast, and saturation of the photo based on the Advanced > Scene Detection setting that is selected
	Off	Turns off automatic adjustments; see Note below
	P.I.M.	Uses your camera's PRINT Image Matching or Exif Print adjustments
Fix Red-Eye	Off - This Image	Automatically fixes the red-eye effect in photos
	On - This Image	
	Off - All Image	
	On - All Image	

Note: **Fix Photo** uses a sophisticated face recognition technology to optimize photos that include faces. For this to work, both eyes and the nose must be visible in the subject's face. If your photo includes a face with an intentional color cast, such as a statue, you may want to turn off **Fix Photo** to retain the special color effects.

Parent topic: [Viewing and Printing From the LCD Screen](#)

Print Setting Options - Device Mode

Select the **Print Settings** you want to use when printing from a USB flash drive or other memory device.

Note: Not all options or settings may be available, depending on the file format.

Print settings	Available options	Description
Paper Source	Various paper size and type settings	Indicates the source that contains the paper size and type you want to print on
Quality	Standard	Provides good quality for most prints
	Best	Provides the highest quality for special prints
Date	Various date formats	Prints the date the photo was taken on the photo in the format you select

Print settings	Available options	Description
Fit Frame	On	Automatically crops the photo to fit into the selected photo layout
	Off	Turns off automatic cropping
Bidirectional	On	Prints at normal speed
	Off	Slows down printing to improve print quality
Print Order	Last Page on Top	Select the order for printing multi-page TIFF files.
	First Page on Top	

Parent topic: [Viewing and Printing From the LCD Screen](#)

Transferring Files on a USB Flash Drive

You can transfer files to and from a USB flash drive inserted into the USB port on the front of your product.

[Setting Up File Sharing for File Transfers From Your Computer](#)

[Transferring Files from a USB Flash Drive to Your Computer](#)

Parent topic: [Using USB Flash Drives With Your Product](#)

Related tasks

[Removing a USB Flash Drive](#)

[Inserting a USB Flash Drive](#)

Setting Up File Sharing for File Transfers From Your Computer

Before you transfer files from a computer to a USB flash drive inserted into the USB port on the front of your product, you may need to set up your product's file sharing settings.

Caution: Remove the flash drive before you change this setting or you may lose data from the flash drive.

Note: These settings can be locked by an administrator. If you cannot access these settings, contact your administrator for assistance.

1. Press the  home button, if necessary.
2. Select **Setup**.

3. Scroll down and select **System Administration**. Enter the administrator password, if necessary.
4. Select **Printer Settings**.
5. Select **Memory Device Interface**.

You see a screen like this:

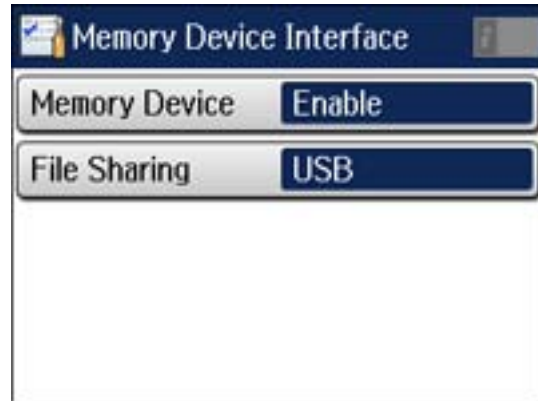

6. Make sure **Memory Device** is set to **Enable**.
7. Select **File Sharing**.
8. Select the way your computer is connected to the product: either **USB** or **Wi-Fi/Network**.

Parent topic: [Transferring Files on a USB Flash Drive](#)

Transferring Files from a USB Flash Drive to Your Computer

You can transfer files to and from a USB flash drive inserted into the USB port on the front of your product and a computer connected to your product.

Note: Do not transfer files to and from a flash drive while you are printing from the flash drive.

1. Make sure your product is connected to a computer.
2. Insert a flash drive into the USB port on the front of your product.
3. Do one of the following to access your flash drive files from your computer:
 - **Windows:** Select the **Computer** or **My Computer** utility, then select the removable disk icon.

- **OS X with a USB connection:** Look for the removable disk icon on your desktop, then select it.
 - **OS X with a network connection:** Select the hard drive icon on your desktop or select **Computer** from the **Go** menu, select your product in the **SHARED** section of the sidebar (you may need to widen the sidebar to see the name), and select the **USBSTORAGE** icon.
4. Select the folder that contains your files.
 5. Drag the files you want to transfer to the desired folder on your computer or on your flash drive.

Note: Your product's LCD screen does not update to display new information about your flash drive after you copy files to it or delete files from it. Remove and insert the flash drive to update the information.

Parent topic: [Transferring Files on a USB Flash Drive](#)

Replacing Ink Cartridges and Maintenance Boxes

The maintenance box stores ink that gets flushed from the system during print head cleaning. When an ink cartridge is expended or the maintenance box is at the end of its service life, you need to replace it.

You may also need to replace a cartridge that is more than six months old if your printouts do not look their best, even after cleaning and aligning the print head.

Note: Please dispose of your used Epson branded ink cartridges and maintenance boxes responsibly and in accordance with local requirements. If you would like to return your used ink cartridges and maintenance boxes to Epson for proper disposal, please go to [epson.com/recycle](https://www.epson.com/recycle) for more information.

[Check Cartridge and Maintenance Box Status](#)

[Purchase Epson Ink Cartridges and Maintenance Box](#)

[Removing and Installing Ink Cartridges](#)

[Printing With Black Ink and Expended Color Cartridges](#)

[Conserving Low Black Ink with Windows](#)

[Replacing the Maintenance Box](#)

Check Cartridge and Maintenance Box Status

Your printer and its software will let you know when an ink cartridge is low or expended, or when the maintenance box needs to be replaced.

[Checking Cartridge Status on the LCD Screen](#)

[Checking Cartridge and Maintenance Box Status with Windows](#)

[Checking Cartridge and Maintenance Box Status with OS X](#)



Parent topic: [Replacing Ink Cartridges and Maintenance Boxes](#)

Related tasks

[Removing and Installing Ink Cartridges](#)

[Replacing the Maintenance Box](#)

Checking Cartridge Status on the LCD Screen

When one of your cartridges is low, you see the  icon on the LCD screen and the orange **i Status** light flashes. When a cartridge is expended, you see the  icon and the orange **i Status** light stays on. You can use the **i Status** button check the status of the cartridges and maintenance box.

1. Press the **i Status** button.
2. Select **Printer Information**.

You see a screen like this:



The ink and maintenance box levels are displayed at the bottom of the screen.

Note: The displayed ink and maintenance box levels are approximate.

3. For more information, select the ink cartridge images at the bottom of the screen.

Parent topic: [Check Cartridge and Maintenance Box Status](#)

Checking Cartridge and Maintenance Box Status with Windows

A low ink reminder appears if you try to print when ink is low, and you can check your cartridge or maintenance box status at any time using a utility on your Windows computer.

1. To check your status, access the Windows Desktop, double-click the product icon in the Windows taskbar, and click **Details**.

You see this window:

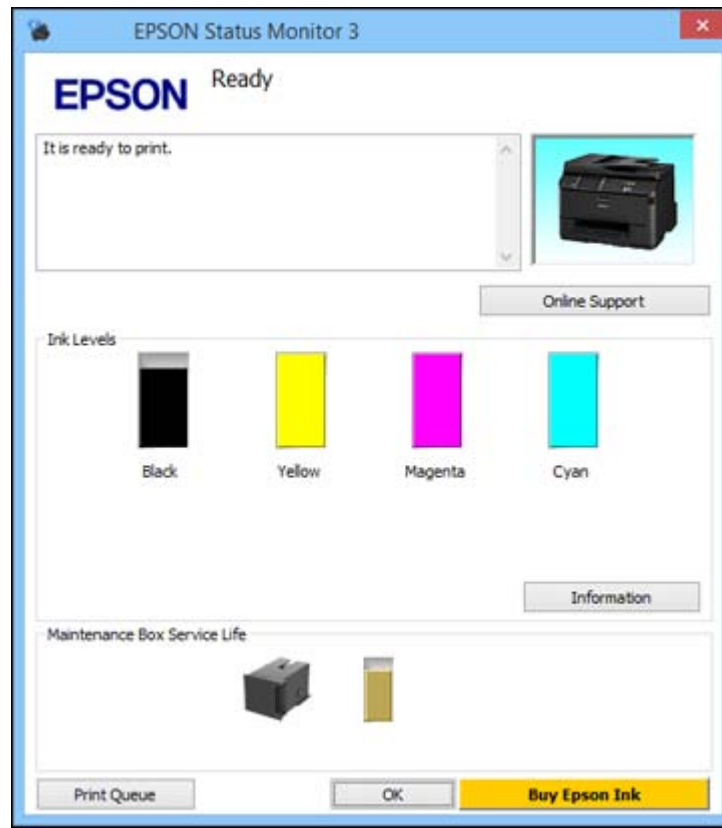

2. Replace or reinstall the maintenance box or any ink cartridge as indicated on the screen.

Note: If any of the cartridges installed in the product is broken, incompatible with the product model, or improperly installed, Epson Status Monitor will not display an accurate cartridge status.

3. To disable the low ink reminder, right-click the product icon in the Windows taskbar and select **Monitoring Preferences**.

You see this window:

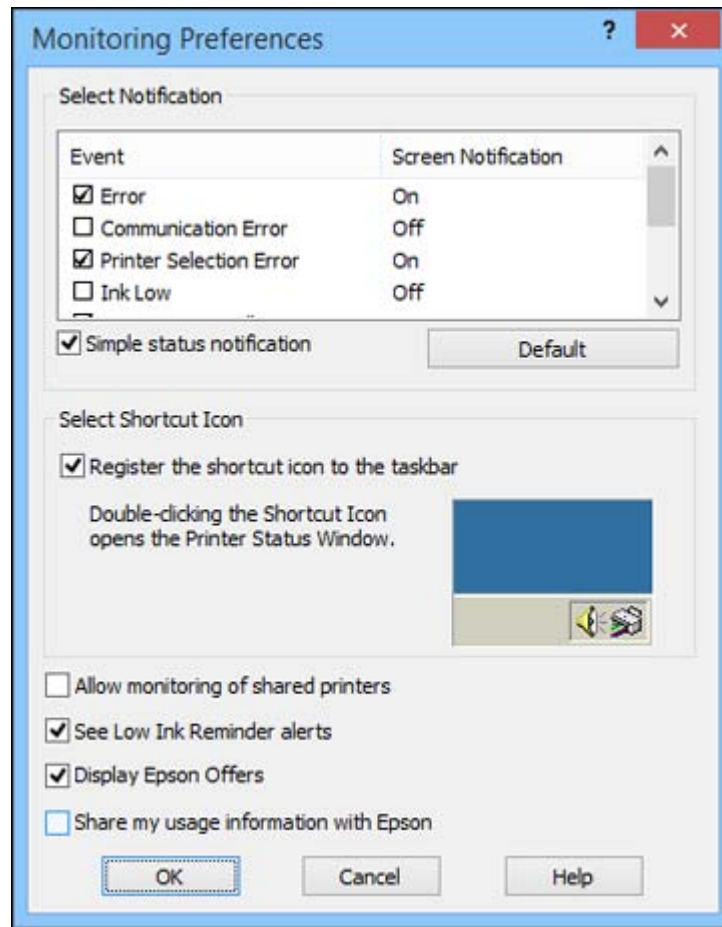

4. Deselect the **See Low Ink Reminder alerts** checkbox at the bottom of the screen.
5. To disable promotional offers, deselect the **Display Epson Offers** checkbox.

Parent topic: [Check Cartridge and Maintenance Box Status](#)

Related tasks

[Removing and Installing Ink Cartridges](#)

[Replacing the Maintenance Box](#)

Checking Cartridge and Maintenance Box Status with OS X

You can check the status of your ink cartridges and maintenance box using a utility on your Mac.

1. Do one of the following:
 - **OS X 10.6/10.7/10.8/10.9:** In the Apple menu or the Dock, select **System Preferences**. Select **Print & Fax**, **Print & Scan**, or **Printers & Scanners**, select your product, and select **Options & Supplies**. Select **Utility** and select **Open Printer Utility**.
 - **OS X 10.5:** In the Apple menu or the Dock, select **System Preferences**. Select **Print & Fax**, select your product, and select **Open Print Queue**. Select **Utility**.
2. Select **EPSON Status Monitor**.

You see this window:



3. Do the following as necessary:
 - You can update the ink cartridge and maintenance box status by clicking **Update**.
 - Replace or reinstall the maintenance box or any ink cartridge as indicated on the screen.

Note: If any of the cartridges installed in the product is broken, incompatible with the product model, or improperly installed, Epson Status Monitor will not display an accurate cartridge status.

Parent topic: [Check Cartridge and Maintenance Box Status](#)

Related tasks

[Replacing the Maintenance Box](#)

[Removing and Installing Ink Cartridges](#)

Purchase Epson Ink Cartridges and Maintenance Box

You can purchase genuine Epson ink, maintenance boxes, and paper at Epson Supplies Central at epson.com/ink3 (U.S. sales) or epson.ca (Canadian sales). You can also purchase supplies from an Epson authorized reseller. To find the nearest one, call 800-GO-EPSON (800-463-7766).

Note: This product uses only genuine Epson-brand cartridges. Other brands of ink cartridges and ink supplies are not compatible and, even if described as compatible, may not function properly.

The cartridges included with the printer are designed for printer setup and not for resale. After some ink is used for priming, the rest is available for printing. Yields vary considerably based on images printed, print settings, paper type, frequency of use, and temperature. For print quality, a variable amount of ink remains in the cartridge after the "replace cartridge" indicator comes on.

[Ink Cartridge and Maintenance Box Part Numbers](#)

Parent topic: [Replacing Ink Cartridges and Maintenance Boxes](#)

Ink Cartridge and Maintenance Box Part Numbers

Use these part numbers when you order or purchase a new maintenance box or ink cartridges.

Maintenance box part number: T6710

Note: For best printing results, use up a cartridge within 6 months of opening the package.

Ink color	Part number		
	Standard-capacity	High-capacity	Extra High-capacity
Black	786	786XL	788XXL
Cyan	786	786XL	788XXL
Magenta	786	786XL	788XXL
Yellow	786	786XL	788XXL

Parent topic: [Purchase Epson Ink Cartridges and Maintenance Box](#)

Removing and Installing Ink Cartridges

Make sure you have your replacement cartridges handy before you begin. You must install new cartridges immediately after removing the old ones.

Caution: Leave your old cartridges in the printer until you are ready to replace them to prevent the print head nozzles from drying out. Do not open ink cartridge packages until you are ready to install the ink. Cartridges are vacuum packed to maintain reliability.

1. Turn on your product.
2. If an ink cartridge is low or expended, a message appears on your product and on your computer screen. Note which cartridges need to be replaced.
3. Open the front cover.

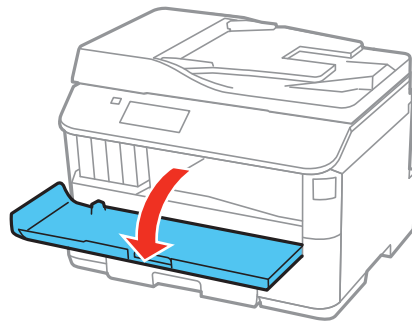

4. Push the ink cartridge in, then pull it out of the slot.

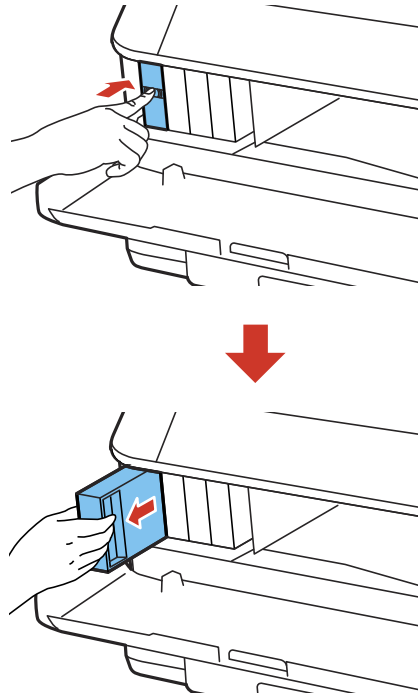

Note: Dispose of used cartridges carefully. Do not take the used cartridge apart or try to refill it.

Warning: If ink gets on your skin, wash it thoroughly with soap and water. If ink gets into your eyes, flush them immediately with water. If ink gets into your mouth, spit it out and see a doctor right away. Keep ink cartridges out of the reach of children.

5. Remove the cartridge from the package.

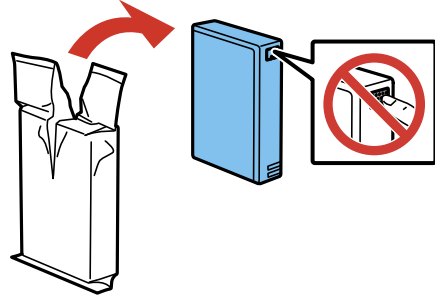

Caution: Do not touch the green chip on the cartridge. Install the new cartridge immediately after removing the old one; if you do not, the print head may dry out and be unable to print.

6. Gently shake the ink cartridge horizontally for about five seconds as shown.

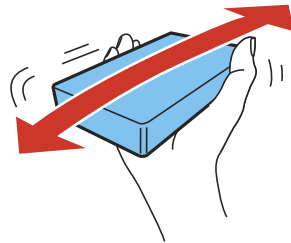

Caution: Do not remove any labels or seals, or ink will leak.

7. Insert the new cartridge into the holder and push it in until it clicks into place.

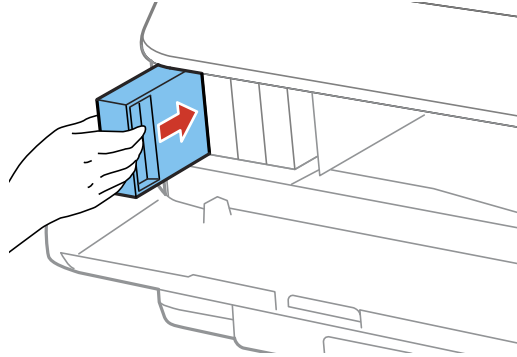

8. Select **Check** on the LCD screen to make sure the cartridges are installed correctly.

Caution: If you see a message that an ink cartridge is installed incorrectly, press in the ink cartridge until it clicks into place.

9. When you are finished, close the front cover.

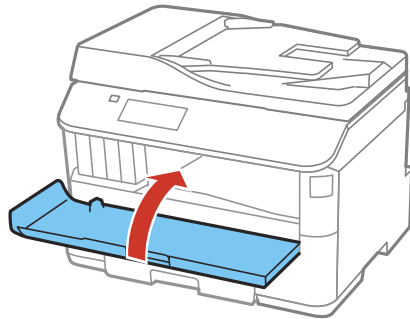

The product starts priming the ink and returns to its previous state when finished.

Note: Do not turn off the printer during ink replacement.

Caution: If you remove an ink cartridge for later use, protect the ink supply area from dirt and dust and store it in the same environment as the printer. The valve in the ink supply port is designed to contain any excess ink, but do not touch the ink supply port or surrounding area. Always store ink cartridges with the label facing up; do not store cartridges upside-down.

Parent topic: [Replacing Ink Cartridges and Maintenance Boxes](#)

Related references

[Ink Cartridge and Maintenance Box Part Numbers](#)

Printing With Black Ink and Expended Color Cartridges

When a color ink cartridge is expended, you can temporarily continue printing from your computer using black ink. Replace the expended color cartridge as soon as possible for future printing.

Note: You cannot print with expended color ink cartridges using your product's control panel.

[Printing With Expended Color Cartridges - Windows](#)

[Printing With Expended Color Cartridges - OS X](#)

Parent topic: [Replacing Ink Cartridges and Maintenance Boxes](#)

Printing With Expended Color Cartridges - Windows

If you see a message during printing telling you that you can temporarily print in black ink with an expended color cartridge, you can cancel your print job and select settings to print on plain paper or on an envelope.

Note: To use this feature, Epson Status Monitor must be enabled.

1. Click **Cancel** or **Cancel Print** to cancel your print job.

Note: If the message screen appears on another computer on a network, you may need to cancel the print job using the product control panel.

2. Load plain paper or an envelope in your product.
3. Access the print settings in your print application.
4. Click the **Main** tab.
5. Select **Plain Paper/Bright White Paper** or **Envelope** as the paper type setting.

6. Select the **Black/Grayscale** checkbox.
7. Click **OK**.
8. Print your document.
Epson Status Monitor 3 displays a print message.
9. Click **Print in Black** to print your document.

Parent topic: [Printing With Black Ink and Expended Color Cartridges](#)

Printing With Expended Color Cartridges - OS X

If printing stops, you can cancel your print job and select settings to temporarily print with only black ink on plain paper or on an envelope.

1. Click the printer icon in the Dock.
2. If you see a message telling you that you can temporarily print with only black ink, click the **Delete** icon to cancel your print job. (**OS X 10.8/10.9:** Click the  icon to cancel your print job. If an error message is displayed, click **OK**.)

Note: If the message screen appears on another computer on a network, you may need to cancel the print job using the product control panel.

3. In the Apple menu or the Dock, select **System Preferences**.
4. Select **Print & Fax**, **Print & Scan**, or **Printers & Scanners**, select your product, and select **Options & Supplies**.
5. Select **Driver** or **Options**.

You see a screen like this:

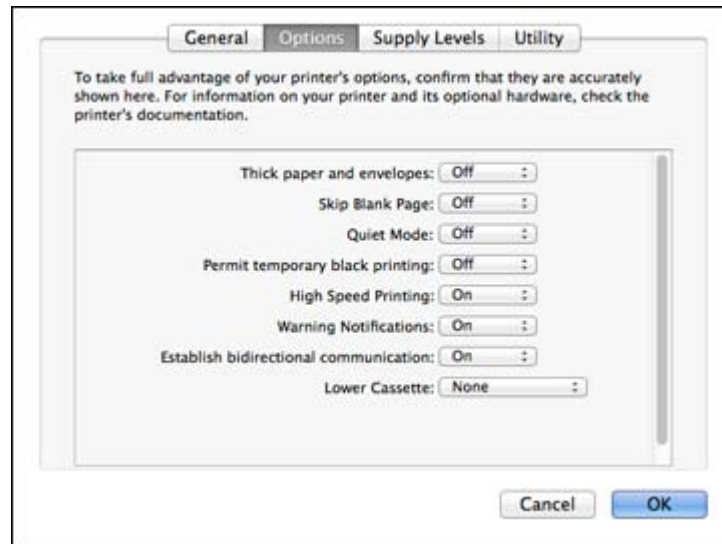

6. Select **On** as the **Permit temporary black printing** setting.
7. Click **OK**.
8. Close the utility window.
9. Load plain paper or an envelope in your product.
10. Access the print settings in your print application.
11. Select **Print Settings** from the pop-up menu.
12. Select **Plain Paper/Bright White Paper** or **Envelope** as the paper type setting.
13. Select the **Grayscale** option.
14. Click **Print** to print your document.

Parent topic: [Printing With Black Ink and Expended Color Cartridges](#)

Conserving Low Black Ink with Windows

The following window appears when black ink runs low and there is more color ink.

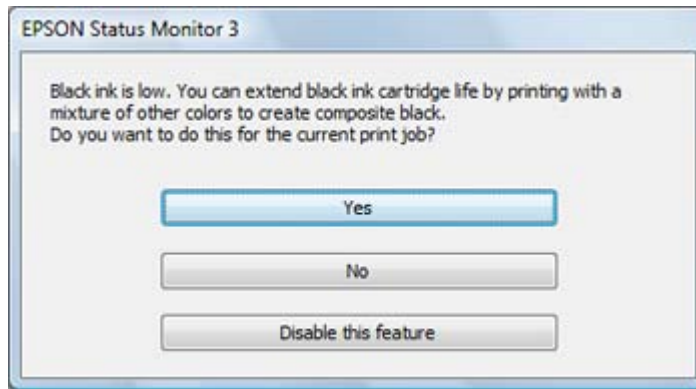

Note: The window appears only when you have selected **Plain Paper/Bright White Paper** as the paper type setting, and depends on other selected print settings. To use this feature, Epson Status Monitor must be enabled.

- Click **Yes** to use a mixture of color inks to create black, or **No** to continue using the remaining black ink for the document you are printing.
- Click **Disable this feature** to continue using the remaining black ink.

Note: If you disable this feature, it remains disabled until you reinstall the black ink cartridge.

Parent topic: [Replacing Ink Cartridges and Maintenance Boxes](#)

Replacing the Maintenance Box

Make sure you have a new maintenance box before you begin.

Caution: Do not reuse a maintenance box that has been removed and left uninstalled for more than a week. Keep the maintenance box away from direct sunlight.

1. Make sure the product is not printing.

2. Remove the new maintenance box from its package.

Caution: Do not touch the green chip on the maintenance box.

3. Press the buttons on the sides of the rear cover and remove it.

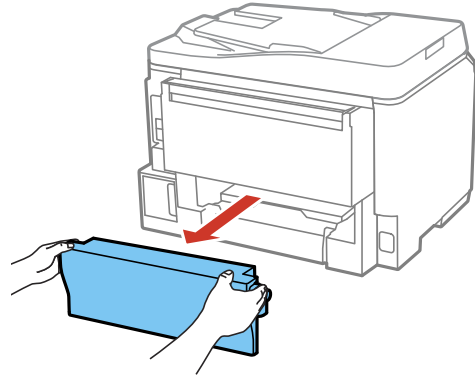

4. Grasp the maintenance box as shown and pull it out of its holder.

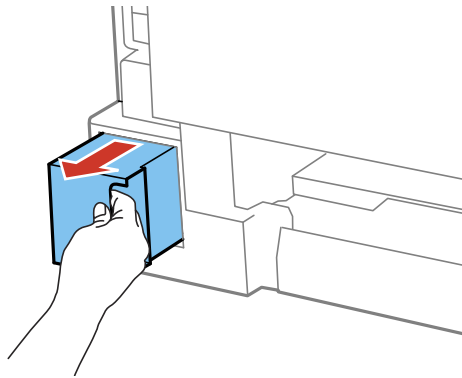

Note: Do not tilt the used maintenance box or take it apart.

Warning: If ink gets on your skin, wash it thoroughly with soap and water. If ink gets into your eyes, flush them immediately with water. If ink gets into your mouth, spit it out and see a doctor right away. Keep the maintenance box out of the reach of children and do not drink the ink.

5. Place the used maintenance box in the plastic bag that came with the new maintenance box. Seal the bag and dispose of it carefully.
6. Insert the new maintenance box into the holder and push it all the way in.

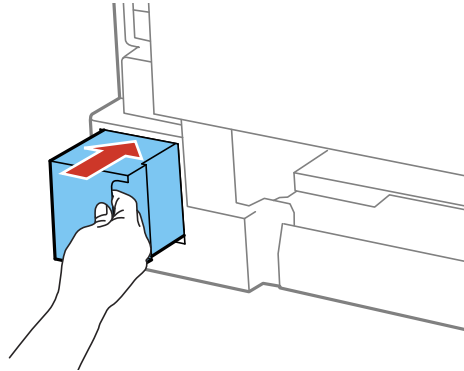

7. Press the buttons on the sides of the rear cover and reattach it.

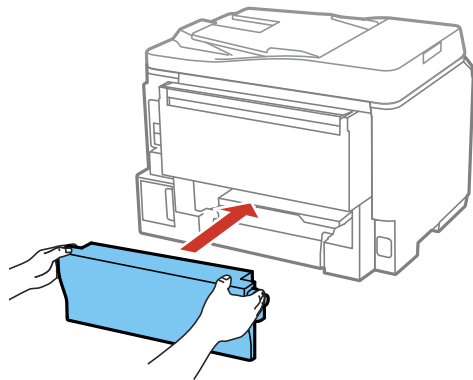

Parent topic: [Replacing Ink Cartridges and Maintenance Boxes](#)

Related references

[Ink Cartridge and Maintenance Box Part Numbers](#)

Adjusting Print Quality

If your print quality declines, you may need to run a utility to clean or align the print head.

If running these utilities does not solve the problem, you may need to replace the ink cartridges.

[Print Head Maintenance](#)

[Print Head Alignment](#)

[Cleaning the Paper Guide](#)

Print Head Maintenance

If your printouts become too light, or you see dark or light bands across them, you may need to clean the print head nozzles. Cleaning uses ink, so clean the nozzles only if print quality declines.

You can check for clogged nozzles before you clean them so you don't clean them unnecessarily.

Note: You cannot clean the print head if an ink cartridge is expended, and may not be able to clean it when a cartridge is low. You must replace the cartridge first.

[Print Head Nozzle Check](#)

[Print Head Cleaning](#)

Parent topic: [Adjusting Print Quality](#)

Related topics

[Replacing Ink Cartridges and Maintenance Boxes](#)

Print Head Nozzle Check

You can print a nozzle check pattern to check for clogged nozzles.

[Checking the Nozzles Using the Product Control Panel](#)

[Checking the Nozzles Using a Computer Utility](#)

Parent topic: [Print Head Maintenance](#)

Related tasks

[Removing and Installing Ink Cartridges](#)

Checking the Nozzles Using the Product Control Panel

You can check the print head nozzles using the control panel on your product.

1. Make sure there are no errors on the LCD screen and plain paper is loaded in the product.
2. Press the  home button, if necessary.
3. Select **Setup**.
4. Select **Maintenance**.

You see a screen like this:

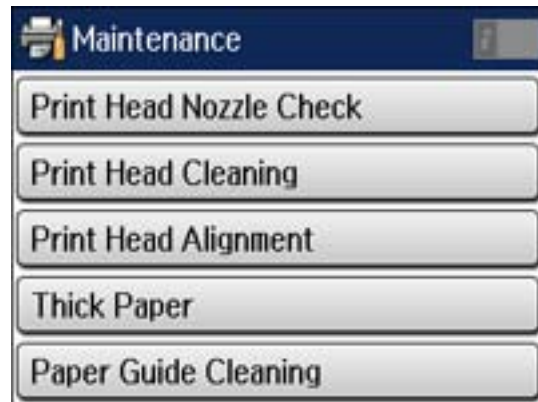

5. Select **Print Head Nozzle Check**.

You see a screen like this:

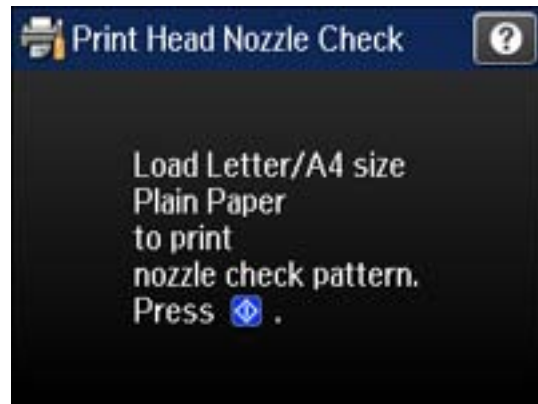

6. Press the  **Color** button.
The nozzle pattern prints.
7. Check the printed pattern to see if there are gaps in the lines.

Print head is clean

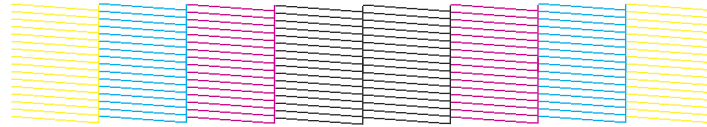

Print head needs cleaning

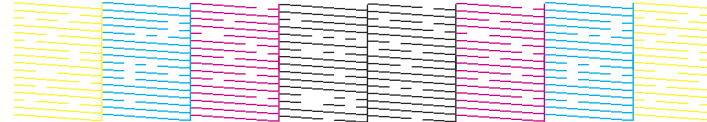

8. Do one of the following:
 - If there are no gaps, select **Done**.
 - If there are gaps or the pattern is faint, select **Clean the Print Head** and continue.
9. Follow the instructions on the screen to clean the print head, check the nozzles, and repeat the process as necessary.

If you don't see any improvement after cleaning the print head up to 4 times, leave the product turned on and wait at least 6 hours. Then try cleaning the print head again. If quality still does not improve, one of the ink cartridges may be old or damaged and needs to be replaced.

Parent topic: [Print Head Nozzle Check](#)

Related concepts

[Print Head Cleaning](#)

Related tasks

[Removing and Installing Ink Cartridges](#)

Related topics

[Loading Paper](#)

Checking the Nozzles Using a Computer Utility

You can check the print head nozzles using a utility on your Windows or Mac computer.

1. Make sure there are no errors on the LCD screen.
2. Load a few sheets of plain paper in the product.
3. Do one of the following:
 - **Windows:** Access the Windows Desktop and right-click the product icon in the Windows taskbar.
 - **OS X 10.6/10.7/10.8/10.9:** In the Apple menu or the Dock, select **System Preferences**. Select **Print & Fax**, **Print & Scan**, or **Printers & Scanners**, select your product, and select **Options & Supplies**. Select **Utility** and select **Open Printer Utility**.
 - **OS X 10.5:** In the Apple menu or the Dock, select **System Preferences**. Select **Print & Fax**, select your product, and select **Open Print Queue**. Select **Utility**.
4. Select **Nozzle Check**.

You see a window like this:

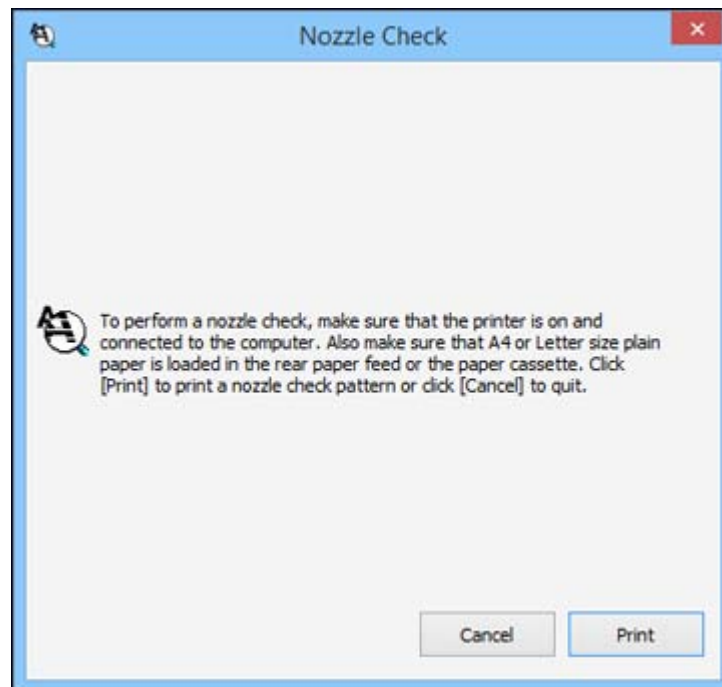

5. Click **Print**.
6. Check the printed pattern to see if there are gaps in the lines.

Print head is clean



Print head needs cleaning



7. If there are no gaps, click **Finish**.
If there are gaps or the pattern is faint, clean the print head.

Parent topic: [Print Head Nozzle Check](#)

Related concepts

[Print Head Cleaning](#)

Related tasks

[Removing and Installing Ink Cartridges](#)

Related topics

[Loading Paper](#)

Print Head Cleaning

If print quality has declined and the nozzle check pattern indicates clogged nozzles, you can clean the print head.

Note: You cannot clean the print head if an ink cartridge is expended, and may not be able to clean it when a cartridge is low. You must replace the cartridge first.

[Cleaning the Print Head Using the Product Control Panel](#)
[Cleaning the Print Head Using a Computer Utility](#)

Parent topic: [Print Head Maintenance](#)

Related tasks

[Removing and Installing Ink Cartridges](#)

Cleaning the Print Head Using the Product Control Panel

You can clean the print head using the control panel on your product.

1. Make sure there are no errors on the LCD screen.
2. Load a few sheets of plain paper in the product.
3. Press the  home button, if necessary.
4. Select **Setup**.
5. Select **Maintenance**.

You see a screen like this:

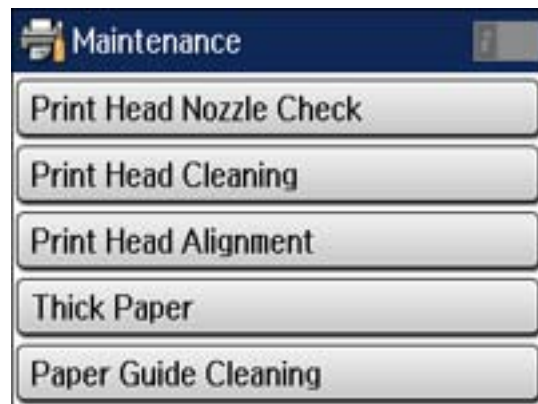

6. Select **Print Head Cleaning**.

You see a screen like this:



7. Press the  **Color** button to clean the print head.

When the cleaning cycle is finished, you see a message on the screen.

Caution: Never turn off the product during a cleaning cycle or you may damage it.

8. Select **Print Nozzle Check Pattern**.
9. Press the  **Color** button to confirm that the print head is clean.

If you don't see any improvement after cleaning the print head up to 4 times, leave the product turned on and wait at least 6 hours. Then try cleaning the print head again. If quality still does not improve, one of the ink cartridges may be old or damaged and needs to be replaced.

Parent topic: [Print Head Cleaning](#)

Related tasks

[Cleaning the Print Head Using a Computer Utility](#)

[Removing and Installing Ink Cartridges](#)

[Checking the Nozzles Using the Product Control Panel](#)

Cleaning the Print Head Using a Computer Utility

You can clean the print head using a utility on your Windows or Mac computer.

1. Make sure there are no errors on the LCD screen.
2. Load a few sheets of plain paper in the product.

3. Do one of the following:
 - **Windows:** Access the Windows Desktop and right-click the product icon in the Windows taskbar.
 - **OS X 10.6/10.7/10.8/10.9:** In the Apple menu or the Dock, select **System Preferences**. Select **Print & Fax**, **Print & Scan**, or **Printers & Scanners**, select your product, and select **Options & Supplies**. Select **Utility** and select **Open Printer Utility**.
 - **OS X 10.5:** In the Apple menu or the Dock, select **System Preferences**. Select **Print & Fax**, select your product, and select **Open Print Queue**. Select **Utility**.

4. Select **Head Cleaning**.

You see a window like this:

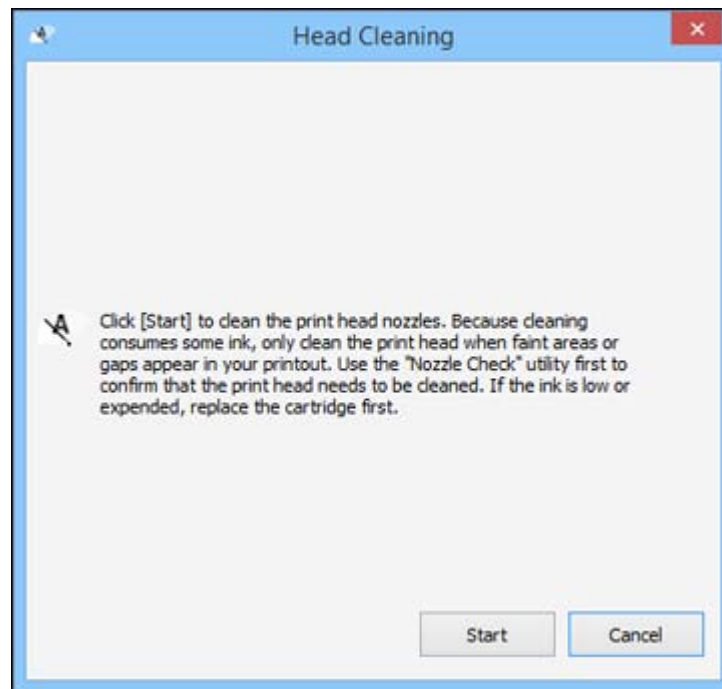

5. Click **Start** to begin the cleaning cycle.

The **⏻** power light flashes throughout the cleaning cycle and stays on when the cleaning cycle is finished.

Note: Do not open the front cover during the cleaning cycle.

Caution: Never turn off the product during a cleaning cycle or you may damage it.

- When the cleaning cycle is finished, you can check to see if the nozzles are clean; click **Print Nozzle Check Pattern** and click **Print**.
- Check the printed pattern to see if there are gaps in the lines.

Print head is clean



Print head needs cleaning



- If there are no gaps, click **Finish**.
- If there are gaps or the pattern is faint, click **Clean** to clean the print head again.

If you don't see any improvement after cleaning the print head up to 4 times, leave the product turned on and wait at least 6 hours. Then try cleaning the print head again. If quality still does not improve, one of the ink cartridges may be old or damaged and needs to be replaced.

Parent topic: [Print Head Cleaning](#)

Related tasks

[Removing and Installing Ink Cartridges](#)

[Cleaning the Print Head Using a Computer Utility](#)

[Cleaning the Print Head Using the Product Control Panel](#)

Print Head Alignment

If your printouts become grainy or blurry, you notice misalignment of vertical lines, or you see dark or light horizontal bands, you may need to align the print head.

Note: Banding may also occur if your print head nozzles need cleaning.

[Aligning the Print Head Using the Product Control Panel](#)

[Aligning the Print Head Using a Computer Utility](#)

Parent topic: [Adjusting Print Quality](#)

Aligning the Print Head Using the Product Control Panel

You can align the print head using the control panel on your product.

1. Make sure there are no errors on the LCD screen.
2. Load a few sheets of plain paper in the cassette (or in cassette 1 if your product has two cassettes).
3. Press the  home button, if necessary.
4. Select **Setup**.
5. Select **Maintenance**.

You see a screen like this:

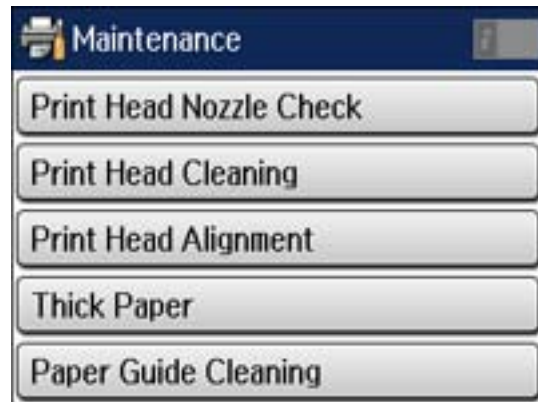

6. Select **Print Head Alignment**.

You see a screen like this:

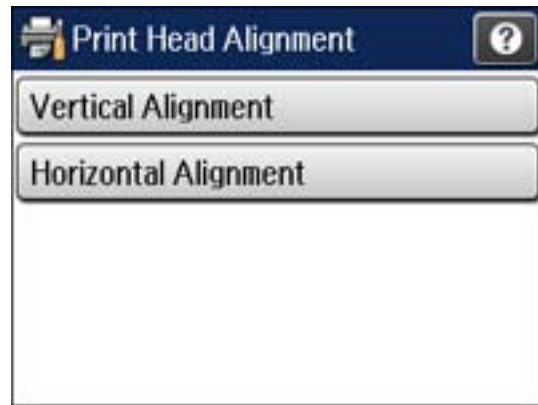

7. Do one of the following:
 - If your printouts look blurry or vertical lines are misaligned, select **Vertical Alignment**.
 - If you see horizontal bands at regular intervals, select **Horizontal Alignment**.

8. Follow the on-screen instructions to print an alignment sheet.

Note: Do not cancel printing while you are printing head alignment patterns.

9. Check the printed patterns on the alignment sheet and do one of the following:
 - If you printed a vertical alignment sheet, select the number representing the most solid printed pattern for each set on the LCD screen .

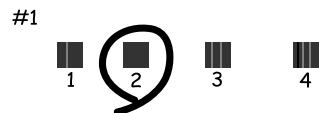

- If you printed a horizontal alignment sheet, select the number representing the pattern with the least amount of separation or overlap on the LCD screen.



Parent topic: [Print Head Alignment](#)

Aligning the Print Head Using a Computer Utility

You can align the print head using a utility on your Windows computer or Mac.

1. Make sure there are no errors on the LCD screen.
2. Load a few sheets of plain paper in the cassette (or in cassette 1 if your product has two cassettes).
3. Do one of the following:
 - **Windows:** Right-click the product icon in the Windows taskbar.
 - **OS X 10.6/10.7/10.8/10.9:** In the Apple menu or the Dock, select **System Preferences**. Select **Print & Fax**, **Print & Scan**, or **Printers & Scanners**, select your product, and select **Options & Supplies**. Select **Utility** and select **Open Printer Utility**.
 - **OS X 10.5:** In the Apple menu or the Dock, select **System Preferences**. Select **Print & Fax**, select your product, and select **Open Print Queue**. Select **Utility**.
4. Select **Print Head Alignment**.
5. Click **Next**, then click **Print** to print an alignment sheet.

Note: Do not cancel printing while you are printing a head alignment pattern.

You see a window like this:

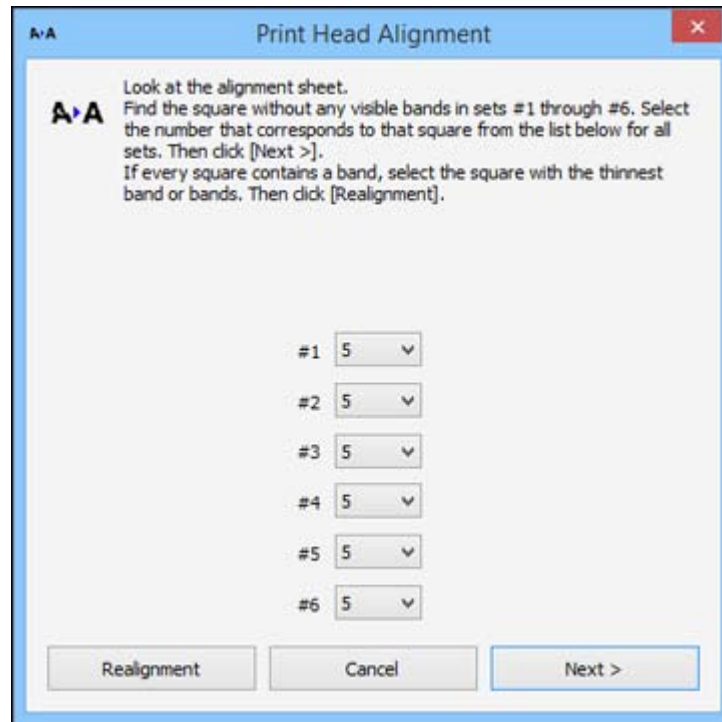

6. Check the printed pattern and follow the instructions on the screen to choose the number representing the best printed pattern for each set.

Vertical alignment

#1

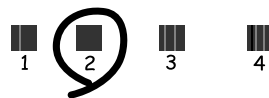

Horizontal alignment



- After choosing each pattern number, click **Next**.
- If no patterns are aligned in one or more of the sets, choose the closest one in each set and click **Realignment**. Then print another alignment sheet and check it.

Note: Click **Skip** (where available) if you want to skip a particular alignment sheet.

7. When you are done, click **Finish**.

Parent topic: [Print Head Alignment](#)

Cleaning the Paper Guide

If you see ink on the back of a printout, you can clean the paper guide rollers to remove any excess ink.

1. Make sure there are no errors on the LCD.
2. Load a few sheets of plain paper in the product (or in cassette 1 if your product has two cassettes).
3. Press the  home button, if necessary.
4. Select **Setup**.
5. Select **Maintenance**.

You see a screen like this:

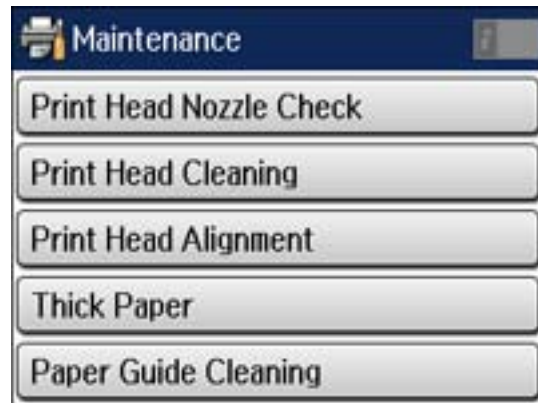

6. Scroll down and select **Paper Guide Cleaning**.
7. Select the paper source to clean.
8. Press the **Color** button.
9. Check the back of the ejected paper to see if it is clean.
10. Repeat as necessary until the paper comes out clean.

Note: If the paper comes out stained even after several cleaning attempts, try cleaning the other paper sources.

Parent topic: [Adjusting Print Quality](#)

Cleaning and Transporting Your Product

See these sections if you need to clean or transport your product.

[Cleaning Your Product](#)

[Transporting Your Product](#)

Cleaning Your Product

To keep your product working at its best, you should clean it several times a year.

Note: Close the rear paper feed slot and the output tray when you are not using the product to protect it from dust.

Caution: Do not use a hard brush, alcohol, or paint thinner to clean the product or you may damage it. Do not use oil or other lubricants inside the product or let water get inside it.

1. Turn off the product.
2. Unplug the power cable.
3. Disconnect any connected cables.
4. Remove all the paper from the product.

5. Clean the scanner glass and the glass area on the left with a soft, lint-free cloth (microfiber is recommended), moistened with a little glass cleaner.

Caution: Do not spray glass cleaner directly on the glass and do not press the glass surface with any force.

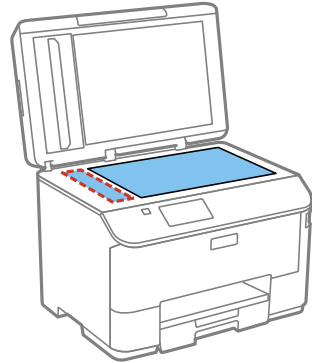

Note: If lines appear on the printout or in scanned images, carefully clean the scanner glass on the left.

6. Open the ADF cover and use a soft, dry, lint-free cloth (microfiber is recommended), to clean the rollers and the interior of the ADF.

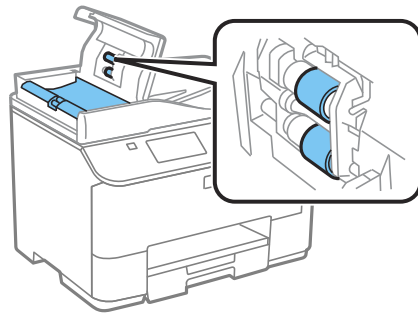

7. Clean the outer case and control panel with a soft, dry cloth. Do not use liquid or chemical cleansers.

Parent topic: [Cleaning and Transporting Your Product](#)

Transporting Your Product

If you need to ship your product or transport it a long distance, prepare it for transportation as described here.

Caution: During transportation and storage, follow these guidelines:

- Avoid tilting the product, placing it vertically, or turning it upside down; otherwise ink may leak.
 - Leave the ink cartridges installed. Removing the cartridges can dry out the print head and may prevent the product from printing.
1. Turn off the product.
 2. Remove all the paper from the product.
 3. Unplug the power cable.
 4. Disconnect any connected cables.
 5. Close the rear paper feeder and the output tray.
 6. Place the product in its original packing materials, if possible, or use equivalent materials with cushioning around the product. Make sure the box adequately protects the product control panel.

Keep the product level during transportation. If print quality has declined when you print again, clean and align the print head.

Parent topic: [Cleaning and Transporting Your Product](#)

Related concepts

[Print Head Alignment](#)

[Print Head Cleaning](#)

Solving Problems

Check these sections for solutions to problems you may have using your product.

[Checking for Software Updates](#)

[Product Status Messages](#)

[Status Menu Error Codes](#)

[Running a Product Check](#)

[Resetting Control Panel Defaults](#)

[Solving Setup Problems](#)

[Solving Network Problems](#)

[Solving Copying Problems](#)

[Solving Paper Problems](#)

[Solving Problems Printing from a Computer](#)

[Solving Page Layout and Content Problems](#)

[Solving Print Quality Problems](#)

[Solving Scanning Problems](#)

[Solving Scanned Image Quality Problems](#)

[Solving Faxing Problems](#)

[When to Uninstall Your Product Software](#)

[Where to Get Help](#)

Checking for Software Updates

Periodically, it's a good idea to check Epson's support website for free updates to your product software. You can select **Download the Latest Software** from the Home screen of this manual or visit Epson's driver download site ([U.S. downloads](#) or [Canadian downloads](#)).

- **Windows:** Your printer software automatically checks for updates. You can also manually update the software by selecting **Software Update** here:

- Accessing the Windows Desktop and right-clicking the product icon in the Windows taskbar
- On the **Maintenance** tab in the printer settings window

You can also update the software by selecting **EPSON Software Updater** in the **EPSON** or **EPSON Software** program group, accessible by the **Start** button, or on the **Start** or **Apps** screens, depending on your version of Windows.

- **OS X:** You can manually update the software by opening the **Applications > Epson Software** folder and selecting **EPSON Software Updater**.

Parent topic: [Solving Problems](#)

Product Status Messages

You can often diagnose problems with your product by checking the messages on its LCD screen. You can also check for errors by pressing the **i Status** button to display the Status Menu.

Note: If the screen is dark, press the screen to wake the product from sleep mode.

LCD screen message	Condition/solution
Paper jam	If paper is jammed in the product, follow the instructions in this guide to remove the jammed paper from the indicated area.
Printer error. Turn the power off and on again.	Turn the product off and then back on again. If the error continues, check for a paper jam. If there is no paper jam, contact Epson for support.
Maintenance box is at the end of its service life. You need to replace it.	You must replace the maintenance box to continue printing.
The phone line is connected to a different jack.	Make sure the phone cable is connected correctly and the phone line works.
Connect the phone line to the "LINE" jack.	
The phone line is not connected	
No dial tone detected.	Make sure the phone cable is connected correctly and the phone line works. If you connected the product to a PBX (Private Branch Exchange) phone line or Terminal Adapter, change the Line Type setting to PBX . If you still cannot send a fax, turn off the Dial Tone Detection setting. (Turning off the Dial Tone Detection setting may cause the product to drop the first digit of a fax number.)
Combination of IP address and subnet mask is invalid.	There is a problem with the network connection to your product.

LCD screen message	Condition/solution
Communication error	See the link below to the Error Code section in this manual.
Authentication error	
DNS error	
Recovery mode	An error has occurred during firmware updating. Connect your product using a USB cable and try downloading the Firmware Update from the Epson support site. If you still need help, contact Epson for support.

Parent topic: [Solving Problems](#)

Related references

[Paper Jam Problems Inside the Product](#)

[Paper Jam Problems in the Cassette](#)

[Paper Jam Problems in the Duplexer \(Rear Cover\)](#)

[Where to Get Help](#)

Related tasks

[Checking for Software Updates](#)

[Connecting a Telephone or Answering Machine](#)

Related topics

[Loading Paper](#)

[Wi-Fi or Wired Networking](#)

[Replacing Ink Cartridges and Maintenance Boxes](#)

Status Menu Error Codes

If a job does not complete successfully, you can check the error code. Press the **i Status** button, then select **Job History** and locate the incomplete job. Select the job to display the error code and additional information.

Code	Condition/solution
001	The product was turned off by a power failure.
101	Memory is full. Reduce the size of the print job.

Code	Condition/solution
102	Collated printing has failed due to a lack of available memory. Reduce the size of the print job or print one copy at a time.
103	Print quality was decreased due to a lack of available memory. If the quality of the printout is unacceptable, try simplifying the page by reducing the number of graphics or the number and size of the fonts.
104	Reverse printing has failed due to a lack of available memory. Reduce the data size of the print job.
107	User authentication failed and the job has been canceled. Contact your printer administrator.
108	Confidential job data was deleted when the product was turned off.
109	The received fax was already deleted.
110	The job was printed 1-sided because the loaded paper does not support 2-sided printing.
111	Short of available memory. Reduce the size of the print job.
201	The product's memory is full. You can send pages individually, or print received faxes and delete them to free up memory space.
202	The line was disconnected by the recipient's fax machine. Wait a moment, then try again.
203	The product cannot detect a dial tone. Make sure the phone cable is connected correctly and the phone line works. If you connected the product to a PBX (Private Branch Exchange) phone line or Terminal Adapter, change the Line Type setting to PBX . If you still cannot send a fax, turn off the Dial Tone Detection setting. (Turning off the Dial Tone Detection setting may cause the product to drop the first digit of a fax number.)
204	The recipient's fax machine is busy. Wait a moment, then try again.
205	The recipient's fax machine does not answer. Wait a moment, then try again.
206	The phone cable is incorrectly connected to the product's LINE and EXT ports. Connect the phone cable correctly.
207	The phone cable is not connected. Connect the phone cable.

Code	Condition/solution
208	The fax could not be sent to some of the specified recipients. Print a fax log to check which recipients failed to receive the fax. If the Save Failure Data setting is turned on, you can resend a fax from Job Monitor in the Status Menu.
301 401	There is not enough storage space available on the external memory device. Clear space on the device or use a different device.
302 402	The external memory device is write-protected. Disable write protection.
303	No folder is available for saving the scanned file. Create a folder or use a different memory device.
304 404	The external memory device has been removed. Reinsert the device.
305 405	An error occurred while saving data to an external memory device. Reinsert the memory device or use a different device.
306	The product's memory is full. Wait until current jobs are finished processing.
331	A communication error occurred while acquiring the destination list. Make sure the product is connected to the network correctly.
332	There is not enough space available for saving the scanned files in the specified folder.
333	The destination could not be found because the destination information was uploaded to the server before sending the scanned data. Select the destination again.
334	An error occurred while sending the scanned data.
341	A communication error has occurred. Make sure the product is connected to the computer or network correctly. Make sure you have installed Document Capture Pro or Document Capture. Make sure the Event Manager program is not being blocked by your firewall or security software.

Parent topic: [Solving Problems](#)

Related tasks

[Connecting a Telephone or Answering Machine](#)

[Selecting Advanced Fax Settings](#)

[Viewing a Fax on the LCD Screen](#)

[Printing Fax Reports](#)

Related topics

[Wi-Fi or Wired Networking](#)

[Sending Faxes](#)

Running a Product Check

Running a product check helps you determine if your product is operating properly.

1. Disconnect any interface cables connected to your product.
2. Load plain paper in the product.
3. Press the  home button, if necessary.
4. Select **Setup**.
5. Select **Maintenance**.

You see a screen like this:

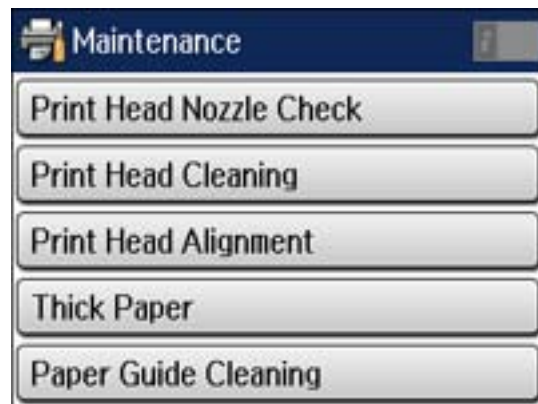

6. Select **Print Head Nozzle Check**.

You see a screen like this:

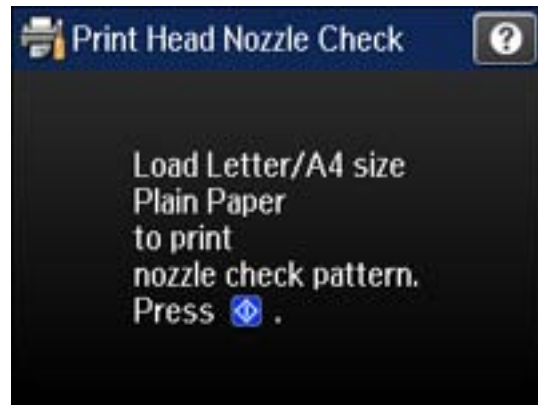

7. Press the  **Color** button.
The nozzle pattern prints.
8. Do one of the following, depending on the results of the product check:
 - If the page prints and the nozzle check pattern is complete, the product is operating properly. Any operation problem you may have could be caused by your computer, cable, software, or selected settings. Check the other solutions in this book or try uninstalling and reinstalling your printer software.
 - If the page prints but the nozzle check pattern has gaps, clean or align the print head.
 - If the page does not print, the product may have a problem. Check the other solutions in this manual. If they do not work, contact Epson.

Parent topic: [Solving Problems](#)

Related concepts

[Print Head Cleaning](#)

[Print Head Alignment](#)

[When to Uninstall Your Product Software](#)

Related references

[Where to Get Help](#)

Resetting Control Panel Defaults

If you have a problem with settings on the product control panel, you can reset them to their factory defaults. You can choose which settings to reset or reset them all.

Note: This setting can be locked by an administrator. If you cannot access or change this setting, contact your administrator for assistance.

1. Press the **⬆** home button, if necessary.
2. Select **Setup**.
3. Scroll down and select **System Administration**. Enter the administrator password, if necessary.
4. Scroll down and select **Restore Default Settings**.

You see a screen like this:



5. Select one of these options:
 - **Wi-Fi/Network Settings:** Resets all network settings.
 - **Copy Settings:** Resets all settings for copying.
 - **Scan Settings:** Resets all settings for scanning.
 - **Fax Settings:** Resets all settings for faxing.
 - **Clear All Data and Settings:** Resets all control panel settings including the contacts list.

You see a confirmation screen.

6. Select **Yes** to reset the selected settings. (Select **No** if you want to cancel the operation.)

Parent topic: [Solving Problems](#)

Solving Setup Problems

Check these sections if you have problems while setting up your product.

[Noise After Ink Installation](#)

[Software Installation Problems](#)

Parent topic: [Solving Problems](#)

Noise After Ink Installation

If you hear noises from your product after installing ink, check the following:

- The first time you install the ink cartridge, the product must prime its print head. Wait until priming finishes before you turn off the product, or it may prime improperly and use excess ink the next time you turn it on.
- If the product's print head stops moving or making noise, and the charging process has not finished after approximately 5 minutes, turn off your product. Turn it back on and check to see if charging is still in progress. If it is still in progress, contact Epson for help.

Parent topic: [Solving Setup Problems](#)

Software Installation Problems

If you have problems while installing your product software, try these solutions:

- Make sure your product is turned on and any necessary cables are securely connected at both ends. If you still have problems installing software, disconnect the cable and carefully follow the instructions on the *Start Here* sheet. Also make sure your system meets the requirements for your operating system.
- Close any other programs, including screen savers and virus protection software, and install your product software again.
- In Windows, make sure your product is selected as the default printer and the correct port is shown in the printer properties.
- If you see any error message or your software does not install correctly in Windows, you may not have software installation privileges. Contact your System Administrator.

Parent topic: [Solving Setup Problems](#)

Related concepts

[When to Uninstall Your Product Software](#)

Related references

[Windows System Requirements](#)

[OS X System Requirements](#)

Solving Network Problems

Check these solutions if you have problems setting up or using your product on a network.

Note: Breakdown or repair of this product may cause loss of fax and network data and settings. Epson is not responsible for backing up or recovering data and settings during or after the warranty period. We recommend that you make your own backup or print out your fax and network data and settings.

[Product Cannot Connect to a Wireless Router or Access Point](#)

[Network Software Cannot Find Product on a Network](#)

[Product Does Not Appear in OS X Printer Window](#)

[Cannot Print Over a Network](#)

[Cannot Scan Over a Network](#)

Parent topic: [Solving Problems](#)

Product Cannot Connect to a Wireless Router or Access Point

If your product has trouble finding or connecting to a wireless router or access point, try these solutions:

- If you are connecting the product via Wi-Fi Protected Setup (WPS) and the Wi-Fi icon on your product's LCD is not lit, make sure you select one of the WPS options from the product control panel within 2 minutes of pressing the WPS button on your router.
- Make sure to place your product within contact range of your router or access point.

Note: Avoid placing your product near a microwave oven, 2.4 GHz cordless phone, or large metal object, such as a filing cabinet.

- Verify that your router or access point is operating correctly by connecting to it from your computer or another device.
- You may need to disable the firewall and any anti-virus software on your wireless router or access point.
- Check to see if access restrictions, such as MAC address filtering, are set on the router or access point. If access restrictions are set, add your product's MAC address to your router's address list. To

obtain your product's MAC address, print a network status sheet. Then follow the instructions in your router or access point documentation to add the address to the list.

- If your router or access point does not broadcast its network name (SSID), follow the instructions that came with your product to enter your wireless network name manually.
- If your router or access point has security enabled, determine the kind of security it is using and any required password or passphrase for connection. Then make sure to enter the exact WEP key or WPA passphrase correctly.
- Check if your computer is restricting the available wireless channels. If so, verify that your wireless access point is using one of the usable channels and change to a usable channel, if necessary.
- If you are using a Wi-Fi Direct connection that suddenly disconnects, the Wi-Fi direct password on your device may have been changed. If necessary, delete the existing **DIRECT-xxxxxxx** connection settings from your device and enter a new password. See your device documentation for instructions.
- If you connected your product to a Windows computer using Wi-Fi Direct and it automatically selected Access Point Mode, you may have trouble accessing a low-priority Internet connection. Check the network connection or adapter settings in the Windows Control Panel and set the **Internet metric** setting to **100** for your version of the Internet Protocol.

Parent topic: [Solving Network Problems](#)

Related concepts

[Wi-Fi Direct Mode Setup](#)

Related tasks

[Printing a Network Status Sheet](#)

[Selecting Wireless Network Settings From the Control Panel](#)

Related topics

[Wi-Fi or Wired Networking](#)

Network Software Cannot Find Product on a Network

If EpsonNet Setup cannot find your product on a network, try these solutions:

- Make sure your product is turned on and connected to your network. Verify connection using your product control panel.
- Check if your network name (SSID) contains non-ASCII characters. Your product cannot display non-ASCII characters.
- If necessary, reinstall your product software and try running EpsonNet Setup again:
 1. Reset your product's network settings to their factory defaults.

2. Windows only: uninstall your product software.
3. Initialize your router following the instructions in your router documentation.

Note: If you are reading these instructions online, you will lose your internet connection when you initialize your router, so note the next step before initializing it.

4. Download your product software from the Epson website using the instructions on the *Start Here* sheet.
- If you have replaced your router, reinstall your product software to connect to the new router.

Parent topic: [Solving Network Problems](#)

Related concepts

[When to Uninstall Your Product Software](#)

Related topics

[Wi-Fi or Wired Networking](#)

Product Does Not Appear in OS X Printer Window

If your product does not appear in the OS X printer window, try these solutions:

- Turn your product off, wait 30 seconds, then turn it back on again.
- If you are connecting the product via Wi-Fi Protected Setup (WPS) and the Wi-Fi icon on your product's LCD is not lit, make sure you select one of the WPS options from the product control panel within 2 minutes of pressing the WPS button on your router.
- If you are connecting the product wirelessly via EpsonNet Setup and the Wi-Fi icon does not appear lit on your LCD screen, make sure your product software was installed correctly. If necessary, reinstall your software.

Parent topic: [Solving Network Problems](#)

Related concepts

[When to Uninstall Your Product Software](#)

Cannot Print Over a Network

If you cannot print over a network, try these solutions:

- Make sure that your product is turned on.
- Make sure you install your product's network software as described in your product documentation.

- Print a network status sheet and verify that the network settings are correct. If the network status is **Disconnected**, check any cable connections and turn your product off and then on again.
- If you are using TCP/IP, make sure the product's IP address is set correctly for your network. If your network does not assign IP addresses using DHCP, set the IP address manually.
- Make sure your computer and product are both using the same wireless network.
- If network printing is slow, print a network status sheet and check the signal strength. If it is poor, place your product closer to your router or access point.

Note: Avoid placing your product near a microwave oven, 2.4 GHz cordless phone, or large metal object, such as a filing cabinet.

- Check to see if your wireless router or access point has an enabled Privacy Separator function that is preventing printing from a device over the network. See your router or access point documentation for instructions on disabling the Privacy Separator function.
- If you are connecting the product via Wi-Fi Protected Setup (WPS) and the Wi-Fi icon on your product's LCD is not lit, make sure you select one of the WPS options from the product control panel within 2 minutes of pressing the WPS button on your router.
- Check your wired LAN router or access point to see if the LED for the port to which your product is connected is on or flashing . If the link LED is off, try the following:
 - Make sure the Ethernet cable is securely connected to your product and to your router, access point, switch, or hub.
 - Try connecting your product to a different port or a different router, access point, switch, or hub.
 - Try connecting with a different Ethernet cable.
 - Try printing to your product from another computer on the network.
- If you are connecting the product via EpsonNet Setup and the Wi-Fi icon does not appear lit on the LCD, make sure your product software was installed correctly. If necessary, reinstall your software.

Parent topic: [Solving Network Problems](#)

Related concepts

[When to Uninstall Your Product Software](#)

Related tasks

[Printing a Network Status Sheet](#)

Related topics

[Wi-Fi or Wired Networking](#)

Cannot Scan Over a Network

If you cannot start Epson Scan for scanning over a network, try these solutions:

- If you cannot scan from your product control panel, make sure you restarted your computer after installing the product software. Make sure the Event Manager program is not being blocked by your firewall or security software.
- If you are scanning a large original at a high resolution, a network communication error may occur. Try scanning again at a lower resolution.
- If network communication was interrupted while starting Epson Scan, exit Epson Scan, wait a few seconds, and restart it. If Epson Scan cannot restart, turn off your product, turn it back on, and try restarting Epson Scan again.
- Check the connection setting and test the connection using Epson Scan Settings:

Windows 8.x: Navigate to the **Apps** screen and select **EPSON Scan Settings**. Make sure the **Connection** setting is set to **Network**, then click the **Test** button.

Windows (other versions): Click  or **Start > All Programs** or **Programs > EPSON > EPSON Scan > EPSON Scan Settings**. Make sure the **Connection** setting is set to **Network**, then click the **Test** button.

OS X: Open the **Applications** folder, click **Epson Software**, and click **EPSON Scan Settings**. Make sure the **Connection** setting is set to **Network**, then click the **Test** button.

- Make sure the option selected as the **Timeout Setting** in the Epson Scan Settings program is long enough to complete scanning over a network.
- You may need to disable the firewall and any anti-virus software on your wireless router or access point.

Note: With OS X 10.6, 10.7, 10.8, or 10.9, in addition to scanning with Image Capture, you can download and install Epson Scan scanning software. Epson Scan provides additional image adjustment and photo correction features for enhancing scanned images, and provides an interface for TWAIN-compliant OCR scanning software, such as ABBYY FineReader. To download Epson Scan, visit Epson's driver download site ([U.S. downloads](#) or [Canadian downloads](#)).

Parent topic: [Solving Network Problems](#)

Related tasks

[Starting a Scan Using the Epson Scan Icon](#)

[Starting a Scan from a Scanning Program](#)

Solving Copying Problems

Check these solutions if you have problems copying with your product.

[Product Makes Noise, But Nothing Copies](#)

[Product Makes Noise When It Sits for a While](#)

Parent topic: [Solving Problems](#)

Product Makes Noise, But Nothing Copies

If your product makes a noise, but nothing copies, try these solutions:

- Run a nozzle check to see if any of the print head nozzles are clogged. Then clean the print head, if necessary.
- If the nozzle check page does not print, but the product's power is on, make sure your product software is installed correctly.
- Make sure your product is level (not tilted).

Parent topic: [Solving Copying Problems](#)

Related concepts

[Print Head Cleaning](#)

[Print Head Nozzle Check](#)

Product Makes Noise When It Sits for a While

Your product is performing routine maintenance. This is normal.

Parent topic: [Solving Copying Problems](#)

Solving Paper Problems

Check these sections if you have problems using paper with your product.

[Paper Feeding Problems](#)

[Paper Jam Problems Inside the Product](#)

[Paper Jam Problems in the Cassette](#)

[Paper Jam Problems in the Duplexer \(Rear Cover\)](#)

[Document Jams in the Automatic Document Feeder](#)

[Paper Ejection Problems](#)

Parent topic: [Solving Problems](#)

Paper Feeding Problems

If you have problems feeding paper, try these solutions:

- If paper does not feed for printing, remove it from the rear feed slot or cassette. Reload it, then adjust the edge guides. Make sure the paper stack is not above the tab on the edge guides inside the cassette or rear feed slot.
- If multiple pages feed at once, remove the paper, fan the edges to separate the sheets, and reload it.
- Do not load more than the recommended number of sheets.
- Make sure your paper meets the specifications for your product.
- If paper jams when you print on both sides of the paper, try loading fewer sheets.
- For best results, follow these guidelines:
 - Use new, smooth, high-quality paper that is not curled, creased, old, too thin, or too thick.
 - Load paper in the cassette printable side down.
 - Do not load binder paper with holes in the cassette.
 - Follow any special loading instructions that came with the paper.

Parent topic: [Solving Paper Problems](#)

Related references

[Paper Jam Problems Inside the Product](#)

[Paper Jam Problems in the Cassette](#)

[Paper Jam Problems in the Duplexer \(Rear Cover\)](#)

[Paper Loading Capacity](#)

Related topics

[Loading Paper](#)

Paper Jam Problems Inside the Product

If paper has jammed inside the product, follow the steps here to clear the jam.

1. Cancel the print job from your computer, if necessary.

2. Open the front cover.

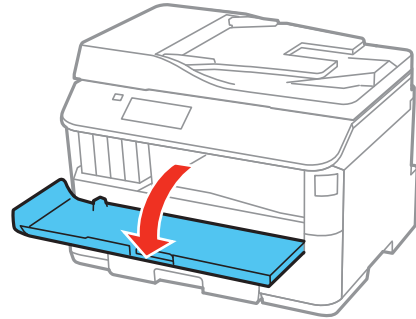

3. Remove any paper inside, including torn pieces.

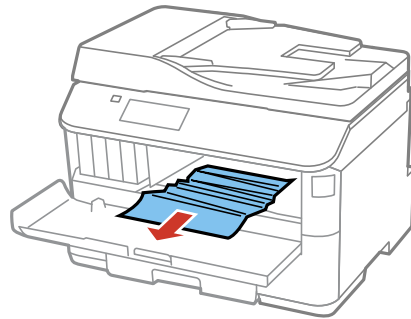

4. Close the front cover.

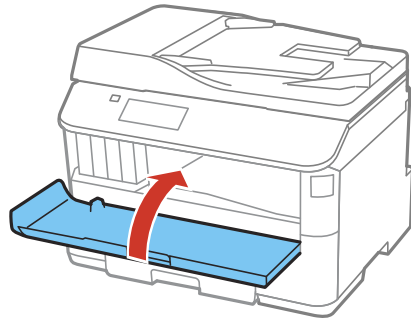

5. If any jammed paper remains near the output tray, carefully remove it.
6. Follow the prompts on the LCD screen to clear any error messages. If you still see a paper jam message, check the other paper jam solutions.

Parent topic: [Solving Paper Problems](#)

Related references

[Paper Jam Problems in the Cassette](#)

[Paper Jam Problems in the Duplexer \(Rear Cover\)](#)

[Document Jams in the Automatic Document Feeder](#)

Paper Jam Problems in the Cassette

If paper has jammed in the cassette, follow the steps here to clear the jam.

1. Cancel the print job, if necessary.
2. Close the output tray.
3. Pull out the paper cassette.

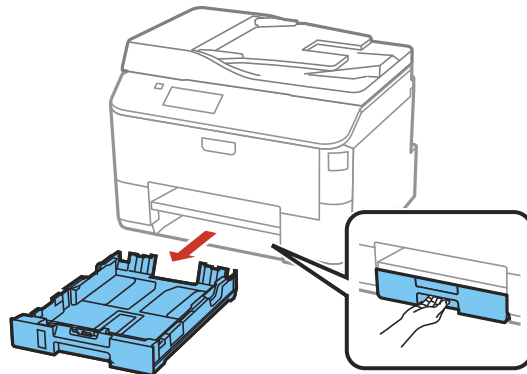

4. Carefully remove any paper jammed inside the product.



5. Carefully follow all paper loading instructions and reload the paper.
6. Keep the cassette flat as you gently insert it.

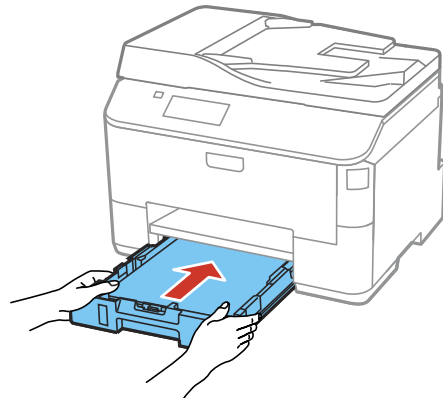

7. Follow the prompts on the LCD screen to clear any error messages. If you still see a paper jam message, check the other paper jam solutions.

Parent topic: [Solving Paper Problems](#)

Related references

[Paper Jam Problems Inside the Product](#)

[Paper Jam Problems in the Duplexer \(Rear Cover\)](#)

Paper Jam Problems in the Duplexer (Rear Cover)

If paper has jammed in the duplexer, follow the steps here to clear the jam.

1. Cancel the print job from your computer, if necessary.
2. Press the buttons on the sides of the rear cover and remove it.

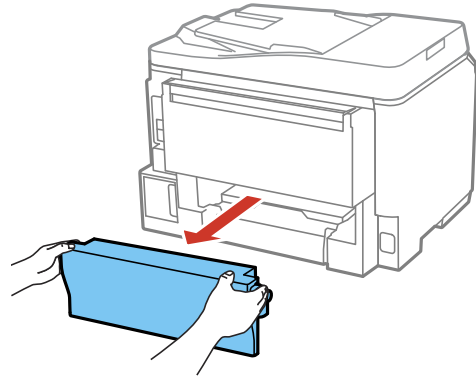

3. Carefully remove any jammed paper.

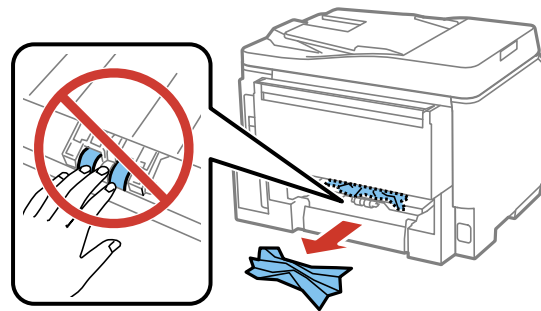

4. Remove any jammed paper from the duplexer.

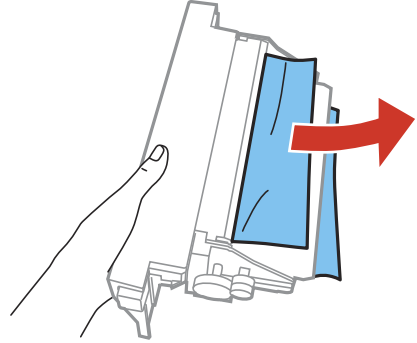

5. Press the buttons on the rear cover as you reattach it.

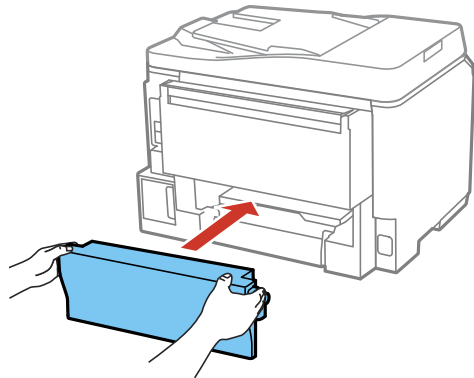

6. Follow the prompts on the LCD screen to clear any error messages. If you still see a paper jam message, check the other paper jam solutions.

Parent topic: [Solving Paper Problems](#)

Related references

[Document Jams in the Automatic Document Feeder](#)

[Paper Jam Problems Inside the Product](#)

[Paper Jam Problems in the Cassette](#)

Document Jams in the Automatic Document Feeder

If you have problems with document jams in the automatic document feeder (ADF), follow the steps here to clear the jam.

1. Cancel the print job, if necessary.
2. Remove your originals from the ADF.
3. Open the ADF cover.

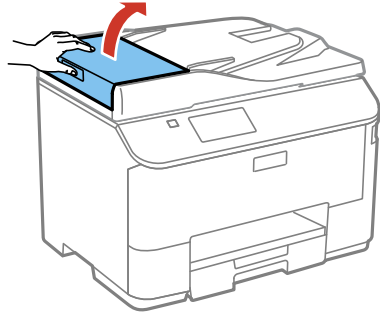

4. Carefully remove any jammed pages.

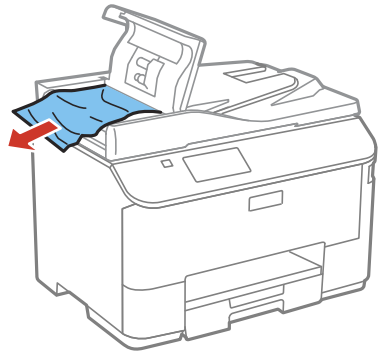

Caution: Make sure you open the ADF cover before removing any jammed paper. Otherwise the product may be damaged.

5. Close the ADF cover open, then raise the document cover.

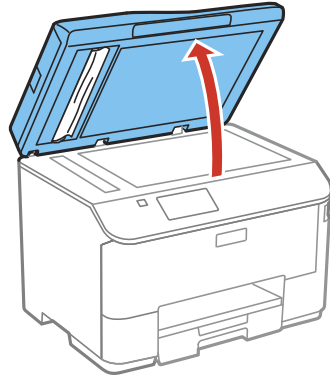

6. Carefully remove any jammed pages.

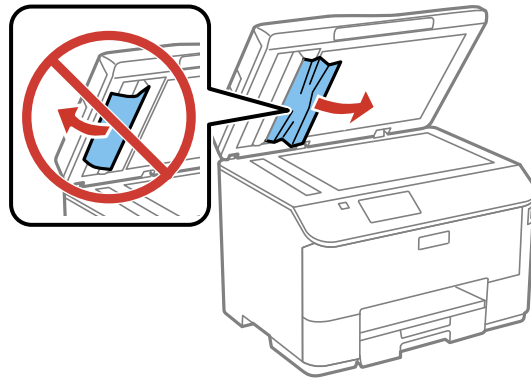

7. Lower the document cover.

8. Raise the ADF input tray.

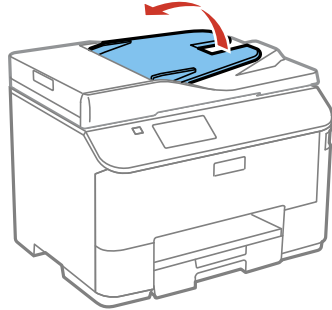

9. Carefully remove any jammed pages.

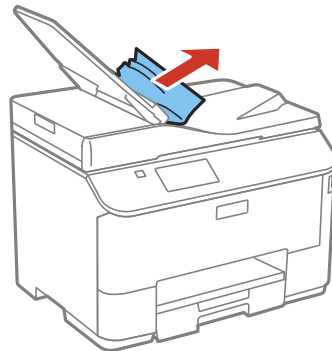

10. Lower the ADF input tray.

11. Reload your originals.

Caution: Make sure you do not load the ADF beyond its capacity for your paper size. Also make sure the originals you load are not bent, folded, or curled and do not have tape, staples, or other materials that could obstruct the feeder.

12. Follow the prompts on the LCD screen to clear any error messages. If you still see a paper jam message, check the other paper jam solutions.

Parent topic: [Solving Paper Problems](#)

Related references

[Paper Jam Problems in the Cassette](#)

[Paper Jam Problems Inside the Product](#)

[Paper Jam Problems in the Duplexer \(Rear Cover\)](#)

Related topics

[Loading Paper](#)

Paper Ejection Problems

If you have problems with paper ejecting properly, try these solutions:

- If paper does not eject fully, you may have set the wrong paper size. Cancel printing to eject the paper. Select the correct paper size when you reprint.
- If paper is wrinkled when it ejects, it may be damp or too thin. Load new paper and be sure to select the correct paper type setting when you reprint.

Parent topic: [Solving Paper Problems](#)

Related references

[Paper Type Settings](#)

[Paper Jam Problems in the Duplexer \(Rear Cover\)](#)

[Paper Jam Problems Inside the Product](#)

[Paper Jam Problems in the Cassette](#)

[Document Jams in the Automatic Document Feeder](#)

Related topics

[Loading Paper](#)

Solving Problems Printing from a Computer

Check these sections if you have problems while printing from your computer.

Note: When printing using AirPrint, the available print settings are different from those covered in this manual. See the Apple website for details.

[Nothing Prints](#)

[Product Icon Does Not Appear in Windows Taskbar](#)

[Printing is Slow](#)

Parent topic: [Solving Problems](#)

Nothing Prints

If you have sent a print job and nothing prints, try these solutions:

- Make sure your product is turned on.
- Make sure any interface cables are connected securely at both ends.
- If you connected your product to a USB hub, make sure it is a first-tier hub. If it still does not print, connect your product directly to your computer instead of the hub.
- Run a product check to see if a test page prints. If the test page prints, check to see if your product software is installed correctly.
- In Windows, make sure your product is selected as the default printer.
- In Windows, clear any stalled print jobs from the Windows Spooler:
 - **Windows 8.x:** Navigate to the **Apps** screen and select **Control Panel > Hardware and Sound > Devices and Printers**. Right-click your product name, select **See what's printing**, and select your product name again if necessary. Right-click the stalled print job, click **Cancel**, and click **Yes**.
 - **Windows 7:** Click  and select **Devices and Printers**. Right-click your product name, select **See what's printing**, and select your product name again, if necessary. Right-click the stalled print job, click **Cancel**, and click **Yes**.
 - **Windows Vista:** Click  and select **Control Panel**. Click **Printer** under **Hardware and Sound**, right-click your product name, and select **Open**. Right click the stalled print job, click **Cancel**, and click **Yes**.
 - **Windows XP:** Click **Start** and select **Printers and Faxes**. (Or open the **Control Panel**, select **Printers and Other Hardware**, if necessary, and select **Printers and Faxes**.) Right-click your product name, select **Open**, right-click the stalled print job, click **Cancel**, and click **Yes**.

Parent topic: [Solving Problems Printing from a Computer](#)



Related references

[Printing is Slow](#)

Product Icon Does Not Appear in Windows Taskbar

If you do not see your product icon in the Windows taskbar, first try restarting your computer. If that does not work, try this solution:

1. Do one of the following:
 - **Windows 8.x:** Navigate to the **Apps** screen and select **Control Panel > Hardware and Sound > Devices and Printers**.

- **Windows 7:** Click  and select **Devices and Printers**.
 - **Windows Vista:** Click , select **Control Panel**, and click **Printer** under **Hardware and Sound**.
 - **Windows XP:** Click **Start** and select **Printers and Faxes**. (Or open the **Control Panel**, select **Printers and Other Hardware**, if necessary, and **Printers and Faxes**.)
2. Right-click your product name, select **Printing Preferences**, and select your product name again if necessary.
 3. Click the **Maintenance** tab.
 4. Click the **Extended Settings** button.
 5. Select **Enable EPSON Status Monitor 3**, then click **OK**.
 6. Click the **Monitoring Preferences** button.
 7. Click the checkbox for the option that adds the shortcut icon to the taskbar.
 8. Click **OK** to close the open program windows.

Parent topic: [Solving Problems Printing from a Computer](#)

Printing is Slow

If printing becomes slow, try these solutions:

- Make sure your system meets the requirements for your operating system. If you are printing a high-resolution image, you may need more than the minimum requirements. If necessary, increase your system's memory.
- If you are using Windows 7, close the **Devices and Printers** window before you print.
- Clear space on your hard drive or run a defragmentation utility to free up existing space.
- Close any programs you are not using when you print.
- If your product is connected to a USB hub, connect it directly to your computer instead.
- If printing becomes slower after printing continuously for a long time, the product may have automatically slowed down to protect the print mechanism from overheating or becoming damaged. Let the product rest with the power on for 30 minutes, then try printing again.

For the fastest printing, select the following settings in your product software:

- Make sure the paper type setting matches the type of paper you loaded.
- Turn on any high speed settings in your product software.
- Select a lower print quality setting.

- Make sure the ink drying time has not been increased for double-sided printing.
- **Windows:** Click the **Maintenance** tab, select **Extended Settings**, and select the following settings:
 - **High Speed Copies**
 - **Always Spool RAW Datatype**
 - **Page Rendering Mode**
 - **Print as Bitmap**

Parent topic: [Solving Problems Printing from a Computer](#)

Related references

[Paper Type Settings](#)

[Windows System Requirements](#)

[OS X System Requirements](#)

Related tasks

[Selecting Basic Print Settings - Windows](#)

[Selecting Extended Settings - Windows](#)

[Selecting Basic Print Settings - OS X](#)

Solving Page Layout and Content Problems

Check these sections if you have problems with the layout or content of your printed pages.

Note: When printing using AirPrint, the available print settings are different from those covered in this manual. See the Apple website for details.

[Inverted Image](#)

[Too Many Copies Print](#)

[Blank Pages Print](#)

[Incorrect Margins on Printout](#)

[Incorrect Characters Print](#)

[Incorrect Image Size or Position](#)

[Slanted Printout](#)

Parent topic: [Solving Problems](#)

Inverted Image

If your printed image is inverted unexpectedly, try these solutions:

- Turn off any mirror or inversion settings in your printing application.
- Turn off the **Mirror Image**, **Flip horizontally**, or **Reverse page orientation** settings in your printer software. (This option has different names, depending on your operating system version.)

Note: Leave these options turned on when you print on Epson Iron-on Cool Peel Transfer paper, if available for your product.

Parent topic: [Solving Page Layout and Content Problems](#)

Related tasks

[Selecting Basic Print Settings - OS X](#)

[Selecting Additional Layout and Print Options - Windows](#)

Too Many Copies Print

Make sure that the **Copies** setting in your printing program or printer software is not set for multiple copies.

Parent topic: [Solving Page Layout and Content Problems](#)

Related tasks

[Selecting Basic Print Settings - Windows](#)

[Selecting Basic Print Settings - OS X](#)

Blank Pages Print

If blank pages print unexpectedly, try these solutions:

- Make sure you selected the correct paper size settings in your printing program and printer software.
- If a blank page exists in a document you are printing and you want to skip printing it, select the **Skip Blank Page** setting in your printer software.
- Run a print head nozzle check to see if any of the nozzles are clogged. Then clean the print head, if necessary.
- Make sure your product is selected as the printer in your printing program.

Parent topic: [Solving Page Layout and Content Problems](#)

Related concepts

[Print Head Cleaning](#)

[Print Head Nozzle Check](#)

Related tasks

[Selecting Extended Settings - Windows](#)

[Selecting Basic Print Settings - OS X](#)

[Selecting Basic Print Settings - Windows](#)

Incorrect Margins on Printout

If your printed page has incorrect margins, try these solutions:

- Make sure you selected the correct paper size settings in your printing program and printer software.
- Make sure you selected the correct margins for your paper size in your printing program.
- Make sure your paper is positioned correctly for feeding into the printer.

You can use the preview option in your printer software to check your margins before you print.

Parent topic: [Solving Page Layout and Content Problems](#)

Related tasks

[Selecting Basic Print Settings - OS X](#)

[Selecting Basic Print Settings - Windows](#)

Related topics

[Loading Paper](#)

Incorrect Characters Print

If incorrect characters appear in your prints, try these solutions before reprinting:

- Make sure any cables are securely connected at both ends.
- In Windows, delete all print jobs from the Windows Spooler:
 - **Windows 8.x:** Navigate to the **Apps** screen and select **Control Panel > Hardware and Sound > Devices and Printers**. Right-click your product name, select **See what's printing**, and select your product name again, if necessary. Right-click the stalled print job, click **Cancel**, and click **Yes**.
 - **Windows 7:** Click  and select **Devices and Printers**. Right-click your product name, select **See what's printing**, and select your product name again, if necessary. Right-click the stalled print job, click **Cancel**, and click **Yes**.

- **Windows Vista:** Click  and select **Control Panel**. Click **Printer** under **Hardware and Sound**, right-click your product name, and select **Open**. Right click the stalled print job, click **Cancel**, and click **Yes**.
- **Windows XP:** Click **Start** and select **Printers and Faxes**. (Or open the **Control Panel**, select **Printers and Other Hardware** if necessary, and select **Printers and Faxes**.) Right-click your product name, select **Open**, right-click the stalled print job, click **Cancel**, and click **Yes**.
- If your product is connected to a USB hub, connect it directly to your computer instead.
- If incorrect characters still appear in your prints, try connecting your product using a different cable.

Parent topic: [Solving Page Layout and Content Problems](#)

Incorrect Image Size or Position

If your printed image is the wrong size or in the wrong position, try these solutions:

- Make sure you selected the correct paper size and layout settings in your printing program and printer software.
- Make sure your paper is positioned correctly for feeding into the printer.

You can use the preview option in your printer software to check your margins before you print.

Parent topic: [Solving Page Layout and Content Problems](#)

Related tasks

[Selecting Basic Print Settings - OS X](#)

[Selecting Basic Print Settings - Windows](#)

[Selecting Additional Layout and Print Options - Windows](#)

[Selecting Page Setup Settings - OS X](#)

Slanted Printout

If your printouts are slanted, try these solutions:

- Slide the edge guides against the edges of the paper.
- Select a higher print quality setting in your printer software.
- Turn off any high speed settings in your product software.
- Align the print head.
- Make sure the product is not printing while tilted or at an angle.

Parent topic: [Solving Page Layout and Content Problems](#)

Related tasks

[Selecting Basic Print Settings - OS X](#)

[Selecting Basic Print Settings - Windows](#)

Related topics

[Loading Paper](#)

Solving Print Quality Problems

Check these sections if your printouts have problems with print quality, but your image looks fine on your computer screen.

Note: When printing using AirPrint, the available print settings are different from those covered in this manual. See the Apple website for details.

[White or Dark Lines in Printout](#)

[Blurry or Smearred Printout](#)

[Faint Printout or Printout Has Gaps](#)

[Grainy Printout](#)

[Incorrect Colors](#)

Parent topic: [Solving Problems](#)

White or Dark Lines in Printout

If you notice white or dark lines in your prints (also called banding), try these solutions before you reprint:

- Run a nozzle check to see if any of the print head nozzles are clogged. Then clean the print head, if necessary.
- Make sure the paper type setting matches the type of paper you loaded.
- Make sure you loaded the printable side of the paper correctly for your product.
- Turn off any high speed settings in your product software.
- Align the print head.
- You may need to replace the ink cartridges.

Parent topic: [Solving Print Quality Problems](#)

Related concepts

[Print Head Nozzle Check](#)

[Print Head Cleaning](#)

[Print Head Alignment](#)

Related references

[Paper Type Settings](#)

Related tasks

[Selecting Additional Layout and Print Options - Windows](#)

Related topics

[Loading Paper](#)

[Replacing Ink Cartridges and Maintenance Boxes](#)

Blurry or Smearred Printout

If your printouts are blurry or smearred, try these solutions:

- Make sure your paper is not damp, curled, old, or loaded incorrectly in your product.
- Use a support sheet with special paper, or load special paper one sheet at a time.
- Make sure your paper meets the specifications for your product.
- Use Epson papers to ensure proper saturation and absorption of genuine Epson inks.
- Make sure the paper type setting in your product software matches the type of paper you loaded.
- If you are printing on thick paper or envelopes, turn on the **Thick Paper** setting from the control panel or select **Thick Paper and Envelopes** in the Extended Settings of the printer software. (Turning this setting on will decrease print speed.)
- Remove each sheet from the output tray as it is printed.
- Avoid handling printouts on glossy paper right after printing to allow the ink to set.
- Turn off any high speed settings in your product software.
- If you print on both sides of a sheet of paper, smudges may appear on the reverse side of heavily saturated or dark images. If one side of a sheet will contain a lighter image or text, print that side first. Adjust the **Print Density** and/or **Increase Ink Drying Time** settings.
- Run a nozzle check to see if any of the print head nozzles are clogged. Then clean the print head, if necessary.
- Align the print head.
- Clean the paper path.

Note: Your product will not operate properly while tilted at an angle. Place it on a flat, stable surface that extends beyond the base of the product in all directions.

Parent topic: [Solving Print Quality Problems](#)

Related concepts

[Print Head Cleaning](#)

[Print Head Alignment](#)

Related references

[Available Epson Papers](#)

[Paper Specifications](#)

Related tasks

[Cleaning the Paper Guide](#)

[Selecting Basic Print Settings - Windows](#)

[Selecting Double-sided Printing Settings - Windows](#)

[Selecting Additional Layout and Print Options - Windows](#)

[Selecting Basic Print Settings - OS X](#)

[Selecting Double-sided Printing Settings - OS X](#)

[Selecting Printing Preferences - OS X](#)

Related topics

[Loading Paper](#)

Faint Printout or Printout Has Gaps

If your printouts are faint or have gaps, try these solutions:

- Run a nozzle check to see if any of the print head nozzles are clogged. Then clean the print head, if necessary.
- The ink cartridges may be old or low on ink, and you may need to replace them.
- Make sure the paper type setting matches the type of paper you loaded.
- Make sure your paper is not damp, curled, old, or loaded incorrectly in your product.
- Align the print head.
- Clean the paper path.

Parent topic: [Solving Print Quality Problems](#)

Related concepts

[Print Head Nozzle Check](#)

[Print Head Cleaning](#)

[Print Head Alignment](#)

Related references

[Paper Type Settings](#)

Related tasks

[Cleaning the Paper Guide](#)

[Selecting Basic Print Settings - Windows](#)

[Selecting Basic Print Settings - OS X](#)

Related topics

[Loading Paper](#)

[Replacing Ink Cartridges and Maintenance Boxes](#)

Grainy Printout

If your printouts are grainy, try these solutions:

- Make sure you loaded the printable side of the paper correctly for your product.
- Select a higher print quality setting and turn off any high speed settings in your product software.
- Run a nozzle check to see if any of the print head nozzles are clogged. Then clean the print head, if necessary.
- Align the print head.
- You may need to increase the image resolution or print a smaller size; see your software documentation.
- If you enlarged the image in an image-editing program, you need to increase the resolution setting to retain a high image quality. Increase the resolution by the same amount you increased the image size. For example, if the resolution is 300 dpi (dots per inch) and you will double the image size later, change the resolution setting to 600 dpi.

Note: Higher resolution settings result in larger file sizes, which take longer to process and print. Consider the limitations of your computer system when selecting a resolution, and select the lowest possible resolution that produces acceptable quality to keep file sizes manageable.

Parent topic: [Solving Print Quality Problems](#)

Related concepts

[Print Head Nozzle Check](#)

[Print Head Cleaning](#)

[Print Head Alignment](#)

Related references

[Paper Type Settings](#)

Related tasks

[Cleaning the Paper Guide](#)

[Selecting Basic Print Settings - Windows](#)

[Selecting Basic Print Settings - OS X](#)

[Selecting Additional Layout and Print Options - Windows](#)

[Selecting Printing Preferences - OS X](#)

Related topics

[Loading Paper](#)

[Replacing Ink Cartridges and Maintenance Boxes](#)

Incorrect Colors

If your printouts have incorrect colors, try these solutions:

- Make sure the **Black/Grayscale** or **Grayscale** setting is not selected in your printer software.
- Run a nozzle check to see if any of the print head nozzles are clogged. Then clean the print head, if necessary.
- The ink cartridges may be old or low on ink, and you may need to replace them.
- Your printed colors can never exactly match your on-screen colors. However, you can use a color management system to get as close as possible. Try using the color management options in your printer software.
- For best results, use genuine Epson ink and paper.

Parent topic: [Solving Print Quality Problems](#)

Related concepts

[Print Head Nozzle Check](#)

[Print Head Cleaning](#)

Related references

[Available Epson Papers](#)

Related tasks

[Selecting Basic Print Settings - Windows](#)

[Selecting Basic Print Settings - OS X](#)

[Selecting Additional Layout and Print Options - Windows](#)

[Managing Color - OS X](#)

Related topics

[Replacing Ink Cartridges and Maintenance Boxes](#)

Solving Scanning Problems

Check these solutions if you have problems scanning with your product.

[Scanning Software Does Not Operate Correctly](#)

[Cannot Start Epson Scan](#)

Parent topic: [Solving Problems](#)

Scanning Software Does Not Operate Correctly

If your scanning software does not operate correctly, try these solutions:

- Make sure your computer has adequate memory and meets the system requirements for your operating system.
- Make sure your computer is not running in a power-saving mode, such as sleep or standby. If so, wake your system and restart your scanning software.
- If you upgraded your operating system but did not reinstall your scanning software, try reinstalling it.

Note: With OS X 10.6, 10.7, 10.8, or 10.9, in addition to scanning with Image Capture, you can download and install Epson Scan scanning software. Epson Scan provides additional image adjustment and photo correction features for enhancing scanned images, and provides an interface for TWAIN-compliant OCR scanning software, such as ABBYY FineReader. To download Epson Scan, visit Epson's driver download site ([U.S. downloads](#) or [Canadian downloads](#)).

Parent topic: [Solving Scanning Problems](#)

Related concepts

[When to Uninstall Your Product Software](#)

Related references

[Windows System Requirements](#)

[OS X System Requirements](#)

Related tasks

[Scanning with OS X Using Image Capture](#)

Cannot Start Epson Scan

If you cannot start Epson Scan, try these solutions:

- Make sure your product is turned on and any interface cables are securely connected at both ends.
- Make sure Epson Scan is selected in your scanning program.
- Make sure your computer is not running in a power-saving mode, such as sleep or standby. If so, wake your system and restart Epson Scan.
- Check the connection setting and test the connection using Epson Scan Settings:

Windows 8.x: Navigate to the **Apps** screen and select **EPSON Scan Settings**. Make sure the correct **Connection** setting is selected, then click the **Test** button.

Windows (other versions): Click  or **Start > All Programs** or **Programs > EPSON > EPSON Scan > EPSON Scan Settings**. Make sure the correct **Connection** setting is selected, then click the **Test** button.

OS X: Open the **Applications** folder, click **Epson Software**, and click **EPSON Scan Settings**. Make sure the correct **Connection** setting is selected, then click the **Test** button.

- Make sure you do not have multiple versions of Epson Scan installed. If you do, uninstall both versions and install one version.
- If you upgraded your operating system but did not reinstall Epson Scan, try reinstalling it.

Note: With OS X 10.6, 10.7, 10.8, or 10.9, in addition to scanning with Image Capture, you can download and install Epson Scan scanning software. Epson Scan provides additional image adjustment and photo correction features for enhancing scanned images, and provides an interface for TWAIN-compliant OCR scanning software, such as ABBYY FineReader. To download Epson Scan, visit Epson's driver download site ([U.S. downloads](#) or [Canadian downloads](#)).

Parent topic: [Solving Scanning Problems](#)

Related tasks

[Scanning with OS X Using Image Capture](#)

[Starting a Scan with Document Capture Pro or Document Capture](#)

[Starting a Scan Using the Epson Scan Icon](#)

Solving Scanned Image Quality Problems

Check these sections if a scanned image on your computer screen has a quality problem.

[Image Consists of a Few Dots Only](#)

[Line of Dots Appears in All Scanned Images](#)

[Straight Lines in an Image Appear Crooked](#)

[Image is Distorted or Blurry](#)

[Image Colors are Patchy at the Edges](#)

[Image is Too Dark](#)

[Back of Original Image Appears in Scanned Image](#)

[Ripple Patterns Appear in an Image](#)

[Scanned Image Colors Do Not Match Original Colors](#)

[Scan Area is Not Adjustable in Thumbnail Preview](#)

[Scanned Image Edges are Cropped](#)

Parent topic: [Solving Problems](#)

Image Consists of a Few Dots Only

If your scanned image consists only of a few dots, try these solutions:

- Make sure you placed your original for scanning facing the correct way.
- If you are scanning using the Epson Scan **Black & White** setting, adjust the **Threshold** setting and scan again.

Parent topic: [Solving Scanned Image Quality Problems](#)

Related references

[Available Image Adjustments - Professional Mode](#)

[Available Image Adjustments - Office Mode](#)

Related topics

[Placing Originals on the Product](#)

Line of Dots Appears in All Scanned Images

If a line of dots appears in all your scanned images, clean the scanner glass with a soft, dry, lint-free cloth or use a small amount of glass cleaner on the cloth, if necessary. Paper towels are not recommended.

Caution: Do not spray glass cleaner directly on the scanner glass.

Parent topic: [Solving Scanned Image Quality Problems](#)

Related tasks

[Cleaning Your Product](#)

Straight Lines in an Image Appear Crooked

If straight lines in an original appear crooked in a scanned image, make sure to place your original straight when you scan it.

Parent topic: [Solving Scanned Image Quality Problems](#)

Related topics

[Placing Originals on the Product](#)

Image is Distorted or Blurry

If a scanned image appears distorted or blurry, try these solutions:

- Make sure your original is not wrinkled or warped. This may prevent the original from laying flat on the scanner glass.
- Do not move your original or your product during scanning.
- Your product will not operate properly while tilted at an angle. Place it on a flat, stable surface that extends beyond the base of the product in all directions.
- Adjust these Epson Scan settings (if available) and try scanning again:
 - Select the **Unsharp Mask** setting.
 - Adjust the **Auto Exposure** setting.
 - Increase the **Resolution** setting.

Parent topic: [Solving Scanned Image Quality Problems](#)

Related topics

[Selecting Epson Scan Settings](#)

Image Colors are Patchy at the Edges

If you are scanning a thick or warped original, cover its edges with paper to block external light as you scan it.

Parent topic: [Solving Scanned Image Quality Problems](#)

Image is Too Dark

If your scanned image is too dark, try these solutions:

- Adjust these Epson Scan settings (if available) and try scanning again:
 - **Auto Exposure**
 - **Brightness**
 - **Histogram Adjustment**
- Check the brightness and contrast settings of your computer monitor.

Parent topic: [Solving Scanned Image Quality Problems](#)

Related topics

[Selecting Epson Scan Settings](#)

Back of Original Image Appears in Scanned Image

If an image from the back of a thin original appears in your scanned image, place a piece of black paper on the back of the original and scan it again.

Parent topic: [Solving Scanned Image Quality Problems](#)

Ripple Patterns Appear in an Image

You may see a ripple pattern (called a moiré) in scanned images of printed documents. This is caused by interference from differing pitches in the scanner's screen and your original's halftone screen. To reduce this effect, adjust these Epson Scan settings (if available) and try scanning again:

- Select the **Descreening** setting.
- Select a lower **Resolution** setting.

Parent topic: [Solving Scanned Image Quality Problems](#)

Related topics

[Selecting Epson Scan Settings](#)

Scanned Image Colors Do Not Match Original Colors

Printed colors can never exactly match the colors on your computer monitor because printers and monitors use different color systems: monitors use RGB (red, green, and blue) and printers typically use CMYK (cyan, magenta, yellow, and black).

Check the color matching and color management capabilities of your computer, display adapter, and the software you are using to see if they are affecting the palette of colors you see on your screen.

To adjust the colors in your scanned image, adjust these Epson Scan settings (if available) and try scanning again:

- Change the **Image Type** setting and experiment with different combinations of the next settings.
- Adjust the **Tone Correction** setting.
- Adjust the **Auto Exposure** setting.

Parent topic: [Solving Scanned Image Quality Problems](#)

Related topics

[Selecting Epson Scan Settings](#)

Scan Area is Not Adjustable in Thumbnail Preview

If you cannot adjust the scan area while viewing a Thumbnail preview in Epson Scan, try these solutions:

- Create a scan area by drawing a marquee on your preview image and adjusting it as necessary.
- Switch to Normal preview mode, if available, and preview your image again.

Parent topic: [Solving Scanned Image Quality Problems](#)

Related concepts

[Image Preview Guidelines](#)

Related tasks

[Selecting a Scan Area - Office Mode](#)

[Selecting a Scan Area - Professional Mode](#)

Scanned Image Edges are Cropped

If the edges of a scanned image are cropped, make sure your original is placed correctly for scanning. If necessary, move your original away from the edges of the scanner glass slightly.

Parent topic: [Solving Scanned Image Quality Problems](#)

Related topics

[Placing Originals on the Product](#)

Solving Faxing Problems

Check these solutions if you have problems faxing with your product.

[Cannot Send or Receive Faxes](#)

[Cannot Receive Faxes with a Telephone Connected to Your Product](#)

Cannot Send or Receive Faxes

If you cannot send or receive faxes, try these solutions:

- Make sure the recipient's fax machine is turned on and working.
- Make sure paper is loaded correctly in your product.
- Make sure you have set up your header information and have not blocked your caller ID. Otherwise, your faxes might be rejected by the recipient's fax machine.
- Make sure Receive Mode is set to **Auto** so you can receive faxes automatically.
- Check that the cable connecting your telephone wall jack to your product's **LINE** port is secure.
- Print a fax connection report using your product control panel or fax software to help diagnose the problem.
- Verify that the telephone wall jack works by connecting a phone to it and testing it.
- If there is no dial tone and you connected the product to a PBX (Private Branch Exchange) phone line or Terminal Adapter, change the **Line Type** setting to **PBX**. If you still cannot send a fax, turn off the turn off the product's dial tone detection setting. (Turning off the dial tone setting may cause the product to drop the first digit of a fax number.)
- If you connected your product to a DSL phone line, you must connect a DSL filter to the phone jack to enable faxing over the line. Contact your DSL provider for the necessary filter.
- If your telephone line has static, turn off your product's error correction mode fax communication setting and try faxing again.
- Try lowering your product's fax speed setting.
- Make sure the error correction mode (ECM) setting is turned on if you are trying to send or receive a color fax.
- If your telephone line uses call waiting and you have trouble receiving faxes, turn off call waiting to prevent disruption of incoming faxes.

Note: If your product is connected to a VoIP (Voice over Internet Protocol) phone line, keep in mind that fax machines are designed to work over analog phone lines. Epson cannot guarantee that fax transmission will work when using VoIP.

If your phone line includes voice mail answering services, calls or faxes may be inadvertently received by your voice mail service.

Parent topic: [Solving Faxing Problems](#)

Related tasks

[Connecting a Telephone or Answering Machine](#)

[Using the Fax Setup Wizard](#)

[Selecting the Line Type](#)

[Selecting Advanced Fax Settings](#)

[Selecting Advanced Fax Settings](#)

[Printing Fax Reports](#)

[Printing Fax Reports](#)

[Receiving Faxes Automatically](#)

Related topics

[Loading Paper](#)

Cannot Receive Faxes with a Telephone Connected to Your Product

If you cannot receive faxes when a telephone is connected to your product, try these solutions:

- Make sure your telephone is connected to your product's **EXT** port.
- Make sure the Receive Mode is set to **Manual**.

Note: When answering a call that is a fax, wait until the product's LCD screen displays a message that a connection has been made before you hang up.

Parent topic: [Solving Faxing Problems](#)

Related tasks

[Using the Fax Setup Wizard](#)

[Connecting a Telephone or Answering Machine](#)

When to Uninstall Your Product Software

If you have a problem that requires you to uninstall and re-install your software, follow the instructions for your operating system.

[Uninstalling Product Software - Windows](#)

[Uninstalling Product Software - OS X](#)

Parent topic: [Solving Problems](#)

Uninstalling Product Software - Windows

You can uninstall and then re-install your product software to solve certain problems.

1. Turn off the product.
2. Disconnect any interface cables.
3. Do one of the following:
 - **Windows 8.x:** Navigate to the **Apps** screen and select **Control Panel > Programs > Programs and Features**. Select the uninstall option for your Epson product, then select **Uninstall/Change**.

Note: If you see a **User Account Control** window, click **Yes** or **Continue**.

Select your product again, if necessary, then select **OK**, and click **Yes** to confirm the uninstallation.

- **Windows (other versions):** Click  or **Start**, and select **All Programs** or **Programs**. Select **EPSON**, select your product, then click **EPSON Printer Software Uninstall**.

Note: If you see a **User Account Control** window, click **Yes** or **Continue**.

In the next window, select your product and click **OK**. Then follow any on-screen instructions.

4. Do one of the following to uninstall Epson Event Manager, then follow any on-screen instructions:
 - **Windows 8.x:** Select **Epson Event Manager** and click **Uninstall**.
 - **Windows 7 or Windows Vista:** Open the Windows **Control Panel** utility. Select **Programs and Features**. (In Classic view, select **Programs** and click **Uninstall a program**.) Select **Epson Event Manager** and click **Uninstall/Change**.
 - **Windows XP:** Open the Windows **Control Panel** utility. Double-click **Add or Remove Programs**. Select **Epson Event Manager** and click **Change/Remove**.
5. Do one of the following to uninstall Epson Scan, then follow any on-screen instructions:
 - **Windows 8.x, Windows 7, or Windows Vista:** Select **EPSON Scan** and click **Uninstall/Change**.
 - **Windows XP:** Select **EPSON Scan** and click **Change/Remove**.
6. Restart your computer, then see the *Start Here* sheet to re-install your software.

Note: If you find that re-installing your product software does not solve a problem, contact Epson.

Parent topic: [When to Uninstall Your Product Software](#)

Uninstalling Product Software - OS X

In most cases, you do not need to uninstall your product software before re-installing it. However, you can download the Uninstaller utility from the Epson support website to uninstall your product software as described here.

Note: If you find that re-installing your product software does not solve a problem, contact Epson.

1. To download the Uninstaller utility, visit the Epson download site ([U.S. downloads](#) or [Canadian downloads](#)).
2. Follow the instructions on the screen to install the Uninstaller utility.
3. Quit all applications currently running on your Mac.
4. Double-click the **Uninstaller** icon.
5. Select the checkbox for each software program you want to uninstall.
6. Click **Uninstall**.
7. Follow the on-screen instructions to uninstall the software.
8. To reinstall your product software, see the *Start Here* sheet for instructions.

Note: If you uninstall the printer driver and your product name remains in the **Print & Fax**, **Print & Scan**, or **Printers & Scanners** window, select your product name and click the – (remove) icon to remove it.

Parent topic: [When to Uninstall Your Product Software](#)

Where to Get Help

If you need to contact Epson for technical support services, use the following support options.

Internet Support

Visit Epson's support website at [epson.com/support](#) (U.S.) or [epson.ca/support](#) (Canada) for solutions to common problems. You can download drivers and documentation, get FAQs and troubleshooting advice, or e-mail Epson with your questions.

Speak to a Support Representative

Before you call Epson for support, please have the following information ready:

- Product name
- Product serial number (located on a label on the product)

- Proof of purchase (such as a store receipt) and date of purchase
- Computer configuration
- Description of the problem

Then call:

- U.S.: (562) 276-4382, 6 AM to 8 PM, Pacific Time, Monday through Friday, and 7 AM to 4 PM, Pacific Time, Saturday
- Canada: (905) 709-3839, 6 AM to 8 PM, Pacific Time, Monday through Friday, and 7 AM to 4 PM, Pacific Time, Saturday

Days and hours of support are subject to change without notice. Toll or long distance charges may apply.

Purchase Supplies and Accessories

You can purchase genuine Epson ink and paper at Epson Supplies Central at epson.com/ink3 (U.S. sales) or epson.ca (Canadian sales). You can also purchase supplies from an Epson authorized reseller. To find the nearest one, call 800-GO-EPSON (800-463-7766).

Parent topic: [Solving Problems](#)

Technical Specifications

These sections list the technical specifications for your product.

Note: Epson offers a recycling program for end of life products. Please go to epson.com/recycle for information on how to return your products for proper disposal.

[Windows System Requirements](#)

[OS X System Requirements](#)

[Printing Specifications](#)

[Scanning Specifications](#)

[Automatic Document Feeder \(ADF\) Specifications](#)

[Fax Specifications](#)

[Paper Specifications](#)

[Printable Area Specifications](#)

[Ink Cartridge Specifications](#)

[Dimension Specifications](#)

[Electrical Specifications](#)

[Environmental Specifications](#)

[Interface Specifications](#)

[Network Interface Specifications](#)

[Safety and Approvals Specifications](#)

Windows System Requirements

To use your product and its software, your computer should use one of these Microsoft operating systems:

- Windows 8.x
- Windows 7
- Windows Vista
- Windows XP Professional x64 Edition
- Windows XP SP3
- Windows Server 2008R2*

- Windows Server 2008*
- Windows Server 2003*

* When you use Windows Server, you can only print. Scanning and any additional included software are not supported.

Note: Visit Epson's support website at epson.com/support (U.S.) or epson.ca/support (Canada) for the latest in compatibility and drivers for your product.

Parent topic: [Technical Specifications](#)

OS X System Requirements

To use your product and its software, your Mac should use one of these operating systems:

- OS X 10.9.x
- OS X 10.8.x
- OS X 10.7.x
- OS X 10.6.x
- OS X 10.5.8

Note: Visit Epson's support website at epson.com/support (U.S.) or epson.ca/support (Canada) for the latest in compatibility and drivers for your product.

Parent topic: [Technical Specifications](#)

Printing Specifications

Paper path	Rear paper feed slot, top entry Paper cassette, front entry
Capacity	Rear paper feed slot: 0.04 inch (0.9 mm) stack thickness Paper cassette: 1.08 inches (27.5 mm) stack thickness

Parent topic: [Technical Specifications](#)

Scanning Specifications

Scanner type	Flatbed, color
Photoelectric device	CIS
Effective pixels	10200 × 14040 pixels at 1200 dpi; scanning area may be restricted if resolution setting is large
Document size	Maximum: A4 (8.3 × 11.7 inches [210 × 297 mm]) or Letter (8.5 × 11 inches [216 × 279 mm])
Scanning resolution	1200 dpi (main scan) 2400 dpi (sub scan)
Output resolution	50 to 4800, 7200, and 9600 dpi (50 to 4800 dpi in 1 dpi increments)
Image data	16 bits per pixel per color internal 8 bits per pixel per color external (maximum)
Light source	LED

Parent topic: [Technical Specifications](#)

Automatic Document Feeder (ADF) Specifications

Paper input	Faceup loading
Paper output	Facedown ejection
Paper size	US letter, legal, A4, A5, or B5 size
Paper type	Plain paper
Paper weight	17 lb (64 g/m ²) to 24 lb (95 g/m ²)
Sheet feeding capacity	Total thickness: 0.14 inch (3.5 mm) Approximately 35 sheets at 20 lb (75 g/m ²); up to 10 sheets of paper in this size: Legal (8.5 × 14 inches [216 × 357 mm])

Note: You cannot automatically scan on both sides of the paper in this size: Legal (8.5 × 14 inches [216 × 357 mm]) or A5 (5.8 × 8.2 inches [148 × 210 mm]).

Parent topic: [Technical Specifications](#)

Fax Specifications

Fax type	Walk-up black-and-white and color fax capability (ITU-T Super Group 3)
Supported lines	Standard analog telephone lines PBX (Private Branch Exchange) telephone systems
Speed	Up to 33.6 kbps
Resolution	Monochrome: Standard: 203 × 98 dpi Fine: 203 × 196 dpi Photo: 203 × 196 dpi Super Fine: 203 × 392 dpi Ultra Fine: 406 × 392 dpi Color: Fine: 200 × 200 dpi Photo: 200 × 200 dpi
Speed dial numbers	Up to 200
Page memory	Up to 550 pages (based on ITU-T No. 1 chart)
Redial	2 times (with 1 minute interval); specifications may differ by region or country
Interface	RJ-11 Phone Line RJ-11 Telephone set connection

Parent topic: [Technical Specifications](#)

Paper Specifications

Note: Since the quality of any particular brand or type of paper may be changed by the manufacturer at any time, Epson cannot guarantee the quality of any non-Epson brand or type of paper. Always test a sample of paper stock before purchasing large quantities or printing large jobs. Poor quality paper may

reduce print quality and cause paper jams or other problems. If you encounter problems, switch to a higher grade of paper.

Single-sheets

Size	B5 (7.2 × 10.1 inches [182 × 257 mm]) A4 (8.3 × 11.7 inches [210 × 297 mm]) A5 (5.8 × 8.2 inches [148 × 210 mm]) A6 (4.1 × 5.8 inches [105 × 148 mm]) Letter (8.5 × 11 inches [216 × 279 mm]) Legal (8.5 × 14 inches [216 × 357 mm]) 4 × 6 inches (102 × 152 mm) 5 × 7 inches (127 × 178 mm) Executive (7.25 × 10.5 inches [184 × 267 mm]) 16:9 wide (4 × 7.1 inches [102 × 181 mm])
Paper types	Plain paper and paper distributed by Epson
Thickness	0.003 (0.08 mm) to 0.004 inch (0.11 mm)
Weight	17 lb (64 g/m ²) to 24 lb (90 g/m ²)

Envelopes

Size	No. 10 (4.1 × 9.5 inches [105 × 241 mm])
Paper types	Plain paper
Weight	20 lb (75 g/m ²) to 24 lb (90 g/m ²)

Parent topic: [Technical Specifications](#)

Printable Area Specifications

Note: When printing borderless, quality may decline in the expanded printable area.

Single sheets

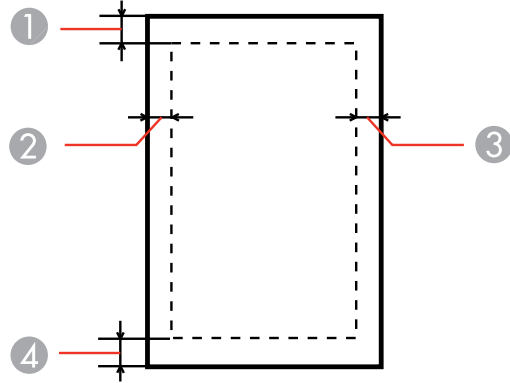

- 1 Top: 0.12 inch (3 mm) minimum
- 2 Left: 0.12 inch (3 mm) minimum
- 3 Right: 0.12 inch (3 mm) minimum
- 4 Bottom: 0.12 inch (3 mm) minimum

Envelopes

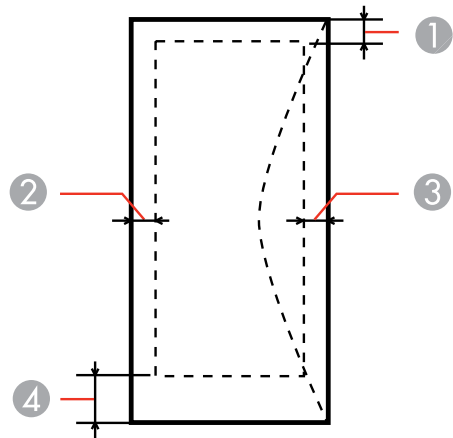

- 1 Left: 0.12 inch (3 mm) minimum; 1.89 inches (48 mm) recommended
- 2 Bottom: 0.20 inch (5 mm) minimum
- 3 Top: 0.20 inch (5 mm) minimum
- 4 Right: 0.12 inch (3 mm) minimum; 0.83 inch (21 mm) recommended

Parent topic: [Technical Specifications](#)

Ink Cartridge Specifications

Note: This product uses only genuine Epson-brand cartridges. Other brands of ink cartridges and ink supplies are not compatible and, even if described as compatible, may not function properly.

The cartridges included with the printer are designed for printer setup and not for resale. After some ink is used for priming, the rest is available for printing. Yields vary considerably based on images printed, print settings, paper type, frequency of use, and temperature. For print quality, a variable amount of ink remains in the cartridge after the "replace cartridge" indicator comes on.

Color	Black, Cyan, Magenta, Yellow
Cartridge life	Opened package: 6 months Unopened package: do not use if the date on the package has expired
Temperature	Storage: -4 to 104 °F (-20 to 40 °C) 1 month at 104 °F (40 °C) Ink freezes at 14 °F (-10 °C) Ink thaws and is usable after 3 hours at 77 °F (25 °C)

Note: For best printing results, use up a cartridge within 6 months of opening the package.

Parent topic: [Technical Specifications](#)

Related references

[Ink Cartridge and Maintenance Box Part Numbers](#)

Dimension Specifications

Height	Stored: 13.5 inches (342 mm) Printing: 15.1 inches (383 mm)
Width	Stored: 18.1 inches (461 mm) Printing: 18.1 inches (461 mm)
Depth	Stored: 16.6 inches (422 mm) Printing: 25.8 inches (655 mm); with the output tray extension extended
Weight (without ink cartridges or power cord)	31.3 lb (14.2 kg)

Parent topic: [Technical Specifications](#)

Electrical Specifications

Input voltage range	100 to 240 V model: 90 to 264 V
Rated frequency range	50/60 Hz
Input frequency range	49.5/60.5 Hz
Rated current	0.8/0.4 A
Power consumption (with USB connection)	Standalone copying: 20 W (ISO/IEC24712) Ready mode: 7.8 W Sleep mode: 1.8 W Power off mode: 0.3 W

Parent topic: [Technical Specifications](#)

Environmental Specifications

Temperature	Operating: 50 to 95 °F (10 to 35 °C) Storage: –4 to 104 °F (–20 to 40 °C) 1 month at 104 °F (40 °C)
Humidity (without condensation)	Operating: 20 to 80% RH Storage: 5 to 85% RH

Parent topic: [Technical Specifications](#)

Interface Specifications

Interface type	Hi-Speed USB (Device Class for computers) Hi-Speed USB (for Mass storage class for external storage)
External USB devices	MO drive: 1.3 GB maximum capacity Hard disk drive: 2 TB maximum capacity USB flash drive: 2 TB maximum capacity, formatted in FAT, FAT32, or exFAT

Note: Epson cannot guarantee the operation of externally connected devices. External storage devices that are powered via USB are not recommended. Use only external storage devices with independent AC power sources.

Parent topic: [Technical Specifications](#)

Network Interface Specifications

Wi-Fi

Standard	IEEE 802.11 b/g/n; complies with either IEEE 802.11 b/g or IEEE 802.11 b/g/n, depending on purchase location
-----------------	--

Security
WEP (64/128 bit)
WPA-PSK (AES); complies with WPA2 with support for WPA/WPA2 Personal
WPA2-Enterprise

Frequency band
2.4 GHz

Communication mode
Infrastructure mode
Ad hoc mode
Wi-Fi Direct

Note: Wi-Fi Direct Simple AP mode available even if you connect the product to an Ethernet network.

Ethernet

Standard
IEEE802.3i/u/ab, IEEE802.3az

Communication mode
Ethernet 100BASE-TX/10BASE-T
Ethernet 1000BASE-T; use a category-5e or higher cable, preferably an STP (Shielded Twisted Pair) cable, to prevent risk of radio frequency interference

Note: The connected device should be IEEE802.3az compliant.

Security Protocol

IEEE802.1X
IPsec/IP Filtering
SSL/TLS: HTTPS Server/Client or IPPS
SNMPv3

Parent topic: [Technical Specifications](#)

Safety and Approvals Specifications

United States

Safety: UL60950-1

EMC: FCC part 15 Subpart B class B

Canada

Safety: CAN/CSA C22.2 No. 60950-1

EMC: CAN/CSA-CEI/IEC CISPR 22 Class B

This equipment contains the following wireless module:

- Manufacturer: Askey Computer Corporation.
- Type: WLU6117-D69 (RoHS)

This product conforms to Part 15 of FCC Rules and RSS-210 of the IC Rules. Epson cannot accept responsibility for any failure to satisfy the protection requirements resulting from a non-recommended modification of the product. Operation is subject to the following two conditions: (1) this device may not cause harmful interference, and (2) this device must accept any interference received, including interference that may cause undesired operation of the device.

To prevent radio interference to the licensed service, this device is intended to be operated indoors and away from windows to provide maximum shielding. Equipment (or its transmit antenna) that is installed outdoors is subject to licensing.

Parent topic: [Technical Specifications](#)

Notices

Check these sections for important notices about your product.

Note: Epson offers a recycling program for end of life products. Please go to [epson.com/recycle](https://www.epson.com/recycle) for information on how to return your products for proper disposal.

[General Product Safety Instructions](#)

[FCC Compliance Statement](#)

[Software Notice](#)

[Trademarks](#)

[Copyright Notice](#)

General Product Safety Instructions

- Be sure to follow all warnings and instructions marked on the product.
- Use only the type of power source indicated on the product's label.
- Use only the power cord that comes with the product. Use of another cord may cause fires or shock. Do not use the cord with any other equipment.
- Place the product near a wall outlet where the plug can be easily unplugged.
- Avoid plugging the product into an outlet on the same circuit as a photo copier or air control system that regularly switches on and off, or on an outlet controlled by a wall switch or timer.
- Do not let the power cord become damaged or frayed. Place it to avoid abrasions, cuts, fraying, crimping, and kinking. Do not place objects on top of it and do not allow it to be stepped on or run over. Be careful to keep the cord straight at each end.
- If you use an extension cord with the product, make sure the total ampere rating of the devices plugged into the extension cord does not exceed the cord's ampere rating. Also, make sure the total ampere rating of all devices plugged into the wall outlet does not exceed the wall outlet's ampere rating.
- Always turn off the product using the power button, and wait until the power light stops flashing before unplugging the product or cutting off power to the electrical outlet.
- If you will not be using the product for a long period, unplug the power cord from the electrical outlet.
- Place the product on a flat, stable surface that extends beyond its base in all directions. It will not operate properly if it is tilted or at an angle.

- Allow space behind the product for the cables, and space above the product so that you can fully raise the document cover.
- Leave enough space in front of the product for the paper to be fully ejected.
- Avoid locations that are subject to rapid changes in heat or humidity, shocks or vibrations, or dust.
- Do not place or store the product outdoors.
- Do not place the product near excessive heat sources or in direct sunlight.
- Leave enough room around the product for sufficient ventilation. Do not block or cover openings in the case or insert objects through the slots.
- Keep the product away from potential sources of electromagnetic interference, such as loudspeakers or the base units of cordless telephones.
- When connecting the product to a computer or other device with a cable, ensure the correct orientation of the connectors. Each connector has only one correct orientation. Inserting a connector in the wrong orientation may damage both devices connected by the cable.
- Do not touch the flat white cable inside the product.
- Do not move the print head by hand; this may damage the product.
- Do not spill liquid on the product or use the product with wet hands.
- Do not use aerosol products that contain flammable gases inside or around the product. Doing so may cause fire.
- Do not press too hard on the document table when placing originals.
- Do not open the scanner section while the product is copying, printing, scanning, or performing any other functions.
- Be careful not to trap your fingers when closing the document cover or scanner.
- Except as specifically explained in your documentation, do not attempt to service the product yourself.
- Unplug the product and refer servicing to qualified service personnel under the following conditions: if the power cord or plug is damaged; if liquid has entered the product; if the product has been dropped or the case damaged; if the product does not operate normally or exhibits a distinct change in performance. Adjust only those controls that are covered by the operating instructions.
- Leave the ink cartridges installed. Removing the cartridges can dehydrate the print head and may prevent the product from printing.
- Before transporting the product, make sure that the print head is in the home (far right) position and the ink cartridges are in place.

- When storing or transporting the product, do not tilt it, stand it on its side, or turn it upside down; otherwise ink may leak.

[Ink Cartridge Safety Instructions](#)

[LCD Screen Safety Instructions](#)

[Wireless Connection Safety Instructions](#)

[Telephone Equipment Safety Instructions](#)

Parent topic: [Notices](#)

Ink Cartridge Safety Instructions

- Keep ink cartridges out of the reach of children and do not drink the ink.
- Be careful when you handle used ink cartridges; there may be ink remaining around the ink supply port. If ink gets on your skin, wash it off with soap and water. If it gets in your eyes, flush them immediately with water.
- Do not put your hand inside the product or touch any cartridges during printing.
- Install a new ink cartridge immediately after removing an expended one. Leaving cartridges uninstalled can dry out the print head and may prevent the product from printing.
- Do not remove or tear the label on the cartridge; this can cause leakage.
- Do not remove the transparent seal from the bottom of the cartridge. This may cause the cartridge to become unusable.
- Do not break the hooks on the side of the cartridge when removing it from the packaging.
- Do not touch the green IC chip on the side of the cartridge. This may prevent normal operation.
- Do not shake cartridges after opening their packages; this can cause them to leak.
- If you remove an ink cartridge for later use, protect the ink supply area from dirt and dust and store it in the same environment as the product. Note that there is a valve in the ink supply port, making covers or plugs unnecessary, but care is needed to prevent the ink from staining items that the cartridge touches. Do not touch the ink cartridge ink supply port or surrounding area.
- Use an ink cartridge before the date printed on its package.
- Do not dismantle an ink cartridge. This could damage the print head.
- Store ink cartridges in a cool, dark place.
- After bringing an ink cartridge inside from a cold storage site, allow it to warm up at room temperature for at least three hours before using it.
- Store ink cartridges with their labels facing upward. Do not store cartridges upside down.

Parent topic: [General Product Safety Instructions](#)

LCD Screen Safety Instructions

- Use only a dry, soft cloth to clean the LCD screen. Do not use liquid or chemical cleansers.
- If the LCD screen is damaged, contact Epson. If the liquid crystal solution gets on your hands, wash them thoroughly with soap and water. If the liquid crystal solution gets into your eyes, flush them immediately with water. If discomfort or vision problems remain after a thorough flushing, see a doctor immediately.
- Do not press too hard on the LCD screen.
- Do not use a pointy or sharp object, such as a pen or your fingernail, to operate the LCD screen.

Parent topic: [General Product Safety Instructions](#)

Wireless Connection Safety Instructions

To avoid adversely affecting the operation of the following equipment and causing an accident, do not use the product:

- Near medical equipment in a medical facility.
- Within 8.7 inches (22 cm) of a cardiac pacemaker.
- Near automatically controlled devices, such as automatic doors or fire alarms.

Parent topic: [General Product Safety Instructions](#)

Telephone Equipment Safety Instructions

When using telephone equipment, you should always follow basic safety precautions to reduce the risk of fire, electric shock, and personal injury, including the following:

- Do not use the Epson product near water.
- Avoid using a telephone during an electrical storm. There may be a remote risk of electric shock from lightning.
- Do not use a telephone to report a gas leak in the vicinity of the leak.

Caution: To reduce the risk of fire, use only a No. 26 AWG or larger telecommunication line cord.

Parent topic: [General Product Safety Instructions](#)

FCC Compliance Statement

For United States Users

This equipment complies with Part 68 of the FCC rules and the requirements adopted by the Administrative Council for Terminal Attachments ("ACTA"). On the surface of this equipment is a label that contains, among other information, a product identifier in the format US:AAAEQ##TXXXX. If requested, this number must be provided to the telephone company.

Applicable certification jack Universal Service Order Codes ("USOC") for the equipment: RJ11C.

A plug and jack used to connect this equipment to the premises wiring and telephone network must comply with the applicable FCC Part 68 rules and requirements adopted by the ACTA. A compliant telephone cord and modular plug is provided with this product. It is designed to be connected to a compatible modular jack that is also compliant. See installation instructions for details.

The REN is used to determine the number of devices that may be connected to a telephone line. Excessive RENs on a telephone line may result in the devices not ringing in response to an incoming call. In most but not all areas, the sum of RENs should not exceed five (5.0). To be certain of the number of devices that may be connected to a line, as determined by the total RENs, contact the local telephone company. For products approved after July 23, 2001, the REN for this product is part of the product identifier that has the format US:AAAEQ##TXXXX. The digits represented by ## are the REN without a decimal point (e.g., 03 is a REN of 0.3). For earlier products, the REN is separately shown on the label.

If this equipment causes harm to the telephone network, the telephone company will notify you in advance that temporary discontinuance of service may be required. But if advance notice isn't practical, the telephone company will notify the customer as soon as possible. Also, you will be advised of your right to file a complaint with the FCC if you believe it is necessary.

The telephone company may make changes in its facilities, equipment, operations or procedures that could affect the operation of the equipment. If this happens the telephone company will provide advance notice in order for you to make necessary modifications to maintain uninterrupted service.

If you have problems with this product and require technical or customer support, please visit www.epson.com for more information.

This product is not intended to be repaired by the customer. If you experience trouble connecting this equipment to a telephone line, please contact:

Name: Epson America, Inc.

Address: 3840 Kilroy Airport Way, Long Beach, CA 90806 U.S.A.

Telephone: (562) 981-3840

If the equipment is causing harm to the telephone network, the telephone company may request that you disconnect the equipment until the problem is resolved.

This equipment may not be used on coin service provided by the telephone company. Connection to party line service is subject to state tariffs. Contact the state public utility commission, public service commission or corporation commission for information.

If your home has specially wired alarm equipment connected to the telephone line, ensure the installation of this equipment does not disable your alarm equipment. If you have questions about what will disable alarm equipment, consult your telephone company or a qualified installer.

The Telephone Consumer Protection Act of 1991 makes it unlawful for any person to use a computer or other electronic device, including fax machines, to send any message unless such message clearly contains in a margin at the top or bottom of each transmitted page or on the first page of the transmission, the date and time it is sent and an identification of the business or other entity, or other individual sending the message and the telephone number of the sending machine or such business, other entity, or individual. (The telephone number provided may not be a 900 number or any other number for which charges exceed local or long-distance transmission charges.)

In order to program this information into your fax machine, click the link below for instructions on entering fax header information.

According to the FCC's electrical safety advisory, we recommend that you may install an AC surge arrester in the AC outlet to which this equipment is connected. Telephone companies report that electrical surges, typically lightning transients, are very destructive to customer terminal equipment connected to AC power sources and that this is a major nationwide problem.

This equipment has been tested and found to comply with the limits for a Class B digital device, pursuant to Part 15 of the FCC Rules. These limits are designed to provide reasonable protection against harmful interference in a residential installation. This equipment generates, uses, and can radiate radio frequency energy and, if not installed and used in accordance with the instructions, may cause harmful interference to radio or television reception. However, there is no guarantee that interference will not occur in a particular installation. If this equipment does cause interference to radio and television reception, which can be determined by turning the equipment off and on, the user is encouraged to try to correct the interference by one or more of the following measures:

- Reorient or relocate the receiving antenna.
- Increase the separation between the equipment and receiver.
- Connect the equipment into an outlet on a circuit different from that to which the receiver is connected.
- Consult the dealer or an experienced radio/TV technician for help.

WARNING

The connection of a non-shielded equipment interface cable to this equipment will invalidate the FCC Certification or Declaration of this device and may cause interference levels which exceed the limits established by the FCC for this equipment. It is the responsibility of the user to obtain and use a shielded

equipment interface cable with this device. If this equipment has more than one interface connector, do not leave cables connected to unused interfaces. Changes or modifications not expressly approved by the manufacturer could void the user's authority to operate the equipment.

For Canadian Users

1. This product meets the applicable Industry Canada technical specifications.
2. The Ringer Equivalence Number is an indication of the maximum number of devices allowed to be connected to a telephone interface. The termination on an interface may consist of any combination of devices subject only to the requirement that the sum of the RENs of all the devices does not exceed five.

CAN ICES-3(B)/NMB-3(B)

Le présent matériel est conforme aux spécifications techniques applicables d'Industrie Canada.

L'indice d'équivalence de la sonnerie (IES) sert à indiquer le nombre maximal de terminaux qui peuvent être raccordés à une interface téléphonique. La terminaison d'une interface peut consister en une combinaison quelconque de dispositifs, à la seule condition que la somme d'indices d'équivalence de la sonnerie de tous les dispositifs n'excède pas 5.

CAN ICES-3(B)/NMB-3(B)

Parent topic: [Notices](#)

Related tasks

[Using the Fax Setup Wizard](#)

Software Notice

1. This printer product includes open source software programs listed in Section 6) according to the license terms of each open source software program.
2. We provide the source code of the GPL Programs, LGPL Programs, Apache License Program and ncftp license Program (each is defined in Section 6) until five (5) years after the discontinuation of same model of this printer product. If you desire to receive the source code above, please contact the customer support of your region. You shall comply with the license terms of each open source software program.
3. The open source software programs are WITHOUT ANY WARRANTY; without even the implied warranty of MERCHANTABILITY AND FITNESS FOR A PARTICULAR PURPOSE. See the license agreements of each open source software program for more details, which are described in OSS.pdf on the [Epson support site](#).
4. OpenSSL toolkit

This printer product includes software developed by the OpenSSL project for use in the OpenSSL Toolkit (<http://www.openssl.org/>).

This product includes cryptographic software written by Eric Young (ey@cryptsoft.com).

5. The license terms of each open source software program are described in OSS.pdf on the [Epson support site](#).

6. The list of open source software programs which this printer product includes are as follows.

GNU GPL

This printer product includes the open source software programs which apply the GNU General Public License Version 2 or later version ("GPL Programs").

The list of GPL Programs:

linux-2.6.35-arm1-epson12

busybox-1.17.4

udhcp 0.9.8cvs20050124-5

ethtool-2.6.35

GNU LGPL

This printer product includes the open source software programs which apply the GNU Lesser General Public License Version 2 or later version ("LGPL Programs").

The list of LGPL Programs:

uclibc-0.9.32

libusb-1.0.8

zeroconf 0.6.1-1

iksemel-rev25

Apache License

This printer product includes the open source software program which apply the Apache License Version 2.0 ("Apache License Program").

Bonjour

OpenLDAP 2.4.30

Bonjour License

This printer product includes the open source software program "Bonjour " which applies the terms and conditions provided by owner of the copyright to the "Bonjour ".

Net-SNMP license

This printer product includes the open source software program "Net-SNMP" which applies the terms and conditions provided by owner of the copyright to the "Net-SNMP".

OpenSSL License/Original SSLeay License

This printer product includes the open source software program "OpenSSL toolkit" which applies the license terms of OpenSSL License and Original SSLeay License.

BSD License (Berkeley Software Distribution License)

This printer product includes the open source software program "busybox-1.17.4 " which apply the Berkeley Software Distribution License ("BSD Program").

Sun RPC License

This printer product includes the open source software program "busybox-1.17.4 " which apply the Sun RPC License ("Sun RPC Program").

ncftp license

This printer product includes the open source software program "ncftp-3.2.4 " which applies the terms and conditions provided by owner of the copyright to the "ncftp ".

SHA1license

This printer product includes the open source software program "SHA1" which applies the terms and conditions provided by owner of the copyright to the "SHA1".

ARC4 license

This printer product includes the open source software program "ARC4" which applies the terms and conditions provided by owner of the copyright to the "ARC4".

json_parserlicense

This printer product includes the open source software program "json_parser" which applies the terms and conditions provided by owner of the copyright to the " json_parser ".

MD5license

This printer product includes the open source software program "MD5" which applies the terms and conditions provided by owner of the copyright to the " MD5 ".

AESlicense

This printer product includes the open source software program "AES" which applies the terms and conditions provided by owner of the copyright to the "AES".

OpenLDAP license

This printer product includes the open source software program "OpenLDAP 2.4.30" which applies the terms and conditions provided by owner of the copyright to the "OpenLDAP".

IPsec-Tools license

This printer product includes the open source software program "IPsec-Tools 0.8.0" which applies the terms and conditions provided by owner of the copyright to the "IPsec-Tools".

Parent topic: [Notices](#)

Trademarks

EPSON® and Supplies Central® are registered trademarks, EPSON Exceed Your Vision is a registered logomark, and Epson Connect™, Epson iPrint™, and Remote Print™ are trademarks of Seiko Epson Corporation.

Epson StoreSM is a service mark of Epson America, Inc.

Epson iPrint™ and Remote Print™ are trademarks of Seiko Epson Corporation.

Apple, iPad, iPhone, iPod touch, Mac, and OS X are trademarks of Apple Inc., registered in the U.S. and other countries. AirPrint and the AirPrint logo are trademarks of Apple Inc.

General Notice: Other product names used herein are for identification purposes only and may be trademarks of their respective owners. Epson disclaims any and all rights in those marks.



Parent topic: [Notices](#)

Copyright Notice

All rights reserved. No part of this publication may be reproduced, stored in a retrieval system, or transmitted in any form or by any means, electronic, mechanical, photocopying, recording, or otherwise, without the prior written permission of Seiko Epson Corporation. The information contained herein is designed only for use with this Epson product. Epson is not responsible for any use of this information as applied to other products.

Neither Seiko Epson Corporation nor its affiliates shall be liable to the purchaser of this product or third parties for damages, losses, costs, or expenses incurred by purchaser or third parties as a result of: accident, misuse, or abuse of this product or unauthorized modifications, repairs, or alterations to this

product, or (excluding the U.S.) failure to strictly comply with Seiko Epson Corporation's operating and maintenance instructions.

Seiko Epson Corporation shall not be liable for any damages or problems arising from the use of any options or any consumable products other than those designated as Original Epson Products or Epson Approved Products by Seiko Epson Corporation.

Seiko Epson Corporation shall not be held liable for any damage resulting from electromagnetic interference that occurs from the use of any interface cables other than those designated as Epson approved Products by Seiko Epson Corporation.

This information is subject to change without notice.

[libTIFF Software Acknowledgment](#)

[A Note Concerning Responsible Use of Copyrighted Materials](#)

[Default Delay Times for Power Management for Epson Products](#)

[Copyright Attribution](#)

Parent topic: [Notices](#)

libTIFF Software Acknowledgment

Copyright © 1988-1997 Sam Leffler

Copyright © 1991-1997 Silicon Graphics, Inc.

Permission to use, copy, modify, distribute, and sell this software and its documentation for any purpose is hereby granted without fee, provided that (i) the above copyright notices and this permission notice appear in all copies of the software and related documentation, and (ii) the names of Sam Leffler and Silicon Graphics may not be used in any advertising or publicity relating to the software without the specific, prior written permission of Sam Leffler and Silicon Graphics.

THE SOFTWARE IS PROVIDED "AS-IS" AND WITHOUT WARRANTY OF ANY KIND, EXPRESS, IMPLIED OR OTHERWISE, INCLUDING WITHOUT LIMITATION, ANY WARRANTY OF MERCHANTABILITY OR FITNESS FOR A PARTICULAR PURPOSE.

IN NO EVENT SHALL SAM LEFFLER OR SILICON GRAPHICS BE LIABLE FOR ANY SPECIAL, INCIDENTAL, INDIRECT OR CONSEQUENTIAL DAMAGES OF ANY KIND, OR ANY DAMAGES WHATSOEVER RESULTING FROM LOSS OF USE, DATA OR PROFITS, WHETHER OR NOT ADVISED OF THE POSSIBILITY OF DAMAGE, AND ON ANY THEORY OF LIABILITY, ARISING OUT OF OR IN CONNECTION WITH THE USE OR PERFORMANCE OF THIS SOFTWARE.

Parent topic: [Copyright Notice](#)

A Note Concerning Responsible Use of Copyrighted Materials

Epson encourages each user to be responsible and respectful of the copyright laws when using any Epson product. While some countries' laws permit limited copying or reuse of copyrighted material in certain circumstances, those circumstances may not be as broad as some people assume. Contact your legal advisor for any questions regarding copyright law.

Parent topic: [Copyright Notice](#)

Default Delay Times for Power Management for Epson Products

This product will enter sleep mode after a period of nonuse. This is to ensure that the product meets Energy Star standards of energy efficiency. More energy savings can be achieved by setting the time to sleep to a shorter interval.

Parent topic: [Copyright Notice](#)

Copyright Attribution

© 2014 Epson America, Inc.

7/14

CPD-40056R1

Parent topic: [Copyright Notice](#)