

EQUITY™ I+

**User's Guide
and
Diagnostics**

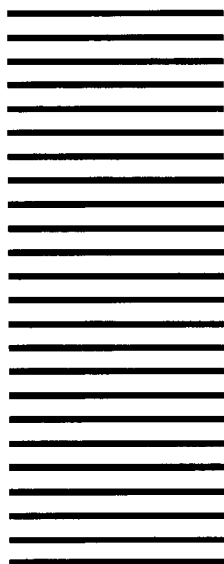

EPSON®



EPSON[®]
Equity[™] I +
User's Guide

Y14499113001

IMPORTANT NOTICE
DISCLAIMER OF WARRANTY

Seiko Epson Corporation makes no representations or warranties, either express or implied, by or with respect to anything in this manual, and shall not be liable for any implied warranties of merchantability and fitness for a particular purpose or for any indirect, special or consequential damages. Some states do not allow the exclusion of incidental or consequential damages, so this exclusion may not apply to you.

COPYRIGHT NOTICE

All rights reserved. No part of this publication may be reproduced, stored in a retrieval system, or transmitted, in any form or by any means, electronic, mechanical, photocopying, recording or otherwise, without the prior written permission of Seiko Epson Corporation. No patent liability is assumed with respect to the use of information contained herein. While every precaution has been taken in the preparation of this publication, Seiko Epson Corporation assumes no responsibility for errors or omissions. Nor is any liability assumed for damages resulting from the use of the information contained herein. Further, this publication and features described herein are subject to change without notice.

TRADEMARKS

Epson is a registered trademark of Seiko Epson Corporation.

Equity is a trademark of Epson America, Inc.

Centronics is a registered trademark of Centronics Data Computer Corp.

Hercules is a trademark of Hercules Computer Technology.

IBM is a registered trademark of International Business Machines Corp.

MS and GW are trademarks of Microsoft Corp.

Copyright © 1986 by Seiko Epson Corporation
Nagano, Japan

FCC COMPLIANCE STATEMENT FOR AMERICAN USERS

This equipment generates and uses radio frequency energy and if not installed and used properly, that is, in strict accordance with the manufacturer's instructions, may cause interference to radio and television reception. It has been type tested and found to comply with the limits for a Class B computing device in accordance with the specifications in Subpart J of Part 15 of FCC rules, which are designed to provide reasonable protection against such interference in a residential installation. However, there is no guarantee that interference will not occur in a particular installation. If this equipment does cause interference to radio or television reception, which can be determined by turning the equipment off and on, the user is encouraged to try to correct the interference by one or more of the following measures:

- Reorient the receiving antenna
- Relocate the computer with respect to the receiver
- Move the computer away from the receiver
- Plug the computer into a different outlet so that computer and receiver are on different branch circuits.

If necessary, the user should consult the dealer or an experienced radio/television technician for additional suggestions. The user may find the following booklet prepared by the Federal Communications Commission helpful:

"Television Interference Handbook"

This booklet is available from the U.S. Government Printing Office, Washington DC 20402. Stock No. 004-000-00450-7.

Note: If the interference stops, it was probably caused by the computer or its peripheral devices. To further isolate the problem:

Disconnect the peripheral devices and their input/output cables one at a time. If the interference stops, it is caused by either the peripheral device or its I/O cable. These devices usually require shielded I/O cables. For Epson peripheral devices, you can obtain the proper shielded cable from your dealer. For non-Epson peripheral devices contact the manufacturer or dealer for assistance.

WARNING

This equipment has been certified to comply with the limits for a Class B computing device, pursuant to Subpart J of Part 15 of FCC Rules. Only peripherals (computer input/output devices, terminals, printers, etc.) certified to comply with the Class B limits may be attached to this computer. Operation with non-certified peripherals is likely to result in interference to radio and TV reception.

The connection of a non-shielded equipment interface cable to this equipment will invalidate the FCC Certification of this device and may cause interference levels which exceed the limits established by the FCC for this equipment.

Contents

Introduction	Intro-1
How to Use This Manual	Intro-2
1 Setting Up Your System	1-1
Unpacking	1-1
Removing the disk drive protector sheet	1-2
Choosing a Location	1-2
Arranging the Components	1-3
The rear panel	1-4
The front panel	1-5
Connecting the Power Cord	1-6
Connecting the Video Monitor	1-7
Connecting the Keyboard	1-8
Connecting the Printer	1-10
Parallel interface	1-10
Serial interface	1-12
The Equity I+ character set	1-12
Setting the DIP Switches	1-13
DIP switch set 1 (internal operations)	1-14
DIP switch set 2 (parallel and serial port operations)	1-16
Turning On the Computer	1-18
Safetyrules..	1-18
Initial setup procedure	1-19
Initial screen display	1-19
2 Using Your Equity I+	2-1
Special Keys	2-1
Selecting Execution Speed	2-2
Resetting the Computer	2-3
Turning Off the Computer	2-4
Using Disks and Disk Drives	2-4
How disks work	2-5
Choosing diskettes for the Equity I+	2-5
Caring for your disks and disk drives	2-5
Inserting and removing diskettes	2-7
Write-protecting diskettes	2-8

	Making backup copies	2-9
	Using a single floppy disk drive	2-9
	Using a hard disk drive	2-10
3	Installing Option Cards	3-1
	Removing the Cover	3-1
	Inserting the Option Card	3-3
	Removing an access slot cover	3-5
	Replacing the Cover	3-6
	Post-installation Setup	3-7
	Removing Option Cards	3-7
4	Troubleshooting	4-1
	The Computer Fails to Start Up	4-1
	The Video Display Does Not Appear	4-1
	The Computer Locks Up or Freezes	4-2
	Floppy Disk Problems	4-2
	Hard Disk Problems	4-3
	Software Problems	4-3
	Printer Problems	4-4
	Option Card Problems	4-4

Appendixes

A	Changing Jumper Settings	A-1
	Jumper J1, Floppy Disk Controller	A-1
	Jumper J2, Parity RAM	A-3
B	Specifications	B 1
	MainUnit	B-1
	Keyboard	B-2
	Mass Storage	B-2
	Power Supply	B-2
	Environmental Requirements	B-2
	Physical Characteristics (CPU Only)	B-2
	Video and Display Options	B-3
C	Glossary..	C-1
	Index	Index-1

Figures

1-1	System arrangement	1-3
1-2	Rear panel	1-4
1-3	Front panel	1-5
1-4	Inserting the power cord	1-6
1-5	Connecting the monitor cable	1-7
1-6	Opening the keyboard socket cover	1-8
1-7	Connecting the cable to the main unit	1-9
1-8	Adjusting the keyboard legs	1-10
1-9	Locating the printer	1-11
1-10	Connecting the printer	1-12
1-11	Location of DIP switches	1-13
1-12	DIP switch label	1-14
2-1	Equity I+ keyboard	2-1
2-2	Speed switch	2-3
2-3	Inserting diskettes	2-7
2-4	Write-protect notch	2-8
2-5	Write-protect switch	2-9
3-1	Back panel screws	3-2
3-2	Side screws under plastic inserts	3-2
3-3	Removing cover..	3-3
3-4	Inserting option card	3-4
3-5	Removing access slot cover	3-5
3-6	Replacing the cover	3-6
A-1	Jumper positions	A-1
A-2	Jumper locations	A-2

Tables

1-1	Monitor/video card compatibility	1-8
1-2	DIP switch set 1	1-14
1-3	DIP switch set 2	1-16
2-1	Special key functions	2-2

Introduction

Your Epson® Equity™ I+ personal computer is a versatile, expandable, and economical system. Its flexibility lets you create your own system; first you choose from three models of the Equity I+ main unit, then you select the accessories you want to use with it to assemble the configuration that does the most for you.

The Equity I+ main unit is available in three configurations:

- One floppy disk drive
- Two floppy disk drives
- One floppy disk drive and one internal hard disk drive.

You also choose which monitor you want to use.

Optional cards and external devices further expand the capabilities of your Equity I+. Its built-in serial and parallel interfaces and five internal option slots let you connect almost any peripheral device you choose. Here are some options you can use with your system:

- Expanded memory option card
- 8087 math coprocessor
- Monochrome monitor
- Monochrome video card
- RGB (red green blue) color or enhanced color monitor
- Color/graphics video card (color, monochrome, or enhanced graphics adapter)
- Graphics or enhanced graphics video card
- An Epson printer or plotter.

Check with your Epson dealer from time to time to find out which peripherals and option cards are available. You can use most of the cards designed for the IBM® personal computer on your Equity I+.

The Equity I+ comes with the MSTM-DOS operating system and the GWTM-BASIC programming language. If you have used MS-DOS before on another computer, you will find that it works the same on the Equity I+. Be sure to refer to your Equity MS-DOS manual, however, for descriptions of the special utility programs added by Epson.

You may have purchased other software as well; you can use most software products designed for the IBM PC on your Equity I+. Refer to your software program documentation for information on using the software.

Additionally, the Equity I+ supports multiple users and multiple tasking with the appropriate operating system. Consult your Epson dealer for more information.

How to Use This Manual

This user's guide explains how to set up and care for your Equity I+. It also describes how to connect optional equipment and start using your operating system. You may not need to read everything in this book; some sections may describe a particular option or accessory you do not have.

Follow the instructions in Chapter 1 to set up your system and turn on your Equity I+. Chapter 2 covers some of the general operational procedures. It also describes how disks and disk drives work and shows how to use them. Chapter 3 explains how to install and remove option cards. Chapter 4 provides information on troubleshooting. The appendixes tell you how to change jumper settings and list hardware specifications. A glossary of some of the computer terms this guide uses is also included. Refer to the glossary whenever you come across an unfamiliar term.

Setting Up Your System

Setting up your Epson Equity I+ personal computer is easy. Just follow the nine easy steps in this chapter. You should also refer to the “Quick Guide To Setting up Your Equity I+” reference card.

1 Unpacking

As you remove the components from their cartons, be sure to inspect each piece. If anything is missing, looks damaged, or seems wrong, consult your Epson dealer. Be sure to keep your packing materials. They provide the best protection possible for your computer if you need to move or ship it later.

When you unpack your Equity I+, you should find the following:

- The main unit and power cord
- The keyboard with detachable cable
- An MS-DOS operating system diskette (version 3.2) with an MS-DOS manual
- A GW-BASIC programming language diskette with a GW-BASIC manual
- A diagnostics and system-dependent utilities diskette and a Diagnostics manual
- This Equity I+ User's Guide.

In addition to these items, you probably purchased a compatible video monitor and video card.

You'll find one registration card with your Equity I+. Fill the card out now and mail it to Epson. With your registration card on file, Epson can send you update information.

Removing the disk drive protector sheet

A cardboard sheet occupies the disk slot in the floppy disk drive. This sheet is inserted at the factory to protect the recording read/write heads.

Be sure to remove it before you connect any cables. Press the button on the left side of the drive. When you release it the edge of the protector sheet pops out. Carefully pull out this sheet.

Save the protector sheet and reinsert it whenever you move the computer, even if you are just moving it to another part of the room. If you are not going to use your computer for a week or more, when you go on vacation for example, reinsert the protector sheet to help keep dust from entering the disk drive.

2 Choosing a Location

An important part of setting up your Equity I+ is deciding where to locate it. Whether you use your computer at home or in the office, you need to find a comfortable, convenient location.

Choose a location that provides the following:

- A large, sturdy desk or table. Make sure it can easily support the weight of your system, including all its components.
- A flat, hard surface. Soft surfaces like beds and carpeted floors attract static electricity, which erases data on your diskettes and can damage the computer's circuitry. Soft surfaces also prevent proper ventilation.
- Good air circulation. Air must be able to circulate freely under the system as well as behind it. Leave several inches of space around the computer to allow ventilation.
- Moderate environmental conditions. You need to protect your computer from extremes in temperature, humidity, dust, and smoke. Avoid direct sunlight or any other type of heat. High humidity also hinders operation, so select a cool, dry area. Because you can't risk losing data stored on disk, do not expose your computer to dust and smoke which can damage disks and disk drives.
- Appropriate power sources. To prevent static charges, connect all your equipment to three-prong, 120-volt grounded outlets. You need one outlet for the main unit, one for the monitor, and additional outlets for your printer and any other peripherals. The auxiliary power outlet on the rear panel of the Equity I+ reduces the number of wall outlets you need.

- No electromagnetic interference. Locate your system away from any electrical device that generates an electromagnetic field. Surprisingly, even your telephone can cause problems, especially if you keep diskettes right next to it.

When you find the ideal location for your Equity I+, you can start to set up your system.

3 Arranging the Components

First decide how you want to arrange your system components. The most common setup, shown in Figure 1-1, is to lay the main unit flat and set the video monitor on top of it with the keyboard directly in front (leaving enough space to insert diskettes into the disk drives).

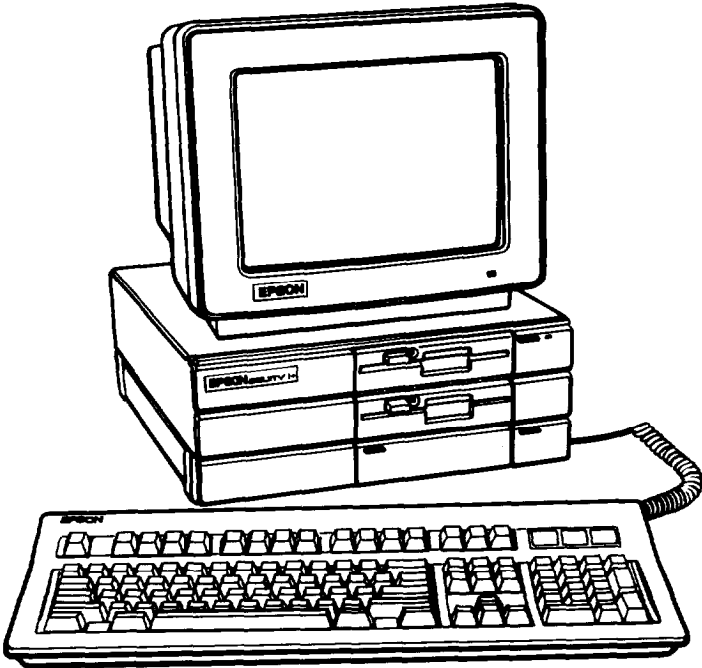

Figure 1-1. System arrangement

Of course, if you have special computer furniture or want to customize your setup, you can arrange your Equity I+ components to suit your own particular needs.

Before you connect the cables, take a look at the rear and front panels of the main unit.

The rear panel

Look at the rear panel to identify the Equity I+ input/output ports. Figure 1-2 shows where you connect the peripheral devices.

WARNING: Do not connect the power cord until you have connected all peripheral devices. Always check to see that the power switch is off before you connect or disconnect any peripherals.

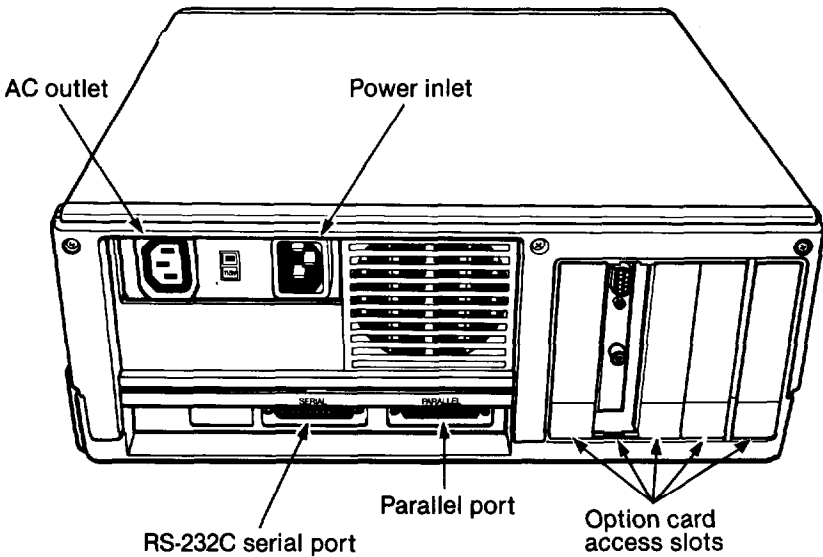

Figure 1-2. Rear panel

Here are brief descriptions of each of the ports:

- AC power outlet. Auxiliary power outlet. Some monitors (and other types of peripherals) can be plugged into the main unit here, instead of a wall outlet. The main unit's power switch controls the monitor or peripheral connected to this outlet. Power consumption should not exceed 80 watts.
- AC power inlet. Supplies electrical power to the computer. Always turn the power switch off before you plug the power cord into an outlet.

- RS-232C serial port. Allows you to connect a peripheral with a serial interface, such as a modem, another computer or a printer.
- Parallel port. Allows you to connect a peripheral with a parallel interface, such as a printer or plotter.
- Option card access slots. The Equity I+ has space for five option cards (which control your peripherals). One of these slots is occupied by either your monochrome or color/graphics video card. You can use the other four to add special devices such as a modem or hard disk controller.

The front panel

Now take a look at the front panel. The components on the front panel are shown in Figure 1-3 with the covers open to show the switches and the keyboard cable socket. To open each cover, press down gently on the small handle.

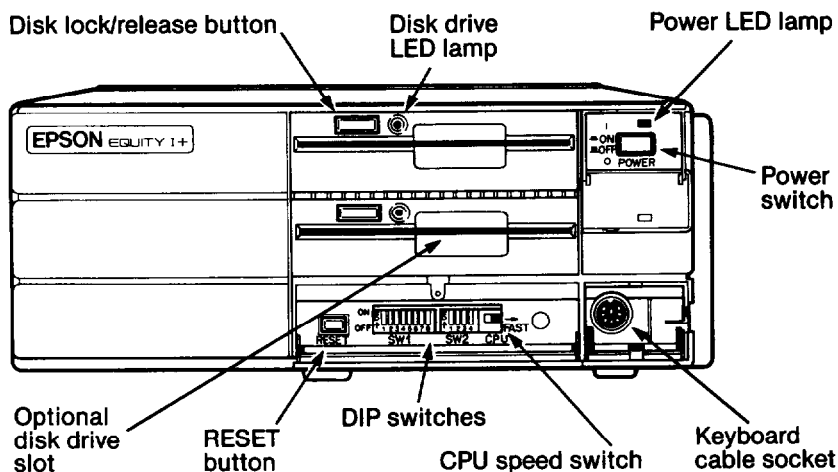

Figure 1-3. Front panel

The front panel components work as follows:

- Disk lock/release button. Press to lock a diskette in place. Press again to eject it.
- Disk drive LED lamps. A light indicates that the drive is being accessed.

- Slot for optional disk drives. You can install a second floppy disk drive or a hard disk drive in this optional slot. All Equity I+ units come with at least one floppy disk drive. The main unit above is shown with a second floppy disk drive.
- Power LED lamp. When the light is red the power is on and the system is running at 4.77MHz. When the light is green the system is on and running at 10MHz.
- Power switch. Turns the main unit on and off.
- Keyboard cable socket. The keyboard plugs into the main unit here.
- RESET button. Press this button to reset the computer. When an operating system diskette is in the top drive or running on the hard disk, you can press the RESET button to reboot it.
- DIP switches. These give the computer information about its keyboard, coprocessor status, memory size, monitor type, floppy disk drives, and interface types. You set them to match your system requirements.
- CPU Speed switch. Move this switch left for 4.77MHz or right for 10MHz.

4 Connecting the Power Cord

Insert the power cord into the AC power inlet on the left side of the back panel, as shown in Figure 1-4. To avoid an electric shock, be sure to plug this end into the main unit before plugging the other end into the wall socket. For now, do not plug the power cord into an electrical outlet.

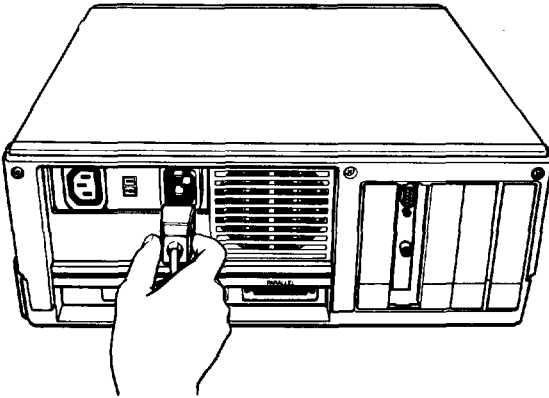

Figure 1-4. herring the power cord

5 Connecting the Video Monitor

To connect the video monitor, place it on top of or near the Equity I+ main unit. It is easiest to connect the monitor cable if the backs of the monitor and the main unit are facing you.

Note: Your dealer probably installed a video card in your main unit to control your monitor. If not, you need to install it before you can connect your monitor. See Chapter 3 for installation instructions.

The way you connect your monitor depends on the type you have. Refer to your monitor manual or follow these guidelines:

1. If necessary, connect the video monitor cable to your monitor. Some cables are permanently attached to the monitor at one end.
2. Connect the appropriate end of the video monitor cable to your monochrome or color/graphics card connector at the back of the main unit, as shown in Figure 1-5. If the plug has retaining screws, tighten them with a screwdriver.

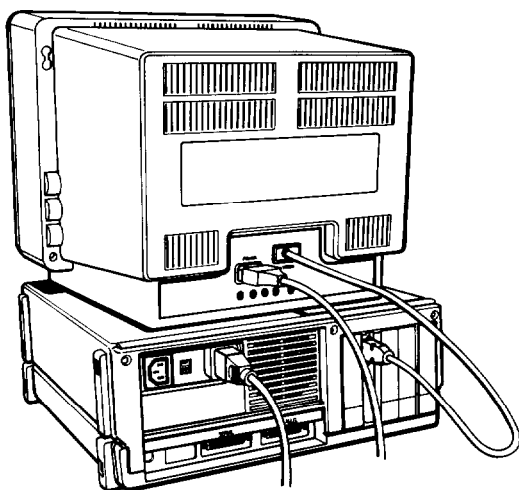

Figure 1-5. Connecting the monitor cable

The monitor type must match the video card in the main unit. If you have a color card, you can use either a nine-pin female D-connector for RGB monitors or an RCA connector for composite video monitors. Consult Table 1-1 to make sure your card and monitor match. Be sure to set the switches on the video card to match your monitor.

Table 1-1. Monitor/video card compatibility

Monitor	Video card	output type
Monochrome	Monochrome or graphics or enhanced graphics	One 9-pin output (TTL compatible)
Color or Enhanced color	Graphics or color graphics or enhanced graphics	One 9-pin RGB output, or one RCA-type jack for composite video

3. Plug the monitor's power cable first into the power inlet on the monitor and then into an electrical outlet. If a monochrome monitor has the proper type of plug, you can plug it into the auxiliary outlet next to the power inlet at the back of the main unit. The monitor's power consumption must not be more than 80 watts.
4. When you check the DIP switch settings, as defined later in this chapter, be sure they are set correctly for the type of monitor you have.
5. If you have trouble getting a display, check that the brightness and contrast controls on the monitor are set correctly. Monitors usually have their own power switches. Make sure the power switch is on.

6 Connecting the Keyboard

Follow these steps to connect the keyboard:

1. Open the cover at the lower right front corner of the main unit, as shown in Figure 1-6.

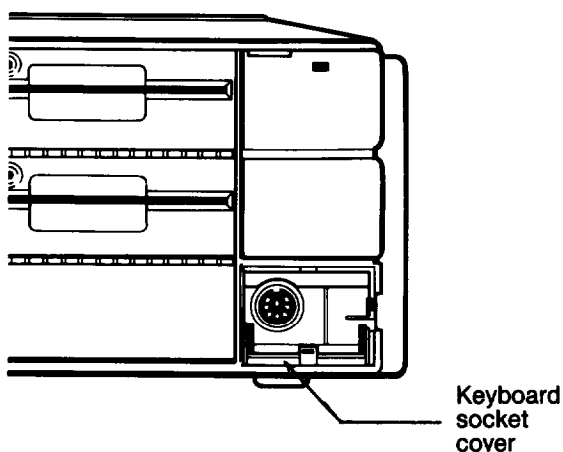

Figure 1-6. Opening the keyboard socket cover

2. Insert the keyboard connector as shown in Figure 1-7. Do not force the connector, but make sure you insert it all the way. See that the cable exits to the right of the main unit.

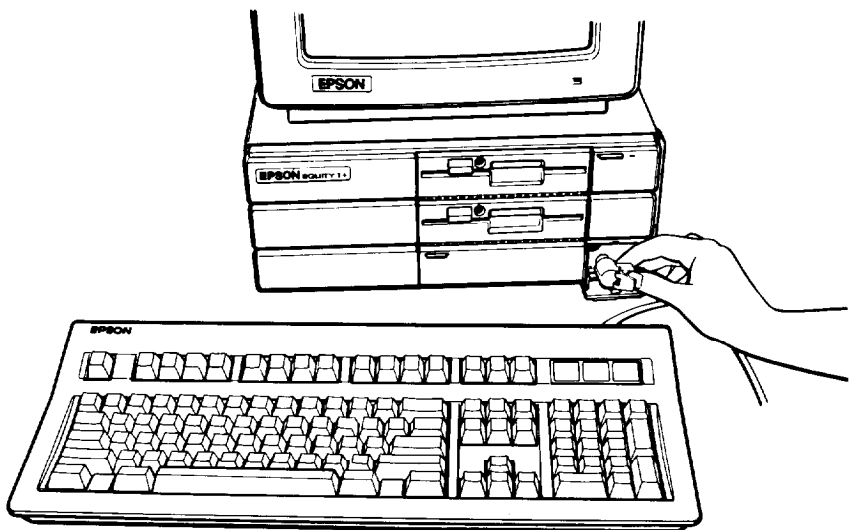

Figure 1-7. Connecting the cable to the main unit

3. Gently push the cable into the retaining clip, and close the cover.

You can use the keyboard at different angles such as laying it flat on a desk or placing it on your lap. You can also tilt the keyboard by adjusting the legs on the bottom. Adjust the keyboard legs by turning the keyboard over, reaching under the lip and pulling each of the legs upward until they lock into place, as shown in Figure 1-8.

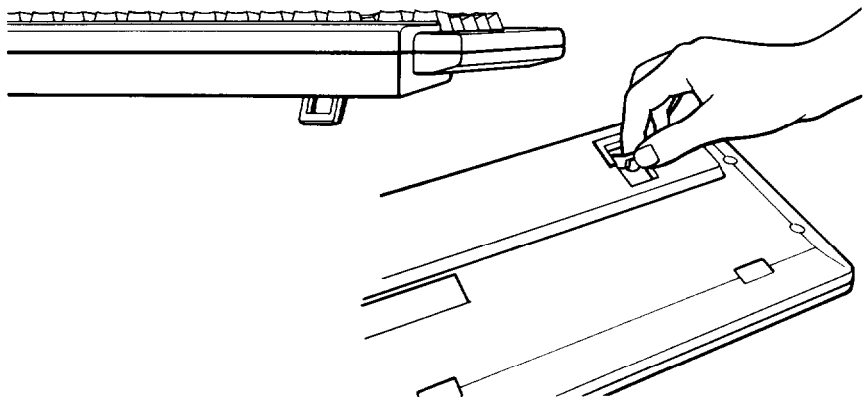

Figure 1-8. Adjusting the keyboard legs

To lower the legs, gently squeeze the sides until they move out of the slot and push down on the leg until it clicks into place.

To disconnect the keyboard, open the cover on the main unit and press down on the retaining clip to release the cable. Lift the tab on the connector, and pull it straight out from the main unit.

7 Connecting the Printer

Your Equity I+ has both serial and parallel built-in interfaces. You can easily connect a printer or plotter that has either a serial or parallel interface. Just follow the instructions below.

Parallel interface

The parallel connector on the Equity I+ is a Centronic®-compatible interface with a DB-25 socket. Most Epson printers have a parallel interface.

To connect your printer to a parallel interface:

1. Place the printer in a convenient location next to your system, as shown in Figure 1-9 for example.



Figure 1-9. Locating the printer

2. Before connecting any cables, make sure the power switches on both the main unit and the monitor are switched off. If you are not sure which cable you need, consult your dealer.
3. One end of the printer cable has a 25-pin male D-connector. (Refer to your printer manual to determine which end this is.) Connect this end to the socket marked PARALLEL on the back panel of the main unit. If the plug has retaining screws, tighten them with a small screwdriver.
4. Connect the other end of the cable to the printer. To secure the cable, tighten the squeeze locks at each side of the printer port and into the connectors on each side of the cable as shown in Figure 1-10.

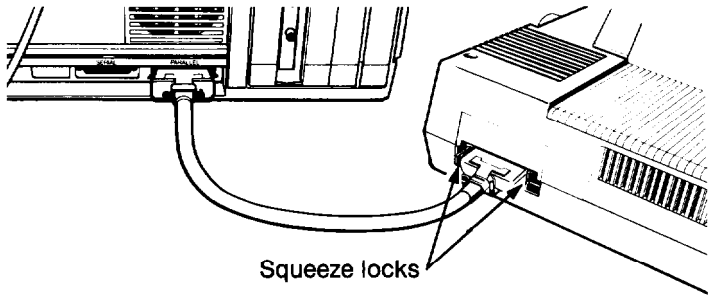

Figure 1- 10. Connecting the printer

5. Plug the printer's power cable into a separate electrical outlet.

Serial interface

If you have a printer (or other peripheral, such as a modem) with a serial interface, connect it to the port marked **SERIAL (RS-232C)** at the back of the main unit. If the cable is a non-standard type, with a male D-connector at both ends, you need an adapter to connect it to the computer. To connect your serial device, follow the same steps above for connecting a parallel device.

The RS-232C serial port needs to be configured properly in order for it to function correctly. The printer output must also be redirected to the serial port instead of the parallel port. Use the MS-DOS SETMODE utility (or the MODE command) to make these changes. See your MS-DOS manual for instructions.

The Equity I+ character set

The Equity I+ uses a special character set that assigns graphics and international characters to some of the ASCII codes. In most cases, if you try to print these characters on a standard printer, you get italic characters instead. Many Epson printers support the IBM character set (like those used on the Equity I+) as a standard feature, and other printers can be adapted. In addition, some application programs print the special graphics characters on a standard printer using a special printer driver program. Ask your dealer for more information.

8 Setting the DIP Switches

The DIP switches on the Equity I+ are set to provide your system with information about itself. Each time you turn on your system, it checks the DIP switch settings to determine the keyboard type, coprocessor status, memory size, monitor type, number of floppy disk drives, and the type of interfaces being used. The DIP switches are located underneath the cover on the front of your main unit, below the disk drives, as shown in Figure 1-11.

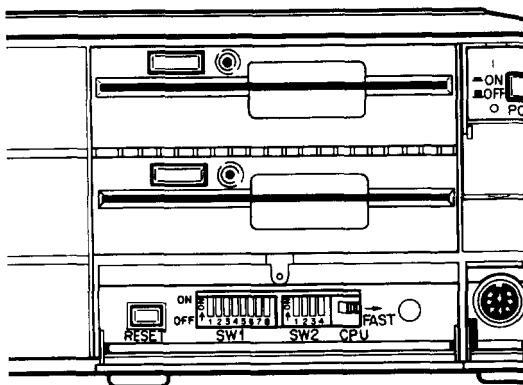

Figure 1-11. Location of DIP switches

Your Epson dealer should have set these switches for you. However, read this section to be sure the settings match your system configuration. If you upgrade your computer later (by adding a hard disk drive for example) you may need to alter the DIP switch settings.

Note: Set the DIP switches only while your computer is off. Software programs check the settings each time you turn on the system, so do not change the settings while a program is running.

The Equity I+ has two sets of DIP switches; set 1 contains eight switches which control the computer's internal operations, and set 2 contains four switches which control the parallel and serial ports. A label inside the DIP switch cover shows the functions of each DIP switch and the factory settings. See Figure 1-12.

SWITCH I	1 2 3 4 5 6 7 8								SWITCH II	1 2 3 4				
K/B TYPE	ENHANCED	OFF							PARALLEL	PRIMARY	OFF	ON		
COPROCESSOR	NOT INST	ON								SECONDARY	OFF	OFF		
RAM SIZE	640KB	OFF OFF							SERIAL	DISABLE	ON	ON		
	512KB	OFF ON								PRIMARY	OFF	OFF		
	256KB	ON ON								SECONDARY	ON	OFF		
MONITOR TYPE	COLOR(40X25)	OFF ON								DISABLE	ON	ON		
NO. OF FDD(S)	COLOR(80X25)	ON OFF												
	MONOCHROME	OFF OFF												
	SINGLE	ON ON												
	DUAL	OFF ON												

Figure 1-12. DIP switch label

When a switch is up, it is on. When a switch is down, it is off. To change a setting, use a hard, thin object, such as a small screwdriver.

DIP switch set 1 (internal operations)

The system functions controlled by each switch in set 1 are listed in Table 1-2 and described below.

Table 1-2. DIP switch set 1

		1	2	3	4	5	6	7	8
Keyboard type	Enhanced	OFF							
Coprocessor	Not installed		ON						
	Installed		OFF						
RAM Size	640KB			OFF	OFF				
	512KB			OFF	ON				
	256KB			ON	ON				
Monitor and adapter type	Color(40X25)					OFF	ON		
	Color(80X25)					ON	OFF		
	Monochrome					OFF	OFF		
	Enhanced					ON	ON		
Number of floppy disk drives	1							ON	ON
	2							OFF	ON
	3							ON	OFF
	4							OFF	OFF

Switch 1 (keyboard)-tells your computer what kind of keyboard is attached to your system. The factory setting is off for the standard (enhanced) keyboard which comes with your Equity I+.

Switch 2 (coprocessor)-tells your computer whether or not an optional math coprocessor is installed. The factory setting is on to tell the system that this option has not been installed.

Switches 3 and 4 (memory size)-indicate how much built-in memory is available. These switches should never be changed unless you install a memory card and you want to use part of the optional memory instead of the built-in main memory.

The system always checks the amount of available memory each time it is reset. Problems may occur if the switch settings do not agree with the amount of main memory in use.

Switches 5 and 6 (monitor type)--define what type of video card and monitor you are using and help the system address the adapter memory correctly. Set these switches as follows:

- If you have a monochrome monitor and video card, set both switches  off.
- If you have an enhanced graphics adapter set both switches on, no matter what type of monitor you have.
- If you have a color graphics adapter and an RGB monitor, set switch 5 on and switch 6 off.
- If you are using a composite video monitor, and its resolution is poor, you may want to set switch 5 off and switch 6 on. This selects 40-column text mode for your screen and improves the resolution.

Switches 7 and 8 (floppy disk drive) indicate how many floppy disk drives your system has. These switches are very important and should be set as follows:

- If you have a single drive, set both switches on so the operating system knows that it must provide help when disk B: is required.
- If you have two floppy disk drives, set switch 7 off and switch 8 on so the lower drive is not ignored.
- If you add external floppy disk drives, for a system total of four, set switches 7 and 8 as indicated in Table 1-2.

DIP switch set 2 (parallel and serial port operations)

The parallel and serial port functions controlled by DIP switch set 2 are listed in Table 1-3 and described below.

Table 1-3. DIP switch set 2

		1	2	3	4
Parallel	Primary	OFF	ON		
	Secondary	OFF	OFF		
	Disable	ON	ON		
Serial	Primary			OFF	OFF
	Secondary			ON	OFF
	Disable			—	ON

Switches 1, 2, 3, and 4 tell the computer how to access the built-in parallel and serial ports. You do not need to change the factory settings unless you install an option card with an additional parallel or serial port. If you do install such an option card, read the following information carefully.

Switches 1 and 2 (*parallel* port)-tell the computer how to access the built-in parallel port.

The built-in parallel port functions as either the primary or secondary parallel port. However, if you install any option card with its own parallel port, you must set these two DIP switches so there is no conflict between the built-in parallel port and the added card. Table 1-3 shows you how to set the DIP switches.

If you install an option card that has only a parallel port, you must designate this as the secondary port and leave the built-in port as the primary port.

If you install a video card with a parallel port (such as an IBM monochrome display and printer adapter) you must designate it as the primary parallel port and the built-in port becomes the secondary parallel port.

If you install two option cards with parallel ports, one is designated as the primary port and the other as the secondary port. In this case, you need to set switches 1 and 2 on in order to disable the built-in port.

If MS-DOS searches the system for a parallel port and finds only one, it names it LPT1:. If there are two parallel ports, it names the primary port LPT1: and the secondary LPT2:.

Switches 3 and 4 (serial port)-tell the computer how to access the built-in serial port.

The built-in serial port functions as either the primary or secondary serial port. However, if you install any option card with its own serial port you must set these two DIP switches so there is no conflict between the built-in serial port and the added card. Table 1-3 shows how to set the DIP switches.

If you install an option card with a serial port preset as primary by the manufacturer, you must designate it as the primary port and designate the built-in port as the secondary port.

If you install an option card or peripheral with a serial port not pre-set you must designate it as the secondary serial port and the built-in port as the primary serial port.

If you install two option cards with serial ports, one is designated as the primary port and the other as the secondary port. In this case you need to set switch 4 on to disable the built-in port.

If MS-DOS searches the system for a serial port and finds only one, it names it COM1:. If there are two serial ports, it names the primary port COM1: and the secondary COM2:.

9 Turning On the Computer

After you set up your system, you're ready to turn on the power and start using your Equity I+. But before you do turn it on, read the following safety rules.

Safety rules

1. Never turn the computer on or off with a disk drive protector sheet in the disk drive.
2. Do not attempt to dismantle any part of the computer. Only remove the top cover to install and remove option cards. If there is a hardware problem you cannot solve after reading Chapter 4 on troubleshooting, or if you want to install an optional 8087 math coprocessor, consult your Epson dealer.
3. To install or remove option cards, always turn off the power, disconnect the main power cord, and wait for a few minutes before removing the cover from the computer.
4. Do not unplug cables from the computer while the power switch is on.
5. Never turn off or reset the computer when one of the drive lamps is on. This can destroy data stored on a disk or make a whole disk unusable.
6. Always wait at least five seconds after you switch the power off before switching it on again. Turning it off and on rapidly can damage the computer's circuitry.
7. Never leave a beverage on top of, or next to, your system or any of its components. Spilled liquid damages the circuitry of your components.

Now you are ready to turn on your system. It's a good idea to turn on the monitor and any peripheral devices before you turn on the main unit.

First, make sure the power cord is plugged into the power inlet on the back panel of the main unit. Then plug the power cord into a three-prong, 120-volt, grounded electrical outlet. Turn on the monitor so you can see the messages that appear as your computer starts up. If you have a printer or other peripheral device, turn it on next.

You can turn on your computer with or without a system diskette in the top disk drive. For now, leave the drive empty. When you are ready to turn on the computer, press the power switch at the upper-right corner once. The power indicator on the front panel lights up and the cooling fan inside the main unit starts. After a few seconds, the computer begins to perform an internal test.

If you cannot see the screen display clearly, use the controls on your monitor to adjust the brightness and contrast until characters on the screen are clear and bright. If the display is not stable, check your monitor's horizontal and vertical hold controls.

Initial setup procedure

If this is the first time your Equity I+ has been used, you need to use the diagnostics diskette to perform an initial setup. This is a simple procedure which you must do at least once. You may need to do it again if you change your system time or date or serial port options. See your Diagnostics manual for instructions.

Initial screen display

After the computer completes its self test, a message tells you how much RAM (random access memory) is available, for example:

640KB OK

Then the following message displays:

Non-system disk or disk error
Insert system diskette in drive A:
and strike any key when ready.

This tells you that the computer can now load an operating system from a diskette in the top drive. The Equity I+ needs a disk operating system (DOS) to function. It comes with MS-DOS version 3.2. If you want to use another operating system, consult your Epson dealer.

To load an operating system, insert the system diskette you want to use (see "Inserting and removing diskettes" in Chapter 2). Refer to your MS-DOS (or other operating system) manual for details on how to use the system.

Note: Use only a backup copy of the system diskette for daily use and keep the original in a safe place. See your MS-DOS manual to find out how to make a backup copy.

If your system has a hard disk, you need to prepare it before you can run an operating system on it. Refer to “Using a hard disk drive” in Chapter 2 (and to your Diagnostics and MS-DOS manuals) for instructions on how to prepare a hard disk for use.

If your hard disk has been properly prepared and set up to automatically boot MS-DOS, the message above does not appear. Instead, the operating system loads when you turn on the computer. The date and time prompts display and then the system prompt:

```
C>
```

This indicates that the hard disk has been assigned as drive C.

Chapter 2

Using Your Equity I+

Once you have set up your Equity I+, you're ready to take advantage of its versatility. This chapter describes the special keys on the keyboard, how to change your computer's operating speed, and how to reset and turn off your computer. It also explains how to use and care for your disks and disk drives.

Special Keys

Certain keys serve special functions and are used in various ways by application programs. Some of the more important keys are shown in Figure 2-1. Table 2-1 describes each of these keys as well as others with special functions.

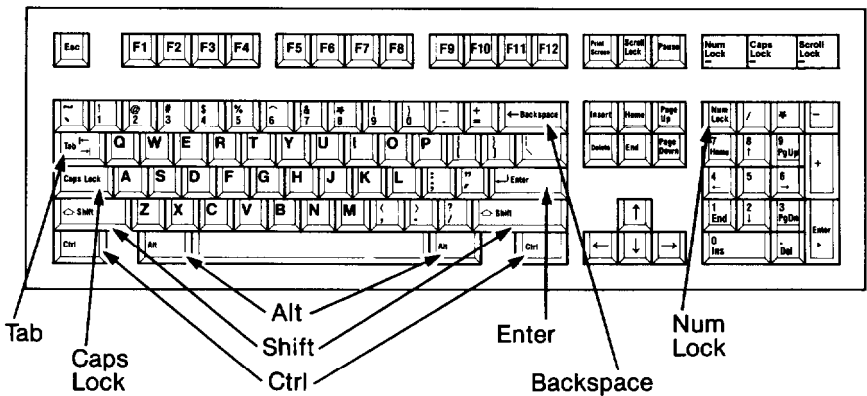

Figure 2-1. Equity I+ keyboard

Table 2-1. Special key functions

Key	Purpose
Tab ← →	Moves the cursor to the right in normal mode (and to the left in shift mode in some application programs).
Caps Lock	Changes the letter keys from lower- to uppercase; changes back to lowercase when pressed again.
Shift	Produces uppercase characters or symbols when used with the main character keys. Produces lowercase characters when Caps Lock is on.
Ctrl	Works with other keys to perform special (control) functions, such as editing operations in MS-DOS and GW-BASIC.
Alt	Works with other keys to enter alternate character codes not otherwise available on a standard keyboard.
Backspace←	Moves the cursor back one space, deleting the character to the left.
Enter↵	Ends a line of keyboard input or executes a command.
Insert (Ins)	Turns insert function on and off.
Delete (Del)	Deletes characters to the right.
Home, End, Page Up (Pg Up), Page Down (Pg Dn)	Within application programs, control cursor location.
Num Lock	Changes the function of the numeric/cursor keys from numeric to cursor positioning; changes when pressed again.
Esc	Cancels the current command line or operation.
F1 - F12	Perform special functions within application programs.
Print Screen (Prt sc)	Prints the screen display on a line printer.
Scroll Lock	Controls scrolling in some applications.
Pause	Suspends current operation.

The **Num Lock**, **Scroll Lock**, and **Caps Lock** keys work as toggles when you press them. When the function is enabled, the corresponding light on the upper-right corner of the keyboard is on. When the function is disabled, the light is off.

Selecting Execution Speed

The Equity I+ can operate at two execution speeds: 4.77MHz or 10 MHz. The first speed is IBM compatible. At the second and faster speed the Equity I+ simply performs all tasks faster. You can select the slower speed to run application programs that have specific timing requirements.

To change the speed, move the switch on the front panel as shown in Figure 2-2. To run the computer at 4.77MHz, move the switch to the left. To run it at 10 MHz, move the switch to the right. You can do this at any time without rebooting the system.

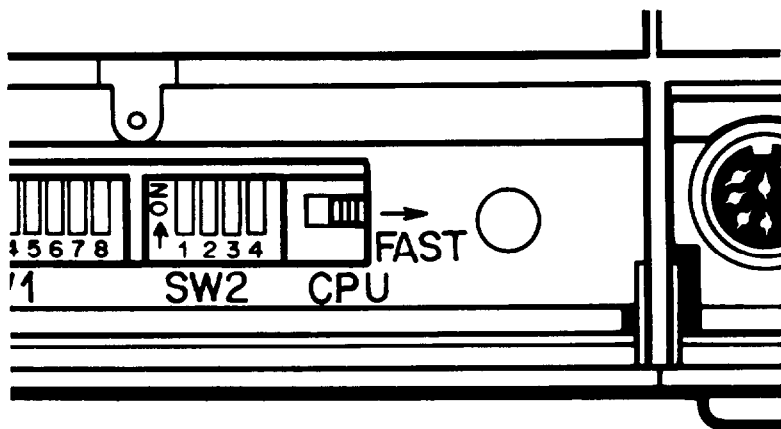

Figure 2-2. Speed switch

The power light on the front panel is red when the computer is running at 4.77MHz and green when it is running at 10MHz.

Resetting the Computer

You may occasionally need to reset the computer, either to load a different operating system, or because a program has failed and the computer does not respond to your keyboard commands. However, resetting the computer causes all data in the computer's temporary memory (RAM) to be lost, so if you have a problem, you should reset the computer only as a last resort.

WARNING: Do not reset the computer to exit a program unless you have to. Some application programs classify and store new data whenever you exit the program properly. If you reset the computer while such a program is running, you may lose data.

There are three ways to reset; you should use them in this order:

1. If you are using MS-DOS, press Ctrl and **Alt** together with the **Del** key on the numeric keypad at the right of the keyboard. The screen goes blank for a moment, and any system disk in drive A reloads. If the problem is not corrected after trying this, try the second method.
2. Press the **RESET** button under the hinged flap beneath the disk drives. This method works even when the keyboard is not responding. If this fails to have any effect, try the third method.
3. Remove any diskettes from the disk drives. Turn off the monitor and any peripherals, and then switch the Equity I+ off. Wait for five seconds, then switch the power back on.

Turning Off the Computer

Before you turn off your computer, save your data, exit the program you are using, and remove all diskettes from the disk drives. Turn off the monitor and peripherals and then turn off the main unit, using the switch on the front panel.

Using Disks and Disk Drives

The disk drives in your computer let you store your work and programs on removable diskettes for future use. All Equity I+ systems have at least one disk drive; others may also have a hard disk drive, either built-in or as an external unit.

This section gives you some background information on how disks work and tells you how to:

- Choose floppy disks (diskettes)
- Care for your disks and disk drives
- Insert and remove diskettes
- Write-protect your data
- Make backup copies
- Use a single floppy disk drive
- Use a hard disk drive.

How disks work

The floppy disks (diskettes) you insert in your system's floppy disk drives are round pieces of flexible plastic coated with magnetic material and enclosed in protective jackets. Like a record, a diskette has circular tracks on both sides. The computer stores the data you enter as magnetic patterns on these circular tracks.

A small read/write head in the disk drive interprets the magnetic patterns. When a diskette is in a drive, the read/write head is right over the large oval hole in the diskette jacket. This hole allows the read/write head to access the diskette when you store, retrieve, and delete data.

Unlike a floppy disk, a hard disk is rigid and fixed in place. It is sealed in a protective environment free of dust and dirt, so you cannot see it. A hard disk stores data the same way as a floppy disk, only it works faster and has a much larger storage capacity.

Because data is stored magnetically, you can retrieve it, record over it, and erase it - just as you play, record, and erase music on cassette tapes.

Choosing diskettes for the Equity I+

The standard floppy disk drive on the Equity I+ uses double-sided, double-density, 48 TPI (tracks per inch) diskettes. These disks are compatible with those used for the IBM PC. You can use diskettes prepared and used with one IBM-compatible computer on the other.

For best results, use only high-quality diskettes with reinforced hub rings-the added reliability is well worth the extra cost. Be sure to select diskettes that are double-sided, double-density. Each diskette can hold 360KB of data, the equivalent of about 150 pages of text.

If you have an optional floppy disk drive that has a capacity of 720KB, use **3 1/2"**, double-sided, highdensity, 135 TPI diskettes. Each high-density diskette holds 720KB of data, approximately 300 pages of text.

Caring for your disks and disk drives

To avoid damaging diskettes and hard disks, you need to care for them properly. Follow these basic precautions to avoid losing data:

- Keep disks away from dust and dirt. Small particles of dust or dirt scratch the magnetic surface (destroying data). Dust can also ruin the read/write head in the disk drive.

- Keep disks away from magnetic fields. (Remember that disks store their information magnetically) There are many sources of magnetism in and around your home or office, such as electrical appliances and telephones, and particularly loudspeakers.
- Keep disks in a moderate environment. They work best at normal room-temperature and humidity conditions. Never leave them sitting in the sun, or in extreme cold or heat. The temperature inside a car in the middle of summer or winter can cause severe damage.
- Never touch the diskette's magnetic surface. The oils on your fingertips can damage the surface of the disk. Always hold disks by their protective jackets. On a 720KB diskette, do not expose the diskette's surface by sliding the metal plate.
- Store diskettes properly. Keep them in their protective envelopes when they are not in use, and store them in a diskette container.
- Do not place anything on top of your disks. They bend easily and do not rotate properly in their sleeves if they are damaged.
- Never wipe, brush, or try to clean diskettes in any way.
- Be careful when you label your diskettes. Attach labels firmly but gently, and only along the top of the disk (next to the manufacturer's label). Avoid placing several labels on top of one other. They may prevent the diskette from spinning freely in the disk drive.
- It is best to write on the label before placing it on the disk. Use only soft-tip pens, not ballpoint pens or pencils, to write on a label that is already attached to a disk.
- Do not remove a diskette or turn off the computer while the drive light is on. This light indicates that the computer is copying data to or from a disk. If you interrupt this process, you can destroy data.
- Remove all diskettes before you turn off the computer.

If you have a hard disk drive, you should also take these additional precautions:

- Never turn off the power to the computer when the hard disk LED lamp is on. This LED indicates that the computer is in the middle of reading from or writing to the disk. If you interrupt this process, you can lose data.

- Never attempt to open the hard disk unit. The disk itself is enclosed in an air-tight container to protect it from dust.
- If you plan to move the hard disk unit, the read/write head must be moved away from the disk recording area. The MS-DOS program to protect the read/write head is HDSIT. Refer to your Diagnostics or MS-DOS manual for details.

Inserting and removing diskettes

To insert a diskette into a disk drive, hold it with the label face up and the write-protect notch to the left (so that the read/write slot is away from you). Then slide it into the disk drive as shown in Figure 2-3. Be careful not to force the diskette into the slot. When it is all the way in, push in the disk lock/release button to secure the diskette in the drive. This enables the read/write heads to access the diskette.

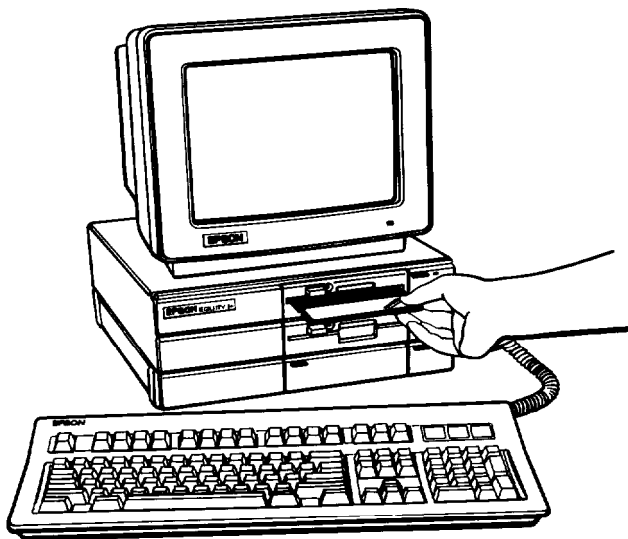

Figure 2-3. Inserting diskettes

To remove the diskette, press the button again. As you release it, the labelled edge of the diskette pops out. Carefully pull out the diskette, place it in its protective envelope and store it properly,

Note: You need to format your blank diskettes before you can use them with your operating system. Refer to your MS-DOS or other operating system manual for instructions on how to format your blank diskettes.

There are two ways to avoid losing the valuable information stored on your disks; write-protect your diskettes and make backup copies. Both of these methods are described below.

Write-protecting diskettes

You can write-protect a diskette to prevent its data from being altered. When a diskette is write-protected, you can copy data from it, but you cannot store new data on the diskette or delete any files it contains. If you try to change data stored on a write-protected diskette, an error message displays.

To write-protect a 5¼" diskette, cover the small, rectangular notch shown in Figure 2-4, with an adhesive write-protect tab. Write-protect tabs usually come with new 5¼" diskettes when you buy them.

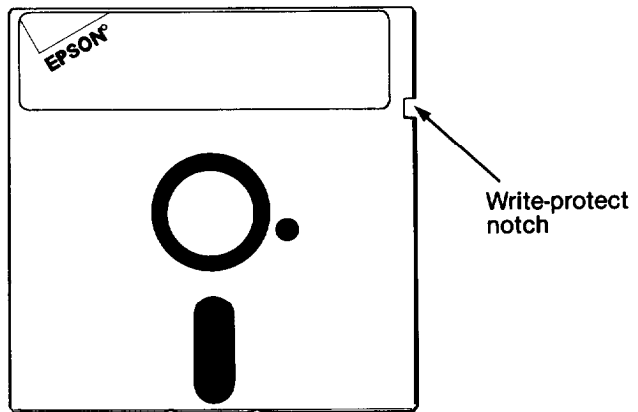

Figure 2-4. Write-protect notch

To unwrite-protect a 5¼" diskette, remove the write-protect tab.

On a 3½" diskette, the write-protect device is a small switch on the lower-right corner on the back, shown in Figure 2-5. To write-protect this diskette, slide the switch down toward the edge, of the diskette so there is a hole where the switch used to be.

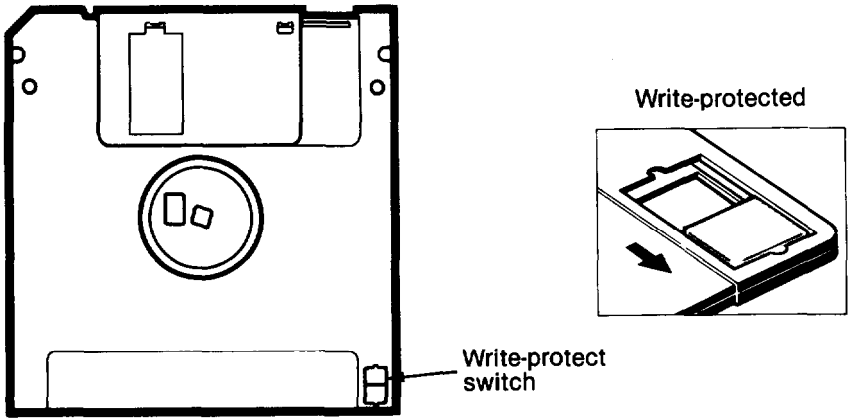

Figure 2-5. Write-protect *switch*

To unwrite-protect a 3½" diskette, move the switch up toward the center of the diskette so the hole is covered.

Making backup copies

It is a good idea to make copies of all your important data and program diskettes. With program diskettes, or the system master diskette supplied with your Equity I+, you should use backup copies, and keep the originals in a safe place—away from your working disks. Copy your data disks regularly (preferably daily), and keep them apart from the originals.

Your MS-DOS manual describes how to make a backup of your MS-DOS system disk. To make regular backups of other MS-DOS disks, use the DU (Disk Utility) program or the DISKCOPY command.

“Using a hard disk drive,” below, gives more information on how to back up hard disks.

Using a single floppy disk drive

Some Equity I+ systems have only one floppy disk drive. For the computer to function correctly, it needs to know how many floppy disk drives it has. DIP switches 1-7 and 1-8 tell the computer how many disk drives it has. If your computer has only one drive, set both switches on. If it has two floppy disk drives, set switch 1-7 off and switch 1-8 on.

An operating system expects the computer to have at least two physical disk drives. MS-DOS recognizes drives A and B for two floppy disk drives, or A and C for a floppy and a hard disk drive. Some operations, such as copying files from one disk to another, require two drives. With MS-DOS, if you have only one physical disk drive, the operating system lets you treat it logically as two drives.

For example, if you give a command to copy from drive A to drive B, MS-DOS copies from the first diskette you place in the drive (A) to the computer's memory. Then it prompts you to insert the disk for drive B. It copies from memory to the B disk you place in the drive. When the copy is complete, the screen prompts you to reinsert the original diskette in drive A.

You may be swapping diskettes this way quite often, and it is easy to forget which disk is which. To avoid accidentally losing your data, here is a tip for keeping the disks straight: always hold the disk for drive A in your left hand and the disk for drive B in your right. Another way to avoid writing on the wrong disk is to write-protect your source disk. This allows you to read information, but not write over it.

For more information on using a single floppy disk drive with MS-DOS, see your MS-DOS manual.

Using a hard disk drive

The Epson hard disk for Equity I+ has a capacity of 20 megabytes—about 20 million characters. This is equivalent to around 60 floppy disks. Using the hard disk greatly reduces the number of floppy disks you need and eliminates much of the disk-swapping you have to do. You can do almost all your work on the hard disk and copy your files to diskette as needed (to make backups, for example).

Although it has a lot of storage space, you should keep only the files you use regularly on the hard disk, to make sure you always have plenty of space available. Store your other files on diskette (you can use the ARCHIVE utility or BACKUP command in MS-DOS to back up your hard disk files). It is very important to back up all your hard disk files on floppy disks. The hard disk is very reliable, but you should always have backup copies in case you lose any of your data from the hard disk.

You need to prepare your hard disk before you can use it. If you are using a hard disk other than Epson's, follow the preparation instructions provided with your hard disk.

Before you use the Epson internal hard disk, you must do the following things to prepare it:

- Use the Format Hard Disk program on your diagnostics diskette to format the hard disk.
- Partition the hard disk to run the MS-DOS operating system using the MS-DOS program FDISK.
- Format the MS-DOS partition with the MS-DOS program SELECT.
- Copy the MS-DOS utility programs to the hard disk using SELECT

For instructions on running the diagnostics program, see your Diagnostics manual. For instructions on how to use the MS-DOS programs, refer to your MS-DOS manual. If you plan to use an operating system other than MS-DOS, you also need to use that operating system to partition the hard disk and copy the system files to it.

Note: Your MS-DOS manual states that you need to run the Setup program on the diagnostics diskette before you format the hard disk, but you do not do this on the Equity I+.

Installing Option Cards

Option cards are accessories you can add to your Equity I+ to provide extra system capabilities. For example, you may want to install a memory expansion card or an auto-dial modem.

You can install up to five option cards in the Equity I+ at one time, but one position is always occupied by the video card that operates your monitor.

Option cards are available from Epson as well as other vendors. In addition, multifunction boards (available from other vendors) allow you to add other features without using additional slots. Consult your Epson dealer for more information.

Before you install an option card in your main unit, you need to remove the cover from your Equity I+.

This chapter describes how to:

- Remove and replace the main unit's cover
- Install and remove an option card.

Removing the Cover

WARNING: Never open the case of the Equity I+ while it is plugged into an electrical outlet. Turn off the power switch to the main unit and any other peripheral devices connected to it, wait for a few minutes, then unplug the power cable before removing the case.

1. If the monitor is on top of the computer, disconnect it and move it to one side. Disconnect the keyboard and set it out of the way too. Turn the main unit around so that the back panel faces you.

2. The back panel is secured with three screws as shown in Figure 3-1. Remove the screws and put them to one side. Slip the back panel off the main unit.

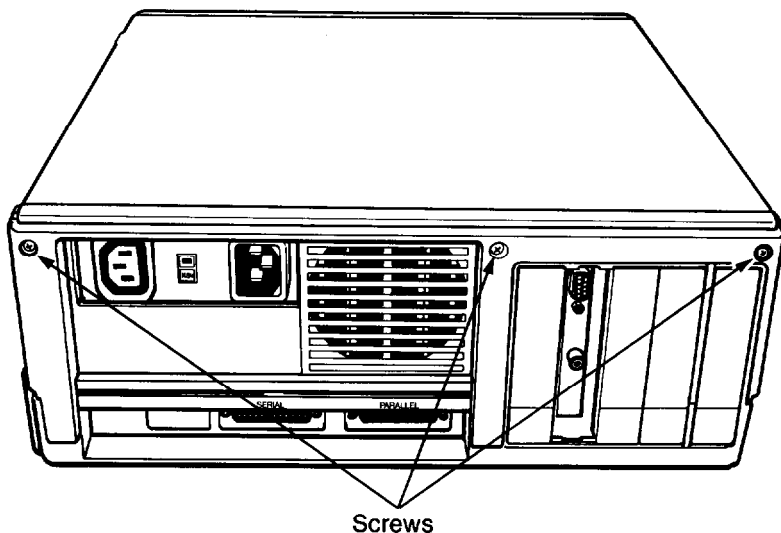

Figure 3-1. Back panel screws

3. The top cover is secured by two screws on each side of the computer as shown in Figure 3-2. The two screws on the left side of the unit are covered by small plastic inserts. Gently remove the inserts with a small screwdriver, then remove the screws on both sides of the computer. Put the screws and inserts safely to one side.

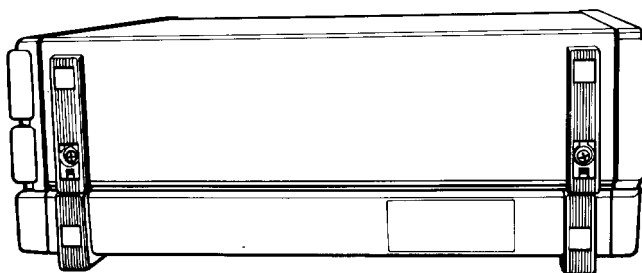

Figure 3-2. Side screws under plastic inserts

4. Tilt the cover up slightly from the back and pull it toward you and away from the main unit, as shown in Figure 3-3. Set the cover aside for now.

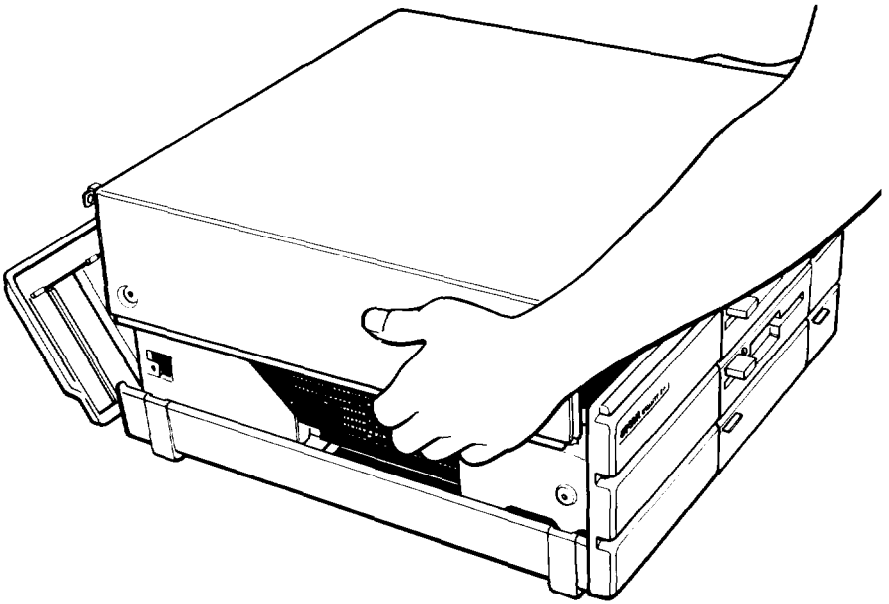

Figure 3-3. Removing cover

Inserting the Option Card

The video card must be placed in the 4th slot. Figure 3-1 shows the correct placement of a video card. Most other option cards can be placed into any of the four remaining option slots, but some cards may need to be installed in a specific slot. Check the option card manual to find out if the option card has to be in a specific slot.

Even though option cards are designed to fit only one way, it is a good idea to examine the card first and follow the instructions closely.

1. Determine which option slot you are going to use, then remove the retaining screw and washer from the metal cover plate at the back of the slot. Lift out the metal cover and put it in a safe place in case you later remove the option card. Keep the screw and washer to secure the option card to the computer.
2. Unpack the option card and read all instructions that come with it. Then adjust any switches or jumper connections that are necessary.

Note: Pay specific attention to the warnings in your option card instructions. Some devices have delicate CMOS chips you should not touch.

When you handle the card, be careful not to touch any of the contacts on the circuit board, especially along the gold edge connections. If you need to put it down before installing it, place it with the component side facing down on top of the original packing. Keep the card's original packing materials in case you remove the card later.

3. Grip the card firmly by the top corners. The contact pins should be pointing down and the components should face toward the inside of the main unit.
4. Insert the card straight down into the slot as shown in Figure 3-4. Place the tab at the bottom of the retaining bracket into the corresponding notch at the back of the computer.

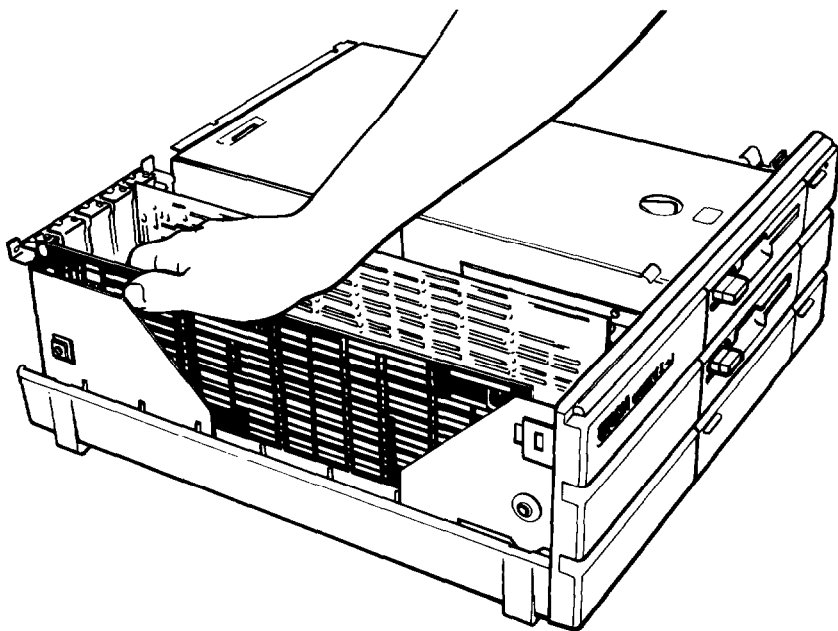

Figure 3-4. Inserting option card

5. Once the connector pins are sitting in the connector slot, push down firmly (but carefully) to fully insert the card. If the connector does not seem to be going in smoothly, do not force it; pull it all the way out and try again. Be sure to keep it straight.

- Secure the retaining bracket to the frame of the computer with the small screw and washer. Also replace the ground screw if there is one. The free end of long option cards is held in position by a piece of foam inside the top of the main unit lid and by the card bracket on the inside of the front panel.

Removing an access slot cover

Some option cards, such as your video monitor card, have an outlet for connecting an external device. If you install an option card that has an external connector for other equipment, (your video monitor, for example), you need to remove the metal access slot cover on the computer's back panel that corresponds to the option card slot. Follow these steps:

- Hold the back panel of the computer with the inside facing you. The individual access slot covers are held in position by a tab at the bottom and a clip at the top.
- Remove the appropriate cover by pushing down on the clip and pushing out. See Figure 3-5. Save the cover in case you need to remove the option card.

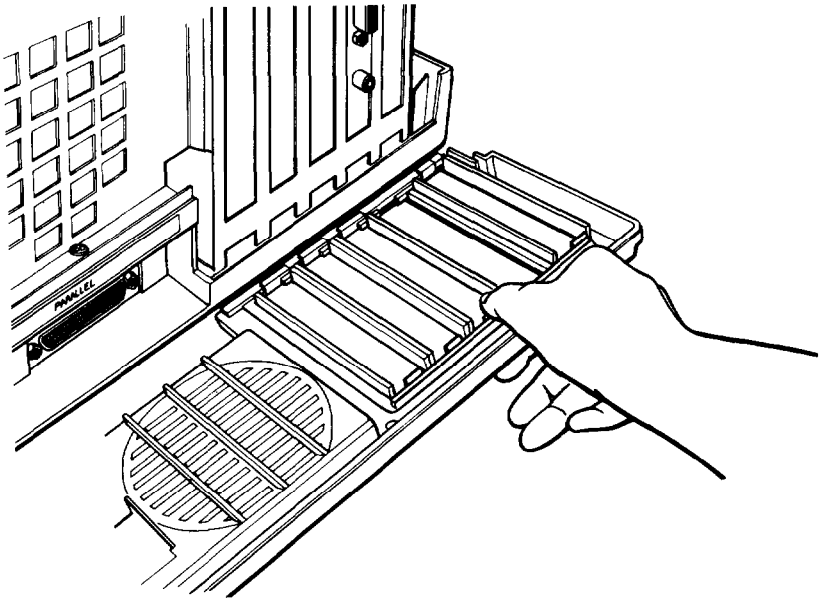

Figure 3-5. Removing access slot cover

Replacing the Cover

With the option card properly installed or removed, the last step is to replace the cover of the main unit:

1. With the back of the main unit facing you, position the cover over the computer with the side feet to the left of the main unit and the front edge pointing slightly downward.
2. Lower the cover onto the bottom half of the case, as shown in Figure 3-6, making sure that the bottom edges fit inside the case. At the same time, slide the front edge beneath the top edge of the front panel. Finally, lower the back of the cover so that it is in position.

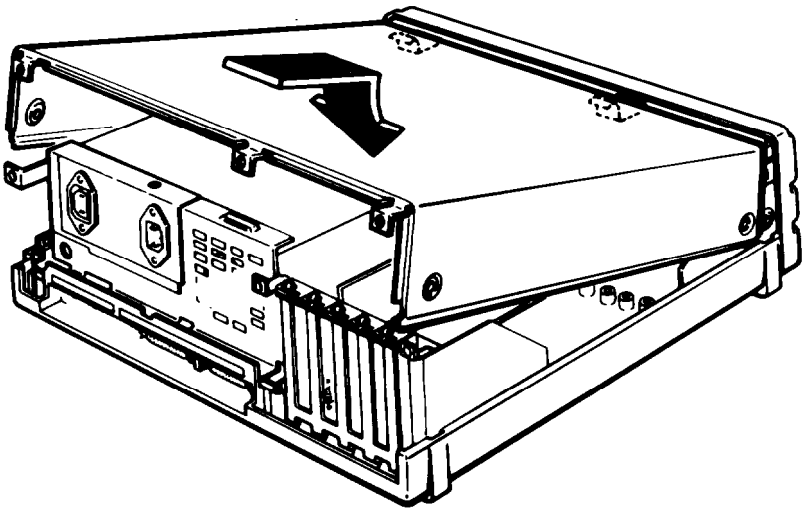

Figure 3-6. Replacing the cover

3. Secure the cover by replacing the screws on both sides of the main unit. Snap the plastic inserts into the side feet.
4. Replace the back panel and the three screws along the top edge.
5. Return the computer to its original position and reconnect it to the monitor, the keyboard, and any other peripherals you have.
6. Check to make sure the power switch is off. Reconnect the power cable to the back of the main unit and to an electrical outlet. Change the DIP switches if necessary.

Post-installation Setup

After you install an option card (and replace the main unit's cover and reconnect the power cord and peripherals), you may need to change your DIP switches to update the configuration information. For example, if you add a floppy disk drive, you need to change switches 1-7 and 1-8 so the computer knows it has the additional drive.

You may also need to add some commands in the configuration files on your system disk as well. See your MS-DOS manual for instructions.

When you finish installing an option card and reconfiguring the system, you should test the option if possible. Some option cards come with their own diagnostic test programs, and you can test others with your diagnostics diskette. These tests include:

- Expansion memory
- 8087 math coprocessor
- Serial and parallel ports
- Monitors and display adapters
- Disk drives.

See your Diagnostics manual for instructions.

Removing Option Cards

To remove an option card, first turn off the computer and unplug the power cord, then detach any cable connected to the card. Disconnect the monitor and keyboard, and remove the main unit cover. Then follow the option card installation instructions in reverse.

Follow the same safety instructions and make sure you pull the card straight up and out of the connector to avoid damaging it. Rewrap the card (preferably with the original packing materials) and place it inside the packing box for safe storage. Replace the metal access slot cover before you replace the computer's cover. If the card you removed had an external connector you also need to replace the plastic access slot cover on the back of the computer. When you have reassembled the unit, remember to reset any DIP switches if necessary.

Troubleshooting

You should not encounter any serious difficulties with the Equity I+, but if anything out of the ordinary does happen, this section should help. Such a situation usually requires nothing more than repeating a software procedure, correcting an operating system error, or resetting the computer.

Most of the minor difficulties you might encounter can be resolved by one of the suggestions below. If none of these solves the problem, consult an Epson dealer about servicing the computer.

WARNING: If the computer has to be turned off for any reason, always wait at least five seconds before switching it back on. Turning it off and on rapidly can damage the computer.

The Computer Fails to Start Up

If the computer does not start up when you press the power switch on, follow these steps to find a solution:

1. Check to see if the power indicator on the main unit is lit. If it is not, remove any disks and turn the power off. Wait five seconds and turn the power back on.
2. If the lamp still does not come on, turn the power switch off. Then check to see that the power cable is securely connected to the electrical outlet. Try turning the power switch on again.
3. If this fails, check the electrical outlet. Plug a portable lamp into the outlet you are using for the computer, and turn it on to see if it supplies power.

The Video Display Does Not Appear

If the computer starts up but no image appears on the screen, follow these steps to find a solution:

1. Check to see that the power indicator on the monitor is lit. If it is not, turn the power off, wait five seconds, then turn the power back on. Wait to see if the display screen appears.

2. Use the controls on the monitor to adjust the brightness and contrast.
3. Check DIP switches 1-5 and 1-6 on the front of the main unit to make sure they are set correctly for your monitor.
4. Remove any diskettes, then turn off the monitor and main unit. Check to see that the monitor power cable is securely connected to the electrical outlet, and that the monitor cable is properly connected to both the monitor and the main unit. Turn both power switches on again.
5. With the computer turned off, check the electrical outlet for power. Plug a portable lamp into the outlet you are using for the monitor, and turn it on to see if it supplies power.

The Computer Locks Up or Freezes

If the computer appears to be locked up and does not respond to the keyboard, try the following:

1. Wait a few seconds. Some operations take longer to perform than others. For example, a spreadsheet program takes longer to recalculate an entire spreadsheet than to simply enter a figure. Also, some BASIC programs that have a lot of calculations to perform can take several minutes, or even hours, to finish. Be aware of the task the computer is performing and judge the time period accordingly.
2. If the computer remains locked up, follow the steps in Chapter 2 under "Resetting the Computer."

Floppy Disk Problems

There are many kinds of disk problems that could occur, and just as many reasons for them happening. If you are having trouble with your diskettes, check the following questions:

1. Is your diskette damaged? If you are getting bad results of any type, the disk could be damaged. Just to be sure, try your backup diskette to see if the same problem occurs. If the backup works, the first diskette is probably damaged. Make another working copy from your backup.
2. Do you have the right type of diskette? In a 360KB drive, use double-sided, double-density, 48 TN, 360KB diskettes. In a 720KB drive, use double-sided, high-density, 135 TPI, 720KB diskettes. The diskette type is normally shown on the manufacturer's label.

3. Is the diskette write-protected? A write-protect tab or switch may be in place to protect the data on the disk. Think twice before removing the tab or moving the switch. It might be a new diskette, but it might also be a diskette with information you do not want to change or lose. Check the diskette directory to determine what files it contains. The operating system manual gives the proper directory command. Although you should normally write-protect program diskettes, there are some programs which use the program diskette for temporary files, and these do not work if the diskette has been write-protected.

Hard Disk Problems

If you have problems with your hard disk when you first start to use it, check to see if it has been set up properly. See "Using a hard disk drive" in Chapter 2 and refer to your MS-DOS manual.

If you cannot access data stored on your hard disk, you may have accidentally repartitioned or reformatted part or all of the hard disk. If you have not done so and your hard disk does not function properly, have an authorized Epson service center check your hard disk. Never open the air-tight container that encloses the recording disk.

Software Problems

If you have trouble with a software program, check the following list of possible problems and solutions:

1. The software program does not start. First check that you are following the right procedure for the operating system you are using. Make sure that a system disk has been placed in drive A.
2. An application routine does not work. Refer to the software manual and complete the routine according to the instructions in the manual. If this does not work:
 - Start from the beginning by following the reset procedure described in Chapter 2. Restart the program and try the routine again after the computer has been reset.
 - Some software programs may need the DIP switches to be set a particular way to work properly. Make sure that the DIP switches are set correctly for the type of monitor, the amount of memory, and the number of disk drives you have. The DIP switch settings are listed in Chapter 1. Always turn off the computer before changing the DIP switches. The new settings are not read by the computer until you turn it back on.

- Some programs, for compatibility reasons, may require the computer to run at 4.77MHz. Try changing the CPU speed with the switch on the front panel. See “Selecting Execution Speed” in Chapter 2.

Printer Problems

Most of the problems encountered while using a printer can be solved by checking the manual that came with the printer. If the printer is not working correctly and has just been installed, first make sure the printer has power and is correctly connected to the computer. The printer manual provides instructions on cable connections.

If you have a serial printer, or if you have problems with paper feeding, you may also need to check the printer manual for the correct DIP switch settings. The DIP switches on a printer help it communicate properly with the computer.

Option Card Problems

If you have installed an option card and get unexpected results, double-check the following points:

1. Is the option card installed correctly?
2. Did you follow the setup and operating instructions described in the option card manual?
3. Did you set any necessary DIP switches or jumpers on the option card? See your option card instructions.
4. Did you set any necessary DIP switches on the main unit? See “Setting the DIP Switches” in Chapter 1.
5. Did you change any necessary jumper settings in the main unit? See Appendix A, “Changing Jumper Settings.”
6. If you added an external device, did you use the proper cable to connect the peripheral to the port or option card connector on the rear panel?
7. Did you perform any necessary post-installation setup procedures for the operating system? See your Diagnostics, MS-DOS, or other software manual for instructions.

Appendix A

Changing Jumper Settings

This appendix describes how to set the jumpers inside the Equity I+ if you install optional devices that require different jumper settings than those set by the factory in the main unit. It is best if your dealer installs the option and makes all necessary adjustments when you buy it. If you decide to do it yourself, be very careful when you follow the procedures in this appendix. There are many system components which can be damaged accidentally.

Jumpers are small electrical connectors that alter some of the computer's functions. A jumper's setting is determined by where the jumper is placed: either between pin A and the middle pin (position A) or between pin B and the middle pin (position B). Figure A-1 shows both positions.

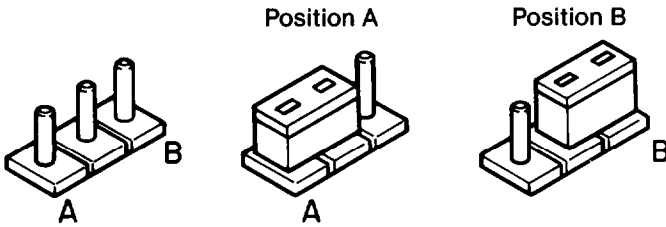

Figure A-1. Jumper positions

To move a jumper from one position to another, use needle-nose pliers or tweezers to lift it off the board and gently move it to the other position. Be careful not to lose the jumpers or leave them out of the computer.

Jumper J1, Floppy Disk Controller

The built-in floppy disk controller in your Equity I+ can control four 360KB (5¼") or 720KB (3½") floppy disk drives; therefore, you should not ordinarily need to install any other type of floppy disk controller. However, some manufacturers produce combined hard disk and floppy disk controller cards which you may want to use to control all the drives installed in your computer. To allow an optional controller to control your floppy disk drives, you must connect the drives to the option card, and disable the Equity I+ built-in controller.

For detailed instructions on how to connect the drives to the optional floppy disk controller card, consult the documentation supplied with the card itself. The drive cables for drives A and B are normally connected to connector CN5 on the system board (shown in Figure A-2). If a different cable was supplied to connect the drives to the optional controller card, make a careful note of how the original drive cable was connected, and remove it from the computer. Keep it in a safe place, in case you need to remove the optional controller for any reason.

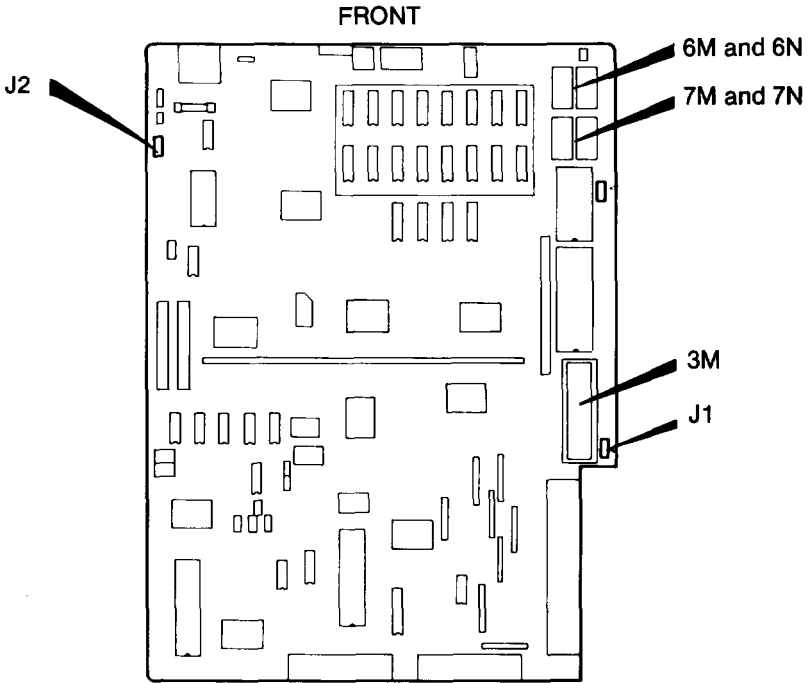

Figure A-2. Jumper locations

To disable the built-in floppy disk controller, you must first remove the cover of the main unit (see "Removing the Cover" in Chapter 3). Then locate Jumper J1 on the main system board, near the option slots, as shown in Figure A-2. You may need to remove an option card from slot number five in order to access this jumper. The factory setting is position A. To disable the internal floppy disk controller, move the jumper to position B. If you have also installed an additional disk drive, remember to adjust the appropriate DIP switches on the front panel to match the number of drives installed.

Jumper J2, Parity RAM

Parity RAM enables the computer to make sure that the data stored in its memory is valid. The Equity I+ can support parity RAM to give you added protection against loss of data. Installation of parity RAM is a simple process, but you should ask your dealer to do it for you, as well as test the RAM carefully. If you decide to install the parity RAM yourself, follow the instructions below carefully.

You need to install four RAM chips. After you remove the cover of the computer (see "Removing the Cover" in Chapter 3) locate sockets 6M, 6N, 7M, and 7N. See Figure A-2. Sockets 6M and 7M require 50256 or 51256 type (256KBitxl) chips; sockets 6N and 7N require 4164 (64KBitxl) chips.

When you insert the chips you must be absolutely certain that each one is installed correctly, with the notch toward the back of the computer.

Once the chips are installed, locate jumper J2, as shown in Figure A-2.

To reach jumper J2 you need to remove the shielding over the power supply by removing the two screws shown in the diagram below. Replace the shielding after you move the jumper.

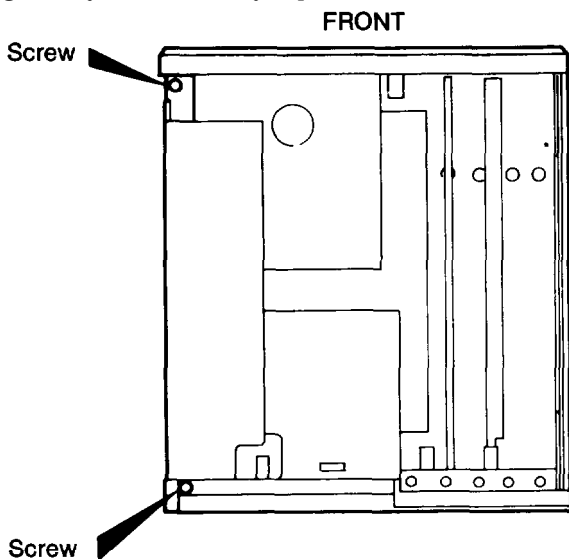

The factory setting for this jumper is position A. To enable the newly installed parity RAM, J2 must be moved to position B.

If a fault occurs in the parity RAM, the computer displays a message during the power-on diagnostics tests. You can continue work by adjusting Jumper J2 to disable the parity RAM, but other errors may also occur, and you should report the problem to your Epson dealer as soon as possible.

Appendix B

Specifications

Main Unit

16-bit CPU	8088 microprocessor; 4.77MHz. or 10MHz clockrate; switch selectable
Main memory	640KB
Coprocessor	8087 microprocessor (optional)
Read Only Memory (ROM)	16KB
Direct Memory Access (DMA)	Programmable DMA controller with four channels—two on the mother board (one for refreshing and one for floppy disk controller), two available for user peripherals including a hard disk controller
Interrupt (8259)	Programmable interrupt controllers, 8 interrupt levels
Timer/counter (8253-5)	Three programmable timer/counters
Clock/calendar RAM	Real-time clock, calendar, and 50-byte CMOS RAM for configuration, battery back-up
Parallel interface	Standard 8-bit parallel, DE25 female connector; programmable
Serial interface	RS-232C, asynchronous, DE25 male connector; programmable
Speaker interface	Internal, controlled by timer/counter
Option slots	Five IBM-compatible input-output expansion slots

Keyboard

	Detachable, three positions, 101 sculpted keys
Layout	58-key QWERTY main keyboard, 17-key numeric pad, 12 function keys (user-definable)
Function keys	Three levels (normal/shift/alternate) user-definable

Mass Storage

	Four drives maximum
Standard	5¼-inch, half-height floppy disk drive; double-sided, doubledensity, 360KB storage capacity
Optional	3½-inch, half-height floppy disk drive; double-sided, high density, 720KB storage capacity
Hard disk drive	3½-inch, half-height internal hard disk drive; 20MB storage capacity (formatted)

Power Supply

Switching type, fan-cooled	Output voltage: -5 VDC, +5 VDC, - 12 VDC, + 12VDC Auxiliary AC Power Requirements: 115/230 VAC Power Rating: 83W average, 102W peak
----------------------------	---

Environmental Requirements

Temperature	Operating range: 25° to 90°F (-5° to 35°C) Nonoperating range: 0° to 149°F (-40° to 60°C)
Humidity	Operating range: 20% to 80%, non-condensing Nonoperating range: 10% to 90%, non-condensing

Physical Characteristics (CPU Only)

Width, 14.4" (365mm)

Depth, 14.8" (376mm)

Height, 5.7" (145mm)

Weight, 28.8 lbs. (9kg with one floppy disk drive)

Video and Display Options

Monochrome video card

Supports Epson or IBM-compatible monochrome monitor; 80-character x 25-line display; 9 x 14 character block; installs in option slot

Color/graphics video card

Supports Epson- or IBM-compatible RGB color or composite video monitor; 40-character x 25-line display (low-resolution text); 80-character x 25-line display (high-resolution text); 640 x 200 (high-resolution graphics), 320 x 200 four colors, 160 x 200 eight colors; installs in option slot

Multiple graphics video card

Supports Epson- and IBM-compatible monochrome or color monitor; monochrome text, color graphics, and Hercules™ (monochrome) graphics, switch-selectable; installs in option slot

Enhanced graphics video card

Supports Epson- and IBM-compatible monochrome, color; or enhanced color monitor; monochrome text (80-character x 25-line display), Hercules text (80-character x 43-line display); color graphics, 640 x 200 pixels B/W; monochrome graphics, 640 x 350; color/graphics, 640 x 350, 16 colors

TTL green or amber monochrome monitor (12-inch diagonal)

High-persistence, P-39 phosphor screen; etched surface to reduce glare; 22 MHz video bandwidth; 35 W

RGB color monitor (13-inch diagonal)

High-contrast screen; 16 colors; etched surface to reduce glare; 18 MHz video bandwidth

Appendix C

Glossary

ASCII

American Standard Code for Information Interchange. A standardized coding system for representing characters, such as numbers, letters, and graphic symbols. An ASCII character occupies one byte of storage. Files transmitted in ASCII code can be used by many different computers, printers, and programs.

Asynchronous

A method of data transmission in which one machine sends data one character at a time to another, without either machine preparing for the transmission.

Backup

An extra copy of a program, data file, or diskette, kept in case your working copy is damaged or lost.

Bit

A binary digit (0 or 1). The smallest unit of computer storage. The value of a bit represents the presence (1) or absence (0) of an electric charge.

Boot

To load a program or an operating system.

Byte

A sequence or group of eight bits that represents one character.

Character

Anything that can print in a single space on the page or the screen. Includes numbers, letters, punctuation marks, and graphic symbols.

CMOS

Complementary Metal-Oxide Semiconductor. A method for making silicon chips.

Code

A system of symbols for representing data or instructions. Also any software program or part of a program.

Command

An instruction you enter on the keyboard to direct your computer to perform a specific function.

Configuration

The particular setup of a group of components. For example, a CPU with two floppy disk drives, connected to a monochrome monitor and a printer is a typical system configuration.

Control code

A command (generated when you hold down Ctrl and press another key on the keyboard) that instructs your computer to perform a specific function.

CPU

Central Processing Unit. The piece of hardware which interprets instructions, performs the tasks you indicate, keeps track of stored data, and controls all input and output operations.

Cursor

The highlighted marker which shows your position on the screen and moves as you enter and delete data.

Data

Information stored or processed by a computer.

Data diskette

A formatted diskette used to store files.

Diagnostics

The tests and procedures the computer performs to check its internal circuitry and set up its configuration.

DIP switches

Small switches on a piece of hardware such as a CPU, a printer, or an option card. DIP switch settings control various functions and provide a system with information about itself. DIP stands for Dual In-Line Package.

Directory

A list of the files stored on a disk or a part of a disk.

Disk

The collective term for both hard disks and floppy disks (diskettes).

Disk drive

The physical device which allows the computer to read from and write to a disk. A floppy disk drive has a disk slot on the front panel of the main unit into which you insert diskettes. A hard disk is permanently fixed inside the main unit, hidden behind the front panel.

Diskette

A flat piece of flexible plastic coated with magnetic material and used to store data permanently. Also called floppy disk.

DOS

The Disk Operating System that controls the computer's input and output functions. See Operating system.

Double-density

A type of diskette format that allows you to store twice as much data as the standard density format. A double-density diskette for the Equity I+ has a storage capacity of 360KB.

File

A group of related pieces of information called records, or entries, stored together on disk. Text files consist of words and sentences. Program files consist of code and are used by computers to interpret and carry out instructions.

Floppy disk

See Diskette.

Format

To prepare a new disk (or erase an old one) so it can receive information. Formatting a disk divides it into tracks and sectors which create addressable locations on it.

Graphics

Lines, angles, curves, and other nonalphanumeric data.

GW-BASIC

Microsoft's extended version of the Beginner's All-purpose Symbolic Instruction Code. A programming language designed to be easy to use and understand.

Hard disk

The enclosed unit used to store data permanently. Unlike a floppy disk, it is fixed in place. It can process data more rapidly and store many more files than a floppy disk.

Hardware

Any physical component of a computer system, such as a monitor, printer, keyboard, or CPU.

Input/output port

See Port.

Interface

A physical or software connection used to transmit data between equipment or programs.

Jumper

A small electrical connector that alters some of the computer's functions.

Kilobyte (KB)

A unit used to measure storage space (in a computer's memory or on a disk). One kilobyte equals 1024 bytes.

LED

Light Emitting Diode. A substance that illuminates when electricity passes through it, like the indicator lights on the front panel of the Equity I+.

Main unit

The Equity I+ computer.

Megabyte (MB)

A unit used to measure storage space (in a computer's memory or on a disk). One megabyte equals 1,048,576 bytes.

Memory

The area where your computer stores data. Memory contents can be permanent and inalterable (ROM) or temporary (RAM).

Microprocessor

A small version of a CPU contained on one semiconductor chip.

Modem

A device which allows a computer to transmit signals over telephone lines so it can send and receive data. Modem stands for MOdulator/DEModulator.

Monitor

The piece of hardware that contains the screen and displays information.

Monochrome monitor

A monitor that displays in only one color, such as green or amber, as opposed to a color monitor which can display in several colors.

MS-DOS

An operating system from Microsoft. See DOS, Operating system.

Operating system

A collection of programs that allow a computer to control its operations. The operating system determines how programs run on the computer and supervises all input and output—for example, MS-DOS.

Option card

A card you install inside the Equity I+ main unit to provide additional capabilities, such as more memory or a hard disk drive.

Parallel

The type of interface which transmits data in groups of bits. See Interface, Serial.

Partition

To divide a hard disk drive into separate sections for use by different operating systems.

Peripheral

A device (such as a printer or a modem) connected to a computer that depends on the computer for its operation.

Port

A physical input/output socket on a computer where you can connect a peripheral.

Program

A disk file that contains coded instructions and tells a computer what to do and how to do it.

RAM

Random Access Memory. The part of memory that a computer can both read and write to. The programs you use are temporarily stored in RAM. All data stored in RAM is erased when you turn off the power.

Read

To copy data from one area to another. For example, when you open a text file stored on disk, the computer reads the data from the disk and displays it on the screen.

Read/write head

The physical device inside a disk drive that reads and records data on the magnetic surface of a disk.

Reset

To reload a computer's operating system so you can retry a task or begin using a different operating system. Resetting clears RAM.

RGB

Red Green Blue. An RGB monitor displays in high-resolution color.

ROM

Read Only Memory. A portion of memory that can only be read and cannot be used for temporary storage. ROM retains its contents even when you turn off the power.

RS-232C

A widely-used, standard type of serial interface. You can easily connect RS-232C-compatible devices to the Equity I+.

Sector

A contiguous section of a disk track that provides an address at which the computer can access data.

Self test

The initial diagnostics procedures a system performs to check its hardware.

Serial

The type of interface which transmits data one bit at a time. See Interface and Parallel.

Software

The programs that enable your computer to perform the tasks and functions you indicate.

System diskette

A diskette that contains the operating system.

Tracks

Addressable concentric circles on a diskette, resembling the grooves on a record, which help to divide the diskette into separate accessible areas. There are 40 tracks on each side of a double-sided, double-density diskette and 80 tracks on each side of a double-sided, high-density diskette.

Write

To store data on a disk.

Write-protect

To prevent a diskette from being overwritten by placing a write-protect tab over the notch on the side of the diskette (5¼-inch) or setting the write-protect switch (3½-inch). When a diskette is write-protected, you cannot erase, change, or record over its contents.

Index

A

Access slot cover, 3-5
AC power inlet, 1-4
AC power outlet, 1-4
Alt, 2-2
Air circulation, 1-2
Application programs, 2-1—2
ARCHIVE utility, 2-10
Arranging components, 1-3
ASCII, 1-12, C-1
Auto-dial modems, 1-5, 3-1
Auxiliary outlet, 1-4

B

Back panel screws, 3-2, 3-7
BACKUP command, 2-10
Backup copies
 daily, 2-9
 making, 2-9, C-1
Backspace key, 2-2
Bit, C-1
Booting, C-1
Brightness control, monitor, 1-8, 4-2
Button, lock/release, 1-2, 2-7
Byte, C-1

C

Cable
 connections, 1-6
 keyboard, 1-6, 1-9
 parallel, 1-10-12
 serial, 1-12
 video monitor, 1-7
Caps Lock key, 2-2
Centronics compatible connector,
 1-10
Character set, 1-12
Clock/calendar, B-1
CMOS, C-1
Color graphics
 connectors, 1-7—8
 video card, 1-7—8

Components, arranging, 1-3
Computer See Equity 1+
Configuring, C-1
Contrast control, monitor, 1-8, 4-2
Controllers
 Disk, B-1
 DMA, B-1
 Interrupt, B-1
 Printer I/O, B-1
 Serial I/O, B-1
 Timer/counter, E1
 Video/Graphic, B-3
Cooling fan, main unit, 1-18
Copying files, 2-9
Cover, main unit, 1-8
CPU, B-1-2, C-2
CPU speed switch, 1-6
Ctrl Alt Del, 2-4
Ctrl key, 2-2
Cursor, C-2

D

Data, C-2
DB-25, 1-10
Del key, 2-2
Diagnostics manual, 1-1, 1-19, 2-7,
 2-11, 3-7, 4-4
DIP switch settings, 1-13
DIP switches
 built-in interfaces, 1-16—7
 coprocessor, 1-15
 floppy disk drives, 1-15
 functions, 1-6, 1-13, C-2
 label, 1-14
 keyboard, 1-15
 location of, 1-13
 memory size, 1-15
 monitor type, 1-8, 1-15
 parallel port, 1-16-17
 RAM size, 1-15
 serial port, 1-16-17

Diskettes

- attaching labels to, 2-6
- backing up, 2-4, 2-9
- care and handling, 2-4—7
- choosing, 2-5
- comfortable environment for, 2-6
- compatibility with IBM-PC, 2-5
- floppy, 2-4, 2-9—10
- floppy, blank, 2-7
- hard disk; 2-10—11
- how they work, 2-5
- inserting and removing, 2-4, 2-6-8
- magnetic surface of, 2-5
- problems, 4-3—4
- system, 1-19
- type, 2-5
- using, 2-4; 2-6
- write-protecting, 2-4, 2-8—9

Disk drive

- hard, See *Hard disk drive*
- inserting floppy into, 2-6
- LED lamps, 1-6
- protector sheets, 1-2, 1-18
- single floppy, 2-9
- slot, 2-9
- using, 2-9

DISKCOPY, 2-9

Disk lock/release button, 1-6, 2-7

Display, monitor, See *Monitor*

DMA, B-1

DOS, C-3

DU, 2-9

E

Electromagnetic interference, 1-3

End key, 2-2

Enter key, 2-2

Environmental conditions, 1-2

Environmental requirements

- humidity, B-2

- temperature, B-2

Epson printers, 1-10

Equity I+

- cable connections, 1-6
- components, arranging the, 1-2
- disk drive, See *Disk drive*
- disk, See *Disk*
- electromagnetic interference, 1-17
- environmental conditions, 1-18
- front panel, 1-5
- main unit, See *Main unit*
- main unit cover, 3-1, 3-7
- operating system, 2-9—11
- packing materials, 1-1
- power cord, 1-6
- power switch, 1-18
- rear panel, 1-4
- resetting the, 2-3
- self-diagnostic test, internal, 1-19
- special keys, 2-1
- turning on power, 1-17
- unpacking, 1-1
- video monitor, See *Monitor*

Esc key, 2-2

Execution speed, selecting, 2-2—3

External devices, See *Option cards*

F

FDISK command, 2-11

Floppy disk

- controller, A-1-2

- drive, 2-4

- problems, 4-2-3

- using, 2-9

Format

- floppy disk, 2-9

- hard disk, 2-11

Formatting, C-3

Front panel, Equity I+, 1-5

G

GW-BASIC, 1-1

H

- Hard disk drive
 - care of, 2-9
 - internal, 2-9
 - partition, 2-11
 - problems, 4-3
 - using, 2-10
- Home key, 2-2
- HDSIT, 2-7

I

- IBM-PC
 - character set, 1-12, 2-1
 - diskette format, compatibility, 2-9
- Interrupt, 3-1
- Initial system testing message, 1-19
- Input/output ports, 1-4, 1-16
- Insert key, 2-2
- Inserting and removing disks, See *Disk*
- Interfaces
 - Clock/calendar RAM, B-1
 - Option slots, 3-3
 - Parallel, 1-10
 - Printer, 1-10
 - Serial, 1-12
 - Speaker, B-1
- Internal self-diagnostic test, 1-19

J

- Jumper settings, changing, A-1 -4, C-4

K

- Keyboard
 - adjusting the legs, 1-9-10
 - arranging the, 1-2
 - cable, 1-8
 - connecting, 1-8
 - layout, B-2
 - socket, 1-6
 - specifications, B-2
 - special keys, 2-2

L

- Labels, disk, 2-5
- LED, power, 2-6
- Location, 1-2

M

- Magnetic fields, 1-17
- Magnetic surface of diskette, 2-5
- Main memory, B-1
- Main unit, Equity I+
 - arrangement of, 1-2
 - cover, removing the, 3-1—3
 - cover, replacing the, 3-6—7
 - power switch, 1-17
 - specifications, B-1
- Mass storage capacity, B-2
- Memory expansion card, 3-3
 - connector for, 3-3
 - installing, 3-1
- Modem, C-4
- Moderate environment, for disks, 1-2, 2-6
- Monitor
 - arranging, 1-6
 - brightness and contrast, 1-8, 1-18
 - cable, 1-6
 - color, RGB, B-3
 - connecting the, 1-7
 - display, B-3
 - enhanced, B-3
 - external device connector, 1-6
 - graphics, B-3
 - monochrome, C-5
 - options, B-3
 - power switch, 1-7
 - video card, 1-7, B-3
 - video, 4-1
- MS-DOS, 1-1, 1-19, 2-7, 2-9—11, c-5

N

- Num lock key, 2-2
 - Operating system, C-5
 - loading an, 1-19

O

Option cards

- access slot cover, 3-5
- connector pins, 3-4
- connector slot, 3-4
- external device connector, 3-5
- installing, 1-13, 3-1—8
- long, 3-3
- metal cover plate, 3-5
- panel, back, 3-1
- post-installation setup, 3-7
- problems, 4-4
- retaining bracket, 3-5
- retaining screw, 3-3
- removing, 1-18, 3-7
- slots, 1-5, B-1
- washer, 3-4

Outlet

- AC, 1-4
- Auxiliary, 1-4
- grounded, 1-3

P

Packing materials, 1-1

Page up key, 2-2

Page down key, 2-2

Parallel, C-5

- cable, 1-11
- interface, 1-11, B-1
- printer port, 1-5

Partitioning, C-5

Parity, A-3

Pause key, 2-2

Peripherals, C-5

Physical characteristics, Equity I+

- depth, B-2
- height, B-2
- weight, B-2
- width, B-2

Plastic inserts, 3-7

Port, 1-16, C-5

- Power
 - inlet, 1-1
- LED lamp, 1-6, 2-6
- requirements, B-2
- sources, 1-2
- supply B-2
- switch, 1-6

Power cord, 1-1, 1-6

Power switch, 1-17

Printer

- cable, 1-11
 - character set, 1-12
 - interface, 1-10-12
 - parallel, 1-10-12
 - problems, 4-4
- Print screen key, 2-2
- Program, C-5
- Protector sheets, disk drive, 1-2

R

RAM, A-3, C-5

Read/Write head, C-6

Rear panel, 1-4

Registration cards, 1-1

RESET button, 1-6, 2-4

Resetting the computer, 2-3

Retaining screws, 3-1

ROM, B-1

RS-232C serial port, 1-5, 1-12, C-6

Rules, safety, 1-18

S

Safety, 1-18

Screws

- back panel, 3-2
 - retaining, 3-3
 - top cover, 3-2
- Scroll Lock key, 2-2
- SELECT, 2-11
- Self-diagnostic test, Equity I+
 - internal, 1-19
- Serial, C-6
 - cable, 1-12
 - interface, 1-2, B-1
 - port, RS-232C, 1-12

Setup, 1-19

Shift key, 2-2

Software, C-6

Software problems, 4-3—4

Special character set, 1-12

Speaker interface, B-1

Special keys, Equity I+, 2-1—2

Speed switch, 2-2 — 3

Squeeze locks, 1-10

Start up failure, 4-1

System

- arrangement, 1-3
- disk, C-6
- testing message, 1-19

T

- Tab key, 2-2
- Timer, B-1
- Troubleshooting, 4-1—4
- Turning off the computer, 2-4
- Turning on the computer, 1-17—19

U

- Unpacking the Equity I+, 1-1
- Using the Equity I+, 2-1—12

V

- Video monitor, See Monitor

W

- Write-protect
 - disks, 2-8—9
 - notch, 2-8
 - switch, 2-9
 - tab, 2-8
 - tab, removing, 2-8
- Writing on labels, 2-4

EPSON[®]

Diagnostics

for the Equity[™] I+

Y14499102200

IMPORTANT NOTICE

DISCLAIMER OF WARRANTY

Seiko Epson Corporation makes no representations or warranties, either express or implied, by or with respect to anything in this manual, and shall not be liable for any implied warranties of merchantability and fitness for a particular purpose or for any indirect, special or consequential damages. Some not allow the exclusion of incidental or consequential damages, so this exclusion may not apply to you.

COPYRIGHT NOTICE

All rights reserved. No part of this publication may be reproduced, stored in a retrieval system, or transmitted, in any form or by any means, electronic, mechanical, photocopying, recording or otherwise, without the prior written permission of Seiko Epson Corporation. No patent liability is assumed with respect to the use of information contained herein. While every precaution has been taken in the preparation of this publication, Seiko Epson Corporation assumes no responsibility for errors or omissions. Nor is any liability assumed for damages resulting from the use of the information contained herein. Further, this publication and features described herein are subject to change Without notice.

TRADEMARKS

Epson is a registered trademark of Seiko Epson Corporation.

Equity is a trademark of Epson America, Inc

IBM is a registered trademark of International Business Machines Corp.

MS is a trademark of Microsoft Corp.

Contents

Introduction	Intro-1
1 Running the Diagnostics	1-1
Starting the Diagnostics	1-1
The Power-on Self Test	1-1
The OPERATION MENU	1-2
Exiting Diagnostics	1-2
Diagnostics and MS-DOS Commands	1-3
2 Setting Up the System	2-1
Using the Setup Program	2-1
Setting the Real-time Clock	2-3
Changing Serial Port (RS-232C) Settings	2-5
3 Formatting a Hard Disk	3-1
Formatting and Checking Options	3-1
Conditional Format (Normal)	3-3
Unconditional Format	3-5
Destructive Surface Analysis	3-6
Non-destructive Surface Analysis	3-8
4 Formatting a Diskette	4-1
5 Performing System Diagnostics	5-1
Using the System Diagnostics Program	5-2
Modifying the DEVICE LIST	5-3
Selecting a test	5-4
Resuming from an error	5-5
System Board Check	5-6
Memory Check	5-6
Keyboard Check	5-7
Monochrome Display Adapter and CRT Check	5-8
Monochrome adapter check	5-9
Attribute check	5-9
Character set check	5-10
Video check	5-10
Sync check	5-11
Run all above checks	5-11

Color Graphics Adapter and CRT Check	5-11
Color graphics adapter check	5-12
Attribute check	5-12
Character set check	5-13
40-column character set check	5-14
320x200 graphics mode check	5-14
640x200 graphics mode check	5-15
Screen paging check	5-15
Light pen check	5-16
Color video check	5-17
Synccheck	5-18
Run all above checks	5-18
Floppy Disk Drives and Controller Check	5-18
Sequential seek check	5-19
Random seek check	5-19
Write, read check	5-19
Speedcheck	5-20
Run all above checks	5-20
Math Coprocessor Check (8087)	5-21
Parallel Port (Printer Interface) Check	5-21
Parallel Port (on Video Adapter) Check	5-22
Serial Port (RS-232C) Check	5-22
Alternate Serial Port Check	5-23
Dot-matrix Printer Check	5-23
Hard Disk Drives and Controller Check	5-24
Seek check	5-25
Write, read check	5-25
Error detection and correction check	5-26
Read, verify check	5-27
Run all above checks	5-27
6 Moving the Hard Disk	6-1
7 System-dependent Utilities	7-1
The HELP Utility	7-1
The ROMBIOS Utility	7-3
The SYSTAT Utility	7-3

Appendixes

A	Error Codes and Messages	A-1
B	Power-on Diagnostics	B-1
	System Device Check	B-1
	Clock and CMOS RAM Check	B-2
	RAM Check	B-2
	Keyboard Controller and Keyboard Check	B-2
	Floppy Disk Drive Seek Check	B-3

Tables

A-1	Error codes and messages	A-1
------------	---------------------------------------	-----

Introduction

This manual describes how to initialize your Epson® Equity™ I+ after it is assembled, and how to test the condition of your computer and peripherals. To set up and test your system, you use a set of programs called diagnostics. The five main diagnostics programs are:

Setup	Use this program when you first set up the computer, and any time you change the system's permanent date or time or the serial port configuration.
Format hard disk	Use this program to check or format the entire hard disk after installation.
Format diskette	Use this program to format a diskette for use by the System diagnostics tests. This program is provided for convenience only, so that you can format a diskette without exiting diagnostics.
System diagnostics	Use these programs whenever you add or remove optional devices, or if you suspect that the system is defective. You also run these diagnostics after moving the system from one place to another and after replacing the internal battery.
Prepare hard disk for moving	Use this program before moving the computer to another location.

The diagnostics programs are stored on your diagnostics diskette, which is labelled Diagnostics and System-dependent Utilities for the Equity I+. As well as the diagnostics, this diskette contains three utilities that are used exclusively by the Equity I+. These utilities are:

HELP	This utility provides information on the MS™-DOS commands.
ROMBIOS	This utility displays the computer name and ROM BIOS version number.
SYSTAT	This utility displays the system parameters.

Chapter 1 describes how to start the diagnostics programs, select options from the menus, and exit the programs. Chapters 2 through 6 describe each of the five programs individually, and Chapter 7 describes the three system-dependent utilities (HELP, ROMBIOS, and SYSTAT). Appendix A lists the error codes and messages that may appear during diagnostics checks, and Appendix B explains the power-on diagnostics messages.

Running the Diagnostics

This chapter describes how to start and use the diagnostics programs.

Starting the Diagnostics

To start the diagnostics programs, follow these steps:

1. Turn off the computer and wait for a few seconds.
2. Place the diagnostics diskette in drive A, and secure the disk drive.
3. Turn on the computer.

The computer tests itself, and then automatically starts the diagnostics.

The Power-on Self Test

Whenever you turn on or reset the computer, the system performs some built-in diagnostics called the power-on self test. This test checks the RAM (random access memory), keyboard, system board, and peripherals before the computer begins normal operation. For a complete description of the power-on self test, refer to Appendix B.

If the self test encounters a problem, you see an error message. The error messages are described in Appendix B.

If the self test finds a discrepancy between the equipment installed on the computer and the equipment list maintained by the computer, an error message displays. You can run the SYSTAT program (described in Chapter 7) to see the list of equipment installed and to check the current settings for your configuration.

The OPERATION MENU

After the power-on self test completes successfully, the diagnostics start and you see the OPERATION MENU:

OPERATION MENU

- 1 - Setup
- 2 - Format hard disk
- 3 - Format diskette
- 4 - System diagnostics
- 5 - Prepare hard disk for moving

- 0 - Exit to DOS for more utilities

Enter selection number:

You select one of the diagnostics programs by pressing a number from **1** to 5 and pressing **Enter**. This manual describes each menu item in the order listed on the OPERATION MENU.

Option 3, Format diskette, is included on the OPERATION MENU for convenience only. This option lets you format diskettes for use by the System diagnostics tests without exiting from the diagnostics programs.

To use the extra utility programs on the diagnostics diskette (which do not appear on this menu), select 0 from the OPERATION MENU. Then start the utility from the MS-DOS prompt.

Exiting Diagnostics

Option 0 exits the diagnostics programs in one of the following ways:

- If you have not run a diagnostics program, you see this selection on the OPERATION MENU:
 - 0 - Exit to DOS for more utilities

In this case, when you press 0 and **Enter**, you see the MS-DOS prompt.

- If you have run a diagnostics program, you see this selection on the OPERATION MENU:

0 - Exit and reset

In this case, when you press **0** and **Enter**, the system is reset. Before selecting this option, remove the diagnostics diskette from drive A and insert your system diskette so the system can hoot normally. If you want to hoot from your hard disk, make sure no diskette is inserted in drive A.

Diagnostics and MS-DOS Commands

Each choice on the OPERATION MENU corresponds to an MS-DOS command:

OPERATION MENU Choice	MS-DOS Command
Setup	SETUP
Format hard disk	HDFMTALL
Format diskette	FORMAT
System diagnostics	DIAGSYS
Prepare hard disk for moving	HDSIT

The other MS-DOS commands on the diagnostics diskette are:

SYSTAT
ROMBIOS
HELP

You can copy these MS-DOS commands, with the exception of DIAGSYS, to your hard disk or to a directory on another floppy disk. You can then execute the program as an MS-DOS command without loading the diagnostics diskette. To copy these commands, use the COPY command described in your MS-DOS manual.

You can also execute the commands directly from the diagnostics diskette, without loading diagnostics. For example, if you are logged onto drive C, and you want to prepare your hard disk for moving, follow these steps:

1. Insert the diagnostics diskette into drive A.
2. At the C) prompt, type:

A: HDSIT

3. Press **Enter**.

To use the System diagnostics program, DIAGSYS, you must always boot the system with the diagnostics diskette in drive A. If you attempt to start this program in any other way, the tests may produce strange results.

Setting Up the System

This chapter describes how to change the information stored in the computer's CMOS RAM. You can select Setup from the OPERATION MENU, or you can execute the MS-DOS SETUP command.

You must run the Setup program when you turn on your computer for the first time. You also need to use Setup if you want to:

- Permanently change the real-time clock's date or time
- Change the default settings for the serial (RS-232C) port(s).

The information you define with Setup is stored in the CMOS RAM, which is backed up by a battery. Whenever you turn on the computer, it searches the CMOS RAM for the correct installation information. If the computer discovers a difference between the information in CMOS RAM and the actual configuration, it prompts you to run the Setup program.

Using the Setup Program

To start the Setup program from the diagnostics OPERATION MENU, press **1** and then press **Enter**.

To select the Setup program from the MS-DOS prompt, type SETUP and press **Enter**.

When you start Setup, the main menu is displayed:

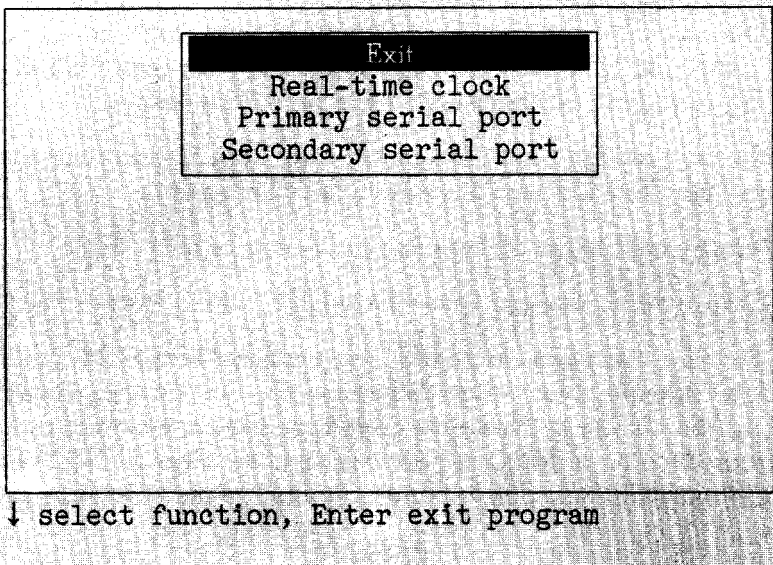

Select options from this menu using \uparrow and \downarrow to move the cursor block. When the selection you want is highlighted, press **Enter**.

Each option on the main menu (except Exit) displays another menu of choices. After making your selections on the submenu, you can exit in one of the following ways:

- To exit the submenu without making any changes, press \uparrow until the cursor block returns to the main menu, or simply press **ESC**. This cancels any changes you just made to the configuration.
- To set your changes, press \downarrow to highlight **** SAVE SETTINGS **** and press **Enter**. When you exit Setup, the changes are written to the CMOS RAM, and the computer is rebooted with the new settings.

When you finish using the Setup program, select the Exit option from the main menu. The program displays a list of the current settings you just made. Check the list before placing the settings in CMOS RAM. Below the list you see this menu:

```
Change settings
Exit without saving
** EXIT AND SAVE **
```

If any setting is incorrect, press **Enter**. The main menu is displayed again, and you can correct the setting.

If you did not make any changes, or if you want to cancel the changes you made, you can return to the OPERATION MENU or the MS-DOS prompt without re-booting the computer. Press ↓ to highlight Exit without saving, and press **Enter**.

When the settings are correct, press ↓ to highlight ** EXIT AND SAVE **, and press **Enter**. If you only changed the real-time clock, the MS-DOS prompt reappears. Otherwise, the program resets the computer using the new configuration.

If the computer displays a Setup error message during the power-on self test, run Setup again and check all your settings.

Setting the Real-time Clock

Your computer automatically keeps track of the time and date using a real-time clock. Because the clock is backed up by a battery, it keeps track of the time and date even while the computer is turned off.

The MS-DOS TIME and DATE commands, as well as many software packages, display the time and date held in the clock, but they cannot make permanent changes to the time and date settings.

Use the Real-time clock option if you need to change the time and date permanently. For example, you may need to change the clock to accommodate seasonal adjustments, such as daylight saving time. Your computer automatically adjusts for leap years. Note that even though MS-DOS and your applications programs may use a different format, the real-time clock uses a 24-hour time format to store the time.

To set the real-time clock, follow these steps:

1. On the main menu, press `↓` to move the cursor block to `Real-time clock` and press **Enter**. You see the time and date displayed like this:

19:45:55	Time
12-31-1986	Date

2. To set the time, move the cursor to `Time` and press **Enter**. You see:

hh:mm:ss

Enter the time in the exact form shown in the box, using two digits for each part; the program automatically inserts the colons (:).

When the time is correct, press **Enter**. If you enter an invalid time, the computer beeps, and the time does not change.

3. To set the date, move the cursor to `Date` and press **Enter**. You see:

mm-dd-yyyy

Enter the date in the exact form shown in the box, using two digits for the month and the day and four digits for the year; the program automatically inserts the dashes (-).

When the date is correct, press **Enter**. If you enter an invalid date, the computer beeps, and the date does not change.

4. When both the time and date are correct, press `↑` to return to the main menu to change other settings.

Note: The real-time clock settings are updated immediately, not when you leave Setup.

Changing Serial Port (RS-232C) Settings

Use the Primary serial port and Secondary serial port options to change the default parameters for the serial ports installed in your computer. The primary serial port is the one that you refer to in MS-DOS as COM1:- normally the built-in serial port. You might use this port for a serial printer, or an external modem. The secondary serial port is the one you address as COM2:- normally a serial port on an option card. This might be the name used for an internal direct modem.

For example, if you have a serial printer attached to the built-in serial port, you can use the Primary serial port option to match the computer's parameters to the printer's switch settings so that you do not need to use a MODE command to set up the serial port when it is needed.

The process for changing the default serial port settings is identical for the primary and secondary serial ports. This section uses the primary serial port as an example.

To alter the primary serial port parameters, move the cursor to Primary serial port and press **Enter**. You see a menu of serial parameters similar to this:

```
Baud rate      110 bps
Parity         None
Data length   8 bits
Stop bits     1 bit(s)
*** SAVE SETTINGS ***
```

To set the speed of communication, move the cursor to Baud rate and press **Enter**. The screen displays:

```
110 bps
150 bps
300 bps
600 bps
1200 bps
2400 bps
4800 bps
9600 bps
19200 bps
38400 bps
```

Move the cursor to the desired communication speed and press **Enter**.

To set the type of parity check, move the cursor to Parity and press **Enter**. The screen displays:

```
_____  
None  
Odd  
Even  
_____
```

Move the cursor to the correct type of parity check and press **Enter**.

To change the data length, move the cursor to Data length and press **Enter**. The number changes to either 7 or 8, whichever was not displayed before. Press **Enter** again if you want to reselect the previous number.

To change the number of stop bits, move the cursor to Stop bits and press **Enter**. The number changes to either 1 or 2, whichever was not displayed before. To reselect the previous number, press **Enter** again.

When you finish changing serial port settings, move the cursor to the Exit option in the main Setup menu. Then exit the program as described in the beginning of this chapter.

Chapter 3

Formatting a Hard Disk

This chapter describes how you check or format a hard disk drive after installation. After the hard disk is formatted, it can be partitioned and formatted for a particular operating system. Formatting destroys all data on the hard disk, in all partitions, so use this program with extreme care.

Format hard disk is option 2 on the OPERATION MENU. You can select this option from the OPERATION MENU, or you can execute the MS-DOS HDFMTALL command.

After you install a hard disk drive, format it using this program, Format hard disk, and choose option 1, Conditional format (Normal). After formatting, you need to partition and format the hard disk for your operating system(s). Refer to your MS-DOS manual for details on partitioning and formatting your hard disk for MS-DOS.

You may need to reformat a hard disk later if you have a serious problem with the drive. However, before completely reformatting the disk, use the Non-destructive surface analysis test (option 4 on the HARD DISK FORMAT MENU) to decide if formatting is necessary. If errors occur during this test, back up your disk, and run the Conditional format followed by Destructive surface analysis. These tests are described below.

Formatting and Checking Options

When you select option 2, Format hard disk, from the OPERATION MENU, you see a menu of formatting and checking options:

HARD DISK FORMAT MENU

- 1 - Conditional format (Normal)
- 2 - Unconditional format
- 3 - Destructive surface analysis
- 4 - Non-destructive surface analysis

0 - Exit

Enter selection number:

The first two options format a hard disk. Normally you use option 1, Conditional format (Normal). This option automatically locates any bad tracks that are flagged by the manufacturer and marks them so that they are never used. Option 2, Unconditional format, requires you to enter the list of bad tracks.

The other two options test a hard disk for problems. Use option 3, Destructive surface analysis, to test the entire disk and update the bad track table. Because this option writes data to the disk as well as reads it, all data on any track that produces an error is destroyed. To check for unflagged bad tracks without destroying data, use option 4, Non-destructive surface analysis.

Many hard disk drives are supplied with a list of bad tracks, but without the bad tracks flagged on the disk. Other hard disks are supplied with the bad tracks already flagged. In all cases, run Non-destructive surface analysis before formatting the disk; this routine finds all bad tracks that are not flagged.

If the analysis shows that all the tracks listed as bad are already flagged, you can then use the Conditional format (Normal) option to format the disk. If the analysis matches the list of bad tracks, but they are not flagged, run the Destructive surface analysis (to flag the tracks) before formatting the disk. If the list provided by the drive manufacturer contains bad tracks that the analysis does not detect, you can use the Unconditional format option to flag all the bad tracks manually.

When you select an option from the HARD DISK FORMAT MENU, the program determines the number of hard disk drives installed in your computer. If you have more than one drive, then each time you select a test you see this prompt:

```
Enter drive letter (C/D)?
```

Press C or **D**, and then press **Enter**.

If you have only one hard disk drive, the option you select starts immediately.

Conditional Format (Normal)

Use this option to format the hard disk. All flagged tracks are marked so that they are never used.

To start the Conditional format, press 1 and then **Enter**.

The program starts to scan the disk to find all tracks flagged as bad, starting from the innermost cylinder of the disk. During the scan, you see the number of the cylinder being checked. For example, if you have a 20MB hard disk, the first messages you see are:

```
Format Hard Disk
Scanning for flagged bad tracks...
Current cylinder is 614
```

When the scan is complete, the program displays information about the condition of the disk. For a 20MB hard disk with no bad tracks, the display looks like this:

```
Scanning finished.
Count of tracks flagged bad           =    0
Count of tracks with other errors     =    0
Count of good tracks                   = 2460
```

The program then displays a warning about the consequences of proceeding with formatting:

```
WARNING! ALL DATA WILL BE DESTROYED IN ALL
PARTITIONS OF HARD DISK, NOT JUST IN MS-DOS
PARTITION!
Do you want to start formatting (Y/N)?
```

If there are no tracks with other errors, and you are absolutely sure that you want to format the hard disk, press Y then **Enter**.

The program then asks you once more if you want to continue. You see this message and prompt:

```
DOUBLE CHECK THAT YOU HAVE BACKUP DISKETTE
COPIES OF ALL YOUR FILES.
Do you want to exit and check your file copies
(Y/N)?
```

When you are certain no valuable data will be destroyed, press **N** and **Enter**.

If you cancel formatting at either stage, you see these messages:

```
Format cancelled.  
Press ENTER to return to the menu.
```

If you continue with formatting, you see:

```
Now formatting . . .
```

When formatting is complete, any bad tracks are flagged, and you see a series of messages like these:

```
Format finished.  
Flagging bad tracks...  
Cylinder is xxxx, head is yy  
Format completed.  
Press ENTER to return to the menu.
```

Flagged tracks are identified by xxxx and yy. At this point, press **Enter** to return to the HARD DISK FORMAT MENU.

If there are any tracks with other errors, scanning stops and you see the message:

```
Scanning cancelled.  
Warning: This drive has an unflagged error(s),  
or is unformatted.  
Press ENTER to return to the menu.
```

Press **Enter**.

This may mean that the drive has never been formatted or that an error was not flagged. If you see this message, it is best to consult your dealer.

If you want to format the disk after receiving this error message, do the following:

1. If the drive is not formatted, run the Unconditional format (option 2) and enter any tracks you know are bad in the Bad Track Table. (See "Unconditional Format" below.)
2. Run the Destructive surface analysis (option 3) to flag any remaining bad tracks. (See "Destructive Surface Analysis," below.)
3. Run the Conditional format again. No errors should occur; if one does, contact your dealer.

Unconditional Format

Use this option to format your hard disk when you want to enter the list of bad tracks before formatting begins. The main difference between unconditional and conditional formatting is the way in which bad tracks are identified. With the unconditional format, you must enter the list of bad tracks before formatting begins.

To start the Unconditional format routine, press 2 and then **Enter**.

You are first given the option to change the interleave factor for formatting from the default value of three. Only do this if the documentation with your hard disk recommends a different value. You see this prompt:

Do you want default interleave of **3** (Y/N)?

To accept the default, press Y and **Enter**. To change the value, press **N** and **Enter**. You see this prompt:

Enter interleave factor **(1-16)**:

Type the recommended value, and press **Enter**.

The next screen allows you to enter the list of bad tracks. The empty bad track table looks like this:

Bad Track Table

Cylinder	Head	Cylinder	Head	Cylinder	Head	Cylinder	Head	Cylinder	Head
----------	------	----------	------	----------	------	----------	------	----------	------

Move highlighted area to desired track with cursor keys.

A = Add track, F = Finish editing

Enter command letter:

To add a bad track, follow these steps:

1. Press **A**. You see this prompt:

Enter cylinder number (1 - xxxx):

2. Type the number of the cylinder containing the missing bad track, and press **Enter**. You see this prompt:

Enter head number (0 - yy):

3. Type the head number for the bad track, and press **Enter**. The maximum valid cylinder and head numbers (xxxx and yy) vary according to the type of the hard disk.

To cancel this operation, press **Enter** without entering a value. You see this message:

Table unchanged.

If you enter an invalid cylinder or head number, a reminder of the range of values is displayed, and the program asks you to enter the value again. When you complete a valid entry, it appears in the table, and you can select another command.

If you make a mistake, move the cursor block to the incorrect track, and press **C** to alter the track data. Or you can press **D** to remove the track from the table. Change the track data just like you add a track.

When you have finished editing, check the entries in the table once more. When you are sure the table is correct, press **F**.

The program displays a warning about the consequences of proceeding with formatting, and the remaining steps are exactly the same as for a normal conditional format.

Destructive Surface Analysis

Use this option to accurately locate any bad tracks on a hard disk, and to flag any bad tracks that are not flagged.

WARNING: If any errors occur during this check, all data on the track that produces the error is destroyed. For this reason, if you think that an unflagged bad track is causing trouble, first run option 4, Non-destructive surface analysis, to check the disk surface.

This test operates by a complex process of writing, reading, and verifying information on every track of the hard disk, except for tracks that are already flagged as bad tracks.

To start the test, press **3** and then **Enter**. You see these messages:

```
Analyze Hard Disk
Read/Save/Write/Read/Restore/Read check for all
tracks...
Current cylinder is xxxx
```

As each track is checked, the cylinder number (xxxx) counts down to zero. When the analysis is complete, the program displays a complete report on the **status** of the disk, including a table of unflagged tracks that produced write, read errors. For a 20MB hard disk with one flagged bad track, you see this display:

```
Analysis finished.
Count of tracks flagged bad           =    1
Count of tracks with write, read errors =    0
Count of good tracks                   = 2459
No write, read error was detected.
No data was destroyed.
Press ENTER to return to the menu.
```

If the program finds one bad track that is not flagged, the summary above shows one track with a write, read error, and only 2458 good tracks. The report is then followed by a table like this:

```
          Write, Read Error Tracks
          =====
Cylinder Head Cylinder Head Cylinder Head Cylinder Head
237      2
```

Confirm to register the tracks in the Write, Read Error Track Table as bad tracks.

Do you want to register the error tracks as bad tracks (Y/N)?

To flag the error tracks as bad, press **Y** and **Enter**. You then see a list of the tracks as they are flagged. You see these messages:

```
Flagging bad tracks...
Cylinder is 237, head is 2
Press ENTER to return to the menu.
```

Press **Enter** to return to the HARD DISK FORMAT MENU.

Non-destructive Surface Analysis

The Non-destructive surface analysis is slightly simpler than the Destructive surface analysis described in the previous section. This option does not destroy any data, and can safely be used to check the condition of your hard disk drives. However, this test will not flag any bad tracks that are detected.

To start the test, press 4 and then **Enter**. **You** see these messages:

```
Analyze Hard Disk
Read/Verify check for all tracks...
Current cylinder is xxxx
```

As each track is checked, the current cylinder is displayed. The cylinder number counts down to zero as the disk is checked.

When the analysis is complete, the program displays a summary of the status of the disk. This summary lists these counts:

- Flagged bad tracks
- Tracks with read, verify errors
- Good tracks.

If no errors occur, you see this message:

```
No read, verify error was detected.
```

If errors are found, the program displays a table of the tracks that gave errors, similar to the one displayed by the destructive analysis.

After the status reports you see this message:

```
Press ENTER to return to the menu.
```

Check the information displayed, then press **Enter**.

Formatting a Diskette

This chapter briefly describes how to format a diskette with diagnostics. Normally, you format a diskette using the MS-DOS FORMAT command. However, if you are running diagnostics and decide to test your floppy drives (which requires a formatted diskette), you can select option 3, Format diskette, from the OPERATION MENU. This option lets you format a 360KB double-density or a 720KB high-density diskette without exiting diagnostics.

The Format diskette program destroys any data on the diskette. When formatting your diskettes, the program also initializes the directory and file allocation tables.

To format a diskette, select option 3 from the OPERATION MENU. If you have two diskette drives, you see this message and prompt:

```
Format Diskette
Format in which drive (A/B)?
```

Press **A** or **B** and **Enter**. Then this prompt displays:

```
Insert new diskette for drive A:
and strike ENTER when ready
```

(The A: is B: if you selected that drive.) Insert the diskette to be formatted and press **Enter**. The screen displays the head and cylinder numbers as the diskette is formatted.

When the format is complete, you see these messages (for a 360KB diskette):

```
Format complete
  362496 bytes total disk space
  362496 bytes available on disk
Format another (Y/N)?
```

You can format another diskette or return to the OPERATION MENU.

For a complete description of the FORMAT command, refer to the MS-DOS manual.

Performing System Diagnostics

This chapter describes how to check the operation of the main unit and peripheral devices of your Equity I+. You check these devices using System diagnostics, option 4 on the OPERATION MENU.

Always run diagnostics after adding or removing optional devices, or if you are unsure whether a device is performing correctly. You should also run these tests after moving your computer from one place to another, and after you replace the internal battery

Note: To run System diagnostics, boot your system with the diagnostics diskette in drive A. Then select option 4 from the OPERATION MENU. If you start this program in any other way, some tests may produce strange results.

You can test the following 13 devices; each has a specific reference number:

- 1 - System
- 2 - Memory
- 3 - Keyboard
- 4 - Monochrome display adapter and CRT
- 5 - Color graphics adapter and CRT
- 6 - Floppy disk drives and controller
- 7 - Math coprocessor (8087)
- 9 - Parallel port (printer interface)
- 11 - Serial port (RS-232C port)
- 12 - Alternate serial port
- 14 - Dot-matrix printer
- 17 - Hard disk drives and controller
- 81 - Parallel port on video adapter

Appendix A lists the possible errors you may see when testing these devices.

Using the System Diagnostics Program

When you Start the System diagnostics, the computer checks:

- The setting of the DIP switches on the front panel
- The positions of the internal jumpers
- The peripheral devices that are connected to the system.

After these items are checked, you see a list of the devices available for testing. This list includes only the devices that are installed in the system, and looks something like this:

The following devices have been installed

DEVICE LIST

- 1 - System board
- 2 - Memory
- 3 - Keyboard
- 4 - Monochrome display adapter and CRT
- 6 - Floppy disk drives and controller
- 9 - Parallel port (printer interface)
- 11 - Serial port (RS-232C port)
- 14 - Dot-matrix printer
- 17 - Hard disk drives and controller

Is the DEVICE LIST correct (Y/N)?

If the list correctly describes your system, press Y and then **Enter**. If a device is missing from this list, or if you wish to change the list, press N and **Enter**. Then follow the instructions below to modify the device list.

Note: Once you confirm the DEVICE LIST, you can only test those items. If you decide later that you need to add another device, you must first return to the OPERATION MENU and re-select System diagnostics.

Modifying the DEVICE LIST

If an installed device is missing from the DEVICE LIST, it is important that you add it to the list and test it carefully. In response to this prompt:

Is the DEVICE LIST correct (Y/N)?

press N followed **by Enter. You see a** new menu:

Modify DEVICE LIST

- 1 - Add devices
- 2 - Delete devices

- 0 - Exit

Enter selection number:

To add a device to the list, press **1** and then **Enter**.

The program displays a list of other devices that are not currently included in the DEVICE LIST. You see a menu similar to this:

Additional DEVICE LIST

- 5** - Color graphics display adapter and CRT
- 7 - Math coprocessor (8087)
- 12 - Alternate serial port
- 81 - Parallel port {on video adapter)

- 0 - Exit

Enter the number of the item to add:

Type the number of the item you wish to add and press **Enter**. That item disappears from the Additional DEVICE LIST on the screen.

You can add as many devices as necessary. When you finish adding devices, press **0 and Enter** to return to the Modify DEVICE LIST menu.

Note: Even if you have both monochrome and color monitor video cards installed, you can only test the monitor that is currently selected by DIP switches 1-5 and 1-6 on the front panel.

To remove a device from the list, press **2 and Enter**. The screen displays the current DEVICE LIST and the prompt:

Enter the number of the item to delete:

Type the number of the item you wish to delete and press **Enter**. That item disappears from the DEVICE LIST on the screen. You can delete as many devices as necessary. When you finish deleting items, press **0 and Enter** to return to the Modify DEVICE LIST menu.

When you finish modifying the DEVICE LIST, press **0** and then **Enter**. The screen displays the modified DEVICE LIST for a final check. If the list is correct, press **Y** and **Enter**.

You are now ready to select a test.

Selecting a test

From the DEVICE LIST, select the device to be tested. Type the number of the device, then press **Enter**.

Before the test begins, you are asked how many times to perform the test. You see this menu:

Number of times to test device

- 1 - Run test one time
- 2 - Run test multiple times

- 0 - Exit

Enter selection number:

You can specify that the test be performed one time only or any number of times in the range from 1 to 9999. Running a test multiple times is for reliability testing of essential functions only; in most cases, running a test only once is sufficient.

To perform the test **ONCE** only, press **1** then **Enter**. The program displays a submenu of more detailed tests for the device you are checking.

To perform the test multiple times, press **2 and Enter**. You see this prompt:

```
Terminate checking if an error detected (Y/N)?
```

Press **Y** and **Enter** to terminate checking if the device produces an error, or press **N and Enter** to repeat the tests regardless of an error.

You see this prompt:

```
How many times (1-9999):
```

Type the number of times you wish to repeat the test, then press **Enter**. The tests for the device now start.

Resuming from an error

If an error occurs during a test, the test stops at that point, and an error code and error message are displayed. If you want to record the problem, you can print out the message on your printer. You see this prompt:

```
Do you want a printout of the error message(s)  
(Y/N)?
```

To continue without printing the error **message**, press **N and Enter**.

Before you request a printout, be sure your printer is turned on and on-line, and the paper is installed correctly. Then press **Y** and **Enter**. If the printer is not ready, the following message and prompt are displayed:

```
Printer is not installed correctly.  
Install correctly and enter Y, or  
Enter N to cancel printing.
```

Correct the the problem **and** press **Y and Enter** to, continue printing, or press **N and Enter** to cancel printing.

After printing the error message, the program displays this prompt:

```
Printout is finished. Press ENTER to return to  
the menu.
```

The program continues after an error in one of the following ways:

- It returns to the DEVICE LIST, or
- If you are running multiple tests and are not terminating on an error, the program repeats the test that caused the error.

The remainder of this chapter describes the tests you can run on the system's internal devices and on the optional devices installed in your computer. The program displays the title of each check on the screen.

For a complete list of the error codes and messages that are displayed by these tests, refer to Appendix A.

System Board Check

Use this option to check the operation of each major component on the system board, including:

- The 8088 CPU chip
- The system ROM
- The real-time clock, CMOS RAM, and battery
- The main integrated circuits.

The checks made on the 8088 CPU chip are extremely comprehensive. They ensure that the CPU instruction set is functioning correctly.

If an error is reported, write down the error code and message, or print them out, and contact your Epson dealer. Attempting to correct system board errors yourself may violate your warranty agreement.

Memory Check

Use this option to check the computer's built-in memory. The program checks the DIP switches to determine the amount of main memory. If any settings are incorrect, check the DIP switches to make sure they match the installed memory.

Note: This option does not check expanded memory above the 640KB memory limit imposed by MS-DOS.

For this check, the program writes specific data into memory and then reads it back. The data is written and read in blocks of 64KB. A parity check is also made on each block. A count of memory is displayed after each block that is tested without an error. The final message is usually:

640 KB OK

If an error is reported, write down the error code and message, or print them out, and contact your Epson dealer. Attempting to correct memory errors yourself may violate your warranty agreement.

Keyboard Check

Use this option to check the operation of the keyboard. The program first checks the keyboard controller; during this check, you see the green indicator lights on the keyboard flash. If no errors are detected, you can then choose the correct keyboard layout.

Before checking the operation of the keys, you must select the appropriate keyboard layout so that the test display matches the keys on your keyboard. You see this menu:

KEYBOARD SELECT MENU

- 1 - US ASCII
- 2 - United Kingdom
- 3 - French
- 4 - German
- 5 - Italian
- 6 - Spanish

- 0 - Exit

Enter selection number:

Type the number of your keyboard layout, then press **Enter**. You can exit the keyboard test by pressing 8 and **Enter**.

After you select a keyboard layout, the program displays the layout on the screen. Press each key on the keyboard to make sure the corresponding character is displayed on the screen. If the character displayed on the screen does not match the key you pressed, there is a problem with your keyboard. Test each key.

The status of the Num Lock, Caps Lock, and Scroll Lock indicators is shown on the upper right side of the keyboard layout.

These messages appear on the screen:

KEYBOARD CHECK

Press Y followed by ENTER to exit.

Press N followed by ENTER if screen and keyboard do not match.

If all the keys function correctly and match the characters displayed, press Y and then **Enter**.

If all the keys function, but the characters displayed do not match the **keys**, press **Y and then Enter**. Then reselect the keyboard test from the DEVICE LIST, and check that you selected the correct keyboard layout. You can find diagrams of all the international keyboard layouts in the MS-DOS manual.

If any key is incorrect, press **N and Enter**. Make a copy of the error code and message, or print them out, and contact your Epson dealer.

Monochrome Display Adapter and CRT Check

Use this option to check the operation of a monochrome display adapter and monitor. This test includes several checks that allow you to identify particular problems related to the monochrome display. To run this check, DIP switches 1 - 5 and 1-6 on the front panel must be set correctly for a monochrome monitor.

You can select the individual checks from this menu:

MONOCHROME ADAPTER AND CRT CHECK MENU

- 1 - Monochrome adapter check
- 2 - Attribute check
- 3 - Character set check
- 4 - Video check
- 5 - Sync check
- 6 - Run all above checks

- 0** - Exit

Enter selection number:

If you specified to run the monochrome check multiple times, this menu of checks does not display and only the first test (option 1) is performed.

If an error occurs during any of these tests, record the error code and message, or print them out. Then contact your Epson dealer.

When you finish running the monochrome adapter check, press 0 and Enter to return to the DEVICE LIST.

Monochrome adapter check

To check the monochrome adapter, press **1** and then **Enter**.

The computer checks the video RAM display memory) on the display adapter by writing certain data to memory, then reading it back and comparing it to the written data. The video enable signal of the display controller chip is also tested.

Attribute check

To check the display attributes of the adapter card, press 2 and then **Enter**.

A series of messages are displayed showing examples of all the possible display attributes (normal intensity high intensity, blinking, reversed characters, and underlining). Check the information displayed on your screen, and then respond to the prompt:

Is the display correct (Y/N)?

Press **Y** and then **Enter** if the display is correct.

If the display attributes are not correct, adjust the brightness and contrast on your display monitor. If they are still incorrect, press **N** and **Enter**.

Contact your Epson dealer to make sure that your monitor is able to display all the attributes available, and to ensure that your monitor cable is not damaged.

Sync check

This test is provided for service purposes only. If you accidentally select this option, press any key to end the test.

Run all above checks

To run all the tests on the menu in **sequence**, press **6 and Enter**.

When you choose this option, all checks for the monochrome adapter and CRT are performed automatically in sequential order. Although you do not start each test, you must still supply the appropriate responses to progress from one test to the next.

Color Graphics Adapter and CRT Check

Use this option to check the operation of a color graphics display adapter and monitor. This test includes several checks that allow you to identify particular problems related to the color display. To run this check, DIP switches 1 - 5 and 1 - 6 must be set correctly for a color monitor.

You can select the individual checks from this menu:

COLOR GRAPHICS ADAPTER AND CRT CHECK MENU

- 1 - Color graphics adapter check
- 2 - Attribute check
- 3 - Character set check
- 4 - 40-column character set check
- 5** - 320X200 graphics mode check
- 6 - 640X200 graphics mode check
- 7 - Screen paging check
- 8 - Light pen check
- 9** - Color video check
- 10 - Sync check
- 11 - Run all above checks

- 0 - Exit

* Enter selection number:

If you specified to run the color adapter check multiple times, this menu does not display and only the first test (Color graphics adapter check) is performed.

If an error occurs during any of these tests, record the error code and message, or print them out. Then contact your Epson dealer.

When you finish running the color adapter check, press **0 and Enter** to return to the DEVICE LIST.

Color graphics adapter check

To check the color graphics adapter, press **1 and Enter**.

The computer checks the video RAM (display memory) on the display adapter by writing test data to memory, and then reading it back and comparing it to the written data. The video enable signal of the display controller chip is also tested.

Attribute check

To check the display attributes of the color graphics adapter card, press **2 and Enter**.

Several messages are displayed showing examples of all the possible display attributes and colors. Check the information displayed on your screen, and respond to the prompt:

Is the display correct (Y/N)?

Press **Y** and then **Enter** if the display is correct.

If the colors are not correct, adjust the controls on your display monitor. If they are still incorrect, press **N and Enter**.

Contact your Epson dealer to verify any monitor problems.

40-column character set check

To check your 40-column character set, press **4** and then **Enter**. The character fonts that are included in the internal character generator are displayed. Check the characters displayed on your screen against this illustration:

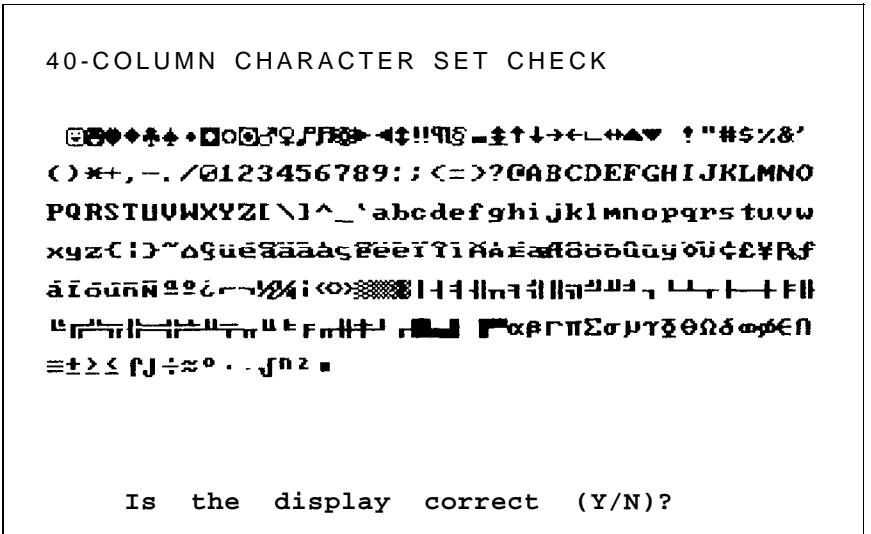

After checking the character fonts, respond to the prompt:

Is the display correct (Y/N)?

If the characters displayed match the illustration, press **Y** and **Enter**. If you find a problem with the characters on the screen, press **N** and **Enter** to display the error message.

320x200 graphics mode check

To check your 320x200 graphics mode, press **5** and then **Enter**.

The screen displays three colored squares—light green, brown, and red—against a cyan background. These four colors are Color Set 0. If they are correct, press **Y** and then **Enter**.

The same pattern is displayed again; this time the squares are cyan, white, and magenta, and the background is red. These colors are called Color Set 1. If these are also correct, press **Y** and then **Enter** to end the test.

If any colors are displayed incorrectly, first check the adjustment of your monitor, and make sure that both ends of the cable are plugged in firmly. If a problem still exists, press **N** and **Enter** to display the error message.

640x200 graphics mode check

To check your **640x200** graphics mode, press **6** and **Enter**.

The screen displays three patterned squares against a black background, as shown below.

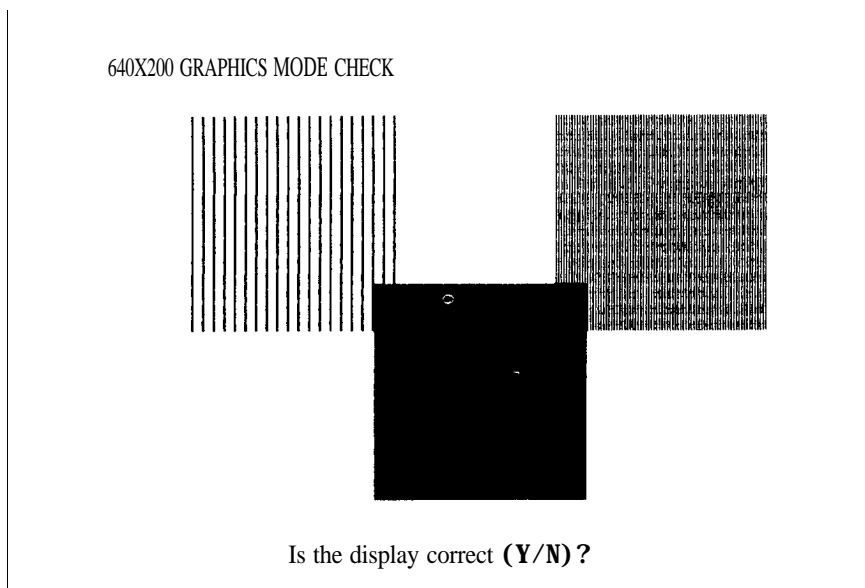

If the patterns on your screen are clear and distinct, press **Y** and then **Enter**.

If any pattern is not displayed clearly, first check the adjustment of your monitor, and then make sure that both ends of the cable are plugged in firmly. If a problem still exists, press **N** and **Enter** to display the error message.

Screen paging check

To check the screen paging of your monitor, press **7** and **Enter**.

The video RAM on the color graphics adapter is divided into eight independent display pages. This test checks the eight pages by first filling all eight with a number corresponding to the page, and then displaying each page in turn. You see this pattern for screen 0:

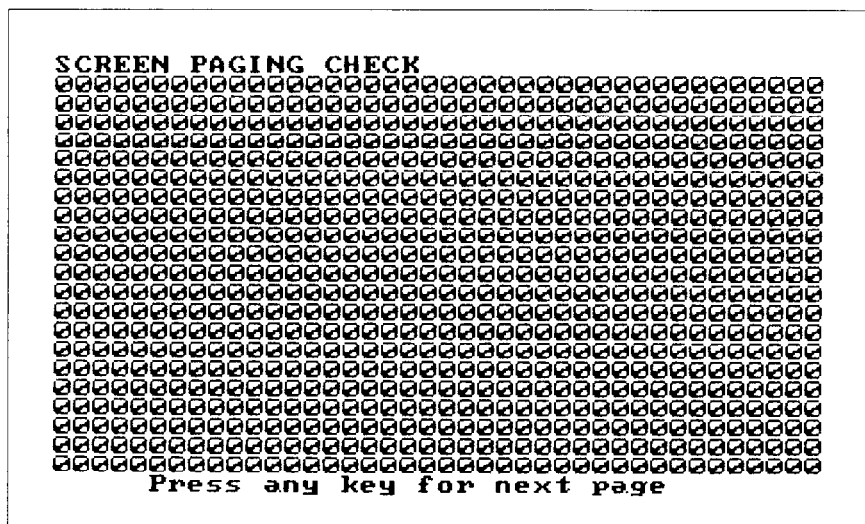

When you have examined this screen, press any key to display the next page. The eight display pages, numbered 0 to 7, are displayed sequentially.

After the eighth page is displayed, you see the prompt:

Is the display correct (Y/N)?

If all eight pages are correct, press **Y** and **Enter**. If any page is filled with an incorrect number, press **N** and **Enter** to display the error message.

Light pen check

To check the function of a light pen connected to the color graphics adapter card, press **8** and then **Enter**.

This test checks that a light pen connected to the color graphics adapter is performing accurately. When you select this check, you see these prompts:

Enter Y to start light pen check.

Enter N to return to the menu.

If you do not have a light pen attached, press **N** and **Enter**. To begin the test, press **Y** and **Enter**. You see this prompt:

PLACE LIGHT PEN ON CENTER OF WHITE BLOCK

Touch the center of the white block on the screen with the light pen. When the light pen is correctly positioned, the block moves to another part of the screen for a second test. After three successful tests, the check ends.

An error occurs if:

- The light pen is not connected properly
- You touch the screen at the wrong point
- The light pen is malfunctioning
- You do not touch the square within a certain amount of time (dependent on the current CPU speed).

Color video check

Option 9, Color video check, displays 16 different screens, each a different color, and a message indicating the color. The screens show the following colors in the order specified below:

- | | |
|-------------|-----------------------------|
| 1 - Black | 9 - Gray |
| 2 - Blue | 10 - Light blue |
| 3 - Green | 11 - Light green |
| 4 - Cyan | 12 - Light cyan |
| 5 - Red | 13 - Light red |
| 6 - Magenta | 14 - Light magenta |
| 7 - Brown | 15 - Yellow |
| 8 - White | 16 - White (high intensity) |

To start this test, select option 9 from the menu; the first screen is displayed. Press any key to display the next screen. On the last screen, you see this prompt:

Is the display correct (Y/N)?

If all the colors are correct, press **Y and Enter** to end the test. If any color is displayed incorrectly, first check the adjustment of your monitor, and then make sure that both ends of the cable are plugged in firmly. If a problem still exists, press **N and Enter** to display the error message.

Sync check

This test is provided for service purposes only. If you accidentally select this option, press any key to end the test.

Run all above checks

To run all the tests on the menu in sequence, press **11** and **Enter**.

When you choose this option, all checks for the color adapter and CRT are performed automatically in sequential order. Although you do not start each test, you must still supply the appropriate responses to progress from one test to the next.

Floppy Disk Drives and Controller Check

Use this option to test the performance of the floppy disk drives installed in your computer. This test includes several checks that allow you to identify particular problems related to your floppy disk drives.

Before running these tests, format a floppy disk to use for the tests that write data on the disk in the drive. In a 360KB drive, you can only use a 360KB floppy disk. In a 720KB drive, use only a 720KB diskette.

You can select the individual tests from this menu:

FLOPPY DISK DRIVE(S) AND CONTROLLER CHECK MENU

- 1 - Sequential seek check
- 2 - Random seek check
- 3 - Write, read check
- 4 - Speed check
- 5** - Run all above checks

- 0 - Exit

Enter selection number:

Before any checks are performed, the program determines the number of floppy disk drives installed in your computer. If you have more than one drive, you see this prompt each time you select a test:

Check which drive (A/B)?

Press **A** or **B** and then **Enter**.

If any errors occur, record the error code and message and contact your Epson dealer. Always have the floppy disk drive serviced by your Epson dealer.

Sequential seek check

This test checks the ability of the read/write heads to locate any part of the diskette. This action by a read/write head is called a seek. During this test, each head seeks sequentially from the innermost track to the outermost track. The innermost track is track 39 for 360KB diskettes and track 79 for 720KB diskettes.

Select option 1 from the menu to start this test.

The program displays the number of each track it finds. For example, with a 360KB floppy disk, the first message you see is:

Current track is **39**

The track number counts down (from 39 or 79) to 0.

The seek is performed by each head, so you see the count twice. If no errors occur, the menu is displayed.

Random seek check

This test is identical to the sequential seek check, except that the seek operation is performed on each track in random order instead of sequential order.

Select option 2 from the menu to start this test.

Write, read check

This test checks the ability of the selected disk drive to read and write data from a diskette. The test writes to and reads from each cylinder on the diskette, starting at the center.

Note: This test destroys all data on the diskette in the selected drive.

Select option 3 from the menu to start this test.

If you have only one floppy disk drive, you are prompted to change the diagnostics diskette for a blank diskette before running the test. You see these messages:

```
Use only a formatted blank diskette for this
test.
Any data present may be erased.
If using drive A, remove your Diagnostics Disk.
Enter Y to start this check.
Enter N to return to the menu.
```

Make sure the blank diskette you prepared is in drive A, then press **Y** and **Enter**.

The program displays the current track number as each cylinder is tested. For example, with a 720KB floppy disk, the first message you see is:

```
Current track is 79
```

Speedcheck

This test checks the revolution speed of the specified disk drive. Select option 4 from the menu to start this test. You see a message similar to this:

```
The disk rotation speed should be more than
294.0 rpm and less than 306.0 rpm.
```

The computer spins the diskette for a few seconds then displays a message like this:

```
The disk rotation speed is now 300.0 rpm.
```

Note: The speed for a 360KB or 720KB (3½-inch) drive should be 300 rpm. This check permits a tolerance of $\pm 2\%$.

The diskette continues to spin, and the display is updated every few seconds. To stop the test, press any key; the program returns to the menu.

If you try to perform a speed test without inserting a floppy disk, or if a read error occurs, you see this message and prompt:

```
Disk is defective or not installed properly.
Press ENTER to return to the menu.
```

Run all above checks

To run all the tests on the menu in sequence, press **5** and then **Enter**.

When you choose this option, all checks for the floppy disk drive(s) and controller are performed automatically in sequential order. Although you do not start each test, you must still supply the appropriate responses to progress from one test to the next.

Math Coprocessor Check (8087)

Use this option to check the operation of the 8087 math coprocessor if you have one installed in your computer. To check the math coprocessor, select option 7 from the DEVICE LIST

Before running any tests, the computer checks DIP switch 1-2 on the front panel to ensure that a coprocessor is installed. If the coprocessor is missing, or if you have not set DIP switch 1 - 2 correctly, an error occurs and the test ends.

The program then runs a series of checks to test the precision with which the coprocessor performs calculations and to detect whether it correctly handles exceptions. The program reports any errors that occur.

Parallel Port (Printer Interface) Check

Use this option to test the operation of the secondary parallel printer port. For example, you would select this option to test the built-in port if you have assigned it as the secondary port, or if you have installed an IBM® parallel port option card.

To perform the test, you must insert a special loop-back connector into the parallel port so that the computer can check individual pins of the port. Contact your dealer if you need a loop-back connector. Note that a different connector is required to test the serial port.

When you select option ? from the DEVICE LIST, you see these prompts:

```
Attach loop-back connector to parallel port.  
Enter Y to start this check when connector is  
attached, or  
Enter N to return to the menu.
```

Insert the loop-back connector. Then press **Y** and **Enter** to start the check.

The computer checks the port by writing and reading data and control information, and reports errors for any pins that are faulty. Note that if you connect a printer cable instead of a loop-back connector, you will get errors.

Parallel Port (on Video Adapter) Check

Use the Parallel port (on video adapter) check to test the functions of the primary port. This tests either the built-in port, if it is set up to act as the primary port, or the parallel port on a monochrome adapter (such as the IBM monochrome display and printer adapter) if you have one installed in your computer.

To perform the test, you must insert the special loop-back connector into the parallel port so that the computer can check individual pins of the port. This test is identical to the Parallel port check. For more details, refer to the description of the Parallel port (printer interface) check above.

Serial Port (RS-232C) Check

Use this option to test the functions of the primary serial communications (KS-232C) port. To perform the test, you must insert a special loop-back connector into the KS-232C port so that the computer can check individual pins of the port. Contact your dealer if you need a loop-back connector. Note that a different connector is required to test the parallel port.

When you select option 11 from the DEVICE LIST, you see these prompts:

```
Attach loop-back connector to serial port.  
Enter Y to start this check when connector is  
attached, or  
Enter N to return to the menu.
```

Insert the loop-back connector. Then press Y and **Enter** to start the check.

First, the computer checks the serial port control lines to see that they are able to change from high to low and vice versa. No messages are displayed during this part of the test unless an error occurs.

The second test is an echo back check during which the port sends data to itself in a fixed data format, at all the possible baud rates. When this test begins, you see these messages:

```
RS232C echo back check - at various baud rates  
Current baud rate is 75  
Current test data is 00
```

Each baud rate is tested in turn, and the display informs you of the progress of the test. If the port does not become ready correctly, a timeout error occurs. If any data received does not match the data sent, a verify error occurs, and the computer reports the transmitted and received data at the time of the error.

The final test is an echo back check during which the port sends data to itself at 9600 baud, using various data formats. At the start of the test, you see these messages:

```
RS232C echo back check - with various data
formats
Current data format: 5data bits, 1 stop bits,
                    parity - NONE
Current test data is 00
```

Once again, if any data received does not match the data sent, a verify error occurs, and the computer reports the transmitted and received data at the time of the error.

Alternate Serial Port Check

Use this option to test the functions of an additional serial communications (RS-232C) port. To perform the test you must insert a special loop-back connector into the alternate serial port so that the computer can check individual pins of the port.

This test is identical to the check for the primary serial port. For more details, refer to the description of the Serial port (RS-232C) check above.

Dot-matrix Printer Check

Use this option to check:

- The operation of your printer in IBM-compatibility mode
- The compatibility of your printer with the extended character set used by the Equity I+
- The ability of your printer to produce hit-image graphics and print images of the graphics screen.

When you select option 14 from the DEVICE LIST, you see this prompt:

```
Is dot-matrix printer on-line (Y/N)?
```

Check that your printer is connected to the computer, and that it is turned on, loaded with paper, and on-line. Press Y and then **Enter** to continue, or press **N** and **Enter** to return to the menu.

When you continue the test, the computer checks that the printer is responding correctly. This test detects whether the printer is off-line or whether an interface error exists. If no errors occur, the computer sends a repeating sequence of ASCII characters and bit-image data to the printer until you press any key. The pattern looks like this:

```
Text data (20H-7FH,A0H-FFH)
!"#$%&'()*+,-./0123456789:;<=>?@ABCDEFGHIJKLMNPOQRSTUVWXYZ[\]^_`abcdefghijklmnop
pqrstuvwxyz{|}~!"#$%&'()*+,-./0123456789:;<=>?@ABCDEFGHIJKLMNPOQRSTUVWXYZ[\]^_`
abcdefghijklmnopqrstuvwxyz{|}~

Bit-image data (00H-FFH)
~!@#%&'()*+,-./0123456789:;<=>?@ABCDEFGHIJKLMNPOQRSTUVWXYZ[\]^_`abcdefghijklmnop
```

The text data includes all the characters commonly used by programs that require foreign languages or graphic characters. If your printer prints different characters than you see in the illustration, you may need to take care with certain software. The bit-image data is sent to the printer using a command (ESC K) compatible with Epson and IBM printers. If this pattern is printed correctly, you can use the MS-DOS GRAPHICS program to print out copies of graphics screens.

Note: Even if the test runs only for a short time, your printer may store many characters in its buffer. To stop printing, turn the printer off-line.

Hard Disk Drives and Controller Check

Use this option to test the performance of the hard disk drives installed in your computer. If any errors occur, have the drive checked and serviced by your dealer.

When you select option 17 from the DEVICE LIST, you see this menu:

HARD DISK DRIVE(S) AND CONTROLLER CHECK MENU

- 1 - Seek check
- 2 - Write, read check
- 3** - Error detection. and correction check
- 4 - Read, verify check
- 5 - Run all above checks

- 0 - Exit

Enter selection number:

If you specified to run the hard disk drive check multiple times, this menu does not display and only the first three tests are performed.

When you select a check from this menu, the program determines the number of hard disk drives installed in your computer. If you have more than one drive, then each time you select a test you see this prompt:

Check which drive (C/D)?

Press C or D and then **Enter**.

Seek check

This test checks the ability of the read/write heads to locate any part of the hard disk. This action by a read/write head is called a *seek*. During this test, each head seeks each cylinder of the disk in sequence, starting from the center.

Select option 1 from the menu to start this test.

The program displays the number of each cylinder it finds, counting down from 614 (for a 20MB hard disk) to 0.

The seek is performed by the read/write heads simultaneously, so you see the cylinder numbers only once. If no errors occur, the menu is displayed.

Write, read check

This check tests the ability of the hard disk drive to read and write data. The test writes to and reads from each sector of the innermost cylinder of the disk, using each head.

Note: This test destroys all data on the innermost cylinder of the selected hard disk drive. This cylinder is reserved for diagnostics, and is never used for storage by MS-DOS. Therefore, data created by MS-DOS is not destroyed.

Select option 2 from the menu to start this test. You see these messages:

The data on the highest physical cylinder may be destroyed by this check.

Enter Y to start this check.

Enter N to return to the menu.

Press Y and then **Enter** to continue with the test.

You do not see a cylinder count during the test. If no errors occur, the program returns to the menu.

If an error is reported, make a note of the code and message. Then use the Non-destructive surface analysis (option 4 on the HARD DISK FORMAT MENU) to check the condition of the hard disk. If this analysis shows no other problems with the disk, follow these steps:

1. Back up all the files on your hard disk.
2. Re-format the disk using option 2, Format hard disk, on the OPERATION MENU.
- ?. Re-create the MS-DOS partition with FDISK and format it with SELECT. (See your MS-DOS manual.)
4. Restore your files.

Error detection and correction check

This test checks the ability of the hard disk drive to detect a read/write error and to correct the data accordingly.

Note: This test destroys some data on the innermost cylinder of the selected hard disk drive. This cylinder is reserved for diagnostics, and is never used for storage by MS-DOS. Therefore, data created by MS-DOS is not destroyed.

Select option 3 from the menu to start this test. You see these messages:

The data on the highest physical cylinder may be destroyed by this check.

-Enter Y to start this check.

Enter N to return to the menu.

Press Y and then **Enter** to continue with the test. If no errors occur, the menu is displayed.

An error occurs only if the drive is malfunctioning. In this case, back up all your files, and have the drive serviced immediately. (The drive may be corrupting your data.)

Read, verify check

This test reads and verifies data from all tracks of the disk, checking each cylinder and using both heads.

Select option 4 from the menu to start this test.

The program displays the number of each cylinder it finds. For example, with a 20MB hard disk, the first message you see is:

```
Current cylinder is 614
```

The cylinder number counts down to 0.

At the end of the test, you see a table of the results of the test. For example, for a 20MB hard disk with no bad tracks, you see:

```
BAD TRACKS ..... 0
READ ERROR TRACKS ..... 0
GOOD TRACKS ..... 2460
```

```
Press ENTER to return to the menu
```

Press **Enter** when you have viewed the table.

Run all above checks

To run all the tests on the menu in sequence, press 5 and then **Enter**.

When you choose this option, all checks for the hard disk drives and controller are performed automatically in sequential order. Although you do not start each test, you must still supply the appropriate responses to progress from one test to the next. The first prompt you see is:

```
The data on the highest physical cylinder may be
destroyed by this check.
```

```
Enter Y to start this check.
```

```
Enter N to return to the menu.
```

Press Y and then **Enter** to continue with the test.

Chapter 6

Moving the Hard Disk

This chapter describes the procedure you use when you plan to move your computer. Even if you are moving the computer only a short distance, use option 5, Prepare hard disk for moving, to prevent damage to the hard disk.

For each hard disk installed in the system, this program ensures that the read/write heads are moved away from the disk surfaces and locked securely in position. If the heads are not secured and the computer is subjected to shock or vibration, the heads may bump the disk surfaces and the drive may be damaged. At the very least you may lose a considerable amount of data.

To secure the heads, select option 5 from the OPERATION MENU. You see a screen of information reminding you that the heads will not be unlocked until the computer is reset or switched off and on again. The screen is displayed, the heads are moved, and the keyboard is disabled. You can now turn the computer off and move it to the new location.

You can also secure the heads on your hard disk by executing the MS-DOS HDSIT command.

Note: If you are using a non-Epson hard disk that does not have a pre-defined cylinder for securing the heads, you may need to specify the cylinder number when giving the HDSIT command. To do this, you must enter the following command at the MS-DOS system prompt:

```
HDSIT /C xxx
```

The /C selects the cylinder switch and xxx is the number of the cylinder where the heads are to be secured. See your hard disk manual for more information.

System-dependent Utilities

This chapter describes the utilities that are included on your diagnostics diskette. These utilities are used exclusively by your Equity I+ system:

HELP
ROMBIOS
SYSTAT

Each utility is an MS-DOS command. You can copy the commands to your hard disk or to a directory on another floppy disk. Then you can execute the commands from the MS-DOS prompt without loading the diagnostics diskette.

To run the utilities from your diagnostics diskette, select option 0 from the OPERATION MENU before you run a diagnostics program. You see this selection on the menu:

```
0 - Exit to DOS for more utilities
```

(After you run a diagnostics program, this selection changes to 0-Exit and reset. Selecting option 0 at this point resets your computer.)

The HELP Utility

Use the HELP command to ask for information on all the MS-DOS commands and utility programs. This help function provides useful information but is not intended to be a substitute for the MS-DOS manual.

The format of this command is:

```
HELP [command. . . ]
```

Type HELP only to see a menu of all commands. Type HELP followed by the name of one or more MS-DOS commands, each separated by a space, to bypass the menu and display the messages for each command.

When the menu is displayed, you see this prompt at the bottom of the screen:

```
↑↓→← Select command name, Enter to display  
command, Esc to Exit
```

Use the cursor keys to select a command name. (You can only select one command name at a time from the menu.) When the correct command is highlighted, press **Enter**. The help screen for the specified command is displayed.

If there is more than one page of text, you see the prompt PgUp on the top of the screen. Press **Page Up** (or **Pg Up**) to display the rest of the text. After reading the help information, press **ESC** to return to the menu.

If you type **HELP** and one or more command names on the command line, the help information for the first command is displayed. Press **Esc** to see the help information for the next command. When you press **Esc** after viewing the information for the last command, MS-DOS returns to the system prompt.

Caution

The help information is stored in the **HELP.TXT** file. If you copy **HELP.COM** to another diskette or to your hard disk, you must also copy **HELP.TXT** to the same disk. If they are not in the same path, you can use the **APPEND** command to locate **HELP.TXT**.

Examples

To see help information for the **COPY** command, type the following command and press **Enter**:

```
HELP COPY
```

To see help information for the **DISKCOPY** and **FORMAT** commands, type the following command line and press **Enter**:

```
HELP DISKCOPY FORMAT
```

To see the help menu, type **HELP** only and press **Enter**.

Messages

command not found

You may have misspelled the command name. Press **Enter** to return to the command prompt and try again.

Failed to open HELP.TXT

HELP could not find the HELP.TXT file. HELP.COM and HELP.TXT must be in the same directory, or use APPEND to locate the directory that contains HELP.TXT.

The ROMBIOS Utility

Use this command to display the Epson name and ROM BIOS version number of the computer you are using.

Because computer systems are frequently updated, it is a good idea to occasionally check with your dealer for update information. To determine if a particular update applies to your system, give your dealer the ROM BIOS version number of your computer.

The format of this command is:

ROMBIOS

Example

Type ROMBIOS at the command prompt and press **Enter**. You see a message similar to:

EQUITY I+ ROM BIOS Version x.xx

The SYSTAT Utility

Use this command to display the system parameters defined in the CMOS RAM and by the DIP switch settings. You can view these values at any time.

The format of this command is:

SYSTAT

Examples

Type SYSTAT only and press **Enter**. **You** see a screen similar to this:

CPU speed		10 MHz
Memory size	Main	640 KB
Display type		Monochrome, 80 col
Coprocessor		8087 not installed
Mass storage	Drive A:	360 KB
	Drive B:	None
Real-time clock	Time	14:52:03
	Date	12-05-1986
Number of RS-232C ports		1
Number of parallel ports		1

Next page --- Enter, Exit --- other

To display the next screen page of information, press **Enter**. **You** see a screen similar to this:

Primary serial port	Baud rate	9600 bps
	Parity	None
	Data length	8 bits
	Stop bits	1 bit(s)
Secondary serial port	Baud rate	9600 bps
	Parity	None
	Date length	8 bits
	Stop bits	1 bit(s)

Exit --- Esc

To exit the SYSTAT program, press ESC .

Messages

Setup error is found

SYSTAT found an error in the way your computer is set up. Use the Setup program to correct your system parameters.

Checksum error found

This error displays if you run SYSTAT before using Setup to define the system parameters.

Realtime clock has lost power

The clock battery is losing power or is dead, and needs to be replaced.

Appendix A

Error Codes and Messages

This appendix lists all the error codes and messages that may appear during diagnostics checks.

Table A-1. Error codes and messages

Error code	Message
System board	
101	8088 CPU ERROR
102	27128 ROM CHECKSUM ERROR
103	8254 TIMER COUNTER REGISTER ERROR
104	8254 TIMER COUNTER ERROR
105	8237 DMA CONTROLLER REGISTER ERROR
105	8237 DMA REFRESH ERROR
108	8048 SELFDIAGNOSTIC ERROR
109	8259 INTERRUPT CONTROLLERERROR
111	146818 CMOS BATTERYERROR
112	146818 CMOS CHECKSUMERROR
113	8088 INSTRUCTIONERROR
Memory	
201	MEMORY/PARITY ERROR
Keyboard	
301	8048 ERROR
302	NON-STANDARDOR DEFECTIVE KEYBOARD
Monochrome display adapter and CRT	
401	V-RAM ERROR
402	VIDEO SIGNAL ALWAYS HIGH/LOW
403	ATTRIBUTEERROR
404	CHARACTERSET ERROR

Table A-1. Error codes and *messages* (continued)

Error code	Message
Color graphics adapter and CRT	
501	V-RAM ERROR
503	ATTRIBUTEERROR
504	CHARACTERSET ERROR
505	40-COLUMN CHARACTERSET ERROR
506	320 x 200 GRAPHICS MODE ERROR
507	640 x 200 GRAPHICS MODE ERROR
508	SCREEN PAGING ERROR
509	LIGHT PEN ERROR
510	COLOR VIDEO ERROR
Floppy disk drives and controller	
601	FLOPPYDISK CONTROLLERERROR
602	SEQUENTIAL SEEK ERROR
603	RANDOM SEEK ERROR
604	WRITEERROR
605	READ ERROR
Math coprocessor (8087)	
701	COPROCESSORNOT INSTALLED
702	COPROCESSOR INITIALIZEERROR
703	COPROCESSOR INVALID OPERATION MASK ERROR
704	COPROCESSOR ST FIELD ERROR
705	COPROCESSOR COMPARISON ERROR
706	COPROCESSOR ZERO DIVIDE MASK ERROR
707	COPROCESSOR ADDITION ERROR
708	COPROCESSORSUBTRACTION ERROR
709	COPROCESSOR MULTIPLICATION ERROR
710	COPROCESSOR PRECISION ERROR
Parallel port	
901	ERROR PIN p
Parallel port on video adapter	
8101	ERROR PIN p

Table A-1 Error codes and *messages* (continued)

Error code	Message
Serial port (RS-232C)	
1101	ERROR DTR DSR, DSR ALWAYS HIGH/LOW
1101	ERROR RTS CTS, CTS ALWAYS HIGH/LOW
1102	TIMEOUT ERROR
1103	VERIFY ERROR
Alternate serial port	
1201	ERROR DTR DSR, DSR ALWAYS HIGH/LOW
1201	ERROR RTS CTS, CTS ALWAYS HIGH/LOW
1202	TIMEOUT ERROR
1203	VERIFY ERROR
Dot-matrix printer	
1401	status : error- <i>type</i>
Hard disk drives and controller	
1701	SEEK ERROR
1702	WRITE ERROR
1703	READ ERROR
1705	ERROR DETECTION ERROR
1706	ERROR CORRECTION ERROR

Appendix B

Power-on Diagnostics

The built-in memory (ROM) of your computer contains a series of diagnostics programs. These programs are run automatically by the system every time you turn on the power. The diagnostics programs check the internal devices such as ROM, RAM, keyboard controller, timer, video controller, and floppy disk driver.

When you turn on the power, the tests described in this appendix are performed. If an error is found, a specific error number and error message are displayed. If the error is serious, the computer cancels further checking and halts system initialization. The error message remains on the screen but the computer is inoperable.

If the error is not serious, the computer displays an error message and waits for you to resume further checking. You see this prompt:

F1 key to resume

Write down the error message and code number, and then press **F1** to resume. Report the error message and code number to your dealer when requesting repairs.

System Device Check

The computer first checks its internal devices such as the ROM. If a malfunction is found, the computer displays an error message. In some cases, it may halt with no further information. If this happens, contact your dealer as soon as possible.

If a fault in the main board is found, the computer stops and this error message displays:

101-System board error

Give this error number to your dealer.

If an I/O or checksum error occurs, you see this message:

xxxx0 ROM error

where xxxx is the number of the segment of the bad I/O ROM on an option card.

Clock and CMOS RAM Check

When the system device check is completed successfully, the computer checks the timer and CMOS RAM. If the information contained in the RAM does not match the actual system installation, you see this message:

```
161-System options not set  
    (Run SETUP in DIAGNOSTICS)
```

The information stored in the CMOS RAM must be corrected. Run the Setup program provided on the diagnostics diskette to correct the installation information.

If the system clock has not been set, this message is displayed:

```
163-Time & Date not set  
    (Run SETUP in DIAGNOSTICS)
```

RAM Check

The computer now begins to check the RAM installed in both the main board and option cards. During this check, this message is displayed:

```
xxx KB OK
```

where xxx indicates the amount of memory in which no malfunction is found. This value increases continuously by 64KB up to the amount of RAM installed on the main board, which is 640KB. If the computer detects an error in the first 64KB area, an error message is displayed and the computer halts with no further information.

If there are faulty RAM chips in your system, you see this message:

```
xxxx0 201-Memory error
```

Keyboard Controller and Keyboard Check

The computer checks the keyboard controller and keyboard for problems such as failure of one of the keys to release. If there are any errors in the connection between the keyboard and the computer, this error message is displayed:

```
301-Keyboard error
```

When a number (xx) precedes this message, the number represents the key (in hexadecimal) that is causing the error. This message may occur after a keyboard reset (**Ctrl Alt Del**) and does not necessarily indicate a problem.

Floppy Disk Drive Seek Check

The computer checks its floppy disk drives by searching the read/write heads for any malfunction.

If any seek errors are found, you see this message:

```
601-Diskette error
```

If this error occurs, confirm that the system diskette is inserted into drive A. If this number still appears after you insert the diskette, you may then want to run the System diagnostics and select option 6 from the DEVICE LIST. If the error persists, consult your dealer about having the drive repaired.

Index

A

- Adapter,
 - Color graphics, 5-11—12
 - Monochrome display, 5-8—9
- Alternate serial port check, 5-23
- Analysis, hard disk,
 - Destructive surface, 3-6
 - Non-destructive surface, 3-8
- Attribute check,
 - Monochrome adapter, 5-9
 - Color graphics adapter, 5-12

B

- Bad tracks, hard disk, 3-2—8
- Board checks, system, 5-6
- Boot system, 1-4, 2-2—3

C

- Caps Lock, 5-8
- Character set checks,
 - Color graphics adapter, 5-13—14
 - Monochrome adapter, 5-10
- Clock,
 - Check, B-2
 - Real-time, 2-1—4
- CMOS RAM, 2-1—3, 5-6, B-2
- Color graphics,
 - Adapter and CRT checks, 5-11—18
 - Adapter check, 5-11—12
 - Attribute check, 5-12
 - Character set check,
 - 40-column, 5-14
 - 80-column, 5-13
 - Color video check, 5-17

- Graphics mode check,

- 320 x 200, 5-14

- 640 x 200, 5-15

- Light pen check, 5-16—17

- Screen paging check, 5-16

- Sync check, 5-18

- Color video check, 5-17

- Commands, See MS-DOS commands

- Conditional format (normal), hard disk, 3-3—4

- Coprocessor (8087), 5-21

- CPU chip (8088), 5-6

- CRT, 5-8, 5-11

D

- DATE command, 2-1, 2-3

- Date, setting, 2-1, 2-3-4

- Destructive surface analysis, hard disk, 3-6—7

- DEVICE LIST, 5-2—6, 5-21

- DIAGSYS, 1-3

- DIP switches, 5-2, 5-4, 5-6, 5-8, 5-11 5-21—22, 7-3

- Diskette, format, 4-1

- Disk drives, 3-20, 5-18—21, 5-24—27

- Display, Monitor, 1-4, 5-8—18

- Dot-matrix printer check, 5-23—24

E

- Error,

- Codes, A-1—3

- Correction check, hard disk, 5-26

- Detection check, hard disk, 5-26

- Messages, A-1—3

- Resuming, 5-5

F

- FDISK, 5-26
- Flagged tracks, 3-2—8
- Floppy disk,
 - Controller check, 5-18—21
 - Drive check, 5-18-21, B-3
 - Formatting, 4-1
 - Random seek check, 5-19
 - Sequential seek check, 5-19
 - Speed check, 5-20, B-3
 - Write, read check, 5-19
- Format,
 - Diskette, 4-1
 - Hard disk, 3-1—8
 - HARD DISK FORMAT MENU,
 - 3-1—2, 3-4, 3-8

G

- Graphics mode check, 5-11, 5-14—15

H

- Hard disk,
 - Conditional format (normal),
 - 3-3—4
 - Controller checks, 5-24—27
 - Destructive surface analysis, 3-6
 - Drives, 5-24—27
 - Error detection and correction check, 5-26
 - Formatting/checking options, 3-1
 - Moving, 6-1
 - Non-destructive surface analysis,
 - 3-8
 - Read, verify check, 5-27
 - Seek check, 5-25
 - Unconditional format, 3-5
 - Write, read check, 5-25—26
- HARD DISK FORMAT MENU,
 - 3-1—2, 3-4, 3-8
- HDSIT, 1-3, 6-1
- HELP utility, 7-1—3

I

- Interface, printer, 5-21

K

- Keyboard check, 5-7—8, B-2

L

- Light pen check, 5-16—17

M

- Math coprocessor (8087) check, 5-21
- Messages, A-1—3
- Memory check, 5-6—7
- Mode, graphics, 5-11, 5-14—15
- Monochrome display,
 - Adapter and CRT checks,
 - 5-8—11
 - Adapter check, 5-9
 - Attribute check, 5-9
 - Character set check, 5-10
 - Checks, 5-8—11
 - Video check, 5-10
 - Sync check, 5-11
- Moving hard disk, 6-1
- MS-DOS, 1-2—3, 2-1, 2-3, 2-5, 3-1, 4-1, 5-6, 5-24, 5-26
- MS-DOS, commands, 2-1, 2-3, 3-1, 4-1, 5-26, 6-1, 7-1—3

N

- Non-destructive surface analysis,
 - hard disk, 3-8
- Num Lock, 5-8

O

OPERATION MENU, 1-2-3, 2-1,
2-3, 3-1, 4-1, 5-1—2, 5-26, 6-1, 7-1

P

Paging, screen check, 5-16
Parallel port check, 5-21—22
Power-on diagnostics (self test), 1-1,
B-1—3
Primary serial port, 2-2, 2-5—6
Printer interface check, 5-21—22
Printer, dot-matrix, 5-23—24
Program, Setup, Intro-1, 1-2—3,
2-1—6

R

RAM,
Checks, 5-6—7, B-2
CMOS, 2-1—3, 5-6, B-2
Video, 5-9
Random seek check, 5-19
Read, verify, 5-27
Real-time clock, setting, 2-1—4
Reset system, 1-3
Resume from error,
Power-on diagnostics, B-1
System diagnostics, 5-5
ROMBIOS utility, 7-3
ROM system, 5-6

S

Screen paging check, 5-16
Scroll Lock, 5-8
Secondary serial port, 2-2, 2-5—6
Seek check, 5-25, B-3
Self test, 1-1, B-1—3
Sequential seek check, 5-19
Serial port (RS-232C) check,
5-22—23
Serial port settings, 1-1
Setting date, 2-3—4

Setting real-time clock, 2-1—4
Setting time, 2-3—4
SETUP command, 1-3, 2-1
Setup program, Intro-1, 1-2—3,
2-1—6
Starting diagnostics, 1-1
Speed check, 5-20
Switches, DIP 5-2, 5-4, 5-6, 5-8, 5-11,
5-22, 7-3
Sync check, 5-11, 5-18
SYSTAT utility, 1-1, 1-3, 7-1, 7-3—5
System,
Board check, 5-6
Device check, B-1
Diagnostics, 5-1—27
ROM, 5-6
Setting real-time clock, 2-3—4
Setup, Intro-1, 1-2—3, 2-1—6
Utilities, Intro-1 -2, 1-3, 7-1—5

T

Test, selecting, 5-4—5
TIME command, 2-3

U

Unconditional format, 3-5
Utilities, system-dependent
HELP, Intro-1—2, 1-3, 7-1—3
ROMBIOS, Intro-1—2, 1-3, 7-3
SYSTAT, Intro-1 -2, 1-3, 7-3

V

Video check,
Color graphics, 5-17
Monochrome display, 5-10
Video RAM, 5-9

W

Write, read check, 5-19, 5-25—26

1 Unpacking your Computer

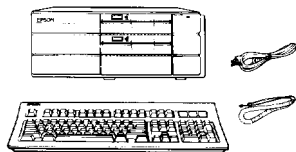

2 Choosing a Location

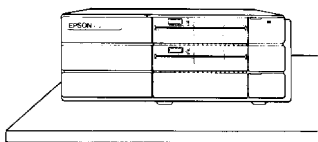

3 Arranging the Components



4 Connecting the Power Cord

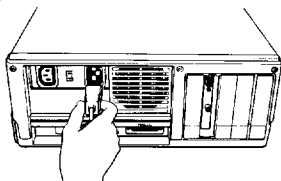

5 Connecting the Video Monitor

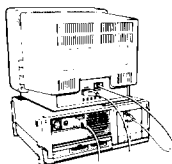

6 Connecting the Keyboard

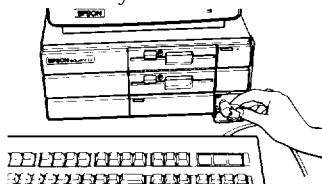

7 Connecting a Printer

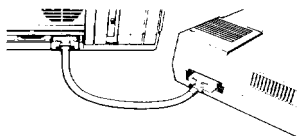

8 Setting the DIP Switches

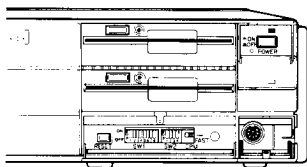

9 Turning on the Computer

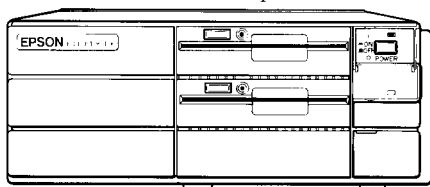

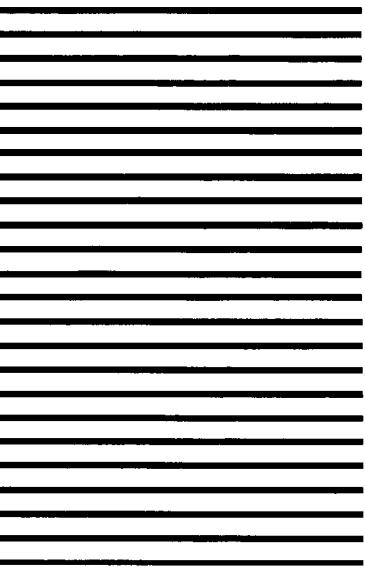

EPSON[®]

EPSON AMERICA, INC.
2780 Lomita Boulevard
Torrance, California 90505