



Quick Reference Guide

This book provides a quick reference to using your camera. It covers the camera's basic features and includes helpful tips for taking pictures in various locations.

IMPORTANT NOTICE DISCLAIMER OF WARRANTY

Epson America makes no representations or warranties, either express or implied, by or with respect to anything in this manual, and shall not be liable for any implied warranties of merchantability and fitness for a particular purpose or for any indirect, special, or consequential damages. Some states do not allow the exclusion of incidental or consequential damages, so this exclusion may not apply to you.

COPYRIGHT NOTICE

All rights reserved. No part of this publication may be reproduced, stored in a retrieval system, or transmitted, in any form or by any means, electronic, mechanical, photocopying, recording, or otherwise, without the prior written permission of Epson America, Inc. No patent liability is assumed with respect to the use of information contained herein. Nor is any liability assumed for damages resulting from the use of the information contained herein. Further, this publication and features described herein are subject to change without notice.

TRADEMARKS

EPSON is a registered trademark of SEIKO EPSON CORPORATION.

PhotoPC is a registered trademark and HyPict is a trademark of Epson America, Inc.

General notice: Other product names used herein are for identification purposes only and may be trademarks of their respective owners. EPSON disclaims any and all rights in those marks.

A NOTE CONCERNING RESPONSIBLE USE OF COPYRIGHTED MATERIALS

Digital cameras and scanners, like photocopiers and conventional cameras, can be misused by improper copying of copyrighted material. While some countries' laws permit limited copying in certain circumstances, those circumstances may not be as broad as some people assume. EPSON encourages each user to be responsible and respectful of the copyright laws when using digital cameras and scanners.

Contents

Installing Batteries 1

Camera Dial Settings 3

Status Display Panel 4

Formatting Your CompactFlash Memory Card 6

Removing a CompactFlash Memory Card 7

Installing a CompactFlash Memory Card 8

Taking Pictures 10

 Taking Pictures With the Viewfinder 11

 Taking Pictures With the LCD Screen 13

Playing Back Pictures 16

Deleting Pictures 17

Capturing Video Clips 18

Playing Back Video Clips 20

Deleting Video Clips 21

Tips for Getting Great Pictures From Your Camera 21

Using the LCD Setup and View Screens

Installing Batteries

Your camera includes a battery charger and a set of new, uncharged batteries. See your *User's Guide* for battery charging and safety instructions, then follow these steps to install the charged batteries:

- 1 Hold the camera upside-down.
- 2 Press and hold the battery cover lock down and slide the cover out to open it.

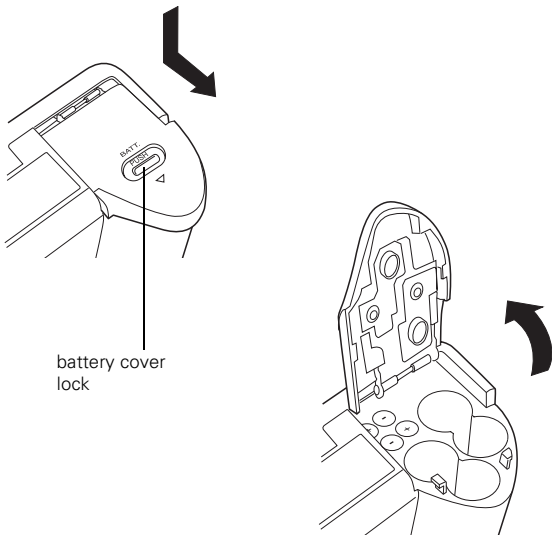

- 3** Insert four batteries into the compartment, positioning the + and – ends as shown below.

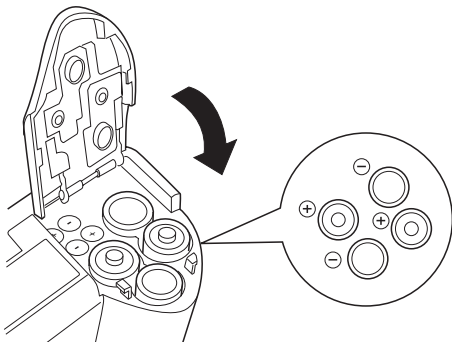

- 4** Lower the battery cover and slide it in.

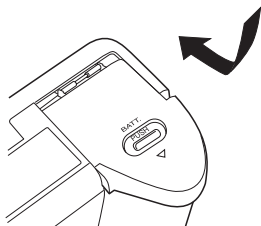



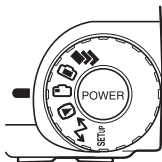

Camera Dial Settings

To turn on the camera, remove the lens cap, then press the **POWER** button in the center of the dial. (Press it again to turn the camera off.)



The following table describes camera dial settings.

| | |
|---|---|
|  | Use for video clips to capture motion, for interval mode to photograph scenes that change over time, and for continuous shooting mode to capture pictures in rapid succession. |
|  | Take pictures using the LCD screen. You can use the LCD screen to take panoramic, macro, and digital zoom pictures. |
|  | Take pictures using the viewfinder. This setting uses less battery power than taking pictures with the LCD screen. |
|  | Play back or delete your photos, sounds, and video clips, or lock and unlock photos. |
|  | Connect your camera to your computer to download or upload photos, sounds, and video clips. Also use it to create DPOF files with the PrintMark program. See your <i>User's Guide</i> . |
| SETUP | Set up or view camera information and settings. |

Status Display Panel

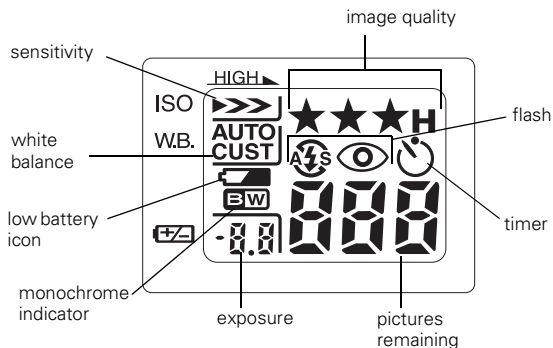

These settings appear on the status display panel on the top of the camera:



Status Display Panel Settings

| Image Quality Settings | Flash Settings |
|---|------------------------|
| ★ Standard (640 X 480 pixels) | ⚡ Automatic |
| ★★ Fine (2048 X 1536 pixels) | ⚡ Forced Flash |
| ★★★ Super Fine (2048 X 1536 pixels) | 🚫 Flash Off |
| ★★★ ^H HyPict™ (2544 X 1904 pixels) | ⚡s Slow Synchronized** |
| ★★★ ^M Uncompressed Tiff* (2048 X 1536 pixels) | 👁 Red-eye Reduction |

Status Display Panel Settings (Continued)

| | |
|---|---|
| Low Battery Icon Indicates that the camera batteries are low. | Monochrome Indicator*** Indicates that the camera is set to monochrome (black and white) mode. |
| Sensitivity Settings**  Standard (ISO 100)  High (ISO 200)  Super High (ISO 400) | White Balance Settings** AUTO Adjusts white balance automatically. FIX Locks white balance at 5200°K. CUST Lets you customize white balance. |
| Exposure Settings** Changes the automatic exposure setting from -2.0 to +2.0 EV in increments of 0.5 in Program mode and 0.2 in Manual mode. | Timer If the timer icon appears, the timer is on. |
| Pictures Remaining Displays the number of pictures you can still take. This number varies depending on your image quality setting. | |

* The Uncompressed Tiff setting must be enabled in the Shot Setup menu. See your *User's Guide* for details.

** These settings are only available in the Program and Manual user modes. See "Using the LCD Setup and View Screens" for instructions on changing the user mode.

*** The monochrome setting must be enabled in the SETUP menu. See your *User's Guide* for details.

Formatting Your CompactFlash Memory Card

To take photos, a CompactFlash™ memory card must be in your camera and formatted. Your camera comes with a preinstalled 16MB memory card that you must format before you take pictures. Follow these steps:

1 Press down the **POWER** button to turn on the camera and turn the camera dial to **SETUP**.

2 If you haven't set the clock yet, you see the clock setting screen with the year highlighted in red.

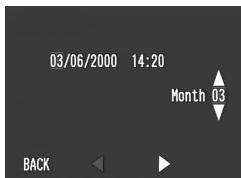

3 Press the buttons next to the up, down, right, and left arrows to change the date and time settings. (For detailed instructions, see your *User's Guide*.)

4 When you're finished, press the button under **BACK**. You see the **SETUP** menu.

5 Press the button under **Memory SETUP**. The **Memory Card Format** menu appears:



- 6 Press the button next to **MEMORY CARD FORMAT**. You see a warning message. Press the button next to **Yes** to format the card.
- 7 After the card is formatted, the camera returns to the Memory Card Format menu. Press the button under **BACK** to return to the **SETUP** menu.

Removing a CompactFlash Memory Card

CAUTION

Never remove the card while the camera is on. Data in the card may be lost or damaged.

Follow these steps to remove a memory card:

- 1 Place your finger behind the memory card cover latch and pull the cover open.

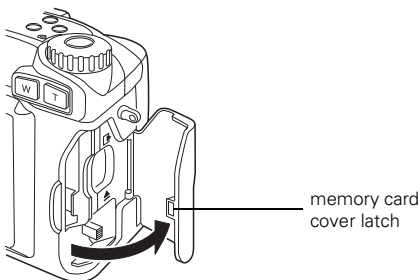

- 2 Push the eject button in to release the card. Then pull the card out and close the cover.

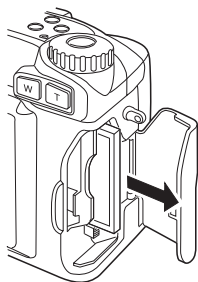
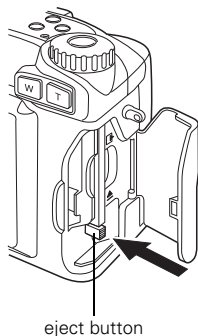

Installing a CompactFlash Memory Card

You can purchase additional CompactFlash memory cards (Type I, 4MB to 192MB) from leading suppliers. See your *User's Guide* for more information.

Follow these steps to install a memory card:

- 1 Make sure the camera is turned off. (Press the **POWER** button to turn the camera off, if it is on.)

- 2** Place your finger behind the memory card cover latch and pull the cover open.

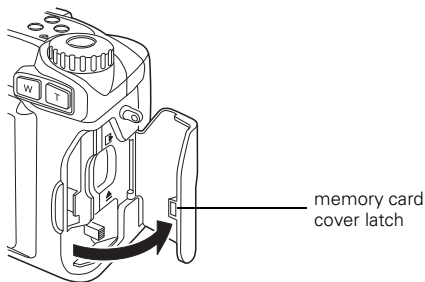

- 3** Insert the card all the way into the memory card slot. Make sure the front of the card is facing the same direction as the front of the camera, and the arrow on the card's label is pointing in. As you insert the card, the eject button pops up.

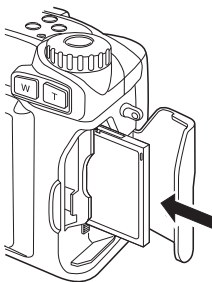

- 4** Close the memory card cover.

If you install a new memory card, make sure you format it before you start taking pictures. See page 6 for instructions.

Taking Pictures

If you prefer, you can take pictures using the viewfinder. Or, you can take pictures with the LCD screen to see a preview of how your image will appear.

Before you start taking pictures, you need to make sure the lens cap is removed, the batteries are installed and fully charged, and the CompactFlash memory card is installed and formatted, as described earlier in this book. You should also choose your user mode. (See "Using the LCD Setup and View Screens.") See your *User's Guide* for instructions on using your camera and its settings.

NOTE

Your camera requires at least 9.1MB of free space on your CompactFlash memory card to take Uncompressed Tiff mode pictures. If you are taking pictures in Tiff mode or HyPict mode, you will notice a delay in processing time of up to 32 seconds. (See your User's Guide for instructions on enabling Uncompressed Tiff mode.)

Taking Pictures With the Viewfinder

Use the camera's viewfinder to capture an image as you would with any point-and-shoot auto-focus camera.

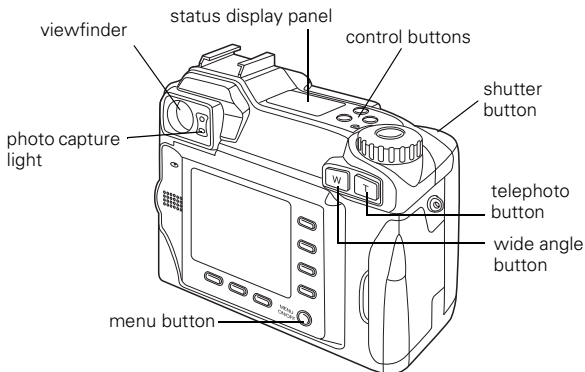



Make sure the lens cap is not on the camera, then follow these steps:

- 1** Make sure you are at least 20 inches (50 cm) away from your subject.
- 2** Press down the **POWER** button and turn the camera dial to . Wait until the photo capture light stops flashing and remains a steady green.
- 3** Use the camera's control buttons to change image quality, flash, or other basic settings. (See page 4 for a description of basic camera settings.)

NOTE

To change the programmed subject setting (when the user mode is set to Program), or make changes to exposure, white balance, or other advanced settings, press the **MENU** button to see the Viewfinder menu. (See your **User's Guide** for details.)

- 4 Look straight through the viewfinder and center your subject within the cross-hairs.
- 5 Push the **T** (telephoto) button to zoom in on your subject, or the **W** (wide angle) button to zoom out.
- 6 Hold the shutter button halfway down to lock the auto focus and exposure.
- 7 Press the shutter button the rest of the way down to take the picture.
- 8 Hold the camera still until the shutter snaps, then release the shutter button. When the photo capture light stops flashing, your image is saved.

CAUTION

If you set the camera down while the light is still flashing, do it carefully. The camera may lose your image if you set it down too hard.

Taking Pictures With the LCD Screen

The LCD screen lets you see a live preview of what the camera's lens sees at any moment.

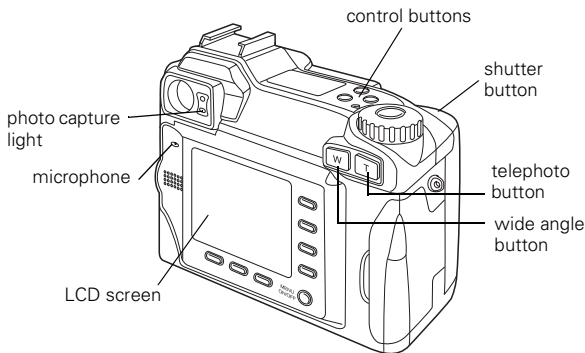

Make sure the lens cap is not on the camera, then follow these steps to take a picture using the LCD screen:

- 1 Make sure you are at least 20 inches (50 cm) away from your subject.

NOTE

You can get as close as 2.36 inches (6 cm) in Macro mode. The lens must be zoomed all the way out to get closer than 8 inches (20 cm). See your **User's Guide** for instructions.

- 2 Press down the **POWER** button and turn the camera dial to  to see a live preview with the View menu settings.

This example shows how the LCD screen looks in Program user mode. The screen looks different in Manual or Full Auto mode. (See the inside back cover to change the user mode.)



NOTE

If the camera is idle for more than the designated power off interval, it turns off automatically. To turn it back on, press the shutter button, or turn the camera off and then back on.

- 3 Make any changes you want to the settings on the View menu. You can also use the camera's control buttons to change image quality, flash, or other basic settings. (See page 4 for a description of basic camera settings.)
- 4 Push the **T** (telephoto) button to zoom in on your subject, or the **W** (wide angle) button to zoom out. You see a display with green zoom steps and the current zoom position in yellow.



- 5 Center your subject on the screen, then press the shutter button halfway down to lock the auto focus and exposure.



You see a green circle ● on the screen when the camera locks the settings.

- 6 Press the shutter button the rest of the way down to take the picture.



- 7 Hold the camera still until the shutter snaps. Then release the shutter button.

If the confirmation setting is on, you see a confirmation screen after a few seconds.



NOTE

You enable the confirmation screen in the Shot Setup menu. See your **User's Guide** for detailed instructions.

From the confirmation screen, you can do the following:

- ▶ Press the button next to **Delete** if you don't want the picture.

- ▶ Press the button next to **Rec Sound** to record a voice message or other sound. You see a countdown on the screen. During this time, you can record a message into the camera's microphone.
- ▶ Press the button next to  to instantly play back your images. (Press the button under **BACK** to return to the View menu.)

For more detailed instructions on using the confirmation screen, see your *User's Guide*.

When the camera's green photo capture light stops flashing, the camera is ready to take another picture.

Playing Back Pictures

You can play back your pictures in the camera's playback menu.

NOTE

- ▶ For detailed instructions on options such as displaying a slide show, locking and unlocking photos, and recording and deleting sounds, see your **User's Guide**.
 - ▶ If you are viewing *Uncompressed Tiff* images, you will notice a delay when you play them back.
-

Follow these steps:

- 1 Press down the camera's **POWER** button to turn on the camera, and turn the camera dial to .

You see the playback screen displaying the last picture you took:



- 2 Press the button next to the right arrow to display the earliest picture taken. You can continue pressing the same button to view your pictures in order. Or, press the button next to the left arrow to move backward through your pictures.

Deleting Pictures

If you want to delete images stored on the camera, follow these steps:

- 1 Follow steps 1 and 2 in the section above to play back your images.
- 2 When you see the image you want to delete, press the button under **Delete**.

- 3 You see a confirmation screen. Press the button next to **Yes** to delete the image.



You can also delete multiple photos or lock and unlock photos for deletion; see your *User's Guide*.

Capturing Video Clips

Make sure the lens cap is not on the camera, then follow these steps to capture 25-second video clips:

- 1 Press the **POWER** button down to turn on your camera and turn the camera dial to .

NOTE

*If you want to adjust any camera settings, such as white balance, sensitivity, or macro mode, turn the camera dial to  to see the View menu and adjust the settings, then turn the camera dial back to . (See your **User's Guide** for instructions on using camera settings.)*

You see the video clip capture screen:

- 2 Press the button next to **Sound** to turn the setting to **On** or **Off**.



- 3** Push the **T** (telephoto) button to zoom in on your subject, or the **W** (wide angle) button to zoom out. You see a display with green zoom steps and the current zoom position in yellow.



Make sure you are zoomed to the position you want; you can't change the zoom setting once you've started recording.

- 4** Press the shutter button to begin recording your video clip. If you want to stop the recording, press the shutter button again.

You see the red letters **REC** on the screen while your camera is recording. When the recording is done, the camera displays **Please wait...** and takes a few seconds to store the video.

You can play back your video, as described on page page 20.

Playing Back Video Clips

Follow these steps to play back your video clips:

- 1 Press the **POWER** button to turn on your camera and turn the camera dial to . You see the last picture you took on the LCD screen. (If you haven't taken any photos, you see a gray screen with the following message: **There is no image.**)

- 2 Press the button under **Menu Change**.

- 3 Press the button next to **Video Clip**. The camera displays **Please wait...** as it accesses your video clip. After a few seconds, you see a video clip playback screen:



- 4 Press the buttons next to the left and right arrows to select a video clip.

- 5 Press the button next to **Play**. You see your video clip playing in a screen like this:

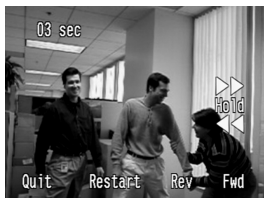

- 6 Press the button under **Quit** to stop playing the video clip.

For detailed playback information, see your *User's Guide*.

Deleting Video Clips

Follow these steps to delete a video clip:

- 1 Follow steps 1 through 4 under “Playing Back Video Clips,” to select a video clip for deletion.
- 2 Press the button next to **Delete**.
- 3 You see a confirmation screen. Press the button next to **Yes** to delete the video clip. Press the button next to **No** if you don't want to delete it.

Tips for Getting Great Pictures From Your Camera

Here are some tips to help you use the camera's settings. Conditions and subjects vary, so these settings may not be exactly right for your specific photograph.

NOTE

*This section includes suggested advanced settings that are described in detail in your **User's Guide**. Many of these settings can only be changed in Manual or Program mode. (See "Using the LCD Setup and View Screens," to change the user mode.)*

If you are taking pictures in bright sunlight:

- ▶ Reduce the automatic exposure setting.
- ▶ Use a fast shutter speed or narrow aperture setting.
- ▶ Use an optional filter with the PhotoPC 3000Z's included lens adapter to cut down on excessive light and protect the camera's lens.

If you are taking pictures when it is cloudy, you might want to adjust your camera settings as follows:

- ▶ Increase the automatic exposure setting.
- ▶ Try using fixed white balance.
- ▶ If the sky has complete cloud cover, you may want to avoid taking landscape photos. Portrait photos and closer shots are better under these conditions.
- ▶ If the sky is partly cloudy, you can take landscape photos with interesting cloud formations.

Under fluorescent lighting, you need to counteract the cool, bluish lighting that results. Try the following:

- ▶ Use custom or fixed white balance.
- ▶ Avoid taking portraits under fluorescent lights.

To capture beautiful sunsets without losing any of the color or lighting effects, set up the camera as follows:

- ▶ Use the fixed white balance setting.

- ▶ Adjust exposure settings for different effects.
- ▶ Take shots at different times of the sunset to capture the changing colors. (Try interval shooting mode.)

Under low light conditions, it is often difficult to capture a good shot of the background as well as your subject. Try the following:

- ▶ Increase the automatic exposure setting.
- ▶ Use a wide aperture or slow shutter speed.
- ▶ Use a higher sensitivity or ISO equivalent. (A tripod is recommended when using higher sensitivity settings.)
- ▶ Use the slow synchronized flash setting to light up the background along with the subject.

When you are taking portraits, you should set up your camera so it captures flattering images that make your subject the center of attention:

- ▶ Try the spot metering setting. Be sure to center your subject when locking the camera settings with the two-step shutter.
- ▶ Be aware of lighting conditions and how they affect the appearance of your subject. Early morning and late afternoon provide flattering light for portraits.
- ▶ Try the Program mode **Portrait** setting.

- ▶ Try to get on the same level as your subject; shots are more interesting if they are taken from the subject's perspective.

Action shots can be tricky. To get the best results:

- ▶ Use a fast shutter speed.
- ▶ Pick a good location where you can capture a shot at any moment.
- ▶ In Program mode, try the **Sports** setting.

For all your pictures:

- ▶ Don't forget about your optical zoom, black and white, Macro mode, and other specialized settings. You can frame the exact shots you want, reducing the time you might spend adjusting your images.
- ▶ Hold the camera as still as possible and use a tripod if you have one.
- ▶ Program mode has great shortcuts for **Landscape**, **Portrait**, and **Sports** images.
- ▶ Try HyPict mode or Uncompressed Tiff mode for prints that will be enlarged up to A3-size (12 × 17 inches).
- ▶ Don't forget that if you don't like the way a shot comes out, you can erase it from your CompactFlash memory card and take another one.

Using the LCD Setup and View Screens

To change a setting, press the button under or next to the setting.

1

Press the POWER button to turn the camera on. Turn the camera dial to **SETUP** to go to the Setup menu, then press the button next to the current mode setting to cycle through the modes: Program, Manual, and Full Auto.

2

3

4

Program

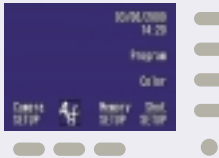

Setup Menu



View Screen

Turn the camera dial to  to go to the View Screen

Take Your Picture

Manual



Setup Menu

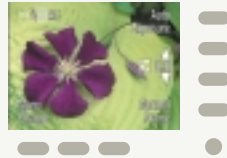

View Screen 1

Turn the camera dial to  to go to the View Screen

View Screen 2

Optionally, press the button under Menu Change to go to View Screen 2

Take Your Picture

Full Auto



Setup Menu

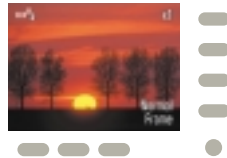

View Screen

Turn the camera dial to  to go to the View Screen

Take Your Picture