



AL-MX200 Series

User's Guide

Contents

Preface

Copyright and Trademarks.	11
Using This Guide.	12
Conventions.	12
Illegal Copies and Printouts.	13
Product Features.	13
Features.	13

Chapter 1 Specifications

Copy Function.	18
Print Function.	20
Scan Function.	22
Fax Function.	23
Direct Fax Function.	24
ADF Function.	25

Chapter 2 Basic Operation

Main Components.	26
Front View.	26
Rear View.	27
Automatic Document Feeder (ADF).	27
Operator Panel.	28
Setting Initial Settings on the Operator Panel.	29
Printing the Panel Settings Page.	30
The Operator Panel.	30
The Printer Setting Utility.	31
Power Saver Mode.	31
Exiting the Power Saver Mode.	32

Chapter 3 **Printer Management Software**

Print and Scan Drivers.	33
EpsonNet Config.	33
Creating an Administrative Password.	34
Printer Setting Utility (Windows Only).	34
Status Monitor (Windows Only).	35
Launcher (Windows Only).	36
Address Book Editor.	37
Express Scan Manager.	37

Chapter 4 **Printer Connection and Software Installation**

Overview of Network Setup and Configuration.	39
Connecting Your Printer.	39
Connecting Printer to a Computer or a Network.	40
Setting the IP Address.	43
TCP/IP and IP Addresses.	43
Automatically Setting the Printer's IP Address.	43
Dynamic Methods of Setting the Printer's IP Address.	43
Assigning an IP Address (for IPv4 Mode).	45
Verifying the IP Settings.	47
Printing and Checking the System Settings Page.	48
Installing Print Drivers on Computers Running Windows.	49
Using the PCL print driver.	50
Using Epson Universal P6 Printer Driver.	97
Installing Print Drivers on Computers Running Mac OS X.	99
Configuring Wireless Settings on the Operator Panel (AL-MX200DWF only).	99
Installing Print Drivers on Computers Running Linux (CUPS).	104
Installing Print Drivers.	104
Specifying the Queue.	105
Specifying the Default Queue.	110
Specifying Printing Options.	111
Setting the Password for Authority as the Printer Administrator.	113
Uninstalling Print Drivers.	113

Chapter 5 **Printing Basics**

About Print Media.	115
----------------------------	-----

Print Media Usage Guidelines.	115
Automatic Document Feeder (ADF) Guidelines.	116
Print Media That Can Damage Your Printer.	117
Print Media Storage Guidelines.	119
Supported Print Media.	119
Usable Print Media.	119
Loading Print Media.	122
Capacity.	123
Print Media Dimensions.	123
Loading Print Media in the Paper Tray.	123
Loading Print Media in the Priority Sheet Inserter (PSI).	132
Using the Output Tray Extension.	136
Setting Paper Sizes and Types.	137
Setting Paper Sizes.	137
Setting Paper Types.	138
Printing.	138
Printing from the Computer.	138
Canceling a Print Job.	139
Duplex Printing.	140
Direct Printing Using a USB Storage Device.	145
Selecting Printing Options.	147
Printing Custom Size Paper.	152
Checking Status of a Print Job.	154
Printing a Report Page.	155
Printer Settings.	156
Printing with the Web Services on Devices.	158
Adding Roles of Print Services.	158
Printer Setup.	159

Chapter 6 **Copying**

Loading Paper for Copying.	161
Preparing a Document.	161
Making Copies From the Document Glass.	162
Making Copies From the Automatic Document Feeder (ADF).	164
Customizing Copy Options.	165
Number of Copies.	165
Original Size.	166
Output Paper Size.	167

Reduce/Enlarge.	168
Collated.	170
Document Type.	171
Lighten/Darken.	172
Sharpness.	173
Auto Exposure.	174
2-Sided.	175
Multiple Up.	175
Margin Top/Bottom.	177
Margin Left/Right.	178
Margin Middle.	179
Copying an ID Card.	180
Changing the Default Copy Settings.	181

Chapter 7 **Scanning**

Scanning Overview.	182
Scanning to a USB Connected Computer.	182
Using the Operator Panel.	182
Using the TWAIN Driver.	183
Using the WIA Driver.	185
Using a Scanner on the Network.	186
Overview.	187
Confirming the Login name and the Password.	189
Specifying a Destination to Store Scanned Documents.	191
Configuring the Printer.	202
Sending the Scanned File to the Network.	209
Scanning to a USB Storage Device.	210
Sending an E-Mail With the Scanned Image.	211
Adding an Entry to the Address Book.	211
Configuring an SMTP Server.	213
Sending an E-mail With the Scanned File.	215
Customizing Scan Options.	216
Changing the Default Scan Settings.	216
Changing the Scan Settings for an Individual Job.	218

Chapter 8 **Faxing**

Connecting the Telephone Line.	220
Configuring Fax Initial Settings.	221
Setting Your Region.	221
Setting the Printer ID.	222
Setting the Time and Date.	223
Changing the Clock Mode.	223
Sending a Fax.	224
Loading a Source Document on the Automatic Document Feeder (ADF).	224
Loading a Source Document on the Document Glass.	225
Resolution.	226
Document Type.	227
Lighten/Darken.	227
Inserting a Pause.	228
Sending a Fax from Memory.	228
Sending a Fax Manually.	229
Confirming Transmissions.	230
Automatic Redialing.	231
Sending a Delayed Fax.	231
Sending a Fax Using the Driver (Direct Fax).	232
Sending a Fax from Windows.	232
Sending a Fax from Mac OS X.	234
Receiving a Fax.	237
About Receiving Modes.	237
Loading Paper for Receiving Faxes	237
Receiving a Fax Automatically in the FAX Mode.	238
Receiving a Fax Manually in the TEL Mode.	238
Receiving a Fax Automatically in the TEL/FAX Mode or Ans/FAX Mode.	238
Receiving a Fax Manually Using an External Telephone.	239
Receiving Faxes in the DRPD Mode.	239
Receiving Faxes in the Memory.	240
Polling Receive.	240
Automatic Dialing.	241
Speed Dialing.	241
Storing a Fax Number for Speed Dialing Using the Operator Panel.	241
Storing a Fax Number for Speed Dialing Using a Computer.	242
Sending a Fax Using Speed Dialing.	245
Group Dialing.	246
Creating Group Dial Numbers Using the Operator Panel.	247

Editing Group Dial Numbers Using the Operator Panel.	247
Creating and Editing a Fax Group Using a Computer.	248
Sending a Fax Using Group Dialing (Multi-address Transmission).	251
Printing the Address Book List.	253
Other Ways to Fax.	253
Using the Secure Receiving Mode.	253
Using an Answering Machine.	254
Using a Computer Modem.	255
Setting Sounds.	256
Speaker Volume.	256
Ringer Volume.	256
Specifying the Fax Settings.	257
Customizing Fax Options.	257
Available Fax Options.	257
Changing the Default Fax Settings.	261
Printing a Report.	261

Chapter 9 Using the Operator Panel Menus and Keypad

Understanding the Operator Panel Menus.	263
Report / List.	263
Meter Readings.	264
Admin Menu.	264
Defaults Settings.	304
Tray Settings.	317
Panel Language.	319
Panel Lock Feature.	320
Enabling the Panel Lock Feature.	320
Disabling the Panel Lock Feature.	321
Limiting Access to Copy, Fax, Scan, and USB Direct Print Operations.	321
Changing the Power Saver Mode Settings.	322
Resetting to Factory Defaults.	323
Changing the Language.	324
Using the Operator Panel.	324
Using the Printer Setting Utility.	324
Using the Numeric Keypad.	325
Entering Characters.	325
Changing Numbers or Names.	326

Chapter 10 **Troubleshooting**

Clearing Jams.	327
Avoiding Jams.	327
Identifying the Location of Paper Jams.	328
Clearing Paper Jams From the Automatic Document Feeder (ADF).	330
Clearing Paper Jams From the Front of the Printer.	333
Clearing Paper Jams From the Rear of the Printer.	338
Clearing Paper Jams From the Center Output Tray.	340
Jam Problems.	344
Basic Printer Problems.	345
Display Problems.	345
Printing Problems.	346
Print Quality Problems.	348
The Output Is Too Light.	348
Toner Smears or Print Comes Off/Stain on Back Side.	349
Random Spots/Blurred Images.	350
The Entire Output Is Blank.	351
Streaks Appear on the Output.	351
Mottle.	352
Ghosting.	352
Fog.	353
Bead-Carry-Out (BCO).	354
Auger Mark.	355
Wrinkled/Stained Paper.	355
The Top Margin Is Incorrect.	356
Protrudent/Bumpy Paper.	357
Copy Problem.	357
Copy Quality Problems.	358
Fax Problems.	359
Scanning Problems.	361
Scan Driver/Printer Utility Problems.	363
Other Problems.	364
Understanding Printer Messages.	364
Contacting Service.	375
Getting Help.	375
LCD Panel Messages.	376
Status Monitor Alerts.	376
Enabling the Non Genuine Toner Mode.	376
Using the Operator Panel.	376

Using the Printer Setting Utility (Windows Only)	377
--	-----

Chapter 11 **Maintenance**

Cleaning the Printer.	378
Cleaning the Scanner.	378
Cleaning the ADF Feed Roller.	380
Replacing the Toner Cartridge.	381
When to Replace the Toner Cartridge.	382
Removing the Toner Cartridge.	383
Installing a Toner Cartridge.	385
Ordering Supplies.	386
Consumables.	387
When to Order a Toner Cartridge.	387
Recycling Supplies.	388
Storing Consumables.	388
Managing the Printer.	388
Checking or Managing the Printer with EpsonNet Config.	388
Checking Printer Status with Status Monitor (Windows Only).	389
Checking Printer Status Through E-mail.	390
Conserving Supplies.	391
Checking Page Counts.	391
Moving the Printer.	392

Appendix A **Where To Get Help**

Contacting Epson Support.	395
Before Contacting Epson.	395
Help for Users in Europe.	395
Help for Users in Taiwan.	395
Help for Users in Singapore.	397
Help for Users in Thailand.	397
Help for Users in Vietnam.	398
Help for Users in Indonesia.	398
Help for Users in Hong Kong.	400
Help for Users in Malaysia.	400
Help for Users in the Philippines.	401

Index

Preface

Copyright and Trademarks

No part of this publication may be reproduced, stored in a retrieval system, or transmitted in any form or by any means, mechanical, photocopying, recording, or otherwise, without the prior written permission of Seiko Epson Corporation. No patent liability is assumed with respect to the use of the information contained herein.

Neither is any liability assumed for damages resulting from the use of the information contained herein. Neither Seiko Epson Corporation nor its affiliates shall be liable to the purchaser of this product or third parties for damages, losses, costs, or expenses incurred by purchaser or third parties as a result of: accident, misuse, or abuse of this product or unauthorized modifications, repairs, or alterations to this product, or (excluding the U.S.) failure to strictly comply with Seiko Epson Corporation's operating and maintenance instructions.

Seiko Epson Corporation and its affiliates shall not be liable against any damages or problems arising from the use of any options or any consumable products other than those designated as Original Epson Products or Epson Approved Products by Seiko Epson Corporation.

Apple®, Bonjour®, ColorSync®, Macintosh®, and Mac OS® are trademarks of Apple Inc. in the United States and/or other countries.

Microsoft®, Windows Vista®, Windows®, and Windows Server® are trademarks of Microsoft Corporation in the United States and/or other countries.

EPSON is a registered trademark of Seiko Epson Corporation.

General Notice: Other product names used herein are for identification purposes only and may be trademarks of their respective owners. Epson disclaims any and all rights in those marks.

Copyright © 2012 Seiko Epson Corporation. All rights reserved.

Using This Guide

Conventions

1. In this guide, personal computers and workstations are collectively called “computers”.
2. The following terms are used throughout this guide:

Important:

Important information that must be read and followed.

Note:

Additional information that merits emphasis.

See Also:

References within this guide.

3. Orientation of documents or paper is described in this guide as follows:

☐, ☐, Long Edge Feed (LEF): Loading the document or paper in the landscape orientation.

☐, ☐, Short Edge Feed (SEF): Loading the document or paper in the portrait orientation.

LEF Orientation

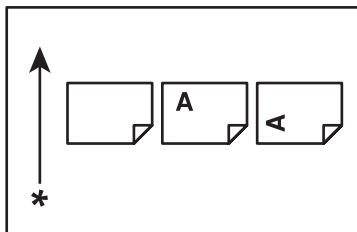

SEF Orientation

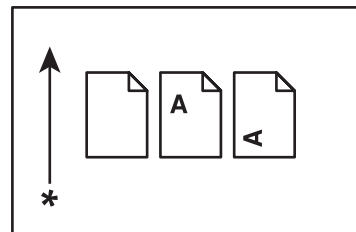

* Paper feed direction

4. The screen shots and illustrations in this guide are those of the AL-MX200DWF unless otherwise specified. Some of the items in the screen shots and illustrations may not be displayed or available depending on your printer model.
5. Some features are not available on some models.

Illegal Copies and Printouts

Copying or printing certain documents may be illegal in your country. Penalties of fines or imprisonment may be imposed on those found guilty. The following are examples of items that may be illegal to copy or print in your country.

- Currency
- Banknotes and checks
- Bank and government bonds and securities
- Passports and identification cards
- Copyright material or trademarks without the consent of the owner
- Postage stamps and other negotiable instruments

This list is not inclusive and no liability is assumed for either its completeness or accuracy. In case of doubt, contact your legal counsel.

Product Features

Features

This section describes the product features and indicates their links.

Duplex Print

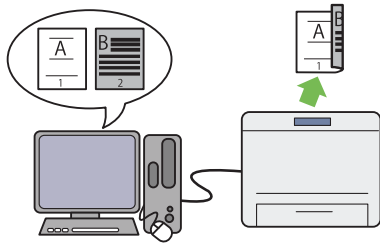

When you have multiple pages to print, you can use the duplex feature of the computer to print on either side of paper to save paper consumption.

For more information, see “Duplex Printing” on page 140.

Priority Sheet Inserter (PSI)

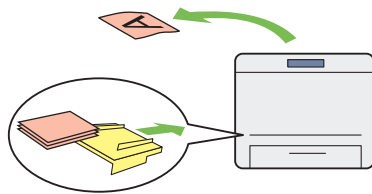

Print media loaded in the PSI is given precedence over the media in the paper tray. Using the PSI, you can print on print media of another type or size preferentially over the regular media in the paper tray.

For more information, see “Loading Print Media in the Priority Sheet Inserter (PSI)” on page 132.

Multiple Up Print

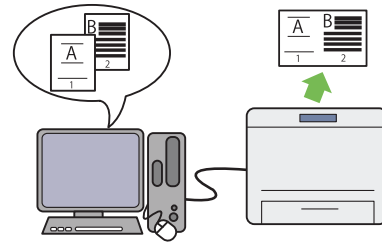

With the Multiple Up print feature of the printer, you can print multiple pages on a single sheet of paper to save paper consumption.

For more information, see the print driver's help.

Wireless Print (AL-MX200DWF only)

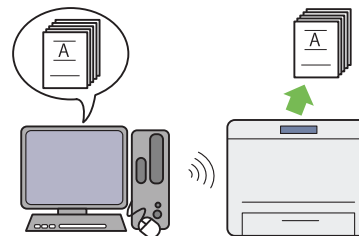

With the wireless LAN feature of the printer, you can place your printer at any location and print from a computer without cabling.

For more information, see “Configuring Wireless Network Settings (AL-MX200DWF only)” on page 54.

USB Direct Print

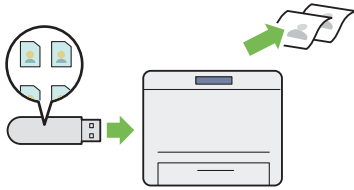

You can print directly from your USB storage device without starting your computer and an application.

For more information, see “Direct Printing Using a USB Storage Device” on page 145.

ID Card Copy



You can copy both sides of an ID card on one side of a single sheet of paper in its original size by selecting **ID Card Copy** on the operator panel.

For more information, see “Copying an ID Card” on page 180.

2-in-1 Copy

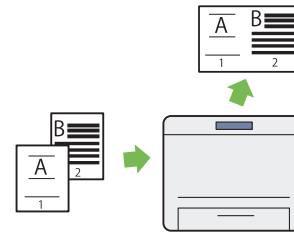

You can copy two original pages on one side of a single sheet of paper to save paper consumption.

For more information, see “Multiple Up” on page 175.

Scan to E-Mail

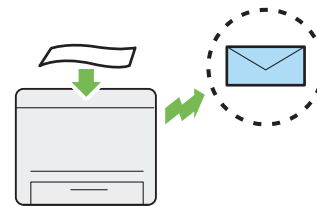

You can directly send scanned data as an e-mail attachment. You can choose destination e-mail addresses from the Address Book or enter addresses directly using the numeric keypad.

For more information, see “Sending an E-Mail With the Scanned Image” on page 211.

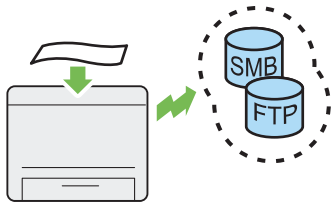
Scan to SMB/FTP (Network)

You can transfer scanned data to a computer or a server via SMB or FTP without service software. Although prior registration of the destination FTP server or the computer on the Address Book is required, it helps save your time.

For more information, see “Using a Scanner on the Network” on page 186.

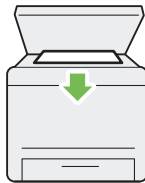
Scan from Document Glass

You can scan pages of a book or a brochure from the document glass. When you scan documents using the document glass, place them face down.

For more information, see “Making Copies From the Document Glass” on page 162.

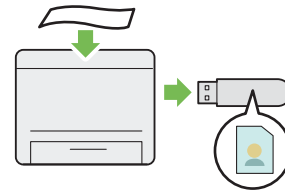
Scan to USB Storage Device

You do not need a computer to connect your USB storage device to save scanned data. Insert your USB storage device into the front USB port on the printer, and save scanned data directly to your USB storage device.

For more information, see “Scanning to a USB Storage Device” on page 210.

Scan from ADF

You can scan pieces of unbound paper using the Automatic Document Feeder (ADF). When you scan documents using the ADF, load them face up.

For more information, see “Making Copies From the Automatic Document Feeder (ADF)” on page 164.

Direct Fax from Computer

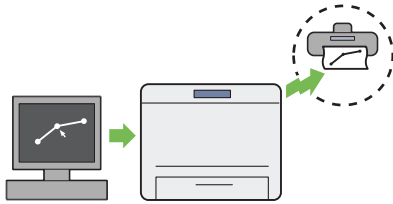

You can directly send faxes from your computer using the fax driver. You can select a recipient from the Phone Book (PC Fax Address Book) or Address Book (Device Address Book), or enter a name and fax number directly using the numeric keypad.

For more information, see “Sending a Fax Using the Driver (Direct Fax)” on page 232.

Address Book

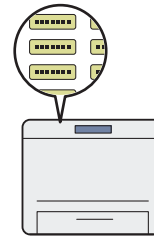

The Address Book simplifies the recipient specification. You can use the Address Book on the printer as well as on the server. Select the desired address or fax number from the Address Book when using the Scan to E-Mail or Scan to Network feature, or sending faxes.



For more information, see “Address Book Editor” on page 37.

Chapter 1

Specifications



Copy Function

Items	Description
Type	Desktop
Memory	256 MB
HDD	—
Scanning Resolution	Document glass: 600 × 600 dpi Automatic Document Feeder (ADF): 600 × 300 dpi
Printing Resolution	Standard: 600 × 600 dpi High Resolution: 1200 × 1200 dpi* * When printing in high resolution mode, printing speed may be reduced due to image quality adjustment. Printing speed may also be reduced depending on documents.
Halftone	256 grayscale gradation
Original Paper Size	Document glass: The maximum size is 215.9 × 297 mm for both sheets and books. Automatic Document Feeder (ADF): The maximum size is 215.9 × 355.6 mm.
Output Paper Size	Paper tray: Maximum: Legal Minimum: 76.2 × 127 mm (3 × 5") Priority Sheet Inserter (PSI): Maximum: Legal Minimum: A5 Image loss width: Top edge, 4 mm or less; bottom edge, 4 mm or less; left and right edges, 4 mm or less

Items	Description
Output Paper Weight	Paper tray: 60 – 163 gsm (for postcard 60 – 190 gsm is available) Priority Sheet Inserter (PSI): 60 – 163 gsm Important: Use paper recommended by Epson. Copying may not be performed correctly depending on the conditions. For more information, see “Print Media That Can Damage Your Printer” on page 117.
First Copy Output Time	20 seconds (for A4 ) / standard mode)
Reduction/Enlargement	Size-for-Size: 1:1 ± 1.3% Preset %: 1:0.50, 1:0.70, 1:0.81, 1:1.00, 1:1.22, 1:1.41, 1:2.00 Variable %: 1:0.25 - 1:4.00 (1% increments)
Continuous Copy Speed	Document glass: A4: 30 sheets/minute (Measured by making 11 copies of a single page document.) Automatic Document Feeder (ADF): A4: 20 sheets/minute (Measured by making a single copy of an 11- page document.) Important: <input type="checkbox"/> The speed may be reduced due to image quality adjustment. <input type="checkbox"/> The performance may be reduced depending on the paper type.
Paper Tray Capacity	Standard: 250 sheets (Paper tray) + 10 sheets (PSI) Maximum paper capacity: 260 sheets (standard)
Continuous Copy	99 images Note: The machine may pause temporarily to perform image stabilization.
Output Tray Capacity	Center output tray: Approximately 125 sheets (A4 ) Document output tray: Approximately 50 sheets (A4 )
Power Supply	AC 220 – 240 V ± 10%/110 – 127 V ± 10%, 5.2/9.8A for both 50/60 Hz ± 3Hz

Items	Description
Power Consumption	Sleep mode: 4 W or less Low Power mode: 8 W or less Standby mode: 55 W or less
Dimensions	Width 420 × Depth 398* × Height 365 mm * Measured when the paper tray is inserted but not extended.
Machine Weight	12.0 kg Important: <input type="checkbox"/> The weight of paper is not included. <input type="checkbox"/> The weight of the toner cartridge is included.
Space Requirement	Width 795.5 × Depth 1049* mm * Measured when the front cover and the rear cover are open.
Usage Environment	Temperature: 10 - 32 °C; Humidity: 10 - 85% (except malfunctions due to dew condensation) Non-Use: Temperature: -20 - 40 °C; Humidity: 5 - 85% (except malfunctions due to dew condensation) Important: Until the conditions (temperature and humidity) inside the printer become acclimated to the installation environment, certain qualities of the paper can cause poor printing.

Print Function

Items	Description
Type	Built-in
Continuous Print Speed* ¹	A4  : When plain paper is fed from the paper tray 1 Sided* ² : 30 sheets/min Important: * ¹ Print speed may decrease due to factors such as paper type, paper size, and printing conditions. * ² When continuously printing a single document of A4  .

Items	Description
Print Resolution	Standard: 600 × 600 dpi High Resolution: 1200 × 1200 dpi* * When printing in high resolution mode, printing speed may be reduced due to image quality adjustment. Printing speed may also be reduced depending on documents.
PDL	Standard: PCL® 5e, PCL® 6, PostScript Level3 Compatible, PDF (Ver. 1.6), TIFF, JPEG
Protocol	AL-MX200DNF: Ethernet (standard): TCP/IP (LPD, Port9100, WSD) AL-MX200DWF: Ethernet (standard): TCP/IP (LPD, Port9100, WSD) IEEE802.11b/g (standard) Note: <input type="checkbox"/> WSD stands for Web Services on Devices. <input type="checkbox"/> WSD is available only on Microsoft® Windows Vista® or Windows® 7.
Operating System* ¹	Microsoft® Windows® XP, Microsoft® Windows® XP x64 Edition, Microsoft® Windows Vista®, Microsoft® Windows Vista® x64 Edition, Microsoft® Windows Server® 2003, Microsoft® Windows Server® 2003 x64 Edition, Microsoft® Windows Server® 2008, Microsoft® Windows Server® 2008 x64 Edition, Microsoft® Windows Server® 2008 R2 x64 Edition, Microsoft® Windows® 7, Microsoft® Windows® 7 x64 Edition, Mac OS®* ² , Linux® OS* ³ Important: * ¹ For the latest information about the supported operating systems, contact our Customer Support Center or your dealer. * ² Mac OS® X 10.5.8 - 10.6, 10.7 are supported. * ³ Red Hat Enterprise Linux® 5/6 Desktop (x86), SUSE® Linux Enterprise Desktop 10/11 (x86), and Ubuntu 8/10 (x86) are supported.

Items	Description
Connectivity	AL-MX200DNF: Standard: Ethernet (100BASE-TX/10BASE-T), USB 2.0 AL-MX200DWF: Standard: Ethernet (100BASE-TX/10BASE-T), USB 2.0, IEEE802.11b/g

Scan Function

Items	Description
Type	Color scanner
Original Paper Size	Same as the Copy Function
Scanning Resolution	1200 × 1200 dpi, 600 × 600 dpi, 300 × 300 dpi, 200 × 200 dpi
Scanning Halftone	Monochrome: 1 bit for the line-art image, 8 bit for the gray-scale image Color: 24 bit
Connectivity	AL-MX200DNF: Standard: Ethernet (100BASE-TX/10BASE-T), USB 2.0 AL-MX200DWF: Standard: Ethernet (100BASE-TX/10BASE-T), USB 2.0, IEEE802.11b/g

Items	Description
Scan to PC	Protocol: TCP/IP (SMB, FTP) Operating System: Microsoft® Windows® XP, Microsoft® Windows Server® 2003, Microsoft® Windows Server® 2008, Microsoft® Windows Vista®, Microsoft® Windows® 7, Microsoft® Windows® XP x64, Microsoft® Windows Server® 2003 x64, Microsoft® Windows Server® 2008 x64, Microsoft® Windows Vista® x64, Microsoft® Windows Server® 2008 R2 x64, Microsoft® Windows® 7 x64, Mac OS® X 10.5.8 - 10.6, 10.7 Important: For the latest information about the supported operating systems, refer to the Epson Web Site. File Format: PDF (multi page 1 file) / JPEG / TIFF (1 page 1 file)
Scan to e-mail	Protocol: TCP/IP (SMTP, POP3) File Format: TIFF (1 page 1 file) / JPEG / PDF (multi page 1 file)

Fax Function

Items	Description
Send Document Size	Document glass: Maximum: 215.9 × 297 mm Automatic Document Feeder (ADF): Maximum: 215.9 × 355.6 mm
Recording Paper Size	Maximum: Legal Minimum: A5

Items	Description
Transmission Time	3 seconds (V.34) Important: When transmitting an A4 size 700-character document in the standard quality (8 × 3.85 lines/mm) and high speed mode (28.8 kbps or above: JBIG). This is only the transmission speed for image information and does not include the controlling time for the communication. Note that the actual transmission time depends on the content of documents, the machine that the recipient uses, and the status of the communication line.
Transmission Mode	ITU-T Super G3, ITU-T G3 ECM, ITU-T G3
Scanning Resolution	400 × 400 pixel/25.4 mm (R16 × 15.4 line/mm) 300 × 300 pixel/25.4 mm (R8 × 15.4 line/mm) 200 × 200 pixel/25.4 mm (R8 × 7.7 line/mm) 200 × 100 pixel/25.4 mm (R8 × 3.85 line/mm)
Coding Method	Monochrome: 1 bit, JBIG, MMR, MR, MH encoding Color: Not supported.
Transmission Speed	V.34 (33.6/31.2/28.8/26.4/24/21.6/19.2/16.8/14.4/12/9.6/7.2/4.8/2.4kbps) V.17 (14.4 /12 /9.6 /7.2kbps) V.29 (9.6 /7.2kbps) V.27ter (4.8 /2.4kbps)
No. of Fax Lines	RJ-11, 1 line PSTN, PBX. Leased line (3.4KHz/2-wire)

Direct Fax Function

Items	Description
Document Size	A4, Letter, Folio, Legal
Transmission Speed	Same as the Fax function
Transmission Resolution	Same as the Fax function
Applicable Lines	Same as the Fax function

Items	Description
Operating System	<p>Microsoft® Windows® XP, Microsoft® Windows Vista®, Microsoft® Windows Server® 2003, Microsoft® Windows Server® 2008, Microsoft® Windows® 7, Microsoft® Windows® XP x64, Microsoft® Windows Server® 2003 x64, Microsoft® Windows Server® 2008 x64, Microsoft® Windows Vista® x64, Microsoft® Windows Server® 2008 R2 x64, Microsoft® Windows® 7 x64, Mac OS® X 10.4.11, 10.5.8 - 10.6, 10.7</p> <p>Important: For the latest information about the supported operating systems, refer to the Epson Web Site.</p>

ADF Function

Items	Description
Type	Simplex
Life	80,000 images

Chapter 2

Basic Operation

Main Components

This section provides an overview of your printer.

Front View

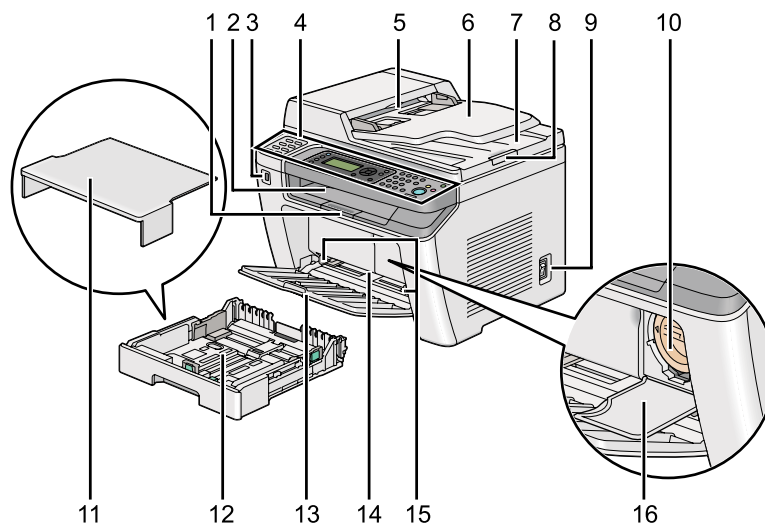

1	Output Tray Extension	2	Center Output Tray
3	Front USB Port	4	Operator Panel
5	Automatic Document Feeder (ADF)	6	Document Feeder Tray
7	Document Output Tray	8	Document Stopper
9	Power Switch	10	Toner Cartridge
11	Paper Tray Cover	12	Paper Tray
13	Front Cover	14	Priority Sheet Inserter (PSI)
15	Paper Width Guides	16	Toner Access Cover

Rear View

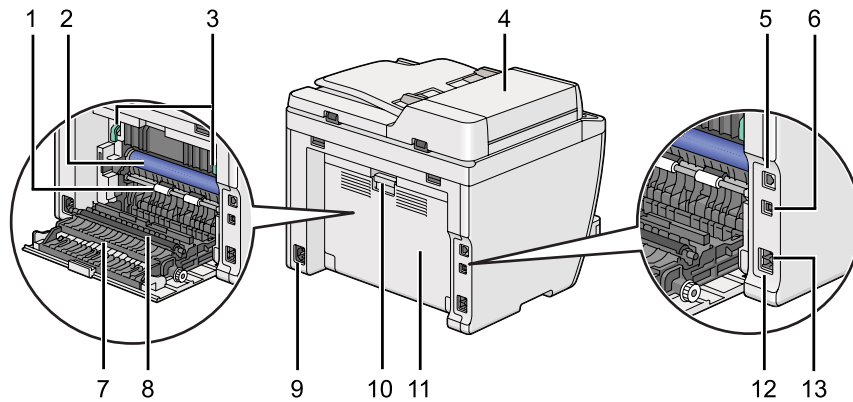

1	Registration Roller	2	OPC Drum
3	Levers	4	ADF Cover
5	Ethernet Port	6	USB Port
7	Paper Chute	8	Transfer Roller
9	Power Connector	10	Rear Cover Handle
11	Rear Cover	12	Phone Connector
13	Wall Jack Connector		

Automatic Document Feeder (ADF)

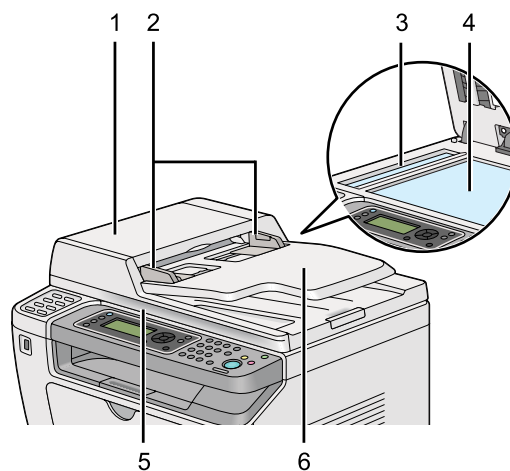







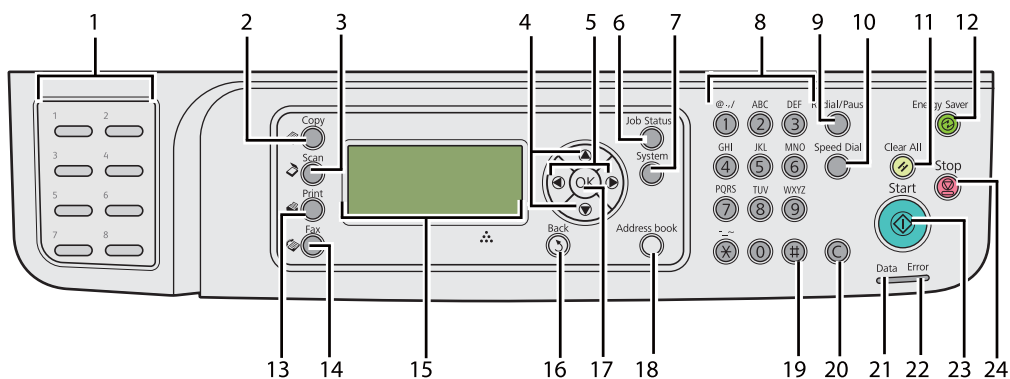





1	ADF Cover
2	Document Guides
3	ADF Glass
4	Document Glass
5	Document Cover
6	Document Feeder Tray

Operator Panel

The operator panel has a 4-line by 28-character liquid crystal display (LCD), light-emitting diodes (LED), control buttons, one-touch buttons, and numeric keypad, which allow you to control the printer.



1	One-touch buttons	Calls up the stored fax number registered in the Phone Book. The first eight fax numbers in the Phone Book are assigned to the buttons in row order, starting from the top left corner.
2	 (Copy) button/LED	Moves to the top level of the Copy menu.
3	 (Scan) button/LED	Moves to the top level of the Scan menu.
4	 buttons	Moves a cursor or highlight up or down.
5	 buttons	Moves a cursor or highlight left or right.
6	Job Status button/LED	Moves to the top level of the Job Status menu.
7	System button/LED	Moves to the top level of the System menu.
8	Numeric keypad	Enters characters and numbers.

9	Redial/Pause button	Re-dials a telephone number. To insert a pause between numbers, press the Redial/Pause button and confirm that “-” appears on the LCD panel.
10	Speed Dial button	Calls up a stored telephone number.
11	 (Clear All) button	Resets the current setting, and returns to the top level of each service menu.
12	 (Energy Saver) button/LED	Lights up in the Sleep mode. Press this button to exit the Sleep mode.
13	 (Print) button/LED	Moves to the top level of the Print menu.
14	 (Fax) button/LED	Moves to the top level of the Fax menu.
15	LCD Panel	Displays various settings, instructions, and error messages.
16	 (Back) button	Returns to the previous screen.
17	 button	Confirms the entry of values.
18	Address Book button	Pressing this button at the Fax menu moves to the top level of the Phone Book menu.
19	# button	Enters characters “(space) & ()”.
20	C (Clear) button	Deletes characters and numbers.
21	Data LED	Lights up for incoming, outgoing, or pending jobs.
22	Error LED	Lights up when the printer has an error.
23	 (Start) button	Starts a job.
24	 (Stop) button	Cancels the current processing or pending job.

Note:

- Selecting a different menu or returning to the previous screen cancels the current entry or setting. Be sure to press the  button to save the current entry or setting.*
- For details on how to use the numeric keypad to enter alphanumeric characters, see “Using the Numeric Keypad” on page 325.*

Setting Initial Settings on the Operator Panel

You need to set the printer language and the clock date and time when you turn on the printer for the first time.

When you turn on the printer, a wizard appears on the LCD panel. Follow the steps below to configure the initial settings.

Note:

If you do not start configuring the initial settings, Select Function appears on the LCD panel in three minutes. After that, you can configure the following initial settings by selecting Power On Wizard on the operator panel as needed.

For details on the operator panel, see “Understanding the Operator Panel Menus” on page 263.

1. Select the language you want to use on the operator panel, and then press the **OK** button.
2. Press the **OK** button to start setting the region.
3. Select your region, and then press the **OK** button.
4. Select the appropriate time zone, and then press the **OK** button.
5. Specify the current date, and then press the **OK** button.
6. Specify the current time, and then press the **OK** button.
7. Press the **OK** button for fax setup.

If you want to skip the fax setup, press the **Start** button.

8. Enter your fax number, and then press the **OK** button.
9. Enter a name, and then press the **OK** button.
10. Press the **OK** button to complete the initial settings on the operator panel.

Printing the Panel Settings Page

The Panel Settings page shows current settings on the operator panel menus.

The Operator Panel

Note:

The reports and lists are all printed in English.

1. Press the **System** button.
2. Select **Report / List**, and then press the **OK** button.
3. Select **Panel Settings**, and then press the **OK** button.

The Panel Settings page is printed.

The Printer Setting Utility

The following procedure uses Microsoft® Windows® 7 as an example.

Note:

The reports and lists are all printed in English.

1. Click **Start** — **All Programs** — **EPSON** — your printer — **Printer Setting Utility**.

Note:

*The window to select a printer appears in this step when multiple print drivers are installed on your computer. In this case, click the name of the desired printer listed in **Printer Name**.*

The Printer Setting Utility starts.

2. Click the **Printer Settings Report** tab.
3. Select **Reports** from the list at the left side of the page.

The **Reports** page is displayed.

4. Click the **Panel Settings** button.

The Panel Settings page is printed.

Power Saver Mode

The printer has a power saving feature that reduces power consumption during periods of inactivity and operates in two modes: Low Power and Sleep. In Low Power mode, only the LCD panel goes blank. In Sleep mode, all LEDs, except for the **Energy Saver** LED, on the operator panel go out and the LCD panel goes blank. When the printer is in Sleep mode, it consumes less power than in Low Power mode.

By default, the printer enters Low Power mode in one minute of inactivity after completion of the last job, and then enters Sleep mode in another 6 minutes of inactivity. You can change these default settings in the following ranges:

Low Power mode: 1 to 45 minutes

Sleep mode: 6 to 11 minutes



See Also:

“Changing the Power Saver Mode Settings” on page 322

Exiting the Power Saver Mode

The printer automatically exits the power saver mode when it receives a print job from a computer or fax data through the telephone line. Alternatively, you can manually bring it back into standby mode. Press any button on the operator panel in Low Power mode. In Sleep mode, press the  (**Energy Saver**) button. Whether the printer is in Low Power or Sleep mode, it will take about 25 seconds for the printer to resume standby mode.

Note:

- In Low Power mode, opening and closing the rear cover will bring the printer back into standby mode.*
- When the printer is in Sleep mode, all buttons on the operator panel except for the  (**Energy Saver**) button do not function. To use the buttons on the operator panel, press the  (**Energy Saver**) button to exit the power saver mode.*

See Also:

“Changing the Power Saver Mode Settings” on page 322

Chapter 3

Printer Management Software

Print and Scan Drivers

To access all of your printer's features, install print and scan drivers from the Software Disc.

- ❑ A printer driver enables communications between your computer and printer and provides access to your printer features.
- ❑ The scan driver enables you to scan images directly to your personal computer and place scanned images directly into an application via USB or the network.

The scan driver is installed along with your print driver. It is available for Microsoft® Windows® and Mac OS® X.

See Also:

- ❑ *“Installing Print Drivers on Computers Running Windows” on page 49*
- ❑ *“Installing Print Drivers on Computers Running Mac OS X” on page 99*
- ❑ *“Installing Print Drivers on Computers Running Linux (CUPS)” on page 104*

EpsonNet Config

This section provides information on EpsonNet Config.

EpsonNet Config is a hyper text transfer protocol (HTTP)-based web page service that is accessed through your web browser.

Using EpsonNet Config, you can confirm the printer status, and change the printer configuration options easily. Anyone on your network can access the printer using EpsonNet Config. In administrative mode, you can change the configuration of the printer, set up your fax directories, and manage your printer settings without leaving your computer.

Note:

- ❑ *Users who are not given passwords by the administrator can still view the configuration settings in user mode. They will not be able to save or apply any changes to the current configuration and settings.*

- ❑ For details on the menu items of EpsonNet Config, refer to the *Help on EpsonNet Config*.

Creating an Administrative Password

1. Launch your web browser.
2. Enter the IP address of the printer in the address bar, and then press the **Enter** key.
3. Click the **Properties** tab.
4. In the left navigation panel, scroll down to **Security** and select **Administrator Settings**.
5. Select **Enabled** for **Administrator Mode**.
6. In the **Administrator Login ID** field, enter a name for the administrator.

Note:

The default ID and password are both blank.

7. In the **Administrator Password** and **Re-enter Password** fields, enter a password for the administrator.
8. In the **Maximum Login Attempts** field, enter the number of login attempts allowed.
9. Click **Apply**.

Your new password has been set and anyone with the administrator name and password can log in and change the printer configuration and settings.

Printer Setting Utility (Windows Only)

The Printer Setting Utility allows you to view or specify the system settings. You can also diagnose the system settings with the Printer Setting Utility.

The Printer Setting Utility consists of the **Printer Settings Report**, **Printer Maintenance**, and **Diagnosis** tabs.

The Printer Setting Utility is installed along with print drivers.

Note:

The **Password** dialog box appears the first time you attempt to change settings on Printer Setting Utility when the Panel Lock feature is enabled on the printer. In this case, enter the password you specified, and click **OK** to apply the settings.

Status Monitor (Windows Only)

You can check the printer status with Status Monitor. Double-click the Status Monitor printer icon on the taskbar at the bottom right of the screen. The **Printer Selection** window appears, which displays the printer name, printer connection port, printer status, and model name. Check the column **Status** to know the current status of your printer.

Settings button: Displays the **Settings** window and allows you to modify the Status Monitor settings.

Click the name of the desired printer listed on the **Printer Selection** window. The **Printer Status** window appears.

The **Printer Status** window alerts you when there is a warning or when an error occurs, for example, when a paper jam occurs or toner is running low.

By default, the **Printer Status** window appears automatically when an error occurs. You can specify the conditions for starting the **Printer Status** window in **Printer Status Window Properties**.

To change the pop-up settings for the **Printer Status** window:

1. Right-click the Status Monitor printer icon on the taskbar at the bottom right of the screen.
2. Select **Printer Status Window Properties**.

The **Printer Status Window Properties** window appears.

3. Select the type of the pop-up and then click **OK**.

You can also check the toner level of your printer (when a genuine toner cartridge is installed) and the job information on the **Printer Status** window.

Status Monitor is installed along with print drivers.

Launcher (Windows Only)

Using the **Launcher-Btype** window, you can open the **Status Window**, **Printer Setting Utility**, **Address Book Editor**, and **Express Scan Manager**.

To use the Launcher, select to install the Launcher when you install print drivers.

The following procedure uses Windows 7 as an example.

To start the Launcher:

1. Click **Start** — **All Programs** — **EPSON** — your printer — **Launcher**.

The **Launcher-Btype** window appears.

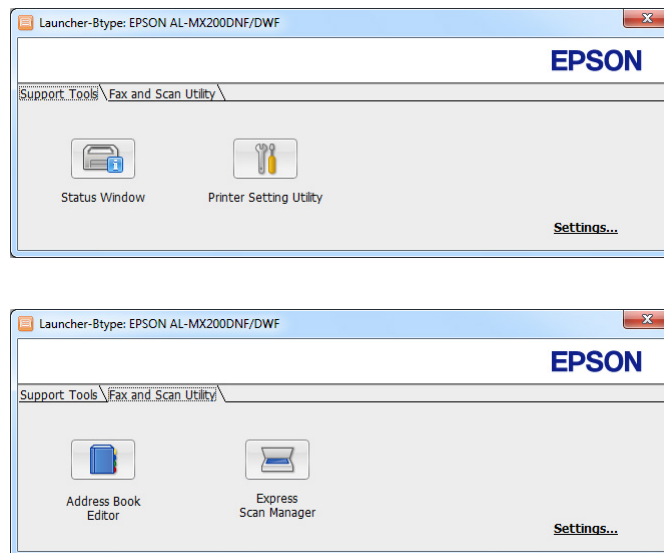

2. The **Launcher-Btype** window provides several buttons: **Status Window**, **Printer Setting Utility**, **Address Book Editor**, and **Express Scan Manager**.

To exit, click the **X** button at the top-right of the window.

For more information, click the **Help** button/icon of each application.

<p>Status Window</p>	<p>Opens the Printer Status window.</p> <p>See Also: "Status Monitor (Windows Only)" on page 35</p>
-----------------------------	---

Printer Setting Utility	Starts the Printer Setting Utility. See Also: "Printer Setting Utility (Windows Only)" on page 34
Address Book Editor	Starts the Address Book Editor, which allows you to add and edit Address Book entries. See Also: "Address Book Editor" on page 37
Express Scan Manager	Starts the Express Scan Manager. See Also: "Express Scan Manager" on page 37

Address Book Editor

The Address Book Editor provides a convenient interface for modifying the printer's Address Book entries. With it you can add:

- Fax entries
- E-Mail entries
- Server entries

When you start the software, the Address Book Editor reads the printer's Address Book. You can add, edit, and delete entries. After making changes, you can then save the updated Address Book to the printer or to your computer.

The Address Book Editor is installed along with your print driver. It is available for Windows and Mac OS X.

Express Scan Manager

The Express Scan Manager handles scan jobs sent from the printer to your computer via USB. When scan jobs are sent from the printer to the computer, the Express Scan Manager automatically manages the scan jobs.

Before scanning to your computer, start the Express Scan Manager and specify the location to send scanned image files.

Click **Open the image file** to display scanned files saved in the specified destination after scanning.

The Express Scan Manager is installed along with your print driver. It is available for Windows and Mac OS X.

Note:

When you separately install the Express Scan Manager from the Software Disc, you also need to install the scan driver from the Software Disc.

See Also:

“Using the Operator Panel” on page 182

Chapter 4

Printer Connection and Software Installation

Overview of Network Setup and Configuration

To set up and configure the network:

1. Connect the printer to the network using the recommended hardware and cables.
2. Turn on the printer and the computer.
3. Print the System Settings page and keep it for referencing network settings.
4. Install the driver software on the computer from the Software Disc. For information on driver installation, see the section in this chapter for the specific operating system you are using.
5. Configure the printer's TCP/IP address, which is required to identify the printer on the network.
 - Microsoft® Windows® operating systems: Run the installer on the Software Disc to automatically set the printer's Internet Protocol (IP) address if you connect the printer to an established TCP/IP network. You can also manually set the printer's IP address on the operator panel.
 - Mac OS® X and Linux® systems: Manually set the printer's TCP/IP address on the operator panel. To use a wireless connection (AL-MX200DWF only), also configure wireless network settings on the operator panel.
6. Print the System Settings page to verify the new settings.

Note:

The reports and lists are all printed in English.

See Also:





"Printing the System Settings Page" on page 155

Connecting Your Printer

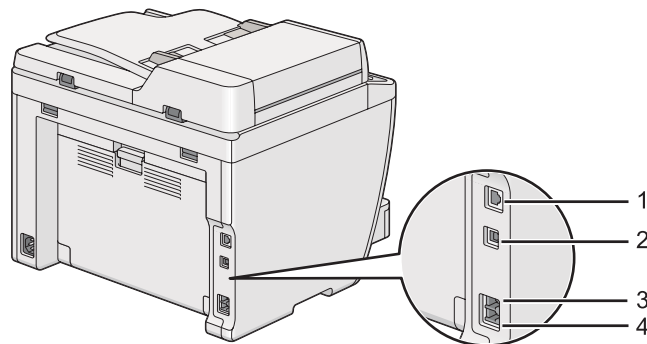
The interface cables of your printer must meet the following requirements:

Connection Type	Connection Specifications
Ethernet	10 Base-T/100 Base-TX compatible
USB	USB 2.0 compatible
Wireless (AL-MX200DWF only)	IEEE 802.11b/802.11g
Wall Jack Connector	RJ11
Phone Connector	RJ11WAll



1	Ethernet Port	
2	USB Port	
3	Wall Jack Connector	LINE 
4	Phone Connector	PHONE 

Connecting Printer to a Computer or a Network

Connect your printer via a USB, Ethernet, or wireless (AL-MX200DWF only) connection. Hardware and cabling requirements vary for the different connection methods. Ethernet cables and hardware are not supplied with your printer and must be purchased separately.

The available features for each connection type are shown in the following table.

Connection Type	Available Features
USB	When connected via USB connection you can: <ul style="list-style-type: none"> <input type="checkbox"/> Instruct print jobs from a computer. <input type="checkbox"/> Scan and print an image into an application. <input type="checkbox"/> Scan and print an image to a folder on the computer. <input type="checkbox"/> Use the Address Book Editor to manage Address Book entries.
Ethernet	When connected via Ethernet connection you can: <ul style="list-style-type: none"> <input type="checkbox"/> Instruct print jobs from a computer on the network. <input type="checkbox"/> Scan and print an image to a computer on the network. <input type="checkbox"/> Scan and print an image to an FTP server. <input type="checkbox"/> Scan to e-mail. <input type="checkbox"/> Use EpsonNet Config to manage Address Book entries.
Wireless (AL-MX200DWF only)	When connected via wireless connection you can: <ul style="list-style-type: none"> <input type="checkbox"/> Instruct print jobs from a computer on the network. <input type="checkbox"/> Scan and print an image to a computer on the network. <input type="checkbox"/> Scan and print an image to an FTP server. <input type="checkbox"/> Scan to e-mail. <input type="checkbox"/> Use EpsonNet Config to manage Address Book entries.

USB Connection

If your printer is connected to a network instead of your computer, skip this section and go to “Network Connection” on page 42.

To connect the printer to a computer:

1. Connect the smaller end of the supplied USB cable to the USB port on the rear of the printer, and the other end to a USB port on the computer.

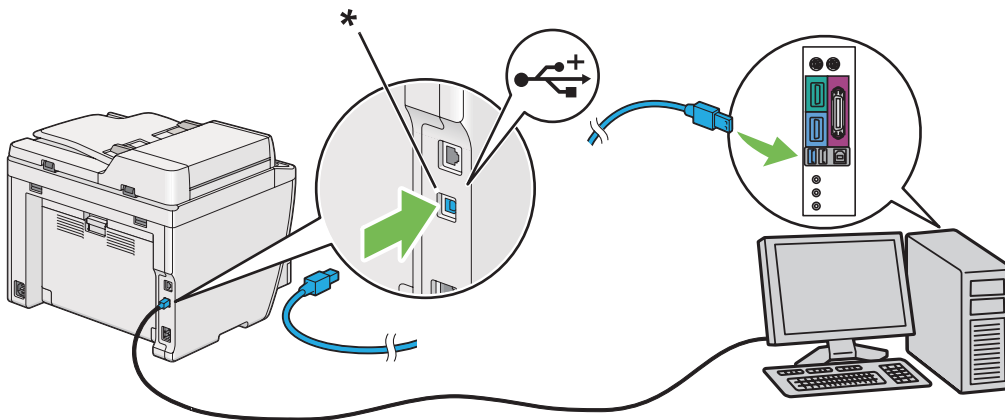

* USB port

Note:

Do not connect the printer USB cable to the USB connector available on the keyboard.

Network Connection

To connect the printer to an Ethernet network:

1. Ensure that the printer, computer and any other connected devices have been turned off and all cables have been disconnected.
2. Connect one end of an Ethernet cable to the Ethernet port on the rear of the printer, and the other end to a LAN drop or hub.

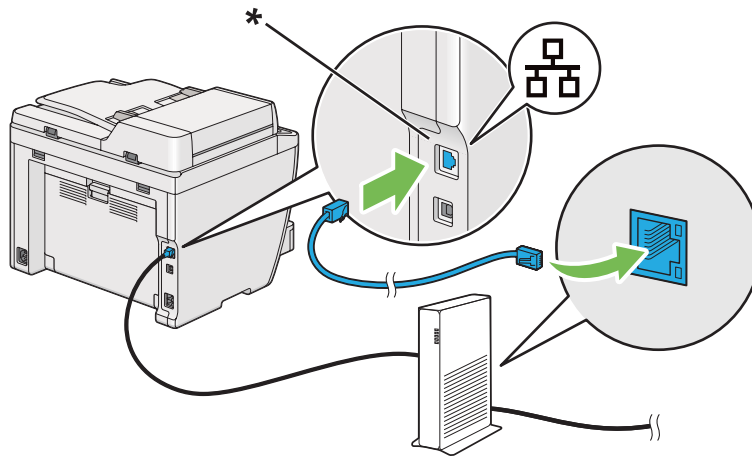

* Ethernet port

Note:

Do not connect the Ethernet cable when you intend to use the wireless network feature of the AL-MX200DWF model.

See Also:

“Configuring Wireless Network Settings (AL-MX200DWF only)” on page 54

Setting the IP Address

TCP/IP and IP Addresses

If your computer is on a large network, contact your network administrator for the appropriate TCP/IP addresses and additional system settings information.

If you are creating your own small Local Area Network or connecting the printer directly to your computer using Ethernet, follow the procedure for automatically setting the printer's IP address.

Computers and printers primarily use TCP/IP protocols to communicate over an Ethernet network. With TCP/IP protocols, each printer and computer must have a unique IP address. It is important that the addresses are similar, but not the same; only the last digit needs to be different. For example, your printer can have the address 192.168.1.2 while your computer has the address 192.168.1.3. Another device can have the address 192.168.1.4.

Many networks have a Dynamic Host Configuration Protocol (DHCP) server. A DHCP server automatically programs an IP address into every computer and printer on the network that is configured to use DHCP. A DHCP server is built into most cable and Digital Subscriber Line (DSL) routers. If you use a cable or DSL router, see your router's documentation for information on IP addressing.

Automatically Setting the Printer's IP Address

If the printer is connected to a small established TCP/IP network without a DHCP server, use the installer on the Software Disc to detect or assign an IP address to your printer. For further instructions, insert the Software Disc into your computer's CD/DVD drive. After the Installer starts, follow the prompts for installation.

Note:

For the automatic installer to function, the printer must be connected to an established TCP/IP network.



Dynamic Methods of Setting the Printer's IP Address

There are two protocols available for dynamically setting the printer's IP address:

- DHCP
- DHCP/Auto IP (enabled by default)







You can turn on/off either protocol using the operator panel or EpsonNet Config.

Note:

*You can print a report that includes the printer's IP address. On the operator panel, press the **System** button, select Report / List, press the  button, select System Settings, and then press the  button. The IP address is listed on the System Settings page.*

Using the Operator Panel

To turn on/off either the DHCP or the AutoIP protocol:

1. On the operator panel, press the **System** button.
2. Select Admin Menu, and then press the  button.
3. Select Network, and then press the  button.
4. Select TCP/IP, and then press the  button.
5. Select IPv4, and then press the  button.
6. Select Get IP Address, and then press the  button.
7. Select DHCP/AutoIP or DHCP, and then press the  button.
8. Turn off and turn on the printer.

Using EpsonNet Config

To turn on/off either the DHCP or the AutoIP protocol:

1. Launch your web browser.
2. Enter the IP address of the printer in the address bar, and then press the **Enter** key.

EpsonNet Config appear on your browser.

3. Select **Properties**.
4. Select **TCP/IP** from the **Protocol Settings** folder on the left navigation panel.
5. In the **IP Address Mode** field, select the **DHCP/AutoIP** or **DHCP** option.

6. Click the **Apply** button.
7. Click the **Reboot Machine** button.

Assigning an IP Address (for IPv4 Mode)

Note:

- ❑ When you assign an IP address manually in **IPv6** mode, use *EpsonNet Config*. To display *EpsonNet Config*, use the link local address. To check a link local address, see “Printing and Checking the System Settings Page” on page 48.
- ❑ Assigning an IP address is considered as an advanced function and is normally done by a system administrator.
- ❑ Depending on the address class, the range of the IP address assigned may be different. On Class A, for example, an IP address in the range from 0.0.0.0 to 127.255.255.255 will be assigned. For assignment of IP addresses, contact your system administrator.

You can assign the IP address by using the operator panel or the Printer Setting Utility.

Using the Operator Panel

1. Turn on the printer.
Ensure that the LCD panel shows `Select Function`.
2. On the operator panel, press the **System** button.
3. Select `Admin Menu`, and then press the **OK** button.
4. Select `Network`, and then press the **OK** button.
5. Select `TCP/IP`, and then press the **OK** button.
6. Select `IPv4`, and then press the **OK** button.
7. Select `Get IP Address`, and then press the **OK** button.
8. Select `Panel`, and then press the **OK** button.
9. Press the **Back** button, and then ensure that `Get IP Address` is selected.

10. Select `IP Address`, and then press the `OK` button.
11. Enter the value of the IP address using the numeric keypad.
12. Press the `▶` button.
13. Repeat steps 11 and 12 to enter all of the digits in the IP address, and then press the `OK` button.
14. Press the `⏪` (**Back**) button, and then ensure that `IP Address` is selected.
15. Select `Subnet Mask`, and then press the `OK` button.
16. Enter the value of the subnet mask using the numeric keypad.
17. Press the `▶` button.
18. Repeat steps 16 and 17 to set subnet mask, and then press the `OK` button.
19. Press the `⏪` (**Back**) button, and then ensure that `Subnet Mask` is selected.
20. Select `Gateway Address`, and then press the `OK` button.
21. Enter the value of the gateway address using the numeric keypad.
22. Press the `▶` button.
23. Repeat steps 21 and 22 to set gateway address, and then press the `OK` button.
24. Turn off and turn on the printer.

See Also:

“Operator Panel” on page 28

Using the Printer Setting Utility

The following procedure uses Windows 7 as an example.

Note:

When you use IPv6 mode for network printing, you cannot use the Printer Setting Utility to assign an IP address.

1. Click **Start** — **All Programs** — **EPSON** — your printer — **Printer Setting Utility**.

Note:

The window to select a printer appears in this step when multiple print drivers are installed on your computer. In this case, click the name of the desired printer listed in **Printer Name**.

The Printer Setting Utility starts.

2. Click the **Printer Maintenance** tab.
3. Select **TCP/IP Settings** from the list at the left side of the page.

The **TCP/IP Settings** page is displayed.

4. Select **Panel** from **IP Address Mode**, and then enter the values in **IP Address**, **Subnet Mask**, and **Gateway Address**.
5. Click the **Restart printer to apply new settings** button to take effect.

The IP address is assigned to your printer. To verify the setting, display the web browser on any computer connected to the network and enter the IP address into the address bar on the browser. If the IP address is set up correctly, EpsonNet Config appears on your browser.

You can also assign the IP address to the printer when installing the print drivers with installer. When you use the network installation feature, you can set the IP address from 0.0.0.0 to the desired IP address on the printer setting window.

Verifying the IP Settings

The following procedure uses Windows 7 as an example.

Note:

The reports and lists are all printed in English.

1. Print the System Settings page.
2. Look under the **IPv4** heading on the System Settings page to ensure that the IP address, subnet mask, and gateway address are appropriate.

To verify if the printer is active on the network, run the ping command in your computer:

1. Click **Start**, and select **Search programs and files**.

2. Enter **cmd**, and then press the **Enter** key.

A black window appears.

3. Enter **ping xx.xx.xx.xx** (where **xx.xx.xx.xx** is the IP address of your printer), and then press the **Enter** key.
4. Reply from the IP address denotes printer is active on the network.

See Also:

“Printing and Checking the System Settings Page” on page 48

Printing and Checking the System Settings Page

Print the System Settings page and check your printer's IP address.

Using the Operator Panel

Note:

The reports and lists are all printed in English.

1. Press the **System** button.
2. Select **Report / List**, and then press the **OK** button.
3. Select **System Settings**, and then press the **OK** button.

The System Settings page is printed.

4. Confirm the IP address next to **IP Address** under **Wired Network** (AL-MX200DNF) or **Wired Network/Wireless Network** (AL-MX200DWF) on the System Settings page. If the IP address is **0.0.0.0**, wait for a few minutes to resolve the IP address automatically, and then print the System Settings page again.

If the IP address is not resolved automatically, see “Assigning an IP Address (for IPv4 Mode)” on page 45.

Using the Printer Setting Utility

The following procedure uses Windows 7 as an example.

Note:

The reports and lists are all printed in English.

1. Click **Start — All Programs — EPSON — your printer — Printer Setting Utility**.

Note:

The window to select a printer appears in this step when multiple print drivers are installed on your computer. In this case, click the name of the desired printer listed in **Printer Name**.

The Printer Setting Utility starts.

2. Click the **Printer Settings Report** tab.
3. Select **Reports** from the list at the left side of the page.

The **Reports** page appears.

4. Click the **System Settings** button.

The System Settings page is printed.

If the IP address is **0.0.0.0** (the factory default) or **169.254.xx.xx**, an IP address has not been assigned.

See Also:

“Assigning an IP Address (for IPv4 Mode)” on page 45

Installing Print Drivers on Computers Running Windows

You can use three types of print drivers on your printer:

- PCL print driver

See “Using the PCL print driver” on page 50.

- PCL compatible Universal P6 print driver

See “Using Epson Universal P6 Printer Driver” on page 97.

- PostScript Level3 Compatible print driver

See *PostScript Level3 Compatible User's Guide*.

Using the PCL print driver

Identifying Print Driver Pre-install Status (for Network Connection Setup)

Before installing print drivers on your computer, print the System Settings page to check the IP address of your printer.

Using the Operator Panel

Note:

The reports and lists are all printed in English.

1. Press the **System** button.
2. Select **Report / List**, and then press the **OK** button.
3. Select **System Settings**, and then press the **OK** button.

The System Settings page is printed.

4. Find the IP address under **Wired Network** (AL-MX200DNF) or **Wired Network/Wireless Network** (AL-MX200DWF) on the System Settings page.

If the IP address is **0.0.0.0**, wait for a few minutes to resolve the IP address automatically, and then print the System Settings page again.

If the IP address is not resolved automatically, see “Assigning an IP Address (for IPv4 Mode)” on page 45.

Using the Printer Setting Utility

The following procedure uses Windows 7 as an example.

Note:

The reports and lists are all printed in English.

1. Click **Start** — **All Programs** — **EPSON** — your printer — **Printer Setting Utility**.

Note:

*The window to select a printer appears in this step when multiple print drivers are installed on your computer. In this case, click the name of the desired printer listed in **Printer Name**.*

The Printer Setting Utility starts.

2. Click the **Printer Settings Report** tab.
3. Select **TCP/IP Settings** from the list on the left side of the page.

The **TCP/IP Settings** page is displayed.

If the IP address shows **0.0.0.0** (the factory default) or **169.254.xx.xx**, an IP address has not been assigned. To assign one for your printer, see “Assigning an IP Address (for IPv4 Mode)” on page 45.

Disabling the Firewall Before Installing Printer Drivers

If you are running one of the following operating systems, you must disable the firewall before installing print drivers:

- Windows 7
- Windows Vista®
- Windows Server® 2008 R2
- Windows Server 2008
- Windows XP

The following procedure uses Windows 7 as an example.

1. Click **Start — Help and Support**.

Note:

*For Windows Vista, Windows Server 2008, Windows Server 2008 R2 and Windows 7 operating systems, if you use **Online Help**, switch to **Offline Help** on **Windows Help and Support** window.*

2. In the **Search Help** box, enter **firewall** and then press the **Enter** key.

In the list, click **Turn Windows Firewall on or off** and then follow the instructions on the screen.

Enable the firewall after the installation of the printer software is complete.

Inserting the Software Disc

1. Insert the Software Disc into your computer's CD/DVD drive. When the **AutoPlay** window appears, click **Run setup.exe** to start the **Easy Install Navi**.

Note:

If the CD does not automatically start or the **AutoPlay** window does not appear, click **Start (start for Windows XP)** — **Computer** — **D:\EPSetup.exe** (where D is the drive letter of your CD), and then click **OK**.

USB Connection Setup

The following procedure uses Windows 7 as an example.

1. Connect your computer and printer with a USB cable.
2. Turn on the printer.
3. Click **Easy Install**.

The **SOFTWARE LICENSE AGREEMENT** appears.

4. If you agree to the terms of the **SOFTWARE LICENSE AGREEMENT**, select **Agree** and then click **Next**.

Easy Install Navi launches.

5. Click **Installing Drivers and Software**.
6. Select **Personal Installation**, and then click **Next**.
7. Select whether to restart your computer and click **Finish** to exit the wizard.

USB Printing

A personal printer is a printer connected to your computer or a print server using a USB. If your printer is connected to a network and not to your computer, see “Network Connection Setup” on page 53.

Network Connection Setup

Note:

- ❑ To use your printer in a Linux environment, you need to install print drivers for the Linux operating systems. For details on how to install and use the drivers, see also “Installing Print Drivers on Computers Running Linux (CUPS)” on page 104.
- ❑ When using a CD drive in a Linux environment, you need to mount the drive to your system environment. The command strings are `mount/media/CD-ROM`.

The following procedure uses Windows 7 as an example.

1. Click **Easy Install**.

The **SOFTWARE LICENSE AGREEMENT** appears.

2. If you agree to the terms of the **SOFTWARE LICENSE AGREEMENT**, select **Agree** and then click **Next**.

Easy Install Navi launches.

3. Click **Installing Drivers and Software**.
4. Select **Network Installation**, and then click **Next**.
5. Select the printer you want to install from the printer list, and then click **Next**. If the target printer is not displayed on the list, click **Refresh** to refresh the list or click **Add Printer** to add a printer to the list manually. You may specify the IP address and port name at this point.

If you have installed this printer on the server computer, select **I am setting up this printer on a server** check box.

Note:

If the installer displays **0.0.0.0** when you intend to use the AutoIP feature, you must enter a valid IP address to continue.

6. Specify the printer settings, and then click **Next**.
 - a Enter the printer name.
 - b If you want other users on the network to access this printer, select **Share this printer with other computers on the network**, and then enter a share name that users can identify.

- c If you want to set a printer as the default for printing, select the **Set this printer as default for printing** check box.
 - d If you want to set a printer as the default for scanning, select the **Set this printer as default for scanning** check box.
 - e If you want to install the fax driver, select the **Install fax driver** check box.
7. Select the software and documentation you want to install, and then click **Install**. You can specify folders in which to install the software and documentation. To change the folders, click **Browse**.
 8. Click **Finish** to exit the wizard.

Configuring Wireless Network Settings (AL-MX200DWF only)

You can configure wireless network settings with the **Easy Install Navi**.

Important:

- Be sure to obtain the SSID and security information from a system administrator in advance when you use a communications standard other than WPS to configure wireless network settings.*
- Ensure that the Ethernet cable has been disconnected from the printer before you configure the wireless network settings.*

The wireless network specifications are described below:

Item	Specification
Connectivity	Wireless
Connectivity Standard	IEEE 802.11b/g compliant
Bandwidth	2.4 GHz
Data Transfer Rate	IEEE 802.11b mode: 11, 5.5, 2, 1 Mbps IEEE 802.11g mode: 54, 48, 36, 24, 18, 12, 9, 6 Mbps
Security	64 (40-bit key)/ 128 (104-bit key) WEP, WPA- PSK (TKIP, AES), WPA2-PSK (AES) (IEEE802.1x attestation function of WPA 1x non-corresponds)
Certifications	Wi-Fi, WPA2.0 (Personal)
Wi-Fi Protected Setup (WPS)	Push Button Configuration (PBC), Personal Identification Number (PIN), WPS2.0 supported

You can select a method to configure wireless network settings from the following:

Wizard Setup Through USB Connection	
Advanced Setup Through	Ethernet connection
	Operator Panel
	EpsonNet Config
	WPS-PIN* ¹
	WPS-PBC* ²

*¹ WPS-PIN (Wi-Fi® Protected Setup-Personal Identification Number) is a method to authenticate and register devices required for wireless configuration, by entering PIN code in the printer and computer. This setting, performed through access point, is available only when the access points of your wireless router supports WPS.

*² WPS-PBC (Wi-Fi Protected Setup-Push Button Configuration) is a method to authenticate and register devices required for wireless configuration, by pressing the button provided on the access point via wireless routers, and then performing WPS-PBC setting on the operator panel. This setting is available only when the access point supports WPS.

Using Wizard Setup to Configure Wireless Network Settings

The following procedure uses Windows 7 as an example.

1. Insert the Software Disc into your computer's CD/DVD drive. When the **AutoPlay** window appears, click **Run setup.exe** to start the **Install Navi**.
2. Click **Easy Install**.

The **SOFTWARE LICENSE AGREEMENT** appears.

3. If you agree to the terms of the **SOFTWARE LICENSE AGREEMENT**, select **Agree** and then click **Next**.

Easy Install Navi launches.

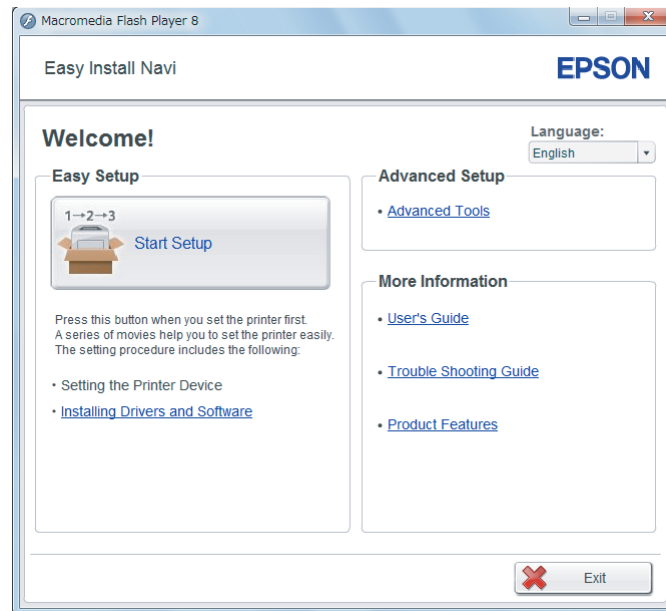

4. Click **Start Setup**.

5. Click **Configure Printer**.

The connection type selection screen appears.

6. Select **Wireless Connection**, and then click **Next**.

The setting method selection screen appears.

7. Ensure that **Wizard** is selected, and then click **Next**.

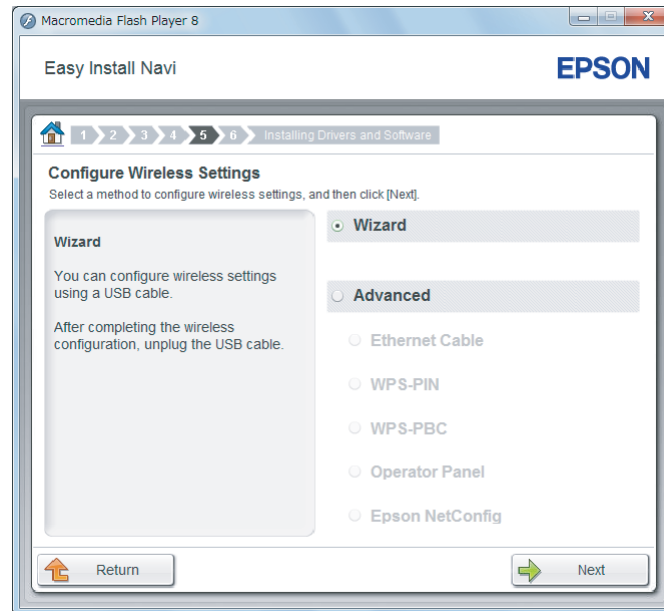

8. Follow the on-screen instructions to connect the USB cable and perform other setup until the **Select Access Point** screen appears.

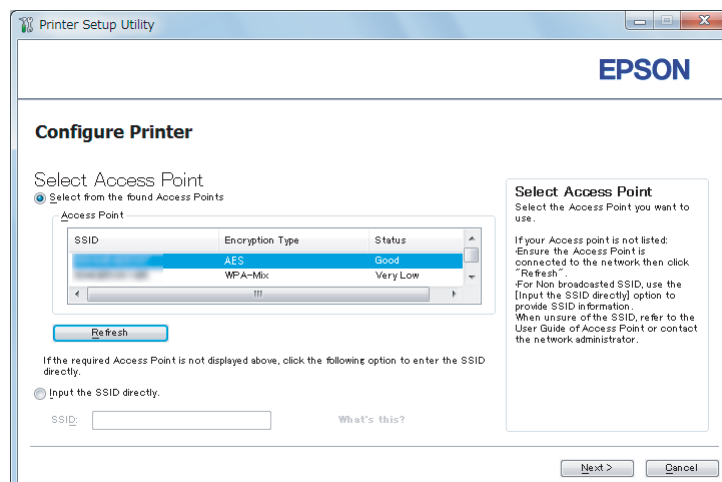

9. Select either of the following:

- Click the **Select from the found Access Points** radio button and select the SSID.
- Click the **Input the SSID directly** radio button and enter the SSID in the **SSID** box.

Note:

Up to five access points are displayed in order of intensity of radio waves. An access point with low-intensity radio waves may not be displayed.

10. Click **Next**.

11. Enter for **Passphrase** for the SSID you specified above and click **Next**.

The screenshot shows the 'Printer Setup Utility' window with the 'Configure Printer' section. Under 'Enter Passphrase', there is a 'SSID:' label and a text box containing 'Epson-Secure'. Below it is a 'Passphrase:' label and an empty text box. A 'Show input' checkbox is present. To the right, a 'Passphrase' information box explains that a passphrase is a 'key' for encryption and must be the same as the one set at the Access Point. At the bottom, there are '< Back', 'Next >', and 'Cancel' buttons.

12. Configure the security setting, and then click **Next**.

The **IP Address Settings** screen appears.

The screenshot shows the 'Printer Setup Utility' window with the 'Configure Printer' section. The 'IP Address Settings' section is active. It includes 'IP Mode' (set to IPv4), 'IPv4 Settings' (with 'Type' set to 'Use Manual Address'), and 'IPv6 Settings' (with 'Use Manual Address' checked). Each section has 'What's this?' links. To the right, an 'IP Address Settings' information box provides instructions for IPv4 (DHCP) and IPv6 (manual) settings. At the bottom, there are '< Back', 'Next >', and 'Cancel' buttons.

13. Select **IP Mode** depending on your network scheme.

When **IPv4** is selected, configure the following:

- a Select **Type**.
- b If you have selected **Use Manual Address** from **Type**, enter the following items:
 - IP Address** of your printer
 - Subnet Mask**
 - Gateway Address**

When **Dual Stack** is selected, configure the following:

- a Configure **IPv4 Settings**.
- b If you have selected the **Use Manual Address** check box under **IPv6 Settings**, enter the following items:
 - IP Address** of your printer
 - Gateway Address**

14. Click **Next**.

The **FAX Settings** screen appears.

The screenshot shows the 'Printer Setup Utility' window for an Epson printer. The main title is 'Configure Printer'. Under the 'FAX Settings' section, there is a checked checkbox labeled 'I don't use FAX functionality'. Below this, there are several configuration options, each with a dropdown menu and a 'What's this?' link:

- Region: United Kingdom
- Line Type: PSTN
- Dialing Type: Tone
- Ans Select: FAX Mode
- DRPD Pattern: Pattern4
- Company Name: (text input field)
- Your Fax Number: (text input field)

To the right of these settings is a help box titled 'FAX Settings' with the following text: 'Configure the FAX settings. The values of each item are retrieved from your printer. If you will not use FAX functionality, check the "I don't use FAX functionality" checkbox and click "Next".' At the bottom of the window are three buttons: '< Back', 'Next >', and 'Cancel'.

15. Configure the fax settings if necessary.

Note:

If you do not intend to use the fax feature, select the **I don't use FAX functionality** check box.

16. Click **Next**.

The **Confirm the settings** screen appears.

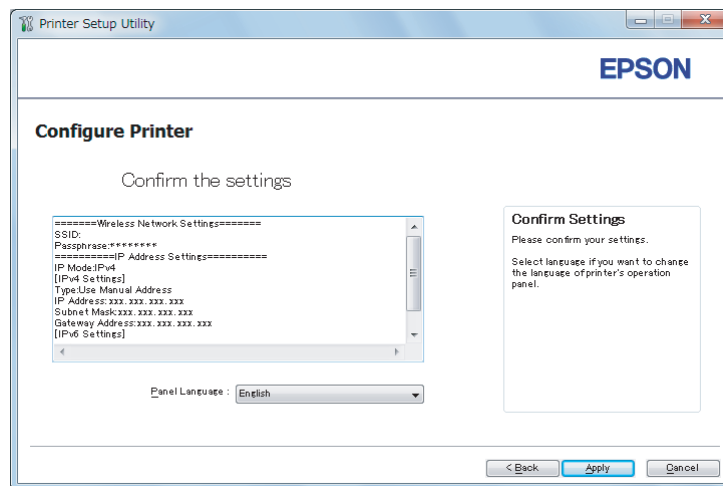

17. Ensure that the wireless network settings are displayed, and then click **Apply**.

A confirmation window appears.

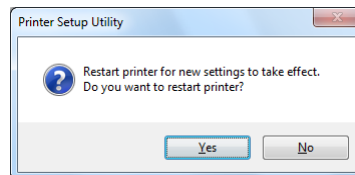

18. Click **Yes**.

19. Wait a few minutes until the printer restarts to establish a wireless network connection and the **Configuration Complete** screen appears.

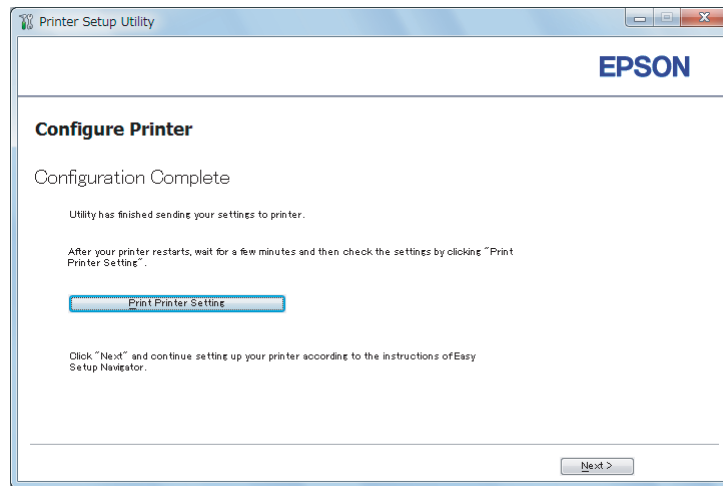

20. Click **Print Printer Setting**.
21. Confirm that "Link Quality" is shown as "Good", "Acceptable", or "Low" on the report.

Note:

When "Link Quality" is shown as "No Reception", check if the wireless network settings are correctly configured. To reconfigure the wireless network settings, click **Next** on the **Configuration Complete** screen and then click **Return**.

22. Click **Next**.

23. Follow the on-screen instructions until the **Check Setup** screen appears.

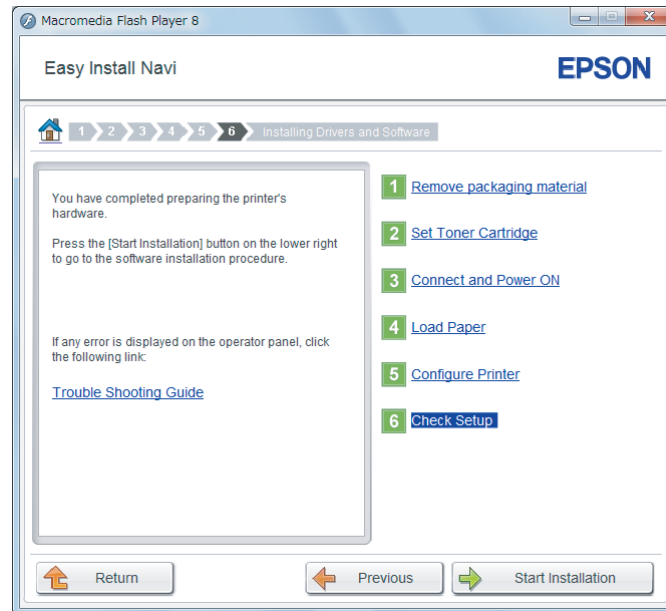

24. Confirm there are no errors displayed on the LCD panel, and then click **Start Installation**.

If you see any errors, click **Trouble Shooting Guide** and follow the instruction.

25. Check if the printer to be installed is listed in the **Select Printer** screen, and then click **Next**.

Note:

*If the printer to be installed is not listed in the **Select Printer** screen, try either of the following steps:*

- Click **Refresh** to update the information.
- Click **Add Printer**, and then enter the details of the printer manually.

26. Select the required items on the **Enter Printer Settings** screen, and then click **Next**.

27. Select the software to be installed, and then click **Install**.

28. Click **Finish** to exit this tool.

The wireless configuration is complete.

Using Advanced Setup to Configure Wireless Network Settings

To use the Advanced setup, display the **Configure Wireless Settings** screen.

The following procedure uses Windows 7 as an example.

Displaying the Configure Wireless Settings Screen

1. Insert the Software Disc into your computer's CD/DVD drive. When the **AutoPlay** window appears, click **Run setup.exe** to start the **Install Navi**.
2. Click **Easy Install**.

The **SOFTWARE LICENSE AGREEMENT** appears.

3. If you agree to the terms of the **SOFTWARE LICENSE AGREEMENT**, select **Agree** and then click **Next**.

Easy Install Navi launches.

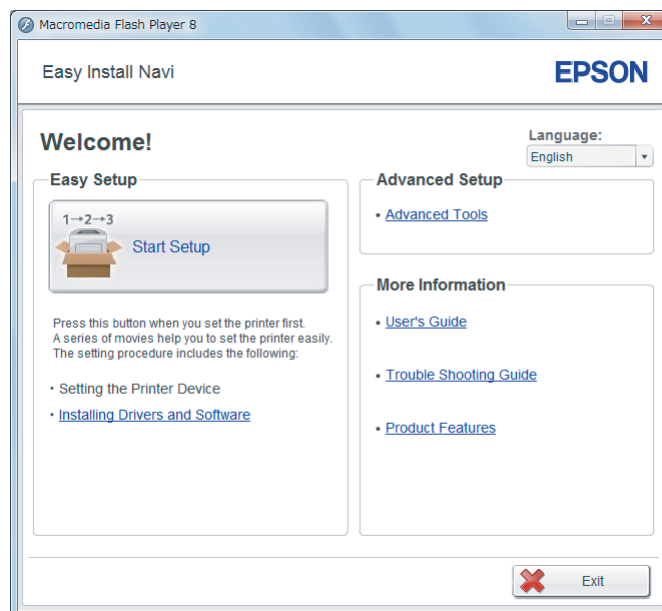

4. Click **Start Setup**.
5. Click **Configure Printer**.
6. Select **Wireless Connection**, and then click **Next**.

The setting method selection screen appears.

7. Select **Advanced**.

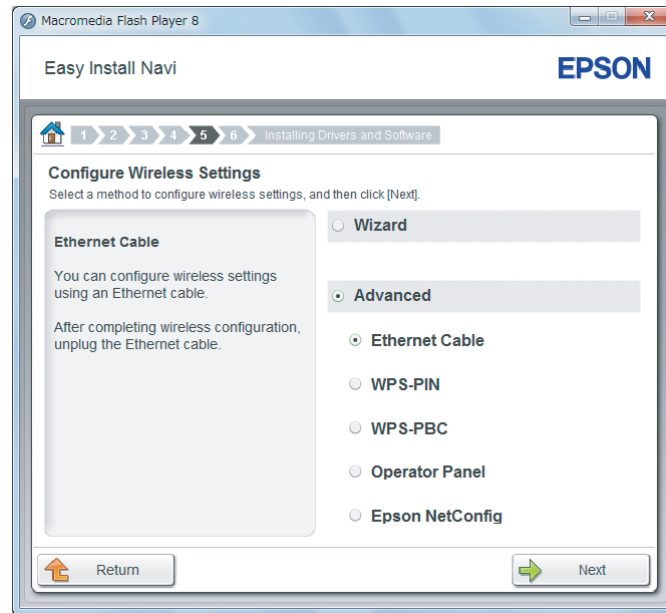

Select a connection method from the following

- “Ethernet Cable” on page 64
- “WPS-PIN” on page 69
- “WPS-PBC” on page 71
- “Operator Panel” on page 72
- “EpsonNet Config” on page 73

Ethernet Cable

1. Select **Ethernet Cable**, and then click **Next**.
2. Follow the on-screen instructions, and then click **Next**.

The **Printer Setup Utility** screen appears.

3. Select the printer to be configured in the **Select Printer** screen, and then click **Next**.

Note:

If the printer to be configured is not listed in the **Select Printer** screen, try either of the following steps:

- Click **Refresh** to update the information.
- Click **Enter IP Address**, and then enter the IP address of your printer.

4. Enter the SSID.

The screenshot shows the 'Configure Printer' window in the Epson Printer Setup Utility. The 'Wireless Network Settings' section is active. It includes fields for SSID, Type of wireless network (Infrastructure selected), Security Protocol (No Security selected), Index (1), and Password. A 'Show input' checkbox is also present. A 'What's this?' link is available for each field. A 'Wireless Settings' help box on the right explains that the SSID and wireless settings must match the network's settings. Navigation buttons '< Back', 'Next >', and 'Cancel' are at the bottom.

5. Select **Type of wireless network**.6. Configure the security setting, and then click **Next**.

The **IP Address Settings** screen appears.

The screenshot shows the 'Configure Printer' window in the Epson Printer Setup Utility. The 'IP Address Settings' section is active. It includes an 'IP Mode' dropdown (IPv4 selected), an 'IP Address Settings' section with 'Type' (Use Manual Address selected), and fields for IP Address, Subnet Mask, and Gateway Address. An 'IPv6 Settings' section is also visible with a 'Use Manual Address' checkbox and fields for IP Address and Gateway Address. 'What's this?' links are provided for several fields. A help box on the right explains DHCP for IPv4 and manual IP assignment for IPv6. Navigation buttons '< Back', 'Next >', and 'Cancel' are at the bottom.

7. Select **IP Mode** depending on your network scheme.

When **IPv4** is selected, configure the following:

- a Select **Type**.
- b If you have selected **Use Manual Address** from **Type**, enter the following items:
 - IP Address** of your printer
 - Subnet Mask**
 - Gateway Address**

When **Dual Stack** is selected, configure the following:

- a Configure **IPv4 Settings**.
 - b If you have selected the **Use Manual Address** check box under **IPv6 Settings**, enter the following items:
 - IP Address** of your printer
 - Gateway Address**
8. Click **Next**.

The **FAX Settings** screen appears.

The screenshot shows the 'Printer Setup Utility' window for an Epson printer. The main title is 'Configure Printer'. Under the 'FAX Settings' section, there is a checked checkbox labeled 'don't use FAX functionality'. Below this, there are several configuration options, each with a dropdown menu and a 'What's this?' link:

- Region: United Kingdom
- Line Type: PSTN
- Dialing Type: Tone
- Area Select: FAX Mode
- DRPD Pattern: Pattern4
- Company Name: (text input field)
- Your Fax Number: (text input field)

On the right side, there is a 'FAX Settings' help box with the following text: 'Configure the FAX settings. The values of each item are retrieved from your printer. If you will not use FAX functionality, check the "don't use FAX functionality" checkbox and click "Next".'

At the bottom of the window, there are three buttons: '< Back', 'Next >', and 'Cancel'.

- Configure the fax settings if necessary.

Note:

If you do not intend to use the fax feature, select the **I don't use FAX functionality** check box.

- Click **Next**.

The **Confirm the settings** screen appears.

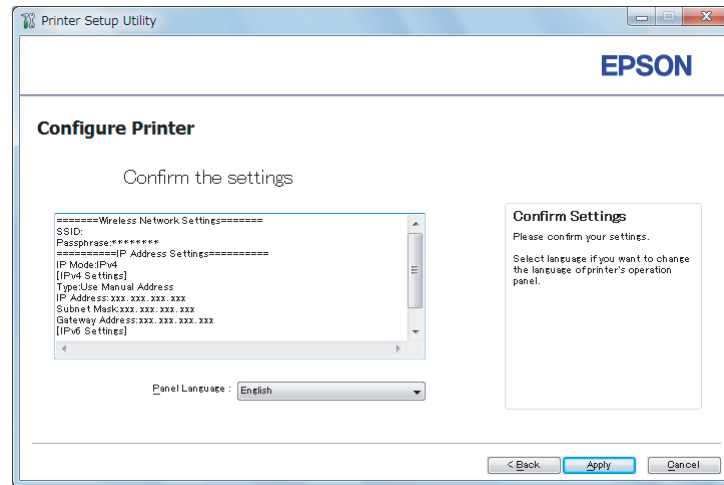

- Ensure that the wireless network settings are displayed, and then click **Apply**.

A confirmation window appears.

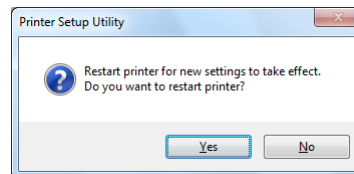

Note:

To make the specified wireless network settings effective, you need to restart the printer.

- Click **Yes**.

13. Wait a few minutes until the printer restarts to establish a wireless network connection and the **Configuration Complete** screen appears.

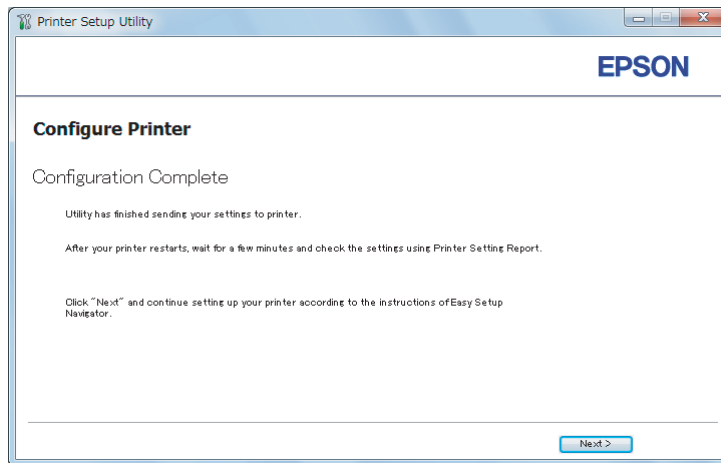

14. Click **Next**.

15. Follow the on-screen instructions until the **Check Setup** screen appears.



16. Print the System Settings page using the operator panel.

See "Printing the System Settings Page" on page 155.

17. Confirm that “Link Quality” is shown as “Good”, “Acceptable”, or “Low” on the report.

Note:

*When “Link Quality” is shown as “No Reception”, check if the wireless network settings are correctly configured. To reconfigure the wireless network settings, click **Return**.*

18. Confirm there are no errors displayed on the LCD panel, and then click **Start Installation**.

If you see any errors, click **Trouble Shooting Guide** and follow the instruction.

19. Check if the printer to be installed is listed in the **Select Printer** screen, and then click **Next**.

Note:

*If the printer to be installed is not listed in the **Select Printer** screen, try either of the following steps:*

- Click **Refresh** to update the information.
- Click **Add Printer**, and then enter the details of the printer manually.

20. Configure the required items on the **Enter Printer Settings** screen, and then click **Next**.

21. Select the software to be installed, and then click **Install**.

22. Click **Finish** to exit this tool.

The wireless configuration is complete.

WPS-PIN

Note:

- WPS-PIN** (Wi-Fi Protected Setup-Personal Identification Number) is a method to authenticate and register devices required for wireless configuration, by entering PIN code to a printer and computer. This setting, performed through access point, is available only when the access points of your wireless router supports WPS.
 - Before **WPS-PIN** starts, you will need to enter your PIN code at the web page of the wireless access point. See the access point manual for the details.
1. Select **WPS-PIN**, and then click **Next**.

2. Follow the on-screen instructions until the **Check Setup** screen appears.

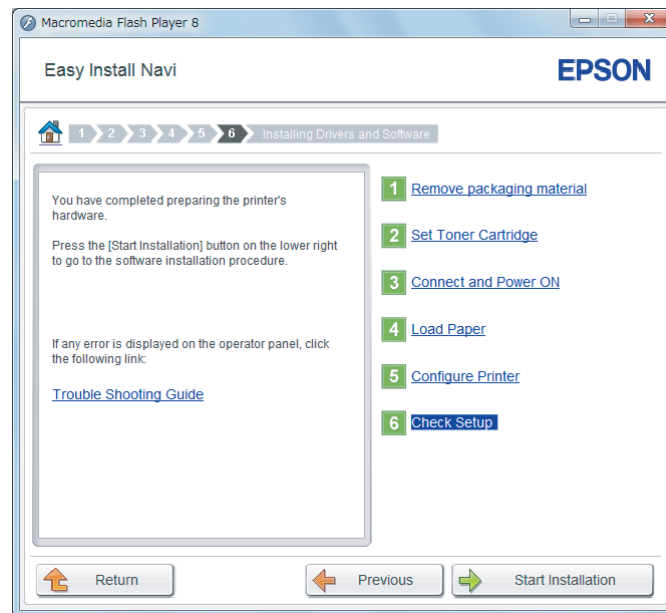

3. Confirm there are no errors displayed on the LCD panel, and then click **Start Installation**.
If you see any errors, click **Trouble Shooting Guide** and follow the instruction.
4. Check if the printer to be installed is listed in the **Select Printer** screen, and then click **Next**.

Note:

If the printer to be installed is not listed in the **Select Printer** screen, try either of the following steps:

- Click **Refresh** to update the information.
 - Click **Add Printer**, and then enter the details of the printer manually.
5. Configure the required items on the **Enter Printer Settings** screen, and then click **Next**.
 6. Select the software to be installed, and then click **Install**.
 7. Click **Finish** to exit this tool.

The wireless configuration is complete.

When the **WPS-PIN** operation is successful and the printer is rebooted, wireless LAN connection is completed.

WPS-PBC

Note:

WPS-PBC (Wi-Fi Protected Setup-Push Button Configuration) is a method to authenticate and register devices required for wireless configuration, by pressing the button provided on the access point via wireless routers, and then performing **WPS-PBC** setting on the operator panel. This setting is available only when the access point supports WPS.

1. Select **WPS-PBC**, and then click **Next**.
2. Follow the on-screen instructions until the **Check Setup** screen appears.



3. Confirm there are no errors displayed on the LCD panel, and then click **Start Installation**.
If you see any errors, click **Trouble Shooting Guide** and follow the instruction.
4. Check if the printer to be installed is listed in the **Select Printer** screen, and then click **Next**.

Note:

If the printer to be installed is not listed in the **Select Printer** screen, try either of the following steps:

- Click **Refresh** to update the information.
- Click **Add Printer**, and then enter the details of the printer manually.

5. Configure the required items on the **Enter Printer Settings** screen, and then click **Next**.
6. Select the software to be installed, and then click **Install**.
7. Click **Finish** to exit this tool.

The wireless configuration is complete.

Note:

For the **WPS-PBC** operation on the wireless LAN access point, refer to the manual supplied with the wireless LAN access point.

When the **WPS-PBC** operation is successful and the printer is rebooted, wireless LAN connection is completed.

Operator Panel

1. Select **Operator Panel**, and then click **Next**.
2. Follow the on-screen instructions until the **Check Setup** screen appears.

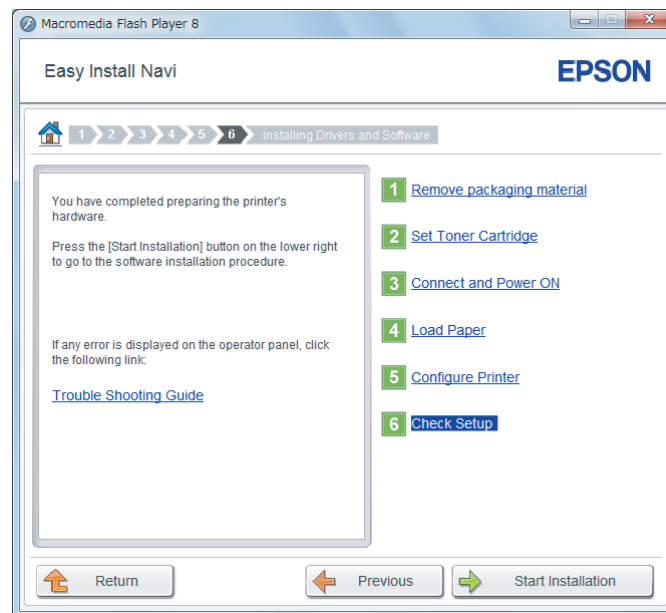

3. Confirm there are no errors displayed on the LCD panel, and then click **Start Installation**.

If you see any errors, click **Trouble Shooting Guide** and follow the instruction.

4. Check if the printer to be installed is listed in the **Select Printer** screen, and then click **Next**.

Note:

If the printer to be installed is not listed in the **Select Printer** screen, try either of the following steps:

- Click **Refresh** to update the information.
 - Click **Add Printer**, and then enter the details of the printer manually.
5. Configure the required items on the **Enter Printer Settings** screen, and then click **Next**.
 6. Select the software to be installed, and then click **Install**.
 7. Click **Finish** to exit this tool.

The wireless configuration is complete.

EpsonNet Config

1. Select **EpsonNet Config**, and then click **Next**.
2. Follow the on-screen instructions until the **Check Setup** screen appears.



3. Confirm there are no errors displayed on the LCD panel, and then click **Start Installation**.

If you see any errors, click **Trouble Shooting Guide** and follow the instruction.

4. Check if the printer to be installed is listed in the **Select Printer** screen, and then click **Next**.

Note:

*If the printer to be installed is not listed in the **Select Printer** screen, try either of the following steps:*

- Click **Refresh** to update the information.
 - Click **Add Printer**, and then enter the details of the printer manually.
5. Configure the required items on the **Enter Printer Settings** screen, and then click **Next**.
 6. Select the software to be installed, and then click **Install**.
 7. Click **Finish** to exit this tool.

The wireless configuration is complete.

When EpsonNet Config operation is successful and the printer is rebooted, wireless LAN connection is completed.

Setting Up a New Wireless Network Environment for Your Computer (When You Need to Set Up Your Wireless Connectivity With Your Computer)

For DHCP Networks:

1. Setting up your computer for wireless connectivity:

Note:

You can also change the wireless network settings using the wireless application that may be installed on your computer.

For Windows XP and Windows Server 2003:

- a Select **Network Connections** from **Control Panel**.
- b Right-click **Wireless Network Connection** and select **Properties**.
- c Select the **Wireless Networks** tab.

- d Ensure that the check box for **Use Windows to configure my wireless network settings** is selected.

Note:

Make note of the wireless network settings on the **Advanced** dialog box (step f) and the **Wireless network properties** dialog box (step h). You may require these settings later.

- e Click the **Advanced** button.
- f Select **Computer-to-computer (ad hoc) networks only** and close the **Advanced** dialog box.
- g Click the **Add** button to display **Wireless network properties**.
- h On the **Association** tab, enter the following information and click **OK**.

Network name (SSID): xxxxxxxx (xxxxxxx indicates a wireless device's SSID which you use)

Network Authentication: Open

Data encryption: Disabled

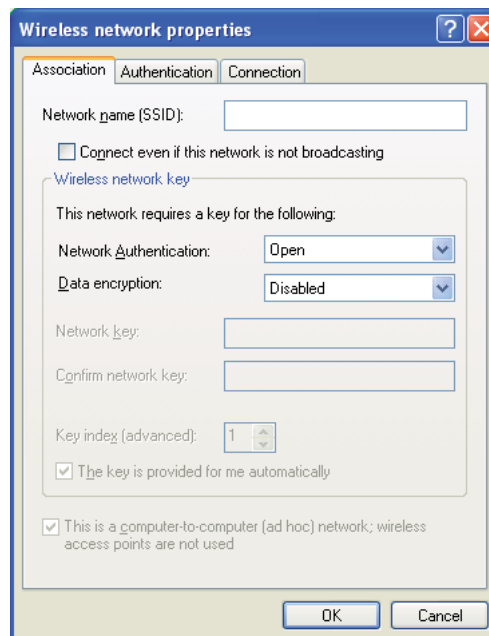

- i Click the **Move up** button to move the newly added SSID to the top of the list.
- j Click **OK** to close the **Wireless network properties** dialog box.

For Windows Vista:





- a Display **Control Panel**.
- b Select **Network and Internet**.
- c Select **Network and Sharing Center**.
- d Select **Connect to a network**.
- e Select **xxxxxxxx** (xxxxxxxx indicates a wireless device's SSID which you use) from the network items listed in the available network list, and click **Connect**.
- f Click **Close** in the dialog box after confirming the connection is a success.

For Windows Server 2008:

- a Display **Control Panel**.
- b Select **Network and Internet**.
- c Select **Network and Sharing Center**.
- d Select **Connect to a network**.
- e Select **xxxxxxxx** (xxxxxxxx indicates a wireless device's SSID which you use) from the network items listed in the available network list, and click **Connect**.
- f Click **Close** in the dialog box after confirming the connection is a success.

For Windows Server 2008 R2 and Windows 7:

- a Display **Control Panel**.
- b Select **Network and Internet**.

- c Select **Network and Sharing Center**.
 - d Select **Connect to a network**.
 - e Select **xxxxxxxx** (xxxxxxxx indicates a wireless device's SSID which you use) from the network items listed in the available network list, and click **Connect**.
2. Check the IP address assigned by AutoIP on the printer.
- a On the operator panel, press the **System** button.
 - b Select Admin Menu, and then press the  button.
 - c Select Network, and then press the  button.
 - d Select TCP/IP, and then press the  button.
 - e Select IPv4, and then press the  button.
 - f Select IP Address, and then press the  button.
- (Default IP address range: 169.254.xxx.yyy)

IP Address 169.254.000.041*

3. Ensure that the IP Address on your computer is assigned by DHCP.

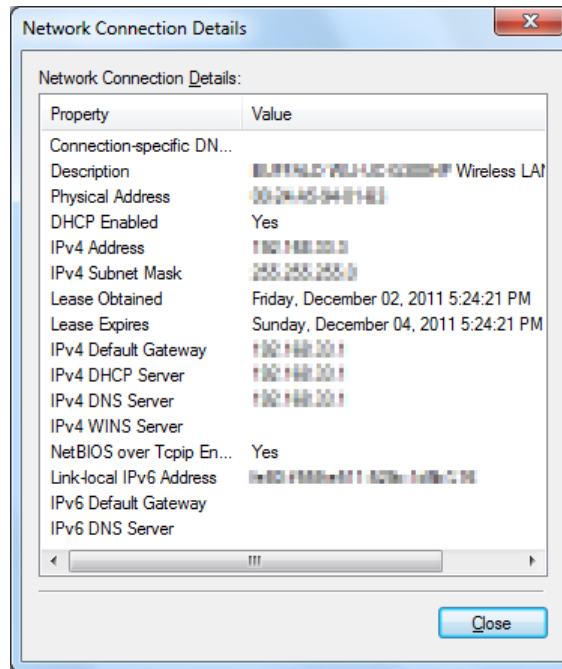

4. Launch your web browser.
5. Enter the IP address of the printer in the address bar, and then press the **Enter** key.

EpsonNet Config appears on your browser.

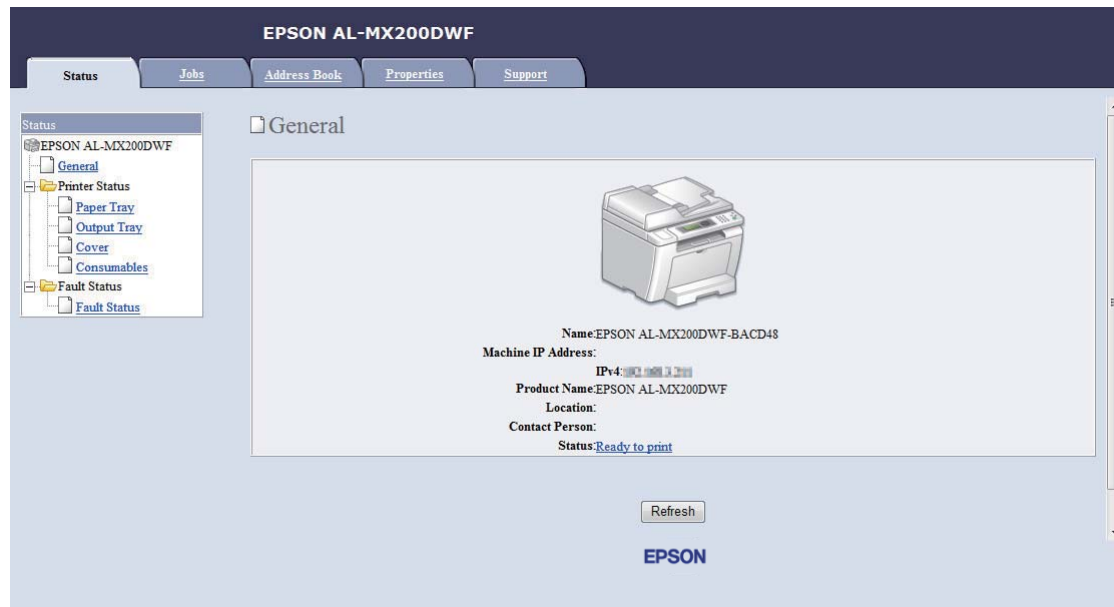

6. Configure wireless network settings for the printer on EpsonNet Config.
7. Reboot the printer.
8. Restore the wireless network settings on your computer.

Note:

If the operating system on your computer provides a wireless configuration software, use it to change the wireless network settings. See the instructions below.

For Windows XP and Windows Server 2003:

- a Select **Network Connections** from **Control Panel**.
- b Right-click **Wireless Network Connection** and select **Properties**.
- c Select the **Wireless Networks** tab.
- d Ensure that the check box for **Use Windows to configure my wireless network settings** is selected.
- e Click **Advanced**.

- f You can either set the printer to the ad-hoc mode or the infrastructure mode.
 - For Ad hoc mode:
Select **Computer-to-computer (ad hoc) networks only** and close the dialog box.
 - For Infrastructure mode:
Select **Access point (Infrastructure) networks only** and close the dialog box.
- g Click **Add** to display **Wireless network properties**.
- h Enter the setting that you will send to the printer and click **OK**.
- i Click **Move up** to move the setting to the top of the list.
- j Click **OK** to close the **Wireless network properties** dialog box.

For Windows Vista:

- a Display **Control Panel**.
- b Select **Network and Internet**.
- c Select **Network and Sharing Center**.
- d Select **Connect to a network**.
- e Select the network, and then click **Connect**.
- f Click **Close** in the dialog box after confirming the connection is a success.

For Windows Server 2008:

- a Display **Control Panel**.
- b Select **Network and Internet**.
- c Select **Network and Sharing Center**.
- d Select **Connect to a network**.
- e Select the network, and then click **Connect**.

- f Click **Close** in the dialog box after confirming the connection is a success.

For Windows Server 2008 R2 and Windows 7:

- a Display **Control Panel**.
- b Select **Network and Internet**.
- c Select **Network and Sharing Center**.
- d Select **Connect to a network**.
- e Select the network, and then click **Connect**.

For Fixed IP Networks:

1. Set up your computer for wireless connectivity:

Note:

If the operating system on your computer provides a wireless configuration software, use it to change the wireless network settings. See the instructions below.

For Windows XP and Windows Server 2003:

- a Select **Network Connections** from **Control Panel**.
- b Right-click **Wireless Network Connection** and select **Properties**.
- c Select the **Wireless Networks** tab.
- d Ensure that the check box for **Use Windows to configure my wireless network settings** is selected.

Note:

Be sure to write down the current wireless computer settings in step f and step h so that you can restore them later.

- e Click the **Advanced** button.

- f Select **Computer-to-computer (ad hoc) networks only** and close the **Advanced** dialog box.
- g Click the **Add** button to display **Wireless network properties**.
- h On the **Association** tab, enter the following information and click **OK**.

Network name (SSID): xxxxxxxx (xxxxxxx indicates a wireless device's SSID which you use)

Network Authentication: Open

Data encryption: Disabled

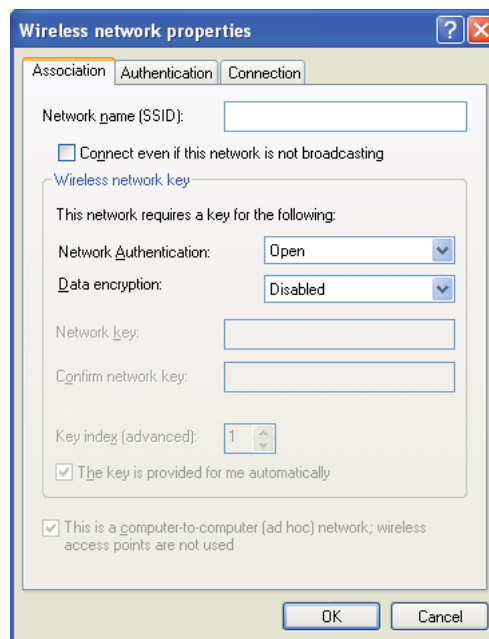

- i Click the **Move up** button to move the newly added SSID to the top of the list.
- j Click **OK** to close the **Wireless network properties** dialog box.

For Windows Vista:

- a Display **Control Panel**.

- b Select **Network and Internet**.
- c Select **Network and Sharing Center**.
- d Select **Connect to a network**.
- e Select **xxxxxxxx** (xxxxxxxx indicates a wireless device's SSID which you use) from the network items listed in the available network list, and click **Connect**.
- f Click **Close** in the dialog box after confirming the connection is a success.

For Windows Server 2008:

- a Display **Control Panel**.
- b Select **Network and Internet**.
- c Select **Network and Sharing Center**.
- d Select **Connect to a network**.
- e Select **xxxxxxxx** (xxxxxxxx indicates a wireless device's SSID which you use) from the network items listed in the available network list, and click **Connect**.
- f Click **Close** in the dialog box after confirming the connection is a success.

For Windows Server 2008 R2 and Windows 7:

- a Display **Control Panel**.
- b Select **Network and Internet**.
- c Select **Network and Sharing Center**.
- d Select **Connect to a network**.
- e Select **xxxxxxxx** (xxxxxxxx indicates a wireless device's SSID which you use) from the network items listed in the available network list, and click **Connect**.

2. Check the IP address on your computer.

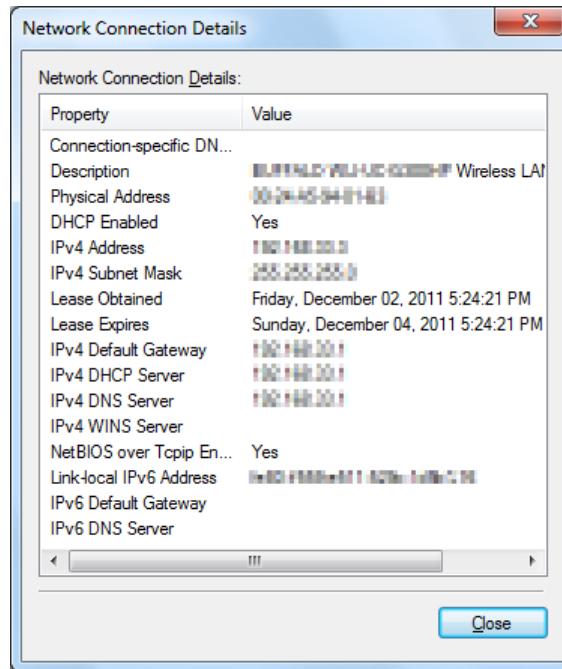

3. Set the IP address on the printer.

See “Assigning an IP Address (for IPv4 Mode)” on page 45.

4. Launch your web browser.
5. Enter the IP address of the printer in the address bar, and then press the **Enter** key.

EpsonNet Config appears on your browser.



6. Change the wireless network settings for the printer on EpsonNet Config.
7. Reboot the printer.
8. Restore the wireless network settings on your computer.

Note:

If the operating system on your computer provides a wireless configuration software, use it to change the wireless network settings. Or you can change the wireless network settings using the tool provided with the operating system. See the instructions below.

For Windows XP and Windows Server 2003:

- a Select **Network Connections** from **Control Panel**.
- b Right-click **Wireless Network Connection** and select **Properties**.
- c Select the **Wireless Networks** tab.
- d Ensure that the check box for **Use Windows to configure my wireless network settings** is selected.
- e Click **Advanced**.

- f You can either set the printer to the ad-hoc mode or the infrastructure mode.
 - For Ad hoc mode:
Select **Computer-to-computer (ad hoc) networks only** and close the dialog box.
 - For Infrastructure mode:
Select **Access point (Infrastructure) networks only** and close the dialog box.
- g Click **Add** to display **Wireless network properties**.
- h Enter the setting that you will send to the printer and click **OK**.
- i Click **Move up** to move the setting to the top of the list.
- j Click **OK** to close the **Wireless network properties** dialog box.

For Windows Vista:

- a Display **Control Panel**.
- b Select **Network and Internet**.
- c Select **Network and Sharing Center**.
- d Select **Connect to a network**.
- e Select the network, and then click **Connect**.
- f Click **Close** in the dialog box after confirming the connection is a success.

For Windows Server 2008:

- a Display **Control Panel**.
- b Select **Network and Internet**.
- c Select **Network and Sharing Center**.
- d Select **Connect to a network**.
- e Select the network, and then click **Connect**.

- f Click **Close** in the dialog box after confirming the connection is a success.

For Windows Server 2008 R2 and Windows 7:

- a Display **Control Panel**.
- b Select **Network and Internet**.
- c Select **Network and Sharing Center**.
- d Select **Connect to a network**.
- e Select the network, and then click **Connect**.

Setting Up the Printer for Shared Printing

One way to make a new printer available for other computers on a network is to use the Software Disc supplied with your printer. Using the supplied CD is helpful in a way that it will install utilities including Status Monitor as well. The following, however, describes the procedures for sharing a printer on a network without using the supplied CD.

To set up a printer to be shared on a network, you need to set up the printer for network sharing and install print drivers for the printer on every computer on the network.

Note:

You need to purchase an additional Ethernet cable at your own cost to connect a printer to an Ethernet network.

Setting Up the Printer for Network Sharing

For Windows XP, Windows XP 64-bit Edition, Windows Server 2003, and Windows Server 2003 x64 Edition

1. Click **Start** (**start** for Windows XP) — **Printers and Faxes**.
2. Right-click the icon for your printer and select **Properties**.
3. From the **Sharing** tab, select **Share this printer**, and then enter a name in the **Share name** text box.
4. Click **Additional Drivers** and select the operating systems of all network clients using your printer.

5. Click **OK**.

If the files are not present in your computer, and then you will be prompted to insert the server operating system CD.

6. Click **Apply**, and then click **OK**.

For Windows Vista and Windows Vista 64-bit Edition

1. Click **Start — Control Panel — Hardware and Sound — Printers**.
2. Right-click the printer icon and select **Sharing**.
3. Click **Change sharing options** button.
4. The “**Windows needs your permission to continue**” appears.
5. Click **Continue** button.
6. Select the **Share this printer** check box, and then enter a name in the **Share name** text box.
7. Select **Additional Drivers** and select the operating systems of all network clients using your printer.
8. Click **OK**.
9. Click **Apply**, and then click **OK**.

For Windows Server 2008 and Windows Server 2008 64-bit Edition

1. Click **Start — Control Panel — Hardware and Sound — Printers**.
2. Right-click the printer icon and select **Sharing**.
3. Select the **Share this printer** check box, and then enter a name in the **Share name** text box.
4. Click **Additional Drivers** and select the operating systems of all network clients using your printer.
5. Click **OK**.
6. Click **Apply**, and then click **OK**.

For Windows 7, Windows 7 64-bit Edition, and Windows Server 2008 R2

1. Click **Start** — **Devices and Printers**.
2. Right-click the printer icon and select **Printer properties**.
3. On the **Sharing** tab, select the **Share this printer** check box, and then enter a name in the **Share name** text box.
4. Click **Additional Drivers** and select the operating systems of all network clients using your printer.
5. Click **OK**.
6. Click **Apply**, and then click **OK**.

To check that the printer is shared:

- Ensure that the printer object in the **Printers, Printers and Faxes** or **Devices and Printers** folder is shared. The share icon is shown under the printer icon.
- Browse **Network** or **My Network Places**. Find the host name of the server and look for the shared name you assigned to the printer.

Installing Print Drivers

Now that the printer is set for shared printing, you need to install print drivers for the shared printer using either of the two Windows features.

Using the Point and Print Feature

The Point and Print feature is a Windows technology that automatically downloads and installs a print driver necessary for using the shared printer on the network.

For Windows XP, Windows XP 64-bit Edition, Windows Server 2003, and Windows Server 2003 x64 Edition

1. On the Windows desktop of the client computer, double-click **My Network Places**.
2. Locate the host name of the server computer, and then double-click the host name.

3. Right-click the shared printer name, and then click **Connect**.

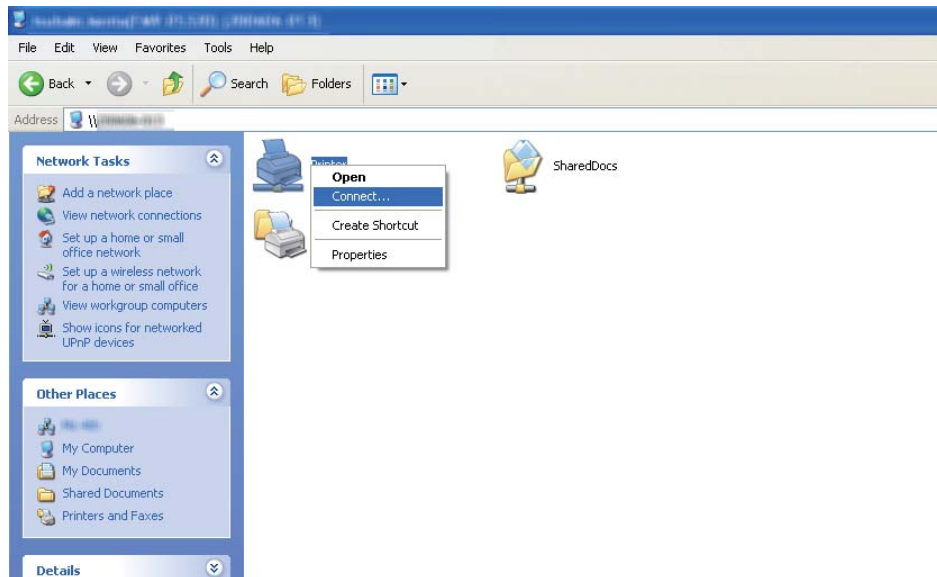

Wait until the driver is copied from the server to the client computer and a new printer object is added to the **Printers and Faxes** folder. It may take some time depending on the amount of network traffic.

Close **My Network Places**.

4. Print a test page to verify installation.
 - a Click **start** (**Start** for Windows Server 2003/Windows Server 2003 x64 Edition) — **Printers and Faxes**.
 - b Select the printer you have installed.
 - c Click **File** — **Properties**.
 - d On the **General** tab, click **Print Test Page**.

When a test page is printed successfully, installation is complete.

For Windows Vista and Windows Vista 64-bit Edition

1. Click **Start** — **Network**.

2. Locate and double-click the host name of the server computer.
3. Right-click the shared printer name, and then click **Connect**.
4. Click **Install driver**.
5. Click **Continue** in the **User Account Control** dialog box.

Wait until the driver is copied from the server to the client computer and a new printer object is added to the **Printers** folder. It may take some time depending on the amount of network traffic.

6. Print a test page to verify installation.
 - a. Click **Start — Control Panel — Hardware and Sound**.
 - b. Select **Printers**.
 - c. Right-click the printer you just created and select **Properties**.
 - d. On the **General** tab, click **Print Test Page**.

When a test page is printed successfully, installation is complete.

For Windows Server 2008 and Windows Server 2008 64-bit Edition

1. Click **Start — Network**.
2. Locate the host name of the server computer, and then double-click the host name.
3. Right-click the shared printer name, and then click **Connect**.
4. Click **Install driver**.
5. Wait until the driver is copied from the server to the client computer and a new printer object will be added to the **Printers** folder. It may take some time depending on the amount of network traffic.
6. Print a test page to verify installation.
 - a. Click **Start — Control Panel**.

- b Select **Hardware and Sound**.
- c Select **Printers**.
- d Right-click the printer you just created and select **Properties**.
- e On the **General** tab, click **Print Test Page**.

When a test page is printed successfully, installation is complete.

For Windows 7, Windows 7 64-bit Edition, and Windows Server 2008 R2

1. Click **Start — Computer — Network**.
2. Locate the host name of the server computer, and then double-click the host name.
3. Right-click the shared printer name, and then click **Connect**.

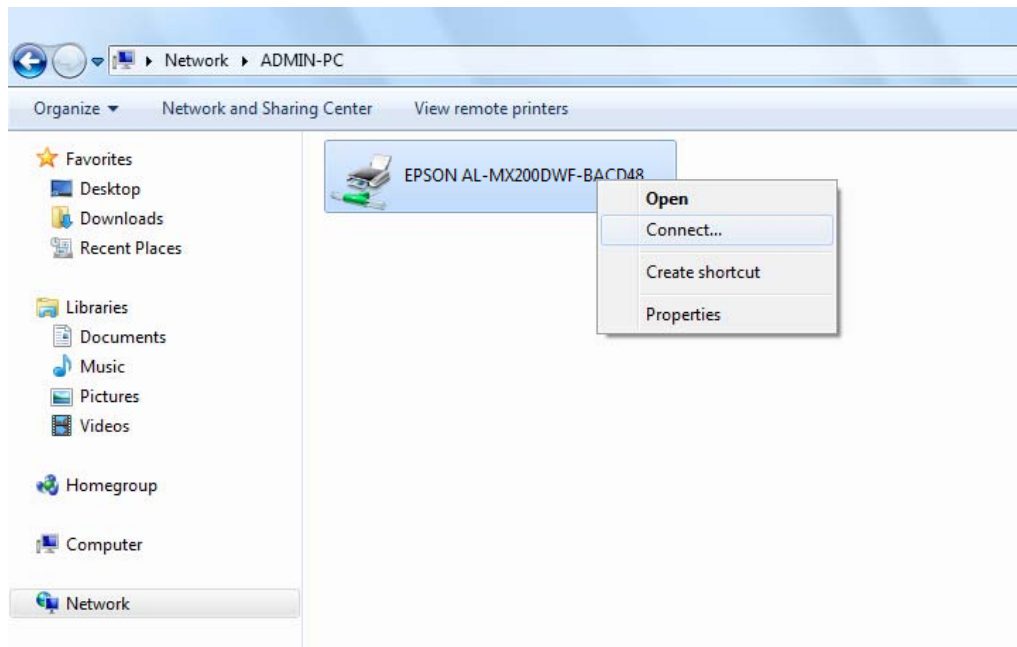

4. Click **Install driver**.
5. Wait until the driver is copied from the server to the client computer and a new printer object will be added to the **Devices and Printers** folder. It may take some time depending on the amount of network traffic.

6. Print a test page to verify installation.
 - a Click **Start — Devices and Printers**.
 - b Right-click the printer you just created and select **Printer properties**.
 - c On the **General** tab, click **Print Test Page**.

When a test page is printed successfully, installation is complete.

Using the Peer-to-Peer Feature

With the peer-to-peer feature, you need to specify the shared printer to install a print driver.

For Windows XP, Windows XP 64-bit Edition, Windows Server 2003, and Windows Server 2003 x64 Edition

1. Click **start** (**Start** for Windows Server 2003/Windows Server 2003 x64 Edition) — **Printers and Faxes**.
2. Click **Add a printer** (**Add Printer** for Windows Server 2003/Windows Server 2003 x64 Edition) to launch the **Add Printer Wizard**.
3. Click **Next**.
4. Select **A network printer, or a printer attached to another computer**, and then click **Next**.
5. Click **Browse for a printer**, and then click **Next**.

6. Select the printer, and then click **Next**. If the printer is not listed, click **Back** and enter the path to the printer in the text box.

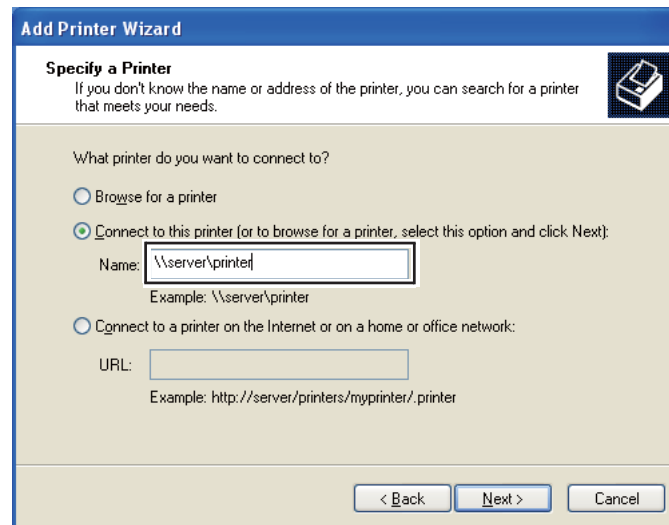

For example: \\[server host name]\\[shared printer name]

The server host name is the name of the server computer that identifies it to the network. The shared printer name is the name assigned during the server installation process.

If this is a new printer, you may be prompted to install a print driver. If no system driver is available, specify the location where the driver is available.

7. Select **Yes** if you want your printer to be set as the default printer, and then click **Next**.
8. Click **Finish**.

For Windows Vista and Windows Vista 64-bit Edition

1. Click **Start** — **Control Panel** — **Hardware and Sound** — **Printers**.
2. Click **Add a printer** to launch the **Add Printer** wizard.

3. Select **Add a network, wireless or Bluetooth printer**. If the printer is listed, select the printer and click **Next**, or select **The printer that I want isn't listed** and enter the path to the printer in the **Select a shared printer by name** text box and click **Next**.

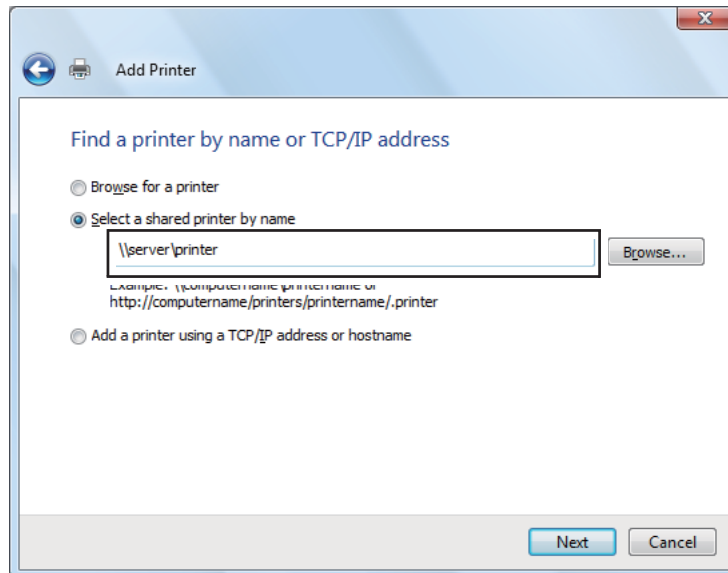

For example: \\[server host name]\\[shared printer name]

The server host name is the name of the server computer that identifies it on the network. The shared printer name is the name assigned during the server installation process.

If this is a new printer, you may be prompted to install a print driver. If no system driver is available, specify the location where the driver is available.

4. Confirm the printer name, and then select whether to use your printer as the default printer and click **Next**.
5. If you want to verify installation, click **Print a test page**.
6. Click **Finish**.

When a test page is printed successfully, installation is complete.

For Windows Server 2008 and Windows Server 2008 64-bit Edition

1. Click **Start — Control Panel — Hardware and Sound — Printers**.
2. Click **Add a printer** to launch the **Add Printer** wizard.

3. Select **Add a network, wireless or Bluetooth printer**. If the printer is listed, select the printer and click **Next**, or select **The printer that I want isn't listed** and enter the path to the printer in the **Select a shared printer by name** text box and click **Next**.

For example: \\[server host name]\[shared printer name]

The server host name is the name of the server computer that identifies it on the network. The shared printer name is the name assigned during the server installation process.

If this is a new printer, you may be prompted to install a print driver. If no system driver is available, specify the location where the driver is available.

4. Confirm the printer name, and then select whether to use your printer as the default printer and click **Next**.
5. Select whether to share your printer or not.
6. If you want to verify installation, click **Print a test page**.
7. Click **Finish**.

When a test page is printed successfully, installation is complete.

For Windows 7, Windows 7 64-bit Edition, and Windows Server 2008 R2

1. Click **Start — Devices and Printers**.
2. Click **Add a printer** to launch the **Add Printer** wizard.

3. Select **Add a network, wireless or Bluetooth printer**. If the printer is listed, select the printer and click **Next**, or select **The printer that I want isn't listed**. Click **Select a shared printer by name** and enter the path to the printer in the text box, and then click **Next**.

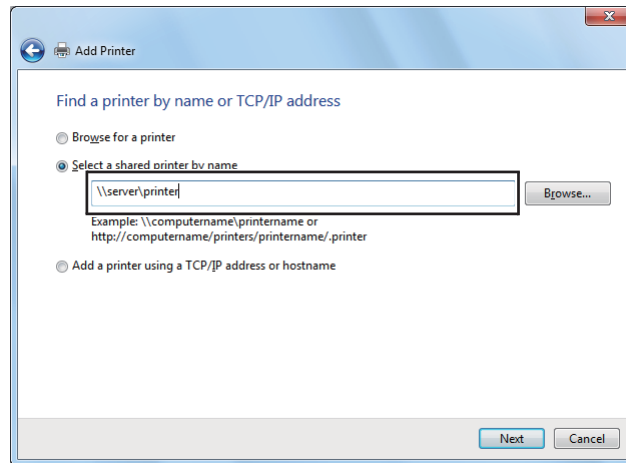

For example: \\[server host name]\\[shared printer name]

The server host name is the name of the server computer that identifies it to the network. The shared printer name is the name assigned during the server installation process.

If this is a new printer, you may be prompted to install a print driver. If no system driver is available, you need to specify the path to the available drivers.

4. Confirm the printer name, and then click **Next**.
5. Select whether to use your printer as the default printer.
6. If you want to verify installation, click **Print a test page**.
7. Click **Finish**.

When a test page is printed successfully, installation is complete.

Using Epson Universal P6 Printer Driver

Epson Universal P6 Printer Driver is the universal PCL6 compatible print driver that has the following features:

- ❑ It supports the basic print functions needed for the business situation.

- ❑ It supports multiple Epson business printers besides this printer.
- ❑ It supports most languages among the print drivers for this printer.

Computer system requirements

If your CD/DVD drive is D:, open **Epson_Universal_P6_Supplement.txt** in the **D:\Drivers\PCL_Universal**, and refer to Supported OS.

Your computer must be running one of the supported Microsoft Windows versions listed there, and must meet the system requirements of its operating system.

Supported Printers

If your CD/DVD drive is D:, open **Epson_Universal_P6_Supplement.txt** in the **D:\Drivers\PCL_Universal**, and refer to Supported Printers.

Supported Languages

If your CD/DVD drive is D:, open **Epson_Universal_P6_Supplement.txt** in the **D:\Drivers\PCL_Universal**, and refer to Supported Languages.

Installing the Printer Driver

1. Insert the printer Software Disc into your CD/DVD drive.
2. If your CD/DVD drive is D:, double-click **setup.exe** in the **D:\Drivers\PCL_Universal\Win32** for 32-bit Windows OS or **D:\Drivers\PCL_Universal\Win64** for 64-bit Windows OS.

Note:

Change the drive letter as needed for your system.

Follow the on-screen instructions.

After the installation is done, access your printer's **Properties** to customize the settings and **Printing Preferences** to make the appropriate printer driver settings.

Note:

The printer driver's online help provides details on printer driver settings.

Uninstalling the printer driver

Note:

The procedure below uses Windows 7 as an example.

1. Close all applications.
2. Access **Programs and Features** on the Control Panel.
3. Select **Epson Universal Laser P6**, and then click **Uninstall/Change**.

Follow the on screen instructions.

Installing Print Drivers on Computers Running Mac OS X

For information on how to install print drivers, refer to the *PostScript Level3 Compatible User's Guide*.

Configuring Wireless Settings on the Operator Panel (AL-MX200DWF only)

You can configure wireless settings on the operator panel.

Important:

- The Wireless LAN feature is unavailable depending on the region you purchased.*
- Be sure to get the SSID and security information from a system administrator in advance when you use other than WPS to configure wireless settings.*
- Ensure that the Ethernet cable has been disconnected from the printer before you configure the wireless settings.*

Note:

- Before you configure the wireless settings on the operator panel, you need to set up the wireless network settings on your computer. For details, see the *Wireless Network Setup Guide*.*
- For information on the specifications of the wireless LAN feature, see "Configuring Wireless Network Settings (AL-MX200DWF only)" on page 54.*

You can select a method to configure a wireless setting from the following:

Manual Setup For	Access Point (Infrastructure) Network
	Computer-to-computer (Ad-hoc) Network
Automatic Setup Using	WPS-PIN*1
	WPS-PBC*2

*1 WPS-PIN is a method to authenticate and register devices required for wireless configuration, by entering PIN code in the printer and computer. This setting, performed through access point, is available only when the access points of your wireless router supports WPS.





*2 WPS-PBC is a method to authenticate and register devices required for wireless configuration, by pressing the button provided on the access point via wireless routers, and then performing WPS-PBC setting on the operator panel. This setting is available only when the access point supports WPS.

Wi-Fi Setup



You can manually configure wireless settings to connect your printer to an access point (infrastructure) network or computer-to-computer (ad-hoc) network.



Connecting to Access Point Network

To configure the wireless settings through an access point such as a wireless router:

1. On the operator panel, press the **System** button.
2. Select `Admin Menu`, and then press the  button.
3. Select `Network`, and then press the  button.
4. Select `Wireless Setup`, and then press the  button.
5. Select the desired network name (SSID) of the computer, and then press the  button.

If the desired network name (SSID) of the computer does not appear:

- a Select `Manual Setup`, and then press the  button.
- b Enter the SSID, and then press the  button.

Use the numeric keypad to enter the desired value, and press the  or  button to move a cursor.

- c Select `Infrastructure`, and then press the  button.

- d Select an encryption type, and then press the **OK** button.

Important:

Be sure to use one of the supported encryption methods to protect your network traffic.

- 6. Enter the WEP key or pass phrase, and then press the **OK** button.

Use the numeric keypad to enter the desired value, and press the **◀** or **▶** button to move a cursor.

When the encryption type is WEP, select a transmit key after entering the WEP key.

- 7. Wait a few minutes until the printer restarts to establish the wireless network.

- 8. Print a System Settings page from the operator panel.

See "Printing and Checking the System Settings Page" on page 48.

- 9. Confirm that "Link Quality" is shown as "Good", "Acceptable" or "Low" on the report.

Note:

When "Link Quality" is "No Reception", check if the wireless settings are correctly configured.

Using Ad Hoc Connection

To configure the wireless settings for an ad-hoc connection where the wireless devices communicate directly with each other without an access point:

1. On the operator panel, press the **System** button.
2. Select **Admin Menu**, and then press the **OK** button.
3. Select **Network**, and then press the **OK** button.
4. Select **Wireless Setup**, and then press the **OK** button.
5. Select the desired access point, and then press the **OK** button.

If the desired access point does not appear:

- a Select **Manual Setup**, and then press the **OK** button.

- b Enter the SSID, and then press the **OK** button.

Use the numeric keypad to enter the desired value, and press the **◀** or **▶** button to move a cursor.

- c Select **Ad-hoc**, and then press the **OK** button.
- d Select an encryption type, and then press the **OK** button.

Important:

Be sure to use one of the supported encryption methods to protect your network traffic.

- 6. Enter the WEP key, and then press the **OK** button.

Use the numeric keypad to enter the desired value, and press the **◀** or **▶** button to move a cursor.

- 7. Select a transmit key.
- 8. Wait a few minutes until the printer restarts to establish the wireless network.
- 9. Print a System Settings page from the operator panel.

See "Printing and Checking the System Settings Page" on page 48.

- 10. Confirm that "Link Quality" is shown as "Good", "Acceptable" or "Low" on the report.

Note:

When "Link Quality" is "No Reception", check if the wireless settings are correctly configured.

Auto Setup With the Access Point





If the access point such as a wireless router supports the WPS, security settings can be made automatically.

WPS-PBC

Note:

WPS-PBC is a method to authenticate and register devices required for wireless configuration, by pressing the button provided on the access point via wireless routers, and then performing WPS-PBC setting on the operator panel. This setting is available only when the access point supports WPS.

- 1. On the operator panel, press the **System** button.

2. Select Admin Menu, and then press the  button.
3. Select Network, and then press the  button.
4. Select WPS Setup, and then press the  button.
5. Select Push Button Control, and then press the  button.
6. Select Yes, and then press the  button.
7. Press and hold the WPS button on the access point.
8. Wait a few minutes until the printer restarts to establish the wireless network.
9. Print a System Settings page from the operator panel.

See "Printing and Checking the System Settings Page" on page 48.





10. Confirm that "Link Quality" is shown as "Good", "Acceptable" or "Low" on the report.

Note:

When "Link Quality" is "No Reception", check if the wireless settings are correctly configured.

WPS-PIN

Note:

- WPS-PIN is a method to authenticate and register devices required for wireless configuration, by entering PIN code to a printer and computer. This setting, performed through access point, is available only when the access points of your wireless router supports WPS.*
 - Before WPS-PIN starts, you will need to enter your PIN code at the web page of the wireless access point. See the access point manual for the details.*
1. On the operator panel, press the **System** button.
 2. Select Admin Menu, and then press the  button.
 3. Select Network, and then press the  button.
 4. Select WPS Setup, and then press the  button.
 5. Select PIN Code, and then press the  button.

6. Take a note of PIN code displayed on the operator panel.
7. Select **Start Configuration**, and then press the **OK** button.
8. If SSID selection screen appears, select the SSID, and then press the **OK** button.
9. Enter the PIN code of the printer at the web page of the wireless access point.
10. Wait a few minutes until the printer restarts to establish the wireless network.
11. Print a System Settings page from the operator panel.

See "Printing and Checking the System Settings Page" on page 48.

12. Confirm that "Link Quality" is shown as "Good", "Acceptable" or "Low" on the report.

Note:

When "Link Quality" is "No Reception", check if the wireless settings are correctly configured.

Installing Print Drivers on Computers Running Linux (CUPS)

This section provides information on installing and setting up print drivers with CUPS (Common UNIX Printing System) on Red Hat Enterprise Linux® 6 Desktop (x86), SUSE® Linux Enterprise Desktop 11 (x86), and Ubuntu 10 (x86). For the information on the previous versions of the Linux operating systems, visit respective web sites.

Installing Print Drivers

Note:

The print driver **Epson-AL-MX200-x.x-y.noarch.rpm** or **epson-al-mx200_x.x-y_all.deb** is included in the **linux** folder on the Software Disc.

For Red Hat Enterprise Linux 6 Desktop (x86)

1. Double-click **Epson-AL-MX200-x.x-y.noarch.rpm** on the Software Disc.
2. Click **Install**.
3. Enter the administrator's password, and then click **Authenticate**.

Installation starts. When the installation is complete, the window automatically closes.

For SUSE Linux Enterprise Desktop 11 (x86)

1. Double-click **Epson-AL-MX200-x.x-y.noarch.rpm** on the Software Disc.
2. Click **Install**.
3. Enter the administrator's password, and then click **Authenticate**.

Installation starts. When the installation is complete, the window automatically closes.

For Ubuntu 10 (x86)

1. Double-click **epson-al-mx200_x.x-y_all.deb** on the Software Disc.
2. Click **Install Package**.
3. Enter the user password, and click **OK**.
4. Click **Close**.
5. Click the **X** button at the top-left of the dialog box to close the **Package Installer** dialog box.

Specifying the Queue

To perform printing, you must set up the print queue on your workstation.

Note:

When you have finished specifying the queue, you can then send print jobs from applications. Start a print job from an application, and specify the queue in the print dialog box. Depending on the application (Mozilla, for example), however, you may have to use the default queue for printing. In such a case, you must specify a queue you want to use as the default queue. For details on specifying the default queue, see "Specifying the Default Queue" on page 110.

For Red Hat Enterprise Linux 6 Desktop (x86)

1. Open the URL "http://localhost:631" using a web browser.
2. Click **Administration**.

3. Click **Add Printer**.
4. Enter root as the user name, and then enter the administrator password.
5. Click **OK**.
6. Select either of the following according to the type of your printer connection.

For a network printer:

- a Select **LPD/LPR Host or Printer** from the **Other Network Printers** menu, and then click **Continue**.
- b Enter the IP address of the printer in **Connection**.
Format: **lpd://xxx.xxx.xxx.xxx** (the IP address of the printer)
- c Click **Continue**.
- d Enter the name of the printer in **Name** in the **Add Printer** dialog box, and then click **Continue**.

You can optionally specify the location and description of the printer as additional information.

If you want to share the printer, select the **Share This Printer** check box.

For a USB printer connected to a computer running the Red Hat Enterprise Linux 6 Desktop (x86):

- a Select **EPSON AL-MX200 X (EPSON AL-MX200 X)** from the **Local Printers** menu, and then click **Continue**.
- b Enter the name of the printer in **Name** in the **Add Printer** dialog box, and then click **Continue**.

You can optionally specify the location and description of the printer as additional information.

If you want to share the printer, select the **Share This Printer** check box.

7. Select **Epson** from the **Make** menu, and then click **Continue**.
8. Select **Epson AL-MX200 xxx PS3 vX.Y (en)** from the **Model** menu, and then click **Add Printer**.

The setup is complete.

You can optionally specify the default options settings of the printer.

For SUSE Linux Enterprise Desktop 11 (x86)

1. Select **Computer — More Applications...**, and then select **YaST** on the **Application Browser**.
2. Enter the administrator password.

YaST Control Center is activated.

3. Select **Hardware** on **YaST Control Center**, and then select **Printer**.

The **Printer Configurations** dialog box appears.

4. Select either of the following according to the type of your printer connection.

For a network printer:

- a Click **Add**.

The **Add New Printer Configuration** dialog box appears.

- b Click **Connection Wizard**.

The **Connection Wizard** dialog box appears.

- c Select **Line Printer Daemon (LPD) Protocol** from **Access Network Printer or Printserver Box via**.
- d Enter the IP address of the printer in **IP Address or Host Name:**.
- e Select **Epson** in **Select the printer manufacturer:**.

- f Click **OK**.

The **Add New Printer Configuration** dialog box appears.

- g Select **Epson AL-MX200XX PS3 vX.Y [EPSON/Epson AL-MX200XX PS3.PPD.gz]** from the **Assign Driver** list.

Note:

*You can specify the printer name in **Set Name:***

For a USB printer connected to a computer running the SUSE Linux Enterprise Desktop 11:

- a Click **Add**.

The **Add New Printer Configuration** dialog box appears.

The printer name is displayed in the **Determine Connection** list.

- b Select **Epson AL-MX200XX PS3 vX.Y [EPSON/Epson AL-MX200XX PS3.PPD.gz]** from the **Assign Driver** list.

Note:

*You can specify the printer name in **Set Name:***

5. Confirm the settings, and then click **OK**.

For Ubuntu 10 (x86)

1. Open the URL "http://localhost:631" using a web browser.
2. Click **Administration**.
3. Click **Add Printer**.
4. Enter the **User Name** and the **Password**, and then click **OK**.
5. Select either of the following according to the type of your printer connection.

For a network printer:

- a Select **EPSON AL-MX200 X (XX:XX:XX) (SEIKO EPSON CORPORATION EPSON AL-MX200 X)** from **Discovered Network Printer**.
- b Click **Continue**.
- c Enter the name of the printer in **Name** in the **Add Printer** dialog box, and then click **Continue**.

You can optionally specify the location and description of the printer as additional information.

If you want to share the printer, select the **Share This Printer** check box.

For a USB printer connected to a computer running the Ubuntu 10 (x86):

- a Select **EPSON AL-MX200 X (EPSON AL-MX200 X)** from the **Local Printers** menu, and then click **Continue**.
- b Enter the name of the printer in **Name** in the **Add Printer** dialog box, and then click **Continue**.

You can optionally specify the location and description of the printer as additional information.

If you want to share the printer, select the **Share This Printer** check box.

6. Select **Epson** from the **Make** menu, and then click **Continue**.
7. Select **Epson AL-MX200 xxx PS3 vX.Y (en)** from the **Model** menu, and then click **Add Printer**.

The setup is complete.

You can optionally specify the default options settings of the printer.

Specifying the Default Queue

For Red Hat Enterprise Linux 6 Desktop (x86)

1. Select **Applications** — **System Tools** — **Terminal**.
2. Enter the following command in the terminal window.

```
su  
(Enter the administrator password)  
lpadmin -d (Enter the queue name)
```

For SUSE Linux Enterprise Desktop 11 (x86)

1. Select **Computer** — **More Applications...**, and then select **YaST** on the **Application Browser**.
2. Enter the administrator password.

YaST Control Center is activated.

3. Select **Printer** from **Hardware**.

The **Printer Configurations** dialog box appears.

4. Select the specified queue name you want to modify in the **Show** list.
5. Click **Edit**.

A dialog box to modify the specified queue appears.

6. Confirm that the printer you want to specify as the default queue is selected in the **Connection** list.
7. Select the **Default Printer** check box.
8. Confirm the settings, and then click **OK**.

For Ubuntu 10 (x86)

1. Select **System** — **Administration** — **Printing**.

2. Select the printer you want to specify as the default queue.
3. Select the **Printer** menu.
4. Select **Set As Default**.
5. Select whether to set this printer as the system-wide default printer, and then click **OK**.

Specifying Printing Options

You can specify printing options such as the duplex (2-sided) printing.

For Red Hat Enterprise Linux 6 Desktop (x86)

1. Open the URL “http://localhost:631” using a web browser.
2. Click **Administration**.
3. Click **Manage Printers**.
4. Click the queue name for which you want to specify printing options.
5. Click the **Administration** drop down box, and then select **Modify Printer**.
6. Specify necessary printing options, and then click **Continue** or **Modify Printer**.

The message **Printer EPSON AL-MX200 X has been modified successfully**. appears.

The setting is complete.

For SUSE Linux Enterprise Desktop 11 (x86)

1. Open a web browser.
2. Enter “http://localhost:631/admin” in the address bar, and then press the **Enter** key.

The **CUPS** window appears.

Note:

Set the password for authority as the printer administrator before setting the printer queue. If you have not set it, see “Setting the Password for Authority as the Printer Administrator” on page 113.

3. Click **Manage Printers**.
4. Click **Modify Printer** on the printer.
5. Specify necessary printing options, and then click **Continue**.
6. Enter root as the user name, enter the administrator password, and then click **OK**.

The message **Printer EPSON AL-MX200 X has been modified successfully.** appears.

The setting is complete.

For Ubuntu 10 (x86)

1. Open the URL “http://localhost:631” using a web browser.
2. Click **Administration**.
3. Click **Manage Printers**.
4. Click the queue name for which you want to specify printing options.
5. Click the **Administration** drop down box, and then select **Modify Printer**.
6. Enter the **User Name** and the **Password**, and then click **OK**.
7. Select the printer you want to modify.
8. Specify necessary printing options, and then click **Continue** or **Modify Printer**.

The message **Printer EPSON AL-MX200 X has been modified successfully.** appears.

The setting is complete.

Setting the Password for Authority as the Printer Administrator

For SUSE Linux Enterprise Desktop 10 and 11, you must set the password for authority as the printer administrator to do operations as the printer administrator.

For SUSE Linux Enterprise Desktop 11 (x86)

1. Select **Computer — More Applications...** and select **GNOME Terminal** on the **Application Browser**.
2. Enter the following command in the terminal window.

```
su
lppasswd -g sys -a root
(Enter the password for authority as the printer administrator after
the Enter password prompt.)
(Reenter the password for authority as the printer administrator
after the Enter password again prompt.)
```

Uninstalling Print Drivers

For Red Hat Enterprise Linux 6 Desktop (x86)

1. Select **Applications — System Tools — Terminal**.
2. Enter the following command in the terminal window to delete the print queue.

```
su
(Enter the administrator password)
lpadm -x (Enter the print queue name)
```

3. Repeat the command above for all queues for the same model.
4. Enter the following command in the terminal window.

```
rpm -e Epson-AL-MX200-x.x-y.noarch
```

The print driver is uninstalled.

For SUSE Linux Enterprise Desktop 11 (x86)

1. Select **Computer — More Applications...** and select **GNOME Terminal** on the **Application Browser**.
2. Enter the following command in the terminal window to delete the print queue.

```
su  
lpadmin -x (Enter the print queue name)
```

3. Repeat the command above for all queues for the same model.
4. Enter the following command in the terminal window.

```
rpm -e EPSON-AL-MX200-x.x
```

The print driver is uninstalled.

For Ubuntu 10 (x86)

1. Select **Applications — Accessories — Terminal**.
2. Enter the following command in the terminal window to delete the print queue.

```
sudo lpadmin -x (Enter the print queue name)  
(Enter the user password)
```

3. Repeat the command above for all queues for the same model.
4. Enter the following command in the terminal window.

```
sudo dpkg -r epson-al-mx200  
(Enter the user password if required)
```

The print driver is uninstalled.

Chapter 5

Printing Basics

About Print Media

Using paper that is not appropriate for the printer can cause paper jams, image quality problems, or printer failures. To achieve the best performance from your printer, we recommend you use only the paper described in this section.

When using paper other than that recommended, contact our local representative office or authorized dealer.

Print Media Usage Guidelines

The paper tray accommodates various sizes and types of paper and other specialty media. Follow these guidelines when loading paper and media:

- Before buying large quantities of any print media, it is recommended that you try a sample first.
- For 60 to 135 gsm (16 to 36 lb bond) paper, grain long, where the paper fibers run along the length of the paper, is recommended. For paper heavier than 135 gsm (36 lb bond), grain short, where the paper fibers run along the width of the paper, is preferred.
- Envelopes can be printed from the paper tray and the Priority Sheet Inserter (PSI).
- Fan paper or other specialty media before loading in the paper tray.
- Do not print on label stock once a label has been removed from a sheet.
- Use only paper envelopes. Do not use envelopes with windows, metal clasps, or adhesives with release strips.
- Print all envelopes single-sided only.
- Some wrinkling and embossing may occur when printing envelopes.
- When loading print media in the paper tray, do not load it above the fill line on the paper width guides of the paper tray.
- Slide the paper width guides to adjust to the paper size.
- If excessive jams or wrinkles occur, use paper or other media from a new package.

**Warning:**

Do not use conductive paper such as origami paper, carbonic paper or conductively-coated paper. When paper jam occurs, it may cause short-circuit and eventually a fire accident.

See Also:

- “Loading Print Media in the Paper Tray” on page 123
- “Loading Print Media in the Priority Sheet Inserter (PSI)” on page 132
- “Loading Envelopes in the Paper Tray” on page 128
- “Loading Envelopes in the Priority Sheet Inserter (PSI)” on page 134
- “Printing on Custom Size Paper” on page 153

Automatic Document Feeder (ADF) Guidelines

The ADF can accommodate the paper of the following sizes:

- Width: 148–215.9 mm (5.83–8.50 inches)
- Length: 210–355.6 mm (8.27–14.00 inches)

The supported paper weight ranges from 60 to 105 gsm.

Follow the guidelines below when loading source documents into the ADF:





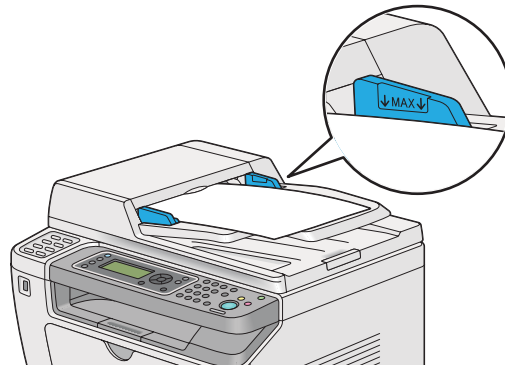

- Load documents face up so that the top of the document enters the printer first.
- Place only loose sheets of paper in the ADF.
- Adjust the document guides so that they fit against the documents.
- Insert paper in the document feeder tray only when the ink on the paper is completely dry.

- ❑ Do not load documents above the MAX fill line. You can load up to 50 sheets of 64 gsm documents.



Note:

You cannot load the following documents on the ADF. Be sure to place them on the document glass.

 Curled documents	 Pre-punched paper
 Lightweight documents	 Folded, creased or torn documents
 Cut and paste documents	 Carbon paper

Print Media That Can Damage Your Printer

Your printer is designed to use a variety of media types for print jobs. However, some media can cause poor output quality, excessive paper jams, or damage to your printer.

Unacceptable media includes:

- ❑ Paper that is too heavyweight or too lightweight (less than 60 gsm or more than 190 gsm)
- ❑ Transparencies
- ❑ Photo paper or coated paper
- ❑ Tracing paper
- ❑ Illumination film
- ❑ Special ink jet printer paper and ink jet transparencies
- ❑ Static-cling paper

- Pasted-up or glued paper
- Specially coated paper
- Color paper with surface treatments
- Paper that uses ink that deteriorates with heat
- Photosensitive paper
- Carbon paper or carbonless copy paper
- Paper with a rough surface, such as Japanese paper, pulp paper or fibrous paper
- Envelopes that are not flat, or that have clasps, windows or adhesives with release strips
- Padded envelopes
- Tack film
- Water transfer paper
- Textile transfer paper
- Perforated paper
- Leather paper, embossed paper
- Conductive paper such as origami paper, carbonic paper or conductively-coated paper
- Wrinkled, creased, folded, or ripped paper
- Damp or wet paper
- Wavy or curled paper
- Paper with staples, clips, ribbons, or tape
- Label paper with some labels already peeled off, or that are partially cut off
- Paper pre-printed by another printer or copy machine
- Paper pre-printed all over rear side

**Warning:**

Do not use conductive paper such as origami paper, carbonic paper or conductively-coated paper. When paper jam occurs, it may cause short-circuit and eventually a fire accident.

Print Media Storage Guidelines

Providing good storage conditions for your paper and other media contributes to optimum print quality.

- ❑ Store print media in dark, cool, relatively dry locations. Most paper items are susceptible to damage from ultraviolet (UV) and visible light. UV radiation, which is emitted by the sun and fluorescent bulbs, is particularly damaging to paper items. The intensity and length of exposure to visible light on paper items should be reduced as much as possible.
- ❑ Maintain constant temperatures and relative humidity.
- ❑ Avoid attics, kitchens, garages, and basements for storing print media.
- ❑ Store print media flat. Print media should be stored on pallets, cartons, shelves, or in cabinets.
- ❑ Avoid having food or drinks in the area where print media is stored or handled.
- ❑ Do not open sealed packages of paper until you are ready to load them into the printer. Leave paper in the original packaging. For most commercial cut-size grades, the ream wrapper contains an inner lining that protects the paper from moisture loss or gain.
- ❑ Leave the media inside the bag until you are ready to use it; reinsert unused media in the bag and reseal it for protection. Some specialty media is packaged inside resealable plastic bags.

Supported Print Media

Using unsuitable print media may lead to paper jams, poor print quality, breakdown and damage to your printer. To use the features of your printer effectively, use the suggested print media that is recommended here.

Important:

The toner may come off the print media, if it gets wet by water, rain, steam and so on. For more information, contact our local representative office or authorized dealer.

Usable Print Media

The types of print media that can be used on your printer are as follows:

Paper Tray

Paper Size	<p>A4 SEF (210 × 297 mm)</p> <p>B5 SEF (182 × 257 mm)</p> <p>A5 SEF (148 × 210 mm)</p> <p>Letter SEF (8.5 × 11 inches)</p> <p>Executive SEF (7.25 × 10.5 inches)</p> <p>Legal 13 (Folio) SEF (8.5 × 13 inches)</p> <p>Legal 14 SEF (8.5 × 14 inches)</p> <p>Statement SEF (139.7 × 215.9 mm)</p> <p>Com-10 Envelope SEF (4.125 × 9.5 inches)</p> <p>Monarch Envelope SEF (3.875 × 7.5 inches)</p> <p>Monarch Envelope LEF (7.5 × 3.875 inches)*</p> <p>DL Envelope SEF (110 × 220 mm)</p> <p>DL Envelope LEF (220 × 110 mm)*</p> <p>C5 Envelope SEF (162 × 229 mm)</p> <p>Postcard (100 × 148 mm)</p> <p>Postcard (148 × 200 mm)</p> <p>Yougata 2 Envelope SEF (114 × 162 mm)</p> <p>Yougata 2 Envelope LEF (162 × 114 mm)*</p> <p>Yougata 3 Envelope SEF (98 × 148 mm)</p> <p>Yougata 3 Envelope LEF (148 × 98 mm)*</p> <p>Yougata 4 Envelope SEF (105 × 235 mm)</p> <p>Yougata 6 Envelope SEF (98 × 190 mm)</p> <p>Younaga 3 Envelope SEF (120 × 235 mm)</p> <p>Nagagata 3 Envelope SEF (120 × 235 mm)</p> <p>Nagagata 4 Envelope SEF (90 × 205 mm)</p> <p>Kakugata 3 Envelope SEF (216 × 277 mm)</p> <p>Custom size:</p> <p>Width: 76.2 - 215.9 mm (3 - 8.5 inches)</p> <p>Length: 127 - 355.6 mm (5 - 14 inches)</p>
------------	--

Paper Type	Plain (60 - 105 gsm) Lightweight Cardstock (106 - 163 gsm) Labels Envelope Recycled Postcard JPN
Loading Capacity	250 sheets of standard paper

* You can load Monarch, DL, Yougata 2, and Yougata 3 envelopes in the LEF orientation into the paper tray with the flap unfolded.

Priority Sheet Inserter (PSI)

Paper Size	A4 SEF (210 × 297 mm) B5 SEF (182 × 257 mm) A5 SEF (148 × 210 mm) Letter SEF (8.5 × 11 inches) Executive SEF (7.25 × 10.5 inches) Legal 13 (Folio) SEF (8.5 × 13 inches) Legal 14 SEF (8.5 × 14 inches) Statement SEF (139.7 × 215.9 mm) Com-10 Envelope SEF (4.125 × 9.5 inches) DL Envelope SEF (110 × 220 mm) C5 Envelope SEF (162 × 229 mm) Yougata 4 Envelope SEF (105 × 235 mm) Younaga 3 Envelope SEF (120 × 235 mm) Nagagata 3 Envelope SEF (120 × 235 mm) Kakugata 3 Envelope SEF (216 × 277 mm) Custom size: Width: 76.2 - 215.9 mm (3 - 8.5 inches) Length: 210 - 355.6 mm (8.2 - 14 inches)
------------	--

Paper Type	Plain (60 - 105 gsm) Lightweight Cardstock (106 - 163 gsm) Labels Envelope Recycled
Loading Capacity	10 sheets of plain paper/one sheet of lightweight cardstock paper

Note:

- SEF and LEF indicate the paper feed orientation; SEF stands for short-edge feed. LEF stands for long-edge feed.*
- Use only laser print media. Do not use ink jet paper on your printer.*

See Also:

- “Loading Print Media in the Paper Tray” on page 123*
- “Loading Print Media in the Priority Sheet Inserter (PSI)” on page 132*
- “Loading Envelopes in the Paper Tray” on page 128*
- “Loading Envelopes in the Priority Sheet Inserter (PSI)” on page 134*

Printing on print media that differs from the paper size or paper type selected on the print driver may lead to paper jams. To ensure that printing is correctly done, select the correct paper size and paper type.

Loading Print Media

Loading print media properly helps prevent jams and ensures trouble-free printing.

Before loading print media, identify the recommended print side of the print media. This information is usually on the print media package.

Note:

After loading paper in the paper tray or the Priority Sheet Inserter (PSI), specify the same paper type on the operator panel.

Capacity

The paper tray can accommodate:

- 250 sheets of standard paper
- 27.5 mm (1.08 inches) of thick paper
- 27.5 mm (1.08 inches) of postcards
- Ten envelopes
- Twenty labels

The Priority Sheet Inserter (PSI) can accommodate:

- 10 sheets of plain paper or one sheet of lightweight cardstock paper

Print Media Dimensions

The paper tray can accommodate print media within the following dimensions:

- Width: 76.2 - 215.9 mm (3.00 - 8.50 inches)
- Length: 127.0 - 355.6 mm (5.00 - 14.00 inches)

The Priority Sheet Inserter (PSI) can accommodate print media within the following dimensions:

- Width: 76.2 - 215.9 mm (3.00 - 8.50 inches)
- Length: 210.0 - 355.6 mm (8.20 - 14.00 inches)

Loading Print Media in the Paper Tray

Note:

- When you are printing on any print media that is smaller than the A5 size paper, be sure to load it in the paper tray.*
- To avoid paper jams, do not remove the paper tray while printing is in progress.*
- Use only laser print media. Do not use ink jet paper on your printer.*

- ❑ For manually loading print media for duplex (2-sided) printing, see “Manual Duplex Printing (PCL Print Driver Only)” on page 141.
- ❑ Do not wipe the pink-tinted grease off as doing so may cause paper to misfeed.

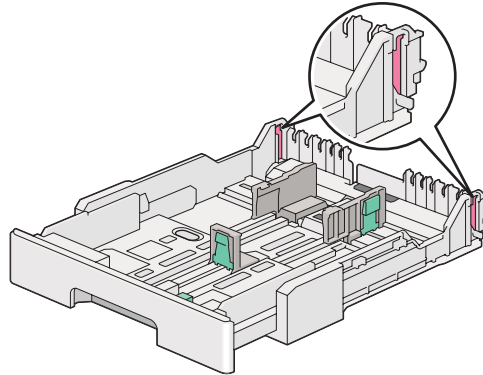

1. Pull the paper tray out of the printer about 200 mm. Hold the tray with both hands, remove it from the printer, and then remove the paper tray cover from the paper tray.

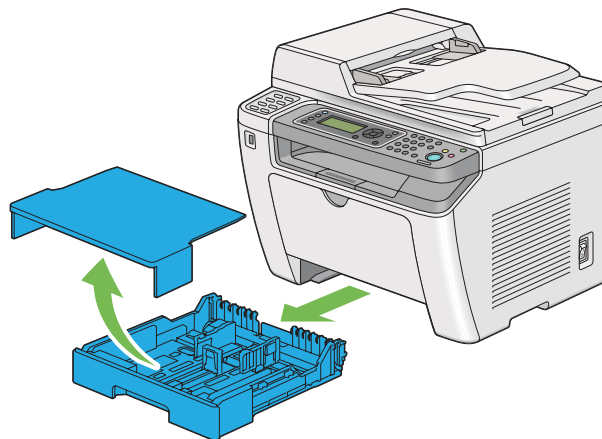

2. Hold the paper tray end with one hand, push and hold the paper tray extension lever with the other hand, and then extend the tray to your desired length.

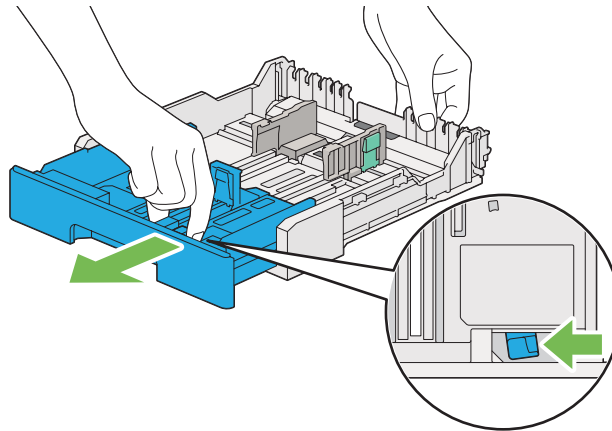

Note:

The paper tray can accommodate a stack of A5 paper by default, and is designed to extend in two lengths. To load A4 paper media, extend the paper tray to the mid length. To load longer paper media, extend it to the full length.

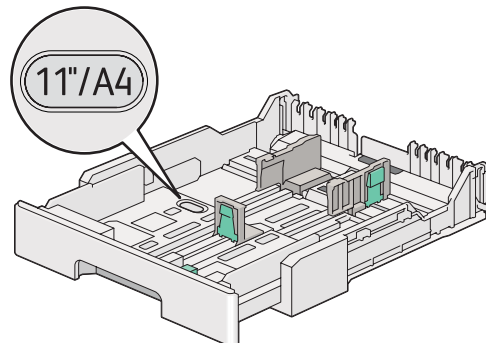

3. Slide the paper width guides and the length guide to the maximum positions.

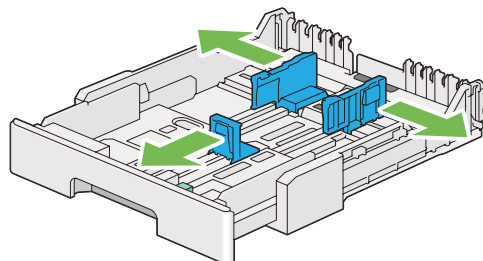

4. Before loading the print media, flex the sheets back and forth, and then fan them. Straighten the edges of the stack on a level surface.

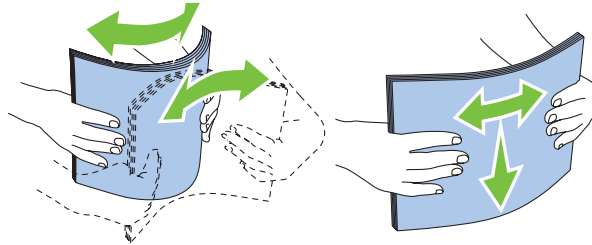

5. Load the print media into the paper tray with the recommended print surface facing up.

Note:

Do not load paper media above the fill line on the paper width guides of the paper tray as it may cause paper jams.

6. Slide the paper width guides and then the length guide inward until they rest lightly against the edges of the print media stack.

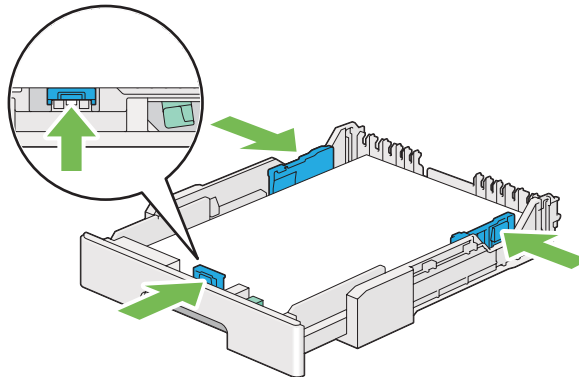

7. Replace the paper tray cover onto the paper tray.

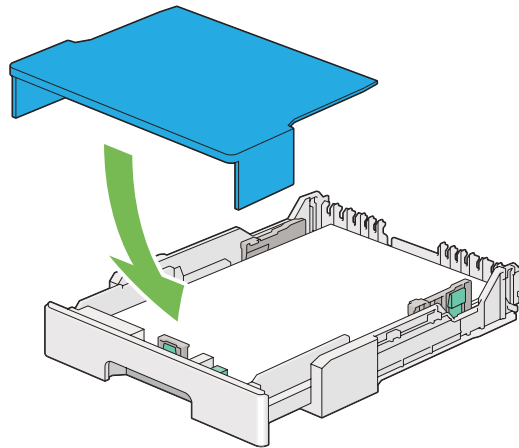

Note:

The paper tray cover can protect the loaded print media from dust and from absorbing moisture.

8. Hold the paper tray with both hands and push it into the printer until it clicks into place.

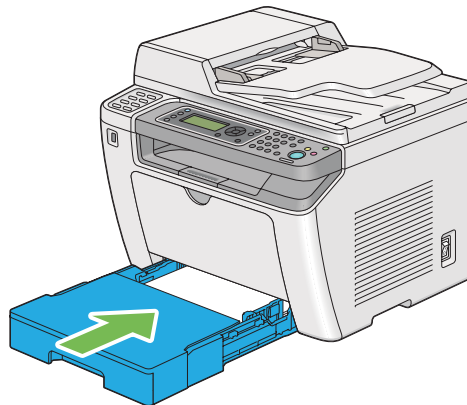

9. Select the paper type on the print driver if the loaded print media is not standard plain paper. If a user-specified print media is loaded in the paper tray, you must specify the paper size on the print driver.

Note:

For details on specifying the paper size and type on the print driver, refer to the Help provided for the print driver.

Loading Envelopes in the Paper Tray

Follow the guidelines below to load envelopes in the paper tray.

Note:

- ❑ *When you print on envelopes, be sure to specify the envelope on the print driver.*
- ❑ *If you do not load envelopes in the paper tray right after they have been removed from the packaging, they may bulge. To avoid jams, flatten them as shown below before loading them in the paper tray.*

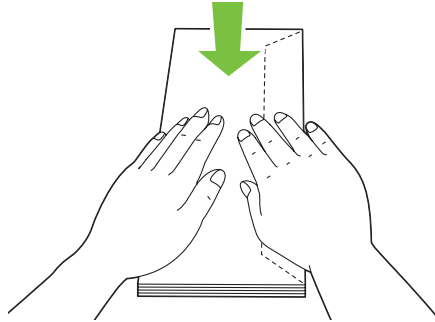

- ❑ If envelopes are still not fed correctly, add some bending to the flap of the envelopes as shown in the following illustration. The amount of the bending shall be 5 mm (0.20 inches) or less.

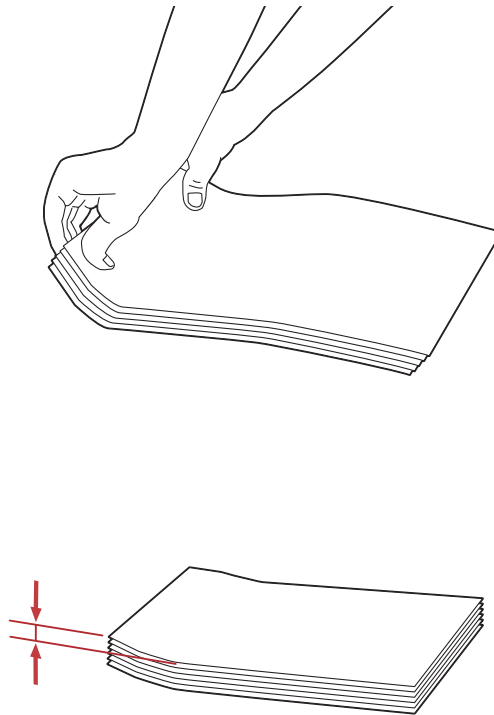

Important:

Never use envelopes with a window or coated linings as it causes paper jams that may result in damage to the printer.

Loading Com-10, Yougata 4/6, or Younaga 3 Envelopes

Load envelopes with the print surface facing up. Ensure that the flapped edge is pointing toward the right of the printer and each flap is folded under the envelope.

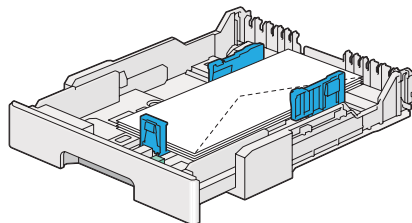

Loading Monarch, DL, or Yougata 2/3 Envelopes

You can load Monarch, DL, and Yougata 2/3 Envelopes in either of the following orientations:

SEF: Load envelopes with the print surface facing up. Ensure that the flapped edge is pointing toward the right of the printer and each flap is folded under the envelope.

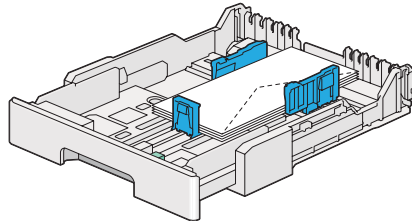

LEF: Load envelopes with the print surface facing up. Ensure that the flapped edge is pointing toward the front of the printer and the flaps are left unfolded.

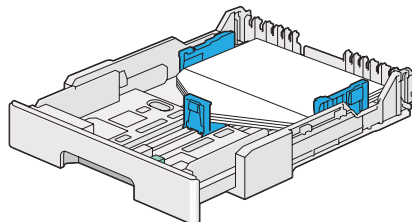

Note:

- When you load the envelopes in the LEF orientation, be sure to specify the landscape orientation on the print driver.
- To confirm the correct orientation of each print media such as envelopes, see the instructions on the **Envelope/Paper Setup Navigator** dialog box of the print driver.

Loading C5, Nagagata 3/4, or Kakugata 3 Envelopes

Load envelopes with the print surface facing up. Ensure that the flapped edge is pointing toward the rear of the printer and each flap is folded under the envelope.

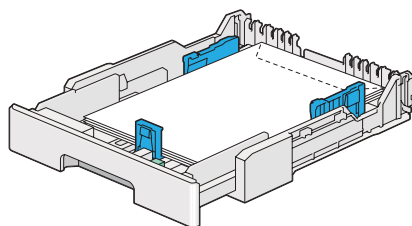

Loading Postcards in the Paper Tray

Note:

- ❑ When you print on postcards, be sure to specify the postcard on the print driver for the optimum print result.
- ❑ If postcards are still not fed correctly, try to do the followings:
 - When the postcards are curled, flatten them as shown in the following illustration.

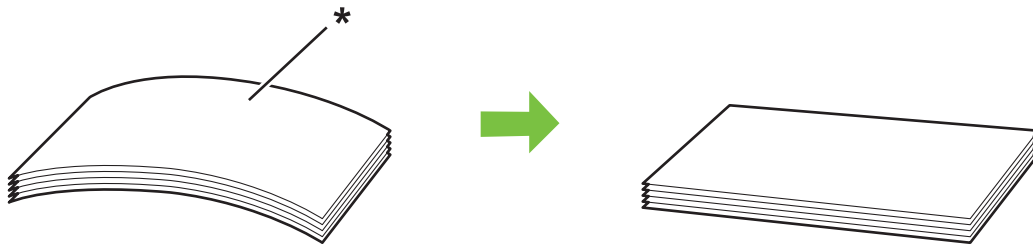

* Print surface

- Reduce the number of postcards loaded in the paper tray to five or less.

Loading Postcards

Load postcards with the print surface facing up and the top edge first.

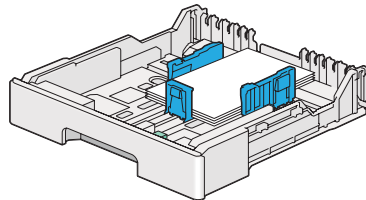

Loading W-Postcards

Load W-postcards with the print surface facing up and the left edge first.

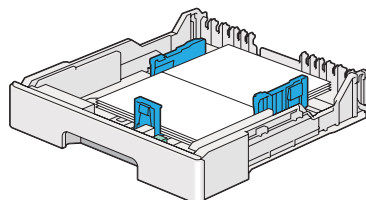

Note:

To confirm the correct orientation of each print media such as postcards, see the instructions on the **Envelope/Paper Setup Navigator** dialog box of the print driver.

Loading Print Media in the Priority Sheet Inserter (PSI)

Note:

- Before you use the Priority Sheet Inserter (PSI), make sure that the printer has the paper tray inserted.
- Use only laser print media. Do not use ink jet paper on your printer.
- For manually loading print media for duplex (2-sided) printing, see “Manual Duplex Printing (PCL Print Driver Only)” on page 141.

1. Open the front cover.

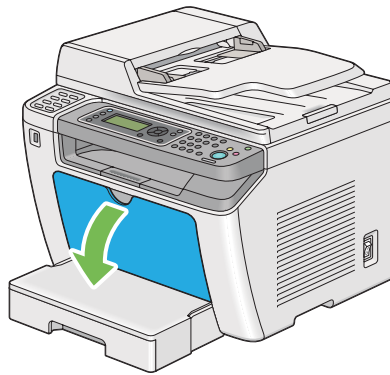

2. Slide the paper width guides to the maximum positions.

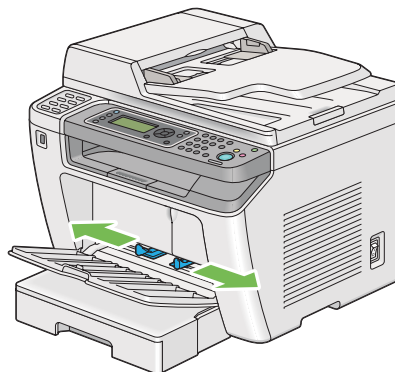

3. Before loading the print media, flex the sheets back and forth, and then fan them. Straighten the edges of the stack on a level surface.

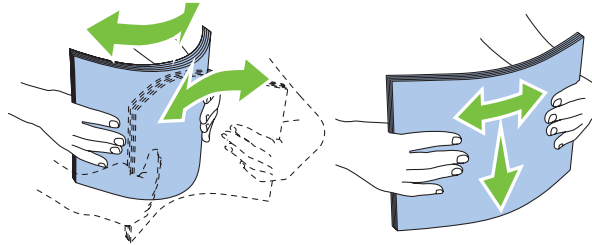

Note:

If envelopes are still not fed correctly, add some bending to the flap of the envelopes as shown in the following illustration. The amount of the bending shall be 5 mm (0.20 inches) or less.

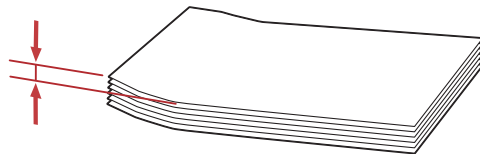
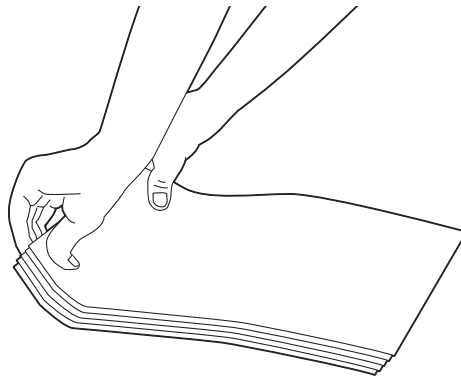

4. Load print media in the PSI with the top edge first and the recommended print surface facing up.



5. Slide the paper width guides inward until they rest lightly against the edges of the print media stack.

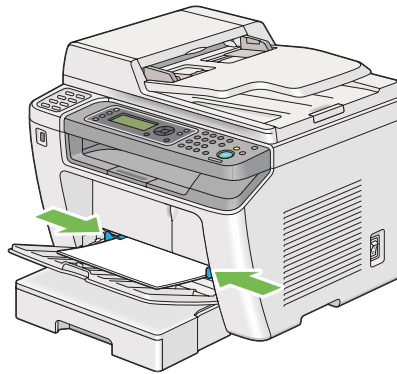

6. Select the paper type on the print driver if the loaded print media is not plain paper. If a user-specified print media is loaded in the PSI, you must specify the paper size on the print driver.

Note:

For details on specifying the paper size and type on the print driver, refer to the Help provided for the print driver.

Loading Envelopes in the Priority Sheet Inserter (PSI)

Follow the guidelines below to load envelopes in the PSI.

Note:

- ❑ Be sure to insert envelopes all the way in. Otherwise, print media that is loaded in the paper tray will be fed.
- ❑ When you print on envelopes, be sure to specify the envelope on the print driver.
- ❑ If you do not load envelopes in the PSI right after they have been removed from the packaging, they may bulge. To avoid jams, flatten them as shown below before loading them in the PSI.

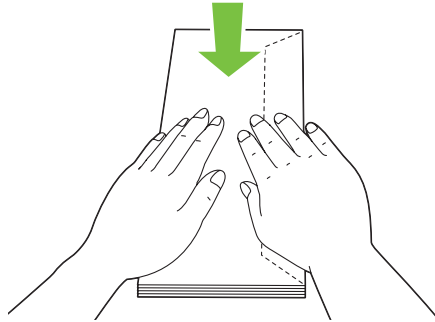

- ❑ If envelopes are still not fed correctly, add some bending to the flap of the envelopes as shown in the following illustration. The amount of the bending shall be 5 mm (0.20 inches) or less.

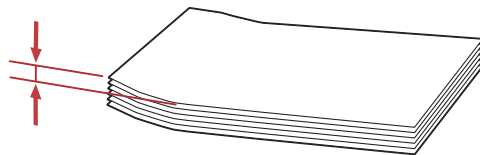
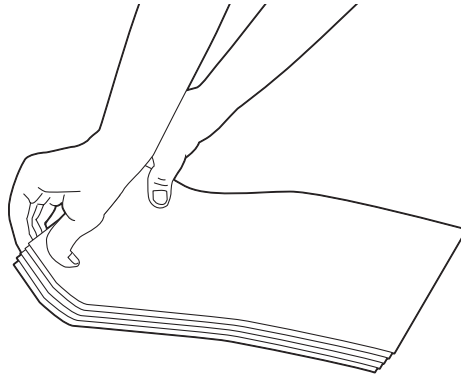

Important:

Never use envelopes with a window or coated linings as it causes paper jams that may result in damage to the printer.

Loading Com-10, DL, Yougata 4/6, or Younaga 3 Envelopes

Load envelopes with the print surface facing up. Ensure that the flapped edge is pointing toward the right of the printer and each flap is folded under the envelope.

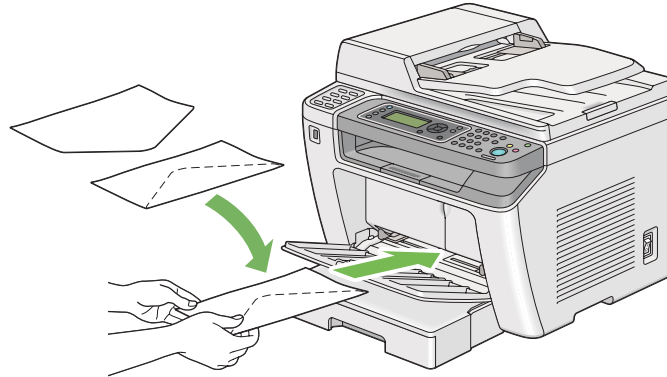
**Loading C5, Nagagata 3, or Kakugata 3 Envelopes**

Load envelopes with the print surface facing up. Ensure that the flapped edge is pointing toward the front of the printer and the flaps are left unfolded.

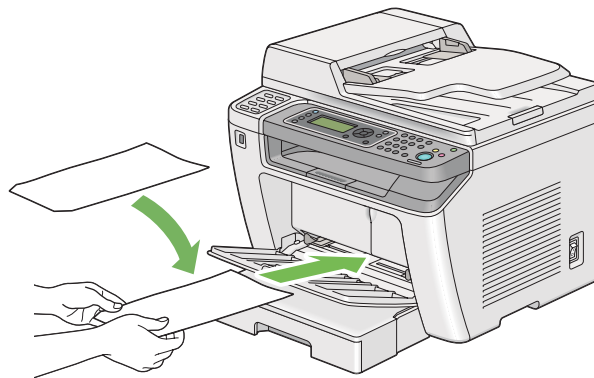
**Using the Output Tray Extension**

The output tray extension is designed to prevent print media from falling from the printer after the print job is complete.

Before printing a long length document, be sure to pull out the output tray extension.

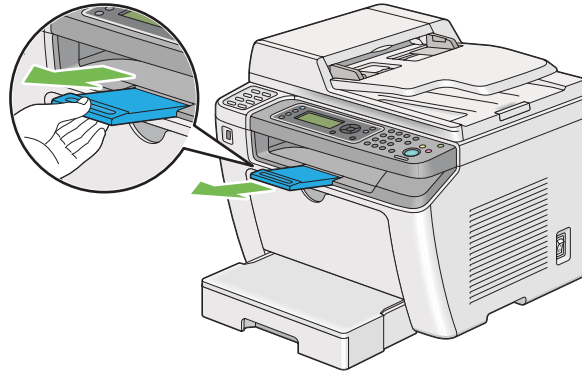

Note:

To pull out envelopes or small print media from the center output tray, lift up the scanner unit.

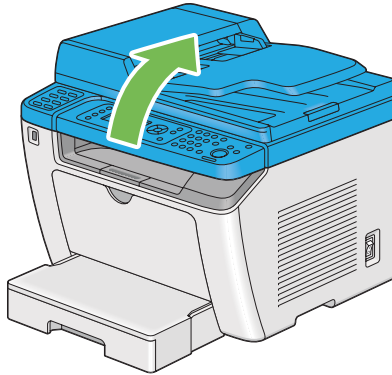

Setting Paper Sizes and Types

When loading print media, set the paper size and type on the operator panel before printing.

This section describes how to set the paper size and type on the operator panel.

See Also:

“Understanding the Operator Panel Menus” on page 263

Setting Paper Sizes

1. Press the **System** button.

2. Select **Tray Settings**, and then press the **OK** button.
3. Select **Paper Tray**, and then press the **OK** button.
4. Select **Paper Size**, and then press the **OK** button.
5. Select the correct paper size for the print media loaded, and then press the **OK** button.

Setting Paper Types

Important:

The paper type must match those of the actual print media loaded in the paper tray. Otherwise, print-quality problems can occur.

1. Press the **System** button.
2. Select **Tray Settings**, and then press the **OK** button.
3. Select **Paper Tray**, and then press the **OK** button.
4. Select **Paper Type**, and then press the **OK** button.
5. Select the correct paper type for the print media loaded, and then press the **OK** button.

Printing

This section covers how to print documents from your printer and how to cancel a job.

Printing from the Computer

Install the print driver to use all the features of the printer. When you choose **Print** from an application, a window representing the print driver appears. Select the appropriate settings for the file to print. Print settings selected on the print driver have precedence over the default menu settings selected on the operator panel or the Printer Setting Utility.

The following procedure uses Windows 7 WordPad as an example.

Clicking **Preferences** on the initial **Print** dialog box enables you to change the print settings. If you are not familiar with features on the print driver window, open the Help for additional information.

1. Open the file you want to print.
2. From the file menu, select **Print**.
3. Verify that the correct printer is selected in the dialog box. Modify the print settings as needed (such as the pages you want to print or the number of copies).
4. To adjust print settings not available from the first screen, such as **Paper Size**, **Paper Type**, or **Feed Orientation**, click **Preferences**.

The **Printing Preferences** dialog box appears.

5. Specify the print settings. For more information, click **Help**.
6. Click **OK** to close the **Printing Preferences** dialog box.
7. Click **Print** to send the job to the selected printer.

Canceling a Print Job

There are several methods for canceling a print job.

Canceling a Job From the Operator Panel

1. Press the  (**Stop**) button.

Note:

Printing is canceled only for the current job. All the following jobs will continue to print.

Canceling a Job From the Computer (Windows)

Canceling a Job From the Taskbar

When you send a print job, a small printer icon appears on the taskbar.

1. Double-click the printer icon.

A list of print jobs appears in the printer window.

2. Select the job you want to cancel.
3. Press the **Delete** key.
4. Click **Yes** on the **Printers** dialog box to cancel a print job.

Canceling a Job From the Desktop

1. Minimize all programs to reveal the desktop.

Click **start** — **Printers and Faxes** (for Windows XP).

Click **Start** — **Printers and Faxes** (for Windows Server® 2003).

Click **Start** — **Devices and Printers** (for Windows 7 and Windows Server 2008 R2).

Click **Start** — **Control Panel** — **Hardware and Sound** — **Printers** (for Windows Vista® and Windows Server 2008).

A list of available printers appears.

2. Double-click the printer you selected when you sent the job.

A list of print jobs appears in the printer window.

3. Select the job you want to cancel.
4. Press the **Delete** key.
5. Click **Yes** on the **Printers** dialog box to cancel a print job.

Duplex Printing

Duplex (2-sided) printing allows you to print on either side of a sheet of paper. The paper sizes available for duplex printing are A4, B5, A5, Letter, Executive, Folio, and Legal.

Automatic Duplex Printing

The following procedure uses the PCL® 6 driver as an example.

1. Click **start** — **Printers and Faxes** (for Windows XP).

Click **Start** — **Printers and Faxes** (for Windows Server 2003).

Click **Start** — **Devices and Printers** (for Windows 7 and Windows Server 2008 R2).

Click **Start** — **Control Panel** — **Hardware and Sound** — **Printers** (for Windows Vista).

Click **Start** — **Control Panel** — **Printers** (for Windows Server 2008).

A list of available printers appears.

2. Right-click the icon for your printer and select **Printing preferences**.

The **Paper/Output** tab appears.

3. From **Duplex**, select **Flip on Long Edge** or **Flip on Short Edge**.

4. Click **OK**.

Manual Duplex Printing (PCL Print Driver Only)

When you have a problem with automatic duplex printing, you may want to try manual duplex printing. Starting manual duplex printing displays a window containing the instructions that you can follow. Note that the window cannot be reopened once it is closed. Do not close the window until duplex printing is complete.

Note:

When printing on curled paper, straighten the paper before inserting the paper.

Operations on Your Computer

The following procedure uses Windows 7 WordPad as an example.

Note:

*The way to display the **Printer Properties/Printing Preferences** dialog box depends on the application software. Refer to the manual of your application software.*

1. From the file menu, select **Print**.
2. Select the printer from the **Select Printer** list box, and then click **Preferences**.

The **Paper/Output** tab of the **Printing Preferences** dialog box appears.

- From **Duplex**, select either **Flip on Short Edge (Manual)** or **Flip on Long Edge (Manual)** to define the way 2-sided print pages are bound.

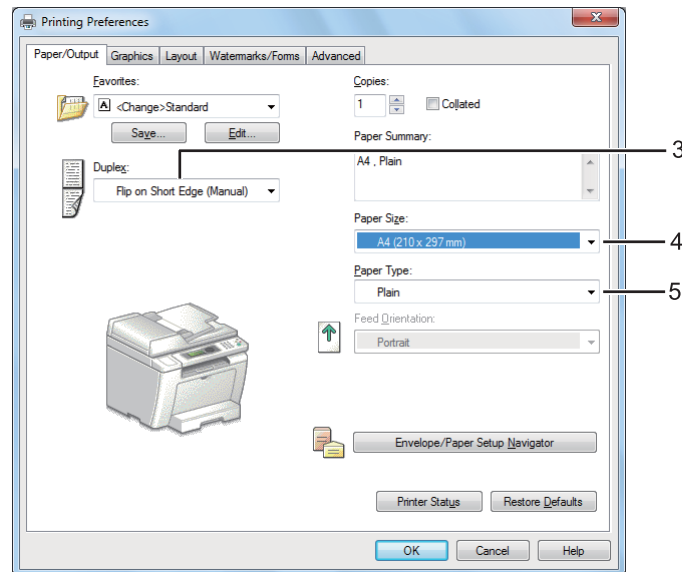

- From **Paper Size**, select the size of the document to be printed.
- From **Paper Type**, select the paper type to be used.
- Click **OK** to close the **Printing Preferences** dialog box.
- Click **Print** in the **Print** dialog box to start printing.

Loading Print Media in the Paper Tray

- First print the even pages (rear sides).

For a six page document, rear sides are printed in the order of page 6, page 4, then page 2.

When printing of the even pages is complete, the **Data** LED lights and the LCD panel shows the following:

075-921 Printer
Insert Output to Tray
Press [OK] Button to
Continue Printing

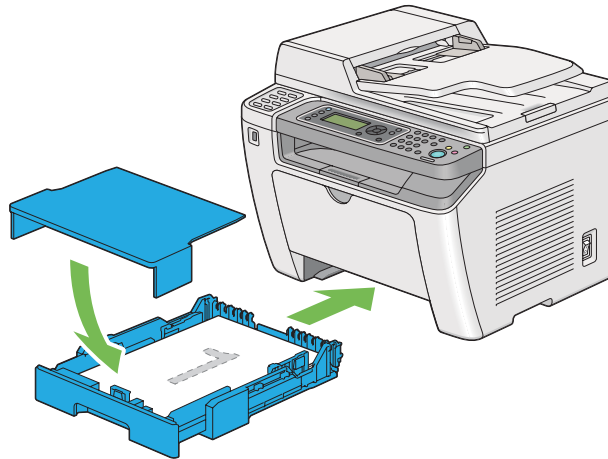

2. After the even pages are printed, pull out the paper tray and remove the paper tray cover.

See Also:

“Loading Print Media in the Paper Tray” on page 123

3. Remove the paper stack from the center output tray and load it into the paper tray with the blank surface facing up.

Note:

Warped or curled prints can cause paper jams. Straighten them before setting them.

4. Replace the paper tray cover, insert the paper tray into the printer, and then press the **OK** button.

Pages are printed in the order of page 1 (rear of page 2), page 3 (rear of page 4), and then page 5 (rear of page 6).

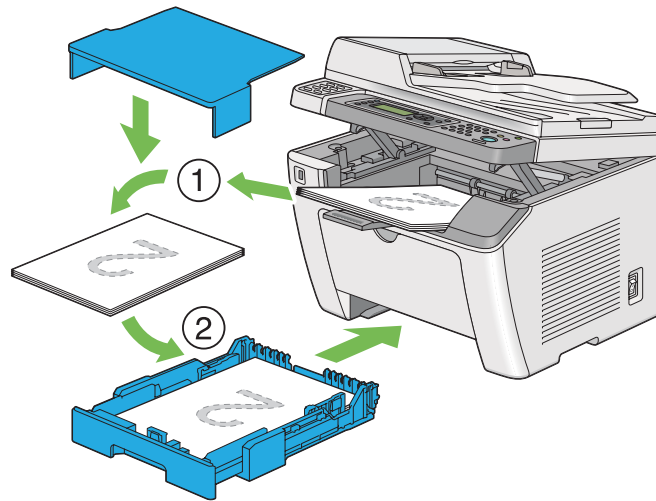

Loading Print Media in the Priority Sheet Inserter (PSI)

1. First print the even pages (rear sides).

For a six page document, rear sides are printed in the order of page 6, page 4, then page 2.

When printing of the even pages is complete, the **Data** LED lights and the LCD panel shows the following:

```

075-921 Printer
Insert Output to Tray
Press [OK] Button to
Continue Printing
  
```

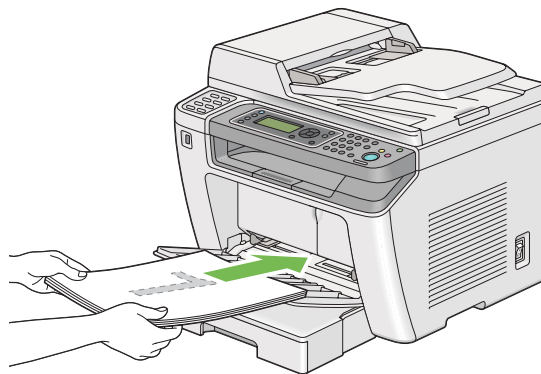

- After the even pages are printed, remove the paper stack from the center output tray.

Note:

Warped or curled prints can cause paper jams. Straighten them before setting them.

- Load the paper stack back into the PSI, and then press the **OK** button.

Pages are printed in order of page 1 (rear of page 2), page 3 (rear of page 4), and then page 5 (rear of page 6).

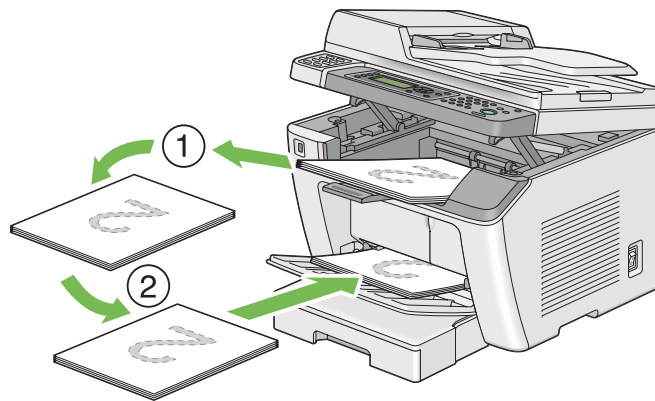

Direct Printing Using a USB Storage Device

The Print From USB Memory feature allows you to print files stored in a USB storage device by operating on the operator panel.

Important:

- To prevent damage to your printer, DO NOT connect any device other than the USB storage device to the front USB port of the printer.
- DO NOT remove the USB storage device from the front USB port until the printer is finished with printing.

Note:

If the Service Lock setting for Print from USB is set to Password Locked, you need to enter the four digit password to use the Print From USB Memory feature. If the Service Lock setting for Print from USB is set to Locked, the Print From USB Memory feature is disabled and the menu is not displayed on the LCD panel. For more information, "Service Lock" on page 301.

The front USB port of the printer is designed for USB 2.0 devices. You must use only an authorized USB storage device with an A plug type connector. Use only a metal shielded USB storage device.

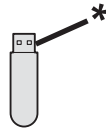



* A plug type

To print a file in a USB storage device:

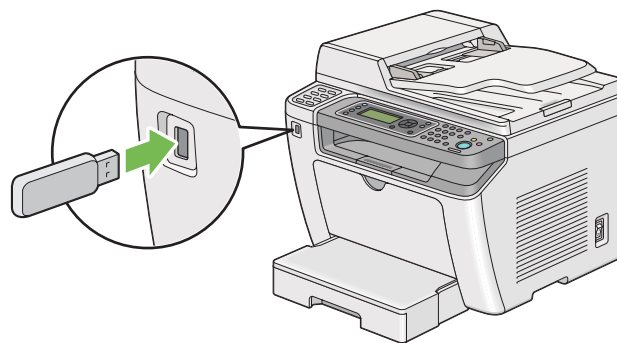
1. Press the  (**Print**) button.
2. Insert a USB storage device to the front USB port of the printer.



3. Select the desired file, and then press the  button.
4. Select printing options as needed.
5. Press the  (**Start**) button to begin printing.

Note:

You can print the files scanned and stored using the Scan to USB Memory feature. Other files, such as those created by a user, may not be printed properly.

Important:

Before removing the USB storage device, ensure that the printer is not accessing the device. Removing the USB storage device while being accessed may destroy the data in the device or the USB storage device itself.

Selecting Printing Options

Selecting Printing Preferences (Windows)

Printing preferences control all of your print jobs, unless you override them specifically for a job. For example, if you want to use duplex (2-sided) printing for most jobs, set this option in printing preferences.

1. Click **start** — **Printers and Faxes** (for Windows XP).

Click **Start** — **Printers and Faxes** (for Windows Server 2003).

Click **Start** — **Devices and Printers** (for Windows 7 and Windows Server 2008 R2).

Click **Start** — **Control Panel** — **Hardware and Sound** — **Printers** (for Windows Vista and Windows Server 2008).

A list of available printers appears.

2. Right-click the icon for your printer, and then select **Printing preferences**.

The printer's **Printing Preferences** dialog box appears.

3. Make selections on the driver tabs, and then click **OK** to save your selections.

Note:

*For details on the Windows print driver options, click **Help** on the print driver tab to view the Help.*

Selecting Options for an Individual Job (Windows)

If you want to use special printing options for a particular job, change the driver settings before sending the job to the printer. For example, if you want to use Photo print-quality mode for a particular graphic, select this setting on the print driver before printing that job.

1. With the desired document or graphic open in your application, access the **Print** dialog box.
2. Select your printer and click **Preferences** to open the print driver.
3. Make selections on the driver tabs.

Note:

*On Windows OS, you can save current printing options with a distinctive name and apply them to other print jobs. Make selections on the **Paper/Output**, **Graphics**, **Layout**, **Watermarks/Forms**, or **Advanced** tab, and then click **Save** under **Favorites** on the **Paper/Output** tab. Click **Help** for more information.*

4. Click **OK** to save your selections.
5. Print the job.

See the following table for specific printing options:

Printing Options for Windows

Operating System	Driver Tab	Printing Options
Windows XP, Windows XP x 64bit, Windows Server 2003, Windows Server 2003 x 64bit, Windows Vista, Windows Vista x 64bit, Windows Server 2008, Windows Server 2008 x 64bit, Windows Server 2008 R2, Windows 7, or Windows 7 x 64bit	Paper/Output tab	<input type="checkbox"/> Favorites <input type="checkbox"/> Duplex <input type="checkbox"/> Copies <input type="checkbox"/> Collated* <input type="checkbox"/> Paper Summary <input type="checkbox"/> Paper Size <input type="checkbox"/> Paper Type <input type="checkbox"/> Feed Orientation <input type="checkbox"/> Envelope/Paper Setup Navigator <input type="checkbox"/> Printer Status <input type="checkbox"/> Restore Defaults
	Graphics tab	<input type="checkbox"/> Image Quality <input type="checkbox"/> Toner Saving Mode <input type="checkbox"/> Image Enhancement <input type="checkbox"/> Screen <input type="checkbox"/> Image Settings <ul style="list-style-type: none"> <input type="checkbox"/> Apply to All Elements <input type="checkbox"/> Apply to Selected Element <input type="checkbox"/> Brightness <input type="checkbox"/> Contrast <input type="checkbox"/> Tone Balance <input type="checkbox"/> Restore Defaults
	Layout tab	<input type="checkbox"/> Image Orientation <input type="checkbox"/> Multiple Up <input type="checkbox"/> Image Order <input type="checkbox"/> Image Border <input type="checkbox"/> Booklet / Poster / Mixed Document <input type="checkbox"/> Output Size <input type="checkbox"/> Reduce / Enlarge <input type="checkbox"/> Margin Shift/Margin <input type="checkbox"/> Restore Defaults

Operating System	Driver Tab	Printing Options
Windows XP, Windows XP x 64bit, Windows Server 2003, Windows Server 2003 x 64bit, Windows Vista, Windows Vista x 64bit, Windows Server 2008, Windows Server 2008 x 64bit, Windows Server 2008 R2, Windows 7, or Windows 7 x 64bit	Watermarks/Forms tab	<input type="checkbox"/> Watermarks <ul style="list-style-type: none"> <input type="checkbox"/> New Text <input type="checkbox"/> New Bitmap <input type="checkbox"/> Edit <input type="checkbox"/> Delete <input type="checkbox"/> First Page Only <input type="checkbox"/> Forms <ul style="list-style-type: none"> <input type="checkbox"/> Off <input type="checkbox"/> Create / Register Forms <input type="checkbox"/> Image Overlay <input type="checkbox"/> Header / Footer Options <input type="checkbox"/> Restore Defaults
	Advanced tab	<input type="checkbox"/> Items <ul style="list-style-type: none"> <input type="checkbox"/> Change All Colors to Black <input type="checkbox"/> Resolution <input type="checkbox"/> Show Paper Size/Type Error <input type="checkbox"/> Font Settings <input type="checkbox"/> Restore Defaults

* **Collated** is not available when the settings in **Watermarks/Forms** tab are set on the 64-bit OS.

Selecting Options for an Individual Job (Mac OS X)

To select print settings for a particular job, change the driver settings before sending the job to the printer.

1. With the document open in your application, click **File**, and then click **Print**.
2. Select your printer from **Printer**.
3. Select the desired printing options from the menus and drop-down lists that are displayed.

Note:

On Mac OS X, click **Save As** on the **Presets** menu screen to save the current printer settings. You can create multiple presets and save each with its own distinctive name and printer settings. To print jobs using specific printer settings, click the applicable saved preset in the **Presets** menu.

4. Click **Print** to print the job.

Mac OS X Print Driver Printing Options:

The table shown below uses Mac OS X 10.6 TextEdit as an example.

Printing options for Mac OS X

Item	Printing Options
	<input type="checkbox"/> Copies <input type="checkbox"/> Collated <input type="checkbox"/> Pages <input type="checkbox"/> Paper Size <input type="checkbox"/> Orientation
Layout	<input type="checkbox"/> Pages per Sheet <input type="checkbox"/> Layout Direction <input type="checkbox"/> Border <input type="checkbox"/> Two-Sided <input type="checkbox"/> Reverse page orientation <input type="checkbox"/> Flip horizontally
Color Matching	<input type="checkbox"/> ColorSync <input type="checkbox"/> In printer <input type="checkbox"/> Profile
Paper Handling	<input type="checkbox"/> Pages to Print <input type="checkbox"/> Page Order <input type="checkbox"/> Scale to fit paper size <input type="checkbox"/> Destination Paper Size <input type="checkbox"/> Scale down only
Cover Page	<input type="checkbox"/> Print Cover Page <input type="checkbox"/> Cover Page Type <input type="checkbox"/> Billing Info
Scheduler	<input type="checkbox"/> Print Document <input type="checkbox"/> Priority
Printer Features	<input type="checkbox"/> 1. Detailed Settings <ul style="list-style-type: none"> <input type="checkbox"/> Resolution <input type="checkbox"/> Screen <input type="checkbox"/> Toner Saving Mode <input type="checkbox"/> Image Enhancement <input type="checkbox"/> 2. Paper Handling <ul style="list-style-type: none"> <input type="checkbox"/> Duplex <input type="checkbox"/> Paper Type <input type="checkbox"/> Show Paper Size/Type Error

Item	Printing Options
Summary	

Printing Custom Size Paper

This section explains how to print on custom size paper using the print driver.

The way to load custom size paper is the same as the one to load standard size paper.

- ❑ “Loading Print Media in the Paper Tray” on page 123
- ❑ “Loading Print Media in the Priority Sheet Inserter (PSI)” on page 132
- ❑ “Setting Paper Sizes and Types” on page 137

Defining a Custom Paper Size

Before printing, define a custom size on the print driver.

Note:

When defining a paper size on the print driver or the operator panel, be sure to specify the same size as the actual print media used. Specifying a wrong size for printing can cause a printer failure. This is especially true if you specify a bigger size when using a narrow width paper.

Using the Windows Print Driver

On the Windows print driver, define a custom size in the **Custom Paper Size** dialog box. This section explains the procedure using Windows 7 as an example.

On Windows XP or later, only users with administrator rights can use the administrator's password to change the settings. Users without the rights of administrator can only view the contents.

1. Click **Start — Devices and Printers**.
2. Right-click the icon for your printer, and then select **Printer properties**.
3. Select the **Configuration** tab.
4. Click **Custom Paper Size**.
5. Select the custom setup you want to define from **Details**.

6. Specify the length of the short edge and long edge under **Change Setting For**. You can specify the values either by entering them directly or using the up arrow and down arrow buttons. The length of the short edge cannot be longer than the long edge, even if it is within the specified range. The length of the long edge cannot be shorter than the short edge, even if it is within the specified range.
7. To assign a paper name, select the **Name the Paper Size** check box, and then enter the name in **Paper Name**. Up to 14 characters can be used for the paper name.
8. If necessary, repeat steps 5 to 7 to define another custom size.
9. Click **OK** twice.

Printing on Custom Size Paper

Use the following procedures to print using either the Windows or Mac OS X print driver.

Using the Windows Print Driver

This section explains the procedure using Windows 7 WordPad as an example.

Note:

*The way to display the **Printer Properties/Printing Preferences** dialog box depends on the application software. Refer to the manual of your application software.*

1. From the file menu, select **Print**.
2. Select your printer and click **Preferences**.
3. Select the **Paper/Output** tab.
4. Select the size of the document to be printed from **Paper Size**.
5. Select the paper type to be used from **Paper Type**.
6. Click the **Layout** tab.
7. From **Output Size**, select the custom size you defined. If you have selected the custom size from **Paper Size** in step 4, select **Same as Paper Size**.
8. Click **OK**.

9. Click **Print** in the **Print** dialog box to start printing.

Using the Mac OS X Print Driver

This section explains the procedure using Mac OS X 10.6 TextEdit as an example.

1. From the **File** menu, select **Page Setup**.
2. Select your printer from **Format For**.
3. From **Paper Size**, select **Manage Custom Sizes**.
4. In the **Custom Paper Sizes** window, click **+**.
A newly created setting **Untitled** is displayed in the list.
5. Double-click **Untitled** and enter a name for the setting.
6. Enter the size of the document to be printed in the **Width** and **Height** boxes of **Paper Size**.
7. Specify **Non-Printable Area** if necessary.
8. Click **OK**.
9. Make sure that the newly created paper size is chosen in **Paper Size**, and then click **OK**.
10. From the **File** menu, select **Print**.
11. Click **Print** to start printing.

Checking Status of a Print Job

Checking Status (Windows Only)

You can check the printer status with Status Monitor. Double-click the Status Monitor printer icon on the taskbar at the bottom right of the screen. The **Printer Selection** window appears and displays the printer name, the printer connection port, printer status, and the model name. Check the column **Status** for the current status of your printer.

Settings button: Displays the **Settings** window and allows you to modify the Status Monitor settings.

Click the name of the desired printer listed on the **Printer Selection** window. The **Printer Status** window appears. You can check the printer status and print job status.

For details on Status Monitor, see Help. The following procedure uses Windows 7 as an example:

1. Click **Start** — **All Programs** — **EPSON** — your printer — **Activate Status Monitor**.

The **Printer Selection** window appears.

2. Click the name of the desired printer from the list.

The **Printer Status** window appears.

3. Click **Help**.

See Also:

“Status Monitor (Windows Only)” on page 35

Checking Status on EpsonNet Config (Windows & Mac OS X)

You can check the status of the print job sent to the printer on the **Jobs** tab of EpsonNet Config.

See Also:

“Printer Management Software” on page 33

Printing a Report Page

You can print various types of reports and lists. For details on each report and list, see “Report / List” on page 263.

Taking the System Settings page as an example, this section describes two methods of printing a report page.

Printing the System Settings Page

To verify detailed printer settings, print the System Settings page.

Using the Operator Panel

Note:

The reports and lists are all printed in English.

1. Press the **System** button.
2. Select **Report / List**, and then press the **OK** button.
3. Select **System Settings**, and then press the **OK** button.

The System Settings page is printed.

Using the Printer Setting Utility (Windows Only)

The following procedure uses Windows 7 as an example.

Note:

The reports and lists are all printed in English.

1. Click **Start** — **All Programs** — **EPSON** — your printer — **Printer Setting Utility**.

Note:

*The window to select a printer appears in this step when multiple print drivers are installed on your computer. In this case, click the name of the desired printer listed in **Printer Name**.*

The Printer Setting Utility starts.

2. Click the **Printer Settings Report** tab.
3. Select **Reports** from the list at the left side of the page.

The **Reports** page is displayed.

4. Click the **System Settings** button.

The System Settings page is printed.

Printer Settings

You can change the printer settings using either the operator panel or the Printer Setting Utility.

Changing the Printer Settings

Using the Operator Panel

Note:

- Factory defaults may vary for different regions.*
- Once one value is selected, it will be active until a new value is applied or the default value is restored.*
- Driver settings may have precedence over the changes previously made and you may have to change the printer settings.*

1. Press the **System** button.
2. Select the desired menu, and then press the **OK** button.
3. Select the desired menu or menu item, and then press the **OK** button.
 - If the selection is a menu, the menu opens and the list of menu items appears.
 - If the selection is a menu item, the default menu setting appears.

A value can be:

- A phrase or word to describe a setting
 - A numerical value that can be changed
 - An On or Off setting
4. Repeat step 3 until you reach the desired value.
 5. Press the **OK** button to apply the selected value.
 6. To continue changing the printer settings, use the **⏪ (Back)** button to ascend the operator panel menus to one of the top menus and follow steps 2 through 5.

To quit changing the printer settings, keep pressing the **⏪ (Back)** button until the LCD panel shows `Select Function`.

Using the Printer Setting Utility (Windows Only)

The following procedure uses Windows 7 as an example.

Note:

- Once one value is selected, it will be active until a new value is applied or the default value is restored.
 - Driver settings may have precedence over the changes previously made and you may have to change the printer settings.
1. Click **Start — All Programs — EPSON — your printer — Printer Setting Utility**.

Note:

The window to select a printer appears in this step when multiple print drivers are installed on your computer. In this case, click the name of the desired printer listed in **Printer Name**.

The Printer Setting Utility starts.

2. Click the **Printer Maintenance** tab.
3. Select the desired menu item.

Each menu item has a list of values. A value can be:

- A phrase or word to describe a setting
 - A numerical value that can be changed
 - An On or Off setting
4. Select the desired value, and then click the **Apply New Settings** or **Restart printer to apply new settings** button.

Printing with the Web Services on Devices

This section provides information for network printing with the Web Services on Devices available on Windows Vista, Windows Server 2008, Windows Server 2008 R2, and Windows 7 protocol of Microsoft.

Adding Roles of Print Services

When you use Windows Server 2008 or Windows Server 2008 R2, you need to add the roles of print services to the Windows Server 2008 or Windows Server 2008 R2 client.

For Windows Server 2008:

1. Click **Start — Administrative Tools — Server Manager**.
2. From the **Action** menu, select **Add Roles**.
3. Select the **Print Services** check box on the **Server Roles** window in the **Add Roles Wizard**, and then click **Next**.
4. Click **Next**.
5. Select the **Print Server** check box, and then click **Next**.
6. Click **Install**.

For Windows Server 2008 R2:

1. Click **Start — Administrative Tools — Server Manager**.
2. From the **Action** menu, select **Add Roles**.
3. Select the **Print and Document Services** check box on the **Server Roles** window in the **Add Roles Wizard**, and then click **Next**.
4. Click **Next**.
5. Select the **Print Server** check box, and then click **Next**.
6. Click **Install**.

Printer Setup

You can install your new printer on the network using the Software Disc that shipped with your printer, or using the **Add Printer** wizard.

Installing a Print Driver Using the Add Printer Wizard

1. Click **Start — Control Panel — Hardware and Sound — Printers (Start — Devices and Printers** for Windows Server 2008 R2 and Windows 7).
2. Click **Add a printer** to launch the **Add Printer** wizard.

3. Select **Add a network, wireless or Bluetooth printer**.
4. In the list of available printers, select the one you want to use, and then click **Next**.

Note:

- In the list of available printers, the **Web Services on Devices printer** is displayed in the form of "**http://IP address/ws/**".*
 - If no **Web Services on Devices printer** is displayed in the list, enter the printer's IP address manually to create a **Web Services on Devices printer**. To enter the printer's IP address manually, follow the instructions below. For Windows Server 2008 R2, to create a **Web Services on Devices printer**, you must be a member of Administrators group.*
 1. Click **The printer that I want isn't listed**.
 2. Select **Add a printer using a TCP/IP address or hostname** and click **Next**.
 3. Select **Web Services Device** from **Device type**.
 4. Enter the printer's IP address in the **Hostname or IP address** text box and click **Next**.
 - Before installing the driver using the **Add Printer** wizard on Windows Server 2008 R2 or Windows 7, perform one of the followings:*
 - Establish the Internet connection so that Windows Update can scan your computer.
 - Add the print driver to your computer in advance.
5. If prompted, install the print driver on your computer. If you are prompted for an administrator password or confirmation, type the password or provide confirmation.
 6. Complete the additional steps in the wizard, and then click **Finish**.
 7. Print a test page to verify print installation.
 - a Click **Start — Control Panel — Hardware and Sound — Printers (Start — Devices and Printers** for Windows Server 2008 R2 and Windows 7).
 - b Right-click the printer you just created, and then click **Properties (Printer properties** for Windows Server 2008 R2 and Windows 7).
 - c On the **General** tab, click **Print Test Page**. When a test page is printed successfully, installation is complete.

Chapter 6

Copying

Loading Paper for Copying

Note:

If the Service Lock setting for Copy is set to Password Locked, you need to enter the four digit password to use the copy function. If the Service Lock setting is set to Locked, the copy function is disabled and the menu is not displayed on the LCD panel. For more information, see "Service Lock" on page 301.

The instructions for loading print documents are the same whether you are printing, faxing, or copying.

See Also:

- ❑ "Usable Print Media" on page 119
- ❑ "Loading Print Media" on page 122

Preparing a Document

You can use the document glass or the Automatic Document Feeder (ADF) to load a source document for copying, scanning and sending a fax. You can load up to 50 sheets of 64 gsm documents for one job using the ADF or one sheet at a time using the document glass.

Important:

- ❑ Avoid loading documents that are smaller than 148.0 × 210.0 mm (5.83 × 8.27 inch) or larger than 215.9 × 355.6 mm (8.5 × 14 inch), different sizes or weights together, booklets, pamphlets, transparencies, or documents having other unusual characteristics in ADF.
- ❑ Carbon-paper or carbon-backed paper, coated paper, onion skin or thin paper, wrinkled or creased paper, curled or rolled paper or torn paper cannot be used in ADF.
- ❑ Do not use the documents with staples, paper clips or exposed to adhesives or solvent based materials such as glue, ink and correcting fluid in ADF.

Note:

To ensure the best scan quality, especially for color or gray scale images, use the document glass instead of the ADF.

Making Copies From the Document Glass

Note:

- ❑ A computer connection is not required for copying.
- ❑ Ensure that no document is on the Automatic Document Feeder (ADF). If any document is detected on the ADF, it takes priority over the document on the document glass.
- ❑ Contaminants on the document glass may cause black spots on the copy printout. For best results, clean the document glass before use. For more information, see “Cleaning the Scanner” on page 378.

To make a copy from the document glass:

1. Open the document cover.

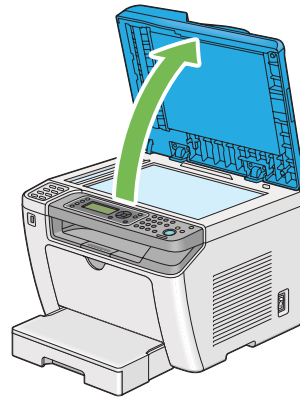

2. Place a single document face down on the document glass and align it with the registration guide on the top left corner of the document glass.

**Caution:**

Do not apply excessive force to hold a thick document on the document glass. It may break the glass and cause injuries.

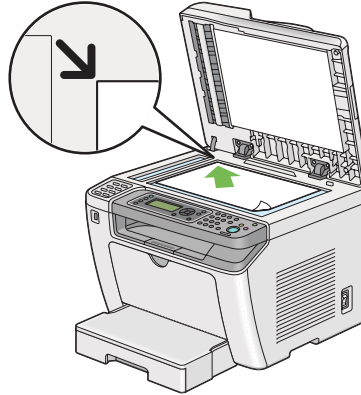

3. Close the document cover.

Note:

- Leaving the document cover open while copying may affect the copy quality and increase the toner consumption.*
- If you are copying a page from a book or magazine, lift the document cover until its hinges are caught by the stopper, and then close the document cover. If the book or magazine is thicker than 20 mm, start copying with the document cover open.*

4. Press the  (**Copy**) button.
5. Customize the copy settings including the number of copies, copy size, and image quality.

See Also:

“Customizing Copy Options” on page 165

To clear the settings, use the  (**Clear All**) button.

6. Press the  (**Start**) button to begin copying.

Note:

*Press the  (**Stop**) button to cancel a copy job at any time while scanning a document.*







Making Copies From the Automatic Document Feeder (ADF)

Important:

Do not load more than 50 sheets on the ADF or allow more than 50 sheets to be fed to the document output tray. The document output tray should be emptied before it holds more than 50 sheets or your source documents may be damaged.

Note:

- ❑ To ensure the best scan quality, especially for color or gray scale images, use the document glass instead of the ADF.
- ❑ A computer connection is not required for copying.
- ❑ You cannot load the following documents on the ADF. Be sure to place them on the document glass.

	Curled documents		Pre-punched paper
	Lightweight documents		Folded, creased or torn documents
	Cut and paste documents		Carbon paper

To make a copy from the ADF:

1. Load up to 50 sheets of 64 gsm documents face up on the ADF with the top edge going in first. Then adjust the document guides to the correct document size.

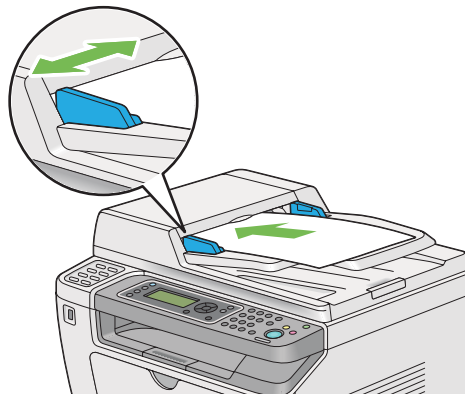

Note:

Ensure that you use the document guides before copying a legal-size document.

2. Press the  (**Copy**) button.

3. Customize the copy settings including the number of copies, copy size, and image quality.

See Also:

“Customizing Copy Options” on page 165

To clear the settings, use the  (**Clear All**) button.

4. Press the  (**Start**) button to begin copying.



Note:

Press the  (**Stop**) button to cancel a copy job at any time while scanning a document.

Customizing Copy Options

You can customize the following options for the current copy job before pressing the  (**Start**) button to make copies.

Note:

*After a copy job is completed, the copy options would be kept until the LCD panel shows Select Function (auto-reset or the  (**Back**) button is pressed), the  (**Clear All**) button is pressed, or the  (**Copy**) button is pressed again.*

Number of Copies

You can specify the number of copies from 1 to 99.

1. Load a document(s) face up on the Automatic Document Feeder (ADF) with the top edge going in first; or place a single document face down on the document glass and close the document cover.

See Also:

“Making Copies From the Automatic Document Feeder (ADF)” on page 164

“Making Copies From the Document Glass” on page 162

2. Press the  (**Copy**) button.
3. Enter the number of copies using the numeric keypad.
4. If necessary, customize other copy options including the copy size, and image quality.

See Also:

“Customizing Copy Options” on page 165

5. Press the  (**Start**) button to begin copying.

Original Size



You can specify the default document size.

1. Load a document(s) face up on the Automatic Document Feeder (ADF) with the top edge going in first; or place a single document face down on the document glass and close the document cover.

See Also:

“Making Copies From the Automatic Document Feeder (ADF)” on page 164

“Making Copies From the Document Glass” on page 162

2. Press the  (**Copy**) button.
3. Select **Original Size**, and then press the  button.
4. Select the desired setting, and then press the  button.

A4 - 210x297mm*
A5 - 148x210mm
B5 - 182x257mm
Letter - 8.5x11"
Folio - 8.5x13"
Legal - 8.5x14"
Executive

* Factory default menu setting

5. If necessary, customize other copy options including the number of copies, and image quality.

See Also:

“Customizing Copy Options” on page 165

6. Press the  (**Start**) button to begin copying.

Output Paper Size



You can specify the output paper size.

1. Load a document(s) face up on the Automatic Document Feeder (ADF) with the top edge going in first; or place a single document face down on the document glass and close the document cover.

See Also:

“Making Copies From the Automatic Document Feeder (ADF)” on page 164

“Making Copies From the Document Glass” on page 162

2. Press the  (**Copy**) button.
3. Select Output Paper Size, and then press the  button.
4. Select the desired setting, and then press the  button.

Note:

To change the default Output Paper Size settings, change the Paper Size settings of Paper Tray under Tray Settings.

A4 - 210x297mm *
A5 - 148x210mm
B5 - 182x257mm
Letter - 8.5x11"
Folio - 8.5x13"
Legal - 8.5x14"
Executive
Statement
#10 Env. - 4.125x9.5"
Monarch Env.
Monarch Env. L
DL Env. - 110x220mm
DL Env. L

C5 Env. - 162x229mm		
Postcard JPN - 148x100mm		
W-Postcard JPN - 148x200mm		
Env Yougata 2		
Env Yougata 2L		
Env Yougata 3		
Env Yougata 3L		
Env Yougata 4		
Env Yougata 6		
Env Younaga 3		
Env Nagagata 3		
Env Nagagata 4		
Env Kakugata 3		
New Custom Size	Portrait(Y)	297mm*/11.7inch*
		127mm - 355mm/5.0inch - 14.0inch
	Landscape(X)	210mm*/8.3inch*
		77mm - 215mm/3.0inch - 8.5inch

* Factory default menu setting

- If necessary, customize other copy options including the number of copies, and image quality.

See Also:

“Customizing Copy Options” on page 165

- Press the  (**Start**) button to begin copying.

Reduce/Enlarge



You can reduce or enlarge the size of a copied image, from 25% to 400%.

Note:

- When you make a reduced copy, black lines may appear at the bottom of your copy.

- This item is available only when Multiple UP is set to Off or Manual.
1. Load a document(s) face up on the Automatic Document Feeder (ADF) with the top edge going in first; or place a single document face down on the document glass and close the document cover.

See Also:

- “Making Copies From the Automatic Document Feeder (ADF)” on page 164
 - “Making Copies From the Document Glass” on page 162
2. Press the  (**Copy**) button.
 3. Select Reduce/Enlarge, and then press the  button.
 4. Select the desired settings, and then press the  button.

mm system

200%
A5->A4(141%)
A5->B5(122%)
100%*
B5->A5(81%)
A4->A5(70%)
50%

* Factory default menu setting

inch system

200%
Stmt->Lgl(154%)
Stmt->Ltr(129%)
100%*
Lgl->Ltr (78%)
Ldgr->Ltr(64%)

50%

* Factory default menu setting

Note:

You can also use the numeric keypad to input the desired zoom ratio from 25% to 400%, or press the ► or the ◀ button to enlarge or reduce the zoom ratio by 1%. See the following table for specific zoom ratios.

		Copy		
		A5	B5	A4
Source	A5	100%	122%	141%
	B5	81%	100%	115%
	A4	70%	86%	100%

The methods to load print media vary depending on the size and orientation of the print media. For more information, refer to “Loading Print Media in the Paper Tray” on page 123 or “Loading Print Media in the Priority Sheet Inserter (PSI)” on page 132.

For print media that can be loaded, refer to “Usable Print Media” on page 119.

- If necessary, customize other copy options including the number of copies, and image quality.

See Also:

“Customizing Copy Options” on page 165

- Press the ◊ (**Start**) button to begin copying.

Collated

You can sort the copy output. For example, if you make two copies of three page documents, one complete three page document will print followed by the second complete document.

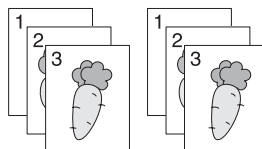

Note:



Copying documents with a large amount of data may exhaust available memory. If a memory shortage occurs, cancel the collating by turning **Collated** to **Off** on the operator panel.

1. Load multiple documents face up on the Automatic Document Feeder (ADF) with the top edge going in first; or place a single document face down on the document glass and close the document cover.

See Also:

❑ “Making Copies From the Automatic Document Feeder (ADF)” on page 164

❑ “Making Copies From the Document Glass” on page 162

2. Press the  (**Copy**) button.
3. Select **Collated**, and then press the  button.
4. Select the desired setting, and then press the  button.

Off*	Does not copy documents in the collated order.
On	Copies documents in the collated order.

* Factory default menu setting

5. If necessary, customize other copy options including the number of copies, copy size, and image quality.

See Also:

“Customizing Copy Options” on page 165

6. Press the  (**Start**) button to begin copying.

Document Type



You can select the copy image quality.

1. Load a document(s) face up on the Automatic Document Feeder (ADF) with the top edge going in first; or place a single document face down on the document glass and close the document cover.

See Also:

❑ “Making Copies From the Automatic Document Feeder (ADF)” on page 164

❑ *“Making Copies From the Document Glass” on page 162*

2. Press the  (**Copy**) button.
3. Select Document Type, and then press the  button.
4. Select the desired setting, and then press the  button.

Text	Suitable for documents with text.
Mixed*	Suitable for documents with both text and photos/gray tones.
Photo	Suitable for documents with photos.

* Factory default menu setting

5. If necessary, customize other copy options including the number of copies, and copy size.

See Also:

“Customizing Copy Options” on page 165

6. Press the  (**Start**) button to begin copying.

Lighten/Darken



You can adjust the copy density level to make the copy lighter or darker than the source document.

1. Load a document(s) face up on the Automatic Document Feeder (ADF) with the top edge going in first; or place a single document face down on the document glass and close the document cover.

See Also:

❑ *“Making Copies From the Automatic Document Feeder (ADF)” on page 164*

❑ *“Making Copies From the Document Glass” on page 162*

2. Press the  (**Copy**) button.
3. Select Lighten/Darken, and then press the  button.
4. Select the desired setting, and then press the  button.

Lighten2	Makes the copy lighter than the source document. Works well with dark print.
Lighten1	
Normal*	Works well with standard type or printed documents.
Darken1	Makes the copy darker than the source document. Works well with light print or faint pencil markings.
Darken2	

* Factory default menu setting

- If necessary, customize other copy options including the number of copies, copy size, and image quality.

See Also:

“Customizing Copy Options” on page 165

- Press the  (**Start**) button to begin copying.

Sharpness



You can adjust the sharpness to make the copy sharper or softer than the source document.

- Load a document(s) face up on the Automatic Document Feeder (ADF) with the top edge going in first; or place a single document face down on the document glass and close the document cover.

See Also:

“Making Copies From the Automatic Document Feeder (ADF)” on page 164

“Making Copies From the Document Glass” on page 162

- Press the  (**Copy**) button.
- Select **Sharpness**, and then press the  button.
- Select the desired setting, and then press the  button.

Sharpest	Makes the copy sharper than the source document.
Sharper	
Normal*	Keeps the sharpness of the source document as it is.

Softer	Makes the copy softer than the source document.
Softest	

* Factory default menu setting

- If necessary, customize other copy options including the number of copies, copy size, and image quality.

See Also:

“Customizing Copy Options” on page 165

- Press the  (**Start**) button to begin copying.

Auto Exposure



You can suppress the background of the source document to enhance text on the copy.

- Load a document(s) face up on the Automatic Document Feeder (ADF) with the top edge going in first; or place a single document face down on the document glass and close the document cover.

See Also:

“Making Copies From the Automatic Document Feeder (ADF)” on page 164

“Making Copies From the Document Glass” on page 162

- Press the  (**Copy**) button.
- Select **Auto Exposure**, and then press the  button.
- Select **On**, and then press the  button.
- If necessary, customize other copy options including the number of copies, copy size, and image quality.

See Also:

“Customizing Copy Options” on page 165

- Press the  (**Start**) button to begin copying.

2-Sided



You can make duplex (2-sided) copies with the specified binding position.

1. Load multiple documents face up on the Automatic Document Feeder (ADF) with the top edge going in first; or place a single document face down on the document glass and close the document cover.

See Also:

“Making Copies From the Automatic Document Feeder (ADF)” on page 164

“Making Copies From the Document Glass” on page 162

2. Press the  (**Copy**) button.
3. Select 2-Sided, and then press the  button.
4. Select the desired binding position, and then press the  button.

1->1-Sided*	Makes regular single-sided copies.
Flip on Long Edge	Makes duplex (2-sided) copies ready to be bound on the long edge.
Flip on Short Edge	Makes duplex (2-sided) copies ready to be bound on the short edge.

* Factory default menu setting

5. If necessary, customize other copy options including the number of copies, copy size, and image quality.

See Also:

“Customizing Copy Options” on page 165

6. Press the  (**Start**) button to begin copying.

Multiple Up

You can print two original images to fit onto one sheet of paper.

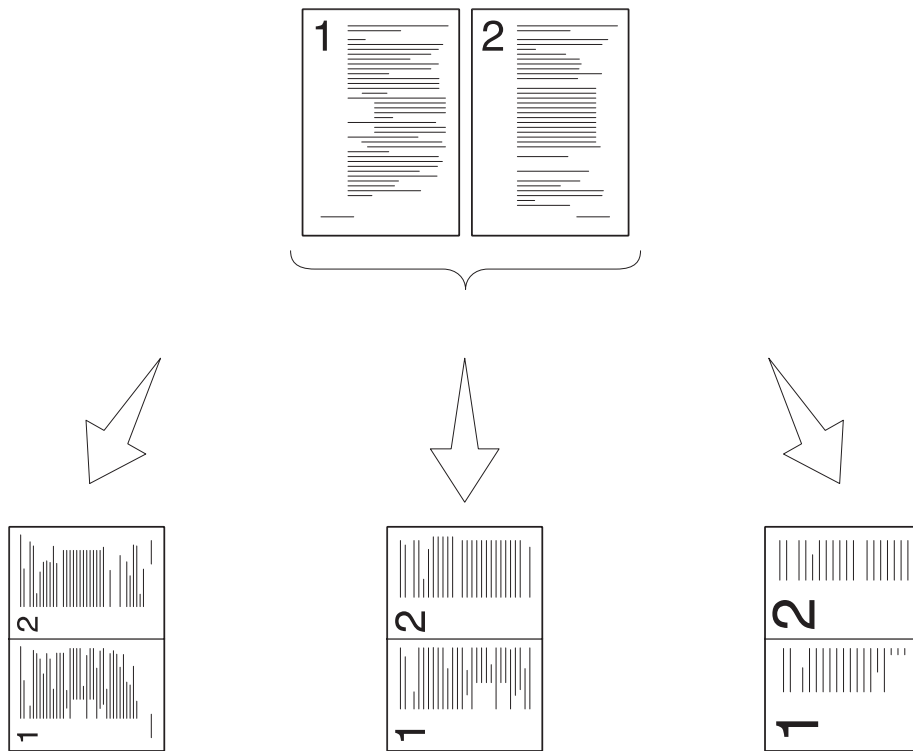
**Auto:**

Automatically reduces the size of the source documents to print all of them on a single sheet of paper.

ID Card Copy:

Prints both sides of the ID card on a single sheet of paper in the original size.

Manual:

Reduces the size of the source documents according to the Reduce/Enlarge setting and print all of them on a single sheet of paper.

1. Load multiple documents face up on the Automatic Document Feeder (ADF) with the top edge going in first; or place a single document face down on the document glass and close the document cover.

See Also:

- “Making Copies From the Automatic Document Feeder (ADF)” on page 164
- “Making Copies From the Document Glass” on page 162

2. Press the  (**Copy**) button.

3. Select **Multiple UP**, and then press the **OK** button.
4. Select the desired setting, and then press the **OK** button.

Off*	Makes regular one-to-one copies of the source documents.
Auto	Automatically reduces the size of the source documents to print all of them on a single sheet of paper.
ID Card Copy	Prints both sides of the ID card on a single sheet of paper in the original size.
Manual	Reduces the size of the source documents according to the Reduce/Enlarge setting and print all of them on a single sheet of paper.

* Factory default menu setting

5. If necessary, customize other copy options including the number of copies, copy size (only for **Off** or **Manual**), and image quality.

See Also:

“Customizing Copy Options” on page 165

6. Press the **Start** button to begin copying.

When you are using the document glass and **Multiple UP** is set to **Auto**, **ID Card Copy**, or **Manual**, the LCD panel displays a prompt for another page. Select **Yes** or **No**, and then press the **OK** button.

If you have selected **Yes**, select **Continue** or **Cancel**, and then press the **OK** button.

Margin Top/Bottom

You can specify the top and bottom margins of the copy.





1. Load a document(s) face up on the Automatic Document Feeder (ADF) with the top edge going in first; or place a single document face down on the document glass and close the document cover.

See Also:

“Making Copies From the Automatic Document Feeder (ADF)” on page 164

“Making Copies From the Document Glass” on page 162

2. Press the **Copy** button.

3. Select Margin Top/Bottom, and then press the  button.
4. Press the  or  button or enter the desired value using the numeric keypad, and then press the  button.

4mm*/0.2inch*	Specify the value in increments of 1 mm/0.1 inch. Which factory default menu setting displays depends on the value selected for mm / inch under the System Settings menu. See "mm / inch" on page 294 for more information.
0 - 50mm/0.0 - 2.0inch	

* Factory default menu setting

5. If necessary, customize other copy options including the number of copies, copy size, and image quality.

See Also:

"Customizing Copy Options" on page 165

6. Press the  (**Start**) button to begin copying.

Margin Left/Right





You can specify the left and right margins of the copy.

1. Load a document(s) face up on the Automatic Document Feeder (ADF) with the top edge going in first; or place a single document face down on the document glass and close the document cover.

See Also:

"Making Copies From the Automatic Document Feeder (ADF)" on page 164

"Making Copies From the Document Glass" on page 162

2. Press the  (**Copy**) button.
3. Select Margin Left/Right, and then press the  button.
4. Press the  or  button or enter the desired value using the numeric keypad, and then press the  button.

4mm*/0.2inch*	Specify the value in increments of 1 mm/0.1 inch. Which factory default menu setting displays depends on the value selected for mm / inch under the System Settings menu. See "mm / inch" on page 294 for more information.
0 - 50mm/0.0 - 2.0inch	

* Factory default menu setting

- If necessary, customize other copy options including the number of copies, copy size, and image quality.

See Also:

"Customizing Copy Options" on page 165

- Press the  (**Start**) button to begin copying.

Margin Middle





You can specify the middle margin of the copy.

- Load a document(s) face up on the Automatic Document Feeder (ADF) with the top edge going in first; or place a single document face down on the document glass and close the document cover.

See Also:

"Making Copies From the Automatic Document Feeder (ADF)" on page 164

"Making Copies From the Document Glass" on page 162

- Press the  (**Copy**) button.
- Select Margin Middle, and then press the  button.
- Press the  or  button or enter the desired value using the numeric keypad, and then press the  button.

0mm*/0.0inch*	Specify the value in increments of 1 mm/0.1 inch. Which factory default menu setting displays depends on the value selected for mm / inch under the System Settings menu. See "mm / inch" on page 294 for more information.
0 - 50mm/0.0 - 2.0inch	

* Factory default menu setting

- If necessary, customize other copy options including the number of copies, copy size, and image quality.

See Also:

“Customizing Copy Options” on page 165

6. Press the  (**Start**) button to begin copying.

Copying an ID Card

You can copy both sides of an ID card on one side of a single sheet of paper in its original size by selecting ID Card Copy on the operator panel.



Note:

If the Service Lock setting for Copy is set to Password Locked, you need to enter the four digit password to use the copy function. If the Service Lock setting for Copy is set to Locked, the copy function is disabled and the menu is not displayed on the LCD panel. For more information, see “Service Lock” on page 301.

1. Place the front side of an ID card face down on the document glass and close the document cover.

See Also:

“Making Copies From the Document Glass” on page 162

2. Press the  (**Copy**) button.
3. Select Multiple UP, and then press the  button.
4. Select ID Card Copy, and then press the  button.
5. If necessary, customize other copy options including the image quality.

See Also:

“Customizing Copy Options” on page 165





6. Press the  (**Start**) button to begin copying.

When the scanning completes, the LCD panel prompts you for another page. Select Yes or No, and then press the  button.

7. When Yes is selected, turn over the ID card, select Continue, and then press the  button to begin copying the other side.

Changing the Default Copy Settings

You can customize the default copy settings using the menu items that you use most frequently.

1. Press the **System** button.
2. Select `Defaults Settings`, and then press the  button.
3. Select `Copy Defaults`, and then press the  button.
4. Select the desired menu item, and then press the  button.
5. Select the desired setting or enter the value using the numeric keypad, and then press the  button.
6. Repeat steps 4 and 5, as needed.
7. To quit changing the default settings, keep pressing the  (**Back**) button until the LCD panel shows `Select Function`.

Chapter 7

Scanning

Scanning Overview

Note:

If the Service Lock setting for Scan is set to Password Locked, you need to enter the four digit password to use the scan function. If the Service Lock setting is set to Locked, the scan function is disabled and the menu is not displayed on the LCD panel. For more information, see "Service Lock" on page 301.

You can use your printer to turn pictures and text into editable images on your computer.

The resolution setting for scanning depends on the scan source type and how you plan to use the scanned image or document on your computer. For the best results, use these recommended settings.

Scan Source Type	Resolution
Documents	300 dpi black-and-white or 200 dpi grayscale or color
Documents of poor quality or that contain small text	400 dpi black-and-white or 300 dpi grayscale
Photographs and pictures	100-200 dpi color or 200 dpi grayscale
Images for an inkjet printer	150-300 dpi
Images for a high-resolution printer	300-600 dpi

Scanning beyond these recommended resolutions may exceed the capabilities of the application. If you require a resolution above those recommended in the above table, you should reduce the size of the image by previewing (or pre-scanning) and cropping before scanning the image.

Scanning to a USB Connected Computer

You can connect your printer to a computer with a USB cable and use the printer as a scanner.



Using the Operator Panel

The following procedure uses Windows 7 as an example.

Note:

- Ensure that the printer is connected to the computer with a USB cable.
 - You must use the Express Scan Manager on your computer to specify the location to send scanned image files.
1. Load a document(s) face up on the Automatic Document Feeder (ADF) with the top edge going in first; or place a single document face down on the document glass and close the document cover.

See Also:

- “Making Copies From the Automatic Document Feeder (ADF)” on page 164
 - “Making Copies From the Document Glass” on page 162
2. Press the  (**Scan**) button.
 3. Select Scan to Computer(USB), and then press the  button.
 4. If necessary, customize scan options.
 5. Press the  (**Start**) button.

A scanned image file is generated.

Note:

If a dialog box to select a program appears on your computer, select **Express Scan Manager-Btype**, and then click **OK**. Once you select the **Always use this program for this action** check box when selecting **Express Scan Manager-Btype**, the selected application is automatically used without displaying the program selection window.

See Also:

“Express Scan Manager” on page 37

Using the TWAIN Driver

Your printer supports the Tool Without An Interesting Name (TWAIN) driver for scanning images. TWAIN is one of the standard components provided with Microsoft® Windows® XP, Windows Server® 2003, Windows Server 2008, Windows Server 2008 R2, Windows Vista®, Windows 7, and Mac OS® X 10.5/10.6, and works with various scanners. The following procedure uses Windows 7 as an example.

Note:

- ❑ *Ensure that the printer is connected to the computer with a USB cable.*
- ❑ *When using the printer as a network printer, you can also scan document(s) via a network instead of using the USB cable.*

The following procedure to scan an image uses the Microsoft Clip Organizer on Windows 7 as an example.

1. Load a document(s) face up on the Automatic Document Feeder (ADF) with the top edge going in first; or place a single document face down on the document glass and close the document cover.

See Also:

- ❑ *“Making Copies From the Automatic Document Feeder (ADF)” on page 164*
 - ❑ *“Making Copies From the Document Glass” on page 162*
2. Click **Start — All Programs — Microsoft Office — Microsoft Office 2010 Tools — Microsoft Clip Organizer**.
 3. Click **File — Add Clips to Organizer — From Scanner or Camera**.
 4. In the **Insert Picture from Scanner or Camera** dialog box, under **Device**, select your TWAIN device.
 5. Click **Custom Insert**.
 6. Select your scanning preferences and click **Preview** to display the preview image.

Note:

Preview is grayed out and disabled when you select **Document Feeder Tray** from **Scan From**.

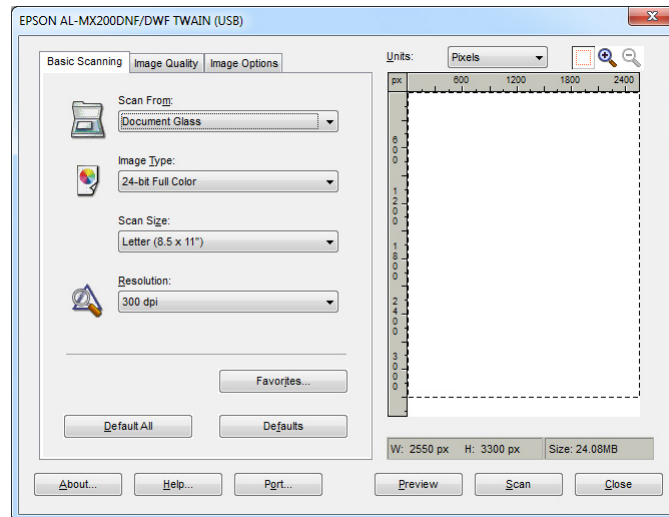

7. Select the desired properties from the **Image Quality** and **Image Options** tabs.
8. Click **Scan** to start scanning.

A scanned image file is generated.

Using the WIA Driver

Your printer also supports the Windows Image Acquisition (WIA) driver for scanning images. WIA is one of the standard components provided with Windows XP and later operating systems and works with digital cameras and scanners. Unlike the TWAIN driver, the WIA driver allows you to scan an image and easily manipulate it without using additional software.

The following procedure uses Windows 7 as an example.

Note:

Ensure that the printer is connected to the computer using the USB cable.

1. Load a document(s) face up on the Automatic Document Feeder (ADF) with the top edge going in first; or place a single document face down on the document glass and close the document cover.

See Also:

- ❑ “Making Copies From the Automatic Document Feeder (ADF)” on page 164

❑ “Making Copies From the Document Glass” on page 162

2. Start the drawing software, such as the Paint.

Note:

On Windows Vista, use the Windows Photo Gallery instead of the Paint.

3. Click the **Paint** button — **From scanner or camera**.

The WIA window appears.

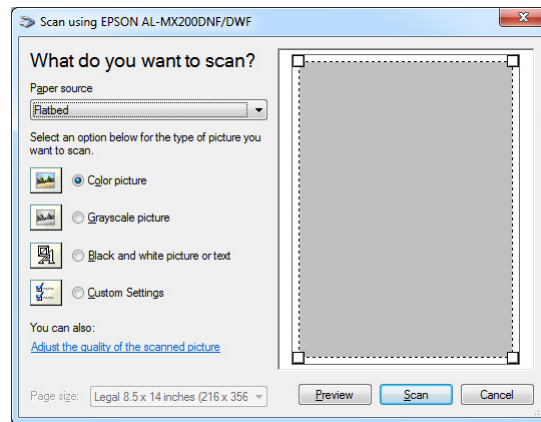

4. Select your scanning preferences and click **Adjust the quality of the scanned picture** to display the **Advanced Properties** dialog box.
5. Select the desired properties including brightness and contrast, and then click **OK**.
6. Click **Scan** to start scanning.
7. Click the **Paint** button — **Save as**.
8. Enter a picture name, and select a file format and destination to save the picture.

Using a Scanner on the Network

You can connect your printer to a network and use the Scan to Network feature of the computer for scanning.

Overview

The Scan to Server/Scan to Computer feature allows you to scan documents on the printer and send the scanned documents to a network computer using the FTP or SMB protocol.

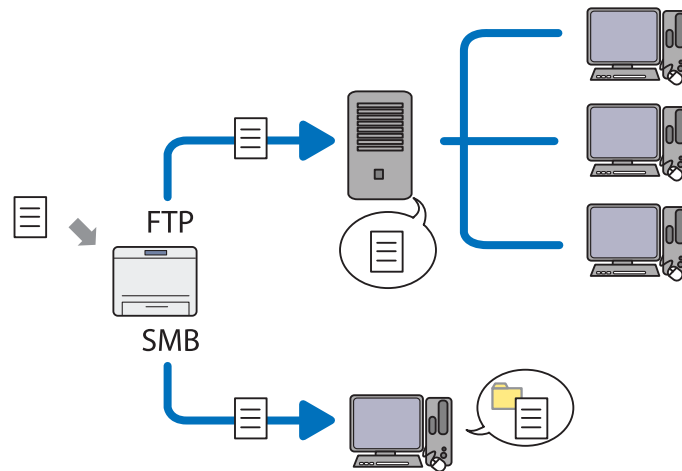

When using the FTP protocol, you need to select a server and specify a destination to store scanned document using EpsonNet Config or Address Book Editor.

The following is required to use the Scan to Server/Computer feature.

Using the SMB

Your computer must run on one of the following operating systems and have the folder sharing enabled.

For Mac OS X, a shared user account is required on the Mac OS X.

- Windows Server 2003
- Windows Server 2008
- Windows Server 2008 R2
- Windows XP
- Windows Vista
- Windows 7
- Mac OS X 10.5/10.6/10.7

Using the FTP

One of the following FTP servers and an account to the FTP server (login name and password) are required.

- Windows Server 2003, Windows Server 2008, Windows Server 2008 R2, Windows Vista, or Windows 7

FTP service of Microsoft Internet Information Services 6.0

- Windows XP

FTP service of Microsoft Internet Information Server 3.0/4.0 or Internet Information Services 5.0/5.1

- Mac OS X

FTP service of Mac OS X 10.5.8 - 10.6, 10.7

For information on how to configure the FTP service, contact your system administrator.

Follow the procedure below to use the Scan to Network feature.

“Confirming the Login name and the Password” on page 189



“Specifying a Destination to Store Scanned Documents” on page 191



“Configuring the Printer” on page 202



“Sending the Scanned File to the Network” on page 209

Confirming the Login name and the Password

When Using the SMB

The Scan to Server/Scan to Computer feature requires a user login account with a valid and non-empty password for authentication. Confirm the login user name and the password.

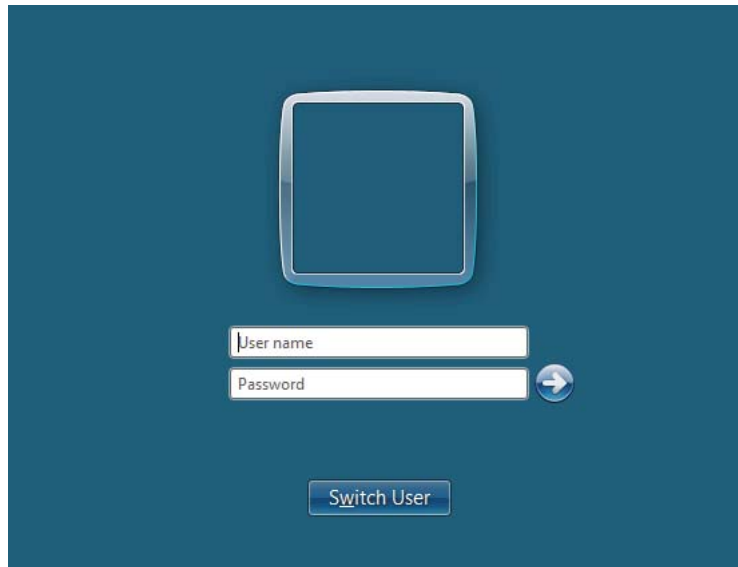

If you do not use a password for your user login, you need to create a password for your user login account with the following procedure.

For Windows XP:

1. Click **start** — **Control Panel** — **User Accounts**.
2. Click **Change an account**.
3. Select your account.
4. Click **Create a password** and add in a password for your user login account.

For Windows Server 2003:

1. Click **Start** — **Administrative Tools** — **Computer Management**.
2. Click **Local Users and Groups**.

3. Double-click **Users**.
4. Right-click your account, and then select **Set Password**.

Note:

*When an alert message appears, confirm the message and then click **Proceed**.*

5. Add in a password for your user login account.

For Windows Vista and Windows 7:

1. Click **Start — Control Panel**.
2. Click **User Accounts and Family Safety**.
3. Click **User Accounts**.
4. Click **Create a password for your account** and add in a password for your user login account.

For Windows Server 2008 and Windows Server 2008 R2:

1. Click **Start — Control Panel**.
2. Click **User Accounts**.
3. Click **User Accounts**.
4. Click **Create a password for your account** and add in a password for your user login account.

For Mac OS X 10.5/10.6/10.7

1. Click **System Preferences — Accounts (Users & Groups for Mac OS X 10.7)**.
2. Select your account.
3. Select **Change Password**.
4. Enter a password for your user login account in **New password (New Password for Mac OS X 10.5)**.
5. Re-enter the password in **Verify**.
6. Click **Change Password**.

After you confirmed a login user name and password, go to “Specifying a Destination to Store Scanned Documents” on page 191.

When Using the FTP

The Scan to Server/Scan to Computer feature requires a user name and a password. For your user name and password, contact your system administrator.

Specifying a Destination to Store Scanned Documents

When Using the SMB

Set up a shared folder to store the scanned document using the following procedure.

For Windows XP Home Edition:

1. Create a folder in the desired directory on your computer (Example of folder name, **MyShare**).
2. Right-click the folder, and then select **Properties**.
3. Click the **Sharing** tab, and then select **Share this folder on the network**.
4. Enter a shared name in the **Share name** box.

Note:

- ❑ Write down this shared name because you will use this name in the next setting procedure.

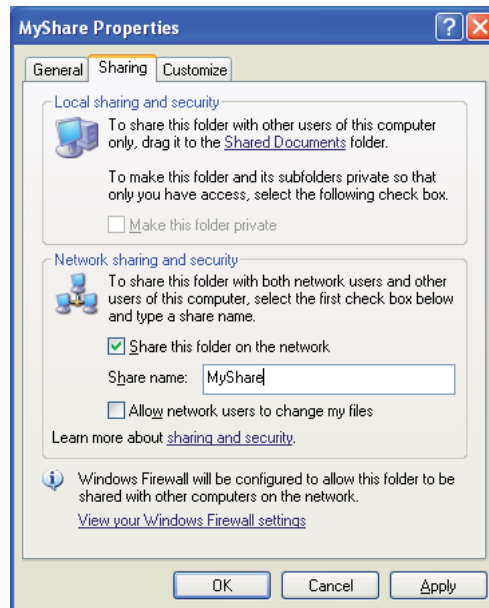

- When the following screen appears, click **If you understand the security risks but want to share files without running the wizard, click here**, then select **Just enable file sharing**, and then click **OK**.

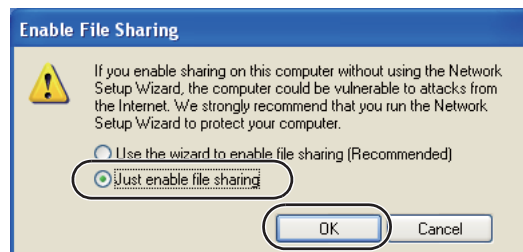
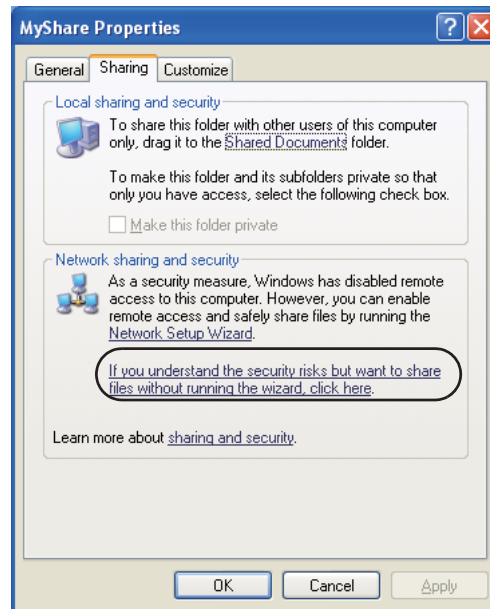

5. Select **Allow network users to change my files**.
6. Click **Apply**, and then click **OK**.

Note:

To add sub-folders, create new folders in the shared folder you have created.

Example: Folder name, **MyShare**, Second-level folder name: **MyPic**, Third-level folder name: **John**

You should now see **MyShare\MyPic\John** in your directory

When you are finished with creating the shared folder, go to “Configuring the Printer” on page 202.

For Windows XP Professional Edition:

1. Create a folder in the desired directory on your computer (Example of folder name, **MyShare**) and double-click the folder.
2. Select **Folder Options** from **Tools**.

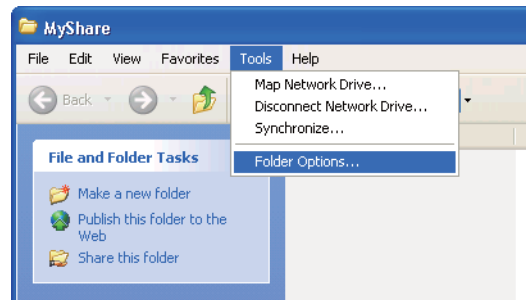

3. Click **View** tab, and then deselect the **Use simple file sharing (Recommended)** check box.

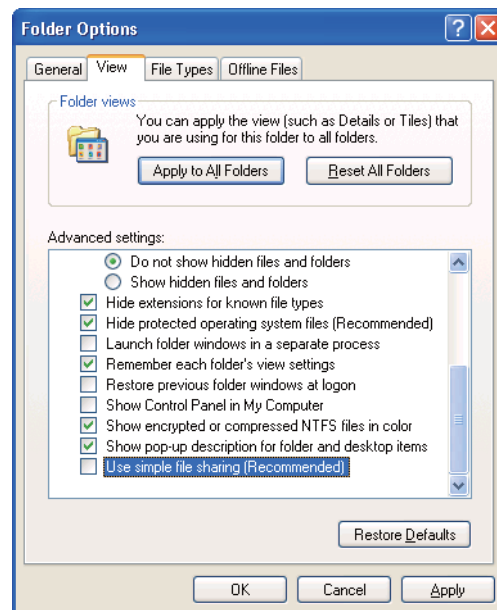

4. Click **OK**, and then close the window.
5. Right-click the folder, and then select **Properties**.
6. Select the **Sharing** tab, and then select **Share this folder**.
7. Enter a shared name in the **Share name** box.

Note:

Write down this shared name because you will use this name in the next setting procedure.

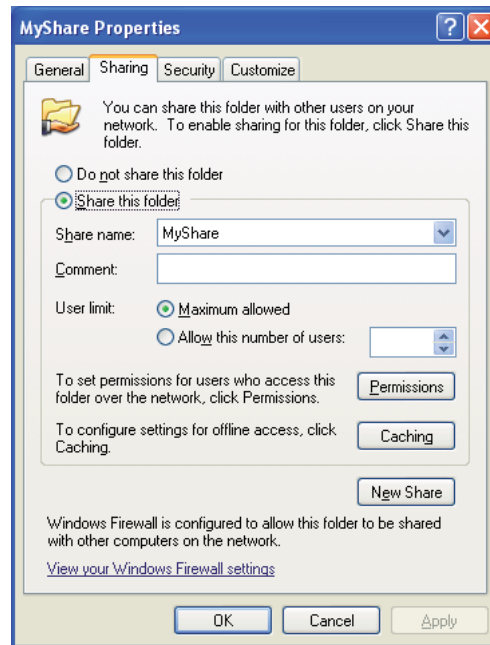

8. Click **Permissions** to create a write permission for this folder.
9. Click **Add**.
10. Search user login name by clicking **Advanced**, or enter the user login name in the **Enter the object names to select** box and click **Check Names** to confirm (Example of user login name, **MySelf**).

Note:

Do not use **Everyone** as the user login name.

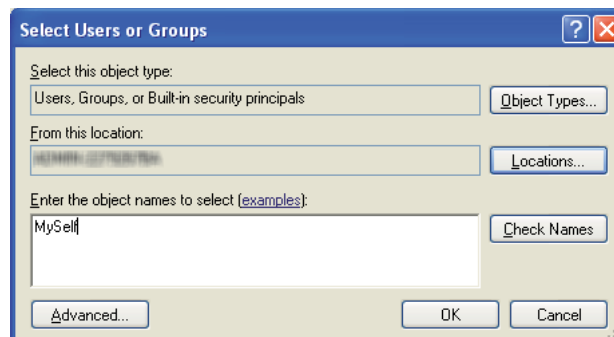

11. Click **OK**.
12. Click the user login name that you have just entered. Select the **Full Control** check box. This will grant you permission to send the document into this folder.

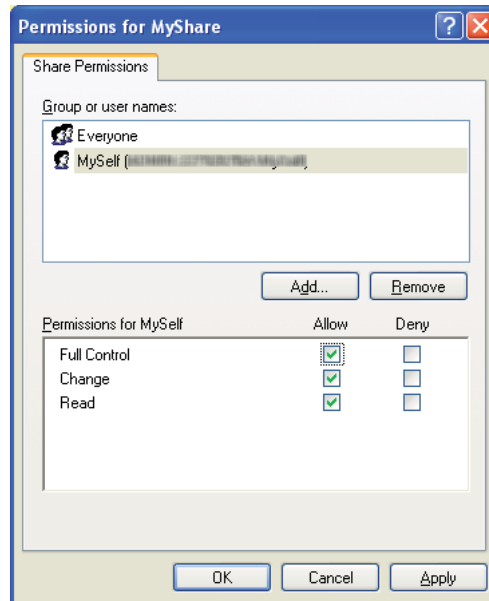

13. Click **OK**.
14. Click **Apply**, and then click **OK**.

Note:

To add sub-folders, create new folders in the shared folder you have created.

Example: Folder name: **MyShare**, Second-level folder name: **MyPic**, Third-level folder name: **John**

You should now see **MyShare\MyPic\John** in your directory.

When you are finished with creating the shared folder, go to “Configuring the Printer” on page 202.

For Windows Server 2003

1. Create a folder in the desired directory on your computer (Example of folder name, **MyShare**).
2. Right-click the folder, and then select **Properties**.
3. Click the **Sharing** tab, and then select the **Share this folder**.

4. Enter a shared name in the **Share name** box.

Note:

Note down the shared name as you need to use this name in the next setting procedure.

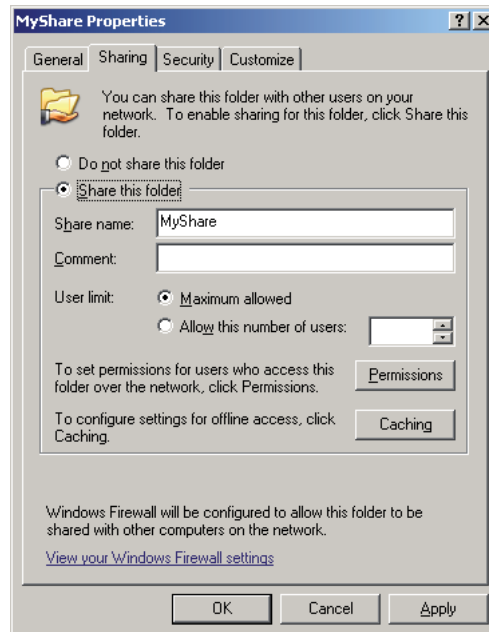

5. Click **Permissions** to give write permission for this folder.
6. Click **Add**.
7. Search user login name by clicking **Advanced**, or enter the user login name in the **Enter the object names to select** box and click **Check Names** to confirm (Example of user login name, **MySelf**).

Note:
Do not use **Everyone** as the user login name.

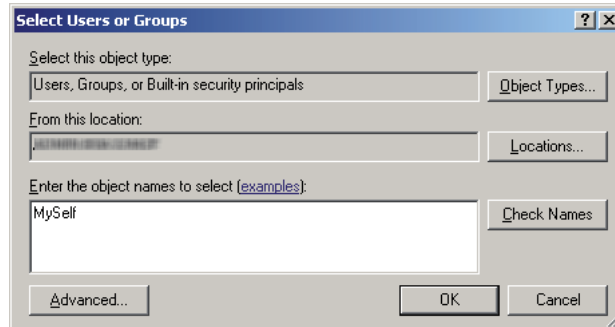

8. Click **OK**.
9. Click the user login name that you have just entered. Select the **Full Control** check box. This will grant you permission to send the document to this folder.

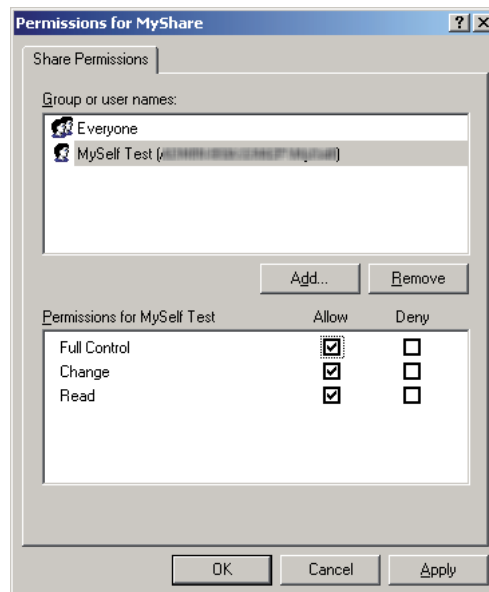

10. Click **OK**.
11. Specify other settings as necessary, and then click **Apply** and click **OK**.

Note:

To add sub-folders, create new folders in the shared folder you have created.

Example: Folder name: **MyShare**, Second-level folder name: **MyPic**, Third-level folder name: **John**

You should now see **MyShare\MyPic\John** in your directory.

When you are finished with creating the shared folder, go to “Configuring the Printer” on page 202.

For Windows Vista, Windows 7, Windows Server 2008, Windows Server 2008 R2

1. Create a folder in the desired directory on your computer (Example of folder name, **MyShare**).
2. Right-click the folder, and then select **Properties**.
3. Click the **Sharing** tab, and then select **Advanced Sharing**.

When **User Account Control** dialog box appears, click **Continue** (Yes for Windows 7).

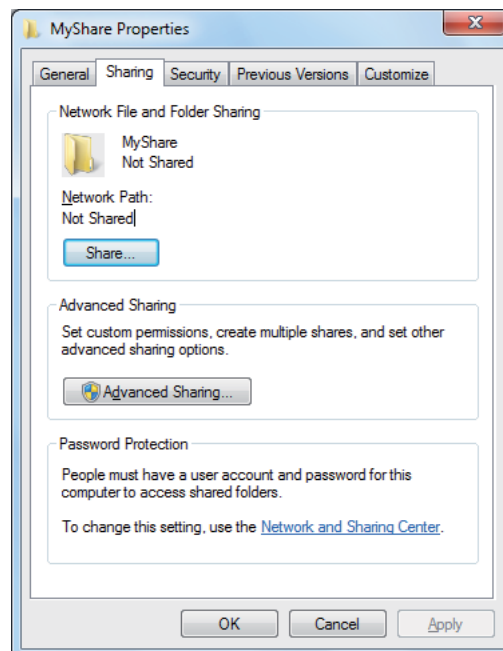

4. Select the **Share this folder** check box.
5. Enter a shared name in the **Share name** box.

Note:

Note down the shared name as you need to use this name in the next setting procedure.

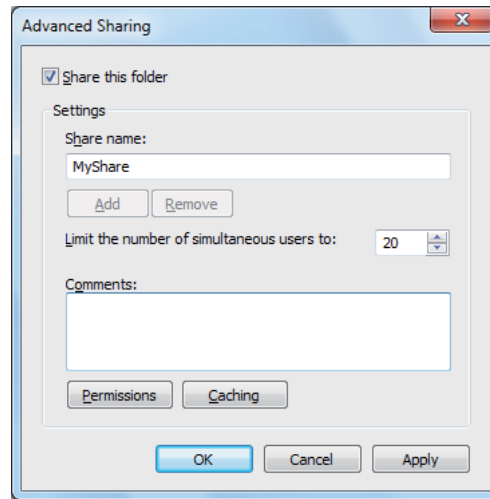

6. Click **Permissions** to give write permission for this folder.
7. Click **Add**.
8. Search user login name by clicking **Advanced**, or enter the user login name in the **Enter the object names to select** box and click **Check Names** to confirm (Example of user login name, **MySelf**).

Note:

Do not use **Everyone** as the user login name.

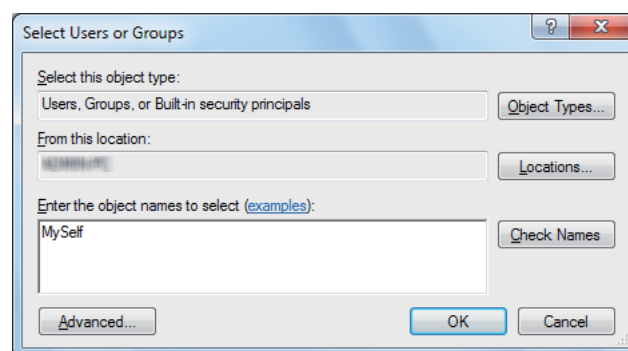

9. Click **OK**.

10. Click the user login name that you have just entered. Select the **Full Control** check box. This will grant you permission to send the document to this folder.

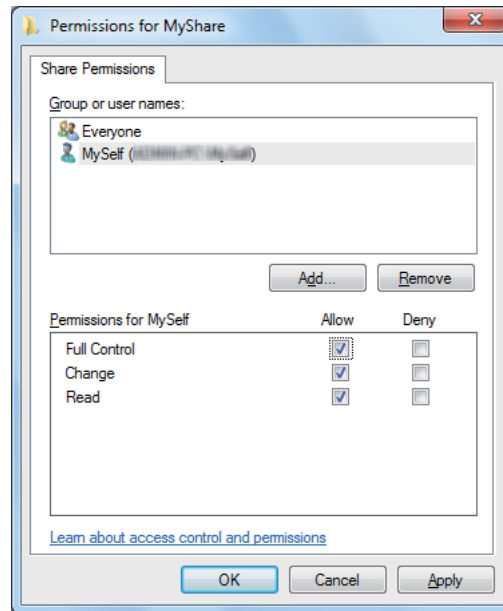

11. Click **OK**.
12. Click **OK** to exit the **Advanced Sharing** dialog box.
13. Click **Close**.

Note:

To add sub-folders, create new folders in the shared folder you have created.

Example: Folder name: **MyShare**, Second-level folder name: **MyPic**, Third-level folder name: **John**

You should now see **MyShare\MyPic\John** in your directory.

When you are finished with creating the shared folder, go to “Configuring the Printer” on page 202.

For Mac OS X 10.5/10.6/10.7:

1. Create a folder in the desired directory on your computer (Example of folder name, **MyShare**).

Note:

Note down the folder name as you need to use this name in the next setting procedure.

2. Select the created folder, and then select **Get Info** from the **File** menu.

3. Select the **Shared folder (Shared Folder for Mac OS X 10.5)** check box.
4. Open **Sharing & Permissions**.
5. Click the plus (+) sign.
6. Specify an account you want to share, and then click **Select**.
7. Set the **Privilege** of the account to **Read & Write**.
8. Repeat steps 5 to 7 as needed, and then close the window.
9. Open **System Preferences**, and then click **Sharing**.
10. Select the **File Sharing** check box, and then click **Options**.
11. Select the **Share files and folders using SMB (Windows) (Share files and folders using SMB for Mac OS X 10.5)** check box and your account name.
12. Enter your account password, and then click **OK**.
13. Click **Done**.

When Using the FTP

Set up a destination to store the scanned document using the EpsonNet Config. To set up a destination using EpsonNet Config, see “Using EpsonNet Config” on page 202

Configuring the Printer

You can configure the printer to use the Scan to Server/Computer feature with EpsonNet Config or Address Book Editor.

The following procedure uses Windows 7 as an example.

Using EpsonNet Config

1. Launch your web browser.
2. Enter the IP address of the printer in the address bar, and then press the **Enter** key.

EpsonNet Config appears on your browser.

Note:

For details on how to check the IP address of the printer, see “Verifying the IP Settings” on page 47.

3. Click the **Address Book** tab.

If a user name and password entry is prompted, enter the correct user name and password.

Note:

The default User ID and password are both blank (NULL).

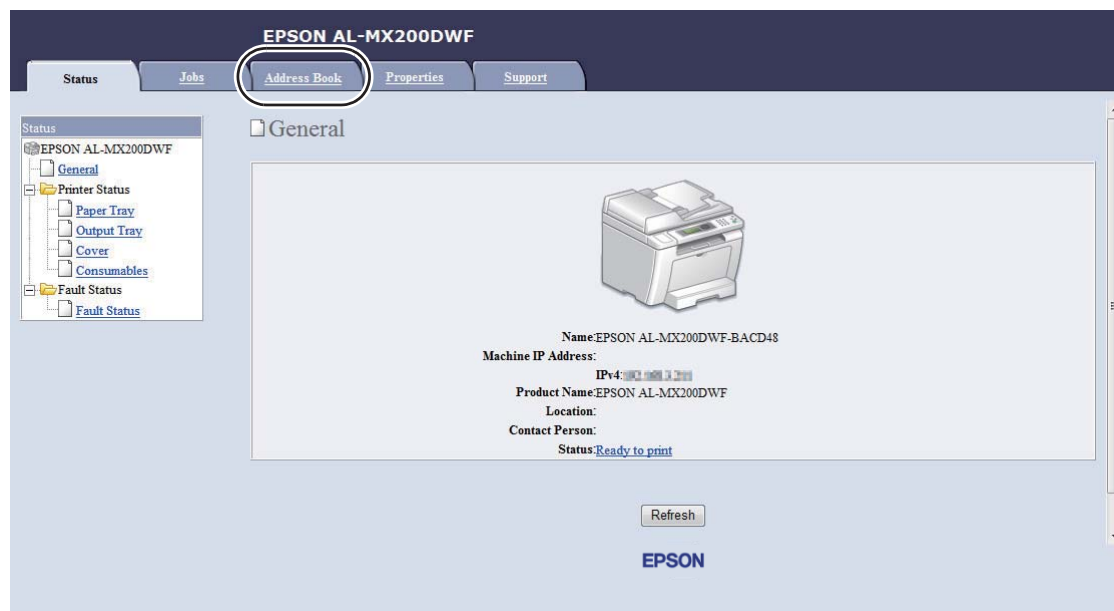

4. Under **Network Scan (Comp./Serv.)**, click **Computer/Server Address Book**.

5. Select any unused number and click **Add**.

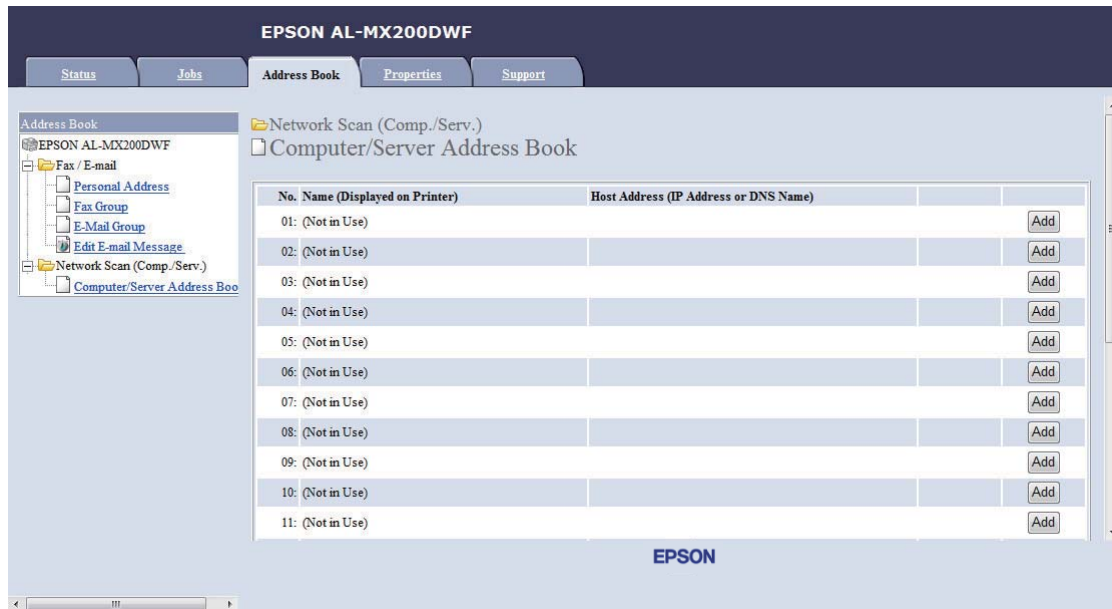

The **Add Network Scan Address** page appears.

No.	01
1— Name (Displayed on Printer)	<input type="text"/>
2— Network Type	* Sever FTP <input type="button" value="v"/>
3— Host Address (IP Address or DNS Name)	<input type="text"/>
4— Port Number	<input type="text"/> FTP(21, 5000 - 65535), SMB(139, 5000 - 65535)
5— Login Name (if required by host)	<input type="text"/>
6— Login Password	<input type="text"/>
7— Re-enter Password	<input type="text"/>
8— Name of Shared Directory	<input type="text"/>
	e.g. SMB(Share, Sharedfolder)
9— Subdirectory Path (optional)	<input type="text"/>

To fill in the fields, enter the information as follows:

1	Name (Displayed on Printer)	Enter a friendly name that you want it to appear on the Address Book.
---	------------------------------------	---

2	Network Type	Select Server FTP to use a FTP server. Select Computer SMB to store scanned documents in a shared folder on your computer.
3	Host Address (IP Address or DNS Name)	Enter the name or IP address of the FTP server or your computer. The following are examples: <input type="checkbox"/> For Server FTP : Server name: myhost.example.com (myhost: host name, example.com: domain name) IP address: 192.168.1.100 <input type="checkbox"/> For Computer SMB : Server name: myhost IP address: 192.168.1.100
4	Port Number	Enter the server port number. If you are unsure, you can enter the default value of 21 for FTP and 139 for SMB.
5	Login Name (if required by host)	Enter the user account name that has access to the shared folder on your computer or the FTP server.
6	Login Password	Enter the password for the above login name. Note: You cannot use an empty password for the Scan to Computer feature. Ensure that you have a valid password for the user login account. (See "Confirming the Login name and the Password" on page 189 for details on how to add a password for your user login account.)
7	Re-enter Password	Re-enter your password.
8	Name of Shared Directory	For Computer SMB only. Enter the name of the shared folder on your computer where you want to store scanned documents.

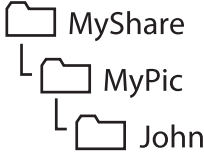
9	Subdirectory Path (optional)	<p>For Computer SMB</p> <p>To store scanned documents simply in the shared folder specified for Name of Shared Directory, leave this box blank.</p> <p>To store scanned documents in a subfolder within the shared folder, enter the path to the subfolder as shown in the example below.</p> <p>Example: Shared folder name: MyShare, Second-level folder name: MyPic, Third-level folder name: John</p> <p>You should now see MyShare\MyPic\John in your directory.</p> <div style="text-align: center;">  <pre> graph TD MS[MyShare] --- MP[MyPic] MP --- J[John] </pre> </div> <p>In this case, enter for Subdirectory Path (optional) as follows: \MyPic\John</p> <p>For Server FTP</p> <p>Enter the path to the FTP server where you want to store scanned documents.</p>
---	-------------------------------------	--

When you are finished with printer configuration, go to “Sending the Scanned File to the Network” on page 209.

Using the Address Book Editor

1. Click **Start** — **All Programs** — **EPSON** — your printer — **Address Book Editor**.

Note:

- The window to select a device appears when multiple fax drivers are installed on your computer. In this case, click the name of the desired printer listed in **Device Name**.*
 - The **Enter Password** window appears when Panel Lock Set is set to Enable. In this case, enter the password you specified, and click **OK**.*
2. Click **OK** on the “Retrieval Successful” message window.

3. Click **Tool — New (Device Address Book) — Server**.

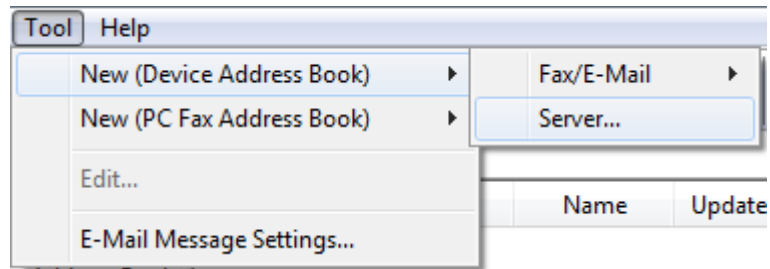

The **Server Address** dialog box appears.

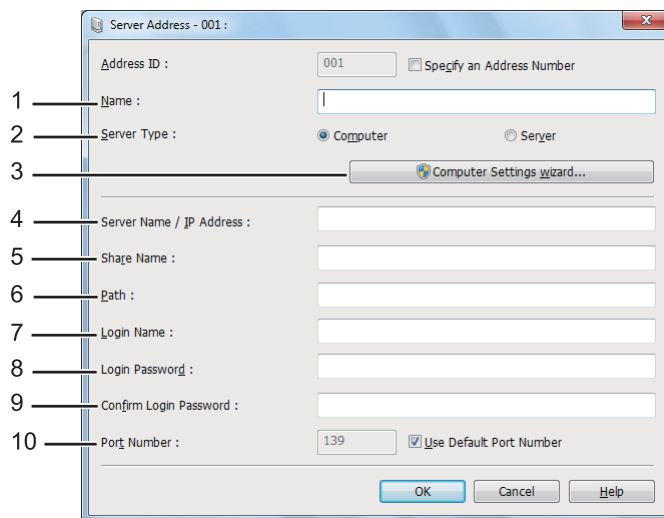

To fill in the fields, enter the information as follows:

1	Name	Enter a friendly name that you want it to appear on the Address Book.
2	Server Type	Select Computer to store scanned documents in a shared folder on your computer. Select Server to use a FTP server.
3	Computer Settings wizard	For Computer only. Clicking this button opens the wizard screen which guides you through several steps. When you complete the steps in the wizard, the settings for Server Address are automatically configured. For more information, click the Help button.

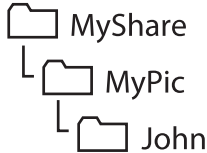
4	Server Name/IP Address	<p>Enter the name or IP address of the FTP server or your computer.</p> <p>The following are examples:</p> <ul style="list-style-type: none"> <input type="checkbox"/> For Computer: Server name: myhost IP address: 192.168.1.100 <input type="checkbox"/> For Server: Server name: myhost.example.com (myhost: host name, example.com: domain name) IP address: 192.168.1.100
5	Share Name	<p>For Computer only.</p> <p>Enter the name of the shared folder on your computer.</p>
6	Path	<p>For Computer</p> <p>To store scanned documents simply in the shared folder specified for Share Name, leave this box blank.</p> <p>To store scanned documents in a subfolder within the shared folder, enter the path to the subfolder as shown in the example below.</p> <p>Example: Shared folder name: MyShare, Second-level folder name: MyPic, Third-level folder name: John</p> <p>You should now see MyShare\MyPic\John in your directory.</p> <div style="text-align: center;">  </div> <p>In this case, enter for Path as follows: \MyPic\John</p> <p>For Server</p> <p>Enter the path to the FTP server where you want to store scanned documents.</p>
7	Login Name	<p>Enter the user account name that has access to the shared folder on your computer or the FTP server.</p>
8	Login Password	<p>Enter the password for the above login name.</p> <p>Note: You cannot use an empty password for the Scan to Server/Scan to Computer feature. Ensure that you have a valid password for the user login account. (See "Confirming the Login name and the Password" on page 189 for details on how to add a password for your user login account).</p>

9	Confirm Login Password	Re-enter your password.
10	Port Number	Enter the port number. If you are unsure, you can enter the default value of 139 for SMB and 21 for FTP.





When you are finished with printer configuration, go to “Sending the Scanned File to the Network” on page 209.

Sending the Scanned File to the Network

1. Load a document(s) face up on the Automatic Document Feeder (ADF) with the top edge going in first; or place a single document face down on the document glass and close the document cover.

See Also:



- “Making Copies From the Automatic Document Feeder (ADF)” on page 164
- “Making Copies From the Document Glass” on page 162

2. Press the  (**Scan**) button.
3. Select Scan to Network, and then press the  button.
4. Select Scan to, and then press the  button.
5. Select Computer (Network), Server (FTP), or Search Address Book, and then press the  button.

Computer (Network): Stores scanned documents on the computer using the SMB protocol.

Server (FTP): Stores scanned documents on the server using the FTP protocol.

Search Address Book: Select the server address registered in the Address Book.

6. Select a destination to store the scanned documents, and then press the  button.
7. If necessary, customize scan options.
8. Press the  (**Start**) button to send a file containing the scanned document(s).

Scanning to a USB Storage Device

The Scan to USB Memory feature allows you to scan documents and save the scanned data to a USB storage device. To scan documents and save them, follow the steps below:

1. Load a document(s) face up on the Automatic Document Feeder (ADF) with the top edge going in first; or place a single document face down on the document glass and close the document cover.

See Also:

❑ “Making Copies From the Automatic Document Feeder (ADF)” on page 164

❑ “Making Copies From the Document Glass” on page 162

2. Insert a USB storage device into the front USB port on your printer.

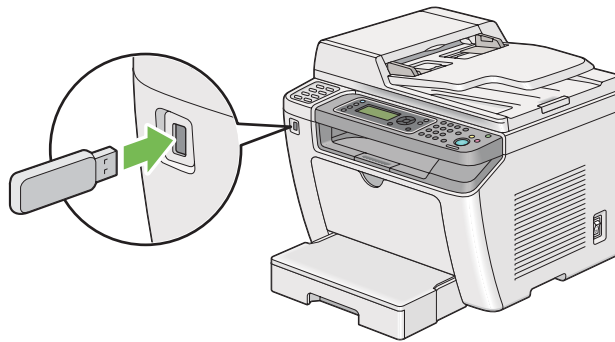

USB Memory appears.

3. Select **Scan to**, and then press the **OK** button.
4. Select **Save to USB Drive** or a folder to save a file, and then press the **OK** button.
5. Select scanning options as required.
6. Press the **Start** button.

When the scan is complete, the LCD panel displays a prompt for another page. Select **No** or **Yes**, and then press the **OK** button.

If you have selected **Yes**, select **Continue** or **Cancel**, and then press the **OK** button.

Sending an E-Mail With the Scanned Image

When sending an e-mail with the scanned image from your printer, it would be easier if you had an address book. You can create this address book with EpsonNet Config. See “Adding an Entry to the Address Book” on page 211 for more information.

Adding an Entry to the Address Book

The following procedure uses Windows 7 as an example.

1. Launch your web browser.
2. Enter the IP address of the printer in the address bar, and then press the **Enter** key.

EpsonNet Config appears on your browser.

Note:

For details on how to check the IP address of the printer, see “Verifying the IP Settings” on page 47.

3. Click the **Address Book** tab.

If a user name and password entry is prompted, enter the correct user name and password.

Note:

The default User ID and password are both blank (NULL).

4. Under **Fax / E-mail**, click **Personal Address**.



5. Select any unused number and click **Add**.

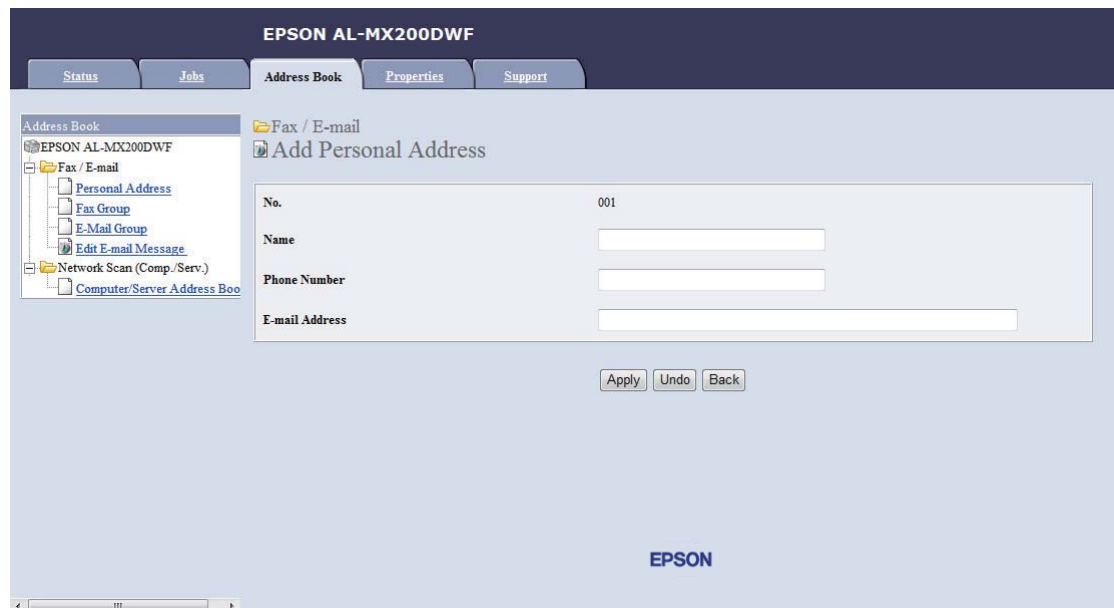

The **Add Personal Address** page appears.

6. Enter a name, a phone number, and an e-mail address in the **Name**, **Phone Number** and **E-mail Address** fields.
7. Click the **Apply** button.

Configuring an SMTP Server

To use the Scan to E-Mail feature, you first need to set up your SMTP (Simple Mail Transfer Protocol) server information. SMTP is a protocol for sending e-mail.

The following procedure uses Windows 7 as an example.

1. Launch your web browser.
2. Enter the IP address of the printer in the address bar, and then press the **Enter** key.

EpsonNet Config appears on your browser.

Note:

For details on how to check the IP address of the printer, see “Verifying the IP Settings” on page 47.

3. Click the **Properties** tab.

4. Click **Port Status**.

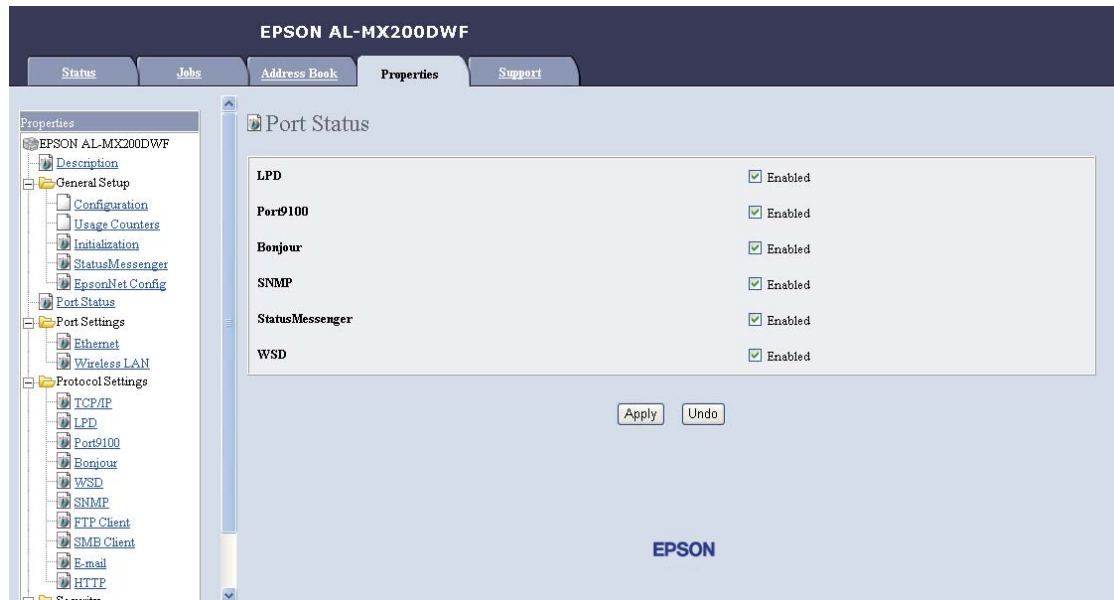

5. Ensure that the **Enabled** check box for **SNMP** is selected.

6. Under **Protocol Settings**, click **E-mail**.

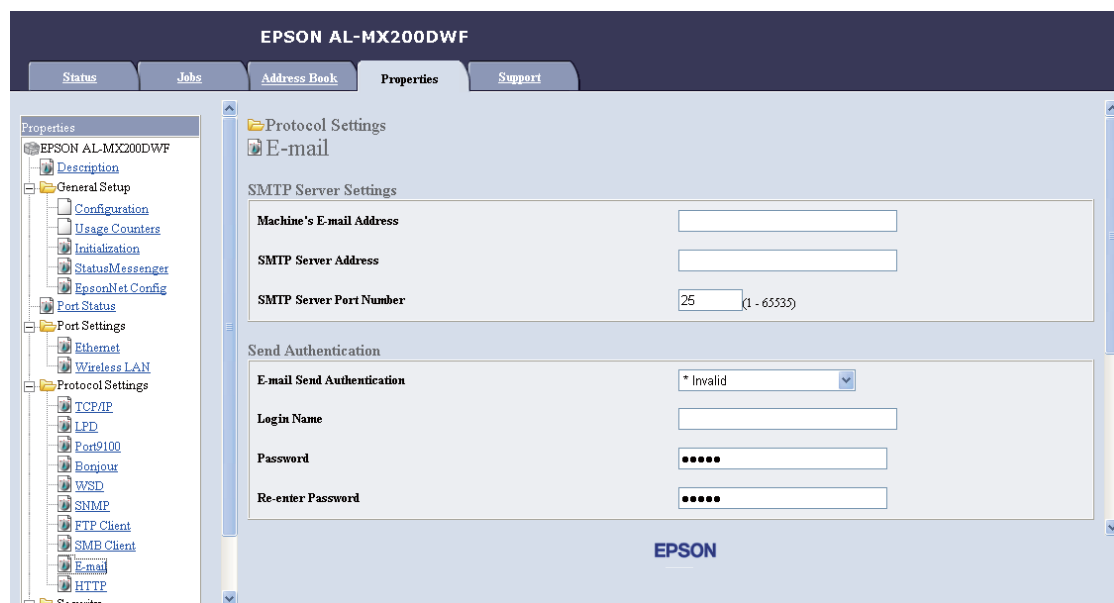

7. Enter your e-mail settings, and then click **Apply**.

Note:

❑ Depending on your environment, you may also need to set **Send Authentication**.

❑ See your system administrator to obtain your e-mail settings if necessary.





Sending an E-mail With the Scanned File

1. Load a document(s) face up on the Automatic Document Feeder (ADF) with the top edge going in first; or place a single document face down on the document glass and close the document cover.



See Also:



❑ “Making Copies From the Automatic Document Feeder (ADF)” on page 164



❑ “Making Copies From the Document Glass” on page 162

2. Press the  (**Scan**) button.
3. Select **Scan to E-Mail**, and then press the  button.
4. Select **E-Mail to**, and then press the  button.
5. Select the setting listed below, and then press the  button.

Keypad: Enter the e-mail address directly and then press the  button.

Address Book: Select the e-mail address registered in the E-mail Address Book, press the  button to select **TO** or **BCC**, and then press the  button.

E-Mail Group: Select the e-mail group registered in the E-mail Groups, press the  button to select **TO** or **BCC**, and then press the  button.

Search Address Book: Enter a text to search from the E-mail Address Book, and then press the  button. Select the e-mail address from the list, press the  button to select **TO** or **BCC**, and then press the  button.

Note:

*E-mail recipients need to be registered before you can select **Address Book** on the operator panel.*

6. Select scanning options as required.
7. Press the  (**Start**) button to send e-mail.

Customizing Scan Options

Changing the Default Scan Settings

For a complete list of all of the default settings, see “Defaults Settings” on page 304.

Setting the Scanned Image File Type

To specify the file type of the scanned image:

1. Press the **System** button.
2. Select Defaults Settings, and then press the **OK** button.
3. Select Scan Defaults, and then press the **OK** button.
4. Select File Format, and then press the **OK** button.
5. Select the type, and then press the **OK** button.

Available types:

- PDF (factory default setting)
- MultiPageTIFF
- TIFF
- JPEG

Setting the Color Mode

You can scan an image in color or in black and white. Selecting black and white significantly reduces the file size of scanned images. An image scanned in color will have a larger file size than the same image scanned in black and white.

1. Press the **System** button.
2. Select Defaults Settings, and then press the **OK** button.
3. Select Scan Defaults, and then press the **OK** button.

4. Select **Color**, and then press the **OK** button.
5. Select one of the following options, and then press the **OK** button.
 - Black & White**: Scans in black and white. This option is available only when **File Format** is set to **PDF**.
 - Grayscale**: Scans in grayscale.
 - Color**: Scans in color. (factory default setting)
 - Color(Photo)**: Scans in color. This option is suitable for photographic images.

Setting the Scan Resolution

You may want to change the scan resolution depending on the way you plan to use the scanned image. Scan resolution affects both the size and image quality of the scanned image file. The higher the scan resolution is, the larger the file size becomes.

To select the scan resolution:

1. Press the **System** button.
2. Select **Defaults Settings**, and then press the **OK** button.
3. Select **Scan Defaults**, and then press the **OK** button.
4. Select **Resolution**, and then press the **OK** button.
5. Select one of the following options, and then press the **OK** button:
 - 200 x 200dpi**: Produces the lowest resolution and smallest file size. (factory default setting)
 - 300 x 300dpi**: Produces a medium resolution and a medium file size.
 - 400 x 400dpi**: Produces a high resolution and a large file size.
 - 600 x 600dpi**: Produces the highest resolution and largest file size.

Setting the Document Size

To specify the size of a source document:

1. Press the **System** button.

2. Select **Defaults Settings**, and then press the **OK** button.
3. Select **Scan Defaults**, and then press the **OK** button.
4. Select **Document Size**, and then press the **OK** button.
5. Select a paper size to specify the scan area, and then press the **OK** button.

The factory default setting is A4 - 210x297mm.

Automatically Suppressing Background Variations

When scanning documents with a dark background such as newspapers, the printer automatically can detect the background and whiten it when outputting the image.

To turn on/off automatic suppression:

1. Press the **System** button.
2. Select **Defaults Settings**, and then press the **OK** button.
3. Select **Scan Defaults**, and then press the **OK** button.
4. Select **Auto Exposure**, and then press the **OK** button.
5. Select either **On** or **Off**, and then press the **OK** button.



The factory default setting is **On**.

Changing the Scan Settings for an Individual Job

Scanning to a Computer







To temporarily change a scan setting when scanning to a computer:

1. Press the **➤ (Scan)** button.
2. Select a destination to store the scanned image, and then press the **OK** button.
3. Select the desired menu item, and then press the **OK** button.

4. Select the desired setting or enter the value using the numeric keypad, and then press the  button.
5. Repeat steps 3 and 4, as needed.
6. Press the  (**Start**) button to begin scanning.

Emailing the Scanned Image

To temporarily change a scan setting when emailing the scanned image:

1. Press the  (**Scan**) button.
2. Select **Scan to E-Mail**, and then press the  button.
3. Select an e-mail recipient, and then press the  button.
4. Select the desired menu item, and then press the  button.
5. Select the desired setting or enter the value using the numeric keypad, and then press the  button.
6. Repeat steps 4 and 5, as needed.
7. Press the  (**Start**) button to begin scanning.

Chapter 8

Faxing

Connecting the Telephone Line

Note:

- ❑ *If the Service Lock setting for FAX is set to Password Locked, you need to enter the four digit password to use the fax function. If the Service Lock setting is set to Locked, the fax function is disabled and the menu is not displayed on the LCD panel. For more information, see “Service Lock” on page 301.*
 - ❑ *Do not connect your printer directly to a DSL (digital subscriber line). This may damage the printer. To use a DSL, you will need to use an appropriate DSL filter. Contact your service provider for the DSL filter.*
1. Plug one end of a telephone line cord to the wall jack connector and the other end to an active wall jack.

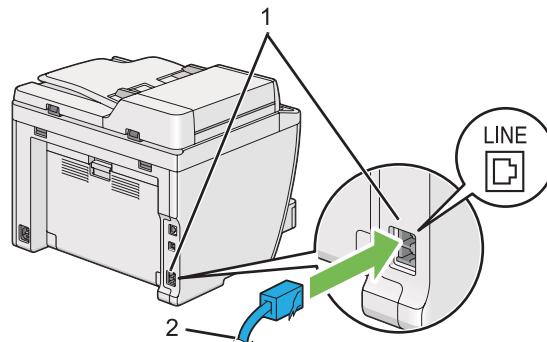

1	Wall jack connector
2	To the wall jack

Note:

The supplied telephone cord has four-contact plugs. It is recommended you use a telephone cord with four-contact plugs and a wall jack with four contacts for a telephone line connection.

- To connect a telephone and/or answering machine to your printer, plug the telephone or answering machine line cord into the phone connector (☎).

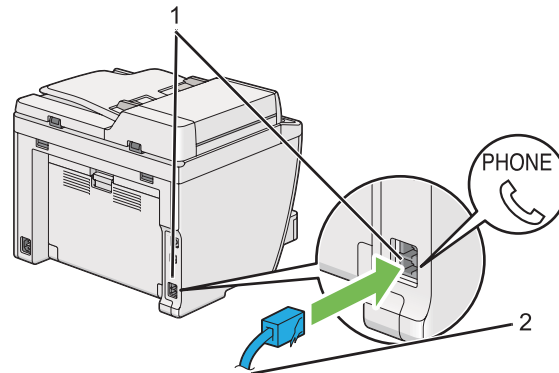

1	Phone connector
2	To an external telephone or an answering machine

Configuring Fax Initial Settings

Setting Your Region

You need to set the region where your printer is used for using the fax service on the printer.

- Press the **System** button.
- Select **Admin Menu**, and then press the **OK** button.
- Select **Fax Settings**, and then press the **OK** button.
- Select **Region**, and then press the **OK** button.
- Select the locale of the printer, and then press the **OK** button.
- When the LCD panel shows **Restart System**, select **Yes**, and then press the **OK** button.

The printer restarts to apply the setting.

Note:

Changing the **Region** setting initializes all the information specified for your printer.

Setting the Printer ID

You may be required to indicate your fax number on any fax you send. The printer ID, containing your fax number and your name or company name will be printed at the top of each page sent from your printer.

1. Press the **System** button.
2. Select **Admin Menu**, and then press the **OK** button.
3. Select **Fax Settings**, and then press the **OK** button.
4. Select **Your Fax Number**, and then press the **OK** button.
5. Enter your fax number using the numeric keypad.

Note:

If you make a mistake while entering numbers, press the **C (Clear)** button to delete the last digit.

6. Confirm the number on the LCD panel is correct, and then press the **OK** button.
7. Select **Company Name**, and then press the **OK** button.
8. Enter your name or company name using the numeric keypad.

You can enter special symbols by pressing the 1, *, and # buttons as well as alphanumeric characters.

For details on how to use the numeric keypad to enter alphanumeric characters, see “Using the Numeric Keypad” on page 325.

9. Confirm the name on the LCD panel is correct, and then press the **OK** button.
10. Press the **⏪ (Back)** button several times until the LCD panel shows **Select Function**.

Setting the Time and Date

Note:

It may be necessary to reset the time and date in case of power loss.

1. Press the **System** button.
2. Select Admin Menu, and then press the **OK** button.
3. Select System Settings, and then press the **OK** button.
4. Select Clock Settings, and then press the **OK** button.
5. Select Set Date, and then press the **OK** button.
6. Enter the correct date using the numeric keypad, or select the correct date.

Note:



*If you make a mistake while entering numbers, press the **◀** button to re-enter the digit.*

7. Confirm the date on the LCD panel is correct, and then press the **OK** button.
8. Select Set Time, and then press the **OK** button.
9. Enter the correct time using the numeric keypad, or select the correct time.
10. Confirm the time on the LCD panel is correct, and then press the **OK** button.
11. Press the **↶** (**Back**) button several times until the LCD panel shows Select Function.

Changing the Clock Mode

You can set the current time in either the 12-hour or 24-hour format.

1. Press the **System** button.
2. Select Admin Menu, and then press the **OK** button.
3. Select System Settings, and then press the **OK** button.
4. Select Clock Settings, and then press the **OK** button.

5. Select `Time Format`, and then press the  button.
6. Select the desired format, and then press the  button.
7. Press the  (**Back**) button several times until the LCD panel shows `Select Function`.

Sending a Fax

You can fax data from your printer.





Loading a Source Document on the Automatic Document Feeder (ADF)

Important:

Do not load more than 50 sheets on the ADF or allow more than 50 sheets to be fed to the document output tray. The document output tray should be emptied before it holds more than 50 sheets or your source documents may be damaged.

Note:

- To ensure the best scan quality, especially for gray scale images, use the document glass instead of the ADF.*
- You cannot load the following documents on the ADF. Be sure to place them on the document glass.*

	Curled documents		Pre-punched paper
	Lightweight documents		Folded, creased or torn documents
	Cut and paste documents		Carbon paper

1. Load a document(s) face up on the ADF with the top edge going in first. Then adjust the document guides to the correct document size.

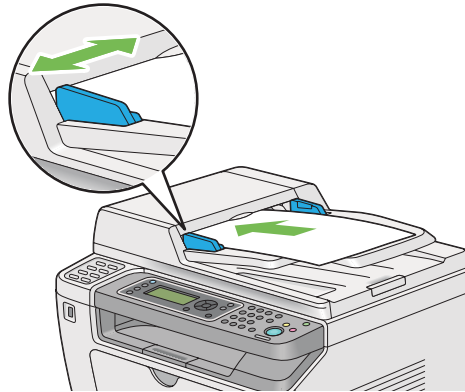

2. Adjust the document resolution, referring to “Resolution” on page 226.

Loading a Source Document on the Document Glass

1. Open the document cover.

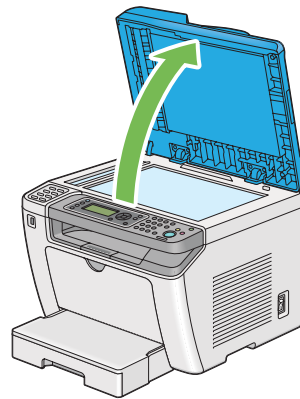

2. Place a single document face down on the document glass and align it with the registration guide on the top left corner of the document glass.

**Caution:**

Do not apply excessive force to hold a thick document on the document glass. It may break the glass and cause injuries.

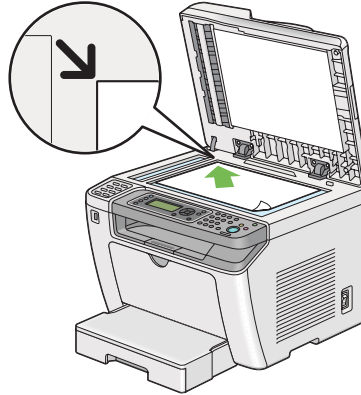



3. Adjust the document resolution, referring to “Resolution” on page 226.
4. Close the document cover.

Note:

- Ensure that no document is on the Automatic Document Feeder (ADF). If any document is detected on the ADF, it will take priority over the document on the document glass.
- If you are faxing a page from a book or magazine, lift the document cover until its hinges are caught by the stopper and then close the document cover. In case the book or magazine is thicker than 20 mm, start faxing with the document cover open.

Resolution

You can specify the resolution level to be used for fax transmission.

1. Press the  (**Fax**) button.
2. Select **Resolution**, and then press the  button.
3. Select the desired menu item, and then press the  button.

Standard*	Suitable for documents with normal sized characters.
Fine	Suitable for documents containing small characters or thin lines or documents printed with a dot-matrix printer.

SuperFine(203dpi)	Suitable for documents containing extremely fine details. The SuperFine(203dpi) mode is effective only when the remote fax machine supports the super fine resolution. See the notes below.
SuperFine(406dpi)	Suitable for documents containing photographic images.



* Factory default menu setting

Note:

Faxes scanned and transmitted in the SuperFine(203dpi) mode are received at the highest resolution of the remote machine.

Document Type

You can select the default document type for the current fax job.



1. Press the  (**Fax**) button.
2. Select Document Type, and then press the  button.
3. Select the desired setting, and then press the  button.

Text*	Suitable for documents with text.
Photo	Suitable for documents with photos.

* Factory default menu setting

Lighten/Darken

you can adjust the contrast to make the fax lighter or darker than the source document.

1. Press the  (**Fax**) button.
2. Select Lighten/Darken, and then press the  button.
3. Select the desired setting, and then press the  button.

Lighten2	Makes the fax lighter than the source document. Works well with dark print.
Lighten1	
Normal*	Works well with standard typewritten or printed documents.

Darken1	Makes the fax darker than the source document. Works well with light print or faint pencil markings.
Darken2	

* Factory default menu setting

Inserting a Pause

On some telephone systems, it is necessary to dial an access code and listen for a second dial tone. A pause must be entered in order for the access code to function. For example, enter the access code 9 and then press the **Redial/Pause** button before entering the telephone number. “-” appears on the LCD panel to indicate that a pause is entered.

Sending a Fax from Memory

1. Load a document(s) face up on the Automatic Document Feeder (ADF) with the top edge going in first; or place a single document face down on the document glass and close the document cover.

See Also:

“Loading a Source Document on the Automatic Document Feeder (ADF)” on page 224







“Loading a Source Document on the Document Glass” on page 225





2. Press the  (**Fax**) button.
3. Adjust the document resolution to suit your fax needs.



See Also:

“Resolution” on page 226

“Lighten/Darken” on page 227

4. Select a fax number in one of the following ways:
 - Select **Fax to**, and then press the  button. Select **Keypad**, and then press the  button. Enter the fax number of the remote fax machine using the numeric keypad, and then press the  button.
 - Press the one-touch button, and then press the  button.
 - Press the **Address Book** button, select **All Entries**, **Group Dial**, or **Search** using the  button, and then press the  button.



All Entries	Displays a list of registered fax numbers. Press the ► button to select the recipients, and then press the  button.
Group Dial	Press the ► button to select the recipients, and then press the  button.
Search	Enter the text you want to search a fax number in the Address Book, and then press the  button. Press the ► button to select the recipients, and then press the  button.

- Press the **Redial/Pause** button to redial, and then press the  button.
- Press the **Speed Dial** button. Enter the speed dial number between 01 and 99 using the numeric keypad, and then press the  button.

Note:

Before you use the one-touch button, you need to register a number for any speed dial from 01 to 08. For details on how to store the number, see “Storing a Fax Number for Speed Dialing Using the Operator Panel” on page 241.

5. Press the  (**Start**) button to scan and store the document in the memory.

When you are using the document glass, the LCD panel displays a prompt for another page. If you have more pages to send, select **Yes**, replace the page with a new one and select **Continue**, repeat the actions for the remaining pages, and then press the  button. Otherwise, select **No** and press the  button.

The printer dials the fax number and send the fax when the remote fax machine answers.

Note:

You can cancel your fax job at any time by pressing the  (**Stop**) button while the transmission is in progress.

Sending a Fax Manually

1. Load a document(s) face up on the Automatic Document Feeder (ADF) with the top edge going in first; or place a single document face down on the document glass and close the document cover.

See Also:

- “Loading a Source Document on the Automatic Document Feeder (ADF)” on page 224
- “Loading a Source Document on the Document Glass” on page 225

2. Press the  (**Fax**) button.

3. Adjust the document resolution to suit your fax needs.

See Also:

- ❑ “Resolution” on page 226
- ❑ “Lighten/Darken” on page 227

4. Select OnHook, and then press the **OK** button.
5. Select On, and then press the **OK** button.
6. Enter the fax number of the remote fax machine using the numeric keypad.
7. Start the fax transmission.
 - ❑ If the document is loaded on the ADF, press the **Start** button.
 - ❑ If the document is loaded on the document glass, press the **Start** button, select the desired setting, and then press the **OK** button.

Note:

You can cancel your fax job at any time by pressing the **Stop** button while the transmission is in progress.

Confirming Transmissions

When the last page of your document has been sent successfully, the printer beeps and returns to standby mode.

If something goes wrong while sending your fax, an error message appears on the LCD panel.

If you receive an error message, press the **OK** button to clear the message and try sending the document again.

You can set your printer to print a confirmation report automatically after each fax transmission.

See Also:

“Printing a Report” on page 261

Automatic Redialing

If the number you have dialed is busy or there is no answer when you send a fax, the printer will automatically redial the number every minute for the number of times set in the redial settings.

To change the time interval between redials and the number of redial attempts, see “Redial Delay” on page 283 and “Number of Redial” on page 283.

Note:

If you manually send a fax, the printer will not automatically redial the number.

Sending a Delayed Fax

You can use the Delayed Start mode to save scanned documents and transmit them at the specified time to take advantage of lower long distance rates.

1. Load a document(s) face up on the Automatic Document Feeder (ADF) with the top edge going in first; or place a single document face down on the document glass and close the document cover.







See Also:

- “Loading a Source Document on the Automatic Document Feeder (ADF)” on page 224
- “Loading a Source Document on the Document Glass” on page 225

2. Press the  (**Fax**) button.
3. Adjust the document resolution to suit your fax needs.

See Also:

- “Resolution” on page 226
- “Lighten/Darken” on page 227

4. Select Delayed Start, and then press the  button.
5. Select On, and then press the  button.
6. Enter the start time using the numeric keypad or press the  or  button to select the start time, and then press the  button.
7. Select Fax to, and then press the  button.

8. Select **Keypad**, and then press the **OK** button.
9. Enter the number of the remote fax machine using the numeric keypad, and then press the **OK** button.

You can also use speed or group dial numbers.

See Also:

“Automatic Dialing” on page 241

10. Press the **Start** button.

When the Delayed Start mode is activated, the printer scans and stores all the documents in its memory and sends them at the specified time. The data in the memory is cleared upon completion of the fax transmission.

Sending a Fax Using the Driver (Direct Fax)

You can send a fax directly from the computer running a Microsoft® Windows® operating system or Mac OS® X by using the driver.

Note:

- Only black and white faxes can be sent using Direct Fax.
- The cover page is not printed for direct fax job even if **Fax Cover Page** is enabled on the operator panel.

Sending a Fax from Windows

Note:

- The following procedure uses Windows 7 WordPad as an example. The names of the windows and the buttons may be different from those given in the following procedure depending on the OS and application you are using.
 - The fax driver is installed along with the printer driver.
1. Open the file you want to send by fax.
 2. Open the print dialog box from the application, and then select your fax driver.

3. Click **Preferences**.

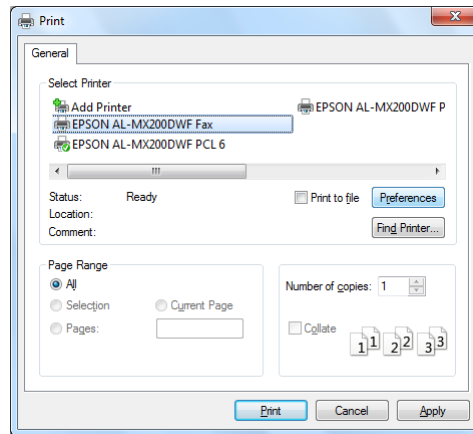

4. Specify the fax settings. For more information, click **Help** of the driver.

Note:

The settings done here are only applied to a single fax job.

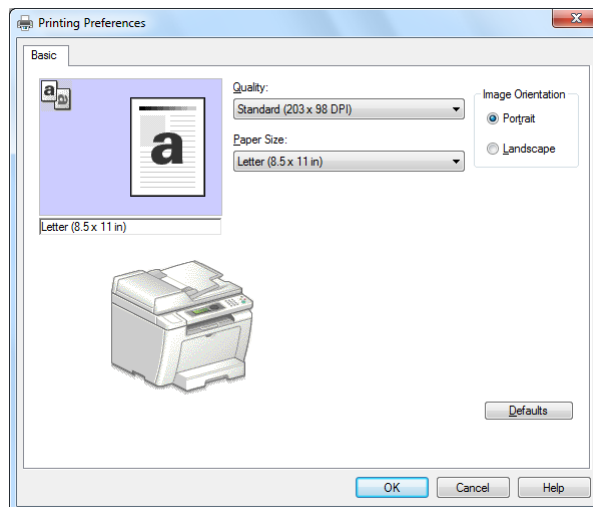

5. Click **OK** to close the **Printing Preferences** dialog box.
6. Click **Print**.

The **Set/Check Fax Transmission** dialog box appears.

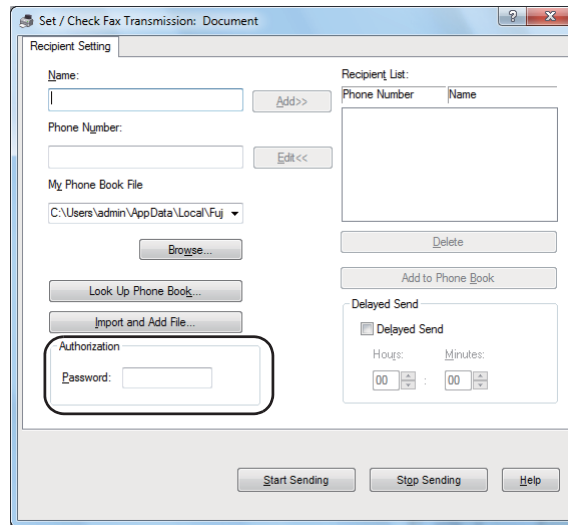

7. Specify the recipient in one of the following ways:

- Enter a name and phone number directly.
- Select a recipient from the Phone Book (PC Fax Address Book) saved on your computer or Address Book (Device Address Book).
- Select a recipient from a database other than the Phone Book (PC Fax Address Book) or Address Book (Device Address Book).

For details on how to specify the recipient, click **Help** to see the Help of the fax driver.

Note:

When the Fax service is locked with a password, enter the password in the **Password** box under **Authorization**.

8. Click **Start Sending**.

Sending a Fax from Mac OS X

Note:

- The following procedure uses Mac OS X 10.6 TextEdit as an example. The names of the windows and the buttons may be different from those given in the following procedure depending on the OS and application you are using.

❑ *The fax driver is installed along with the printer driver.*

1. Open the file you want to send by fax.
2. Open the print dialog box from the application, and then select your fax driver.

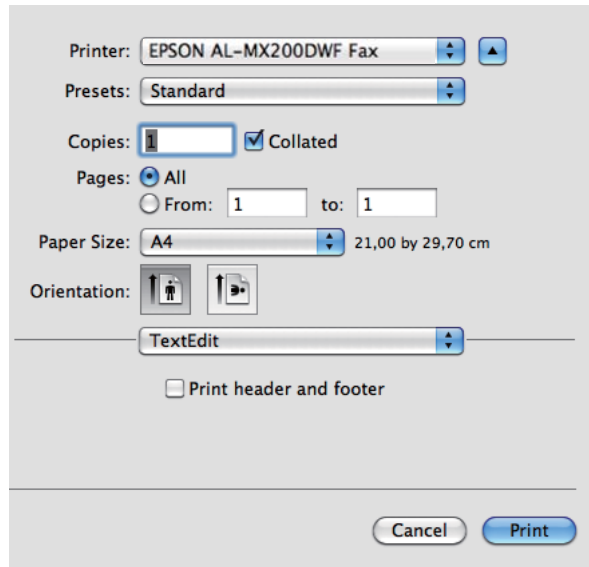

3. Specify the fax settings.

Note:

The settings done here are only applied to a single fax job.

4. Click **Print**.

The **Set/Check Fax Transmission** dialog box appears.

5. Specify the destination for the recipient in one of the following ways:

Specify a recipient directly.

a Enter a name and phone number directly.

b Click **Add**.

OR

Select a recipient from the Address Book saved on your computer.

a Click **Look Up Address Book**.

The **Refer To Address Book** dialog box appears.

b Select a recipient and then click **Add**.

c Click **OK**.

Note:

When the Fax service is locked with a password, enter the password in the **Password** box under **Authorization**.

6. Click **Start Sending**.

Receiving a Fax

About Receiving Modes

There are five receiving modes: FAX Mode, TEL Mode, TEL/FAX Mode, Ans/FAX Mode, and DRPD Mode.

Note:

- To use TEL/FAX Mode or Ans/FAX Mode, connect an external telephone or answering machine to the phone connector (PHONE) on the rear of your printer.
- When the memory is full, you cannot receive a fax. Delete any documents you no longer need from the memory.

See Also:

- "Receiving a Fax Automatically in the FAX Mode" on page 238
- "Receiving a Fax Manually in the TEL Mode" on page 238
- "Receiving a Fax Automatically in the TEL/FAX Mode or Ans/FAX Mode" on page 238
- "Using an Answering Machine" on page 254
- "Receiving Faxes in the DRPD Mode" on page 239

Loading Paper for Receiving Faxes

The instructions for loading paper in the paper tray or the Priority Sheet Inserter (PSI) are the same whether you are printing, faxing, or copying, except that faxes can only be printed on Letter-sized, A4-sized, or Legal-sized paper.

See Also:

- "Loading Print Media in the Paper Tray" on page 123
- "Loading Print Media in the Priority Sheet Inserter (PSI)" on page 132
- "Setting Paper Sizes and Types" on page 137



Receiving a Fax Automatically in the FAX Mode

Your printer is preset to enter the FAX Mode by default.

When the printer receives an incoming fax transmission, it automatically enters the FAX Mode after a predefined period of time and receives the fax.

To change the interval at which the printer enters the FAX Mode after receiving an incoming fax, see “Auto Answer Fax” on page 281.

Receiving a Fax Manually in the TEL Mode

To receive a fax manually, pick up the handset of the external telephone, and then press the  (**Fax**) button. The fax menu opens. Then press the  (**Start**) button and select **Manual Receive**.

The printer begins receiving a fax and returns to standby mode when it is finished with the fax reception.

Receiving a Fax Automatically in the TEL/FAX Mode or Ans/FAX Mode

To use TEL/FAX Mode or Ans/FAX Mode, you must connect an external telephone to the phone connector ( PHONE) on the rear of your printer.

If the printer receives an incoming fax while in the TEL/FAX Mode, the external telephone rings for the period of time specified for **Auto Ans. TEL/FAX**, and then the printer automatically receives a fax.

If a caller leaves a message while the printer is in the Ans/FAX Mode, the answering machine stores the message as it would normally. If the printer hears a fax tone on the line, on the other hand, it automatically starts receiving the fax.

Note:

*If you have set a value for **Auto Answer Fax** and your answering machine is turned off or no answering machine is connected, the printer will automatically enter the FAX Mode after a predefined period of time.*



See Also:

“Using an Answering Machine” on page 254

Receiving a Fax Manually Using an External Telephone

This feature works best for using an external telephone connected to the phone connector (PHONE) on the rear of your printer. You can receive a fax from someone you are talking to by pressing the two-digit remote receive codes on the external telephone without having to go to the printer.

When you receive a call on the external telephone and hear fax tones, do either of the followings:

- Press the two-digit keys on the external telephone.
- Press the  (**Fax**) button to enter the fax menu. *OffHook* appears. Then press the  (**Start**) button and select *Manual Receive*.

If you still hear the fax tone from the remote fax machine, try pressing the two-digit remote receive code once again.

The Remote Receive option is disabled by default. You can change the two-digit remote receive code to whatever you choose. For details on changing the code, see “Remote Rcv Tone” on page 284.

Note:

Set the dialing system of your external telephone to DTMF.

Receiving Faxes in the DRPD Mode

The Distinctive Ring Pattern Detection (DRPD) is a service provided by some telephone companies. This service assigns multiple telephone numbers to a single telephone line and distinguishes each line with a distinctive ring pattern of long and short sounds. If this service is available from your telephone company, subscribe the service and ask the telephone company which one of the available seven DRPD patterns on your printer you can use for the service.

See Also:

“DRPD Pattern” on page 285

To receive faxes in the DRPD Mode, you need to place the printer in the DRPD Mode and select a DRPD pattern. For details on placing the computer in the DRPD Mode, see “Ans Select” on page 280. To set up DRPD, you will need another telephone line at your location or have someone dial your fax number from outside.

To select a DRPD pattern:

1. Press the **System** button.
2. Select *Admin Menu*, and then press the  button.

3. Select **Fax Settings**, and then press the **OK** button.
4. Select **DRPD Pattern**, and then press the **OK** button.
5. Select an appropriate DRPD pattern, and then press the **OK** button.
6. Reboot the printer by turning the power switch off and then on.

Receiving Faxes in the Memory

Since your printer is a multi-tasking device, it can receive faxes while you are making copies or printing. When the printer receives a fax while you are copying, printing, or run out of paper or toner, it stores incoming faxes in the memory. Then, as soon as you finish copying, printing, or replace the toner cartridge, the printer automatically prints the faxes.

Polling Receive

You can poll and receive faxes from a remote fax machine anytime.

1. Press the **Fax** button.
2. Select **Polling Receive**, and then press the **OK** button.
3. Select **On**, and then press the **OK** button.
4. Enter the fax number of the remote fax machine, and then press the **OK** button.

Note:

For details on how to enter the fax number of the remote fax machine, see “Sending a Fax from Memory” on page 228.









5. Press the **Start** button.

Automatic Dialing



Speed Dialing

You can store up to 99 frequently dialed numbers in fax speed dial locations (01–99).

Storing a Fax Number for Speed Dialing Using the Operator Panel

1. Press the **System** button.
2. Select `Admin Menu`, and then press the  button.
3. Select `Phone Book`, and then press the  button.
4. Select `Speed Dial`, and then press the  button.
5. Select the desired speed dial number between 01 and 99, and then press the  button.
6. Select `Name`, and then press the  button.
7. Enter the name using the numeric keypad, and then press the  button.
8. Select `Phone Number`, and then press the  button.
9. Enter the number you want to store using the numeric keypad, and then press the  button.

To insert a pause between numbers, press the **Redial/Pause** button and confirm that “-” appears on the LCD panel.

10. Select `Apply Settings`, and then press the  button.
11. Select `Yes`, and then press the  button.
12. Repeat steps 5 to 11 as needed to add speed dial numbers.
13. To quit adding speed dial numbers, keep pressing the  (**Back**) button until the LCD panel shows `Select Function`.

Storing a Fax Number for Speed Dialing Using a Computer

You can also create a personal address with EpsonNet Config or Address Book Editor for speed dialing.

The following procedure uses Windows 7 as an example.

Using EpsonNet Config

1. Launch your web browser.
2. Enter the IP address of the printer in the address bar, and then press the **Enter** key.

EpsonNet Config appears on your browser.

Note:

For details on how to check the IP address of the printer, see “Verifying the IP Settings” on page 47.

3. Click the **Address Book** tab.

If a user name and password entry is prompted, enter the correct user name and password.

Note:

The default User ID and password are both blank (NULL).



4. Under **Fax / E-mail**, click **Personal Address**.
5. Select any unused number and click **Add**.

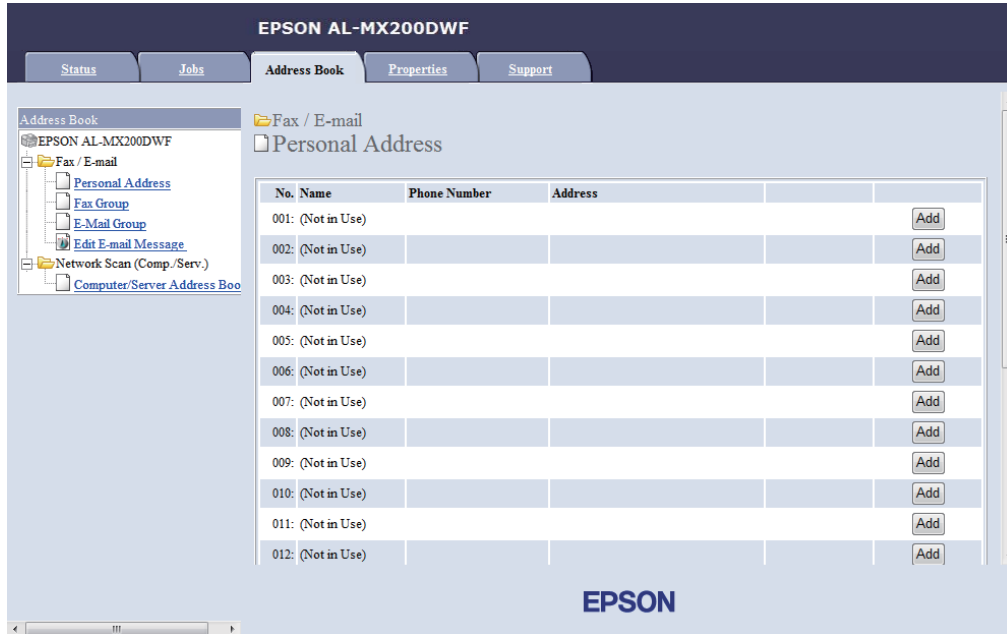

The **Add Personal Address** page appears.

No.	001
1— Name	<input type="text"/>
2— Phone Number	<input type="text"/>
3— E-mail Address	<input type="text"/>

To fill in the fields, enter the information as follows:

1	Name	Enter a friendly name that you want it to appear on the Address Book.
2	Phone Number	Enter the recipient's phone number.
3	E-mail Address	Enter the recipient's E-mail address.

Note:

The first eight entries in the Address Book correspond to the one-touch buttons on the operator panel.

- Click **Apply** to create the new address.

Using the Address Book Editor

- Windows:**

Click **Start** — **All Programs** — **EPSON** — your printer — **Address Book Editor**.

Mac OS X:

From the **Applications** folder, select **EPSON**— your printer — **Address Book Editor-Btype**.

Note:

- The window to select a device appears when multiple fax drivers are installed on your computer. In this case, click the name of the desired printer listed in **Device Name**. For Mac OS X, double-click the desired printer in **Select Device**.
 - The **Enter Password** window appears when Panel Lock Set is set to Enable. In this case, enter the password you specified, and click **OK**.
- Click **OK** on the “Retrieval Successful” message window.
 - Right-click the **Fax/E-Mail** icon, and then select **New** — **New Entry**.

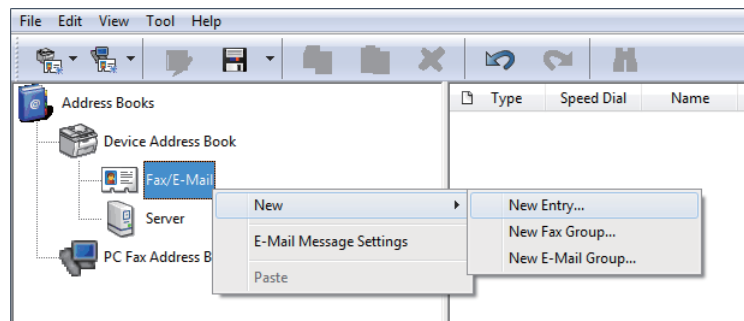

The **Personal Address** dialog box appears.

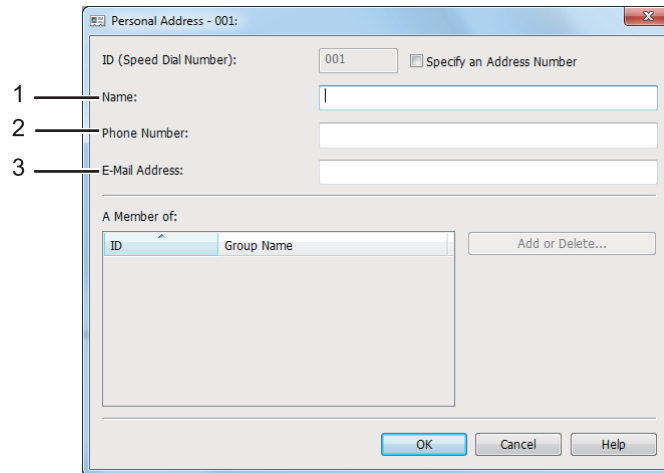

To fill in the fields, enter the information as follows:

1	Name	Enter a friendly name that you want it to appear on the Address Book.
2	Phone Number	Enter the recipient's phone number.
3	E-mail Address	Enter the recipient's E-mail address.

Note:

- If you want to change the automatically assigned address ID, select the **Specify an Address Number** check box, and then enter a value from 1 to 99 for **ID (Speed Dial Number)**.
- The first eight entries in the Address Book correspond to the one-touch buttons on the operator panel.





4. Click **OK**.
5. On the **File** menu, select **Save All**.

Sending a Fax Using Speed Dialing

1. Load a document(s) face up on the Automatic Document Feeder (ADF) with the top edge going in first; or place a single document face down on the document glass and close the document cover.



See Also:

- "Loading a Source Document on the Automatic Document Feeder (ADF)" on page 224

- ❑ “Loading a Source Document on the Document Glass” on page 225
2. Press the  (**Fax**) button and do either of the following:
 - ❑ Select **Fax to**, and then press the  button. Select **Speed Dial**, and then press the  button.
 - ❑ Press the **Speed Dial** button.
 3. Enter a speed dial number between 01 and 99 using the numeric keypad.
The corresponding entry's name briefly appears on the LCD panel.
 4. Press the  button.
 5. Adjust the document resolution to suit your fax needs.

See Also:

- ❑ “Resolution” on page 226
 - ❑ “Lighten/Darken” on page 227
6. Press the  (**Start**) button to scan and store the document in the memory.

When you are using the document glass, the LCD panel displays a prompt for another page. If you have more pages to send, select **Yes**, replace the page with a new one and select **Continue**, repeat the actions for the remaining pages, and press the  button. Otherwise, select **No** and press the  button.

The printer dials the fax number stored as the speed dial number and send the fax when the remote fax machine answers.

Note:

Using an asterisk (*) in the digit of the speed dial number, you can send a document to multiple locations. For example, if you enter 0*, you can send a document to the destinations registered to the speed dial numbers 01 through 09.











Group Dialing

If you frequently send the same document to several destinations, you can group the fax numbers for these destinations together to create a group dialing number. This enables you to send a fax to multiple destinations by specifying a single group dialing number. You can create up to six group dial numbers.

Note:

You cannot include a group dial number within another group dial number.

Creating Group Dial Numbers Using the Operator Panel

1. Press the **System** button.
2. Select Admin Menu, and then press the  button.
3. Select Phone Book, and then press the  button.
4. Select Group Dial, and then press the  button.
5. Select a group dial number between 01 and 06, and then press the  button.
6. Select Name, and then press the  button.
7. Enter your desired name, and then press the  button.
8. Select Speed Dial No, and then press the  button.
9. Select speed dial numbers to include in the group dial number, and then press the  button.
10. Select Apply Settings, and then press the  button.
11. Select Yes when Are You Sure? is displayed, and then press the  button.
12. To create more group dial numbers, repeat steps 5 to 11.
13. To quit creating group dial numbers, keep pressing the  (**Back**) button until the LCD panel shows Select Function.

Editing Group Dial Numbers Using the Operator Panel

You can add/delete a speed dial number(s) to/from a group dial number.

1. Press the **System** button.
2. Select Admin Menu, and then press the  button.

3. Select `Phone Book`, and then press the **OK** button.
 4. Select `Group Dial`, and then press the **OK** button.
 5. Select the group dial number that you want to edit, and then press the **OK** button.
 6. To change the group dial name:
 - a. Select `Name`, and then press the **OK** button.
 - b. Enter a new name, and then press the **OK** button.
 - c. Select `Apply Settings`, and then press the **OK** button.
 - d. Select `Yes when Are You Sure?` is displayed, and then press the **OK** button.
 7. To change the speed dial number:
 - a. Select `Speed Dial No.`, and then press the **OK** button.
 - b. Select or deselect a desired speed dial number(s), and then press the **OK** button.
 - c. Select `Apply Settings`, and then press the **OK** button.
 - d. Select `Yes when Are You Sure?` is displayed, and then press the **OK** button.
- Note:**
*Deselecting all speed dial numbers in the group dial number does not delete the group dial number itself. To delete the group dial number, press the **C (Clear)** button step b above and proceed to step d.*
8. If you want to edit another group dial number, repeat steps 5 to 8.
 9. To quit editing group dial numbers, keep pressing the **↵ (Back)** button until the LCD panel shows `Select Function`.

Creating and Editing a Fax Group Using a Computer

You can also create and edit a fax group with EpsonNet Config or Address Book Editor.

The following procedure uses Windows 7 as an example.

Using EpsonNet Config

1. Launch your web browser.
2. Enter the IP address of the printer in the address bar, and then press the **Enter** key.

EpsonNet Config appears on your browser.

Note:

For details on how to check the IP address of the printer, see “Verifying the IP Settings” on page 47.

3. Click the **Address Book** tab.

If a user name and password entry is prompted, enter the correct user name and password.

Note:

The default User ID and password are both blank (NULL).



4. Under **Fax / E-mail**, click **Fax Group**.

5. Select any unused number and click **Add**.

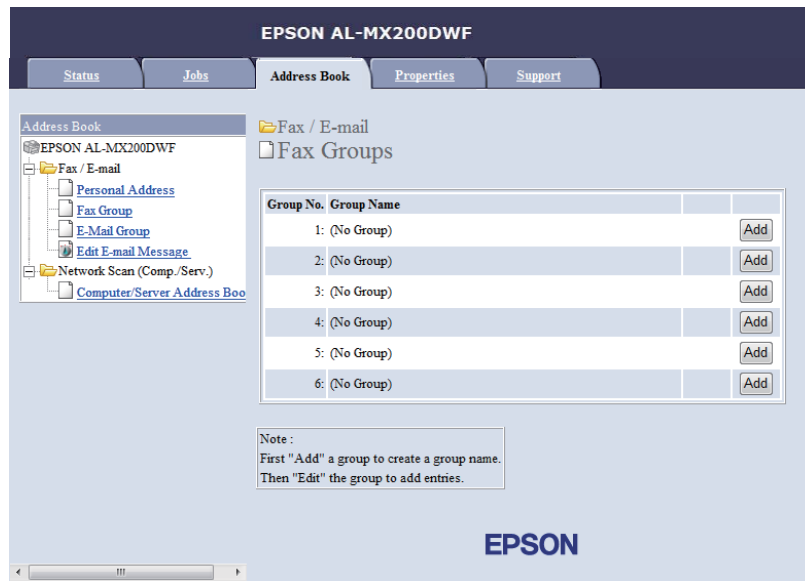

The **Add Fax Group** page appears.

6. Enter a group name in the **Group Name** box, and then click **Apply**.
7. Click **Back** to return to the previous screen, and then select the group name you just created.

The **Edit Fax Group** page appears.

8. Select a phone number you want to add in the fax group, and then click **Apply**.

Using the Address Book Editor

1. **Windows:**

Click **Start** — **All Programs** — **EPSON** — your printer — **Address Book Editor**.

Mac OS X:

From the **Applications** folder, select **EPSON**— your printer — **Address Book Editor-Btype**.

Note:

- ❑ *The window to select a device appears when multiple fax drivers are installed on your computer. In this case, click the name of the desired printer listed in **Device Name**. For Mac OS X, double-click the desired printer in **Select Device**.*

- ❑ The **Enter Password** window appears when **Panel Lock Set** is set to **Enable**. In this case, enter the password you specified, and click **OK**.
2. Click **OK** on the “Retrieval Successful” message window.
 3. Right-click the **Fax/E-Mail** icon, and then select **New — New Fax Group**.

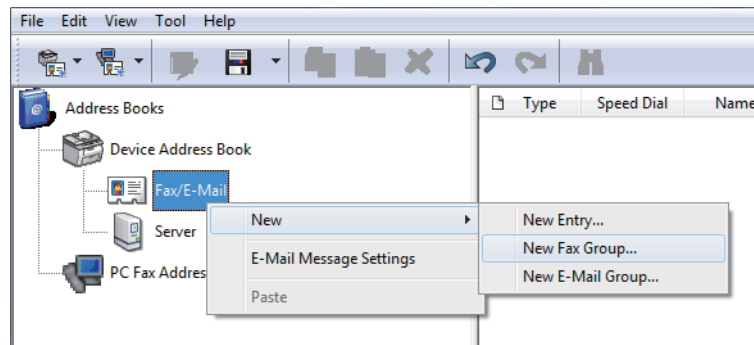

The **Group Dial** dialog box appears.

4. Enter the name that you want it to appear in the Address Book in the **Group Name** box.
5. Click the **Add or Delete** button.
6. Select group members from **List of Selectable Members**.
7. Click **Add**, and then click **OK**.
8. Click **OK** again to create the group.
9. (Windows only)
Confirm the group members, and then click **OK**.
10. On the **File** menu, select **Save All**.

Note:

To edit the existed fax group, click the **Fax/E-Mail** icon and double-click the fax group you want to edit, and then repeat steps 5 to 10.

Sending a Fax Using Group Dialing (Multi-address Transmission)

You can use group dial numbers for broadcasting or delayed transmissions.

See Also:







“Sending a Delayed Fax” on page 231

1. Load a document(s) face up on the Automatic Document Feeder (ADF) with the top edge going in first; or place a single document face down on the document glass and close the document cover.

See Also:

“Loading a Source Document on the Automatic Document Feeder (ADF)” on page 224

“Loading a Source Document on the Document Glass” on page 225

2. Press the  (**Fax**) button.
3. Select **Fax to**, and then press the  button.
4. Select **Group Dial**, and then press the  button.
5. Press the  or  button to enter a group dial number between 01 and 06, and then press the  button to make or clear the selection.

The corresponding entry's name appears on the LCD panel.



6. Press the  button.
7. Adjust the document resolution to suit your fax needs.

See Also:

“Resolution” on page 226

“Lighten/Darken” on page 227

8. Press the  (**Start**) button to scan and store the document in the memory.

When you are using the document glass, the LCD panel displays a prompt for another page. If you have more pages to send, select **Yes**, replace the page with a new one and select **Continue**, repeat the actions for the remaining pages, and press the  button. Otherwise, select **No** and press the  button.

The printer dials the fax number stored as the speed dial number and send the fax when the remote fax machine answers.

Printing the Address Book List

You can review your automatic dial entries by printing the Address Book List.

1. Press the **System** button.
2. Select Report / List, and then press the **OK** button.
3. Select Address Book, and then press the **OK** button.

A list of your speed and group dial entries is printed.

Other Ways to Fax

Using the Secure Receiving Mode

You may need to prevent your received faxes from unauthorized access. Use the secure receiving mode to prohibit printing out all of the received faxes when the printer is unattended. In the secure receiving mode, all incoming faxes will be stored in the memory. You can then turn off the mode to print all the stored faxes.

Note:

Before operation, ensure that Panel Lock Set is set to Enable.

To turn on the secure receiving mode:

1. Press the **System** button.
2. Select Admin Menu, and then press the **OK** button.
3. Enter the password specified for Panel Lock, and then press the **OK** button.

Note:

The factory-default panel password is 0000.

4. Select Secure Settings, and then press the **OK** button.
5. Select Secure Receive, and then press the **OK** button.
6. Select Secure Receive Set, and then press the **OK** button.

7. Select **Enable**, and then press the **OK** button.
8. Press the **⏪ (Back)** button several times until the LCD panel shows **Select Function**.

While in the secure receiving mode, your printer stores received faxes in the memory and displays **Secure Receive** in the **Job Status** screen to indicate it has faxes stored in the memory.

Note:

*If you change the panel password while **Secure Receive Set** is set to **Enable**, perform steps 1 through 5 above, select **Change Password**, and then press the **OK** button. Enter a new password, and then press the **OK** button.*

To print stored faxes:

1. Press the **Job Status** button.
2. Select **Secure Receive**, and then press the **OK** button.
3. Enter the password, and then press the **OK** button.

The faxes stored in memory are printed.

To turn off the secure receiving mode:

1. Follow steps 1 through 6 in “To turn on the secure receiving mode:” to access the **Secure Receive Set** menu.
2. Select **Disable**, and then press the **OK** button.
3. Press the **⏪ (Back)** button several times until the LCD panel shows **Select Function**.

Using an Answering Machine

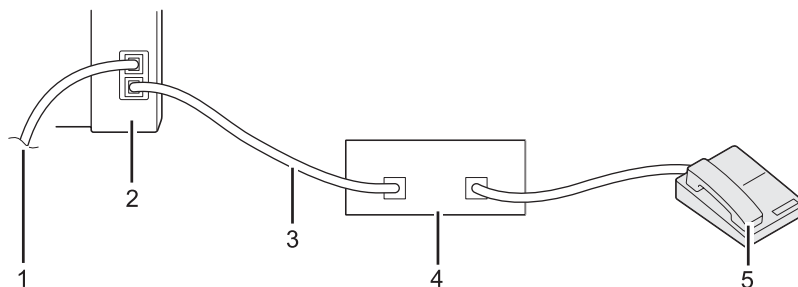

1	To the wall jack
2	Printer
3	Line
4	Telephone Answering Device
5	Phone

You can connect a telephone answering device (TAD) directly to the rear of your printer as shown above.

- Place your printer in the Ans/FAX Mode and specify for `Auto Ans.` Ans/FAX a period of time before the TAD responds.
- When the TAD picks up an incoming call, the printer monitors and takes the line if it hears a fax tone and then starts receiving the fax.
- When the TAD is turned off, the printer automatically enters the FAX Mode after a predefined period of time.

Using a Computer Modem

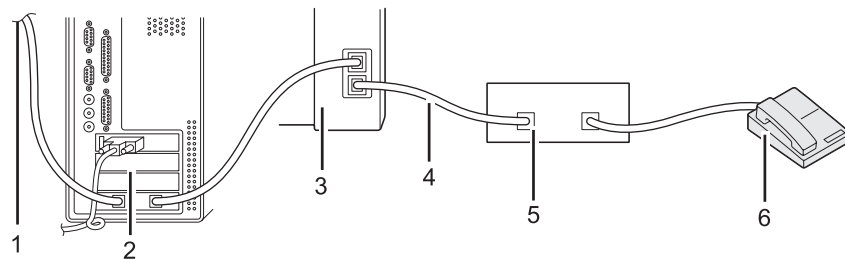

1	To the internet
2	Computer
3	Printer
4	Line
5	Telephone Answering Device
6	Phone

If you want to use your computer modem for faxing or dial-up internet connection, connect the computer modem directly to the rear of your printer with the TAD as shown above.

- Place your printer in the Ans/FAX Mode and specify for Auto Ans. Ans/FAX a period of time before the TAD responds.
- Turn off the computer modem's fax-receive feature.
- Do not use the computer modem while your printer is sending or receiving a fax.
- Follow the instructions provided with your computer modem and fax application to fax via the computer modem.

Setting Sounds

Speaker Volume

1. Press the **System** button.
2. Select Admin Menu, and then press the **OK** button.
3. Select Fax Settings, and then press the **OK** button.
4. Select Line Monitor, and then press the **OK** button.
5. Select the desired volume, and then press the **OK** button.
6. Reboot the printer by turning the power switch off and then on.

Ringer Volume

1. Press the **System** button.
2. Select Admin Menu, and then press the **OK** button.
3. Select Fax Settings, and then press the **OK** button.
4. Select Ring Tone Volume, and then press the **OK** button.

5. Select the desired volume, and then press the **OK** button.
6. Reboot the printer by turning the power switch off and then on.

Specifying the Fax Settings

Customizing Fax Options

Your printer is provided with a variety of options that you can use to configure the fax feature. For details on the available menu items, see “Available Fax Options” on page 257.

1. Press the **System** button.
2. Select Admin Menu, and then press the **OK** button.
3. Select Fax Settings, and then press the **OK** button.
4. Select the desired menu item, and then press the **OK** button.
5. Select the desired setting or enter the value using the numeric keypad.
6. Press the **OK** button to save the selection.
7. Repeat steps 4 to 6 as needed to change the setting.
8. To quit changing settings, keep pressing the **Back** button until the LCD panel shows Select Function.

Available Fax Options

You can use the following options for configuring the fax feature of your printer:









Option		Description
Ans Select	TEL Mode	The printer does not automatically receive faxes. To receive an incoming fax, you need to pick up the handset of the connected external telephone and press the 2-digit remote receive code.
	FAX Mode	This option is selected by default and the printer automatically receives faxes.
	TEL/FAX Mode	When the printer receives an incoming fax, the external telephone rings for the period of time specified for <code>Auto Ans. TEL/FAX</code> , and then the printer automatically receives the fax. If an incoming call is not a fax, the printer beeps from the internal speaker indicating that the call is a telephone call.
	Ans/FAX Mode	The printer shares the telephone line with an answering machine and monitors the line for a fax tone. It will pick up an incoming call if it hears a fax tone. This option is not available in regions where a serial phone system is employed.
	DRPD Mode	To use this option, you need to subscribe the Distinctive Ring Pattern Detection (DRPD) service from your telephone company that assigns multiple telephone numbers to a single telephone line and distinguishes each line with a distinctive ring pattern. Once this service is activated, then you can configure your printer to monitor the line for the distinctive ring pattern.
Auto Answer Fax		Specify a period of time for which the printer waits before entering the FAX Mode upon reception of an incoming call.
Auto Ans. TEL/FAX		Specify a period of time for which the printer waits before entering the FAX Mode when the external telephone receives an incoming call.
Auto Ans. Ans/FAX		Specify a period of time for which the printer waits before entering the FAX Mode when the answering machine receives an incoming call.
Line Monitor		Select a volume level of the sound that the printer emits from the internal speaker while establishing a connection for fax transmission.
Ring Tone Volume		Select a volume level of the ring tone that the printer emits from the internal speaker to indicate an incoming telephone call while in the TEL/FAX Mode.
Line Type		Select the line type.
Dialing Type		Select the dialing type. Note: DP (10FFS) is not displayed when South Africa is set for Region.
Interval Timer		Specify an interval between transmission attempts.

Option	Description
Number of Redial	Specify the number of redial attempts to make when the destination fax number is busy. If you specify 0, the printer will not redial.
Redial Delay	Specify an interval between redial attempts.
Junk Fax Filter	Select whether to reject faxes from the numbers that are not included in the Phone Book.
Remote Receive	Select whether to use this option. With this option enabled, you can pick up the handset and enter the remote receive code to receive a fax.
Remote Rcv Tone	Specify the remote receive code in two digits for the Remote Receive option.
Send Header	Select whether to print the sender information on the header of faxes.
Company Name	Enter a sender name of up to 30 alphanumeric characters.
Your Fax Number	Enter the fax number of the printer to be printed on the header of faxes.
Fax Cover Page	<p>Select whether to attach a cover page to faxes.</p> <p>Note: The cover page is not printed for direct fax job even if Fax Cover Page is enabled on the operator panel.</p>
DRPD Pattern	Select a ring pattern for the Distinctive Ring Pattern Detection (DRPD) service.
2-Sided Print	Select whether to print on either side of the paper.
Forward Settings	Select how you want to forward received faxes.
Fax Fwd Number	Enter the forwarding fax number when you have selected Forward Only or Forward and Print for Forward Settings.
Fax Fwd E-Mail	Enter the forwarding e-mail address when you have selected E-Mail and Print for Forward Settings.
Prefix Dial	Select whether to insert a prefix dial number.
Prefix Dial Num	Enter a prefix dial number of up to five digits. This number dials before any auto dial number is started. It is useful for accessing the Private Automatic Branch Exchange (PABX).
Discard Size	Select whether to discard text or images at the bottom of a fax page when the entire page does not fit onto the output paper. Selecting Auto Reduction automatically reduces the fax page to fit it onto the output paper, and does not discard any images or text at the bottom of the page.

Option	Description
ECM	Select whether to enable the ECM. To use the ECM, the remote fax machines must also support the ECM.
Extel Hook Thresh	Select an external telephone hook detection threshold for the condition in which a telephone line is not being used.
Modem Speed	Select a fax modem speed when a fax transmission or reception error occurs.
Fax Activity	Select whether to automatically print the Fax Activity Report after every 50 incoming and outgoing fax communications.
Fax Transmit	Select whether to print a transmission report after every fax transmission or only when an error occurs.
Fax Broadcast	Select whether to print a transmission report after every fax transmission to multiple destinations or only when an error occurs.
Region	Select the region where the printer is used.

Prefix Dial

The prefix dial number is required in an environment where out-going fax calls go through a PBX machine.

1. Press the **System** button.
2. Select Admin Menu, and then press the  button.
3. Select Fax Settings, and then press the  button.
4. Select Line Type, and then press the  button.
5. Select PBX, and then press the  button.
6. Press the  (**Back**) button to return to the previous menu.
7. Select Prefix Dial, and then press the  button.
8. Select On, and then press the  button.
9. Press the  (**Back**) button to return to the previous menu.
10. Select Prefix Dial Num, and then press the  button.

11. Enter an up-to-five-digit prefix number using 0–9, *, and #.
12. Confirm the prefix dial number on the LCD panel is correct, and then press the **OK** button.
13. Reboot the printer by turning the power switch off and then on.

Changing the Default Fax Settings

You can customize the default fax settings using the menu items that you use most frequently.

1. Press the **System** button.
2. Select `Defaults Settings`, and then press the **OK** button.
3. Select `Fax Defaults`, and then press the **OK** button.
4. Select the desired menu item, and then press the **OK** button.
5. Select the desired setting or enter the value using the numeric keypad, and then press the **OK** button.
6. Repeat steps 4 and 5, as needed.
7. To quit changing the default settings, keep pressing the **Back** button until the LCD panel shows `Select Function`.

Printing a Report

The following reports may be useful when using the fax function:

Address Book List

This list shows all the addresses currently stored in the memory of the printer as Address Book information.

Fax Activity Report

This report shows information about the recent 50 faxes you received or sent.

Protocol Monitor

This report shows a detailed list of monitored protocols.

Monitor Report

This report shows the details of a fax job. This is printed when the fax was successfully sent.

Transmission Report

This report shows the details of a fax job. This is printed when the fax transmission failed.

Broadcast Report

This report shows all the destinations of a broadcast fax and the transmission result for each destination.

Note:

The reports and lists are all printed in English.

To print a report or list:

1. Press the **System** button.
2. Select **Report / List**, and then press the **OK** button.
3. Select a report or list you want to print, and then press the **OK** button.

The selected report or list is printed.

Note:

You cannot manually print the Monitor Report, Transmission Report, and Broadcast Report with the above procedure. They will be printed as specified upon completion of a fax job. For details on setting when to print them, see "Fax Transmit" on page 290 or "Fax Broadcast" on page 290.

Chapter 9

Using the Operator Panel Menus and Keypad

Understanding the Operator Panel Menus

When your printer is connected to a network and available to a number of users, access to the Admin Menu may be restricted. This prevents unauthorized users from using the operator panel to inadvertently change the default menu settings that have been set by the administrator. However, you can change settings for individual print jobs using the print driver. Print settings selected on the print driver have precedence over the default menu settings on the operator panel.

Report / List

Use Report / List to print various types of reports and lists.

Note:

- A password is required to use the Report / List menu when Panel Lock Set is set to Enable. In this case, enter the password you specified, and press the  button.
- The reports and lists are all printed in English.

System Settings

Purpose:

To print a list of information such as the printer name, the serial number, print volume, and network settings.

Panel Settings

Purpose:

To print a detailed list of all the settings on the operator panel menus.

Job History

Purpose:

To print a detailed list of the jobs that have been processed. This list contains the last 50 jobs.

Error History

Purpose:

To print a detailed list of paper jams and fatal errors.

PCL Fonts List

Purpose:

To print a sample of available PCL® fonts.

PS Fonts List

Purpose:

To print a sample of available PostScript Level3 Compatible and PDF fonts.

Protocol Monitor

Purpose:

To print a detailed list of monitored protocols.

Address Book

Purpose:

To print the list of all addresses stored as Address Book information.

Fax Activity

Purpose:

To print the report of faxes you recently received or sent.

Meter Readings

Use `Meter Readings` to check the total number of printed pages.

Admin Menu

Use the `Admin Menu` to configure a variety of printer features.

Note:

A password is required to use the Admin Menu when Panel Lock Set is set to Enable. In this case, enter the password you specified, and press the  button.

Phone Book

Use the **Phone Book** menu to configure the speed dial and group dial settings.

Speed Dial

Purpose:

To store up to 99 frequently dialed numbers in speed dial locations.

Note:

The first eight entries are assigned to the one-touch buttons on the operator panel.

See Also:

“Storing a Fax Number for Speed Dialing Using the Operator Panel” on page 241

Group Dial

Purpose:

To create a group of fax destinations and register it under a 2-digit dial code. Up to six group dial codes can be registered.

See Also:

“Creating Group Dial Numbers Using the Operator Panel” on page 247

PCL Settings

Use the **PCL Settings** menu to change printer settings that only affect jobs using the PCL emulation printer language.

Paper Size

Purpose:

To specify the default paper size.

Values:

A4 - 210x297mm *
A5 - 148x210mm
B5 - 182x257mm
Letter - 8.5x11"
Folio - 8.5x13"

Legal - 8.5x14"
Executive
Statement
#10 Env. - 4.125x9.5"
Monarch Env.
Monarch Env. L
DL Env. - 110x220mm
DL Env. L
C5 Env. - 162x229mm
Postcard JPN - 148x100mm
W-Postcard JPN - 148x200mm
Env Yougata 2
Env Yougata 2L
Env Yougata 3
Env Yougata 3L
Env Yougata 4
Env Yougata 6
Env Younaga 3
Env Nagagata 3
Env Nagagata 4
Env Kakugata 3

New Custom Size	Portrait(Y)	297mm[*] / 11.7inch[*]	Specifies the length of the custom size paper. Which factory default menu setting displays depends on the value selected for mm / inch under the System Settings menu. See "mm / inch" on page 294 for more information.
		127mm - 355mm / 5.0inch - 14.0inch	
	Landscape(X)	210mm[*] / 8.3inch[*]	Specifies the width of the custom size paper. Which factory default menu setting displays depends on the value selected for mm / inch under the System Settings menu. See "mm / inch" on page 294 for more information.
		77mm - 215mm / 3.0inch - 8.5inch	

^{*} Factory default menu setting

Orientation

Purpose:

To specify how text and graphics are oriented on the page.

Values:

Portrait[*]	Prints text and graphics parallel to the short edge of the paper.
Landscape	Prints text and graphics parallel to the long edge of the paper.

^{*} Factory default menu setting

2-Sided

Purpose:

To specify whether to print on either side of paper.

Values:

2-Sided Print	Off	Does not print on either side of paper.
	On[*]	Prints on either side of paper.
Binding Edge	Flip Long Edge[*]	Prints on either side of paper to be bound on the long edge.
	Flip Short Edge	Prints on either side of paper to be bound on the short edge.

^{*} Factory default menu setting

Font

Purpose:

To select the default font from the fonts installed on the printer.

Values:

Courier*	AlbertusMd	ITCBookmanDb
CGTimes	AlbertusXb	ITCBookmanLtit
CGTimesBd	Arial	ITCBookmanDbIt
CGTimesIt	ArialBd	NwCentSchlBkRmn
CGTimesBdIt	ArialIt	NwCentSchlBkBd
CGOmega	ArialBdIt	NwCentSchlBkIt
CGOmegaBd	TimesNew	NwCentSchlBkBdIt
CGOmegaIt	TimesNewBd	Times
CGOmegaBdIt	TimesNewIt	TimesBd
Coronet	TimesNewBdIt	TimesIt
ClarendonCd	Helvetica	TimesBdIt
UniversMd	HelveticaBd	ZapfChanceryMdlIt
UniversBd	HelveticaOb	Symbol
UniversMdlIt	HelveticaBdOb	SymbolPS
UniversBdIt	HelveticaNr	Wingdings
UniversMdCd	HelveticaNrBd	ZapfDingbats
UniversBdCd	HelveticaNrOb	CourierBd
UniversMdCdIt	HelveticaNrBdOb	CourierIt
UniversBdCdIt	PalatinoRmn	CourierBdIt
AntiqueOlv	PalatinoBd	LetterGothic
AntiqueOlvBd	Palatinolt	LetterGothicBd
AntiqueOlvIt	PalatinoBdIt	LetterGothicIt
GarmondAntiqua	ITCAvantGardBk	CourierPS
GarmondHlb	ITCAvantGardDb	CourierPSBd
GarmondKrsv	ITCAvantGardBkOb	CourierPSOb
GarmondKrsvHlb	ITCAvantGardDbOb	CourierPSBdOb

Marigold	ITCBookmanLt	Line Printer
-----------------	---------------------	---------------------

* Factory default menu setting

Symbol Set

Purpose:

To specify a symbol set for the specified font.

Values:

ROMAN-8	DESKTOP	ISO-21
ROMANEXT	MC TEXT	ISO-60
ISO-L1	PS TEXT	ISO-69
ISO-L2	MS PUB	WIN 3.0
ISO-L5	MATH-8	SYMBOL
PC-8*	PS MATH	WINGDINGS
PC-8 DN	PI FONT	DNGBTSMS
PC-850	LEGAL	ISO-L6
PC-852	ISO-4	PC-1004
PC-8 TK	ISO-6	PC-775
WIN L1	ISO-11	WINBALT
WIN L2	ISO-15	UCS-2
WIN L5	ISO-17	

* Factory default menu setting

Font Size

Purpose:

To specify the font size for scalable typographic fonts, within a range from 4.00 to 50.00. The default is 12.00.

Font size refers to the height of the characters in the font. One point equals approximately 1/72 of an inch.

Font Pitch

Purpose:

To specify the font pitch for scalable mono spaced fonts, within a range from 6.00 to 24.00. The default is 10.00.

Font pitch refers to the number of fixed-space characters in a horizontal inch of type. For nonscheduled mono spaced fonts, the pitch is displayed, but cannot be changed.

Form Line

Purpose:

To set the number of lines in a page.

Values:

72*	Select the value in increments of 1.
5-128	

* Factory default menu setting

Note:

The printer sets the amount of space between each line based on the Form Line and Orientation settings. Make sure that the Form Line and Orientation settings are correct before changing the Form Line setting.

Quantity

Purpose:

To set the default print quantity, within a range from 1 to 999. The default is 1. (Set the number of copies required for a specific job on the print driver. Values selected on the print driver always override values selected on the operator panel.)

Image Enhance

Purpose:

To specify whether to enable the Image Enhance feature which makes the boundary line between black and white smoother to decrease jagged edges and enhance the visual appearance.

Values:

Off*	Disables the Image Enhance feature.
-------------	-------------------------------------

On	Enables the Image Enhance feature.
-----------	------------------------------------

* Factory default menu setting

Draft Mode

Purpose:

To save toner by printing in the draft mode. The print quality is reduced when you print in the draft mode.

Values:

Disable*	Does not print in the draft mode.
Enable	Prints in the draft mode.

* Factory default menu setting

Line Termination

Purpose:

To add the line termination commands.

Values:

Off*	The line termination command is not added. CR=CR, LF=LF, FF=FF
Add CR	The CR command is added. CR=CR, LF=CR+LF, FF=CR+FF
Add LF	The LF command is added. CR=CR+LF, LF=LF, FF=FF
CR-XX	The CR and LF commands are added. CR=CR+LF, LF=CR+LF, FF=CR+FF

* Factory default menu setting

PS Settings

Use the **PS Settings** menu to change printer settings that only affect jobs using the PostScript Level3 Compatible printer language.

PS Error Report

Purpose:

To specify whether to print the description of errors concerning the PostScript Level3 Compatible printer language.

Values:

Off	Dose not print the PS error report.
On*	Prints the PS error report.

* Factory default menu setting

PS Job Time-Out

Purpose:

To specify the runtime of a single job using the PostScript Level3 Compatible printer language.

Values:

Off*		Does not set the runtime of a PS job.
On	1min	Sets the runtime of a PS job.
	1min - 900min	

* Factory default menu setting

PDF Settings

Use the **PDF Settings** menu to change printer settings that only affect the PDF jobs.

Quantity

Purpose:

To specify the number of copies to print.

Values:

1*	Select a value in increments of 1.
1 - 999	

* Factory default menu setting

2-Sided

Purpose:

To specify whether to print on either side of paper.

Values:

2-Sided Print	Off	Does not print on either side of paper.
	On *	Prints on either side of paper.
Binding Edge	Flip Long Edge *	Prints on either side of paper to be bound on the long edge.
	Flip Short Edge	Prints on either side of paper to be bound on the short edge.

* Factory default menu setting

Print Mode

Purpose:

To specify the print mode.

Values:

Normal *	For documents with normal sized characters.
High Quality	For documents with small characters or thin lines, or documents printed using a dot-matrix printer.

* Factory default menu setting

PDF Password

Purpose:

To specify a password for printing secure PDF files.

Values:

*****	Enter a password of up to 32 alphanumeric characters for printing secure PDF files.
-------	---

Paper Size

Purpose:

To specify the output paper size for PDF files.

Values:

A4 - 210x297mm*
Letter - 8.5x11"
Auto

* Factory default menu setting

Layout**Purpose:**

To specify the output layout.

Values:

Auto %*
100% (No Zoom)
2 Pages Up
4 Pages Up

* Factory default menu setting

Network

Use the `Network` option to change the printer settings affecting jobs sent to the printer through the network.

Ethernet**Purpose:**

To specify the communication speed and the duplex settings of Ethernet. To make any changes effective, turn off the printer and then turn it back on.

Values:

Auto*	Detects the Ethernet settings automatically.
10BASE-T Half	Uses 10base-T half-duplex.
10BASE-T Full	Uses 10base-T full-duplex.
100BASE-TX Half	Uses 100base-TX half-duplex.

100BASE-TX Full	Uses 100base-TX full-duplex.
------------------------	------------------------------

* Factory default menu setting

Note:

This menu item appears only when the printer is connected to a wired network.

Wireless Status (AL-MX200DWF only)

Purpose:

To display the information on the wireless signal strength. No changes can be made on the operator panel to improve the status of the wireless connection.

Values:

Connection	Good	Indicates good signal strength.
	Acceptable	Indicates marginal signal strength.
	Low	Indicates insufficient signal strength.
	No Reception	Indicates that no signal is received.
SSID	XXXXXX	As the factory default menu setting, "wireless_device" is specified in advance.
Encryption Type	No Security	A wireless network is configured with no security.
	WEP	A wireless network is configured with the WEP encryption.
	WPA-PSK-TKIP	A wireless network is configured with the WPA-PSK-TKIP encryption.
	WPA2-PSK-AES	A wireless network is configured with the WPA2-PSK-AES encryption.
	Mixed Mode PSK	A wireless network is configured with the Mixed Mode PSK encryption.

Note:

This menu item appears only when the printer is connected to a wireless network.

Wireless Setup (AL-MX200DWF only)

Purpose:

To configure wireless network settings.

Values:

Manual Setup	Enter Network (SSID)	Enter a name of up to 32 alphanumeric characters to identify the wireless network. As the factory default menu setting, "wireless_device" is specified in advance.		
	Infrastructure	Configures a wireless network with access points.		
		No Security*	Configures a wireless network without security encryption.	
		Mixed Mode PSK	Configures a wireless network with the WPA-PSK-TKIP, WPA-PSK-AES and the WPA2-PSK-AES encryption.	
			PassPhrase Entry	Enter a passphrase of 8 to 63 alphanumeric characters.
		WPA-PSK-TKIP	Configures a wireless network with the WPA-PSK-TKIP encryption.	
			PassPhrase Entry	Enter a passphrase of 8 to 63 alphanumeric characters.
		WPA2-PSK-AES	Configures a wireless network with the WPA2-PSK-AES encryption.	
			PassPhrase Entry	Enter a passphrase of 8 to 63 alphanumeric characters.
		WEP	Configures a wireless network with the WEP encryption and specify a WEP key of 5 or 13 ASCII characters; or 10 or 26 hexadecimal characters.	
			Transmit Key	Select the transmit key from Auto, WEP Key 1, WEP Key 2, WEP Key 3, and WEP Key 4.
	Ad-hoc	Configures a wireless network without access points.		
		No Security*	Configures a wireless network without security encryption.	
		WEP	Configures a wireless network with the WEP encryption and specify a WEP key of 5 or 13 ASCII characters; or 10 or 26 hexadecimal characters.	
Transmit Key			Select the transmit key from WEP Key 1, WEP Key 2, WEP Key 3, and WEP Key 4.	

* Factory default menu setting

Note:

This menu item appears only when the printer is connected to a wireless network.

WPS Setup (AL-MX200DWF only)

Push Button Control	PBC Start	No*	Disables the PBC method for the WPS encryption.
		Yes	Enables the PBC method for the WPS encryption.
PIN Code	Start Configuration	Starts configuring wireless network settings using the PIN code assigned automatically by the printer.	
	Print PIN Code	Prints the PIN code to be entered on the computer for the WPS encryption setup.	

* Factory default menu setting

Note:

This menu item appears only when the printer is connected to a wireless network.

Reset Wireless (AL-MX200DWF only)**Purpose:**

To initialize wireless network settings. Enabling this feature and rebooting the printer will reset all the wireless settings to their factory default settings.

Values:

No*	Does not reset the wireless setting.
Yes	Resets the wireless setting.

* Factory default menu setting

Note:

This menu item appears only when the printer is connected to a wireless network.

TCP/IP**Purpose:**

To configure TCP/IP settings. To make any changes effective, turn off the printer and then turn it back on.

Values:

IP Mode	Dual Stack*		Uses both IPv4 and IPv6 to set the IP address.
	IPv4		Uses IPv4 to set the IP address.
IPv4	Get IP Address	DHCP/AutoIP*	Automatically sets the IP address.
		BOOTP	Uses BOOTP to set the IP address.
		RARP	Uses RARP to set the IP address.
		DHCP	Uses DHCP to set the IP address.
		Panel	Enter the IP address on the operator panel.
	IP Address		Enter the IP address allocated to the printer.
	Subnet Mask		Enter the subnet mask.
	Gateway Address		Enter the gateway address.

* Factory default menu setting

Note:

To configure the IPv6 settings, use *EpsonNet Config*.

Protocol

Purpose:

To enable or disable each protocol. To make any changes effective, turn off the printer and then turn it back on.

Values:

LPD	Disable	Disables the Line Printer Daemon (LPD) port.
	Enable* ¹	Enables the LPD port.
Port 9100	Disable	Disables the Port 9100 port.
	Enable* ¹	Enables the Port 9100 port.
WSD* ²	Disable	Disables the Web Services on Devices port.
	Enable* ¹	Enables the Web Services on Devices port.
SNMP	Disable	Disables the Simple Network Management Protocol (SNMP) UDP port.
	Enable* ¹	Enables the SNMP UDP port.

StatusMessenger	Disable	Disables the StatusMessenger feature.
	Enable * ¹	Enables the StatusMessenger feature.
Internet Services	Disable	Disables an access to EpsonNet Config embedded in the printer.
	Enable * ¹	Enables an access to EpsonNet Config embedded in the printer.
Bonjour(mDNS)	Disable	Disables the Bonjour® (mDNS).
	Enable * ¹	Enables the Bonjour (mDNS).

*¹ Factory default menu setting

*² WSD stands for Web Services on Devices.

IP Filter

Note:

The IP Filter feature is supported for IPv4 addresses and available only when Protocol is set to LFD.

Purpose:

To block data received from certain IP addresses through the network. You can set up to five IP addresses. To make any changes effective, turn off the printer and then turn it back on.

Values:

No.n/Address (n is 1 - 5.)		Sets the IP address for Filter <i>n</i> .
No.n/Mask (n is 1 - 5.)		Sets the address mask for Filter <i>n</i> .
No.n/Mode (n is 1 - 5.)	Off *	Disables the IP Filter feature for Filter <i>n</i> .
	Accept	Accepts an access from the specified IP address.
	Reject	Rejects an access from the specified IP address.

* Factory default menu setting

Initialize NVM

Purpose:

To initialize wired network data stored in Non-Volatile Memory (NVM). Enabling this feature and rebooting the printer will reset all the wired network settings to their factory default values.

Values:

Yes	Initializes the wired network data stored in NVM.
No*	Does not initialize the wired network data stored in NVM.

* Factory default menu setting

PS Data Format

Purpose:

To set the PS data communications protocol. To make any changes effective, turn off the printer and then turn it back on.

Values:

Auto*	Sets the PS data communications protocol automatically.
Standard	Sets the PS data communications protocol to Standard.
BCP	Sets the PS data communications protocol to BCP.
TBCP	Sets the PS data communications protocol to TBCP.

* Factory default menu setting

Fax Settings

Use the `Fax Settings` menu to configure the basic fax settings.

Ans Select

Purpose:

To specify the default fax receiving mode.

Values:

TEL Mode	The printer does not automatically receive faxes. To receive an incoming fax, you need to pick up the handset of the connected external telephone and press the 2-digit code.
FAX Mode*	The printer automatically receives faxes.
TEL/FAX Mode	When the printer receives an incoming fax, the external telephone rings for the period of time specified for <code>Auto Ans. TEL/FAX</code> , and then the printer automatically receives a fax. If an incoming call is not a fax, the printer beeps from the internal speaker indicating that the call is a telephone call.

Ans/FAX Mode	The printer shares the telephone line with an answering machine and monitors the line for a fax tone. It will pick up an incoming call if it hears a fax tone. This option is not available in regions where a serial phone system is employed.
DRPD Mode	To use this option, you need to subscribe the Distinctive Ring Pattern Detection (DRPD) service from your telephone company that assigns multiple telephone numbers to a single telephone line and distinguishes each line with a distinctive ring pattern. Once this service is activated, then you can configure your printer to monitor the line for the distinctive ring pattern.

* Factory default menu setting

Auto Answer Fax

Purpose:

To specify a period of time for which the printer waits before entering the FAX Mode upon reception of an incoming call. The interval can be specified within the range of 0 to 255 seconds. The default is 0 second.

Auto Ans. TEL/FAX

Purpose:

To specify a period of time for which the printer waits before entering the FAX Mode when the external telephone receives an incoming call. The interval can be specified within the range of 0 to 255 seconds. The default is 6 seconds.

Auto Ans. Ans/FAX

Purpose:

To specify a period of time for which the printer waits before entering the FAX Mode when the answering machine receives an incoming call. The interval can be specified within the range of 0 to 255 seconds. The default is 21 seconds.

Line Monitor

Purpose:

To specify the volume of the sound that the printer emits from the internal speaker while establishing a connection for fax transmission.

Values:

Off	Turns off the line monitor.
------------	-----------------------------

Min	Sets the volume of the line monitor.
Middle*	
Max	

* Factory default menu setting

Ring Tone Volume

Purpose:

To specify the volume of the ring tone that the printer emits from the internal speaker to indicate an incoming telephone call while in the TEL/FAX Mode.

Values:

Off	Turns off the ring tone.
Min	Sets the volume of the ring tone.
Middle	
Max*	

* Factory default menu setting

Line Type

Purpose:

To specify the line type.

Values:

PSTN*	Sets the line type to PSTN.
PBX	Sets the line type to PBX.

* Factory default menu setting

Dialing Type

Purpose:

To specify the dialing type.

Values:

Tone*	Uses the touch-tone dialing system.
DP (10pps)	Uses the pulse dialing system (10 pulses per second).

* Factory default menu setting

Note:

DP (10PPS) is not displayed when South Africa is set for Region.

Interval Timer

Purpose:

To specify an interval between transmission attempts within the range of 3 to 255 seconds. The default is 8 seconds.

Number of Redial

Purpose:

To specify the number of redial attempts to make when the destination fax number is busy, within the range of 0 to 9. If you specify 0, the printer will not redial. The default is 3.

Redial Delay

Purpose:

To specify an interval between redial attempts within the range of 1 to 15 minutes. The default is 1 minute.

Junk Fax Filter

Purpose:

To reject faxes from the numbers that are not included in the Address Book.

Values:

Off*	Accepts all faxes.
On	Rejects faxes sent from the numbers that are not included in the Address Book.

* Factory default menu setting

Note:

Ensure to register the fax numbers you want to accept faxes from in the Address Book before using Junk Fax Filter.

Remote Receive

Purpose:

To receive a fax by pressing the remote receive code on the external telephone after picking up the handset of the telephone.

Values:

Off*	You cannot receive a fax by pressing the remote receive code on the external telephone.
On	You can receive a fax by pressing the remote receive code on the external telephone.

* Factory default menu setting

Remote Rcv Tone

Purpose:

To specify the remote receive code in two digits to start the Remote Receive action. As the factory default menu setting, 00 is specified in advance.

Send Header

Purpose:

To print the information of sender on the header of faxes.

Values:

Off	Does not print the information of sender on the header of faxes.
On*	Prints the information of sender on the header of faxes.

* Factory default menu setting

Company Name

Purpose:

To specify the name of sender to be printed on the header of faxes. Up to 30 alphanumeric characters can be entered.

Your Fax Number

Purpose:

To specify the fax number of the printer to be printed on the header of faxes.

*Fax Cover Page***Purpose:**

To specify whether to attach a cover page to faxes.

Values:

Off*	Does not attach a cover page to faxes.
On	Attaches a cover page to faxes.

* Factory default menu setting







Note:

The cover page is not printed for direct fax job even if Fax Cover Page is enabled on the operator panel.

*DRPD Pattern***Purpose:**

To provide a separate number for faxing with a distinctive ring pattern.

Values:

Pattern1-7	<p>DRPD is a service provided by some telephone companies. DRPD patterns are specified by your telephone company. The patterns provided with your printer are shown below:</p>
	<p>Pattern1</p> 
	<p>Pattern2</p> 
	<p>Pattern3</p> 
	<p>Pattern4</p> 
	<p>Pattern5</p> 
	<p>Pattern6</p> 
	<p>Pattern7</p> 
<p>Ask your telephone company which pattern you need to select to use this service. For example, Pattern7 is the New Zealand FaxAbility distinctive ring pattern: rings for 400 ms, stops for 800 ms, rings for 400 ms and stops for 1400 ms. This pattern is repeated over and over again. This printer only responds to Distinctive Alert cadence(s) DA4 in New Zealand.</p>	

2-Sided Print

Purpose:

To specify whether to use the duplex printing for faxing.

Values:

Off*	Disables the duplex printing.
On	Enables the duplex printing.

* Factory default menu setting

Forward Settings

Purpose:

To specify whether to forward incoming faxes to a specified destination.

Values:

Off*	Incoming faxes will not be forwarded.
Forward Only	Incoming faxes will be forwarded to a specified destination and, if an error occurs while forwarded, they will be printed.
Forward and Print	Incoming faxes will be forwarded to a specified destination, and then printed from your printer.
E-Mail and Print	Incoming faxes will be sent with an e-mail to a specified destination, and then printed from your printer.

* Factory default menu setting

Fax Fwd Number

Purpose:

To enter the fax number of the destination to which incoming faxes will be forwarded.

Fax Fwd E-Mail

Purpose:

To enter the e-mail address to which incoming faxes will be sent with an e-mail.

Prefix Dial

Purpose:

To specify whether to insert a prefix dial number.

Values:

Off*	Does not insert a prefix dial number.
-------------	---------------------------------------

On	Inserts a prefix dial number.
-----------	-------------------------------

* Factory default menu setting

Prefix Dial Num

Purpose:

To specify the prefix dial number of up to five digits. This number will be dialed before any automatic dialing number is started. It is useful for accessing the Private Automatic Branch Exchange (PABX).

Discard Size

Purpose:

To specify whether to discard text or images at the bottom of a fax page when the entire page does not fit onto the output paper.

Values:

Off	Prints any excess at the bottom of a fax page without discarding it.
On	Discards any excess at the bottom of a fax page.
Auto Reduction*	Automatically reduces a fax page to fit it onto the output paper.

* Factory default menu setting

ECM

Purpose:

To specify whether to enable the Error Correction Mode (ECM). To use the ECM, the remote fax machines must also support the ECM.

Values:

Off	Disables the ECM.
On*	Enables the ECM.

* Factory default menu setting

Extel Hook Thresh

Purpose:

To specify the external telephone hook detection threshold for the condition in which a telephone line is not being used.

Values:

Lower	Sets the external telephone hook detection threshold to Lower .
Normal*	Sets the external telephone hook detection threshold to Normal .
Higher	Sets the external telephone hook detection threshold to Higher .

* Factory default menu setting

*Modem Speed***Purpose:**

To specify the fax modem speed when a fax transmission or reception error occurs.

Values:

2.4 Kbps
4.8 Kbps
9.6 Kbps
14.4 Kbps
33.6 Kbps*

* Factory default menu setting

*Fax Activity***Purpose:**

To specify whether to automatically print the Fax Activity Report after every 50 incoming and outgoing fax communications.

Values:

Auto Print*	Automatically prints the Fax Activity Report after every 50 incoming and outgoing fax communications.
No Auto Print	Does not automatically print the Fax Activity Report.

* Factory default menu setting

Fax Transmit

Purpose:

To specify whether to print a transmission report after every fax transmission or only when an error occurs.

Values:

Print Always	Prints a transmission report after every fax transmission.
Print On Error*	Prints a transmission report only when an error occurs.
Print Disable	Does not print a transmission report after a fax transmission.

* Factory default menu setting

Fax Broadcast

Purpose:

To specify whether to print a transmission report after every fax transmission to multiple destinations or only when an error occurs.

Values:

Print Always*	Prints a transmission report after every fax transmission to multiple destinations.
Print On Error	Prints a transmission report only when an error occurs.
Print Disable	Does not print a transmission report after a fax transmission to multiple destinations.

* Factory default menu setting

Region

Purpose:

To specify the region where the printer is used.

System Settings

Use the `System Settings` menu to configure a variety of printer features.

Power Saver Timer

Purpose:

To specify a time period before the printer enter each power saver mode.

Values:

Low Power Timer	1min*	By default, the printer enters Low Power mode in one minute of inactivity after completion of the last job. You can change the Low Power Timer setting within a range from 1 to 45 minutes.
	1min - 45min	
Sleep Timer	6min*	By default, the printer enters Sleep mode in six minutes of inactivity starting from the moment it entered Low Power mode. You can change the Sleep Timer setting within a range from 6 to 11 minutes.
	6min - 11min	

* Factory default menu setting

Select 1min (default) for Low Power Timer if your printer shares an electrical circuit with your room lights and you notice them flickering. Otherwise, select a high value to keep your printer available for frequent use with the minimum warm-up time.

The printer automatically exits a power saver mode when it receives a print job from a computer or fax data through the telephone line. Alternatively, you can manually bring it back to the ready-to-print state. Press any button on the operator panel in Low Power mode. In Sleep mode, press the  (**Energy Saver**) button. Whether the printer is in Low Power or Sleep mode, it will take about 25 seconds for the printer to resume the ready-to-print state.

*Auto Reset***Purpose:**

To specify a time period before the printer restores the default setting for the current menu item and resumes the ready-to-print state when an attempt to change the setting is left unfinished.

Values:

45sec*
1min
2min
3min
4min

* Factory default menu setting

Fault Time-Out

Purpose:

To specify a time period before the printer cancels a job that has halted abnormally. Any job will be cancelled when it times out.

Values:

Off		Disables the fault time-out feature.
On	60sec*	By default, the printer cancels a job in 60 seconds after the job halts abnormally. You can change the setting within a range from 3 to 300 seconds.
	3sec - 300sec	

* Factory default menu setting

Job Time-Out

Purpose:

To specify a time period that the printer waits to receive data from a computer. Any print job will be cancelled when it times out.

Values:

Off		Disables the job time-out feature.
On	30sec*	By default, the printer waits to receive data from a computer for 30 seconds. You can change the setting within a range from 5 to 300 seconds.
	5sec - 300sec	

* Factory default menu setting

Clock Settings

Purpose:

To specify the date and time, and regional time zone of the printer.

Values:

Set Date	Sets the current date.
Set Time	Sets the current time.

Date Format	yy/mm/dd	Sets the date format.
	mm/dd/yy	
	dd/mm/yy*	
Time Format	12H	Sets the time format.
	24H*	
Time Zone		Sets the time zone.

* Factory default menu setting

Alert Tone

Purpose:

To configure settings for tones emitted by the printer during operation or when a warning message appears.

Values:

Panel Select Tone	Off*	Does not emit a tone when the operator panel input is correct.
	Min	Emits a tone at the specified volume when the operator panel input is correct.
	Middle	
	Max	
Panel Alert Tone	Off*	Does not emit a tone when the operator panel input is incorrect.
	Min	Emits a tone at the specified volume when the operator panel input is incorrect.
	Middle	
	Max	
Auto Clear Alert	Off*	Does not emit a tone before the printer performs auto clear.
	Min	Emits a tone at the specified volume five seconds before the printer performs auto clear.
	Middle	
	Max	

Job Tone	Off	Does not emit a tone when a job is complete.
	Min	Emits a tone at the specified volume when a job is complete.
	Middle*	
	Max	
Alert Tone	Off	Does not emit a tone when a problem occurs.
	Min	Emits a tone at the specified volume when a problem occurs.
	Middle*	
	Max	
Out of Paper	Off	Does not emit a tone when the printer runs out of paper.
	Min	Emits a tone at the specified volume when the printer runs out of paper.
	Middle*	
	Max	
All Tones	Off	Disables all the alert tones.
	Min	Sets the volume of all the alert tones at once.
	Middle*	
	Max	

* Factory default menu setting

mm / inch

Purpose:

To specify the measurement unit after the numeric value displayed on the operator panel.

Values:

Millimeters (mm)*
Inches (")

* Factory default menu setting

2-Sided Report

Purpose:

To specify whether to print a report on either side of paper.

Values:

2-Sided	Prints a report on either side of paper.
1-Sided*	Prints a report on the single side of paper.

* Factory default menu setting

*Low Toner Alert Msg***Purpose:**

To specify whether to show the alert message when the toner is low.

Values:

Off	Does not show the alert message when the toner is low.
On*	Shows the alert message when the toner is low.

* Factory default menu setting

*Power On Wizard***Purpose:**

To perform initial settings for the printer.

See Also:

“Setting Initial Settings on the Operator Panel” on page 29

Values:

Yes	Performs the initial settings for the printer.
No*	Does not perform the initial settings for the printer.

* Factory default menu setting

Maintenance

Use the **Maintenance** menu to adjust print settings for each paper type, initialize the Non-Volatile Memory (NVM), and change the toner cartridge settings.

*F/W Version***Purpose:**

To display the version of the controller.

Adjust BTR

Purpose:

To specify a voltage of the transfer roller (BTR) for optimum printing of each paper type. To lower the voltage, specify a negative value. To increase, specify a positive value.

The default settings may not yield the best output on all paper types. If you see mottles on the print output, try increasing the voltage. If you see white spots on the print output, try decreasing the voltage.

Note:

The print quality depends on the values you select for this menu item.

Values:

Plain	0*
	-3 - 3
Light Card	0*
	-3 - 3
Labels	0*
	-3 - 3
Recycled	0*
	-3 - 3
Envelope	0*
	-3 - 3
Postcard	0*
	-3 - 3

* Factory default menu setting

Adjust Fusing Unit

Purpose:

To specify a temperature of the fusing unit for optimum printing of each paper type. To lower the temperature, specify a negative value. To increase, specify a positive value.

The default settings may not yield the best output on all paper types. When the printed paper has curled, try lowering the temperature. When the toner does not fuse on the paper properly, try increasing the temperature.

Note:

The print quality depends on the values you select for this menu item.

Values:

Plain	0*
	-3 - 3
Light Card	0*
	-3 - 3
Labels	0*
	-3 - 3
Recycled	0*
	-3 - 3
Envelope	0*
	-3 - 3
Postcard	0*
	-3 - 3

* Factory default menu setting

Density Adjustment**Purpose:**

To adjust the print density level within the range of -3 to 3 . The factory default menu setting is 0 .

Clean Developer**Purpose:**

To rotate the developer motor and stir the toner in the toner cartridge.

Values:

Yes	Stirs the toner in a new toner cartridge.
No*	Does not stir the toner in a new toner cartridge.

* Factory default menu setting

Toner Refresh

Purpose:

To use up a toner cartridge when you need to replace it before the end of its life, or to stir the toner in a new toner cartridge.

Values:

Black	Yes	Cleans the toner in the toner cartridge.
	No*	Does not clean the toner in the toner cartridge.

* Factory default menu setting

Machine life

Purpose:

To specify whether to continue print operations when the printer comes to the end of its service life.

Values:

Stop Print*	Stops print operations at the end of service life.
Continue Print	Continues print operations after the end of service life.

* Factory default menu setting

Note:

- When the printer no longer operates showing the error code 191-310 on the LCD panel, operate as follows to keep using the printer:
 - if a job is remaining, press the **⏪ (Back)** button and the **▼** button at the same time.
 - if there is no job, select Continue Print in this menu.
- Although you can keep using the printer after the end of its service life by changing the setting to Continue Print, the printing quality is not guaranteed.

Initialize NVM

Purpose:

To initialize the NVM for the printer settings, the Phone Book data for fax, and the Address Book data for scan. Enabling this feature and rebooting the printer will reset all the printer settings and all the Phone Book (fax) and Address Book (scan) data to their factory default values.

See Also:

“Resetting to Factory Defaults” on page 323

Values:

User Fax Section	Yes	Initializes the Speed Dial and Group Dial entries in the Phone Book.
	No*	Does not initialize the Speed Dial and Group Dial entries in the Phone Book.
User Scan Section	Yes	Initializes the e-mail and server address entries in the Address Book.
	No*	Does not initialize the e-mail and server address entries in the Address Book.
System Section	Yes	Initializes the printer settings.
	No*	Does not initialize the printer settings.

* Factory default menu setting

Non Genuine Toner

Purpose:

To use a toner cartridge of another manufacturer.

Note:

- Using a non-genuine toner cartridge may make some printer features unusable, reduce print quality and decrease the reliability of your printer. We recommend you use only new Epson brand toner cartridges for your printer. We do not provide warranty coverage for problems caused by using non-genuine consumables.*
- Before you use a toner cartridge of another manufacturer, be sure to restart the printer.*

Values:

Toner	Off*	Does not use a toner cartridge of another manufacturer.
	On	Uses a toner cartridge of another manufacturer.

* Factory default menu setting

Adjust Altitude

Purpose:

To specify the altitude of the location where the printer is installed.

The discharge phenomenon for charging the photo conductor varies with barometric pressure. You can specify the altitude of the printer location for adjustment.

Note:

An incorrect altitude adjustment leads to poor printing quality and an incorrect indication of remaining toner.

Values:

0m*	Select the altitude of the location where the printer is installed.
1000m	
2000m	
3000m	

* Factory default menu setting

Secure Settings

Use the `Secure Settings` menu to set a password to limit access to the operator panel menus. This prevents the printer settings from being changed accidentally.

Panel Lock

Purpose:

To restrict access to `Admin Menu` and `Report / List` with a password.

See Also:

"Panel Lock Feature" on page 320

Note:

You can select `Disable for Panel Lock Set` when all items under `Service Lock` are set to `Unlocked` and `Secure Receive Set` is set to `Disable`.

Values:

Panel Lock Set	Disable *1	Does not restrict access to Admin Menu and Report / List with a password.
	Enable	Restricts access to Admin Menu and Report / List with a password.
Change Password *2	0000 *1- 9999	Sets or changes the password required to access Admin Menu and Report / List.

*1 Factory default menu setting

*2 Not displayed when Panel Lock Set is set to Disable.

Service Lock

Purpose:

To specify whether to enable each of the printer services or to require a password to use the services, and to set or change the password.

See Also:

“Limiting Access to Copy, Fax, Scan, and USB Direct Print Operations” on page 321

Note:

You can access to the items under Service Lock only when Panel Lock Set is set to Enable.

Values:

Copy	Unlocked *1	Enables the Copy function.
	Locked	Disables the Copy function.
	Password Locked	Enables the Copy function, but requires a password.
FAX	Unlocked *1	Enables the Fax function.
	Locked	Disables the Fax function (the printer will not send or receive faxes).
	Password Locked	Enables the Fax function, but requires a password to send faxes (does not require a password to receive incoming faxes).
Scan	Unlocked *1	Enables the Scan function.
	Locked	Disables the Scan function.
	Password Locked	Enables the Scan function, but requires a password.

Print from USB	Unlocked ^{*1}	Enables the Print From USB Memory feature.
	Locked	Disables the Print From USB Memory feature.
	Password Locked	Enables the Print From USB Memory feature, but requires a password.
Change Password ^{*2}	0000 ^{*1} - 9999	Sets or changes the password required to use the Copy, Fax, and Scan functions and the Print From USB Memory feature.

^{*1} Factory default menu setting

^{*2} Displayed only when any of the `Service Lock` items is set to `Password Locked`.

Secure Receive

Purpose:

To specify whether to require a password to print incoming faxes, and to set or change the password. When `Secure Receive Set` is set to `Enable`, the printer stores incoming faxes and prints them when the correct password is entered on the operator panel.

Note:

You can access to the items under `Secure Receive` only when `Panel Lock Set` is set to `Enable`.

Values:

Secure Receive Set	Disable ^{*1}	Does not require a password to print incoming faxes.
	Enable	Requires a password to print incoming faxes.
Change Password ^{*2}	0000 ^{*1} - 9999	Sets or changes the password required to print incoming faxes.

^{*1} Factory default menu setting

^{*2} Not displayed when `Secure Receive Set` is set to `Disable`.

Software Download

Purpose:

To install or discard the software data downloaded and sent by the connected computer.

Values:

Disable	Discards the downloaded software data to maximize data security.
Enable [*]	Installs the downloaded software data.

^{*} Factory default menu setting

Scan to E-Mail

Use the `Scan to E-Mail` menu to edit the transmission source.

Edit From Field

Purpose:

To enable or disable editing of the transmission source.

Values:

Disable	Disables editing of the transmission source.
Enable*	Enables editing of the transmission source.

* Factory default menu setting

USB Settings

Use the `USB Settings` menu to change printer settings affecting a USB port.

Port Status

Purpose:

To enable or disable the USB interface.

Values:

Disable	Disables the USB interface.
Enable*	Enables the USB interface.

* Factory default menu setting

PS Data Format

Purpose:

To set the PS data communications protocol. To make any changes effective, turn off the printer and then turn it back on.

Values:

Auto*	Sets the PS data communications protocol automatically.
Standard	Sets the PS data communications protocol to Standard.

BCP	Sets the PS data communications protocol to BCP.
TBCP	Sets the PS data communications protocol to TBCP.

* Factory default menu setting

Defaults Settings

Use the Defaults Settings menu to configure the default copy, scan, and fax settings of the printer.

Copy Defaults

Use the Copy Defaults menu to configure a variety of copy features.

Original Size

Purpose:

To specify the default document size.

Values:

A4 - 210x297mm*
A5 - 148x210mm
B5 - 182x257mm
Letter - 8.5x11"
Folio - 8.5x13"
Legal - 8.5x14"
Executive

* Factory default menu setting

Reduce/Enlarge

Purpose:

To specify the default copy reduction/enlargement ratio.

Values:

mm system

200%
A5->A4(141%)
A5->B5(122%)
100%*
B5->A5(81%)
A4->A5(70%)
50%

* Factory default menu setting

inch system

200%
Stmt->Lgl(154%)
Stmt->Ltr(129%)
100%*
Lgl->Ltr (78%)
Ldgr->Ltr(64%)
50%

* Factory default menu setting

Note:

- You can also use the numeric keypad to input the desired zoom ratio from 25% to 400%, or press the ► button to enlarge the zoom ratio or press the ◀ button to reduce the zoom ratio in 1% intervals.
- This item is available only when Multiple Up is set to Off or Manual.

Collated

Purpose:

To specify whether to collate the copy job.

Values:

Off*	Does not copy documents in the collated order.
-------------	--

On	Copies documents in the collated order.
-----------	---

* Factory default menu setting

Document Type

Purpose:

To specify the default document type.

Values:

Text	Suitable for documents with text.
Mixed*	Suitable for documents with both text and photos/gray tones.
Photo	Suitable for documents with photos.

* Factory default menu setting

Lighten/Darken

Purpose:

To specify the default copy density level.

Values:

Lighten2	Makes the copy lighter than the source document. Works well with dark print.
Lighten1	
Normal*	Works well with standard typewritten or printed documents.
Darken1	Makes the copy darker than the source document. Works well with light print or faint pencil markings.
Darken2	

* Factory default menu setting

Sharpness

Purpose:

To specify the default sharpness level.

Values:

Sharpest	Makes the copy sharper than the source document.
Sharper	
Normal*	Does not make the copy sharper or softer than the original.
Softer	Makes the copy softer than the source document.
Softest	

* Factory default menu setting

Auto Exposure

Purpose:

To suppress the background of the original to enhance text on the copy.

Values:

Off	Does not suppress the background.
On*	Suppresses the background of the original to enhance text on the copy.

* Factory default menu setting

Gray Balance

Purpose:

To specify the default gray balance level within the range of -2 to 2 . The factory default menu setting is 0 .

2-Sided

Purpose:

To specify whether to print on either sides of paper.

Values:

1->1-Sided*	Makes regular single-sided copies.
Flip on Long Edge	Makes duplex (2-sided) copies ready to be bound on the long edge.
Flip on Short Edge	Makes duplex (2-sided) copies ready to be bound on the short edge.

* Factory default menu setting

Multiple Up

Purpose:

To print two original pages to fit onto one sheet of paper.

Values:

Off*	Makes regular one-to-one copies of the source documents.
Auto	Automatically reduces the size of the source documents to print all of them on a single sheet of paper.
ID Card Copy	Prints both sides of the ID card on a single sheet of paper in the original size.
Manual	Reduces the size of the source documents according to the <i>Reduce/Enlarge</i> setting and print all of them on a single sheet of paper.

* Factory default menu setting

Margin Top/Bottom

Purpose:

To specify the value of the top and bottom margins.

Values:

4mm*/0.2inch*	Specify the value in increments of 1 mm/0.1 inch. Which factory default menu setting displays depends on the value selected for <i>mm / inch</i> under the <i>System Settings</i> menu. See "mm / inch" on page 294 for more information.
0 - 50mm/0.0 - 2.0inch	

* Factory default menu setting

Margin Left/Right

Purpose:

To specify the value of the left and right margins.

Values:

4mm*/0.2inch*	Specify the value in increments of 1 mm/0.1 inch. Which factory default menu setting displays depends on the value selected for <i>mm / inch</i> under the <i>System Settings</i> menu. See "mm / inch" on page 294 for more information.
0 - 50mm/0.0 - 2.0inch	

* Factory default menu setting

Margin Middle

Purpose:

To specify the value of the middle margin.

Values:

0mm*/0.0inch*	Specify the value in increments of 1 mm/0.1 inch. Which factory default menu setting displays depends on the value selected for mm / inch under the System Settings menu. See "mm / inch" on page 294 for more information.
0 - 50mm/0.0 - 2.0inch	

* Factory default menu setting

Paper Error

Purpose:

To specify whether to display an error when the specified output paper size does not match the loaded paper.

Important:

Printing repeatedly on the paper smaller than the specified output paper size may make the interior of your printer dirty, which may result in poor print quality or breakdown in your printer.

Values:

Off*	Does not display an error when the specified output paper size does not match the loaded paper.
On	Displays an error when the specified output paper size does not match the loaded paper.

* Factory default menu setting

Scan Defaults

Use the **Scan Defaults** menus to configure a variety of scan features.

Scan to Network

Purpose:

To store the scanned image on a network server or on a computer.

Values:

Computer(Network)*	Stores the scanned image on a computer using the Server Message Block (SMB) protocol.
Server(FTP)	Stores the scanned image on a server using the FTP protocol.

* Factory default menu setting

File Format

Purpose:

To specify the file format to save the scanned image.

Values:

PDF*
MultiPageTIFF
TIFF
JPEG

* Factory default menu setting

Color

Purpose:

To set the color mode.

Values:

Black & White	Scans in black and white mode. This is available only when File Format is set to PDF or TIFF.
Grayscale	Scans in grayscale mode.
Color*	Scans in color mode.
Color(Photo)	Scans in color mode. This is suitable for photographic images.

* Factory default menu setting

Resolution

Purpose:

To specify the default scan resolution.

Values:

200 x 200dpi*
300 x 300dpi
400 x 400dpi
600 x 600dpi

* Factory default menu setting

Document Size

Purpose:

To specify the default document size.

Values:

A4 - 210x297mm*
A5 - 148x210mm
B5 - 182x257mm
Letter - 8.5x11"
Folio - 8.5x13"
Legal - 8.5x14"
Executive

* Factory default menu setting

Lighten/Darken

Purpose:

To specify the default scan density level.

Values:

Lighten2	Makes the scanned image lighter than the original. Works well with dark print.
Lighten1	
Normal*	Works well with standard typewritten or printed documents.

Darken1	Makes the scanned image darker than the original. Works well with light print or faint pencil markings.
Darken2	

* Factory default menu setting

Sharpness

Purpose:

To specify the default sharpness level.

Values:

Sharpest	Makes the scanned image sharper than the original.
Sharper	
Normal*	Does not make the scanned image sharper or softer than the original.
Softer	Makes the scanned image softer than the original.
Softest	

* Factory default menu setting

Auto Exposure

Purpose:

To suppress the background of the original to enhance text on the scanned image.

Values:

Off	Does not suppress the background.
On*	Suppresses the background of the original to enhance text on the scanned image.

* Factory default menu setting

Margin Top/Bottom

Purpose:

To specify the value of the top and bottom margins.

Values:

2mm*/0.1inch*	Specify the value in increments of 1 mm/0.1 inch. Which factory default menu setting displays depends on the value selected for mm / inch under the System Settings menu. See "mm / inch" on page 294 for more information.
0 - 50mm/0.0 - 2.0inch	

* Factory default menu setting

Margin Left/Right

Purpose:

To specify the value of the left and right margins.

Values:

2mm*/0.1inch*	Specify the value in increments of 1 mm/0.1 inch. Which factory default menu setting displays depends on the value selected for mm / inch under the System Settings menu. See "mm / inch" on page 294 for more information.
0 - 50mm/0.0 - 2.0inch	

* Factory default menu setting

Margin Middle

Purpose:

To specify the value of the middle margin.

Values:

0mm*/0.0inch*	Specify the value in increments of 1 mm/0.1 inch. Which factory default menu setting displays depends on the value selected for mm / inch under the System Settings menu. See "mm / inch" on page 294 for more information.
0 - 50mm/0.0 - 2.0inch	

* Factory default menu setting

TIFF File Format

Purpose:

To specify the TIFF file format.

Values:

TIFF V6*
TTN2

* Factory default menu setting

Image Compression

Purpose:

To specify the image compression level.

Values:

Higher	Sets the higher image compression level.
Normal*	Sets the normal image compression level.
Lower	Sets the lower image compression level.

* Factory default menu setting

Max E-Mail Size

Purpose:

To specify the maximum size of e-mail that can be sent, within the range of 50KB to 16384KB. The default is 2048KB.

Fax Defaults

Use the Fax Defaults menus to configure a variety of fax features.

Note:

The Fax service cannot be used unless you specify your region under Region. If Region is set to Unknown, the message Set The Region Code appears on the LCD panel.

Resolution

Purpose:

To specify the resolution level to be used for fax transmission.

Values:

Standard*	Suitable for documents with normal sized characters.
Fine	Suitable for documents containing small characters or thin lines or documents printed with a dot-matrix printer.
SuperFine(203dpi)	Suitable for documents containing extremely fine details. The SuperFine(203dpi) mode is effective only when the remote fax machine supports the super fine resolution. See the notes below.

SuperFine(406dpi)	Suitable for documents containing photographic images.
--------------------------	--

* Factory default menu setting

Note:

Faxes scanned in the SuperFine(203dpi) mode are received at the highest resolution of the remote machine.

Document Type

Purpose:

To specify the default document type.

Values:

Text*	Suitable for documents with text.
Photo	Suitable for documents with photos.

* Factory default menu setting

Lighten/Darken

Purpose:

To specify the default fax density level.

Values:

Lighten2	Makes the fax lighter than the source document. Works well with dark print.
Lighten1	
Normal*	Works well with standard typewritten or printed documents.
Darken1	Makes the fax darker than the source document. Works well with light print or faint pencil markings.
Darken2	

* Factory default menu setting

Delayed Start

Purpose:

This feature enables you to set a specific time for the fax transmission to start. Once Delayed Start mode is activated, your printer stores all of the documents to be faxed into its memory and sends them at the specified time. After faxing in the Delayed Start mode is complete, the data in the memory is cleared.

Values:

21:00* /PM 9:00*	Specify the fax transmission start time when sending a fax at a specified time. Which factory default menu setting displays depends on the value set for Time Format under the System Settings menu. See "Changing the Clock Mode" on page 223 for more information.
0:00 - 23:59 / AM/PM 1:00 - 12:59	

* Factory default menu setting

Note:

A maximum of 19 delayed fax jobs can be stored in this printer.

Print from USB Defaults

Use the Print from USB Defaults menus to configure the Print From USB Memory feature.

2-Sided**Purpose:**

To specify whether to print on either side of paper.

Values:

1->1-Sided*	Prints on a single side of paper.
Flip on Long Edge	Prints on either side of paper to be bound on the long edge.
Flip on Short Edge	Prints on either side of paper to be bound on the short edge.

* Factory default menu setting

Layout**Purpose:**

To specify the output layout.

Values:

1UP*
2UP
4UP

* Factory default menu setting

AutoFit

Purpose:

To automatically enlarge/reduce the size of the image to fit it into the paper selected for printing.

Values:

Auto*	Reduces/enlarges the size of the image to fit it into the paper before printing.
Off	Prints the image as it is.

* Factory default menu setting

Note:

This item is available only when a TIFF or JPG file is selected for printing.

PDF Password

Purpose:

To specify a password for printing secure PDF files.

Values:

*****	Enter a password of up to 32 alphanumeric characters for printing secure PDF files.
-------	---

Tray Settings

Use the `Tray Settings` option to set the paper size and type of paper loaded in the paper tray.

Paper Tray

Purpose:

To specify the paper loaded in the paper tray.

Values:

Paper Size	A4 - 210x297mm *
	A5 - 148x210mm
	B5 - 182x257mm
	Letter - 8.5x11"
	Folio - 8.5x13"
	Legal - 8.5x14"
	Executive
	Statement
	#10 Env. - 4.125x9.5"
	Monarch Env.
	Monarch Env. L
	DL Env. - 110x220mm
	DL Env. L
	C5 Env. - 162x229mm
	Postcard JPN - 148x100mm
	W-Postcard JPN - 148x200mm
	Env Yougata 2
	Env Yougata 2L
	Env Yougata 3
	Env Yougata 3L
	Env Yougata 4
	Env Yougata 6
	Env Younaga 3
	Env Nagagata 3
	Env Nagagata 4
Env Kakugata 3	

	New Custom Size	Portrait(Y)	297mm*/11.7inch*	Specifies the length of the custom size paper. Which factory default menu setting displays depends on the value selected for mm / inch under the System Settings menu. See "mm / inch" on page 294 for more information.
			127mm - 355mm/ 5.0inch - 14.0inch	
	Landscape(X)	210mm*/8.3inch*	Specifies the width of the custom size paper. Which factory default menu setting displays depends on the value selected for mm / inch under the System Settings menu. See "mm / inch" on page 294 for more information.	
		77mm - 215mm/ 3.0inch - 8.5inch		
Paper Type	Plain*			
	Light Card			
	Labels			
	Recycled			
	Envelope			
	Postcard			

* Factory default menu setting

Note:

For details on the supported paper sizes, see "Usable Print Media" on page 119.

Panel Language

Purpose:

To specify the language to be used on the operator panel.

See Also:

"Changing the Language" on page 324

Values:

English*	English
Français	French
Italiano	Italian
Deutsch	German

Español	Spanish
Nederlands	Dutch
Português Europeu	Portuguese
Türkçe	Turkish
Русский	Russian
繁體中文	Traditional Chinese
한국어	Korean

* Factory default menu setting

Panel Lock Feature

This feature prevents unauthorized users from changing the settings on the operator panel made by the administrator. However, you can modify the settings for individual print jobs using the print driver.

Enabling the Panel Lock Feature

1. Press the **System** button.
2. Select Admin Menu, and then press the **OK** button.
3. Select Secure Settings, and then press the **OK** button.
4. Select Panel Lock, and then press the **OK** button.
5. Select Panel Lock Set, and then press the **OK** button.
6. Select Enable, and then press the **OK** button.
7. If necessary, select Change Password, and then press the **OK** button.
8. Enter a new password, and then press the **OK** button.

Note:

The factory-default panel password is 0000.

Note:

- ❑ Be sure to remember the password. The procedure described below allows you to reset the password. Turn off the printer. Then, while holding the **System** button, turn on the printer.
- ❑ If you want to change the password while Panel Lock Set is Enable, perform steps 1 and 2. Enter the current password, and then press the **OK** button. Perform steps 3 and 4. Select Change Password, and then press the **OK** button. Enter a new password, and then press the **OK** button. This will change the password.

Disabling the Panel Lock Feature

Note:

You can select Disable for Panel Lock Set when all items under Service Lock are set to Unlocked and Secure Receive Set is set to Disable.

1. Press the **System** button.
2. Select Admin Menu, and then press the **OK** button.
3. Enter the password, and then press the **OK** button.
4. Select Secure Settings, and then press the **OK** button.
5. Select Panel Lock, and then press the **OK** button.
6. Select Panel Lock Set, and then press the **OK** button.
7. Select Disable, and then press the **OK** button.

Note:

The password is reset to 0000 when the setting for Panel Lock Set is changed from Enable to Disable.

Limiting Access to Copy, Fax, Scan, and USB Direct Print Operations

Enabling the Copy, FAX, Scan, and Print from USB lock options limits access to copy, fax, scan, and USB direct print operations.

Taking the **Copy** lock option as an example, the following procedure explains how to enable or disable the option. Use the same procedure to enable or disable the **FAX**, **Scan**, and **Print from USB** lock options.

1. Press the **System** button.
2. Select **Admin Menu**, and then press the **OK** button.
3. Select **Secure Settings**, and then press the **OK** button.
4. Select **Panel Lock**, and then press the **OK** button.
5. Select **Panel Lock Set**, and then press the **OK** button.
6. Select **Enable**, and then press the **OK** button.
7. If necessary, select **Change Password**, and change the password using the numeric keypad. Then, press the **OK** button.

Note:

The factory-default panel password is 0000.

8. Press the **↶ (Back)** button.
9. Select **Service Lock**, and then press the **OK** button.
10. Select **Copy**, and then press the **OK** button.
11. Select one of the following options, and then press the **OK** button.
 - Unlocked
 - Locked
 - Password Locked

Changing the Power Saver Mode Settings

The printer enters a power saver mode after the specified time period of inactivity. You can set **Power Saver Timer** to place the printer in either of the power saver modes.

1. Press the **System** button.
2. Select Admin Menu, and then press the **OK** button.
3. Select System Settings, and then press the **OK** button.
4. Select Power Saver Timer, and then press the **OK** button.
5. Select Low Power Timer, or Sleep Timer, and then press the **OK** button.
6. Press the ▲ or ▼ button or enter the desired value using the numeric keypad, and then press the **OK** button.
You can select from 1 - 45 minutes for Low Power Timer or 6 - 11 minutes for Sleep Timer.

Resetting to Factory Defaults

Enabling the Initialize NVM feature and rebooting the printer will reset all the printer settings and the Phone Book (fax) and Address Book (scan) data to their factory default menu settings.

Note:

The following procedure does not initialize the network settings.

- ❑ *To initialize the wired network settings, see “Initialize NVM” on page 279.*
- ❑ *To initialize the wireless network settings on the AL-MX200DWF model, see “Reset Wireless (AL-MX200DWF only)” on page 277.*

1. Press the **System** button.
2. Select Admin Menu, and then press the **OK** button.
3. Select Maintenance, and then press the **OK** button.
4. Select Initialize NVM, and then press the **OK** button.
5. Select System Section to initialize the printer settings, and then press the **OK** button.

Select User Fax Section to initialize the Phone Book data for fax.

Select User Scan Section to initialize the Address Book data for scan.

6. Select Yes, and then press the **OK** button.

The printer restarts automatically with the factory default menu settings.

Changing the Language

To display a different language on the operator panel:

Using the Operator Panel

1. Press the **System** button.
2. Select **Panel Language**, and then press the **OK** button.
3. Select the desired language, and then press the **OK** button.

Using the Printer Setting Utility

The following procedure uses Microsoft® Windows® 7 as an example.

1. Click **Start** — **All Programs** — **EPSON** — your printer — **Printer Setting Utility**.

Note:

*The window to select a printer appears in this step, when multiple print drivers are installed on your computer. In this case, click the name of the desired printer listed in **Printer Name**.*

The Printer Setting Utility appears.

2. Click the **Printer Maintenance** tab.
3. Select **System Settings** from the list at the left side of the page.

The **System Settings** page is displayed.

4. Select the desired language from **Panel Language**, and then click the **Apply New Settings** button.

Using the Numeric Keypad

As you perform various tasks, you may need to enter numbers and names. For example, when you enter the password, you enter four-digit number. When you set up your printer, you enter your name or your company name.

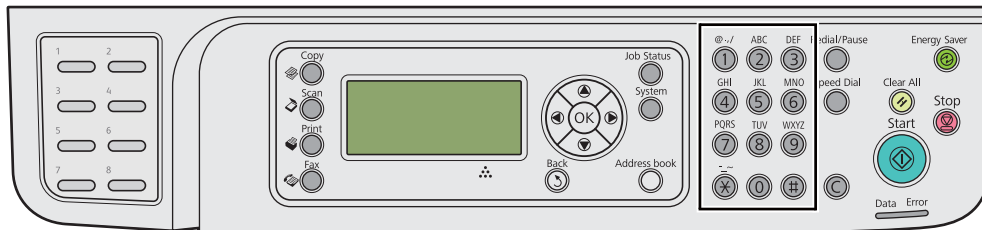

Entering Characters

When prompted to enter a letter, press the appropriate button until the correct letter appears on the LCD panel.

For example, to enter the letter O, press **6**.

- Each time you press **6**, the display shows a different letter, m, n, o, M, N, O and finally 6.
- To enter additional letters, repeat the first step.
- Press the **OK** button when you are finished.

Key	Assigned numbers, letters or characters
1	1 @ . _ - (space) \ & () ! " # \$ % ' ~ ^ ` ; : ? , + * / = [] { } < >
2	a b c A B C 2
3	d e f D E F 3
4	g h i G H I 4
5	j k l I J K L 5
6	m n o M N O 6
7	p q r s P Q R S 7
8	t u v T U V 8
9	w x y z W X Y Z 9

Key	Assigned numbers, letters or characters
0	0
*	- _ ~
#	(space) & ()

Changing Numbers or Names

If an incorrect number or name is entered, press the **C (Clear)** button to clear the number or character. Then enter the correct number or character.

Chapter 10

Troubleshooting

Clearing Jams

Careful selection of appropriate print media and proper loading allow you to avoid most jams.



Warning:

If you cannot remove the paper jam by doing the procedures in the manual, do not try to forcibly remove the jam. Doing so may cause injuries. Contact your local Epson representative.

See Also:

- “About Print Media” on page 115
- “Supported Print Media” on page 119

Note:

Before buying large quantities of any print media, it is recommended that you try a sample first.

Avoiding Jams

- Use only recommended print media.
- See “Loading Print Media in the Paper Tray” on page 123 and “Loading Print Media in the Priority Sheet Inserter (PSI)” on page 132 to load print media properly.
- Do not load print media before turning on the printer.
- Do not overload the print media sources.
- Do not load wrinkled, creased, damp, or curled print media.
- Flex, fan, and straighten print media before you load it. If a jam occurs with print media, try feeding one sheet at a time through the paper tray or the Priority Sheet Inserter (PSI).
- Do not use print media that you have cut or trimmed.
- Do not mix print media sizes, weights, or types in the same print media source.
- Ensure that the recommended print surface is face up when you load print media in the paper tray or the Priority Sheet Inserter (PSI).

- ❑ Keep print media stored in an acceptable environment.
- ❑ Do not remove the paper tray cover while printing is in progress.
- ❑ Ensure that all cables that connect to the printer are correctly attached.
- ❑ Overtightening the guides may cause jams.

See Also:

- ❑ “About Print Media” on page 115
- ❑ “Supported Print Media” on page 119
- ❑ “Print Media Storage Guidelines” on page 119

Identifying the Location of Paper Jams



Caution:

Do not attempt to remove a paper deeply jammed inside the product, particularly a paper wrapped around the fusing unit or the heat roller. Otherwise, it may cause injuries or burns. Switch off the product immediately and contact your local Epson representative.

Important:

Do not attempt to clear any jams using tools or instruments. This may permanently damage the printer.

The following illustration shows where paper jams may occur along the print media path.

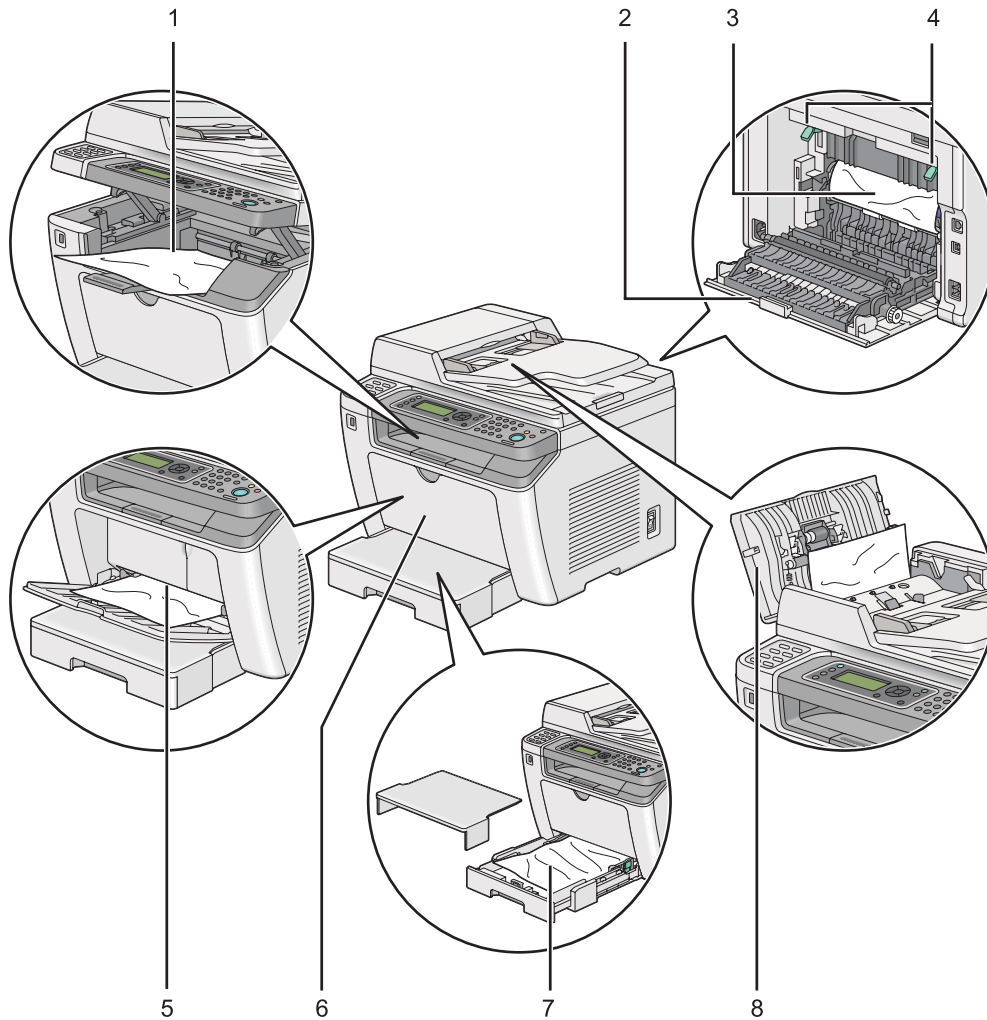

1	Center Output Tray
2	Rear Cover
3	OPC Drum
4	Levers
5	Priority Sheet Inserter (PSI)
6	Front Cover
7	Paper Tray
8	ADF Cover

Clearing Paper Jams From the Automatic Document Feeder (ADF)

When a document is jammed while it passes through the ADF, follow the steps below to remove it.

Note:

To resolve the error displayed on the LCD panel, you must clear all print media from the print media path.

1. Open the ADF cover.



2. Remove the jammed document by carefully pulling it in the direction of the arrow shown in the following illustration.

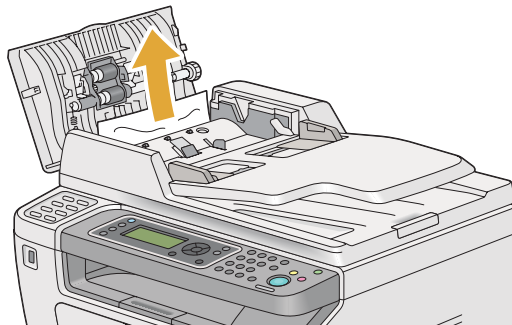

3. If you find it difficult to pull the document, open the document feeder tray.

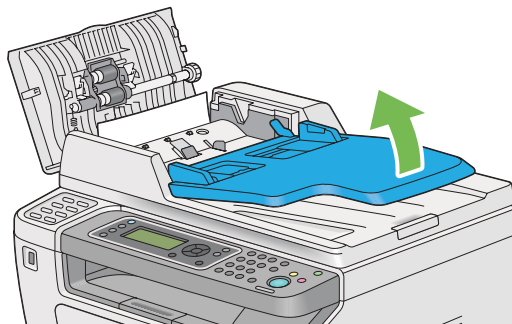

4. Remove the jammed document from the document output tray.



5. Close the document feeder tray.

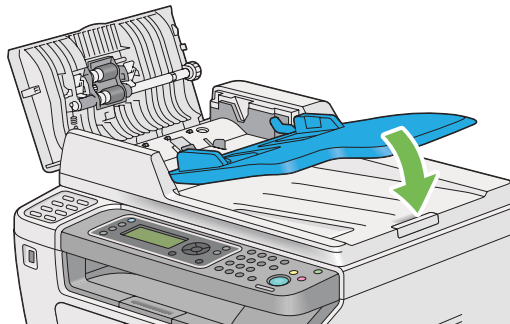

6. Close the ADF cover, and then load the documents back into the ADF.

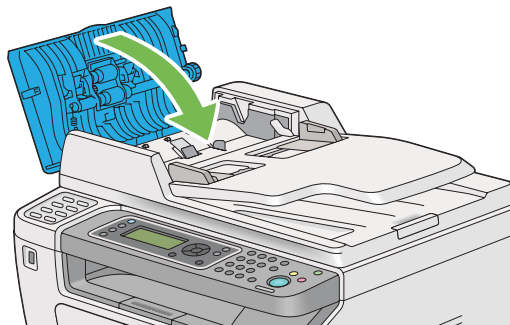

Note:

Be sure to adjust the document guides before printing a Legal-size document.

7. If you cannot remove the jammed document from the document output tray or cannot find any jammed document there, open the document cover.

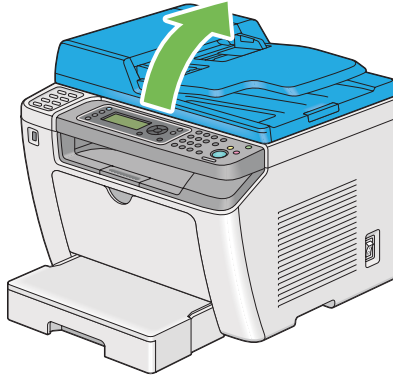

8. Remove the document from the ADF feed roller or the feed area by carefully pulling the document in the direction of the arrow shown in the following illustration.

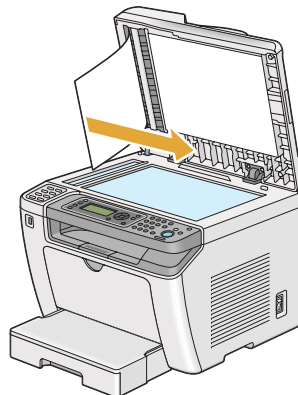
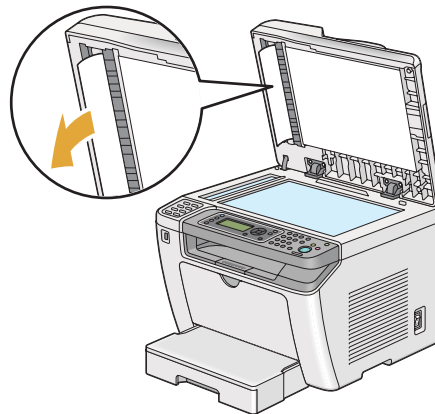

Clearing Paper Jams From the Front of the Printer

Clearing Paper Jams From the Paper Tray

Important:

- ❑ To prevent electric shock, always turn off the printer and disconnect the power cord from the grounded outlet before performing maintenance.
- ❑ To avoid burns, do not clear paper jams immediately after printing. The fusing unit becomes extremely hot during use.
- ❑ Protect the OPC drum against bright light. If the rear cover is left open for more than five minutes, print quality may deteriorate.

Note:

To resolve the error displayed on the LCD panel, you must clear all print media from the print media path.

1. Push the rear cover handle and open the rear cover.

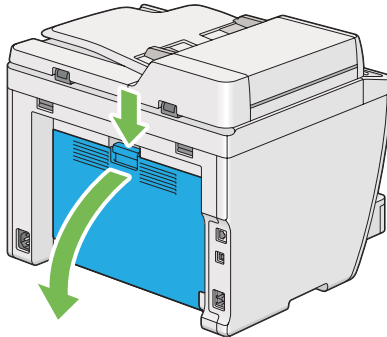

2. Lift up the levers.

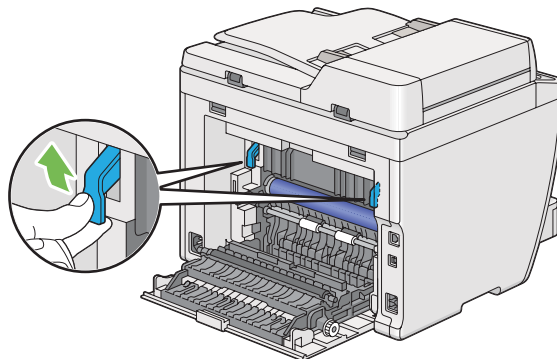

3. Pull the paper tray out of the printer carefully. Hold the tray with both hands, lift the front slightly, and remove it from the printer.

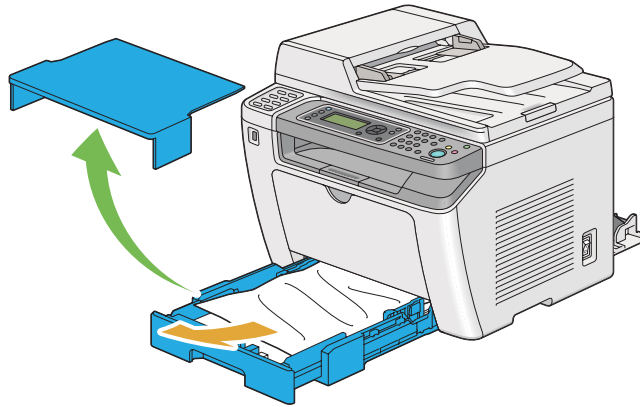

4. Remove all the jammed and/or creased paper from the tray.

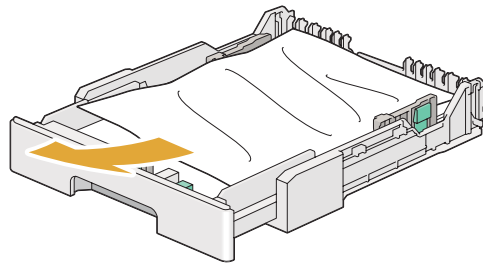

5. Pull the jammed paper out carefully to avoid tearing it.

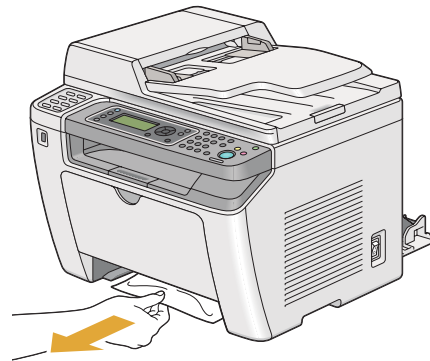

6. Lower the levers to the original position.

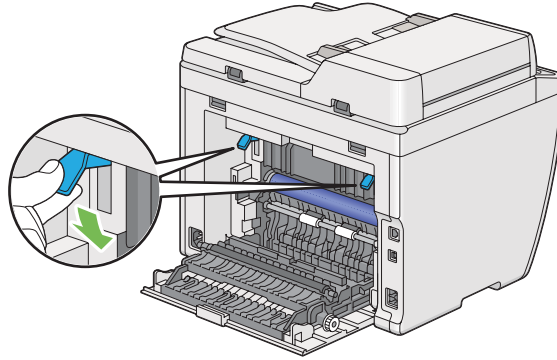

7. Close the rear cover.

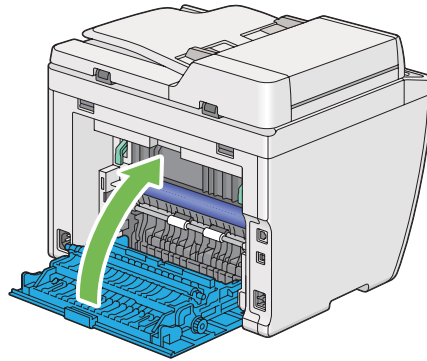

8. Insert the paper tray into the printer, and push until it clicks into place.

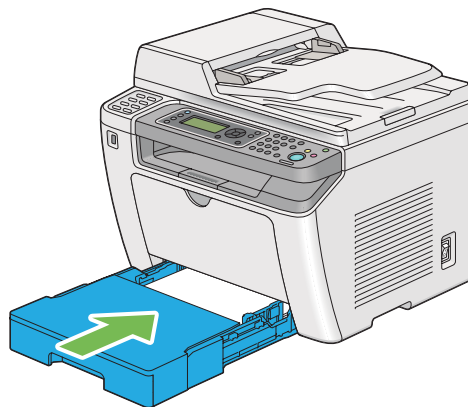

Clearing Paper Jams From the Priority Sheet Inserter (PSI)

Important:

- ❑ Do not put excessive force on the front cover when removing the jammed paper. Doing so could damage the cover.
- ❑ To prevent electric shock, always turn off the printer and disconnect the power cord from the grounded outlet before performing maintenance.
- ❑ To avoid burns, do not clear paper jams immediately after printing. The fusing unit becomes extremely hot during use.
- ❑ Protect the OPC drum against bright light. If the rear cover is left open for more than five minutes, print quality may deteriorate.

Note:

To resolve the error displayed on the LCD panel, you must clear all print media from the print media path.

1. Push the rear cover handle and open the rear cover.

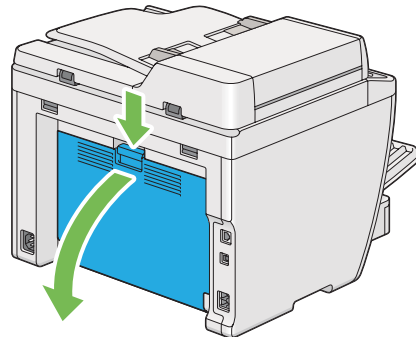

2. Lift up the levers.

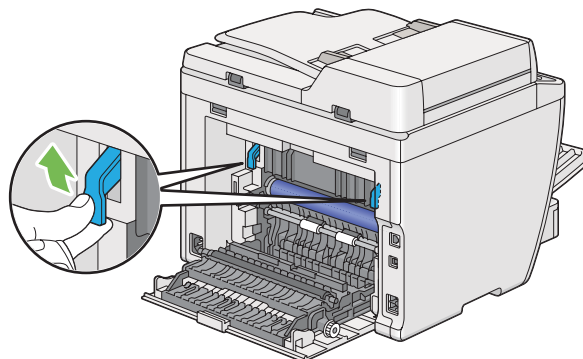

3. Pull the jammed paper out carefully to avoid tearing it.

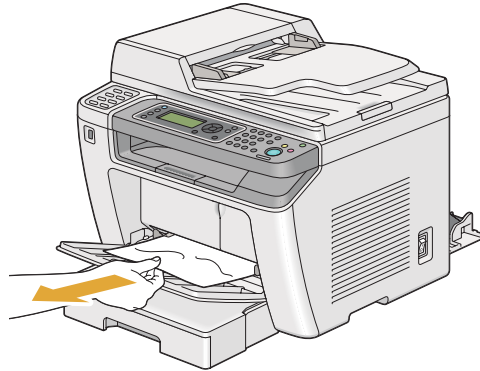

4. Lower the levers to the original position.

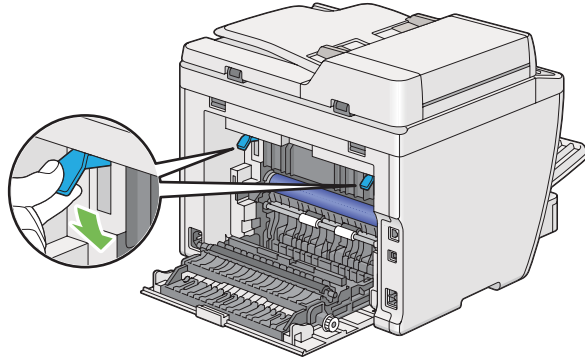

5. Close the rear cover.

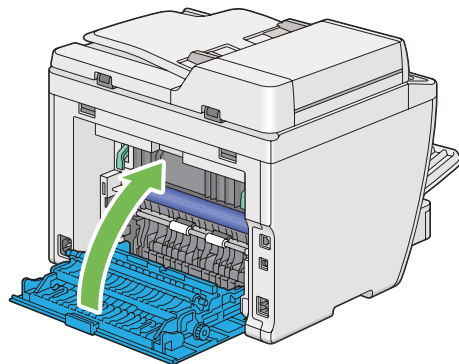

Clearing Paper Jams From the Rear of the Printer

Important:

- ❑ To prevent electric shock, always turn off the printer and disconnect the power cord from the grounded outlet before performing maintenance.
- ❑ To avoid burns, do not clear paper jams immediately after printing. The fusing unit becomes extremely hot during use.
- ❑ Protect the OPC drum against bright light. If the rear cover is left open for more than five minutes, print quality may deteriorate.

Note:

To resolve the error displayed on the LCD panel, you must clear all print media from the print media path.

1. Push the rear cover handle and open the rear cover.

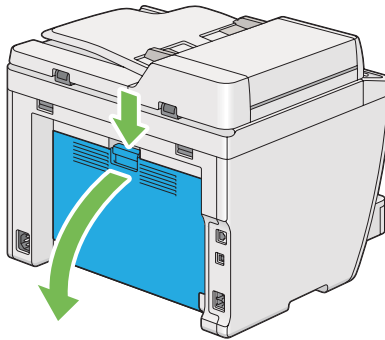

2. Lift up the levers.

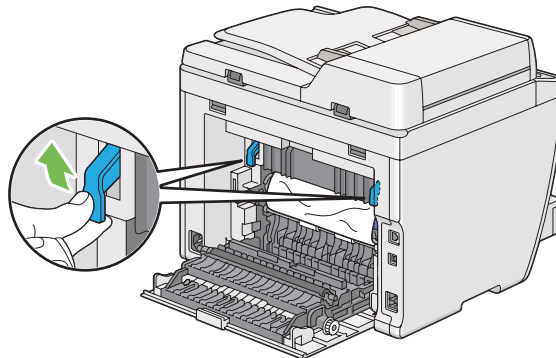

3. Remove the jammed paper from the rear of the printer.

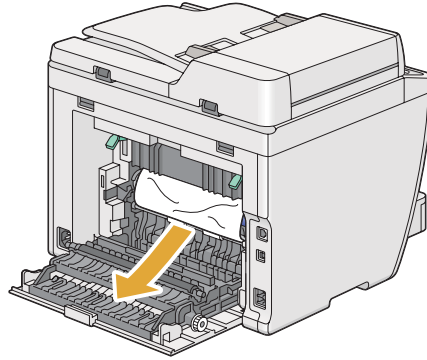

4. Lower the levers to the original position.

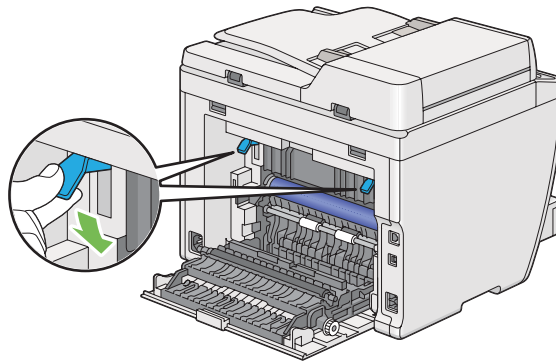

5. Close the rear cover.

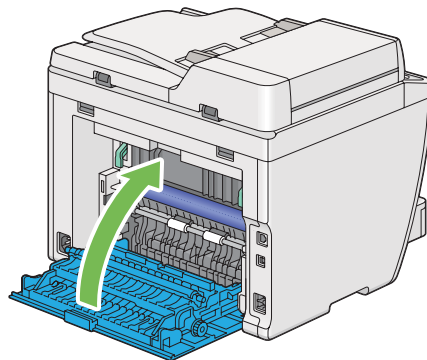

If the error is not resolved, there may be a piece of paper remaining inside the printer. Use the following procedure to clear the jam.

6. Load print media in the paper tray or the Priority Sheet Inserter (PSI) if there is no print media.

7. Press the  (**Clear All**) button on the operator panel for three seconds.

The print media is fed to push out the jammed paper.

Clearing Paper Jams From the Center Output Tray

Important:

- To prevent electric shock, always turn off the printer and disconnect the power cord from the grounded outlet before performing maintenance.
- To avoid burns, do not clear paper jams immediately after printing. The fusing unit becomes extremely hot during use.
- Protect the OPC drum against bright light. If the rear cover is left open for more than five minutes, print quality may deteriorate.

Note:

To resolve the error displayed on the LCD panel, you must clear all print media from the print media path.

1. Push the rear cover handle and open the rear cover.

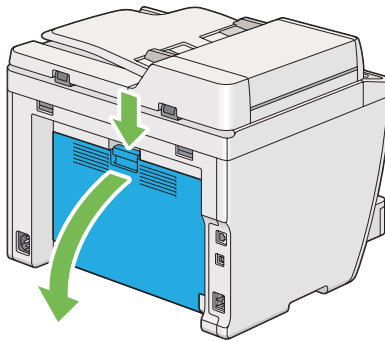

2. Lift up the levers.

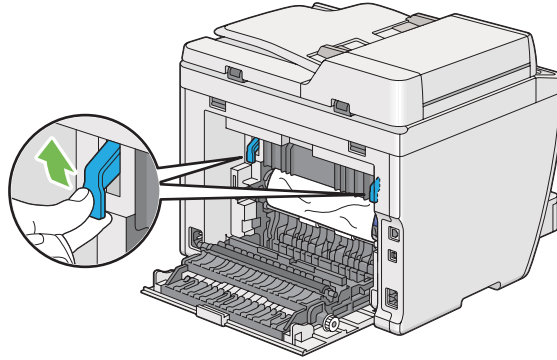

3. Remove the jammed paper from the rear of the printer.

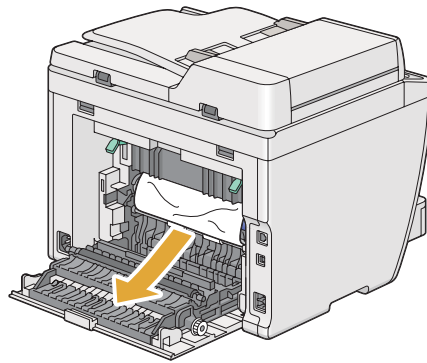

4. If no paper is found in the paper path, lift and open the scanner unit.

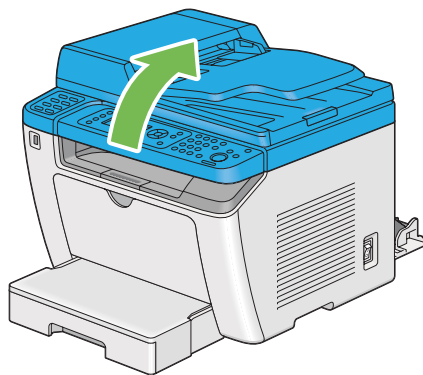

5. Remove any paper jammed out of the center output tray.

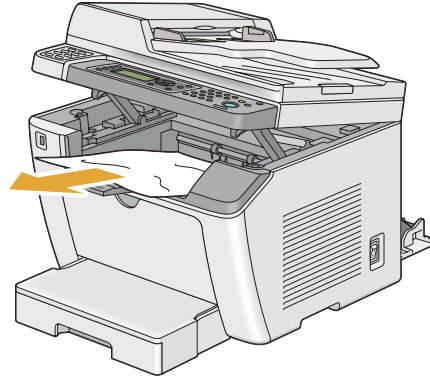

6. Lower and close the scanner unit.

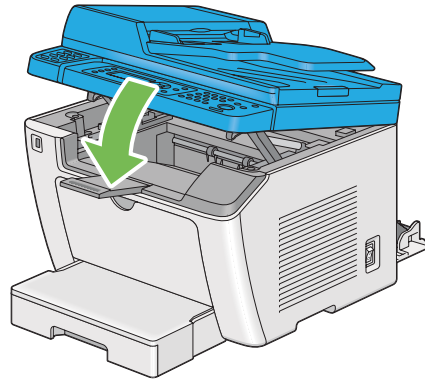

7. Lower the levers to the original position.

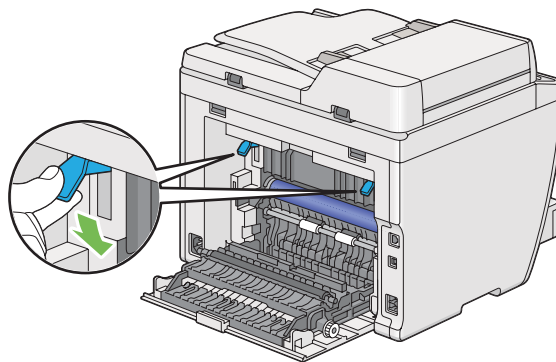

8. Close the rear cover.

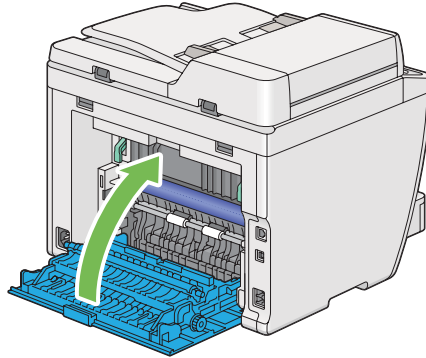

If the error is not resolved, there may be a piece of paper remaining inside the printer. Use the following procedure to clear the jam.

9. Load print media in the paper tray or the Priority Sheet Inserter (PSI) if there is no print media.
10. Press the  (**Clear All**) button on the operator panel for 3 seconds.

The print media is fed to push out the jammed paper.

Jam Problems

Misfeed Jam

Problem	Action
Print media misfeeds occur.	Remove the paper from the Priority Sheet Inserter (PSI), and then ensure that the paper is properly inserted in the paper tray.
	Depending on the print media you use, take any of the following actions: <ul style="list-style-type: none"> <input type="checkbox"/> For thick paper, use the one that is 163 gsm or less. <input type="checkbox"/> For postcard, the one up to 190 gsm is available. <input type="checkbox"/> For thin paper, use the one that is 60 gsm or more. <input type="checkbox"/> For the envelope, ensure that it is properly loaded in the paper tray as instructed in "Loading Envelopes in the Paper Tray" on page 128.
	If the envelope is deformed, correct it or use another envelope.
	If performing manual duplex (2-sided) printing, ensure that the print media is not curled.
	Fan the print media.
	If the print media is damp, turn over the print media.
	If the problem continues, use print media that is not damp.

Note:

If the problem continues even though you have taken suggested actions described above, contact our local representative office or authorized dealer.

Multi-feed Jam

Problem	Action
Print media multiple feeds occur.	Remove the paper from the Priority Sheet Inserter (PSI), and then ensure that the paper is properly loaded in the paper tray.
	If the print media is damp, use print media that is not damp.
	Fan the print media.
A document jam occurs in the ADF if scanning of multiple-sheet document is cancelled while scanning is in progress.	Clear the jam. See Also: "Clearing Paper Jams From the Automatic Document Feeder (ADF)" on page 330

Note:

If the problem continues even though you have taken suggested actions described above, contact our local representative office or authorized dealer.

Basic Printer Problems

Some printer problems can be easy to resolve. If a problem occurs with your printer, check each of the following:

- The power cord is connected to the printer, and to a properly grounded electrical outlet.
- The printer is turned on.
- The electrical outlet is not turned off at any switch or breaker.
- Other electrical equipment plugged into the outlet is working.
- When the AL-MX200DWF model is connected to a wireless network, an Ethernet cable should be unplugged from the printer.

If you have checked all of the above and still have a problem, turn off the printer, wait for 10 seconds, and then turn on the printer. This often fixes the problem.

Display Problems

Problem	Action
After the printer is turned on, the display on the LCD panel is blank, keeps showing <code>Please Wait...</code> , or the back light is not lit.	Turn off the printer, wait for 10 seconds, and turn on the printer. <code>Self Test Message</code> appears on the LCD panel. When the test is completed, <code>Select Function</code> is displayed.
Menu settings changed from the operator panel have no effect.	Settings in the software program, the print driver, or the printer utilities have precedence over the settings made on the operator panel. Change the menu settings from the print driver, the printer utilities, or the software program instead of the operator panel.

Printing Problems

Problem	Action
Job did not print or incorrect characters printed.	Ensure that the Select Function screen appears on the LCD panel before you send a job to print.
	Ensure that print media is loaded in the printer.
	Verify that you are using the correct print driver.
	Ensure that you are using the correct Ethernet or USB cable and that it is securely connected to the printer.
	Verify that the correct print media size is selected.
	If you are using a print spooler, verify that the spooler has not stalled.
	<p>Check the interface of your printer from Admin Menu.</p> <p>Determine the host interface you are using. Print the System Settings page to verify that the current interface settings are correct. Refer to "Printing the System Settings Page" on page 155 for details on how to print the System Settings page.</p>

Problem	Action
Print media misfeeds or multiple feeds occur.	Ensure that the print media you are using meets the specifications for your printer. See Also: "Usable Print Media" on page 119
	Fan the print media before loading it.
	Ensure that the print media is loaded correctly.
	Ensure that the paper width guides and length guide are adjusted correctly.
	Do not overfill the print media sources.
	Do not force print media into the Priority Sheet Inserter (PSI) or the paper tray when you load it. Otherwise, it may skew or buckle.
	Ensure that the print media is not curled.
	Load print media with the recommended print surface facing in the correct direction. See Also: "Loading Print Media" on page 122
	Turn the print media over or around and try printing again to see if feeding improves.
	Do not mix print media types.
	Do not mix print media sizes.
	Remove the top and bottom curled sheets of a ream before loading the print media.
	Load a print media source only when it is empty.
The envelope is creased after printing.	Ensure that the envelope is loaded in the paper tray as instructed in "Loading Envelopes in the Paper Tray" on page 128.
Page breaks in unexpected places.	Increase the value for Job Time-Out in the System Settings menu, that is on the Printer Maintenance tab in the Printer Setting Utility.
	Increase the time-out value in the Protocol Settings menu on EpsonNet Config.
Print media does not stack neatly in the center output tray.	Turn the print media stack over in the Priority Sheet Inserter (PSI) and the paper tray.
Printer does not duplex pages.	Select Flip on Short Edge or Flip on Long Edge from the Duplex menu on the Paper/Output tab of the print driver.

Print Quality Problems

Note:

In this section, some procedures use the Printer Setting Utility or Status Monitor. Some procedures that use the Printer Setting Utility can also be performed using the operator panel.

See Also:

- ❑ *“Understanding the Operator Panel Menus” on page 263*
- ❑ *“Printer Setting Utility (Windows Only)” on page 34*
- ❑ *“Status Monitor (Windows Only)” on page 35*

The Output Is Too Light

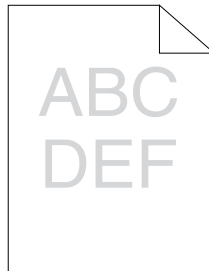

Problem	Action
The output is too light.	<p>The toner cartridge may be low or need to be replaced. Confirm the amount of toner in the toner cartridge.</p> <ol style="list-style-type: none"> 1. Check the toner level on the Consumables tab of the Printer Status window of Status Monitor. 2. Replace the toner cartridge as needed.
	<p>Verify that the print media is dry and the correct print media is used.</p> <p>If not, use the print media recommended for the printer.</p> <p>See Also: "Usable Print Media" on page 119</p>
	<p>Try changing the Paper Type setting on the print driver.</p> <ol style="list-style-type: none"> 1. On the Paper/Output tab for Printing Preferences of the print driver, change the Paper Type setting.
	<p>Disable Toner Saving Mode on the print driver.</p> <ol style="list-style-type: none"> 1. On the Graphics tab in Printing Preferences of the print driver, ensure that the Toner Saving Mode check box is not selected.

Note:

If the problem continues even though you have taken suggested actions described above, contact our local representative office or authorized dealer.

Toner Smears or Print Comes Off/Stain on Back Side

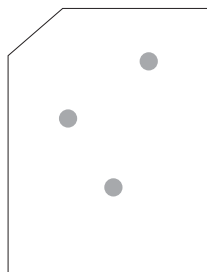
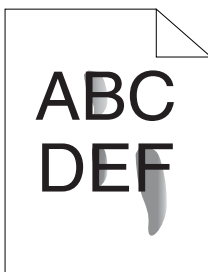

Problem	Action
<p>Toner smears or print comes off.</p> <p>The output has stain on the back side.</p>	<p>The print media surface may be uneven. Try changing the Paper Type setting in the print driver. For example, change Plain to Lightweight Cardstock.</p> <ol style="list-style-type: none"> 1. On the Paper/Output tab for Printing Preferences of the print driver, change the Paper Type setting.
	<p>Verify that the correct print media is being used.</p> <p>If not, use the print media recommended for the printer.</p> <p>See Also: "Usable Print Media" on page 119</p>
	<p>Adjust the temperature of the fusing unit.</p> <ol style="list-style-type: none"> 1. Launch the Printer Setting Utility, and click Adjust Fusing Unit on the Printer Maintenance tab. 2. Adjust the fixing temperature by turning up the value for your printing media. 3. Click the Apply New Settings button.

Note:

If the problem continues even though you have taken suggested actions described above, contact our local representative office or authorized dealer.

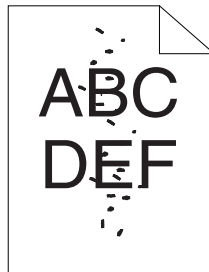
Random Spots/Blurred Images

Problem	Action
The printed result has random spots or is blurred.	Ensure that the toner cartridge is installed correctly. See Also: "Installing a Toner Cartridge" on page 385
	If you use a non-genuine brand toner cartridge, install a genuine brand toner cartridge.
	Clean up the fusing unit. 1. Load one sheet of paper in the paper tray, and then print a solid image all over paper. 2. Load the printed sheet with the print surface facing down, and then print a blank sheet of paper.

Note:

If the problem continues even though you have taken suggested actions described above, contact our local representative office or authorized dealer.

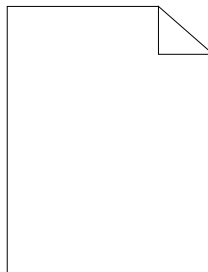
The Entire Output Is Blank

If this trouble happens, contact our local representative office or authorized dealer.

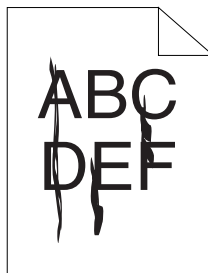
Streaks Appear on the Output

If this trouble happens, contact our local representative office or authorized dealer.

Mottle

Problem	Action
The printed result has mottled appearance.	Adjust the transfer bias. 1. Launch the Printer Setting Utility, click Adjust BTR on the Printer Maintenance tab. 2. Adjust the setting for the type of print media being used. 3. Click the Apply New Settings button.
	If you use non-recommended print media, use the print media recommended for the printer.

Note:

If the problem continues even though you have taken suggested actions described above, contact our local representative office or authorized dealer.

Ghosting

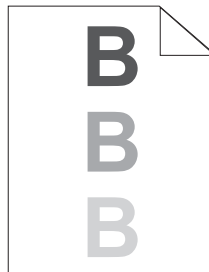

Problem	Action
The printed result has ghosting.	<p>The print media surface may be uneven. Try changing the Paper Type setting in the print driver. For example, change Plain to Lightweight Cardstock.</p> <ol style="list-style-type: none"> 1. On the Paper/Output tab for Printing Preferences of the print driver, change the Paper Type setting.
	<p>Adjust the transfer bias.</p> <ol style="list-style-type: none"> 1. Launch the Printer Setting Utility, click Adjust BTR on the Printer Maintenance tab. 2. Adjust the setting for the type of print media being used. 3. Click the Apply New Settings button.
	<p>Adjust the temperature of the fusing unit.</p> <ol style="list-style-type: none"> 1. Launch the Printer Setting Utility, and click Adjust Fusing Unit on the Printer Maintenance tab. 2. Adjust the fixing temperature by turning up the value for your printing media. 3. Click the Apply New Settings button.
	<p>If you use non-recommended print media, use the print media recommended for the printer.</p>

Note:

If the problem continues even though you have taken suggested actions described above, contact our local representative office or authorized dealer.

Fog

Problem	Action
The printed result is foggy.	When the whole is printed light, contact our local representative office or authorized dealer.
	When the printed page is partly light, start Clean Developer . <ol style="list-style-type: none"> 1. Launch the Printer Setting Utility, and click Clean Developer on the Diagnosis tab. 2. Click the Start button.

Note:

If the problem continues even though you have taken suggested actions described above, contact our local representative office or authorized dealer.

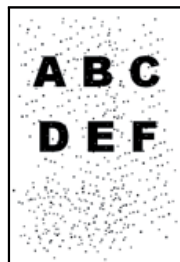
Bead-Carry-Out (BCO)

Problem	Action
Bead-Carry-Out (BCO) is happening.	If the printer is installed in a high altitude location, set the altitude of the location. <ol style="list-style-type: none"> 1. Launch the Printer Setting Utility, and click Adjust Altitude on the Printer Maintenance tab. 2. Select the value close to the altitude of the location where the printer is installed. 3. Click the Apply New Settings button.

Note:

If the problem continues even though you have taken suggested actions described above, contact our local representative office or authorized dealer.

Auger Mark

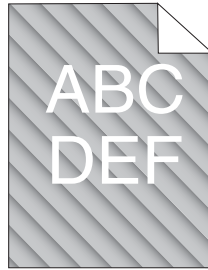

Problem	Action
The printed result has auger mark.	<p>The toner cartridge may be low or need to be replaced. Confirm the amount of toner in the toner cartridge.</p> <ol style="list-style-type: none"> 1. Check the toner level on the Consumables tab of the Printer Status window of Status Monitor. 2. Replace the toner cartridge as needed.
	<p>Start Clean Developer.</p> <ol style="list-style-type: none"> 1. Launch the Printer Setting Utility, and click Clean Developer on the Diagnosis tab. 2. Click the Start button.

Note:

If the problem continues even though you have taken suggested actions described above, contact our local representative office or authorized dealer.

Wrinkled/Stained Paper

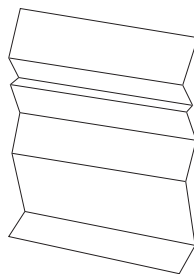

Problem	Action
<p>The output is wrinkled.</p> <p>The output is stained.</p>	<p>Verify that the correct print media is being used.</p> <p>If not, use the print media recommended for the printer.</p> <p>If excessive folds or wrinkles occur, load print media from a new package and use the paper tray cover.</p> <p>See Also:</p> <ul style="list-style-type: none"> <input type="checkbox"/> "Usable Print Media" on page 119 <input type="checkbox"/> "About Print Media" on page 115 <hr/> <p>If you use the envelope, check whether the crease is within 30 mm of the four edges of the envelope.</p> <p>If the crease is within 30 mm of the four edges of the envelope, this is considered normal. Your printer is not at fault.</p> <p>If not, check if the printer supports your envelope type, and then check if you loaded the envelope in the correct orientation. For more information, see "Loading Print Media in the Paper Tray" on page 123 or "Loading Print Media in the Priority Sheet Inserter (PSI)" on page 132.</p>

Note:

If the problem continues even though you have taken suggested actions described above, contact our local representative office or authorized dealer.

The Top Margin Is Incorrect

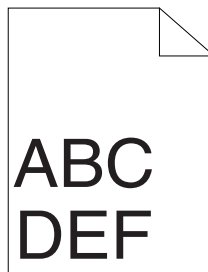

Problem	Action
The top margin is incorrect.	Ensure that the margins are set correctly on the application being used.

Note:

If the problem continues even though you have taken suggested actions described above, contact our local representative office or authorized dealer.

Protrudent/Bumpy Paper



Problem	Action
Printed surface got protrudent/bumpy.	Clean up the fusing unit. 1. Load one sheet of paper in the paper tray, and then print a solid image all over paper. 2. Load the printed sheet with the print surface facing down, and then print a blank sheet of paper.

Note:

If the problem continues even though you have taken suggested actions described above, contact our local representative office or authorized dealer.

Copy Problem

Problem	Action
A document loaded in the ADF cannot be copied.	Ensure that the ADF cover is firmly closed.

Copy Quality Problems

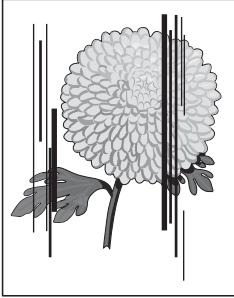
Problem	Action
<p>There are lines or streaks in copies made from the ADF.</p> 	<p>There is debris on the ADF glass. When scanning, the paper from the ADF passes over the debris creating lines or streaks.</p> <p>Clean the ADF glass with a lint free cloth.</p> <p>See Also: "Cleaning the Scanner" on page 378</p>
<p>There are spots in copies taken from the document glass.</p>	<p>There is debris on the document glass. When scanning, the debris creates a spot on the image.</p> <p>Clean the document glass with a lint free cloth.</p> <p>See Also: "Cleaning the Scanner" on page 378</p>
<p>The reverse side of the original is showing on the copy.</p>	<p>On the Copy menu, enable Auto Exposure.</p> <p>For information on turning Auto Exposure on and off, see "Auto Exposure" on page 174.</p>
<p>Light colors are washed out or white on the copy.</p>	<p>On the Copy menu, disable Auto Exposure.</p> <p>For information on turning Auto Exposure on and off, see "Auto Exposure" on page 174.</p>
<p>Image is too light or dark.</p>	<p>Use the Lighten/Darken option on the Copy menu.</p> <p>For information on making the image lighter or darker, see "Lighten/Darken" on page 172.</p>

Note:

If the problem continues even though you have taken suggested actions described above, contact our local representative office or authorized dealer.

Fax Problems

Problem	Action
The printer is not working, there is no display and the buttons are not working.	Unplug the power cord and plug it in again.
	Ensure that there is power to the electrical receptacle.
No dial tone sounds.	Check that the phone line is connected properly. See Also: "Connecting the Telephone Line" on page 220
	Check that the phone socket in the wall is working by plugging in another phone.
The numbers stored in the memory do not dial correctly.	Ensure that the numbers are stored in the memory correctly. Print the Address Book List.
The document does not feed into the printer.	Ensure that the document is not wrinkled and you are putting it in correctly. Check that the document is of the right size, not too thick or thin.
	Ensure that the ADF cover is firmly closed.
Faxes are not received automatically.	Select <code>FAX Mode for Ans Select</code> .
	Ensure that there is paper in the Priority Sheet Inserter (PSI) or the paper tray.
	Check if the LCD panel shows <code>Memory Full</code> .
	Check the Junk Fax Filter setting. When the <code>Junk Fax Filter</code> is set to <code>On</code> , you can receive faxes from the fax numbers registered in the Address Book of the printer. Faxes sent from other numbers are rejected.
The printer does not send faxes.	Check the other fax machine you are sending to, to see if it can receive your fax.
The incoming fax has blank spaces or is received in poor-quality.	The fax machine sending you the fax may be faulty. Ask the sender to sort out the problem and resend the fax.
	A noisy phone line can cause line errors. Ask the sender to resend the fax.
	Check your printer by making a copy.
	The toner cartridge may be empty. Replace the toner cartridge. See Also: "Replacing the Toner Cartridge" on page 381
Some of the words on an incoming fax are stretched.	The fax machine sending you the fax had a temporary document jam. Ask the sender to clear the document jam and resend the fax.

Problem	Action
There are lines on the documents you send.	<p>Check your ADF glass for marks and clean it.</p> <p>See Also: "Cleaning the Scanner" on page 378</p>
The printer dials a number, but the connection with another fax machine fails.	<p>The other fax machine may be turned off, out of paper, or cannot answer incoming calls. Ask the sender to sort out the problem and retry.</p>
Documents are not stored in the memory.	<p>There may not be enough memory to store the document. If the LCD panel shows <code>Memory Full</code>, delete any documents you no longer need from the memory and then restore the document, or wait for the job in progress (e.g., a fax transmission or reception) to complete.</p>
Blank areas appear at the bottom of each page or on other pages, with a small strip of text at the top.	<p>You may have chosen the wrong paper settings in the user option setting. Correct the paper settings.</p> <p>See Also: "Tray Settings" on page 317</p>
The printer will not send or receive faxes.	<p>Ensure that the region is set correctly.</p> <ol style="list-style-type: none"> 1. Press the System button. 2. Select <code>Admin Menu</code>, and then press the OK button. 3. Select <code>Fax Settings</code>, and then press the OK button. 4. Select <code>Region</code>, and then press the OK button. 5. When the setting is correct, press the Back button to return to the previous screen. <p>To change the setting, select the correct region and then press the OK button. Select <code>Yes</code> to reboot the printer.</p>
	<p>Check that the phone line is connected properly.</p> <p>See Also: "Connecting the Telephone Line" on page 220</p>
An error often occurs during a fax transmission or reception.	<p>Reduce the modem speed.</p> <ol style="list-style-type: none"> 1. Press the System button. 2. Select <code>Admin Menu</code>, and then press the OK button. 3. Select <code>Fax Settings</code>, and then press the OK button. 4. Select <code>Modem Speed</code>, and then press the OK button. 5. Select the desired menu item, and then press the OK button.

Scanning Problems

Problem	Action
The scanner does not work.	Ensure that you place the document to be scanned face down on the document glass, or face up in the Automatic Document Feeder (ADF).
	There may not be enough available memory to hold the document you want to scan. Try the Preview feature to see if that works. Try lowering the scan resolution rate.
	Check that the USB cable is connected properly.
	Ensure that the USB cable is not defective. Switch the cable with a known good cable. If necessary, replace the cable.
	Check that the scanner is configured correctly. Check the application you want to use to make certain that the scanner job is being sent to the correct port.
The printer scans very slowly.	Graphics are scanned more slowly than text when using the Scan to E-Mail or Scan to Network feature.
	Communication speed becomes slow in scan mode because of the large amount of memory required to analyze and reproduce the scanned image.
	Scanning images at a high resolution takes more time than scanning at a low resolution.
Document misfeeds or multiple feeds occur in the ADF.	Ensure that the document's paper type meets the specifications for the printer.
	See Also:
	<input type="checkbox"/> "Preparing a Document" on page 161
	<input type="checkbox"/> "Making Copies From the Automatic Document Feeder (ADF)" on page 164
	Check whether the document is properly loaded in the ADF.
	Ensure that the document guides are adjusted properly.
	Ensure that the number of document sheets do not exceed the maximum capacity of the ADF.
Vertical stripes appear on the output when scanned using the ADF.	Clean the ADF glass.
	See Also: "Cleaning the Scanner" on page 378

Problem	Action
A smear appears at the same location on the output when scanned using the document glass.	Clean the document glass. See Also: "Cleaning the Scanner" on page 378
Images are skewed.	Ensure that the document is loaded straight in the ADF or on the document glass.
Diagonal lines appear jagged when scanned using the ADF.	If the document uses thick media, try scanning it from the document glass.
The printer does not properly transfer scan data to a specified destination via the Scan to E-Mail or Scan to Network feature.	Check if the following settings have been set correctly on EpsonNet Config. Scan to E-Mail Check the following setting under Address Book — Personal Address: <input type="checkbox"/> Address Scan to Network Check the following settings under Address Book — Computer/Server Address Book: <input type="checkbox"/> Name (Displayed on Printer) <input type="checkbox"/> Network Type <input type="checkbox"/> Host Address (IP Address or DNS Name) <input type="checkbox"/> Port Number <input type="checkbox"/> Login Name (if required by host) <input type="checkbox"/> Login Password <input type="checkbox"/> Name of Shared Directory <input type="checkbox"/> Subdirectory Path (optional)
Cannot scan using WIA on a Windows Server® 2003 computer.	Enable WIA on the computer. To enable WIA: 1. Click Start — Administrative Tools — Services . 2. Right-click Windows Image Acquisition (WIA) , and then click Properties to ensure that Startup type is set to Manual or Automatic . 3. Click OK . 4. Right-click Windows Image Acquisition (WIA) , and then click Start .

Problem	Action
Cannot scan using TWAIN or WIA on a Windows Server 2008 or Windows Server 2008 R2 computer.	<p>Install the Desktop Experience feature on the computer.</p> <p>To install Desktop Experience:</p> <ol style="list-style-type: none"> 1. Click Start — Administrative Tools — Server Manager. 2. Under Features Summary, click Add Features. 3. Select the Desktop Experience check box. 4. If a window appears, follow the on-screen instructions. 5. Click Next, and then click Install. 6. Restart the computer.

Scan Driver/Printer Utility Problems

Problem	Action
Unable to retrieve the Address Book data from the printer on the Address Book Editor.	Ensure that your computer and the printer is properly connected with the USB cable or Ethernet cable.
	Ensure that the printer is turned on.
	Ensure that the print driver is installed on your computer. (The Address Book Editor retrieves the Address Book data via the print driver.)
The TWAIN driver cannot connect to the printer.	Ensure that your computer and the printer is properly connected with the USB cable.
	Check whether the printer is turned on. If the printer is turned on, reboot it by turning the power switch off and then on again.
	If a scan application is running, close the application once, restart the application, and then try scanning again.
The scan driver has not been registered on your computer and cannot be accessed from the Express Scan Manager.	Install the scan driver. If the driver is already installed, uninstall it and then reinstall it.
Failed to scan your document on the printer via the Express Scan Manager.	Ensure that your computer and the printer is properly connected with the USB cable.
	Check whether the printer is turned on. If the printer is turned on, reboot it by turning the power switch off and then on again.
	If a scan application is running, close the application once, restart the application, and then try scanning again.

Problem	Action
Failed to create an image file via the Express Scan Manager.	Ensure that there is sufficient space in your hard disk.
	Uninstall the Express Scan Manager on your computer and then reinstall it.
Failed to initialize the Express Scan Manager.	Uninstall the Express Scan Manager on your computer and then reinstall it.
Failed to execute the Express Scan Manager.	Uninstall the Express Scan Manager on your computer and then reinstall it.
An unexpected error occurred on the Express Scan Manager.	Uninstall the Express Scan Manager on your computer and then reinstall it.

Other Problems

Problem	Action
Condensation has occurred inside the printer.	This usually occurs within several hours after you heat the room in winter. This also occurs when the printer is operating in a location where relative humidity reaches 85% or more. Adjust the humidity or relocate the printer to an appropriate environment.













Understanding Printer Messages

The printer's LCD panel displays a message describing the current state of the printer or indicates a possible printer problem you must resolve. This section describes error codes included in the messages, their meanings, and how to clear the messages.















Important:











When an error message is displayed, the print data remaining on the printer and the information accumulated in the memory of the printer are not secured.

Error Code	What You Can Do
005-121	Open the ADF cover. Remove the jammed paper and then close the ADF cover. See Also: "Clearing Paper Jams From the Automatic Document Feeder (ADF)" on page 330
005-301	Close the ADF cover.

Error Code	What You Can Do
010-397	Turn off the printer, and then on. If this does not solve the problem, contact our local representative office or authorized dealer. See Also: "Contacting Epson Support" on page 395
016-315	
016-317	
016-372	
016-501	
016-502	
016-503	Press the  button to clear the message. Check if the SMTP server setting is correct by contacting your server administrator.
016-504	Press the  button to clear the message. Check if the user name and password for the POP3 server are set correctly by contacting your server administrator.
016-506	Press the  button to clear the message. Check if the SMTP server address and e-mail destination are set correctly.
016-507	Press the  button to clear the message. Check if the user name and password used for the SMTP server are set correctly by contacting your server administrator.
016-718	Press the  button to clear the message. Retry when the printer does not process any job.
016-719	Press the  button to cancel the current job. Retry when the printer does not process any job.
016-720	
016-744	Press the  button to clear the message. If this does not solve the problem, contact our local representative office or authorized dealer. See Also: "Contacting Epson Support" on page 395
016-745	
016-749	Press the  button to cancel the current job. Retry when the printer does not process any job.
016-753	Press the  button to cancel the current job. Retry when the printer does not process any job.
016-755	
016-764	Press the  button to clear the message. Check if the Ethernet cable is properly connected. If this does not solve the problem, contact SMTP server administrator.
016-766	Press the  button to clear the message. Check if the server or the computer is available by pinging the IP address. If this does not solve the problem, contact your server administrator.
016-767	Press the  button to clear the message. Check if the recipient address is correct, and try scanning again.
016-791	Insert the USB memory device and press the  button to clear the message.

Error Code	What You Can Do
016-795	Press the  button to clear the message. Check if the format of a file stored in USB memory device is supported, or the file is not broken.
016-797	
016-920	Press the  button to clear the message. Check the wireless settings for the access point and the printer.
016-930	Remove the device from the front USB port and press the  button to clear the message.
016-931	
016-981	Press the  button to cancel the current job. Try copying fewer documents.
016-985	Attached file size is larger than you defined. Press the  button to clear the message. Try the following: <ul style="list-style-type: none"> <input type="checkbox"/> Enlarge Max E-Mail Size. <input type="checkbox"/> Lower the resolution setting. <input type="checkbox"/> Change the file format of the scanned image.
017-970	Memory is likely to be full. Press the  button to clear the message. Try the following: <ul style="list-style-type: none"> <input type="checkbox"/> Delete the data stored in the memory. <input type="checkbox"/> Lower the resolution setting. <input type="checkbox"/> Reduce the number of pages.
017-980	Press the  button to clear the message. Retry when the printer does not process any job.
017-981	
017-988	Press the  button to clear the message. Check if the interface cable is securely connected or your computer does not have any problem.
018-338	Turn off the printer, and then on. If this does not solve the problem, contact our local representative office or authorized dealer. See Also: "Contacting Epson Support" on page 395
024-340	
024-360	
024-371	
024-958	Load the specified paper and press the  button to clear the message. Follow the on-screen instruction if one appears.
024-963	
See Also: <ul style="list-style-type: none"> <input type="checkbox"/> "Loading Print Media in the Paper Tray" on page 123 <input type="checkbox"/> "Loading Print Media in the Priority Sheet Inserter (PSI)" on page 132 	







Error Code	What You Can Do
024-969	Load the specified paper and press the  button to clear the message. See Also: <input type="checkbox"/> "Loading Print Media in the Paper Tray" on page 123 <input type="checkbox"/> "Loading Print Media in the Priority Sheet Inserter (PSI)" on page 132
026-720	Press the  button to clear the message. Check if the USB memory device has enough memory.
026-721	Press the  button to clear the message. Check if the USB memory device is write-protected or gets any disk problem.
026-722	
026-723	Press the  button to clear the message. Check if the path and file name to save the data is too long.
026-750	Press the  button to clear the message. Check if the interface cable is securely connected, or restart the application you use.
026-751	Press the  button to clear the message. Check if the interface cable is securely connected.
026-752	
027-446	IPv6 address duplication. Change the IP address setting.
027-452	IPv4 address duplication. Change the IP address setting.
031-521	Press the  button to clear the message. Check if the access setting to the SMB server is correct by contacting your server administrator.
031-526	Press the  button to clear the message. Check if the domain name of the SMB server is correct. Check DNS connection, or check if the name of the forwarding destination server is registered with DNS.
031-529	Press the  button to clear the message. Check if the network is properly connected and if the password for the SMB server is correct.
031-530	Press the  button to clear the message. Check if the working path setting to the SMB server is correct.
031-533	Press the  button to clear the message. Check the following: <input type="checkbox"/> If the file name you specified is not used by other users. <input type="checkbox"/> If file or folder that has the same name as the one you specified already exists. <input type="checkbox"/> If the SMB server encounters any write-protection or disk problem.
031-534	Press the  button to clear the message. Check if the SMB server encounters any write-protection or disk problem.
031-535	
031-536	
031-537	Press the  button to clear the message. Check if the storage location has free space.
031-555	Press the  button to clear the message. Check if the network is properly connected.

Error Code	What You Can Do
031-556	Press the  button to clear the message. Check if the SMB server encounters any write-protection or disk problem.
031-557	Press the  button to clear the message. Check the following: <ul style="list-style-type: none"> <li data-bbox="371 442 1007 476"><input type="checkbox"/> If the file name you specified is not used by other users. <li data-bbox="371 480 1241 514"><input type="checkbox"/> If file or folder that has the same name as the one you specified already exists.
031-558	Press the  button to clear the message. Check if the access setting to the SMB server is correct by contacting your server administrator.
031-571	Press the  button to clear the message. Check if the network is properly connected.
031-574	Press the  button to clear the message. Check if the domain name of the FTP server is correct.
031-575	Press the  button to clear the message. Check if the host name setting to the FTP server is correct.
031-576	Press the  button to clear the message. Check if the FTP server encounters any write-protection or disk problem.
031-578	Press the  button to clear the message. Check if the network is properly connected and if login name (user name) and password for the FTP server are correct.
031-579	Press the  button to clear the message. Check if the working path setting to the FTP server is correct.
031-582	Press the  button to clear the message. Check if the FTP server encounters any write-protection or disk problem.
031-584	Press the  button to clear the message. Check the following: <ul style="list-style-type: none"> <li data-bbox="371 1174 1007 1208"><input type="checkbox"/> If the file name you specified is not used by other users. <li data-bbox="371 1212 1241 1247"><input type="checkbox"/> If file or folder that has the same name as the one you specified already exists. <li data-bbox="371 1251 1114 1285"><input type="checkbox"/> If the FTP server encounters any write-protection or disk problem.
031-585	Press the  button to clear the message. Check if the FTP server encounters any delete/write-protection or disk problem.
031-587	
031-588	Press the  button to clear the message. Check if the FTP server encounters any write-protection or disk problem.
031-589	Press the  button to clear the message. Check if the storage location has free space.
031-594	Press the  button to clear the message. Contact your server administrator to check if the scanned file has wrong setting while being stored to FTP server. If this does not solve the problem, contact our local representative office or authorized dealer. See Also: "Contacting Epson Support" on page 395
031-598	Press the  button to clear the message. Check if the FTP server encounters any write-protection or disk problem.

Error Code	What You Can Do
033-503 033-513	Press the OK button to clear the message. Retry, and check the report. Delete the unnecessary data stored in the memory.
033-517	Press the OK button to clear the message. Check if the password of the fax lock is correct.
033-518	Press the OK button to clear the message. Check if your region is set correctly.
033-519	Fax service is locked. To continue, press the OK button and disable the fax lock. See Also: "Limiting Access to Copy, Fax, Scan, and USB Direct Print Operations" on page 321
033-787	Press the OK button to clear the message. The job is cancelled.
033-788	Press the OK button to clear the message. Remove the received fax, or wait for a while until sending a fax is completed.
034-700 034-701 034-702	Press the OK button to clear the message. If the error continues to appear after the redial for the specified number of times, try the following: <input type="checkbox"/> Check if the phone line is connected properly. <input type="checkbox"/> Check if the destination number is correct. <input type="checkbox"/> Set Number of Redial to the largest value. <input type="checkbox"/> Set Interval Timer or Redial Delay longer. See Also: "Connecting the Telephone Line" on page 220
034-703 034-704 034-705 034-706	Press the OK button to clear the message. If the error continues to appear after the redial for the specified number of times, try the following: <input type="checkbox"/> Check if the phone line is connected properly. <input type="checkbox"/> Check if the destination number is available and correct. <input type="checkbox"/> Set Number of Redial to the largest value. <input type="checkbox"/> Set Interval Timer or Redial Delay longer. See Also: "Connecting the Telephone Line" on page 220
034-707	Press the OK button to clear the message. If the error continues to appear after the redial for the specified number of times, try the following: <input type="checkbox"/> Set Number of Redial to the largest value. <input type="checkbox"/> Set Interval Timer or Redial Delay longer. <input type="checkbox"/> Lower Modem Speed.

Error Code	What You Can Do
034-708	<p>Press the OK button to clear the message. If the error continues to appear after the redial for the specified number of times, try the following:</p> <ul style="list-style-type: none"> <input type="checkbox"/> Set Number of Redial to the largest value. <input type="checkbox"/> Set Interval Timer or Redial Delay longer. <input type="checkbox"/> Lower Modem Speed. <input type="checkbox"/> Check if the destination number is available.
034-709	<p>Press the OK button to clear the message. If the error continues to appear after the redial for the specified number of times, try the following:</p>
034-710	<ul style="list-style-type: none"> <input type="checkbox"/> Set Number of Redial to the largest value. <input type="checkbox"/> Set Interval Timer or Redial Delay longer.
034-711	<p>Press the OK button to clear the message. If the error continues to appear after the redial for the specified number of times, try the following:</p>
034-712	<ul style="list-style-type: none"> <input type="checkbox"/> Set Number of Redial to the largest value.
034-713	<ul style="list-style-type: none"> <input type="checkbox"/> Set Interval Timer or Redial Delay longer. <input type="checkbox"/> Lower Modem Speed.
034-714	<p>Press the OK button to clear the message. If the error continues to appear after the redial for the specified number of times, try the following:</p> <ul style="list-style-type: none"> <input type="checkbox"/> Set Number of Redial to the largest value. <input type="checkbox"/> Set Interval Timer or Redial Delay longer. <input type="checkbox"/> Check if the destination number is available.
034-715	<p>Press the OK button to clear the message. If the error continues to appear after the redial for the specified number of times, try the following:</p> <ul style="list-style-type: none"> <input type="checkbox"/> Set Number of Redial to the largest value. <input type="checkbox"/> Set Interval Timer or Redial Delay longer. <input type="checkbox"/> Lower Modem Speed.
034-716	<p>Press the OK button to clear the message. If the error continues to appear after the retry for the specified number of times, it will be cancelled. When retrying sending the fax, lower Modem Speed.</p>
034-717	<p>Press the OK button to clear the message. If the error continues to appear after the retry for the specified number of times, it will be cancelled. Retry sending the fax.</p>
034-718	<p>Press the OK button to clear the message. If the error continues to appear after the retry for the specified number of times, it will be cancelled. When retrying sending the fax, lower Modem Speed.</p>
034-719	
034-720	<p>Press the OK button to clear the message. If the error continues to appear after the retry for the specified number of times, it will be cancelled. When retrying sending the fax, try the following:</p> <ul style="list-style-type: none"> <input type="checkbox"/> Lower Modem Speed. <input type="checkbox"/> Enable ECM.

Error Code	What You Can Do
034-721	Press the  button to clear the message. If the error continues to appear after the retry for the specified number of times, it will be cancelled. When retrying sending the fax, lower Modem Speed.
034-722	
034-723	
034-724	
034-725	
034-726	
034-727	Press the  button to clear the message. Check if the destination number is available. If the error continues to appear after the retry for the specified number of times, it will be cancelled.
034-750	Press the  button to clear the message. Check if the phone line is connected properly. See Also: "Connecting the Telephone Line" on page 220
034-751	Press the  button to clear the message. Check the Junk Fax Filter setting. When the Junk Fax Filter is set to On, register the fax number of sender in the Address Book of the printer, or set the Junk Fax Filter to Off.
034-752	Press the  button to clear the message. Check if the phone line is connected properly.
034-753	See Also: "Connecting the Telephone Line" on page 220
034-754	Press the  button to clear the message. Lower Modem Speed.
034-755	
034-756	
034-757	
034-758	Press the  button to clear the message. Check if the phone line is connected properly. Or, lower Modem Speed. See Also: "Connecting the Telephone Line" on page 220
034-759	Press the  button to clear the message. Lower Modem Speed.
034-760	
034-761	Press the  button to clear the message. Check if the phone line is connected properly. See Also: "Connecting the Telephone Line" on page 220

Error Code	What You Can Do
034-762	Press the  button to clear the message. Try the following: <ul style="list-style-type: none"> <input type="checkbox"/> Lower Modem Speed. <input type="checkbox"/> Enable ECM.
034-763	Press the  button to clear the message. Lower Modem Speed.
034-764	
034-765	
034-766	
034-767	Press the  button to clear the message. Check if the phone line is connected properly. See Also: "Connecting the Telephone Line" on page 220
034-768	Press the  button to clear the message. Lower Modem Speed.
041-340	Turn off the printer, and then on. If this does not solve the problem, contact our local representative office or authorized dealer. See Also: "Contacting Epson Support" on page 395
042-358	
061-370	
062-321	
075-100	Check and clear the paper path, load the paper, and then press the  button to clear the message. See Also: "Clearing Paper Jams From the Front of the Printer" on page 333
075-921	Load the printed output in the paper tray or the Priority Sheet Inserter (PSI) and press the  button.
077-100	Open the rear cover and remove the jammed paper. See Also: "Clearing Paper Jams From the Rear of the Printer" on page 338
077-104	
077-106	
077-108	
077-109	
077-304	Close the rear cover.
077-900	Open the rear cover and remove the jammed paper. See Also: "Clearing Paper Jams From the Rear of the Printer" on page 338
077-901	
077-907	

Error Code	What You Can Do
091-402	<p>The service life of your printer is coming to an end and the printer will soon stop running. If you want to keep using the printer, change the Machine life setting to Continue Print. However, continuous use of the printer will degrade the print quality.</p> <p>See Also: "Machine life" on page 298</p>
091-441	<p>The printer has exceeded its service life or the settings have been changed to continue using it. The quality of printouts will degrade if the printer continues to be used.</p> <p>See Also: "Machine life" on page 298</p>
092-651	<p>Turn off the printer, and then on. If this does not solve the problem, contact our local representative office or authorized dealer.</p>
092-661	<p>See Also: "Contacting Epson Support" on page 395</p>
093-426	<p>Replace the toner cartridge soon.</p> <p>See Also: "Replacing the Toner Cartridge" on page 381</p>
093-925	<p>Set the toner cartridge appropriately or replace it.</p> <p>See Also: "Replacing the Toner Cartridge" on page 381</p>
093-926	<p>Replace the toner cartridge with a supported one.</p> <p>See Also: "Replacing the Toner Cartridge" on page 381</p>
093-933	<p>Replace the toner cartridge with a new one. If you do not replace the toner cartridge, print quality problems may occur.</p> <p>See Also: "Replacing the Toner Cartridge" on page 381</p>
093-974	<p>Turn off the printer, check if the toner cartridge is installed correctly, and then turn on the printer. If this does not solve the problem, contact our local representative office or authorized dealer.</p> <p>See Also: "Contacting Epson Support" on page 395</p>

Error Code	What You Can Do
116-210	Turn off the printer, and then on. If this does not solve the problem, contact our local representative office or authorized dealer. See Also: "Contacting Epson Support" on page 395
116-314	
116-323	
116-325	
116-326	
116-355	
116-395	
116-703	
116-720	
117-331	Turn off the printer, and then on. If this does not solve the problem, contact our local representative office or authorized dealer. See Also: "Contacting Epson Support" on page 395
117-332	
117-333	
117-334	
117-342	
117-346	
117-348	Retry, and check the report. Turn off the printer, and then on. If this does not solve the problem, contact our local representative office or authorized dealer. See Also: "Contacting Epson Support" on page 395
117-350	
117-366	Open the rear cover and then close it.
124-333	
134-211	
117-366	Turn off the printer, and then on. If this does not solve the problem, contact our local representative office or authorized dealer. See Also: "Contacting Epson Support" on page 395
124-333	
134-211	

Error Code	What You Can Do
191-310	<p>Although the service life of your printer has been over and the printer stopped running, you can still use the printer by performing as follows:</p> <ul style="list-style-type: none"> - if a job is remaining, press the ↶ (Back) button and the ▼ button at the same time. - if there is no job, press the System button, and then select Continue Print in Machine Life of Maintenance. <p>However, continuous use of the printer will degrade the print quality.</p> <p>See Also: "Machine life" on page 298</p>
193-700	A non-genuine toner is installed.

Note:

As for the following message, which does not include an error code, refer to the table below for the solution.

Error Message	What You Can Do
<p>Wrong Paper Size Reload Paper then Press OK</p>	<p>Load the specified paper and press the OK button to clear the message.</p> <p>See Also:</p> <ul style="list-style-type: none"> <input type="checkbox"/> "Loading Print Media in the Paper Tray" on page 123 <input type="checkbox"/> "Loading Print Media in the Priority Sheet Inserter (PSI)" on page 132
<p>Job Cancelled Open ADF Cover and Remove All Paper</p>	<p>Open the ADF cover. Remove the jammed paper and then close the ADF cover.</p> <p>See Also: "Clearing Paper Jams From the Automatic Document Feeder (ADF)" on page 330</p>

Contacting Service

When you call for printer service, be prepared to describe the problem you are experiencing or the error message on the LCD panel.

You need to know the model of your printer and serial number. See the label on the rear cover of your printer.

Getting Help

We provide several automatic diagnostic tools to help you produce and maintain print quality.

LCD Panel Messages

The LCD panel provides you with information and troubleshooting help. When an error or warning condition occurs, the LCD panel displays a message informing you of the problem.

See Also:

“Understanding Printer Messages” on page 364

Status Monitor Alerts

Status Monitor is a tool that is included on the Software Disc. It automatically checks the printer status when you send a print job. If the printer is unable to print your job, Status Monitor automatically displays an alert on your computer screen to let you know that the printer needs attention.

Enabling the Non Genuine Toner Mode

When toner within the toner cartridge is empty, the message, 093-933, appears.

When you want to use the printer in the Non Genuine Toner mode, enable the Non Genuine Toner mode and replace the toner cartridge.

Important:

If you use the printer in the Non Genuine Toner mode, the performance of the printer may not be at its optimum. And any problems that may arise from the use of the Non Genuine Toner mode are not covered by our quality guarantee. The continuous use of the Non Genuine Toner mode can also cause the printer to break down, and any repair charges for such break down will be incurred by users.

Note:

*To disable the Non Genuine Toner mode, select Off for Toner of Non Genuine Toner on the operator panel or clear the check box next to **On** on the **Non Genuine Toner** page of the **Printer Maintenance** tab of the Printer Setting Utility.*

Using the Operator Panel

Note:

Before starting the operation described below, confirm that the LCD panel shows Select Function.

1. Press the **System** button.

2. Select **Admin Menu** and then press the **OK** button.
3. Select **Maintenance** and then press the **OK** button.
4. Select **Non Genuine Toner** and then press the **OK** button.
5. Select **Toner** and then press the **OK** button.
6. Select **On** and then press the **OK** button.
7. Press the **3** button until the top page is displayed.

The printer switches to the Non Genuine Toner mode.

Using the Printer Setting Utility (Windows Only)

The following procedure uses Windows® 7 as an example.

1. Click **Start** — **All Programs** — **EPSON** — your printer — **Printer Setting Utility**.

Note:

*The window to select a printer appears in this step when multiple print drivers are installed on your computer. In this case, click the name of the desired printer listed in **Printer Name**.*

The Printer Setting Utility starts.

2. Click the **Printer Maintenance** tab.
3. Select **Non Genuine Toner** from the list at the left side of the page.

The **Non Genuine Toner** page is displayed.

4. Select the check box next to **On**, and then click the **Apply New Settings** button.

Chapter 11

Maintenance

Cleaning the Printer

This section describes how to clean the printer in order to maintain it in good condition and print clean printouts all the time.

**Warning:**

When cleaning this product, use the designated cleaning materials exclusive to it. Other cleaning materials may result in poor performance of the product. Never use aerosol cleaners to avoid catching fire and explosion.

**Caution:**

When cleaning this product, always switch off and unplug it. Access to a live machine interior may cause electric shock.

Cleaning the Scanner

To ensure the best possible copies, clean the scanner at the start of each day and during the day, as needed, to keep it clean.

1. Slightly dampen a soft lint-free cloth or paper towel with water.
2. Open the document cover.

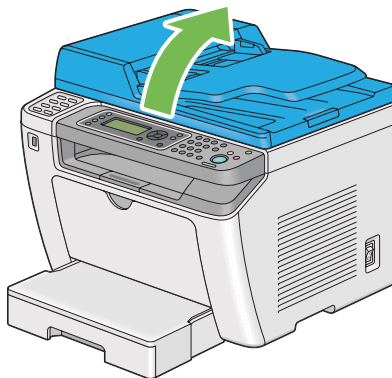

3. Wipe the surface of the document glass and ADF glass until they are clean and dry.

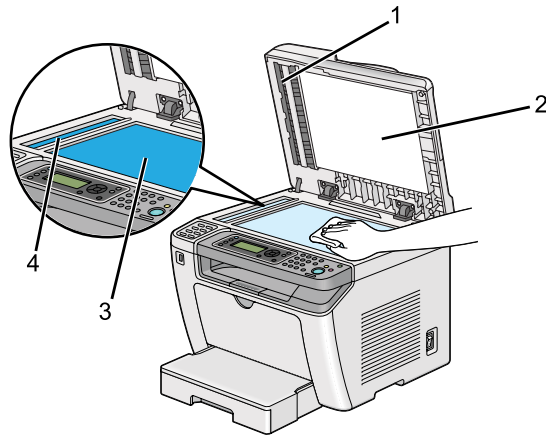

1	Film
2	White Document Cover
3	Document Glass
4	ADF Glass

4. Wipe the underside of the white document cover and film until they are clean and dry.

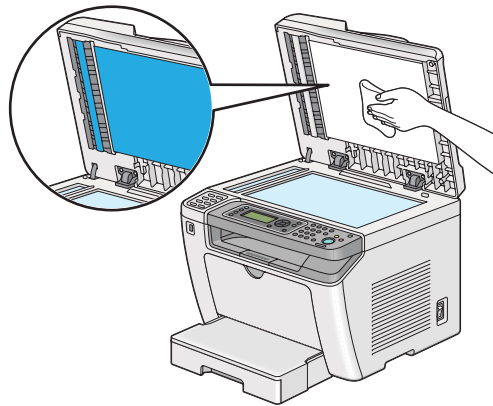

5. Close the document cover.

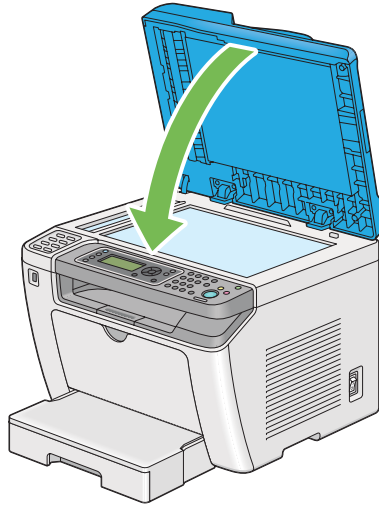

Cleaning the ADF Feed Roller

To ensure the best possible copies, clean the ADF feed roller at regular intervals to keep it clean.

1. Open the ADF cover.

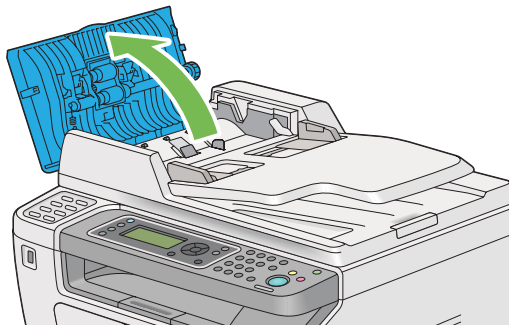

2. Wipe the ADF feed roller with a dry soft lint-free cloth or paper towel until it is clean.

The ADF feed roller soiled with ink stains may dirty the paper that goes through the Automatic Document Feeder (ADF). In such a case, slightly dampen a soft lint-free cloth or paper towel with neutral detergent or water, and wipe the ADF feed roller until it is clean and dry.

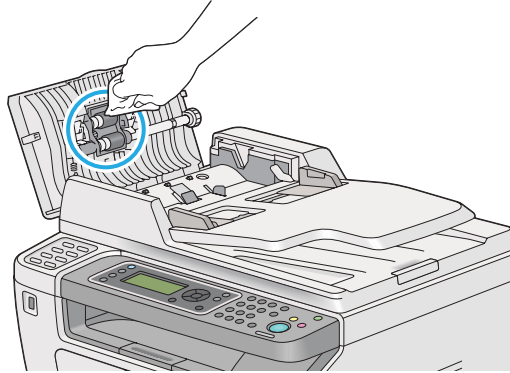

Replacing the Toner Cartridge

Genuine toner cartridges are available only through Epson.

It is recommended that you use a genuine toner cartridge for your printer. Epson does not provide warranty coverage for problems caused by using non-genuine consumables.



Warning:

- ❑ *Use a broom or a wet cloth to wipe off spilled toner. Never use a vacuum cleaner for the spills. It may catch fire by electric sparks inside the vacuum cleaner and cause explosion. If you spill a large volume of toner, contact your local Epson representative.*
- ❑ *Never throw a toner cartridge into an open flame. Remaining toner in the cartridge may catch fire and cause burn injuries or explosion. If you have a used toner cartridge no longer needed, contact your local Epson representative for its disposal.*

**Caution:**

- Keep drum cartridges (or drum if not a cartridge type) and toner cartridges out of the reach of children. If a child accidentally swallows toner, spit it out, rinse mouth with water, drink water and consult a physician immediately.*
- When replacing drum cartridges (or drum if not a cartridge type) and toner cartridges, be careful not to spill the toner. In case of any toner spills, avoid contact with clothes, skin, eyes and mouth as well as inhalation.*
- If toner spills onto your skin or clothing, wash it off with soap and water. If you get toner particles in your eyes, wash it out with plenty of water for at least 15 minutes until irritation is gone. Consult a physician if necessary. If you inhale toner particles, move to a fresh air location and rinse your mouth with water. If you swallow toner, spit it out, rinse your mouth with water, drink plenty of water and consult a physician immediately.*

Important:

Do not shake the used toner cartridge to avoid spilling of the toner.

When to Replace the Toner Cartridge

The printer has one toner cartridge: black (K).

When a toner cartridge reaches its usable life-span, the following messages appear on the LCD panel.

Message	Remaining Page Yield	Printer Status and Action
093-426*	Approx. 500 pages	The toner cartridge has become low. Prepare a new one.
093-933	—	The toner cartridge has become empty. Replace the old toner cartridge with a new one.

* This warning appears only when a genuine toner cartridge is used (i.e. Non Genuine Toner is disabled).

Important:

- When placing a used toner cartridge on the floor or on a table, place a few sheets of paper under the toner cartridge to catch any toner that may spill.*
- Do not reuse old toner cartridges that you remove from the printer. Doing so can impair print quality.*
- Do not shake or pound used toner cartridges. The remaining toner may spill.*
- We recommend you use up a toner cartridge within one year after you remove it from the packaging.*

Removing the Toner Cartridge

1. Open the front cover.

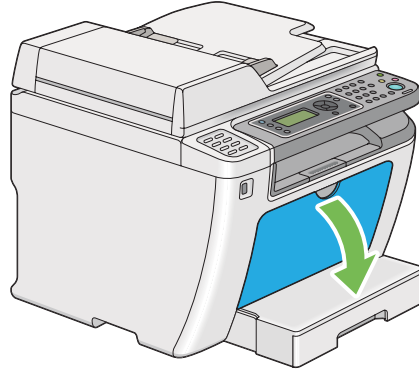

2. Open the toner access cover.

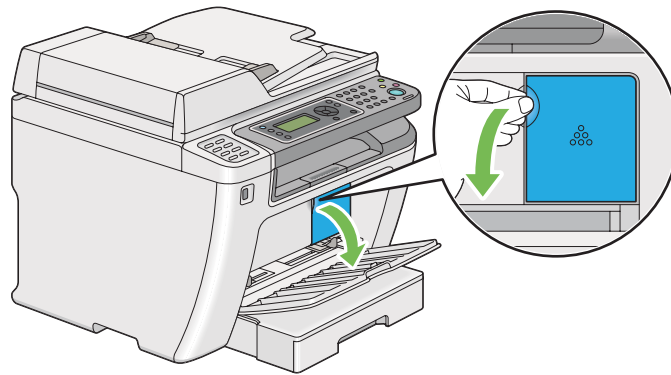

3. Spread a few sheets of paper on the floor or table where you want to place the removed toner cartridge.

4. Turn the toner cartridge counterclockwise to unlock.

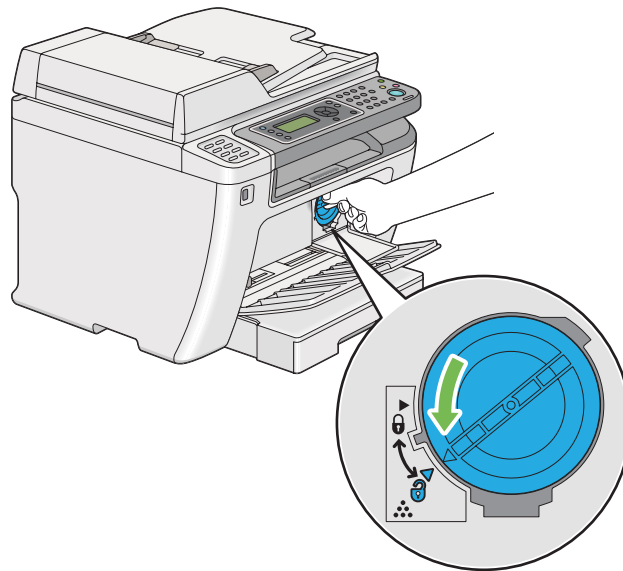

5. Pull the toner cartridge out.

Important:

- ❑ Do not touch the shutter of the used toner cartridge.
- ❑ Always pull the toner cartridge out slowly so you do not spill any toner.

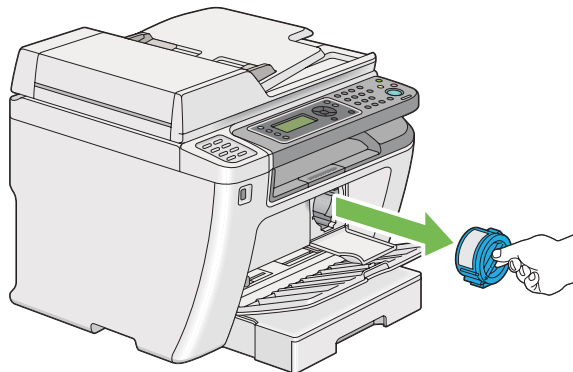

6. Place the toner cartridge slowly on the sheets of paper you spread in step 4.

Installing a Toner Cartridge

1. Unpack a new toner cartridge and shake it five times to distribute the toner evenly.

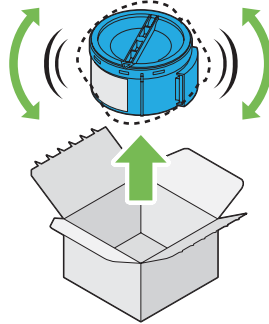

Note:

Handle the toner cartridge carefully to avoid spilling of the toner.

2. Insert the toner cartridge into the cartridge holder, and then turn it clockwise to align to the lock mark.

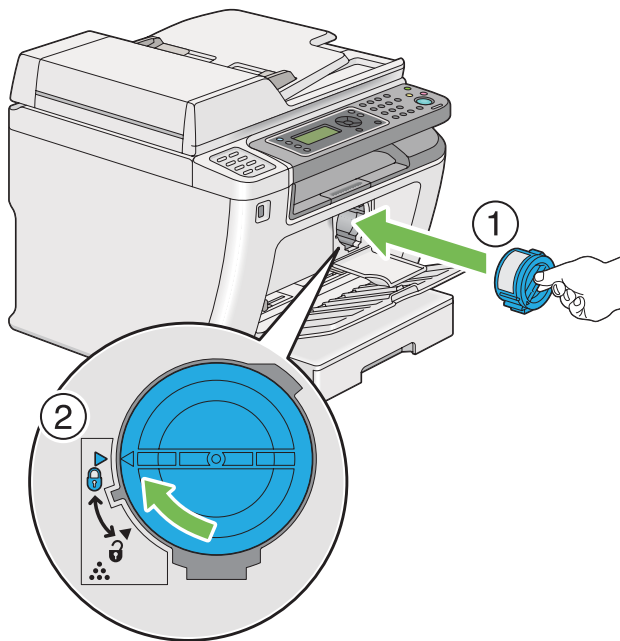

Important:

Be sure to secure the toner cartridge firmly before printing. Otherwise, it may cause some defects.

3. Close the toner access cover. Make sure that the cover clicks into place.

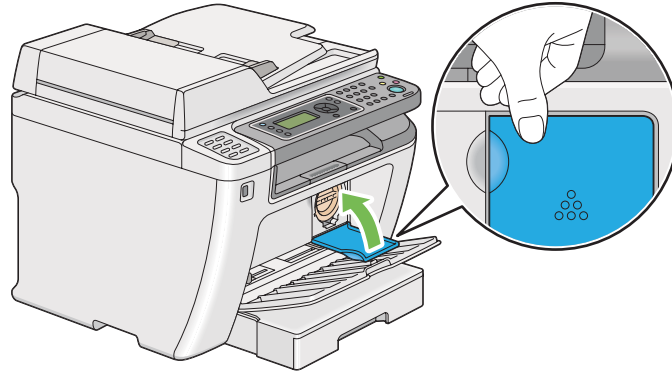

4. Close the front cover.

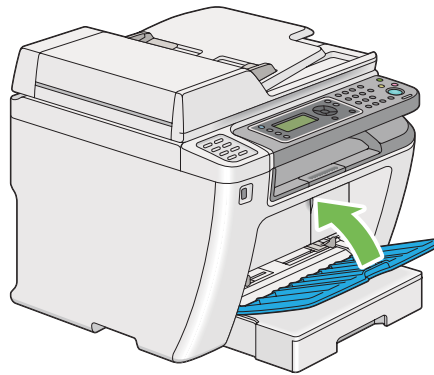

5. Pack the removed toner cartridge in the box in which the installed toner cartridge was packed up.
6. Taking care not to touch any spilled toner, dispose of the sheets of paper you used for toner cartridge replacement.

Ordering Supplies

The toner cartridge needs to be ordered occasionally. The toner cartridge includes installation instructions on the box.

Consumables

Important:

Use only consumables we recommend. Use of any consumables other than recommended can impair machine quality and performance.

Product Name	Product Code
TONER CARTRIDGE	0709
DOUBLE TONER CARTRIDGE PACK	0710
RETURN DOUBLE TONER CARTRIDGE PACK	0711

Important:

The number of printable pages are applicable when A4 plain paper SEF (□) is used and printing is done continuously in the print ratio of 5% in image density. Also, it satisfies the public values on the basis of JIS X6931 (ISO/IEC 19752). These values are estimates and vary depending on conditions such as the content being printed, paper size, paper type, the printer's operating environment, initializing process done when you turn on or off the printer, and adjustments to maintain print quality.

Note:

- The printable number of pages for the starter toner cartridge shipped with the printer is approximately 1,000 pages.
- Each toner cartridge includes installation instructions on the box.

When to Order a Toner Cartridge

The LCD panel displays a warning when the toner cartridge nears its replacement time. Verify that you have a replacement at hand. It is important to order a toner cartridge when the message first appears to avoid interruptions to your printing. The LCD panel displays an error message when the toner cartridge must be replaced.

To order a toner cartridge, contact our local representative office or authorized dealer.

Important:

This printer is designed to provide the most stable performance and print quality when used with the recommended toner cartridge. Not using the toner cartridge recommended for this printer degrades the performance and printing quality of the printer. You could also incur charges if the printer breaks down. To receive customer support and achieve the optimum performance of the printer, be sure to use the recommended toner cartridge.

Recycling Supplies

- For environmental protection and efficient use of resources, Epson reuses returned toner cartridges and drums (photoreceptors) to make recycle parts, recycle materials or energy recovery.
- Proper disposal is required for toner cartridges no longer needed. Do not open toner cartridges. Return them to your local Epson representative.

Storing Consumables

Store consumables in their original packaging until you need to use them. Do not store consumables in:

- Temperatures greater than 40 °C (140 °F).
- An environment with extreme changes in humidity or temperature.
- Direct sunlight.
- Dusty places.
- A car for a long period of time.
- An environment where corrosive gases are present.
- An environment with salty air.

Managing the Printer

Checking or Managing the Printer with EpsonNet Config

When the printer is installed in a TCP/IP environment, you can check printer status and configure settings using a web browser on a network computer. You can also use EpsonNet Config to check the remaining volume of consumables and the paper loaded in this printer.

Note:

When using the printer as a local printer, you cannot use EpsonNet Config. For details on checking the status of a local printer, refer to “Checking Printer Status with Status Monitor (Windows Only)” on page 389.

Starting EpsonNet Config

Use the following procedure to start EpsonNet Config.

1. Launch your web browser.
2. Enter the IP address of the printer in the address bar, and then press the **Enter** key.

EpsonNet Config appears on your browser.

Using Online Help

For details regarding the items that you can set on EpsonNet Config, click the **Help** button to display the online Help.

Checking Printer Status with Status Monitor (Windows Only)

Status Monitor is a tool that is installed along with your print driver. It automatically checks the printer status when you send a print job. Status Monitor can also check the status of the paper tray and remaining amount of toner in the toner cartridge.

Starting Status Monitor

Double-click the Status Monitor icon on the taskbar or right-click the icon and select **Printer Selection**.

If the Status Monitor icon is not displayed on the taskbar, open Status Monitor from the **Start** menu.

The following procedure uses Microsoft® Windows® 7 as an example.

1. Click **Start — All Programs — EPSON — your printer — Activate Status Monitor**.

The **Printer Selection** window appears.

2. Click the name of the desired printer from the list.

The **Printer Status** window appears.

For details on the functions of Status Monitor, refer to the Help of Status Monitor.

See Also:

“Status Monitor (Windows Only)” on page 35

Checking Printer Status Through E-mail

When connected in a network environment where e-mail exchange is available, the printer can send an e-mail report to specified e-mail addresses containing the following information:

- The error status which has occurred on the printer

Setting the E-mail Environment

Access EpsonNet Config. On the **Properties** tab, configure the following settings according to your e-mail environment. After configuring the settings on each window, always click **Apply** and then turn off/on the printer to reboot. For details on each item, refer to the Help on EpsonNet Config.

Item	Item to be configured	Description
General Setup — StatusMessenger	Recipient's E-mail Address	Specify up to two e-mail addresses to which notices about changes in printer status or errors are sent.
	Notification Items	Set the content of the notices to send via e-mail.
Port Status	StatusMessenger	Select Enabled .
Protocol Settings — E-mail	SMTP Server Settings <input type="checkbox"/> Machine's E-mail Address <input type="checkbox"/> SMTP Server Address <input type="checkbox"/> SMTP Server Port Number Send Authentication <input type="checkbox"/> E-mail Send Authentication <input type="checkbox"/> Login Name <input type="checkbox"/> Password <input type="checkbox"/> Re-enter Password POP3 Server Settings <input type="checkbox"/> POP3 Server Address <input type="checkbox"/> POP3 Server Port Number <input type="checkbox"/> Login Name <input type="checkbox"/> Password <input type="checkbox"/> Re-enter Password	Select appropriate settings for sending and receiving e-mails.

Conserving Supplies

You can change several settings of your print driver to conserve toner and paper.

Supply	Setting	Function
Toner cartridge	Toner Saving Mode in the Graphics tab of the print driver	This check box allows the users to select a print mode that uses less toner. When this feature is used, the image quality will be lower than when it is not used.
Print media	Multiple Up in the Layout tab of the print driver	<p>The printer prints two or more pages on one side of a sheet. The available numbers that each print driver can print on one sheet of paper are as follows:</p> <ul style="list-style-type: none"> <input type="checkbox"/> Windows® Print Driver: 2, 4, 8, or 16 pages <input type="checkbox"/> Mac OS X Print Driver: 2, 4, 6, 9, or 16 pages <p>Combined with the Duplex (2-sided) print setting, Multiple Up allows you to print up to 32 pages on one sheet of paper. (16 images on the front and 16 on the back)</p>

Checking Page Counts

You can print the System Settings page to check the total number of printed pages. The total number of printed pages is shown in the Print Volume section, classified by paper sizes.

Single side print (including Multiple Up print) is counted as one job, and 2-sided print (including Multiple Up print) is counted as two. During duplex (2-sided) printing, if an error occurs after one side is printed properly, it is counted as one.

During duplex (2-sided) printing, a blank page may be inserted automatically depending on the settings of the application. In this case, the blank page is counted as one page. If a blank page is inserted during duplex (2-sided) printing for odd-number pages and the rear of the last odd-number page is left blank, however, this page is excluded from page counting.

Note:

Refer to “Printing the System Settings Page” on page 155 for details on how to print the System Settings page.

Moving the Printer

1. Turn off the printer.

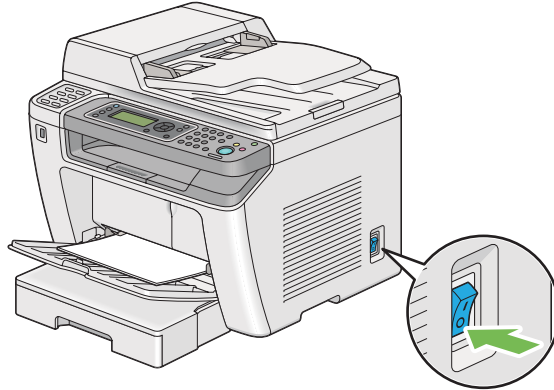

2. Disconnect the power cord, interface cable, and any other cables.

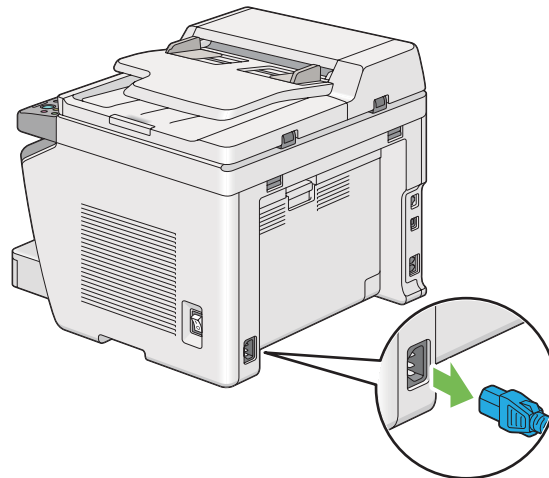

3. Remove all paper from the document output tray.

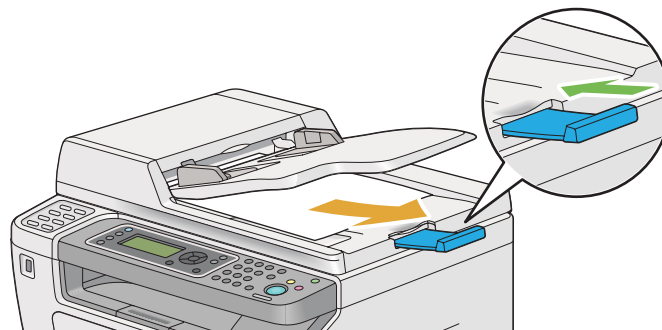

4. Lift the scanner unit, remove all paper from the center output tray, and then retract the output tray extension, if extended.

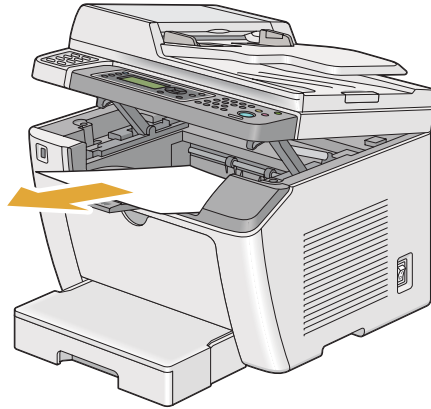

5. Remove the paper tray from the printer.

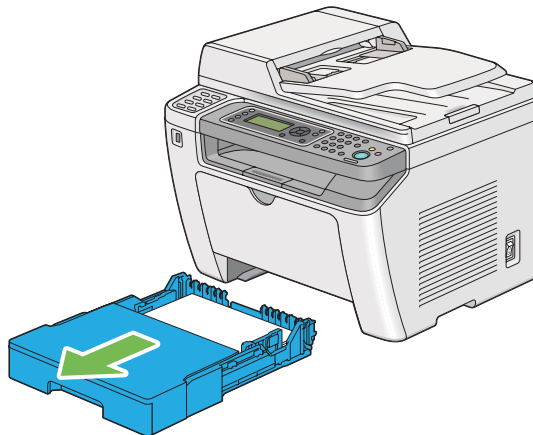

6. Lift the printer and move it gently.

Note:

If you move the printer over a long distance, be sure to remove the toner cartridge and pack the printer inside a box to avoid spilling of the toner.



7. Place the printer at a new location and replace the paper tray.

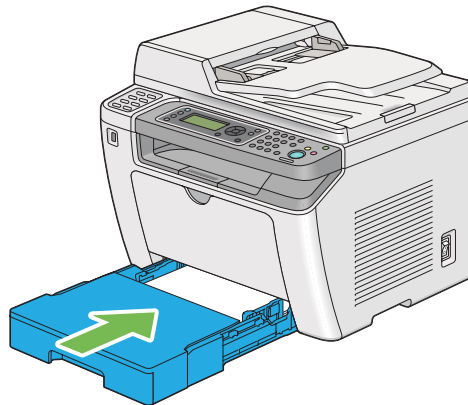

Appendix A

Where To Get Help

Contacting Epson Support

Before Contacting Epson

If your Epson product is not operating properly and you cannot solve the problem using the troubleshooting information in your product documentation, contact Epson support services for assistance. If Epson support for your area is not listed below, contact the dealer where you purchased your product.

Epson support will be able to help you much more quickly if you give them the following information:

- Product serial number
(The serial number label is usually on the back of the product.)
- Product model
- Product software version
(Click **About**, **Version Info**, or similar button in the product software.)
- Brand and model of your computer
- Your computer operating system name and version
- Names and versions of the software applications you normally use with your product

Help for Users in Europe

Check your **Pan-European Warranty Document** for information on how to contact Epson support.

Help for Users in Taiwan

Contacts for information, support, and services are:

World Wide Web (<http://www.epson.com.tw>)

Information on product specifications, drivers for download, and products enquiry are available.

Epson HelpDesk (Phone: +0280242008)

Our HelpDesk team can help you with the following over the phone:

- Sales enquiries and product information
- Product usage questions or problems
- Enquiries on repair service and warranty

Repair service center:

Telephone number	Fax number	Address
02-23416969	02-23417070	No.20, Beiping E. Rd., Zhongzheng Dist., Taipei City 100, Taiwan
02-27491234	02-27495955	1F., No.16, Sec. 5, Nanjing E. Rd., Songshan Dist., Taipei City 105, Taiwan
02-32340688	02-32340699	No.1, Ln. 359, Sec. 2, Zhongshan Rd., Zhonghe City, Taipei County 235, Taiwan
039-605007	039-600969	No.342-1, Guangrong Rd., Luodong Township, Yilan County 265, Taiwan
038-312966	038-312977	No.87, Guolian 2nd Rd., Hualien City, Hualien County 970, Taiwan
03-4393119	03-4396589	5F., No.2, Nandong Rd., Pingzhen City, Taoyuan County 32455, Taiwan (R.O.C.)
03-5325077	03-5320092	1F., No.9, Ln. 379, Sec. 1, Jingguo Rd., North Dist., Hsinchu City 300, Taiwan
04-23011502	04-23011503	3F., No.30, Dahe Rd., West Dist., Taichung City 40341, Taiwan (R.O.C.)
04-23805000	04-23806000	No.530, Sec. 4, Henan Rd., Nantun Dist., Taichung City 408, Taiwan
05-2784222	05-2784555	No.463, Zhongxiao Rd., East Dist., Chiayi City 600, Taiwan
06-2221666	06-2112555	No.141, Gongyuan N. Rd., North Dist., Tainan City 704, Taiwan

Telephone number	Fax number	Address
07-5520918	07-5540926	1F., No.337, Minghua Rd., Gushan Dist., Kaohsiung City 804, Taiwan
07-3222445	07-3218085	No.51, Shandong St., Sanmin Dist., Kaohsiung City 807, Taiwan
08-7344771	08-7344802	1F., No.113, Shengli Rd., Pingtung City, Pingtung County 900, Taiwan

Help for Users in Singapore

Sources of information, support, and services available from Epson Singapore are:

World Wide Web (<http://www.epson.com.sg>)

Information on product specifications, drivers for download, Frequently Asked Questions (FAQ), Sales Enquiries, and Technical Support via e-mail are available.

Epson HelpDesk (Phone: (65) 6586 3111)

Our HelpDesk team can help you with the following over the phone:

- Sales enquiries and product information
- Product usage questions or problems
- Enquiries on repair service and warranty

Help for Users in Thailand

Contacts for information, support, and services are:

World Wide Web (<http://www.epson.co.th>)

Information on product specifications, drivers for download, Frequently Asked Questions (FAQ), and e-mail are available.

Epson Hotline (Phone: (66)2685-9899)

Our Hotline team can help you with the following over the phone:

- Sales enquiries and product information
- Product usage questions or problems
- Enquiries on repair service and warranty

Help for Users in Vietnam

Contacts for information, support, and services are:

Epson Hotline (Phone): 84-8-823-9239

Service Center: 80 Truong Dinh Street, District 1, Hochiminh City
Vietnam

Help for Users in Indonesia

Contacts for information, support, and services are:

World Wide Web (<http://www.epson.co.id>)

- Information on product specifications, drivers for download
- Frequently Asked Questions (FAQ), Sales Enquiries, questions through e-mail

Epson Hotline

- Sales enquiries and product information
- Technical support

Phone (62) 21-572 4350

Fax (62) 21-572 4357

Epson Service Center

Jakarta	Mangga Dua Mall 3rd floor No 3A/B Jl. Arteri Mangga Dua, Jakarta Phone/Fax: (62) 21-62301104
Bandung	Lippo Center 8th floor Jl. Gatot Subroto No.2 Bandung Phone/Fax: (62) 22-7303766
Surabaya	Hitech Mall It IIB No. 12 Jl. Kusuma Bangsa 116 – 118 Surabaya Phone: (62) 31-5355035 Fax: (62)31-5477837
Yogyakarta	Hotel Natour Garuda Jl. Malioboro No. 60 Yogyakarta Phone: (62) 274-565478
Medan	Wisma HSBC 4th floor Jl. Diponegoro No. 11 Medan Phone/Fax: (62) 61-4516173
Makassar	MTC Karebosi Lt. III Kav. P7-8 Jl. Ahmad Yani No.49 Makassar Phone: (62)411-350147/411-350148

Help for Users in Hong Kong

To obtain technical support as well as other after-sales services, users are welcome to contact Epson Hong Kong Limited.

Internet Home Page

Epson Hong Kong has established a local home page in both Chinese and English on the Internet to provide users with the following information:

- Product information
- Answers to Frequently Asked Questions (FAQs)
- Latest versions of Epson product drivers

Users can access our World Wide Web home page at:

<http://www.epson.com.hk>

Technical Support Hotline

You can also contact our technical staff at the following telephone and fax numbers:

Phone: (852) 2827-8911

Fax: (852) 2827-4383

Help for Users in Malaysia

Contacts for information, support, and services are:

World Wide Web (<http://www.epson.com.my>)

- Information on product specifications, drivers for download
- Frequently Asked Questions (FAQ), Sales Enquiries, questions through e-mail

Epson Trading (M) Sdn. Bhd.

Head Office.

Phone: 603-56288288

Fax: 603-56288388/399

Epson Helpdesk

- Sales enquiries and product information (Infoline)

Phone: 603-56288222

- Enquiries on repair services & warranty, product usage and technical support (Techline)

Phone: 603-56288333

Help for Users in the Philippines

To obtain technical support as well as other after sales services, users are welcome to contact the Epson Philippines Corporation at the telephone and fax numbers and e-mail address below:

Trunk Line: (63-2) 706 2609

Fax: (63-2) 706 2665

Helpdesk Direct Line: (63-2) 706 2625

E-mail: epchelpdesk@epc.epson.com.ph

World Wide Web (<http://www.epson.com.ph>)

Information on product specifications, drivers for download, Frequently Asked Questions (FAQ), and E-mail Enquiries are available.

Toll-Free No. 1800-1069-EPSON(37766)

Our Hotline team can help you with the following over the phone:

- Sales enquiries and product information
- Product usage questions or problems

- ❑ Enquiries on repair service and warranty

Index

- #**
- # button.....29
- 2**
- 2-Sided.....175, 267 , 273 , 307 , 316
 - 2-Sided Print.....259, 286
 - 2-Sided Report.....294
- A**
- Address Book.....264
 - Address Book button.....29
 - Address Book Editor.....37
 - ADF cover.....27, 28 , 329
 - ADF glass.....28, 379
 - Adjust Altitude.....300
 - Adjust BTR.....296
 - Adjust Fusing Unit.....296
 - Admin Menu.....264
 - Alert Tone.....293
 - Ans Select.....258, 280
 - Ans/FAX Mode.....258
 - Applicable lines.....24
 - Auto Ans. Ans/FAX.....258, 281
 - Auto Ans. TEL/FAX.....258, 281
 - Auto Answer Fax.....258, 281
 - Auto Exposure.....174, 307 , 312
 - Auto Reset.....291
 - AutoFit.....317
 - Automatic Document Feeder (ADF).....26, 27
 - Automatic duplex printing.....140
 - Automatic redialing.....231
 - Avoiding jams.....327
- B**
- Back button.....29
 - Basic printer problems.....345
- C**
- C (Clear) button.....29
 - Canceling a print job.....139
 - From computer.....139
 - From operator panel.....139
 - Center output tray.....26, 329 , 340
 - CentreWare Internet Services
 - Managing printer.....388
 - Online help for.....389
 - Starting.....389
 - Clean Developer.....297
 - Clear All button.....29
 - Clearing jams.....327
 - Clearing paper jams
 - From Automatic Document Feeder (ADF).....330
 - From center output tray.....340
 - From front of printer.....333
 - From paper tray.....333
 - From Priority Sheet Inserter (PSI).....336
 - From rear of printer.....338
 - Clock mode.....223
 - Clock Settings.....292
 - Coding method.....24
 - Collated.....170, 305
 - Color.....310
 - Company Name.....259, 284
 - Connecting printer.....39
 - Connection specifications.....40
 - Connection type.....40
 - Connectivity.....22
 - Conserving supplies.....391
 - Consumables.....387
 - Contacting Epson.....395
 - Contacting service.....375
 - Continuous copy.....19
 - Continuous copy speed.....19
 - Continuous print speed.....20
 - Copy
 - ID card.....180
 - Limiting access.....321
 - Copy button/LED.....28

Copy problem.....	357	Extel Hook Thresh.....	260, 288
Copy quality		F	
Problems.....	358	F/W Version.....	295
Custom paper.....	152	Fault Time-Out.....	292
With Mac OS X driver.....	154	Fax	
With Windows print driver.....	153	Limiting access.....	321
Customizing copy options.....	165	Fax Activity.....	260, 264 , 289
D		Fax Broadcast.....	260, 290
Data LED.....	29	Fax button/LED.....	29
Delayed Start.....	315	Fax Cover Page.....	259, 285
Density Adjustment.....	297	Fax Fwd E-Mail.....	259, 287
Dialing Type.....	258, 282	Fax Fwd Number.....	259, 287
Dimensions.....	20	FAX Mode.....	258
Direct Fax.....	232	Fax Number.....	259
Discard Size.....	259, 288	Fax problems.....	359
Display problems.....	345	Fax Transmit.....	260
Document cover.....	28	File Format.....	310
Document feeder tray.....	26, 28	Film.....	379
Document glass.....	28, 379	First Copy Output Time.....	19
Document guides.....	28	Font.....	267
Document output tray.....	26	Font Pitch.....	270
Document Size.....	311	Font Size.....	269
Document size.....	24	Form Line.....	270
Document stopper.....	26	Forward Settings.....	259, 287
Document Type.....	171, 227 , 306 , 315	Front cover.....	26, 329
Draft Mode.....	271	G	
DRPD Mode.....	258	Getting help.....	375
DRPD Pattern.....	259, 285	Status Monitor Alerts.....	376
Duplex printing.....	140	Gray Balance.....	307
E		Group Dial.....	265
ECM.....	260, 288	Group dialing.....	246
Edit From Field.....	303	H	
Energy Saver button/LED.....	29	Half-tone.....	18
Envelope.....	296, 297	HDD.....	18
EpsonNet Config.....	33	Help	
Error and warning messages.....	376	Epson.....	395
Error History.....	264		
Error LED.....	29		
Ethernet.....	274		
Ethernet port.....	27, 40		
Express Scan Manager.....	37		

I	
Image Compression.....	314
Image Enhance.....	270
Initialize NVM.....	279, 299
Installing print driver	
Linux.....	104
Mac OS X.....	99
Windows.....	49
Internet Services.....	279
Interval Timer.....	258, 283
IP Filter.....	279
J	
Job History.....	263
Job Status button/LED.....	28
Job Time-Out.....	292
Junk Fax Filter.....	259, 283
L	
Labels.....	296, 297
Launcher.....	36
Layout.....	274, 316
LCD panel.....	29
LCD panel messages.....	376
Levers.....	27
Light Card.....	296, 297
Lighten/Darken.....	172, 227, 306, 311, 315
Line Monitor.....	258, 281
Line Termination.....	271
Line Type.....	258, 282
Loading envelopes in the paper tray.....	128, 134
Loading print media.....	122
Paper tray.....	123
Priority Sheet Inserter (PSI).....	132
Low Toner Alert Msg.....	295
LPD.....	278
M	
Machine life.....	298
Machine weight.....	20
Main components.....	26
Maintenance.....	295
Manual duplex printing.....	141
Margin Left/Right.....	178, 308, 313
Margin Middle.....	179, 309, 313
Margin Top/Bottom.....	177, 308, 312
Max E-Mail Size.....	314
Memory.....	18
Meter Readings.....	264
mm / inch.....	294
Modem Speed.....	260, 289
Mottle.....	352
Multiple Up.....	175, 308, 391
N	
Network.....	274
Network connection setup.....	53
Non Genuine Toner.....	299, 376
Number of copies.....	165
Number of fax lines.....	24
Number of Redial.....	259, 283
Numeric keypad.....	28
O	
OK button.....	29
One-touch buttons.....	28
OPC drum.....	27, 329
Operating system.....	21, 25
Operator panel.....	26, 28
Ordering supplies.....	387
Orientation.....	267
Original paper size.....	18, 22
Original Size.....	166, 304
Output Paper Size.....	167
Output paper size.....	18
Output paper weight.....	19
Output tray capacity.....	19
Output tray extension.....	26, 136
P	
Panel Language.....	319
Panel Lock.....	300, 320
Panel Settings.....	263

Panel Settings page.....	30	Print driver	
Paper chute.....	27	Linux.....	104
Paper Error.....	309	Mac OS X.....	99
Paper jam location.....	328	PCL.....	49
Center output tray.....	329	Windows.....	49
Front cover.....	329	Print driver pre-install status.....	50
Levers.....	329	Print media.....	391
OPC drum.....	329	Dimensions.....	123
Paper tray.....	329	Print Mode.....	273
Priority Sheet Inserter (PSI).....	329	Print quality problems.....	348
Rear cover.....	329	Print resolution.....	21
Paper jams.....	333, 338, 340, 344	Printer	
Paper tray.....	333	Managing.....	388
Priority Sheet Inserter (PSI).....	336	Messages.....	364
Paper Size.....	265, 273	Moving.....	392
Paper Tray.....	317	Status.....	390
Paper tray.....	26, 120, 329	Printer messages.....	364
Paper tray capacity.....	19	Printer Setting Utility.....	34
Paper tray cover.....	26	Printer software.....	33
Paper width guides.....	26, 126	Printer status.....	390
Parts name.....	26	Printing.....	138
PCL Fonts List.....	264	Basics.....	115
PCL print driver.....	49	Custom paper.....	152
PCL Settings.....	265	From computer.....	138
PDF Password.....	273, 317	Problems.....	346
PDF Settings.....	272	With Web Services on Devices.....	158
PDL.....	21	Printing problems.....	346
Peer-to-peer.....	93	Printing resolution.....	18
Phone Book.....	265	Printing with Web Services on Devices.....	158
Phone connector.....	27, 40	Priority Sheet Inserter (PSI).....	26, 121, 329, 336
Plain.....	296, 297	Problems	
Point and Print.....	89	contacting Epson.....	395
Port 9100.....	278	solving.....	395
Port Status.....	303	Product features.....	13
Post Card.....	296, 297	Protocol.....	21, 278
Power connector.....	27	Protocol Monitor.....	264
Power consumption.....	20	PS Data Format.....	280, 303
Power On Wizard.....	295	PS Error Report.....	272
Power saver mode.....	322	PS Fonts List.....	264
Power Saver Timer.....	290	PS Job Time-Out.....	272
Power supply.....	19	PS Settings.....	271
Power switch.....	26		
Prefix Dial.....	259, 260, 287	Q	
Prefix Dial Num.....	259, 288	Quantity.....	270, 272
Print button/LED.....	29		

R	
Rear cover.....	27, 329
Rear cover handle.....	27
Recording paper size.....	23
Recycled.....	296, 297
Recycling supplies.....	388
Redial Delay.....	259, 283
Redial/Pause button.....	29
Reduce/Enlarge.....	168, 304
Reduction/enlargement.....	19
Region.....	260, 290
Registration roller.....	27
Remote Rcv Tone.....	259, 284
Remote Receive.....	259, 284
Report page.....	155
Reset Wireless.....	277
Resetting to factory defaults.....	323
Resolution.....	226, 310, 314
Setting scan resolution.....	217
Ring Tone Volume.....	258, 282
Ringer volume.....	256
S	
Scan button/LED.....	28
Scan settings	
Color mode.....	216
Document size.....	217
Scan resolution.....	217
Scanned image file type.....	216
Suppress background color.....	218
Scan to e-mail.....	23
Scan to Network.....	309
Scan to PC.....	23
Scanner driver/printer utility problems.....	363
Scanning	
Limiting access.....	321
Scanning halftone.....	22
Scanning problems.....	361
Scanning resolution.....	18, 22, 24
Secure Receive.....	302
Secure Settings.....	300
Send document size.....	23
Send Header.....	259, 284
Sending a fax.....	224
Sending a fax from memory.....	228
Sending a fax manually.....	229
Service.....	395
Service Lock.....	301
Setting the printer ID.....	222
Setting the time and date.....	223
Setting your region.....	221
Sharpness.....	173, 306, 312
SNMP.....	278
Software Download.....	302
Software installation.....	39
Space requirement.....	20
Speaker volume.....	256
Specifications.....	18
Speed Dial.....	265
Speed Dial button.....	29
Start button.....	29
Status Monitor Alerts.....	376
StatusMessenger.....	279, 390
Configuring.....	390
Stop button.....	29
Storing consumables.....	388
Supplies	
Recycling.....	388
When to order.....	387
Symbol Set.....	269
System button/LED.....	28
System Settings.....	263, 290
T	
TCP/IP.....	277
TEL Mode.....	258
TEL/FAX Mode.....	258
TIFF File Format.....	313
Toner access cover.....	26
Toner cartridge.....	26, 382
Conserving.....	391
Install.....	385
Remove.....	383
When to order.....	387
When to replace.....	382
Toner Refresh.....	298
Tool Without An Interesting Name (TWAIN).....	183

Total page counts.....	391
Transfer roller.....	27
Transmission mode.....	24
Transmission resolution.....	24
Transmission speed.....	24
Transmission time.....	24
Tray Settings.....	317

U

Usage environment.....	20
USB direct print	
Limiting access.....	321
USB port.....	26, 27 , 40
USB Settings.....	303
USB storage device.....	210

W

Wall jack connector.....	27, 40 , 220
White document cover.....	379
Windows Image Acquisition (WIA).....	185
Wireless network settings.....	54
Wireless Setup.....	275
Wireless Status.....	275
WPS Setup.....	277

Y

Your Fax Number.....	284
----------------------	-----