



L1455

User's Guide

Copyright

Copyright

No part of this publication may be reproduced, stored in a retrieval system, or transmitted in any form or by any means, electronic, mechanical, photocopying, recording, or otherwise, without the prior written permission of Seiko Epson Corporation. No patent liability is assumed with respect to the use of the information contained herein. Neither is any liability assumed for damages resulting from the use of the information herein. The information contained herein is designed only for use with this Epson product. Epson is not responsible for any use of this information as applied to other products.

Neither Seiko Epson Corporation nor its affiliates shall be liable to the purchaser of this product or third parties for damages, losses, costs, or expenses incurred by the purchaser or third parties as a result of accident, misuse, or abuse of this product or unauthorized modifications, repairs, or alterations to this product, or (excluding the U.S.) failure to strictly comply with Seiko Epson Corporation's operating and maintenance instructions.

Seiko Epson Corporation and its affiliates shall not be liable for any damages or problems arising from the use of any options or any consumable products other than those designated as Original Epson Products or Epson Approved Products by Seiko Epson Corporation.

Seiko Epson Corporation shall not be held liable for any damage resulting from electromagnetic interference that occurs from the use of any interface cables other than those designated as Epson Approved Products by Seiko Epson Corporation.

© 2016 Seiko Epson Corporation. All rights reserved.

The contents of this manual and the specifications of this product are subject to change without notice.

Trademarks

- ❑ EPSON® is a registered trademark, and EPSON EXCEED YOUR VISION or EXCEED YOUR VISION is a trademark of Seiko Epson Corporation.
- ❑ Epson Scan 2 software is based in part on the work of the Independent JPEG Group.
- ❑ libtiff

Copyright © 1988-1997 Sam Leffler

Copyright © 1991-1997 Silicon Graphics, Inc.

Permission to use, copy, modify, distribute, and sell this software and its documentation for any purpose is hereby granted without fee, provided that (i) the above copyright notices and this permission notice appear in all copies of the software and related documentation, and (ii) the names of Sam Leffler and Silicon Graphics may not be used in any advertising or publicity relating to the software without the specific, prior written permission of Sam Leffler and Silicon Graphics.

THE SOFTWARE IS PROVIDED "AS-IS" AND WITHOUT WARRANTY OF ANY KIND, EXPRESS, IMPLIED OR OTHERWISE, INCLUDING WITHOUT LIMITATION, ANY WARRANTY OF MERCHANTABILITY OR FITNESS FOR A PARTICULAR PURPOSE.

IN NO EVENT SHALL SAM LEFFLER OR SILICON GRAPHICS BE LIABLE FOR ANY SPECIAL, INCIDENTAL, INDIRECT OR CONSEQUENTIAL DAMAGES OF ANY KIND, OR ANY DAMAGES WHATSOEVER RESULTING FROM LOSS OF USE, DATA OR PROFITS, WHETHER OR NOT ADVISED OF THE POSSIBILITY OF DAMAGE, AND ON ANY THEORY OF LIABILITY, ARISING OUT OF OR IN CONNECTION WITH THE USE OR PERFORMANCE OF THIS SOFTWARE.

- ❑ SDXC Logo is a trademark of SD-3C, LLC.



- ❑ Memory Stick Duo, Memory Stick PRO Duo, Memory Stick PRO-HG Duo, Memory Stick Micro, and MagicGate Memory Stick Duo are trademarks of Sony Corporation.



- ❑ Microsoft®, Windows®, and Windows Vista® are registered trademarks of Microsoft Corporation.
- ❑ Apple, Macintosh, Mac OS, OS X, Bonjour, Safari, iPad, iPhone, iPod touch, and iTunes are trademarks of Apple Inc., registered in the U.S. and other countries.
- ❑ Google Cloud Print™, Chrome™, Chrome OS™, and Android™ are trademarks of Google Inc.
- ❑ Adobe and Adobe Reader are either registered trademarks or trademarks of Adobe Systems Incorporated in the United States and/or other countries.
- ❑ Intel® is a registered trademark of Intel Corporation.
- ❑ General Notice: Other product names used herein are for identification purposes only and may be trademarks of their respective owners. Epson disclaims any and all rights in those marks.

Contents

Copyright

Trademarks

About This Manual

Introduction to the Manuals.	9
Marks and Symbols.	9
Descriptions Used in this Manual.	10
Operating System References.	10

Important Instructions

Safety Instructions.	11
Safety Instructions for Ink.	12
Printer Advisories and Warnings.	12
Advisories and Warnings for Setting Up the Printer.	12
Advisories and Warnings for Using the Printer.	13
Advisories and Warnings for Transporting or Storing the Printer.	13
Advisories and Warnings for Using the Printer with a Wireless Connection.	14
Advisories and Warnings for Using Memory Cards.	14
Advisories and Warnings for Using the Touchscreen.	14
Protecting Your Personal Information.	14

Printer Basics

Part Names and Functions.	15
Control Panel.	18
Buttons and Lights.	18
Icons Displayed on the LCD Screen.	19
Icons Displayed on the Software Keyboard of the LCD Screen.	20
Presets Mode.	21

Network Settings

Network Connection Types.	22
Ethernet Connection.	22
Wi-Fi Connection.	22
Wi-Fi Direct Connection.	23
Connecting to a Computer.	24
Connecting to a Smart Device.	25

Making Wi-Fi Settings from the Control Panel.	25
Making Wi-Fi Settings Manually.	26
Making Wi-Fi Settings by Push Button Setup (WPS).	27
Making Wi-Fi Settings by PIN Code Setup (WPS).	28
Making Wi-Fi Direct Settings.	28
Making Advanced Network Settings from the Control Panel.	30
Checking the Network Connection Status.	31
Checking the Network Status Using Network Icon.	31
Checking the Network Status from the Control Panel.	32
Printing a Network Connection Report.	32
Printing a Network Status Sheet.	37
Replacing or Adding New Access Points.	37
Changing the Connection Method to a Computer.	38
Disabling Wi-Fi from the Control Panel.	39
Disconnecting Wi-Fi Direct from the Control Panel.	39
Restoring the Network Settings from the Control Panel.	40

Administrator Settings

Locking the Printer Settings Using an Administrator's Password.	41
Unlocking the Printer Settings.	41

Loading Paper

Paper Handling Precautions.	42
Available Paper and Capacities.	43
List of Paper Types.	44
Loading Paper in the Paper Cassette.	45
Loading Paper in the Rear Paper Feed Slot.	48

Placing Originals

Available Originals on the ADF.	52
Placing Originals on the ADF.	52
Placing Originals on the ADF for 2-up Copying.	54
Placing Originals on the Scanner Glass.	54

Inserting a Memory Card

Supported Memory Cards.	56
---------------------------------	----

Contents

Inserting and Removing a Memory Card. 56

Managing Contacts

Registering Contacts. 58

Registering Grouped Contacts. 59

Register Contacts on a Computer. 59

Backing up Contacts using a Computer. 59

Printing

Printing from the Control Panel. 61

 Printing a JPEG file. 61

 Printing a TIFF file. 62

 Menu Options for Memory Device. 63

Printing from a Computer. 64

 Printing Basics - Windows. 64

 Printing Basics - Mac OS X. 66

 Printing on 2-Sides. 68

 Printing Several Pages on One Sheet. 70

 Printing to Fit the Paper Size. 71

 Printing Multiple Files Together (for Windows Only). 72

 Printing One Image on Multiple Sheets to Create a Poster (for Windows Only). 73

 Printing Using Advanced Features. 79

 Printing Photos Using Epson Easy Photo Print. 82

Printing from Smart Devices. 82

 Using Epson iPrint. 82

Canceling Printing. 83

 Canceling Printing - Printer Button. 84

 Canceling Printing - Status Menu. 84

 Canceling Printing - Windows. 84

 Canceling Printing - Mac OS X. 84

Copying

Menu Options for Copy Mode. 85

Scanning

Scanning Using the Control Panel. 88

 Scanning to an Email. 88

 Scanning to a Network Folder or FTP Server. 89

 Scanning to a Memory Device. 91

 Scanning to the Cloud. 92

 Scanning to a Computer. 93

 Scanning to a Computer (WSD). 94

 Common Menu Options for Scanning. 96

Scanning from a Computer. 97

 Scanning Using Epson Scan 2. 97

Scanning from Smart Devices. 100

 Installing Epson iPrint. 100

 Scanning Using Epson iPrint. 100

Faxing

Setting Up a Fax. 102

 Connecting to a Phone Line. 102

 Making Basic Fax Settings. 106

Sending Faxes. 108

 Basic Fax Sending Operations. 108

 Various Ways of Sending Faxes. 110

Receiving Faxes. 114

 Setting Receiving Mode. 114

 Various Ways of Receiving Faxes. 115

 Saving and Forwarding Received Faxes. 116

Using Other Faxing Features. 121

 Printing Fax Report and List. 121

 Setting Security for Faxing. 122

 Checking Fax Jobs. 122

Menu Options for Fax Mode. 124

Fax Settings Options. 126

 User Default Settings. 126

 Send Settings. 127

 Receive Settings. 127

 Output Settings. 127

 Basic Settings. 128

 Security Settings. 129

 Check Fax Connection. 130

 Fax Setting Wizard. 130

Refilling Ink and Replacing Maintenance Boxes

Checking the Status of the Remaining Ink and the Maintenance Box. 131

Checking the Status of the Maintenance Box - Control Panel. 131

 Checking the Status of the Remaining Ink and the Maintenance Box - Windows. 131

 Checking the Status of the Remaining Ink and the Maintenance Box - Mac OS X. 131

Ink Bottle Codes. 132

Ink Bottle Handling Precautions. 132

Refilling the Ink Tanks. 133

Maintenance Box Code. 136

Maintenance Box Handling Precautions. 136

Replacing a Maintenance Box. 137

Contents

Maintaining the Printer

Checking and Cleaning the Print Head.	139
Checking and Cleaning the Print Head - Control Panel.	139
Checking and Cleaning the Print Head - Windows.	140
Checking and Cleaning the Print Head - Mac OS X.	140
Replacing Ink inside the Ink Tubes.	140
Replacing Ink inside the Ink Tubes - Windows.	141
Replacing Ink inside the Ink Tubes - Mac OS X.	141
Aligning the Print Head.	141
Aligning the Print Head - Control Panel.	141
Cleaning the Paper Path for Ink Smears.	142
Cleaning the ADF.	143
Cleaning the Scanner Glass.	144
Checking the Total Number of Pages Fed Through the Printer.	145
Checking the Total Number of Pages Fed Through the Printer - Control Panel.	145
Checking the Total Number of Pages Fed Through the Printer - Windows.	146
Checking the Total Number of Pages Fed Through the Printer - Mac OS X.	146
Saving Power.	146
Saving Power - Control Panel.	146

Menu Options for Setup Mode

Maintenance Box Service Life.	147
Menu Options for Maintenance.	147
Menu Options for Paper Setup.	148
Menu Options for Print Status Sheet.	148
Menu Options for Network Status.	148
Menu Options for Admin Settings.	149
Menu Options for System Administration.	149
Printer Settings.	149
Common Settings.	150
Wi-Fi/Network Settings.	151
Epson Connect Services.	152
Google Cloud Print Services.	153
Universal Print Settings.	153
Eco Mode.	154
Restore Default Settings.	154

Network Service and Software Information

Epson Connect Service.	156
--------------------------------	-----

Web Config.	156
Running Web Config on a Web Browser.	157
Running Web Config on Windows.	157
Running Web Config on Mac OS X.	157
Windows Printer Driver.	158
Restricting Settings for the Windows Printer Driver.	159
Making Operation Settings for the Windows Printer Driver.	159
Mac OS X Printer Driver.	160
Making Operation Settings for the Mac OS X Printer Driver.	160
Epson Scan 2 (Scanner Driver).	161
Epson Event Manager.	161
PC-FAX Driver (Fax Driver).	162
FAX Utility.	162
Epson Easy Photo Print.	163
E-Web Print (for Windows Only).	163
EPSON Software Updater.	163
EpsonNet Config.	164
Uninstalling Applications.	164
Uninstalling Applications - Windows.	164
Uninstalling Applications - Mac OS X.	165
Installing Applications.	166
Updating Applications and Firmware.	166

Solving Problems

Checking the Printer Status.	168
Checking Messages on the LCD Screen.	168
Error Code on the Status Menu.	169
Checking the Printer Status - Windows.	173
Checking Printer Status - Mac OS X.	174
Removing Jammed Paper.	174
Removing Jammed Paper from the Rear Paper Feed Slot.	174
Removing Jammed Paper from Inside the Printer.	174
Removing Jammed Paper from the Paper Cassette.	176
Removing Jammed Paper from Rear Cover 1 and Rear Cover 2.	179
Removing Jammed Paper from the ADF.	181
Paper Does Not Feed Correctly.	183
Paper Jams.	184
Paper Feeds at a Slant.	184
Several Sheets of Paper are Fed at a Time.	184
No Paper Feeds.	184
Original Does Not Feed in the ADF.	184

Contents

Power and Control Panel Problems.	185	Uneven Colors, Dirt, Spots, and so on Appear when Scanning from the Scanner Glass.	199
Power Does Not Turn On.	185	Straight Lines Appear when Scanning from ADF.	199
Power Does Not Turn Off.	185	The Image Quality Is Rough.	199
Power Turns Off Automatically.	185	Offset Appears in the Background of Images.	199
LCD Screen Gets Dark.	186	Text is Blurred.	200
Cannot Print from a Computer.	186	Moiré Patterns (Web-Like Shadows) Appear.	200
When You Cannot Make Network Settings.	186	Cannot Scan the Correct Area on the Scanner Glass.	200
Cannot Connect from Devices Even Though Network Settings are No Problem.	187	Text is Not Recognized Correctly when Saving as a Searchable PDF.	201
Checking the SSID Connected to the Printer.	188	Cannot Solve Problems in the Scanned Image.	201
Checking the SSID for the Computer.	189	Other Scanning Problems.	202
Suddenly the Printer Cannot Print over a Network Connection.	189	Scanning Speed Is Slow.	202
Suddenly the Printer Cannot Print Using a USB Connection.	190	Cannot Send the Scanned Image by Email.	202
Printout Problems.	190	Scanning Stops when Scanning to PDF/Multi-TIFF.	202
Printout is Scuffed or Color is Missing.	190	Problems when Sending and Receiving Faxes.	203
Banding or Unexpected Colors Appear.	191	Cannot Send or Receive Faxes.	203
Colored Banding Appears at Intervals of Approximately 2.5 cm.	191	Cannot Send Faxes.	204
Blurry Prints, Vertical Banding, or Misalignment.	191	Cannot Send Faxes to a Specific Recipient.	204
Print Quality is Poor.	192	Cannot Send Faxes at a Specified Time.	205
Printed Photos are Sticky.	193	Cannot Receive Faxes.	205
Images or Photos are Printed in Unexpected Colors.	193	Memory Full Error Occurs.	205
The Position, Size, or Margins of the Printout Are Incorrect.	193	Sent Fax Quality Is Poor.	206
Paper Is Smearred or Scuffed.	194	Faxes are Sent at the Wrong Size.	206
Paper is Smearred During Automatic 2-Sided Printing.	195	Received Fax Quality Is Poor.	207
Printed Characters Are Incorrect or Garbled.	195	Cannot Receive A3 Size Faxes.	207
The Printed Image Is Inverted.	195	Received Faxes Are Not Printed.	207
Mosaic-Like Patterns in the Prints.	196	Other Faxing Problems.	207
Uneven Colors, Smears, Dots, or Straight Lines Appear in the Copied Image.	196	Cannot Make Calls on the Connected Telephone.	207
Moiré (Cross-Hatch) Patterns Appear in the Copied Image.	196	Answering Machine Cannot Answer Voice Calls.	208
An Image of the Reverse Side of the Original Appears in the Copied Image.	196	Sender's Fax Number Not Displayed on Received Faxes or the Number Is Wrong.	208
The Printout Problem Could Not be Cleared.	197	Other Problems.	208
Other Printing Problems.	197	Slight Electric Shock when Touching the Printer.	208
Printing Is Too Slow.	197	Operation Sounds Are Loud.	208
Printing Slows Down Dramatically During Continuous Printing.	197	Rear Paper Feed Slot is Removed.	209
Cannot Start Scanning.	198	The Date and Time Are Incorrect.	209
Cannot Start Scanning when Using the Control Panel.	198	Memory Device Is not Recognized.	209
Scanned Image Problems.	199	Cannot Save Data to a Memory Device.	209
		Forgot Your Password.	210
		Application Is Blocked by a Firewall (for Windows Only).	210
		"?" Is Displayed on the Photo Selection Screen.	210
		A Message Prompting You to Reset the Ink Levels is Displayed.	210

Appendix

Technical Specifications.	211
Printer Specifications.	211
Scanner Specifications.	211
Interface Specifications.	212
Fax Specifications.	212
Network Function List.	213
Wi-Fi Specifications.	214
Ethernet Specifications.	215
Security Protocol.	215
Supported Third Party Services.	215
External Storage Device Specifications.	215
Dimensions.	217
Electrical Specifications.	217
Environmental Specifications.	218
System Requirements.	218
Regulatory Information.	219
Standards and Approvals.	219
Restrictions on Copying.	219
Transporting the Printer.	220
Accessing the External Storage Device From a Computer.	224
Using an Email Server.	225
Configuring an Email Server.	225
Email Server Setting Items.	226
Checking an Email Server Connection.	227
Where to Get Help.	227
Technical Support Web Site.	227
Contacting Epson Support.	227

About This Manual

Introduction to the Manuals

The following manuals are supplied with your Epson printer. As well as the manuals, check the various types of help information available from the printer itself or from the Epson software applications.

- ❑ Important Safety Instructions (paper manual)
Provides you with instructions to ensure the safe use of this printer.
- ❑ Start Here (paper manual)
Provides you with information on setting up the printer and installing the software.
- ❑ User's Guide (digital manual)
This manual. Provides overall information and instructions on using the printer, on network settings when using the printer on a network, and on solving problems.
- ❑ Administrator's Guide (digital manual)
Provides network administrators with information on management and printer settings.

You can obtain the latest versions of the above manuals with the following methods.

- ❑ Paper manual
Visit the Epson Europe support website at <http://www.epson.eu/Support>, or the Epson worldwide support website at <http://support.epson.net/>.
- ❑ Digital manual
Start EPSON Software Updater on your computer. EPSON Software Updater checks for available updates of Epson software applications and the digital manuals, and allows you to download the latest ones.

Related Information

➔ [“EPSON Software Updater” on page 163](#)

Marks and Symbols

**Caution:**

Instructions that must be followed carefully to avoid bodily injury.

**Important:**

Instructions that must be observed to avoid damage to your equipment.

Note:

Provides complementary and reference information.

➔ Related Information

Links to related sections.

Descriptions Used in this Manual

- ❑ Screenshots of the printer driver and the Epson Scan 2 (scanner driver) screens are from Windows 10 or Mac OS X v10.11.x. The content displayed on the screens varies depending on the model and situation.
- ❑ Illustrations of the printer used in this manual are examples only. Although there may be slight differences depending on the model, the method of operation is the same.
- ❑ Some of the menu items on the LCD screen vary depending on the model and settings.

Operating System References

Windows

In this manual, terms such as "Windows 10", "Windows 8.1", "Windows 8", "Windows 7", "Windows Vista", "Windows XP", "Windows Server 2012 R2", "Windows Server 2012", "Windows Server 2008 R2", "Windows Server 2008", "Windows Server 2003 R2", and "Windows Server 2003" refer to the following operating systems. Additionally, "Windows" is used to refer to all versions.

- ❑ Microsoft® Windows® 10 operating system
- ❑ Microsoft® Windows® 8.1 operating system
- ❑ Microsoft® Windows® 8 operating system
- ❑ Microsoft® Windows® 7 operating system
- ❑ Microsoft® Windows Vista® operating system
- ❑ Microsoft® Windows® XP operating system
- ❑ Microsoft® Windows® XP Professional x64 Edition operating system
- ❑ Microsoft® Windows Server® 2012 R2 operating system
- ❑ Microsoft® Windows Server® 2012 operating system
- ❑ Microsoft® Windows Server® 2008 R2 operating system
- ❑ Microsoft® Windows Server® 2008 operating system
- ❑ Microsoft® Windows Server® 2003 R2 operating system
- ❑ Microsoft® Windows Server® 2003 operating system

Mac OS X

In this manual, "Mac OS X v10.11.x" refers to OS X El Capitan, "Mac OS X v10.10.x" refers to OS X Yosemite, "Mac OS X v10.9.x" refers to OS X Mavericks, and "Mac OS X v10.8.x" refers to OS X Mountain Lion. Additionally, "Mac OS X" is used to refer to "Mac OS X v10.11.x", "Mac OS X v10.10.x", "Mac OS X v10.9.x", "Mac OS X v10.8.x", "Mac OS X v10.7.x", and "Mac OS X v10.6.8".

Important Instructions

Safety Instructions

Read and follow these instructions to ensure safe use of this printer. Make sure you keep this manual for future reference. Also, be sure to follow all warnings and instructions marked on the printer.

- Some of the symbols used on your printer are to ensure safety and proper use of the printer. Visit the following Web site to learn the meaning of the symbols.
<http://support.epson.net/symbols>
- Use only the power cord supplied with the printer and do not use the cord with any other equipment. Use of other cords with this printer or the use of the supplied power cord with other equipment may result in fire or electric shock.
- Be sure your AC power cord meets the relevant local safety standard.
- Never disassemble, modify, or attempt to repair the power cord, plug, printer unit, scanner unit, or options by yourself, except as specifically explained in the printer's manuals.
- Unplug the printer and refer servicing to qualified service personnel under the following conditions:
The power cord or plug is damaged; liquid has entered the printer; the printer has been dropped or the casing damaged; the printer does not operate normally or exhibits a distinct change in performance. Do not adjust controls that are not covered by the operating instructions.
- Place the printer near a wall outlet where the plug can be easily unplugged.
- Do not place or store the printer outdoors, near excessive dirt or dust, water, heat sources, or in locations subject to shocks, vibrations, high temperature or humidity.
- Take care not to spill liquid on the printer and not to handle the printer with wet hands.
- Keep the printer at least 22 cm away from cardiac pacemakers. Radio waves from this printer may adversely affect the operation of cardiac pacemakers.
- If the LCD screen is damaged, contact your dealer. If the liquid crystal solution gets on your hands, wash them thoroughly with soap and water. If the liquid crystal solution gets into your eyes, flush them immediately with water. If discomfort or vision problems remain after a thorough flushing, see a doctor immediately.
- Avoid using a telephone during an electrical storm. There may be a remote risk of electric shock from lightning.
- Do not use a telephone to report a gas leak in the vicinity of the leak.

Important Instructions

- ❑ The printer is heavy and should not be lifted or carried by less than two people. When lifting the printer, two or more people should assume the correct positions as shown below.



Safety Instructions for Ink

- ❑ Be careful not to touch any ink when you handle the ink tanks, ink tank caps, and opened ink bottles or ink bottle caps.
 - ❑ If ink gets on your skin, wash the area thoroughly with soap and water.
 - ❑ If ink gets into your eyes, flush them immediately with water. If discomfort or vision problems continue after a thorough flushing, see a doctor immediately.
 - ❑ If ink gets into your mouth, see a doctor right away.
- ❑ Do not disassemble the maintenance box; otherwise ink may get into your eyes or on your skin.
- ❑ Do not tilt or shake an ink bottle after removing its seal; this can cause leakage.
- ❑ Keep ink bottles, the ink tank unit, and maintenance box out of the reach of children. Do not allow children to drink from or handle the ink bottles and ink bottle cap.

Printer Advisories and Warnings

Read and follow these instructions to avoid damaging the printer or your property. Make sure you keep this manual for future reference.



Advisories and Warnings for Setting Up the Printer

- ❑ Do not block or cover the vents and openings in the printer.
- ❑ Use only the type of power source indicated on the printer's label.
- ❑ Avoid using outlets on the same circuit as photocopiers or air control systems that regularly switch on and off.
- ❑ Avoid electrical outlets controlled by wall switches or automatic timers.

Important Instructions

- ❑ Keep the entire computer system away from potential sources of electromagnetic interference, such as loudspeakers or the base units of cordless telephones.
- ❑ The power-supply cords should be placed to avoid abrasions, cuts, fraying, crimping, and kinking. Do not place objects on top of the power-supply cords and do not allow the power-supply cords to be stepped on or run over. Be particularly careful to keep all the power-supply cords straight at the ends and the points where they enter and leave the transformer.
- ❑ If you use an extension cord with the printer, make sure that the total ampere rating of the devices plugged into the extension cord does not exceed the cord's ampere rating. Also, make sure that the total ampere rating of all devices plugged into the wall outlet does not exceed the wall outlet's ampere rating.
- ❑ If you plan to use the printer in Germany, the building installation must be protected by a 10 or 16 amp circuit breaker to provide adequate short-circuit protection and over-current protection for the printer.
- ❑ When connecting the printer to a computer or other device with a cable, ensure the correct orientation of the connectors. Each connector has only one correct orientation. Inserting a connector in the wrong orientation may damage both devices connected by the cable.
- ❑ Place the printer on a flat, stable surface that extends beyond the base of the printer in all directions. The printer will not operate properly if it is tilted at an angle.
- ❑ Allow space above the printer so that you can fully raise the document cover.
- ❑ Leave enough space in front of the printer for the paper to be fully ejected.
- ❑ Avoid places subject to rapid changes in temperature and humidity. Also, keep the printer away from direct sunlight, strong light, or heat sources.

Advisories and Warnings for Using the Printer

- ❑ Do not insert objects through the slots in the printer.
- ❑ Do not put your hand inside the printer during printing.
- ❑ Do not touch the white flat cable and ink tubes inside the printer.
- ❑ Do not use aerosol products that contain flammable gases inside or around the printer. Doing so may cause fire.
- ❑ Do not move the print head by hand; otherwise, you may damage the printer.
- ❑ Be careful not to trap your fingers when closing the scanner unit.
- ❑ Do not press too hard on the scanner glass when placing the originals.
- ❑ Visually check ink levels in the actual ink tanks. Continued use of the printer when the ink is expended could damage the printer. Epson recommends filling the ink tank to the upper line when the printer is not operating to reset the ink level.
- ❑ Always turn the printer off using the  button. Do not unplug the printer or turn off the power at the outlet until the  light stops flashing.
- ❑ If you are not going to use the printer for a long period, be sure to unplug the power cord from the electrical outlet.

Advisories and Warnings for Transporting or Storing the Printer

- ❑ When storing or transporting the printer, avoid tilting it, placing it vertically, or turning it upside down; otherwise ink may leak.
- ❑ Before transporting the printer, make sure that the print head is in the home (far right) position.

Important Instructions

Advisories and Warnings for Using the Printer with a Wireless Connection

- ❑ Radio waves from this printer may negatively affect the operation of medical electronic equipment, causing them to malfunction. When using this printer inside medical facilities or near medical equipment, follow directions from the authorized personnel representing the medical facilities, and follow all posted warnings and directions on the medical equipment.
- ❑ Radio waves from this printer may negatively affect the operation of automatically controlled devices such as automatic doors or fire alarms, and could lead to accidents due to malfunction. When using this printer near automatically controlled devices, follow all posted warnings and directions on these devices.

Advisories and Warnings for Using Memory Cards

- ❑ Do not remove a memory card or turn off the printer while the memory card light is flashing.
- ❑ The methods for using memory cards vary according to card type. Be sure to refer to the manual packaged with your memory card for details.
- ❑ Use only memory cards compatible with the printer.

Related Information

➔ [“Supported Memory Card Specifications” on page 215](#)

Advisories and Warnings for Using the Touchscreen

- ❑ The LCD screen may contain a few small bright or dark spots, and because of its features it may have an uneven brightness. These are normal and do not indicate that it is damaged in any way.
- ❑ Only use a dry, soft cloth for cleaning. Do not use liquid or chemical cleaners.
- ❑ The exterior cover of the touchscreen could break if it receives a heavy impact. Contact your dealer if the panel surface chips or cracks, and do not touch or attempt to remove the broken pieces.
- ❑ Press the touchscreen gently with your finger. Do not press force or operate with your nails.
- ❑ Do not use sharp objects such as ball point pens or sharp pencils to perform operations.
- ❑ Condensation inside the touchscreen due to abrupt changes in temperature or humidity may cause performance to deteriorate.

Protecting Your Personal Information

When you give the printer to someone else or dispose of it, erase all the personal information stored in the printer's memory by selecting **Setup > System Administration > Restore Default Settings > Clear All Data and Settings** on the control panel.

Printer Basics

Part Names and Functions

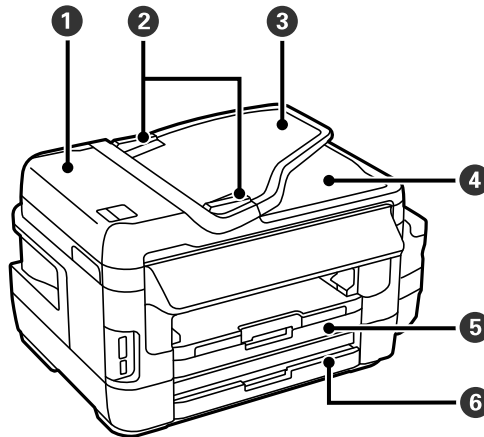

❶	ADF (Automatic Document Feeder) cover	Open when removing jammed originals in the ADF.
❷	ADF edge guide	Feeds originals straight into the printer. Slide to the edges of the originals.
❸	ADF input tray	Feeds originals automatically.
❹	ADF output tray	Holds originals ejected from the ADF.
❺	Paper cassette 1	Loads paper.
❻	Paper cassette 2	

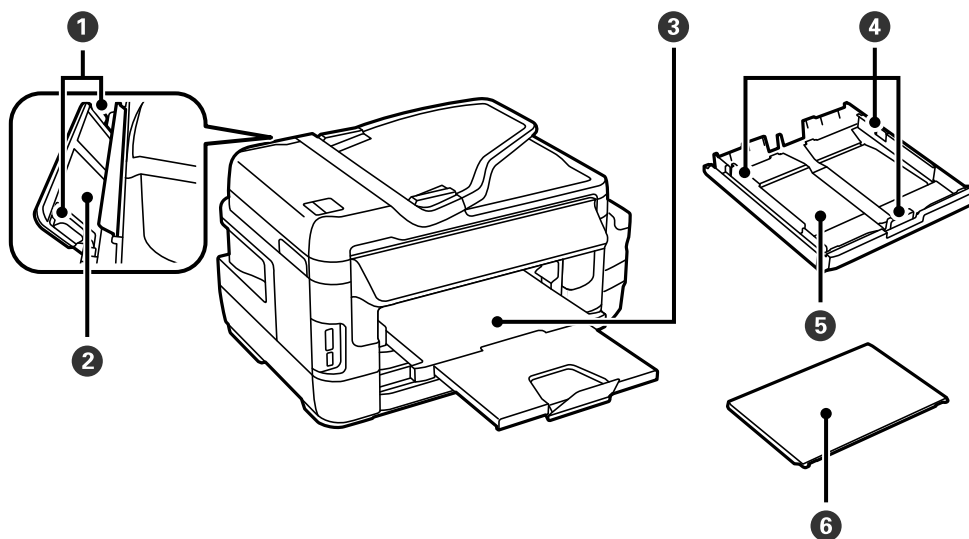

❶	Edge guide	Feeds the paper straight into the printer. Slide to the edges of the paper.
---	------------	---

Printer Basics

②	Rear paper feed slot	Load one sheet of paper at a time by hand.
③	Output tray	Holds the ejected paper.
④	Edge guide	Feeds the paper straight into the printer. Slide to the edges of the paper.
⑤	Paper cassette	Loads paper.
⑥	Paper cassette cover	Prevents foreign substance from entering the paper cassette.

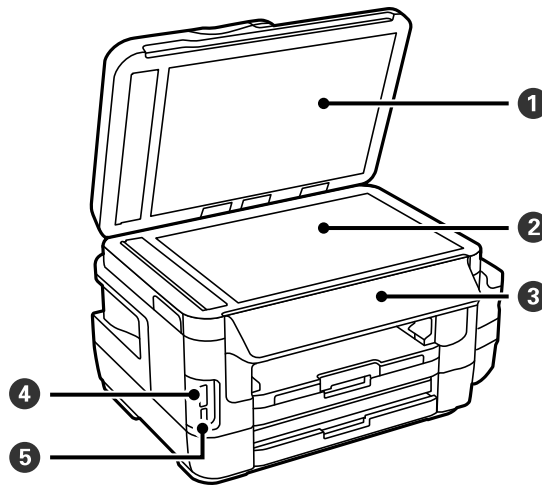

①	Document cover	Blocks external light while scanning.
②	Scanner glass	Place the originals.
③	Control panel	Operates the printer.
④	Memory card slot	Insert a memory card.
⑤	External interface USB port	Connects memory devices.

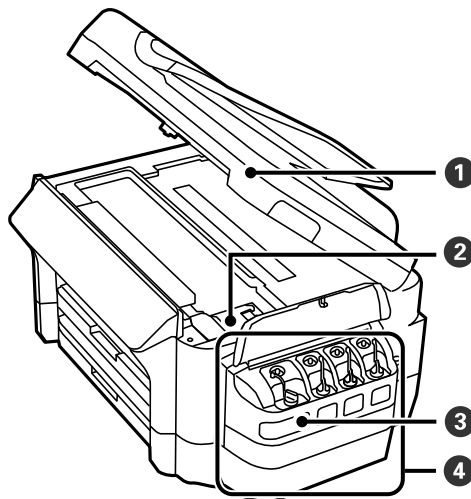

Printer Basics

①	Scanner unit	Scans placed originals. Open when removing jammed paper inside the printer.
②	Print head (under this section)	Fires ink.
③	Ink reservoir tank (Ink tank)	Supplies ink to the print head.
④	Ink tank unit	Contains the ink tanks.

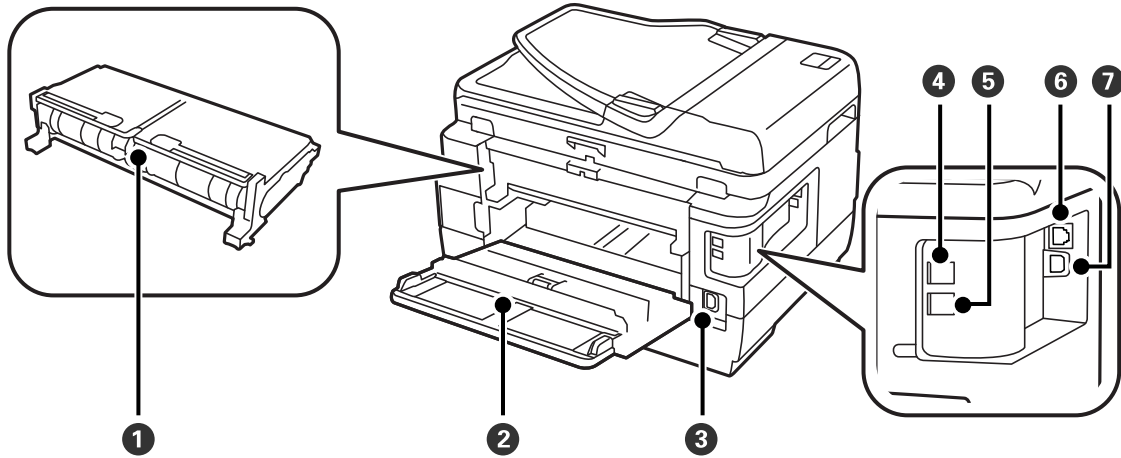

①	Rear cover 2	Remove when removing jammed paper.
②	Rear cover 1	Open when replacing the maintenance box or removing jammed paper.
③	AC inlet	Connects the power cord.
④	LINE port	Connects a phone line.
⑤	EXT. port	Connects external phone devices.
⑥	LAN port	Connects a LAN cable.
⑦	USB port	Connects a USB cable.

Control Panel

Buttons and Lights

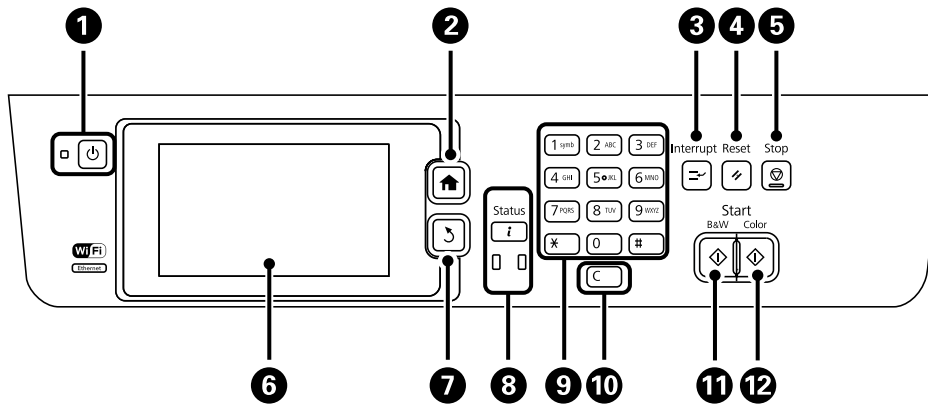

1		Turns the printer on or off. Unplug the power cord when the power light is off.
2		Displays the home screen.
3		Pauses the current job and allows you to interrupt another job. Press this button again to restart a paused job.
4		Resets the current settings to user default settings. If user default settings have not been made, resets to the factory default.
5		Stops the current operation.
6	-	Displays menus and messages. Touch the LCD screen to select a menu, and scroll by swiping.
7		Returns to the previous screen.
8		Displays the Status Menu . You can check the printer's status and job history. The error light on the left flashes or turns on when an error occurs. The data light on the right flashes when the printer is processing data. It turns on when there are queued jobs.
9	0 - 9 *, #	Enters numbers, characters, and symbols.
10	c	Clears number settings such as the number of copies.
11		Starts printing, copying, scanning, and faxing in black and white.
12		Starts printing, copying, scanning, and faxing in color.

Status Menu

Press the *i* button on the control panel.

Printer Information

Printer Basics

Displays the status of the consumables and any errors that have occurred in the printer. Select the error from the list to display the error message.

Job Monitor

Displays a list of ongoing jobs and jobs waiting to be processed. You can also cancel jobs.

Job History

Displays the job history. If a job has failed, an error code is displayed in the history.

Job Storage









Select **Inbox** to display the received faxes stored in the printer's memory.

Related Information







➔ [“Error Code on the Status Menu” on page 169](#)

Icons Displayed on the LCD Screen

The following icons are displayed on the LCD screen depending on the printer's status. Press the network icon to check the current network settings and make Wi-Fi settings.

	<p>Press this icon to view operating instructions such as how to load paper, and how to place originals.</p>
	<p>Turns on when originals are placed in the ADF.</p>
	<p>Turns on when the maintenance box is nearly full. Press the i button, and then select Printer Information to check the status.</p>
	<p>Turns on when the maintenance box is full. Press the i button, and then select Printer Information to check the status.</p>
	<p>Turns on when received documents that have not yet been read, printed, or saved, are stored in the printer's memory.</p>
	<p>Turns on while the printer is receiving or sending faxes.</p>
	<p>Indicates fax memory usage.</p>
	<p>Indicates that the fax memory is full.</p>
	<p>Indicates the number of unprocessed or unread received faxes. This icon is displayed on the fax mode icon. When the number of faxes exceeds 10, the icon changes to 10+. For more details, see the section that describes the display when a received fax has not been processed.</p>

Printer Basics

	Indicates that the printer is connecting to a wireless (Wi-Fi) or wired (Ethernet) network.
	Turns on while the printer is connected to a wired (Ethernet) network.
	Turns on while the printer is connected to a wireless (Wi-Fi) network. The number of bars indicates the signal strength of the connection. The more bars there are, the stronger the connection.
	Indicates a problem with the printer's wireless (Wi-Fi) network connection, or that the printer is searching for a wireless (Wi-Fi) network connection.
	Indicates that the printer is connected to a wireless (Wi-Fi) network in Ad Hoc mode.
	Indicates that the printer is connected to a wireless (Wi-Fi) network in Wi-Fi Direct mode.
	Indicates that the printer is connected to a wireless (Wi-Fi) network in Simple AP mode.

Related Information





- ➔ [“Notification of Unprocessed Received Faxes” on page 122](#)
- ➔ [“Memory Full Error Occurs” on page 205](#)

Icons Displayed on the Software Keyboard of the LCD Screen



You can enter characters and symbols by using the software keyboard screen when you register a contact, make network settings, and so on. The following icons are displayed on the software keyboard screen.

Note:

Available icons vary depending on the setting item.

	Switches between upper case and lower case.
	Switches the character type. 123#: Enters numbers and symbols. ABC: Enters letters. ÁÁÂ: Enters special characters such as umlauts and accents.
	Changes the keyboard layout.
	Enters a space.
	Deletes a character to the left.

Printer Basics

	Enters a character.
	Enters a pause (pauses for three seconds) while dialing. A hyphen (-) is entered as the pause mark.

Presets Mode

You can register frequently used copy, fax, and scan settings as presets. To register a preset, select **Presets** from the home screen, select **Add New**, and then select the feature for which you want to register a contact. Make the necessary settings, press **Save**, and then enter a name for the preset.

To load a registered preset, select the preset from the list.

Press **Preset** on the screen of each feature. You can register the current address (except for address that have been entered directly and the contacts in the LDAP address list) and settings.

Menu

Displays the details of registered presets, and allows you to change their names, edit, and delete.

Network Settings

Network Connection Types

Ethernet Connection

Connect the printer to a hub with an Ethernet cable.

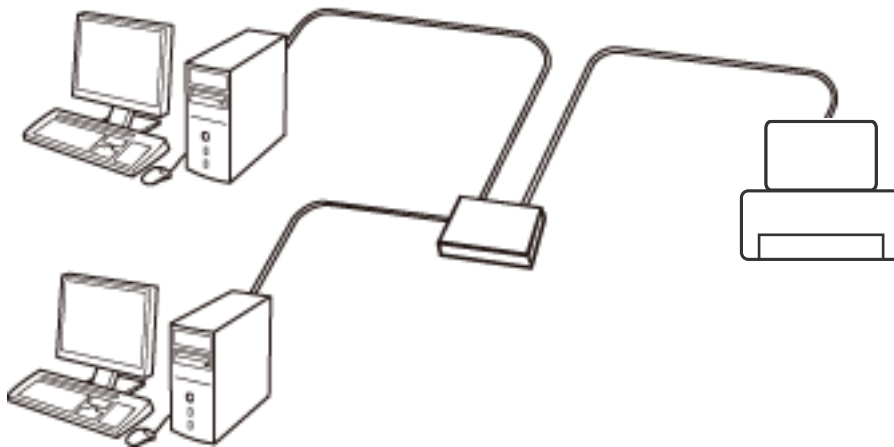

Related Information

➔ [“Setting Items for Advanced Network Settings” on page 30](#)

Wi-Fi Connection

Connect the printer and the computer or smart device to the access point. This is the typical connection method for home or office networks where computers are connected by Wi-Fi through the access point.

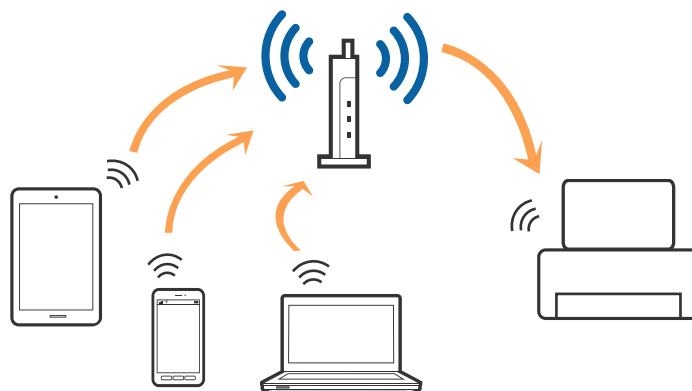

Related Information

- ➔ [“Making Wi-Fi Settings Manually” on page 26](#)
- ➔ [“Making Wi-Fi Settings by Push Button Setup \(WPS\)” on page 27](#)
- ➔ [“Making Wi-Fi Settings by PIN Code Setup \(WPS\)” on page 28](#)

Network Settings

Wi-Fi Direct Connection

Use this connection method when you are not using Wi-Fi at home or at the office, or when you want to connect the printer and the computer or smart device directly.

Simple AP Mode

The printer is connected in Simple AP mode when you set up using **Wi-Fi Direct Setup** if Wi-Fi settings for the printer have not been made. In this mode, the printer acts as an access point and you can connect up to four devices to the printer without having to use a standard access point. However, devices directly connected to the printer cannot communicate with each other through the printer.

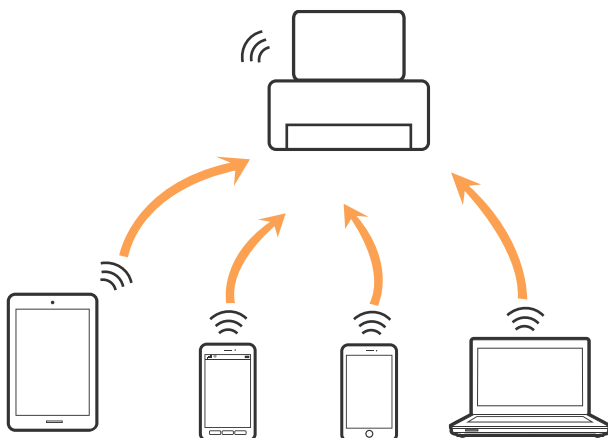

The printer can be connected in Ethernet and Simple AP mode simultaneously.

Related Information

➔ [“Making Wi-Fi Direct Settings When Wi-Fi Is Disabled \(Simple AP Mode\)” on page 29](#)

Wi-Fi Direct Mode

The printer is connected in Wi-Fi Direct mode when you set up using **Wi-Fi Direct Setup** if Wi-Fi settings for the printer have been made. The connection method varies depending on the device that connects to the printer, such as iOS devices, devices that support Wi-Fi Direct, and so on.

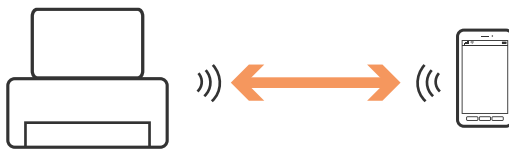

Note:

- Only one device can connect to the printer in Wi-Fi Direct mode.
- Since Wi-Fi Direct mode is a temporary connection method, we recommend connecting by Wi-Fi if you want to use the device continuously.

Related Information

➔ [“Making Wi-Fi Direct Settings When Wi-Fi Is Enabled \(Wi-Fi Direct Mode\)” on page 29](#)

Connecting to a Computer

We recommend using the installer to connect the printer to a computer. You can run the installer using one of the following methods.

Setting up from the website

Access the following website, and then enter the product name.

<http://epson.sn>

Go to **Setup**, and then click **Download** in the download and connect part. Click or double-click the downloaded file to run the installer. Follow the on-screen instructions.

Setting up using the software disc (only for the models that come with a software disc and users with computers with disc drives.)

Insert the software disc into the computer, and then follow the on-screen instructions.

Selecting the Connection Methods

Follow the on-screen instructions until the following screen is displayed, and then select the connection method of the printer to the computer.

Windows

Select the connection type and then click **Next**.

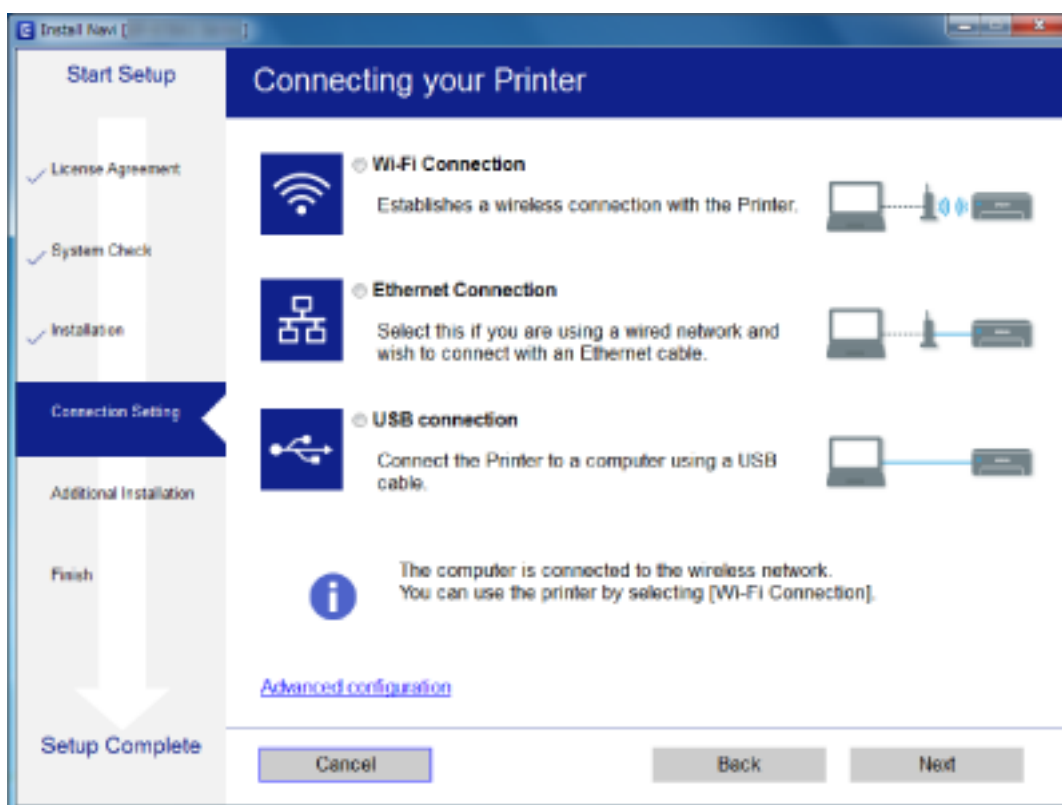

Network Settings

Mac OS X

Select the connection type.



Follow the on-screen instructions. The necessary software is installed.

Connecting to a Smart Device

You can use the printer from a smart device when you connect the printer to the same Wi-Fi network (SSID) as the smart device. To use the printer from a smart device, set up from the following website. Access to the website from the smart device that you want to connect to the printer.

<http://epson.sn> > Setup

Note:

If you want to connect a computer and a smart device to the printer at the same time, we recommend connecting the computer first.

Making Wi-Fi Settings from the Control Panel

You can make network settings from the printer's control panel. After connecting the printer to the network, connect to the printer from the device that you want to use (computer, smart phone, tablet, and so on.)

Related Information

- ➔ “Making Wi-Fi Settings Manually” on page 26
- ➔ “Making Wi-Fi Settings by Push Button Setup (WPS)” on page 27
- ➔ “Making Wi-Fi Settings by PIN Code Setup (WPS)” on page 28

Network Settings

➔ “Making Wi-Fi Direct Settings” on page 28

Making Wi-Fi Settings Manually

You can manually set up the information necessary to connect to an access point from the printer's control panel. To set up manually, you need the SSID and password for an access point.

Note:

If you are using an access point with its default settings, the SSID and password are on the label. If you do not know the SSID and password, contact the person who set up the access point, or see the documentation provided with the access point.

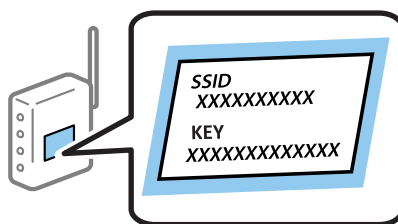

1. Press  on the home screen.
2. Select **Wi-Fi Setup**.
3. Select **Wi-Fi Setup Wizard**.
4. Select the SSID for the access point.

Note:

- If the SSID you want to connect to is not displayed on the printer's control panel, select **Other Networks**, and then enter the SSID directly.
- If you do not know the SSID, check if it is written on the label of the access point. If you are using the access point with its default settings, use the SSID written on the label.

5. Press **Password**, and then enter the password.

Note:

- The password is case-sensitive.
- If you do not know the password, check if it is written on the label of the access point. If you are using the access point with its default settings, use the password written on the label. The password may also be called a "Key", a "Passphrase", and so on.
- If you do not know the password for the access point, see the documentation provided with the access point, or contact the person who set it up.

6. When you have setup finished, press .
7. Check the settings, and then press **Proceed**.
8. Press **OK**.
9. Press **Done** to finish.

Note:

If you fail to connect, load A4 size plain paper, and then press the  button to print a connection report.

Network Settings

Related Information

- ➔ [“Checking the Network Connection Status” on page 31](#)
- ➔ [“When You Cannot Make Network Settings” on page 186](#)

Making Wi-Fi Settings by Push Button Setup (WPS)

You can automatically set up a Wi-Fi network by pressing a button on the access point. If the following conditions are met, you can set up by using this method.

- The access point is compatible with WPS (Wi-Fi Protected Setup).
- The current Wi-Fi connection was established by pressing a button on the access point.

Note:

If you cannot find the button or you are setting up using the software, see the documentation provided with the access point.

1. Press  on the home screen.
2. Select **Wi-Fi Setup**.
3. Select **Push Button Setup (WPS)**.
4. Hold down the [WPS] button on the access point until the security light flashes.



If you do not know where the [WPS] button is, or there are no buttons on the access point, see the documentation provided with your access point for details.

5. Press **Proceed**.
6. When a completion message is displayed, press **OK**.
The screen automatically closes after a specific length of time if you do not press **OK**.

Note:

If connection fails, restart the access point, move it closer to the printer, and try again. If it still does not work, print a network connection report and check the solution.

7. Press **OK**.

Related Information

- ➔ [“Checking the Network Connection Status” on page 31](#)

Network Settings

➔ [“When You Cannot Make Network Settings” on page 186](#)

Making Wi-Fi Settings by PIN Code Setup (WPS)

You can automatically connect to an access point by using a PIN code. You can use this method to set up if an access point is capable of WPS (Wi-Fi Protected Setup). Use a computer to enter a PIN code into the access point.

1. Press  on the home screen.
2. Select **Wi-Fi Setup**.
3. Select **PIN Code Setup (WPS)**.
4. Use your computer to enter the PIN code (an eight digit number) displayed on the printer's control panel into the access point within two minutes.

Note:

See the documentation provided with your access point for details on entering a PIN code.

5. Press **Proceed**.
6. When a completion message is displayed, press **OK**.
The screen automatically closes after a specific length of time if you do not press **OK**.

Note:

If connection fails, restart the access point, move it closer to the printer, and try again. If it still does not work, print a connection report and check the solution.

7. Press **OK**.

Related Information

- ➔ [“Checking the Network Connection Status” on page 31](#)
- ➔ [“When You Cannot Make Network Settings” on page 186](#)

Making Wi-Fi Direct Settings

This method allows you to connect the printer directly to devices without an access point. The printer acts as an access point. The connection mode varies depending on whether or not Wi-Fi settings have been made.

 **Important:**

When you connect from the computer or smart device to the printer using the Wi-Fi Direct connection, the printer is connected to the same Wi-Fi network (SSID) as the computer or smart device and the communication is established between them. Since the computer or smart device is automatically connected to the other connectable Wi-Fi network if the printer is turned off, it is not connected to the previous Wi-Fi network again if the printer is turned on. Connect to the printer's SSID for Wi-Fi Direct connection from the computer or smart device again. If you do not want to connect every time you turn the printer on or off, we recommend to use Wi-Fi network by connecting the printer to an access point.

Related Information

- ➔ [“Making Wi-Fi Direct Settings When Wi-Fi Is Disabled \(Simple AP Mode\)” on page 29](#)

Network Settings

➔ [“Making Wi-Fi Direct Settings When Wi-Fi Is Enabled \(Wi-Fi Direct Mode\)” on page 29](#)

Making Wi-Fi Direct Settings When Wi-Fi Is Disabled (Simple AP Mode)

Note:

In this mode, the printer can be connected by Ethernet at the same time. Also, you can connect up to four devices to the printer.

1. Press  on the home screen.
2. Select **Wi-Fi Setup**.
3. Select **Wi-Fi Direct Setup**.
4. Select **Connection Setup**.
5. Select **Proceed**.

If you want to change the password, select **Change Password** and follow the on-screen instruction.

6. Scroll the screen and check the SSID and password. On the computer's network connection screen or the smart device's Wi-Fi screen, select the SSID shown on the printer's control panel to connect.
7. Enter the password displayed on the printer's control panel.
8. After the connection is established, press **Done** on the printer's control panel.

Related Information

- ➔ [“Checking the Network Connection Status” on page 31](#)
- ➔ [“When You Cannot Make Network Settings” on page 186](#)

Making Wi-Fi Direct Settings When Wi-Fi Is Enabled (Wi-Fi Direct Mode)



Important:

Since the printer is disconnected from the Wi-Fi network when it is connected in Wi-Fi Direct mode, you cannot use the printer over the Wi-Fi network. If you disconnect the connection in Wi-Fi Direct mode, the printer is re-connected to the previous Wi-Fi network.

The connection method for Wi-Fi Direct mode is much the same as Simple AP mode. Select  > **Wi-Fi Setup** > **Wi-Fi Direct Setup** > **Connection Setup** on the printer's control panel, press **Proceed**, and then start connecting from the device. The message is displayed on the printer's control panel and the network icon on the home screen changes to the Wi-Fi Direct mode icon when the printer is connected.

Note:

*You can connect in Wi-Fi Direct mode from Android devices only. Before connecting, start Web Config, and then select **Basic Settings** > **Wi-Fi Direct Setup** > **Connect to the Wi-Fi Direct devices only** to set up the printer. The method for starting connection from the printer is the same as for Wi-Fi Direct mode.*

If you connect in Wi-Fi Direct mode from specific smart devices, you can only connect using Wi-Fi Direct mode when connecting to the printer from the smart device, and you do not need to enter the SSID and password because the printer and the devices communicate each other directly to connect.

Related Information

- ➔ [“Checking the Network Connection Status” on page 31](#)
- ➔ [“When You Cannot Make Network Settings” on page 186](#)

Making Advanced Network Settings from the Control Panel

You can change the network printer name, TCP/IP setup, DNS server and so on. Check your network environment before making changes.

1. Press  on the home screen.
2. Select **Menu**.
3. Select **Wi-Fi/Network Settings**.
4. Select **Advanced Setup**.
5. Select the menu item for settings, and then select or specify the setting values.

Setting Items for Advanced Network Settings

Select the menu item for settings, and then select or specify the setting values.

Printer Name

Enter the printer name. You can enter the following characters.

- Character limits: 2 to 15 (you must enter at least 2 characters)
- Usable characters: A to Z, a to z, 0 to 9, -.
- Characters you cannot use at the top: 0 to 9.
- Characters you cannot use at the bottom: -

Note:

If you press  button without entering the printer name, the default printer name (EPSON and the last six digits of the printer's MAC address) are set.

TCP/IP Address Auto

Select when you are using an access point at home or you are allowing the IP address to be acquired automatically by DHCP.

 Manual

Select when you do not want the printer's IP address to be changed. Enter the **IP Address**, **Subnet Mask**, and **Default Gateway**, according to your network environment.

Network Settings

- DNS Server
 - Auto
Select when you want to acquire the IP address automatically.
 - Manual
Select when you want to set a unique DNS server address to the printer. Enter the addresses for the **Primary DNS Server** and the **Secondary DNS Server**.
- Proxy Server
 - Use
Select when you are using a proxy server in your network environment and you want to set it to the printer. Enter the proxy server address and port number.
 - Do Not Use
Select when you are using the printer in a home network environment.
- Email Server
 - Server Settings
You can select the server from Off, POP before SMTP, or SMTP-AUTH.
 - Connection Check
You can check the connection for e-mail server. See *Administrator's Guide* if an error occurs when performing **Connection Check**.
- IPv6 Address
 - Enable
Select this when using an IPv6 address.
 - Disable
Select this when using an IPv4 address.
- Wi-Fi Direct
 - Enable
Allow computers or smart devices to connect using Wi-Fi Direct.
 - Disable
Reject computers or smart devices that are trying to connect using Wi-Fi Direct. If **Disable** is selected, no computers or smart devices can connect to the printer directly.
- MS Network Sharing
 - Enable
Use MS Network service.
 - Disable
Prohibit file sharing using the MS Network service. You cannot share files by network scanning.

Checking the Network Connection Status

Checking the Network Status Using Network Icon

You can check the network connection status using the network icon on the printer's home screen. The icon changes depending on the connection type and strength of the radio wave.

Network Settings

Related Information

➔ [“Icons Displayed on the LCD Screen” on page 19](#)

Checking the Network Status from the Control Panel



When your printer is connected to the network, you can also view other network-related information by pressing the network menus you want to check.

1. Enter **Setup** from the home screen.
2. Select **Network Status**.
3. To check the information, select the menus that you want to check.
 - Wi-Fi/Network Status**
Displays the network information (Printer Name, Obtain IP Address, Default Gateway, DNS Server Setup Mode and so on) for Ethernet or Wi-Fi connections.
 - Wi-Fi Direct Status**
Displays the network information (Printer Name, Connection, Obtain IP Address, Default Gateway and so on) for Wi-Fi Direct connections.
 - Email Server Status**
 - Epson Connect Status**
Displays the registered information for Epson Connect services.
 - Google Cloud Print Status**
Displays the registered information for services and the connection status.
4. Press **OK** to return to the menu screen or **Print** to print a network status sheet.

When you press **Print**, make sure that A4 plain paper is loaded in the printer, and then press the  button to print.

Printing a Network Connection Report

You can print a network connection report to check the status between the printer and the access point.

1. Load A4-size plain paper in the printer.
2. Press  on the home screen.
3. Select **Menu**.
4. Select **Wi-Fi/Network Settings > Connection Check**.
5. Press  button to print the network connection report.
If an error has occurred, check the network connection report and then follow the printed solutions.

Related Information

➔ [“Messages and Solutions on the Network Connection Report” on page 33](#)

Network Settings

Messages and Solutions on the Network Connection Report

Check the messages and error codes on the network connection report, and then follow the solutions.

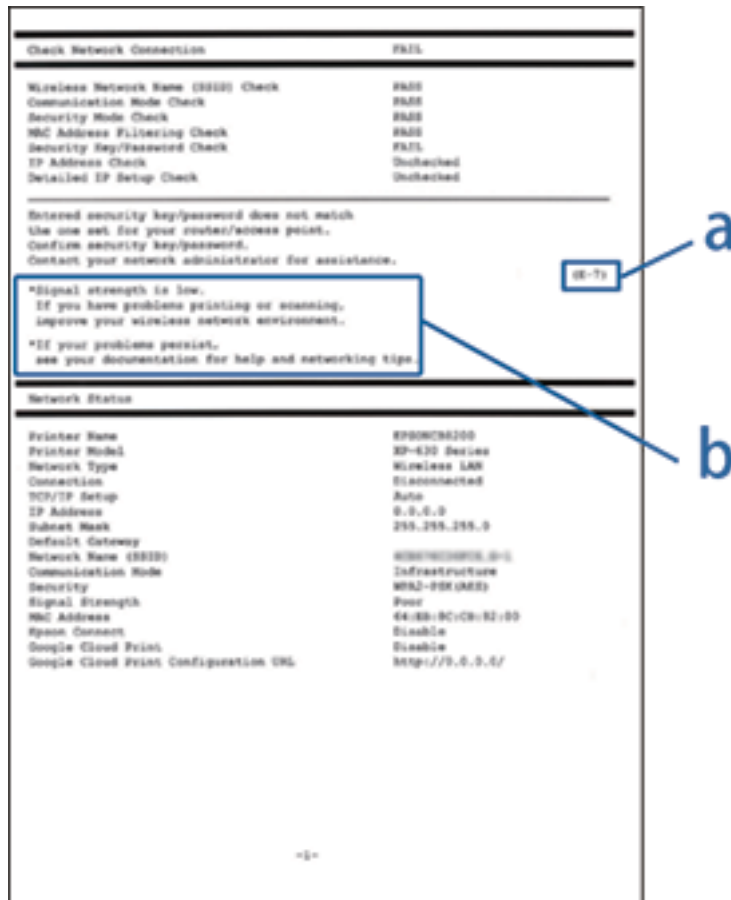

- a. Error code
- b. Messages on the Network Environment

a. Error code

Code	Message	Solution
E-1	Confirm that the network cable is connected and network devices such as hub, router, or access point are turned on.	<ul style="list-style-type: none"> <input type="checkbox"/> Make sure that the Ethernet cable is connected to the printer, a hub, or other network devices. <input type="checkbox"/> Make sure that the hub or other network devices are turned on.

Network Settings

Code	Message	Solution
E-2	No wireless network names (SSID) found. Confirm that the router/access point is turned on and the wireless network (SSID) is set up correctly. Contact your network administrator for assistance.	<ul style="list-style-type: none"> <input type="checkbox"/> Make sure that the access point is turned on. <input type="checkbox"/> Check that the computer or other devices are connected correctly to the access point. <input type="checkbox"/> Place the printer close to the access point. Remove any obstacles between them. <input type="checkbox"/> If you have entered the SSID manually, check if it is correct. You can check the SSID from Network Status on the network connection report. <input type="checkbox"/> To establish a network using Push Button Setup (WPS), check that the access point supports WPS. If it does not support WPS, you cannot establish a network using Push Button Setup (WPS). <input type="checkbox"/> If you want to connect the printer and a computer in Ad Hoc mode, set up your computer in Ad Hoc mode and start a connection, and then make the printer's network settings. <input type="checkbox"/> Check that only ASCII characters (alphanumeric characters and symbols) are used for the SSID. The printer cannot display an SSID which contains any characters other than ASCII characters.
E-3	No wireless network names (SSID) found. Confirm that the wireless network name (SSID) of the PC you wish to connect is set up correctly. Contact your network administrator for assistance.	<ul style="list-style-type: none"> <input type="checkbox"/> To establish a connection in Ad Hoc mode, make sure the computer is turned on. If it is turned off, turn it on and then make the printer's network settings. <input type="checkbox"/> Place the computer close to the printer.
E-4	Wi-Fi communication mode (IEEE802.11b/g/n) does not match the current setting of the printer. Set the same communication mode to the printer, router/access point, and PC. Contact your network administrator for assistance.	Make sure the Wi-Fi standard set on the access point matches the printer's Wi-Fi standard. If the standard does not match, adjust the Wi-Fi standard on the access point. See the documentation provided with the access point for details.
E-5	Security mode (e.g. WEP, WPA) does not match the current setting of the printer. Confirm security mode. Contact your network administrator for assistance.	<p>Make sure the access point's security type is set to one of the following. If it is not, change the security type on the access point, and then reset the printer's network settings.</p> <ul style="list-style-type: none"> <input type="checkbox"/> WEP-64 bit (40 bit) <input type="checkbox"/> WEP-128 bit (104 bit) <input type="checkbox"/> WPA PSK (TKIP/AES)* <input type="checkbox"/> WPA2 PSK (TKIP/AES)* <input type="checkbox"/> WPA (TKIP/AES) <input type="checkbox"/> WPA2 (TKIP/AES) <p>* : WPA PSK is also known as WPA Personal. WPA2 PSK is also known as WPA2 Personal.</p>

Network Settings

Code	Message	Solution
E-6	MAC address of your printer may be filtered. Check whether your router/access point has restrictions such as MAC address filtering. See the documentation of the router/access point or contact your network administrator for assistance.	<ul style="list-style-type: none"> <input type="checkbox"/> Check if the MAC address is disabled. If it is enabled, register the printer's MAC address so that it is not filtered. See the documentation provided with the access point for details. You can check the printer's MAC address from the network status screen on the printer's control panel or by printing a network status sheet. <input type="checkbox"/> If the access point's shared authentication is enabled on the WEP security method, make sure the authentication key and index are correct.
E-7	Entered security key/password does not match the one set for your router/access point. Confirm security key/password. Contact your network administrator for assistance.	<ul style="list-style-type: none"> <input type="checkbox"/> The password set on the access point and the entered password do not match. The password is case sensitive. Enter the correct password. <input type="checkbox"/> If the Wi-Fi connection is suddenly disconnected, check the following. If any of these are applicable, reset the network settings using the software disc supplied or using the software downloaded from the website. http://epson.sn <ul style="list-style-type: none"> <input type="checkbox"/> Another smart device was added to the network using Push Button Setup (WPS). <input type="checkbox"/> The Wi-Fi network was set up using any method other than Push Button Setup (WPS) from the software disc supplied.
E-8	Incorrect IP address is assigned to the printer. Confirm IP address setup of the network device (hub, router, or access point). Contact your network administrator for assistance.	<ul style="list-style-type: none"> <input type="checkbox"/> Enable DHCP on the access point when the printer's Obtain IP Address is set to Auto. <input type="checkbox"/> If the printer's Obtain IP Address is set to Manual, the IP address you manually set is out of range (for example: 0.0.0.0) and it is disabled. Set a valid IP address.
E-9	Confirm the connection and network setup of the PC or other device. Connection using the EpsonNet Setup is available. Contact your network administrator for assistance.	<p>Check the following.</p> <ul style="list-style-type: none"> <input type="checkbox"/> Devices are turned on. <input type="checkbox"/> You can access the Internet and other computers or network devices on the same network from the devices you want to connect to the printer. <p>If it still does not work after checking the above, reset the network settings using the software disc supplied or using the software downloaded from the website.</p> <p>http://epson.sn</p>
E-10	Confirm IP address, subnet mask, and default gateway setup. Connection using the EpsonNet Setup is available. Contact your network administrator for assistance.	<p>Check the following.</p> <ul style="list-style-type: none"> <input type="checkbox"/> Other devices on the network are turned on. <input type="checkbox"/> Network addresses (IP address, subnet mask, and default gateway) are correct if you have set the printer's Obtain IP Address to Manual. <p>Reset the network address if these are incorrect. You can check the IP address, subnet mask, and default gateway from the network status screen on the printer's control panel or by printing a network status sheet.</p> <p>When DHCP is enabled, change the printer's Obtain IP Address to Auto. If you want to set the IP address manually, check the access point's IP address, and then select Manual on the printer's control panel. Set the subnet mask to [255.255.255.0].</p>

Network Settings

Code	Message	Solution
E-11	Setup is incomplete. Confirm default gateway setup. Connection using the EpsonNet Setup is available. Contact your network administrator for assistance.	<p>Check the following.</p> <ul style="list-style-type: none"> <input type="checkbox"/> The default gateway address is correct when you set the printer's TCP/IP Setup to Manual. <input type="checkbox"/> The device that is set as the default gateway is turned on. <p>Set the correct default gateway address. You can check the default gateway address from the network status screen on the printer's control panel or by printing a network status sheet.</p>
E-12	<p>Confirm the following:</p> <ul style="list-style-type: none"> <input type="checkbox"/> Entered security key/password is correct <input type="checkbox"/> Index of the security key/password is set to the first number <input type="checkbox"/> IP address, subnet mask, or default gateway setup is correct <p>Contact your network administrator for assistance.</p>	<p>Check the following.</p> <ul style="list-style-type: none"> <input type="checkbox"/> Other devices on the network are turned on. <input type="checkbox"/> The network addresses (IP address, subnet mask, and default gateway) are correct if you are entering them manually. <input type="checkbox"/> The network addresses for other devices (subnet mask and default gateway) are the same. <input type="checkbox"/> The IP address does not conflict with other devices. <p>If it still does not work after checking the above, try the following.</p> <ul style="list-style-type: none"> <input type="checkbox"/> Make network settings on the computer that is on the same network as the printer using the software disc supplied or using the software downloaded from the website. http://epson.sn <input type="checkbox"/> You can register several passwords on an access point that uses the WEP security type. If several passwords are registered, check if the first registered password is set on the printer.
E-13	<p>Confirm the following:</p> <ul style="list-style-type: none"> <input type="checkbox"/> Entered security key/password is correct <input type="checkbox"/> Index of the security key/password is set to the first number <input type="checkbox"/> Connection and network setup of the PC or other device is correct <p>Contact your network administrator for assistance.</p>	<p>Check the following.</p> <ul style="list-style-type: none"> <input type="checkbox"/> Network devices such as an access point, hub, and router are turned on. <input type="checkbox"/> The TCP/IP Setup for network devices has not been set up manually. (If the printer's TCP/IP Setup is set automatically while the TCP/IP Setup for other network devices is performed manually, the printer's network may differ from the network for other devices.) <p>If it still does not work after checking the above, try the following.</p> <ul style="list-style-type: none"> <input type="checkbox"/> Make network settings on the computer that is on the same network as the printer using the software disc supplied or using the software downloaded from the website. http://epson.sn <input type="checkbox"/> You can register several passwords on an access point that uses the WEP security type. If several passwords are registered, check if the first registered password is set on the printer.

b. Messages on the Network Environment

Message	Solution
*Multiple network names (SSID) that match your entered network name (SSID) have been detected. Confirm network name (SSID).	The same SSID may be set on several access points. Check the settings on the access points, and change the SSID.

Network Settings

Message	Solution
*Signal strength is low. If you have problems printing or scanning, improve your wireless network environment.	The printing speed may be slow or printing may stop due to medium signal strength. Placing the printer close to the access point, or removing any obstacles between the access point and the printer may improve the environment.
*A router/access point channel conflict has been detected. If you have problems printing or scanning, improve your wireless network environment.	Signal interference can be caused by other wireless networks being used in nearby rooms or buildings. Placing the printer close to the access point, or changing the access point channel setting may improve the environment. See the documentation provided with the access point for details.
*Signal strength is low. A router/access point channel conflict has been detected. If you have problems printing or scanning, improve your wireless network environment.	The printing speed may be slow or printing may stop due to low signal strength. Signal interference can be caused by other wireless networks being used in nearby rooms or buildings. Placing the printer close to the access point, or changing the access point channel setting may improve the environment. See the documentation provided with the access point for details.
*No more devices can be connected. Disconnect one of the connected devices if you want to add another one.	You can simultaneously connect up to four computers and smart devices in Simple AP mode. To add another computer or smart device, disconnect one of the connected devices first.

Related Information

- ➔ [“Connecting to a Computer” on page 24](#)
- ➔ [“When You Cannot Make Network Settings” on page 186](#)

Printing a Network Status Sheet

You can check the detailed network information by printing it.

1. Load A4-size plain paper in the printer.
2. Enter **Setup** from the home screen.
3. Select **Network Status > Wi-Fi/Network Status**.
4. Press **Print**.
5. Press the  button.

Replacing or Adding New Access Points

If the SSID changes due to the replacement of an access point, or an access point is added and a new network environment is established, re-set the Wi-Fi settings.

Related Information

- ➔ [“Changing the Connection Method to a Computer” on page 38](#)

Changing the Connection Method to a Computer

Using the installer and re-set up in a different connection method.

- ❑ Setting up from the website

Access the following website, and then enter the product name.

<http://epson.sn>

Go to **Setup**, and then click **Download** in the download and connect part. Click or double-click the downloaded file to run the installer. Follow the on-screen instructions.

- ❑ Setting up using the software disc (only for the models that come with a software disc and users with computers with disc drives.)

Insert the software disc into the computer, and then follow the on-screen instructions.

Selecting Change the Connection Methods

Follow the on-screen instructions until the following screen is displayed.

- ❑ Windows

Select **Change or re-set the connection method** on the Select Software Installation screen, and then click **Next**.

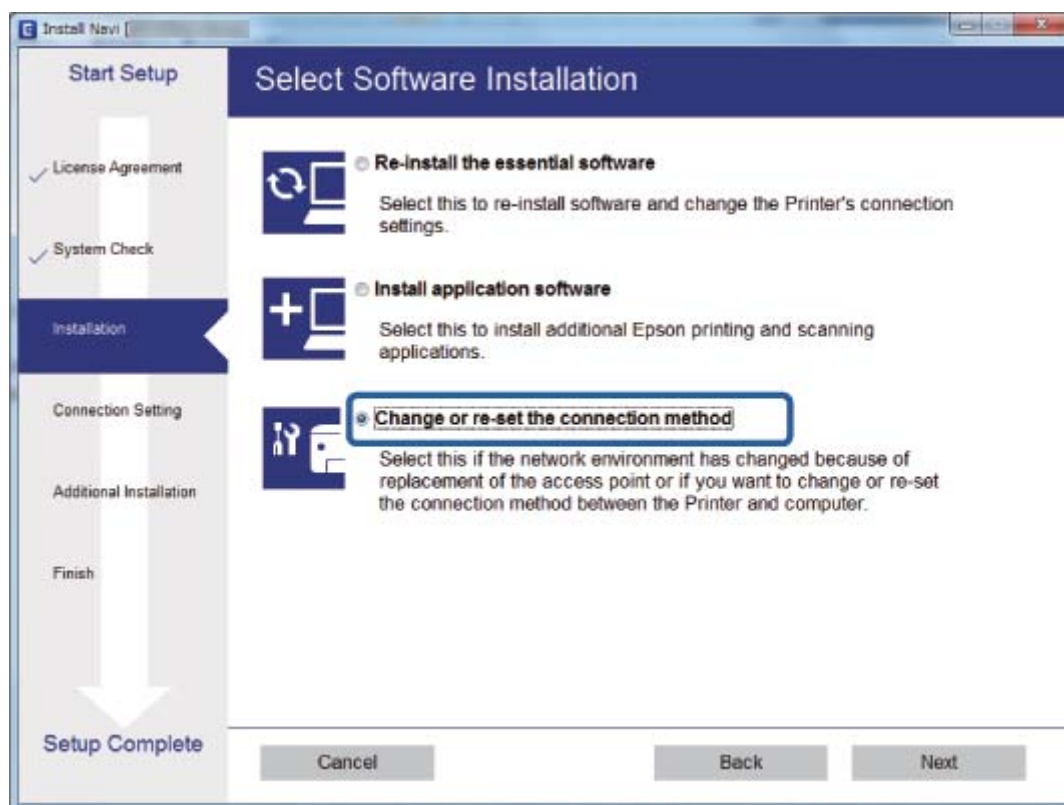

Network Settings

Mac OS X

Select how you want to connect the printer to your computer.



Disabling Wi-Fi from the Control Panel

When Wi-Fi is disabled, the Wi-Fi connection is disconnected.

1. Press  on the home screen.
2. Select **Wi-Fi Setup**.
3. Select **Disable Wi-Fi**.
4. Check the message, and then select **Yes**.
5. Press **Done**.

Disconnecting Wi-Fi Direct from the Control Panel

Note:

- When Simple AP mode is disabled, all devices connected to the printer in Simple AP mode are disconnected. If you want to disconnect a specific device, disconnect from the device instead of the printer.
- If you disconnect Wi-Fi Direct mode from the printer or from a device, the network is returned to its original setup.

1. Press  on the home screen.

Network Settings

2. Select **Wi-Fi Setup**.
3. Select **Wi-Fi Direct Setup**.
4. Select **Disconnect**.
5. Check the message, and then select **Yes**.
6. Press **Done**.

Restoring the Network Settings from the Control Panel

You can restore all network settings to their defaults.

1. Enter **Setup** from the home screen.
2. Select **System Administration**.
3. Select **Restore Default Settings**.
4. Select **Wi-Fi/Network Settings**.
5. Check the message, and then select **Yes**.
6. Press **OK**.

Administrator Settings

Locking the Printer Settings Using an Administrator's Password

You can set an administrator's password to lock the printer settings so that they cannot be changed by other users. You can lock the following settings.

- System Administration
- Eco Mode
- Presets
- Contacts

You cannot change settings without entering the password. This password is also required when you make settings using Web Config or EpsonNet Config.

**Important:**

Do not forget the password. If you forget the password, contact Epson support.

1. Enter **Setup** from the home screen.
2. Select **Admin Settings > Admin Password**.
3. Select **Register**, and then enter a password.
4. Enter the password again.
5. Select **Lock Setting**, and then enable it.

Unlocking the Printer Settings

1. Enter **Setup** from the home screen.
2. Select **Admin Settings**.
3. Enter the administrator's password.
4. Select **Lock Setting**, and then disable it.

Loading Paper

Paper Handling Precautions

- ❑ Read the instruction sheets supplied with the paper.
- ❑ Fan and align the edges of the paper before loading. Do not fan or curl photo paper. Doing so may damage the printable side.

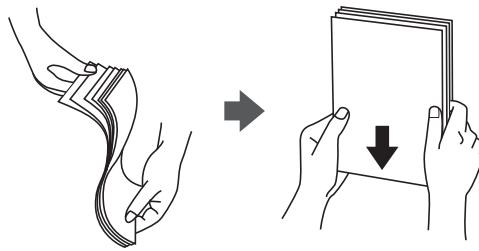

- ❑ If the paper is curled, flatten it or curl it slightly in the opposite direction before loading. Printing on curled paper may cause paper jams and smears on the printout.

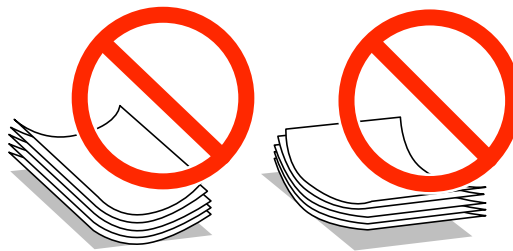

- ❑ Do not use paper that is wavy, torn, cut, folded, damp, too thick, too thin, or paper that has stickers stuck to it. Using these types of paper causes paper jams and smears on the printout.
- ❑ Make sure you are using long-grain paper. If you are not sure what type of paper you are using, check the paper packaging or contact the manufacturer to confirm the paper specifications.
- ❑ Fan and align the edges of the envelopes before loading. When the stacked envelopes are puffed up with air, press them down to flatten them before loading.



- ❑ Do not use envelopes that are curled or folded. Using these envelopes causes paper jams and smears on the printout.
- ❑ Do not use envelopes with adhesive surfaces on the flaps or window envelopes.
- ❑ Avoid using envelopes that are too thin, as they may curl during printing.

Related Information

➔ [“Printer Specifications” on page 211](#)

Available Paper and Capacities

Epson recommends using genuine Epson paper to ensure high-quality printouts.

Genuine Epson Paper

Media Name	Size	Loading Capacity (Sheets)			2-Sided Printing
		Paper Cassette 1	Paper Cassette 2	Rear Paper Feed Slot	
Epson Bright White Ink Jet Paper	A4	200	200	1	Auto Manual*
Epson Premium Glossy Photo Paper	A3+, A3, A4, 13×18 cm (5×7 in.), 16:9 wide size (102×181 mm), 10×15 cm (4×6 in.)	20	–	1	–
Epson Matte Paper-Heavyweight	A3+, A3, A4	20	–	1	–
Epson Photo Quality Ink Jet Paper	A3+, A3, A4	80	–	1	–

* You can load up to 30 sheets for paper with one side already printed.

Note:

- The availability of paper varies by location. For the latest information on paper available in your area, contact Epson support.
- When printing on genuine Epson paper at a user defined size, only **Standard** or **Normal** print quality settings are available. Although some printer drivers allow you to select a better print quality, the printouts are printed using **Standard** or **Normal**.

Loading Paper

Commercially Available Paper

Media Name	Size	Loading Capacity (Sheets or Envelopes)			2-Sided Printing
		Paper Cassette 1	Paper Cassette 2	Rear Paper Feed Slot	
Plain paper Copy paper Letterhead Recycled paper Color paper Preprinted paper	A3, B4, Legal, Letter, A4, B5	Up to the line indicated by the triangle symbol on the edge guide.		1	Auto Manual* ¹
	A5	Up to the line indicated by the triangle symbol on the edge guide.	–		–
	A6				
	User Defined (mm) 89×127 to 329×1200 mm	1	–	1	Auto* ² Manual
	User Defined (mm) 182×257 to 329×1200 mm	–	1	–	Auto* ³ Manual
Thick paper	A3, B4, Legal, Letter, A4, B5, A5, User Defined	–	–	1	–
Envelope	Envelope #10, Envelope DL, Envelope C4 , Envelope C6	10	–	1	–

*1 You can load up to 30 sheets for paper with one side already printed.

*2 User Defined (Auto 2-sided printing): 148×210 (A5) to 297×431.8 mm

*3 User Defined (Auto 2-sided printing): 182×257 (B5) to 297×431.8 mm

Related Information

➔ [“Part Names and Functions” on page 15](#)

➔ [“Technical Support Web Site” on page 227](#)

List of Paper Types

To obtain optimum printing results, select the paper type that suits the paper.

Media Name	Media Type	
	Control Panel	Printer Driver
Plain paper, Copy paper Epson Bright White Ink Jet Paper	plain papers	plain papers
Epson Premium Glossy Photo Paper	Prem. Glossy	Epson Premium Glossy

Loading Paper

Media Name	Media Type	
	Control Panel	Printer Driver
Epson Matte Paper-Heavyweight	Matte	Epson Matte
Epson Photo Quality Ink Jet Paper		
Thick paper	Thick-Paper	Thick-Paper
Envelope	Envelope	Envelope
Letterhead	Letterhead	Letterhead
Recycled paper	Recycled	Recycled
Preprinted paper	Preprinted	Preprinted
Colored paper	Color	Color

Loading Paper in the Paper Cassette

1. Check that the printer is not operating, and then pull out the paper cassette.

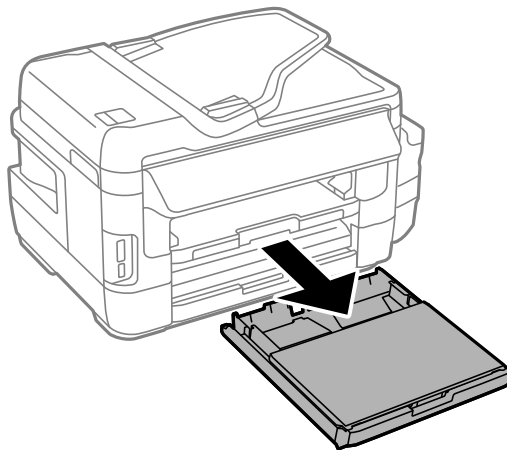

2. Remove the paper cassette cover from paper cassette.

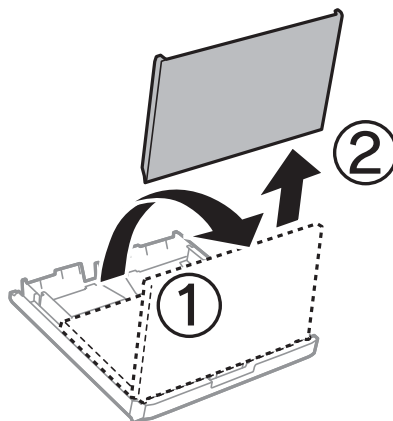

Loading Paper

- Slide the edge guides to their maximum position.

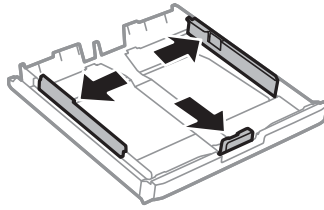

Note:

When using paper larger than A4 size, extend the paper cassette.

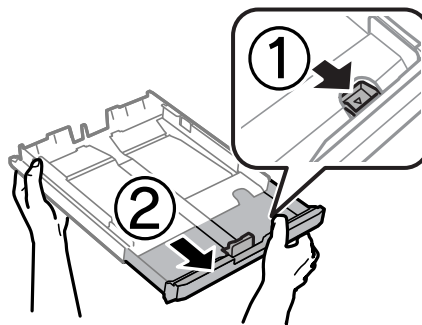

- Slide the front edge guide to the paper size you want to use.

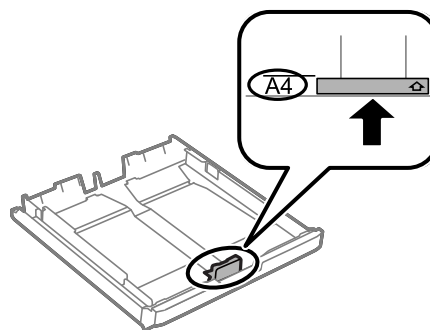

- With the printable side facing down, load paper against the front edge guide.

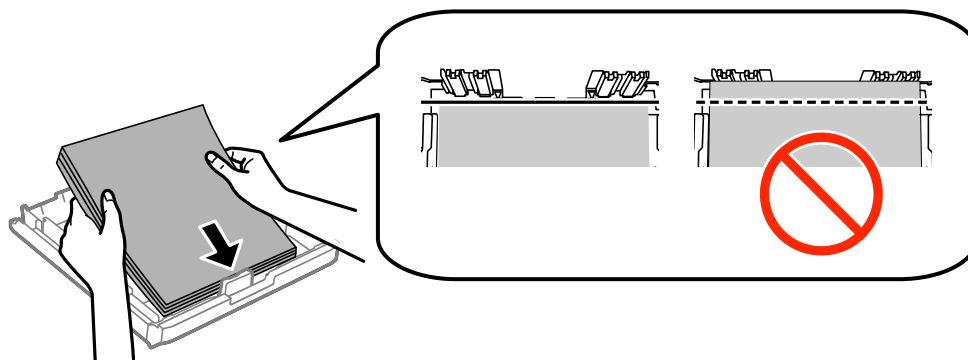

Loading Paper

For envelopes:

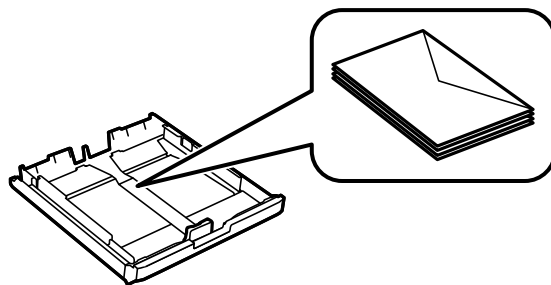

Important:

Do not load more than the maximum number of sheets specified for the paper. For plain paper, do not load above the line just under the triangle symbol inside the edge guide.

6. Slide the side edge guides to the edges of the paper.

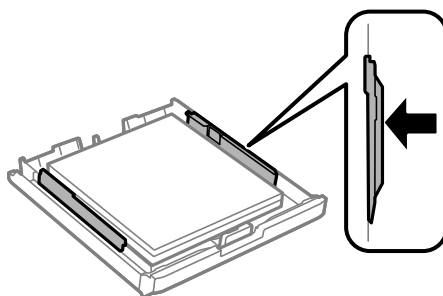

7. Put the paper cassette cover back on.

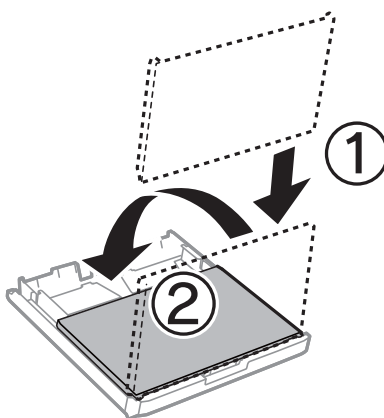

8. Insert the paper cassette all the way.
9. On the control panel, set the size and type of the paper you loaded in the paper cassette.

Note:

*You can also display the paper size and paper type settings screen by selecting **Setup** > **Paper Setup**.*

Loading Paper

- Slide out the output tray.

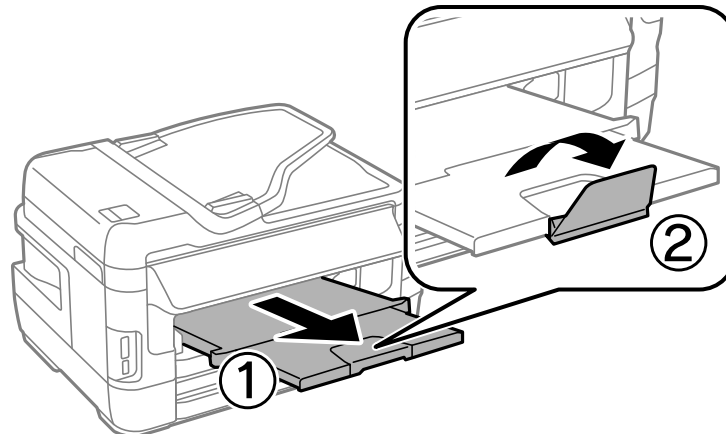

Related Information

- ➔ [“Paper Handling Precautions” on page 42](#)
- ➔ [“Available Paper and Capacities” on page 43](#)

Loading Paper in the Rear Paper Feed Slot

You can load a single sheet of all types of supported paper in the rear paper feed slot. You can also load thick paper (up to 0.3 mm thick) and pre-punched paper, which cannot be loaded in the paper cassette. However, even if the thickness is within this range, some paper may not be fed correctly depending on the hardness.

! *Important:*

Do not load paper in the rear paper feed slot until the printer prompts you to do so. Doing so will result in the blank paper being ejected.

- Do one of the following.
 - When printing from the control panel: Select rear paper feed slot as the **Paper Source** setting, make other print settings, and then press the **◊** button.
 - When printing from a computer: Select rear paper feed slot as the **Paper Source** setting, make other print settings, and then click **Print**.
- A message is displayed on the control panel telling you to load paper. Follow the instructions below to load the paper.

Loading Paper

3. Open the rear paper feed slot.

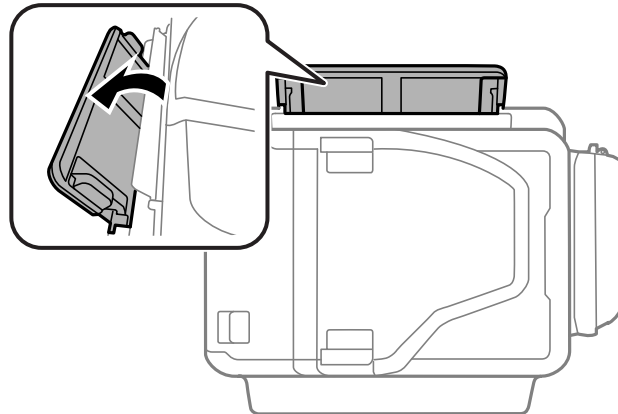

4. Slide out the edge guides.

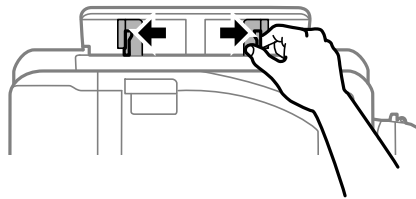

5. While holding a single sheet of paper at the center of the rear paper feed slot with the printable side facing up, slide the edge guides to the edges of the paper.

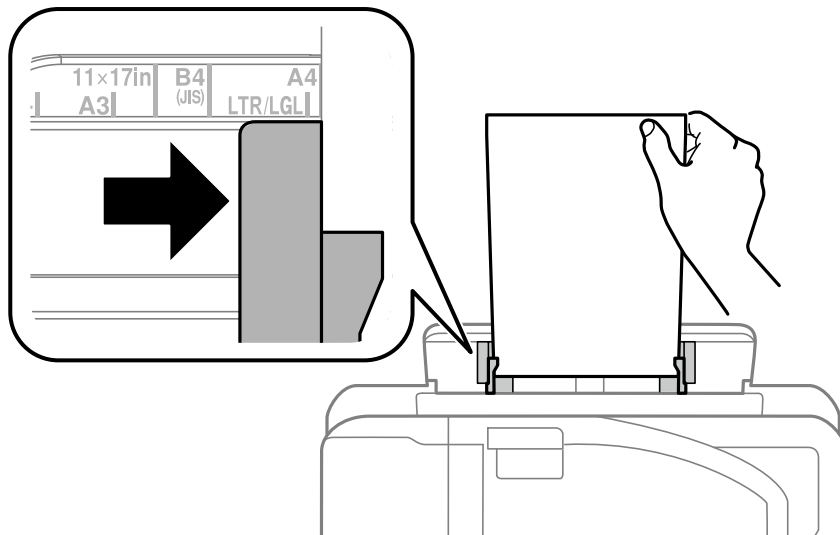

Loading Paper

- ❑ Envelopes

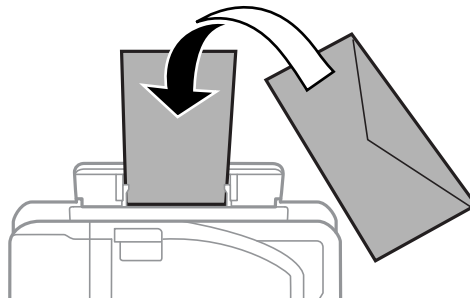

- ❑ Pre-punched paper

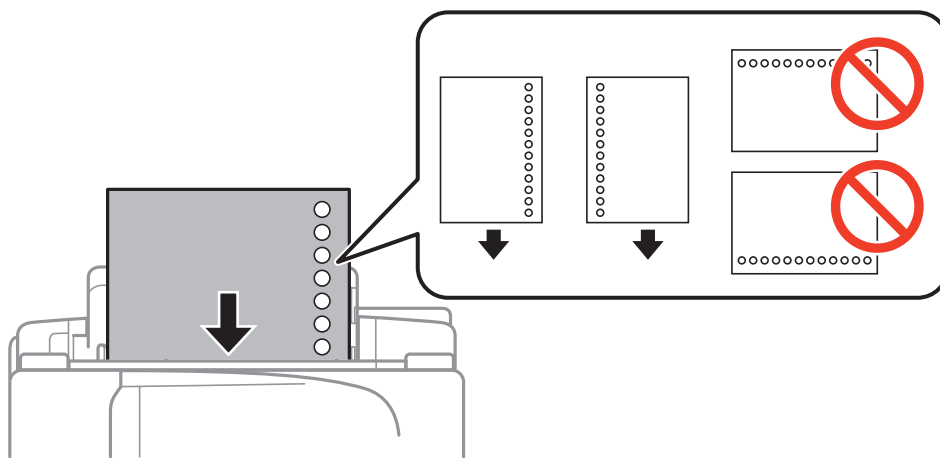

Note:

- ❑ Load a single sheet of defined size plain paper with binding holes at the left or right.
- ❑ Adjust the print position of your file to avoid printing over the holes.
- ❑ Automatic 2-sided printing is not available for pre-punched paper.

6. Insert the paper until the printer partially pulls in the paper.

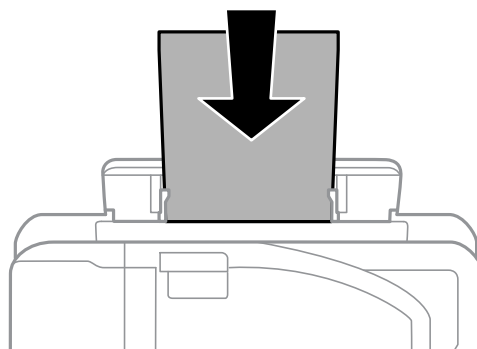

Loading Paper

7. Slide out the output tray.

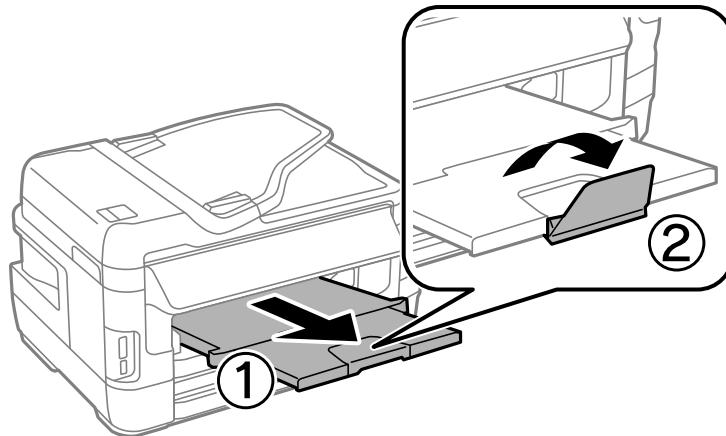

8. Press the  button to start printing.

Related Information

- ➔ [“Paper Handling Precautions” on page 42](#)
- ➔ [“Available Paper and Capacities” on page 43](#)

Placing Originals

Place originals on the scanner glass or the ADF. Use the scanner glass for originals that the ADF does not support. You can scan multiple originals and both sides of the originals at the same time with the ADF.

Available Originals on the ADF

Available Paper Sizes	A5 to A3, Ledger
Paper Type	Plain paper
Paper Thickness (Weight of Paper)	64 to 95 g/m ²
Loading Capacity	35 sheets or 3.5 mm

To prevent paper jams, avoid placing the following originals in the ADF. For these types, use the scanner glass.

- Originals that are torn, folded, wrinkled, deteriorated, or curled
- Originals with binder holes
- Originals held together with tape, staples, paper clips etc.
- Originals that have stickers or labels stuck to them
- Originals that are cut irregularly or not right angled
- Originals that are bound
- OHPs, thermal transfer paper, or carbon backs

Placing Originals on the ADF

1. Align the edges of the originals.
2. Slide the ADF edge guide.

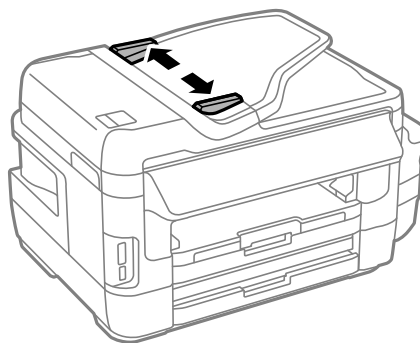

Placing Originals

3. Place the originals in the center of the ADF, facing up.

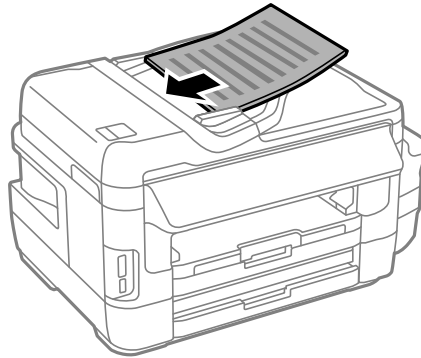

! *Important:*

- ❑ *Do not load originals above the line indicated by the triangle symbol on the ADF.*

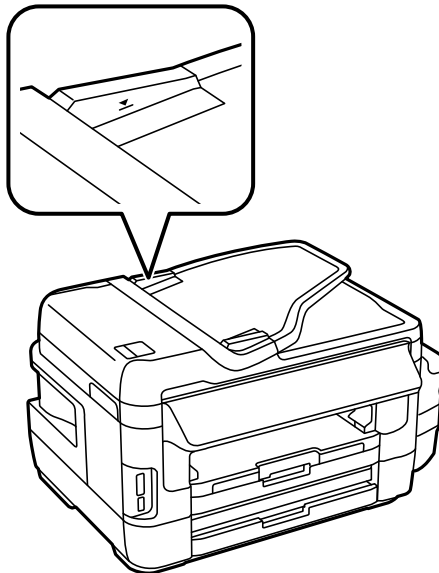

- ❑ *Do not add originals while scanning.*

4. Slide the ADF edge guide to the edge of the originals.

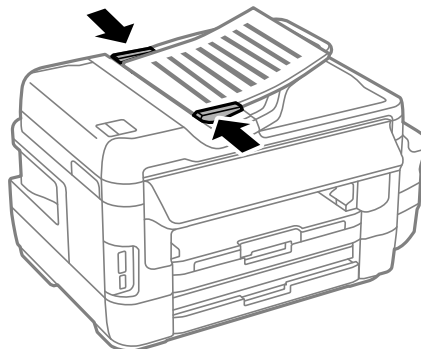

Placing Originals

Related Information

➔ [“Available Originals on the ADF” on page 52](#)

Placing Originals on the ADF for 2-up Copying

Place the originals in the correct direction and select the orientation setting.

Portrait originals: Select **Portrait** on the control panel as described below.

Copy > Settings > Document Orientation > Portrait



Landscape originals: Select **Landscape** on the control panel as described below.

Copy > Settings > Document Orientation > Landscape



Placing Originals on the Scanner Glass

 **Caution:**

Be careful not to trap your hand or fingers when opening or closing the document cover. Otherwise you may be injured.

 **Important:**

When placing bulky originals such as books, prevent exterior light from shining directly onto the scanner glass.

1. Open the document cover.

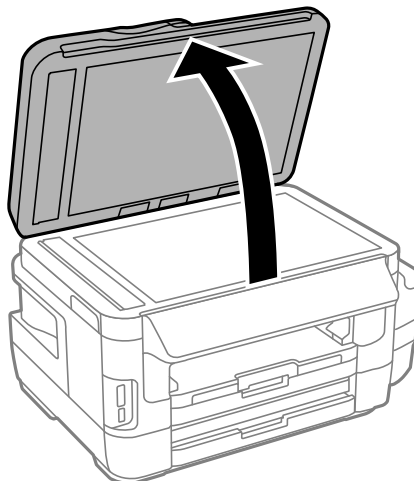

Placing Originals

2. Remove any dust or stains on the scanner glass.
3. Place the original face-down and slide it to the corner mark.

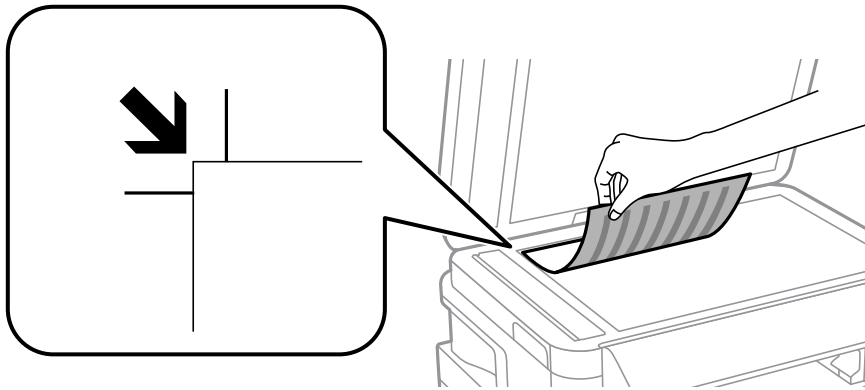

Note:

- ❑ A range of 1.5 mm from the edges of the scanner glass is not scanned.
- ❑ When originals are placed in the ADF and on the scanner glass, priority is given to the originals in the ADF.



4. Close the cover gently.
5. Remove the originals after scanning.

Note:

If you leave the originals on the scanner glass for a long time, they may stick to the surface of the glass.

Inserting a Memory Card

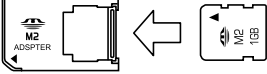
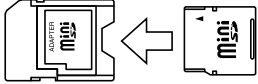
Supported Memory Cards

	<ul style="list-style-type: none"> Memory Stick Duo* Memory Stick PRO Duo* Memory Stick PRO-HG Duo* Memory Stick Micro* MagicGate Memory Stick Duo*
	<ul style="list-style-type: none"> miniSD* miniSDHC* microSD* microSDHC* microSDXC*
	<ul style="list-style-type: none"> SD SDHC SDXC

* Attach an adapter to fit the memory card slot. Otherwise, the card may get stuck.

Related Information

➔ [“Supported Memory Card Specifications” on page 215](#)

Inserting and Removing a Memory Card

1. Insert a memory card into the printer.

The printer starts reading the data and the light flashes. When reading is complete, the light stops flashing and remains on.

Inserting a Memory Card

! *Important:*

- ❑ *Insert a memory card straight into the printer.*
- ❑ *The card should not be fully inserted. Do not try to force it all the way into the slot.*

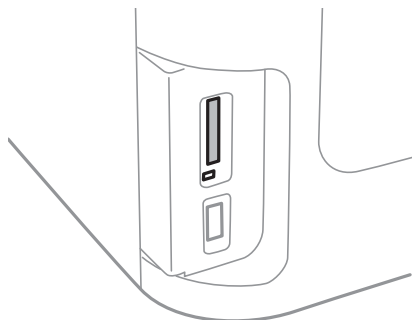

2. When you have finished using the memory card, make sure the light is not flashing, and then remove the card.

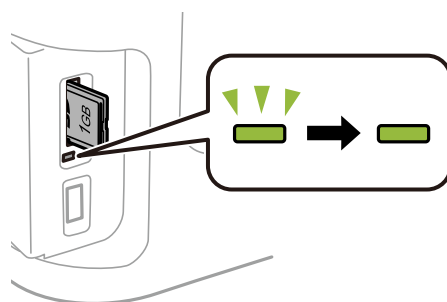

! *Important:*

If you remove the memory card while the light is flashing, the data in the memory card may be lost.

Note:

If you access the memory card from a computer, you need to operate the computer to safely remove the removable device.

Related Information

- ➔ [“Accessing the External Storage Device From a Computer” on page 224](#)

Managing Contacts

Registering a contacts list allows you to easily enter destinations. You can register up to 200 entries, and you can use the contacts list when you enter a fax number, enter a destination for attaching a scanned image to an email, and saving a scanned image to a network folder.

You can also register contacts in the LDAP server. See the *Administrator's Guide* to register contacts in the LDAP server.

Registering Contacts

Note:

Before registering contacts, make sure you have also configured the email server settings to use the email address.

1. Select **Contacts** from the home screen, the **Scan** mode, or the **Fax** mode.
2. Press **Menu**, and then select **Add Entry**.
3. Select the type of contact you want to register.
 - Fax: Register a contact (fax number) to send a fax.
 - Email: Register an email address to send a scanned image or forward a received fax.
 - Network Folder/FTP: Register a network folder to save a scanned image or received fax.

Note:

This screen is displayed when you open the contacts list from the home screen.

4. Select the entry number that you want to register.
5. Make the necessary settings for each mode.

Note:

*When entering a fax number, enter an external access code at the beginning of the fax number if your phone system is PBX and you need the access code to get an outside line. If the access code has been set in the **Line Type** setting, enter a hash (#) instead of the actual access code. To add a pause (pause for three seconds) during dialing, enter a hyphen by pressing .*

6. Press **Save**.

Note:

- To edit or delete an entry, press the information icon on the right of the target entry, and then press **Edit** or **Delete**.
- You can register an address that is registered in the LDAP server in the local contacts list of the printer. Display an entry, and then press **Save**.

Related Information

➔ [“Using an Email Server” on page 225](#)

Registering Grouped Contacts

Adding contacts to a group allows you to send a fax or send a scanned image by an email to multiple destinations at the same time.

1. Select **Contacts** from the home screen, the **Scan** mode, or the **Fax** mode.
2. Press **Menu**, and then select **Add Group**.
3. Select the type of group address you want to register.
 - Fax: Register a contact (fax number) to send a fax.
 - Email: Register an email address to send a scanned image or forward a received fax.

Note:

This screen is displayed when you open the contacts list from the home screen.

4. Select the entry number that you want to register.
5. Enter **Name** and **Index Word**, and then press **Proceed**.
6. Press the check box of the contacts that you want to register in the group.

Note:

- You can register up to 199 contacts.
- To deselect, press the check box of the contact again.

7. Press **Save**.

Note:

*To edit or delete a grouped contact, press the information icon on the right of the target grouped contact, and then press **Edit** or **Delete**.*

Register Contacts on a Computer

Using EpsonNet Config, you can create a contact list on your computer and import it to the printer. See the manual of EpsonNet Config for details.

Related Information

➔ [“EpsonNet Config” on page 164](#)

Backing up Contacts using a Computer

Using EpsonNet Config, you can back up the contact data stored in the printer to the computer. See the manual of EpsonNet Config for details.

Contacts data may be lost due to a printer malfunction. We recommend that you make a backup of the data whenever you update the data. Epson shall not be responsible for the loss of any data, for backing up or recovering data and/or settings even during a warranty period.

Managing Contacts

Related Information

➔ [“EpsonNet Config” on page 164](#)

Printing

Printing from the Control Panel

You can print data from a memory card or an external USB device.

Printing a JPEG file

1. Load paper in the printer.

**Important:**

- When loading in the paper cassette, make the paper settings on the control panel.
- When loading in the rear paper feed slot, do not load paper until the printer prompts you to do so.

2. Insert a memory device.

**Important:**

Do not remove the memory device until you have finished printing.

3. Enter **Memory Device** from the Home menu.

4. Select **JPEG**.

Note:

- If you have more than 999 images on your memory device, images are automatically divided into groups and the group selection screen is displayed. Select the group that contains the image you want to print. Images are sorted by the date they were taken.
- To select another group, select the menu as shown below.

Memory Device > JPEG > Options > Select Group.

5. Select the image you want to print.

6. Enter the number of prints by using the numeric keypad on the control panel.

7. Press **Adjustments** to make color adjustment settings

Note:

For more information on detailed settings, see the menus for the memory device.

8. Press  button.

Note:

To select more images, press the  button and then repeat step 5 or swipe horizontally to change the image. Then repeat steps 6 to 7.

9. Press **Settings** to make print settings.

Note:

For more information on detailed settings, see the menus for the memory device.

Printing

10. Press **Proceed** to confirm the print settings.
11. Press one of the  buttons to set the color mode, and then start printing.

Related Information

- ➔ [“Loading Paper in the Paper Cassette” on page 45](#)
- ➔ [“Loading Paper in the Rear Paper Feed Slot” on page 48](#)
- ➔ [“Inserting a Memory Card” on page 56](#)
- ➔ [“Menu Options for Memory Device” on page 63](#)

Printing a TIFF file

1. Load paper in the printer.



Important:

- When loading in the paper cassette, make the paper settings on the control panel.
- When loading in the rear paper feed slot, do not load paper until the printer prompts you to do so.



2. Insert a memory device.



Important:

Do not remove the memory device until you have finished printing.

3. Select **Memory Device** from the Home menu.
4. Select **TIFF**.
5. Select the file you want to print.
6. Check the file information, and then press **Proceed**.
7. Enter the number of prints by using the numeric keypad on the control panel.
8. Press **Settings** to make print settings.

Note:
For more information on detailed settings, see the menus for the memory device.
9. Press the  button, and then press **Proceed** to confirm the print settings.
10. Press one of the  buttons to set the color mode, and then start printing.

Related Information

- ➔ [“Loading Paper in the Paper Cassette” on page 45](#)
- ➔ [“Loading Paper in the Rear Paper Feed Slot” on page 48](#)
- ➔ [“Inserting a Memory Card” on page 56](#)
- ➔ [“Menu Options for Memory Device” on page 63](#)

Printing

Menu Options for Memory Device

Note:

Available menus vary depending on the format of the file that you are printing.

Format of file

Select **JPEG** or **TIFF** to print the file in the memory device.

Number of copies

Enter the number of printouts.

Settings

 Paper Source

Select the paper source that you want to use. When you select **Rear Paper Feed Slot**, select the paper size and paper type you want to load in the rear paper feed slot.

 Quality

Select the print quality. Selecting **Best** provides higher quality printing, but the printing speed may be slower.

 Date

Select the format used to print the date on photos for photos that include the date the photos were taken or the date they were saved. The date is not printed for some layouts.

 Fit Frame

If the aspect ratio of the image data and the paper size is different, the image is automatically enlarged or reduced so that the short sides match the short sides of the paper. The long side of the image is cropped if it extends beyond the long side of the paper. This feature may not work for panorama photos.

 Bidirectional

Prints while the print head moves to the left and to the right. If vertical or horizontal ruled lines on your printout look blurred or misaligned, disabling this feature may solve the problem; however, doing so may reduce print speed.

 Print Order

Select **Last Page on Top** to print from the first page of a file. Select **First Page on Top** to print from the last page of a file.

Adjustments

 Fix Photo

Select the image fixing method.

 Fix Red-Eye

Fixes red-eye in photos. Corrections are not applied to the original file, only to the printouts. Depending on the type of photo, parts of the image other than the eyes may be corrected.

Options

 Select Images

Printing

Select All Images selects all of the images on the memory device.

- Select Group

Select this menu to select another group.

Printing from a Computer

If you cannot change some of the printer driver settings, they may have been restricted by the administrator. Contact your printer administrator for assistance.

Printing Basics - Windows

Note:

- See the online help for explanations of the setting items. Right-click an item, and then click **Help**.
- Operations may differ depending on the application. See the application's help for details.

1. Load paper in the printer.



Important:

- When loading in the paper cassette, make the paper settings on the control panel.
- When loading in the rear paper feed slot, start printing from the printer driver before loading paper. Select *Rear Paper Feed Slot* as the Paper Source setting on the printer driver. When printing starts, the printer driver tells you that printing is in progress. Follow the printer's on-screen instructions to load paper.

2. Open the file you want to print.
3. Select **Print** or **Print Setup** from the **File** menu.
4. Select your printer.

Printing

5. Select **Preferences** or **Properties** to access the printer driver window.

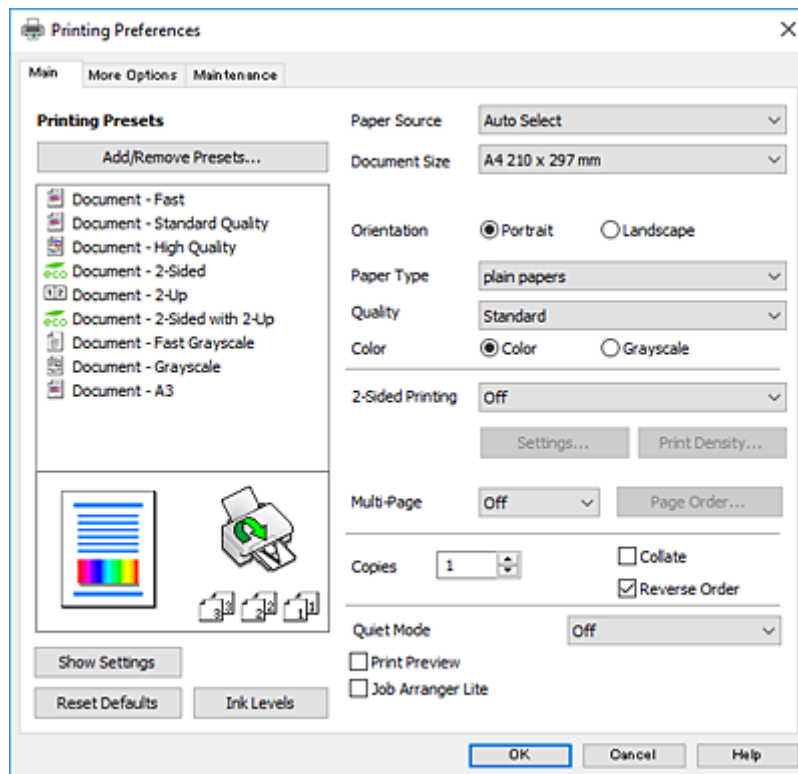

6. Make the following settings.
 - Paper Source: Select the paper source in which you loaded the paper.
 - Document Size: Select the paper size you loaded in the printer.
 - Orientation: Select the orientation you set in the application.
 - Paper Type: Select the type of paper you loaded.
 - Quality: Select the print quality. Selecting **High** provides higher quality printing, but the printing speed may be slower.
 - Color: Select **Grayscale** when you want to print in black or shades of gray.

Note:

- If you are printing high-density data on plain paper, letterhead, or preprinted paper, select Standard-Vivid as the Quality setting to make your printout vivid.*
 - When printing on envelopes, select Landscape as the **Orientation** setting.*
7. Click **OK** to close the printer driver window.
 8. Click **Print**.

Related Information

- ➔ [“Available Paper and Capacities” on page 43](#)
- ➔ [“Loading Paper in the Paper Cassette” on page 45](#)
- ➔ [“Loading Paper in the Rear Paper Feed Slot” on page 48](#)
- ➔ [“List of Paper Types” on page 44](#)

Printing

Printing Basics - Mac OS X

Note:

- ❑ Explanations in the section use TextEdit as an example. Operations and screens differ depending on the application. See the application's help for details.
- ❑ When printing envelopes, use the application to rotate the data 180 degrees. See the application's help for details.

1. Load paper in the printer.

! Important:

- ❑ When loading in the paper cassette, make the paper settings on the control panel.
- ❑ When loading in the rear paper feed slot, start printing from the printer driver before loading paper. Select **Rear Paper Feed Slot** as the **Paper Source** setting on the printer driver. When printing starts, the printer driver tells you that printing is in progress. Follow the printer's on-screen instructions to load paper.

2. Open the file you want to print.
3. Select **Print** from the **File** menu or another command to access the print dialog.

If necessary, click **Show Details** or ▼ to expand the print window.

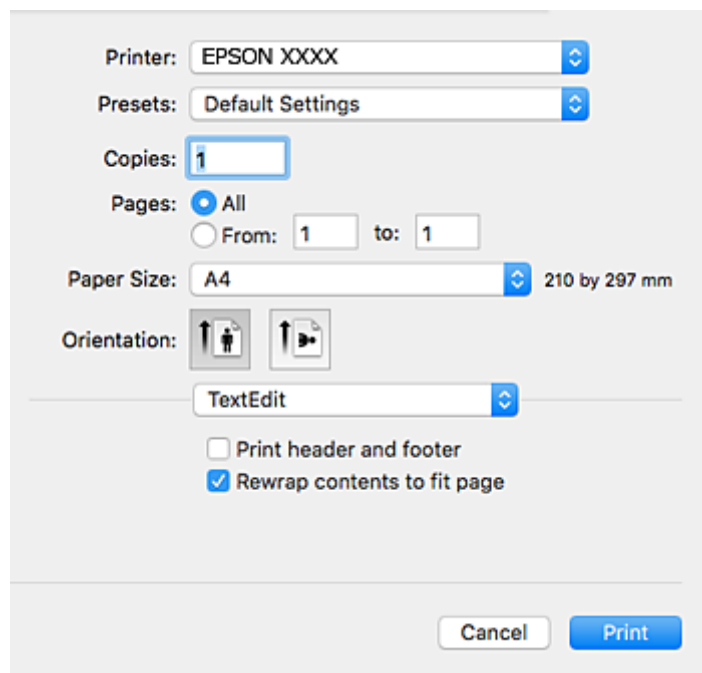

4. Make the following settings.
 - ❑ Printer: Select your printer.
 - ❑ Presets: Select when you want to use the registered settings.
 - ❑ Paper Size: Select the paper size you loaded in the printer.
 - ❑ Orientation: Select the orientation you set in the application.

Printing

Note:

- If the above setting menus are not displayed, close the print window, select **Page Setup** from the **File** menu, and then make settings.
- When printing on envelopes, select landscape orientation.

5. Select **Print Settings** from the pop-up menu.

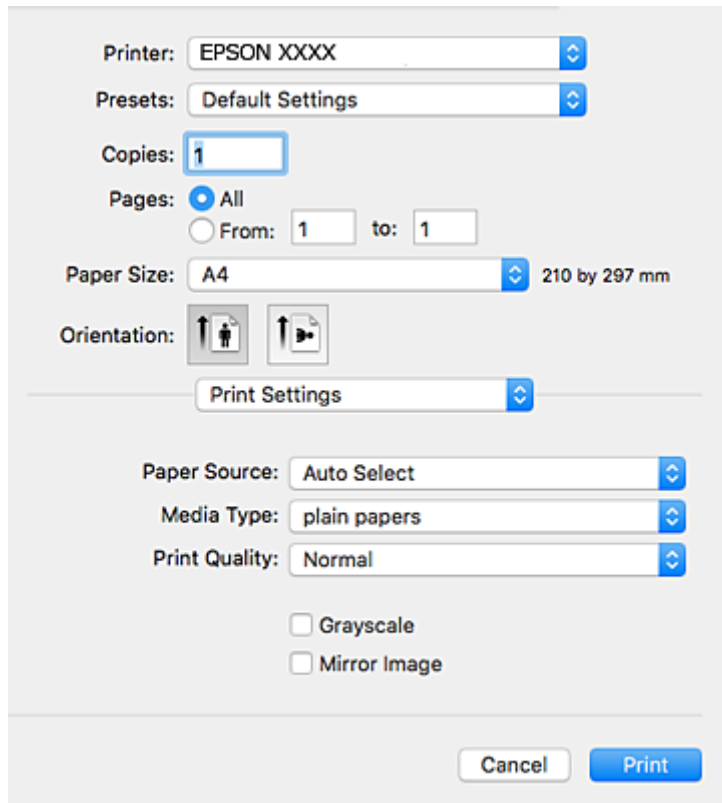

Note:

On Mac OS X v10.8.x or later, if the **Print Settings** menu is not displayed, the Epson printer driver has not been installed correctly.

Select **System Preferences** from the  menu > **Printers & Scanners** (or **Print & Scan**, **Print & Fax**), remove the printer, and then add the printer again. See the following to add a printer.

<http://epson.sn>

6. Make the following settings.
 - Paper Source: Select the paper source in which you loaded the paper.
 - Media Type: Select the type of paper you loaded.
 - Print Quality: Select the print quality. Selecting **Fine** provides higher quality printing, but the printing speed may be slower.
 - Grayscale: Select to print in black or shades of gray.

Note:

If you are printing high-density data on plain paper, letterhead, or preprinted paper, select **Normal-Vivid** as the **Print Quality** setting to make your printout vivid.

7. Click **Print**.

Printing

Related Information

- ➔ [“Available Paper and Capacities” on page 43](#)
- ➔ [“Loading Paper in the Paper Cassette” on page 45](#)
- ➔ [“Loading Paper in the Rear Paper Feed Slot” on page 48](#)
- ➔ [“List of Paper Types” on page 44](#)

Printing on 2-Sides

You can use either of the following methods to print on both sides of the paper.

- Automatic 2-sided printing
- Manual 2-sided printing (for Windows only)

When the printer has finished printing the first side, flip the paper over to print on the other side.

You can also print a booklet that can be created by folding the printout. (For Windows only)

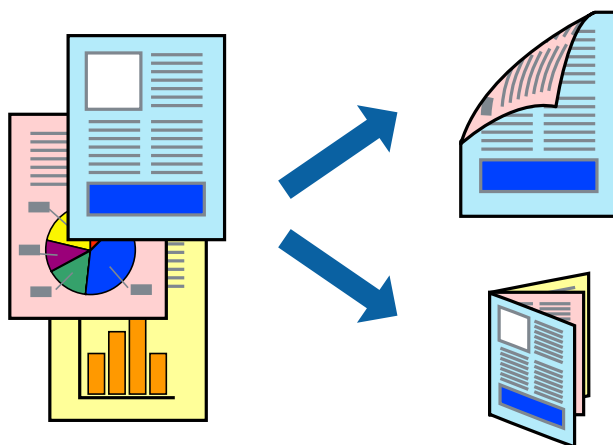

Note:

- If you do not use paper that is suitable for 2-sided printing, the print quality may decline and paper jams may occur.
- Depending on the paper and the data, ink may bleed through to the other side of the paper.

Related Information

- ➔ [“Available Paper and Capacities” on page 43](#)

Printing on 2-Sides - Windows

Note:

- Manual 2-sided printing is available when **EPSON Status Monitor 3** is enabled. If **EPSON Status Monitor 3** is disabled, access the printer driver, click **Extended Settings** on the **Maintenance** tab, and then select **Enable EPSON Status Monitor 3**.
- Manual 2-sided printing may not be available when the printer is accessed over a network or is used as a shared printer.

1. Load paper in the printer.
2. Open the file you want to print.
3. Access the printer driver window.

Printing

4. Select **Auto (Long-edge binding)**, **Auto (Short-edge binding)**, **Manual (Long-edge binding)**, or **Manual (Short-edge binding)** from **2-Sided Printing** on the **Main** tab.

5. Click **Settings**, make the appropriate settings, and then click **OK**.

Note:

*To print a folded booklet, select **Booklet**.*

6. Click **Print Density**, select the document type from **Select Document Type**, and then click **OK**.

The printer driver automatically sets the **Adjustments** options for that document type.

Note:

*Printing may be slow depending on the combination of options selected for **Select Document Type** in the **Print Density Adjustment** window and for **Quality** on the **Main** tab.*

*For manual 2-sided printing, the **Print Density Adjustment** setting is not available.*

7. Set the other items on the **Main** and **More Options** tabs as necessary, and then click **OK**.

8. Click **Print**.

For manual 2-sided printing, when the first side has finished printing, a pop-up window is displayed on the computer. Follow the on-screen instructions.

Related Information

- ➔ [“Loading Paper in the Paper Cassette” on page 45](#)
- ➔ [“Loading Paper in the Rear Paper Feed Slot” on page 48](#)
- ➔ [“Printing Basics - Windows” on page 64](#)

Printing on 2-Sides - Mac OS X

1. Load paper in the printer.
2. Open the file you want to print.
3. Access the print dialog.
4. Select **Two-sided Printing Settings** from the pop-up menu.
5. Select the bindings and **Document Type**.

Note:

*Printing may be slow depending on the **Document Type** setting.*

*If you are printing high-density data such as photos or graphs, select **Text & Graphics** or **Text & Photos as the Document Type** setting. If scuffing occurs or the image bleeds through to the reverse side, adjust the print density and ink drying time by clicking the arrow mark next to **Adjustments**.*

6. Set the other items as necessary.
7. Click **Print**.

Related Information

- ➔ [“Loading Paper in the Paper Cassette” on page 45](#)

Printing

- ➔ “Loading Paper in the Rear Paper Feed Slot” on page 48
- ➔ “Printing Basics - Mac OS X” on page 66

Printing Several Pages on One Sheet

You can print two or four pages of data on a single sheet of paper.

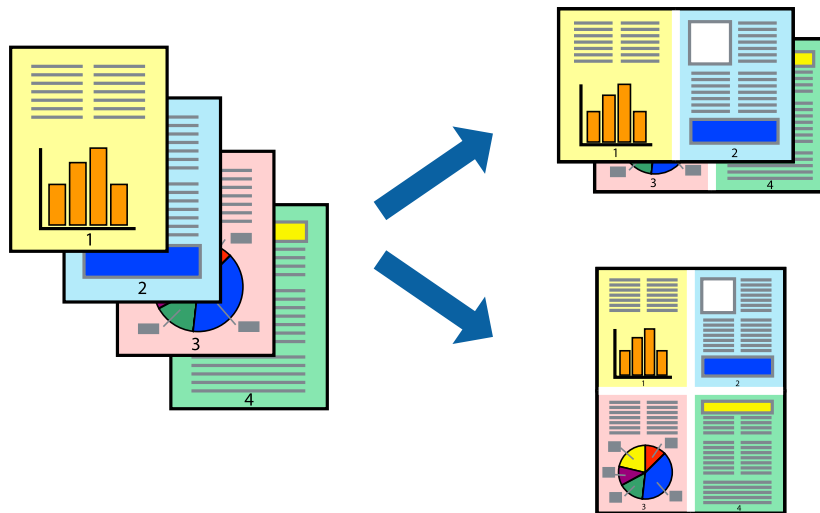

Printing Several Pages on One Sheet - Windows

1. Load paper in the printer.
2. Open the file you want to print.
3. Access the printer driver window.
4. Select **2-Up** or **4-Up** as the **Multi-Page** setting on the **Main** tab.
5. Click **Page Order**, make the appropriate settings, and then click **OK** to close the window.
6. Set the other items on the **Main** and **More Options** tabs as necessary, and then click **OK**.
7. Click **Print**.

Related Information

- ➔ “Loading Paper in the Paper Cassette” on page 45
- ➔ “Loading Paper in the Rear Paper Feed Slot” on page 48
- ➔ “Printing Basics - Windows” on page 64

Printing Several Pages on One Sheet - Mac OS X

1. Load paper in the printer.
2. Open the file you want to print.

Printing

3. Access the print dialog.
4. Select **Layout** from the pop-up menu.
5. Set the number of pages in **Pages per Sheet**, the **Layout Direction** (page order), and **Border**.
6. Set the other items as necessary.
7. Click **Print**.

Related Information

- ➔ [“Loading Paper in the Paper Cassette” on page 45](#)
- ➔ [“Loading Paper in the Rear Paper Feed Slot” on page 48](#)
- ➔ [“Printing Basics - Mac OS X” on page 66](#)

Printing to Fit the Paper Size

You can print to fit the paper size you loaded in the printer.



Printing to Fit the Paper Size - Windows

1. Load paper in the printer.
2. Open the file you want to print.
3. Access the printer driver window.
4. Make the following settings on the **More Options** tab.
 - Document Size: Select the paper size you set in the application.
 - Output Paper: Select the paper size you loaded in the printer.
 - Fit to Page** is selected automatically.
- Note:**
*If you want to print a reduced image at the center of the page, select **Center**.*
5. Set the other items on the **Main** and **More Options** tabs as necessary, and then click **OK**.
6. Click **Print**.

Printing

Related Information

- ➔ [“Loading Paper in the Paper Cassette” on page 45](#)
- ➔ [“Loading Paper in the Rear Paper Feed Slot” on page 48](#)
- ➔ [“Printing Basics - Windows” on page 64](#)

Printing to Fit the Paper Size - Mac OS X

1. Load paper in the printer.
2. Open the file you want to print.
3. Access the print dialog.
4. Select the size of the paper you set in the application as the **Paper Size** setting.
5. Select **Paper Handling** from the pop-up menu.
6. Select **Scale to fit paper size**.
7. Select the paper size you loaded in the printer as the **Destination Paper Size** setting.
8. Set the other items as necessary.
9. Click **Print**.

Related Information

- ➔ [“Loading Paper in the Paper Cassette” on page 45](#)
- ➔ [“Loading Paper in the Rear Paper Feed Slot” on page 48](#)
- ➔ [“Printing Basics - Mac OS X” on page 66](#)

Printing Multiple Files Together (for Windows Only)

Job Arranger Lite allows you to combine several files created by different applications and print them as a single print job. You can specify the print settings for combined files, such as layout, print order, and orientation.

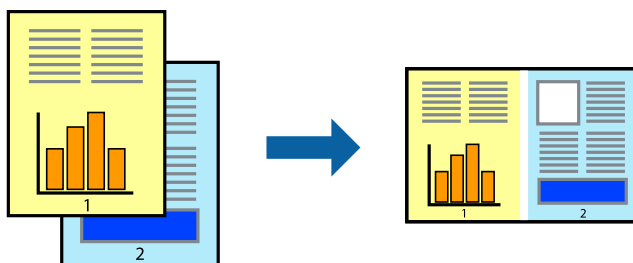

1. Load paper in the printer.
2. Open the file you want to print.
3. Access the printer driver window.

Printing

4. Select **Job Arranger Lite** on the **Main** tab.
5. Click **OK** to close the printer driver window.
6. Click **Print**.

The **Job Arranger Lite** window is displayed and the print job is added to the **Print Project**.

7. With the **Job Arranger Lite** window opened, open the file that you want to combine with the current file, and then repeat steps 3 to 6.

Note:

- If you close the **Job Arranger Lite** window, the unsaved **Print Project** is deleted. To print later, select **Save** from the **File** menu.
 - To open a **Print Project** saved in **Job Arranger Lite**, click **Job Arranger Lite** on the printer driver's **Maintenance** tab. Next, select **Open** from the **File** menu to select the file. The extension of the saved files is ".ecl".
8. Select the **Layout** and **Edit** menus in **Job Arranger Lite** to edit the **Print Project** as necessary. See the help of Job Arranger Lite for details.
 9. Select **Print** from the **File** menu.

Related Information

- ➔ [“Loading Paper in the Paper Cassette” on page 45](#)
- ➔ [“Loading Paper in the Rear Paper Feed Slot” on page 48](#)
- ➔ [“Printing Basics - Windows” on page 64](#)

Printing One Image on Multiple Sheets to Create a Poster (for Windows Only)

This feature allows you to print one image on multiple sheets of paper. You can create a larger poster by taping them together.

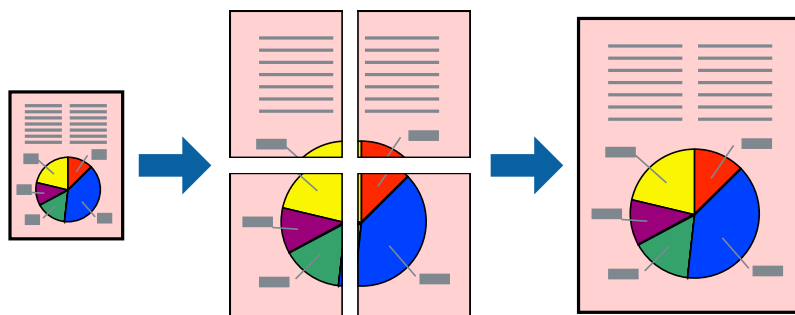

1. Load paper in the printer.
2. Open the file you want to print.
3. Access the printer driver window.
4. Select **2x1 Poster**, **2x2 Poster**, **3x3 Poster**, or **4x4 Poster** from **Multi-Page** on the **Main** tab.

Printing

5. Click **Settings**, make the appropriate settings, and then click **OK**.

Note:

Print Cutting Guides allows you to print a cutting guide.

6. Set the other items on the **Main** and **More Options** tabs as necessary, and then click **OK**.
7. Click **Print**.

Related Information

- ➔ [“Loading Paper in the Paper Cassette” on page 45](#)
- ➔ [“Loading Paper in the Rear Paper Feed Slot” on page 48](#)
- ➔ [“Printing Basics - Windows” on page 64](#)

Making Posters Using Overlapping Alignment Marks

Here is an example of how to make a poster when **2x2 Poster** is selected, and **Overlapping Alignment Marks** is selected in **Print Cutting Guides**.

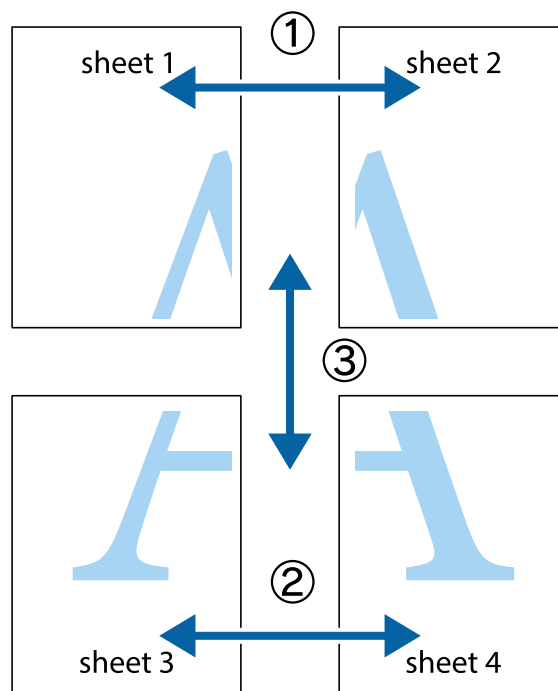

Printing

1. Prepare Sheet 1 and Sheet 2. Cut off the margins of Sheet 1 along the vertical blue line through the center of the top and bottom cross marks.

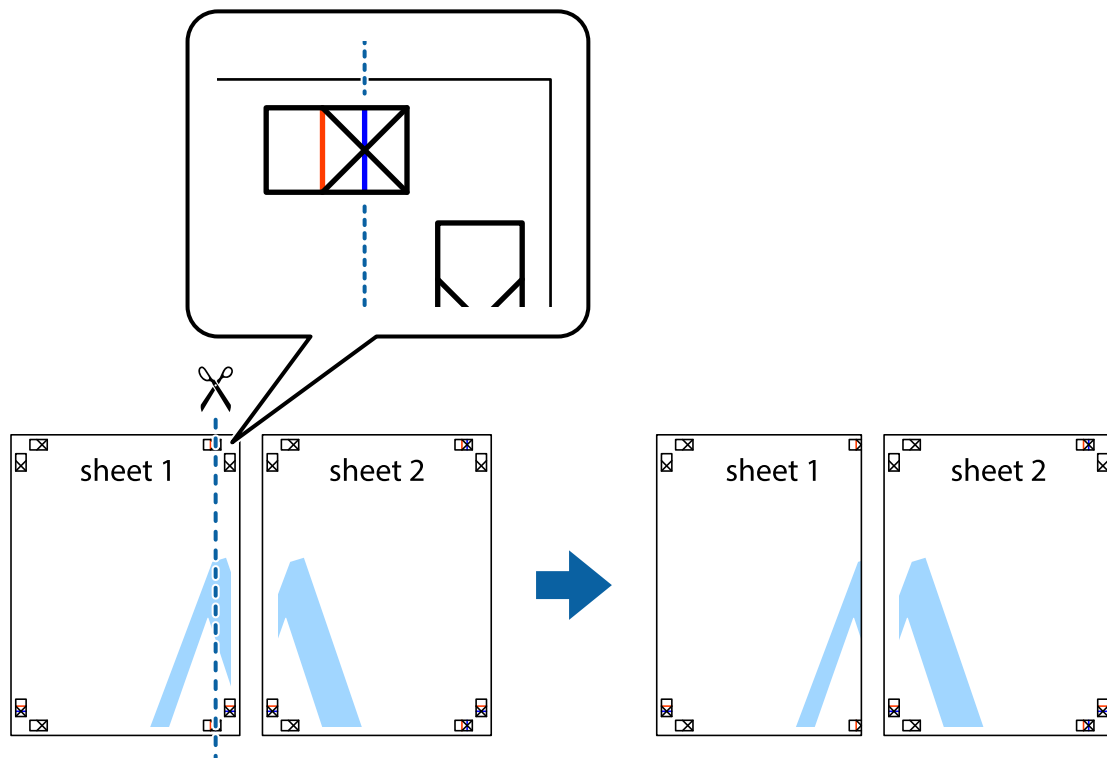

2. Place the edge of Sheet 1 on top of Sheet 2 and align the cross marks, then temporarily tape the two sheets together from the back.

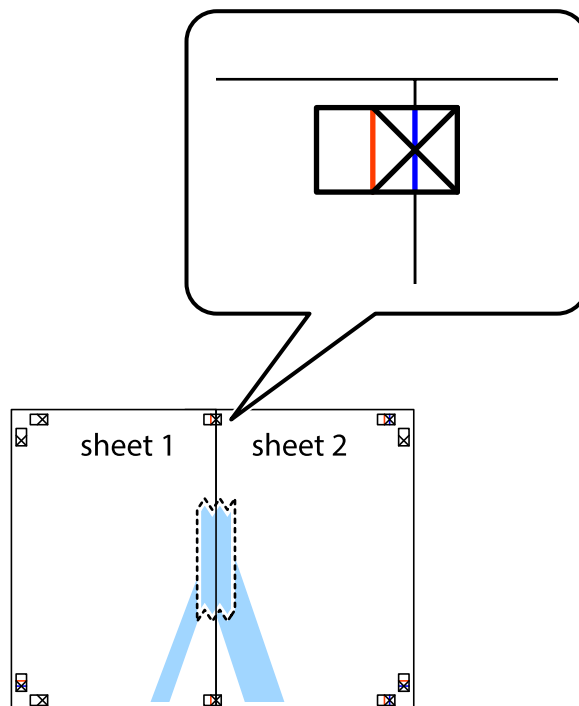

Printing

- Cut the taped sheets in two along the vertical red line through the alignment markers (this time, the line to the left of the cross marks).

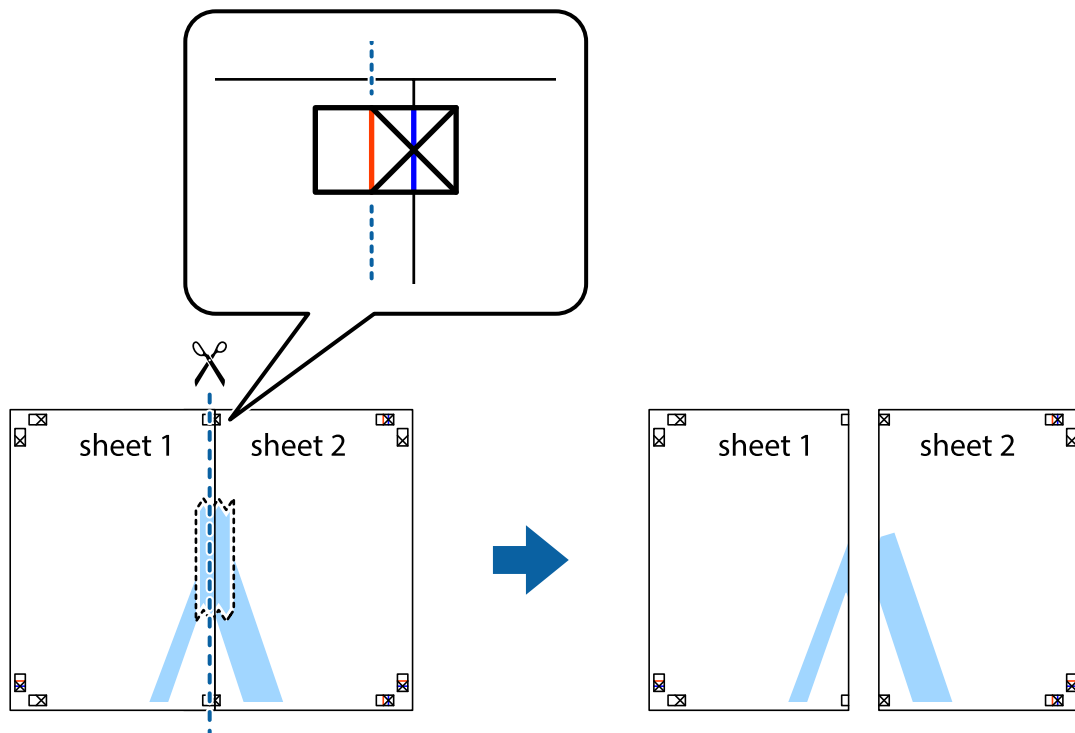

- Tape the sheets together from the back.

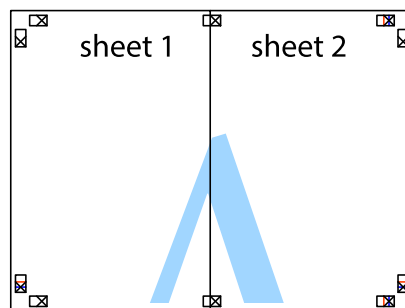

- Repeat steps 1 to 4 to tape Sheet 3 and Sheet 4 together.

Printing

6. Cut off the margins of Sheet 1 and Sheet 2 along the horizontal blue line through the center of the left and right side cross marks.

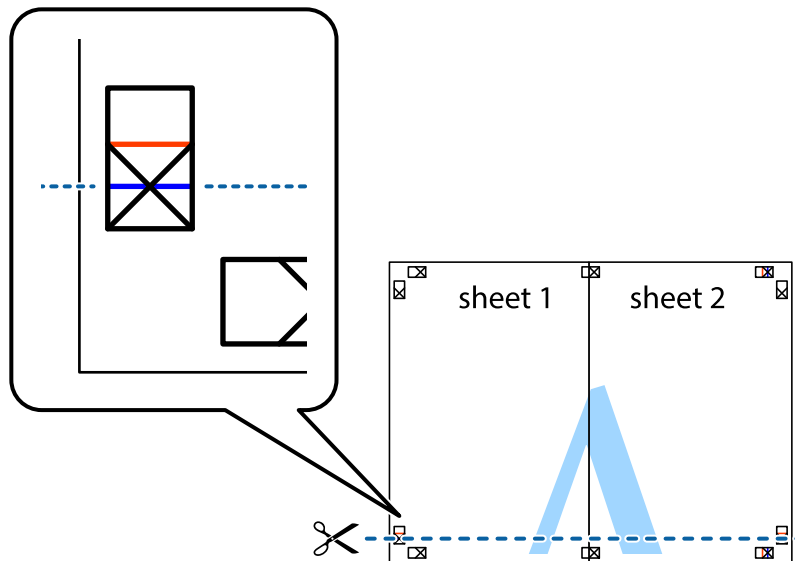

7. Place the edge of Sheet 1 and Sheet 2 on top of Sheet 3 and Sheet 4 and align the cross marks, and then temporarily tape them together from the back.

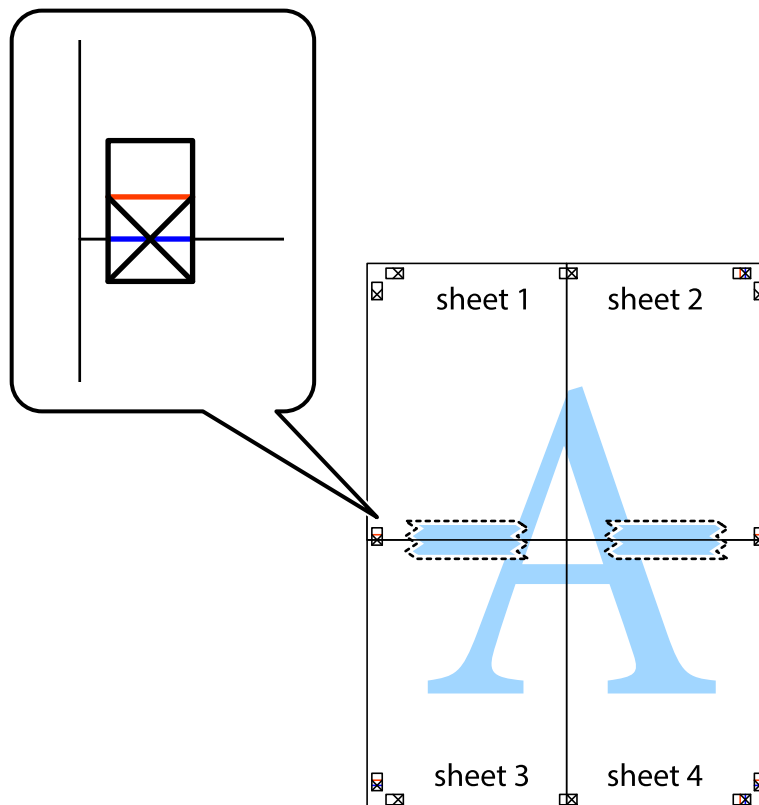

Printing

- Cut the taped sheets in two along the horizontal red line through the alignment markers (this time, the line above the cross marks).

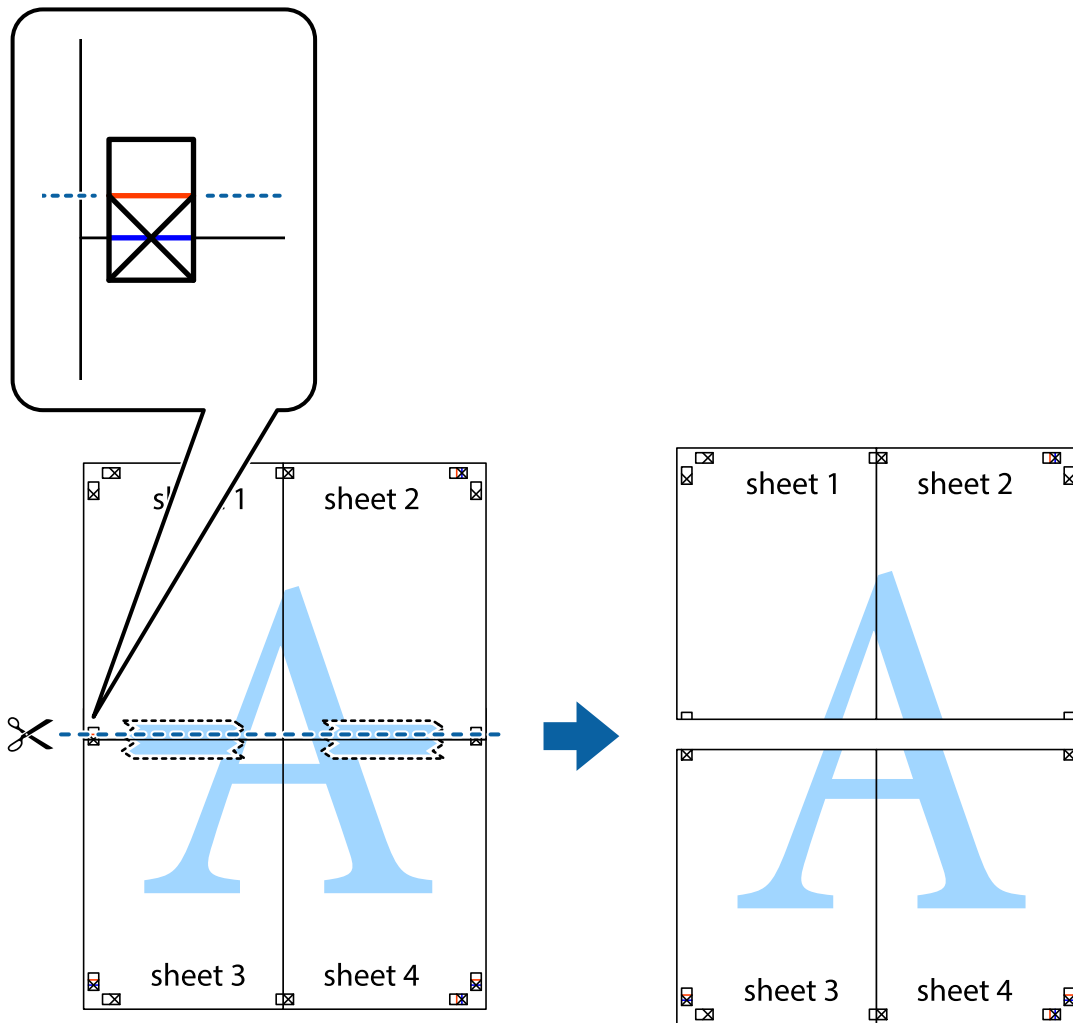

- Tape the sheets together from the back.



Printing

10. Cut off the remaining margins along the outer guide.

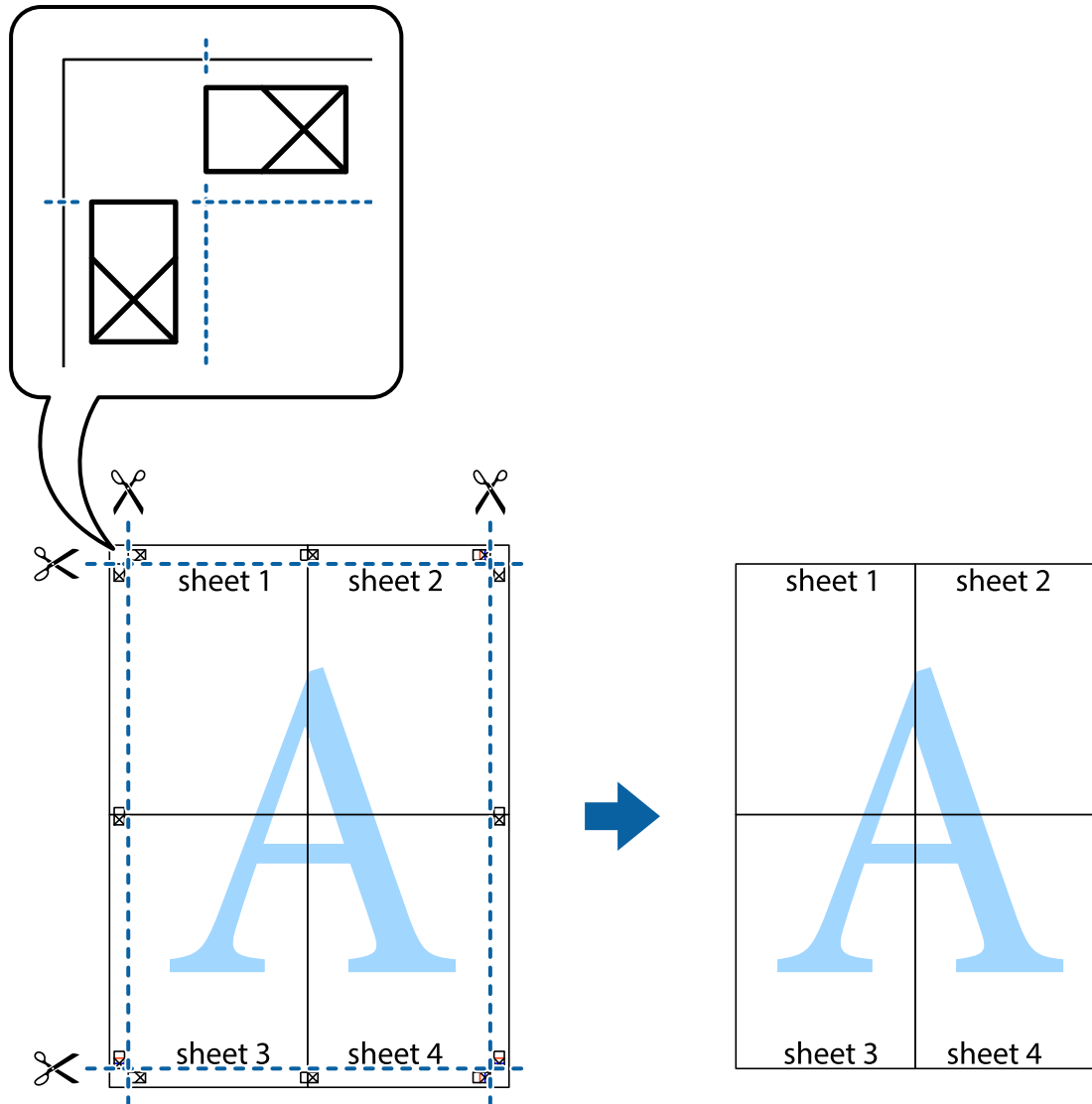

Printing Using Advanced Features

This section introduces a variety of additional layout and printing features available on the printer driver.

Related Information

- ➔ [“Windows Printer Driver” on page 158](#)
- ➔ [“Mac OS X Printer Driver” on page 160](#)

Adding a Printing Preset to Print Easily

If you create your own preset of frequently used print settings on the printer driver, you can print easily by selecting the preset from the list.

Printing

Windows

To add your own preset, set items such as the **Document Size** and **Paper Type** on the **Main** or **More Options** tab, and then click **Add/Remove Presets** in **Printing Presets**.

Note:

To delete an added preset, click **Add/Remove Presets**, select the preset name you want to delete from the list, and then delete it.

Mac OS X

Access the print dialog. To add your own preset, set items such as the **Paper Size** and **Media Type**, and then save the current settings as the preset in the **Presets** setting.

Note:

To delete an added preset, click **Presets > Show Presets**, select the preset name you want to delete from the list, and then delete it.

Printing a Reduced or Enlarged Document

You can reduce or enlarge the size of a document by a specific percentage.

Windows

Set the **Document Size** on the **More Options** tab. Select **Reduce/Enlarge Document**, **Zoom to**, and then enter a percentage.

Mac OS X

Note:

Operations differ depending on the application. See the application's help for details.

Select **Page Setup** (or **Print**) from the **File** menu. Select the printer from **Format For**, select the paper size, and then enter a percentage in **Scale**. Close the window, and then print following the basic printing instructions.

Related Information

➔ [“Printing Basics - Mac OS X” on page 66](#)

Adjusting the Print Color

You can adjust the colors used in the print job.

PhotoEnhance produces sharper images and more vivid colors by automatically adjusting the contrast, saturation, and brightness of the original image data.

Note:

These adjustments are not applied to the original data.

PhotoEnhance adjusts the color by analyzing the location of the subject. Therefore, if you have changed the location of the subject by reducing, enlarging, cropping, or rotating the image, the color may change unexpectedly. If the image is out of focus, the tone may be unnatural. If the color is changed or becomes unnatural, print in a mode other than **PhotoEnhance**.

Windows

Select the method of color correction from **Color Correction** on the **More Options** tab.

Printing

If you select **Automatic**, the colors are automatically adjusted to match the paper type and print quality settings. If you select **Custom** and click **Advanced**, you can make your own settings.

Mac OS X

Access the print dialog. Select **Color Matching** from the pop-up menu, and then select **EPSON Color Controls**. Select **Color Options** from the pop-up menu, and then select one of the available options. Click the arrow next to **Advanced Settings** and make the appropriate settings.

Printing an Anti-Copy Pattern (for Windows Only)

You can print documents with invisible letters such as "Copy". These letters appear when the document is photocopied so that the copies can be distinguished from the original. You can also add your own anti-copy pattern.

Note:

This feature is only available when the following settings are selected.

- Paper Type: plain papers
- Quality: Standard
- Auto 2-sided printing: Disabled
- Color Correction: Automatic
- Short Grain Paper: Disabled

Click **Watermark Features** on the **More Options** tab, and then select an anti-copy pattern. Click **Settings** to change details such as the size and density.

Printing a Watermark (for Windows Only)

You can print a watermark such as "Confidential" on your printouts. You can also add your own watermark.

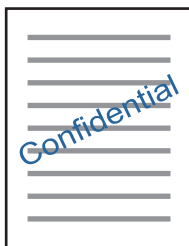

Click **Watermark Features** on the **More Options** tab, and then select a watermark. Click **Settings** to change details such as the density and position of the watermark.

Printing a Header and Footer (for Windows Only)

You can print information such as a user name and printing date as headers or footers.

Click **Watermark Features** in the **More Options** tab, and then select **Header/Footer**. Click **Settings** and select necessary items from the drop-down list.

Printing

Printing Photos Using Epson Easy Photo Print

Epson Easy Photo Print lets you lay out and print photos easily on various types of paper. See the application's help for details.

Note:

By printing on genuine Epson photo paper, the ink quality is maximized and the printouts are vivid and clear.

Related Information

➔ [“Epson Easy Photo Print” on page 163](#)

Printing from Smart Devices

Using Epson iPrint

Epson iPrint is an application that allows you to print photos, documents, and web pages from a smart device such as a smartphone or tablet. You can use local print, printing from a smart device that is connected to the same wireless network as your printer, or remote print, printing from a remote location over the Internet. To use remote print, register your printer in the Epson Connect service.



Related Information

➔ [“Epson Connect Service” on page 156](#)

Installing Epson iPrint

You can install Epson iPrint on your smart device from the following URL or QR code.

<http://ipr.to/c>



Printing Using Epson iPrint

Start Epson iPrint from your smart device and select the item you want to use from the home screen.

Printing

The following screens are subject to change without notice.

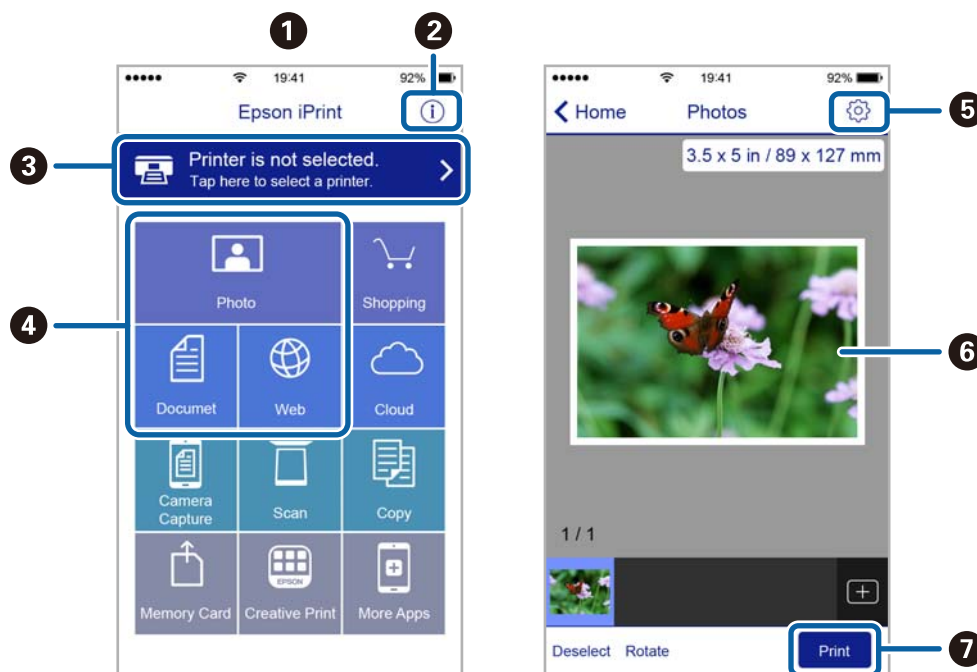

1	Home screen displayed when the application is started.
2	Displays information on how to setup the printer and a FAQ.
3	Displays the screen where you can select the printer and make printer settings. Once you have selected the printer, you do not need to select it again from the next time.
4	Select what you want to print such as photos, documents, and web pages.
5	Displays the screen to make print settings such as paper size and paper type.
6	Displays photos and documents you selected.
7	Starts printing.

Note:

To print from the document menu using iPhone, iPad, and iPod touch running iOS, start Epson iPrint after transferring the document you want to print using the file sharing function in iTunes.

Canceling Printing

Note:

- ❑ In Windows, you cannot cancel a print job from the computer once it has been completely sent to the printer. In this case, cancel the print job by using the printer's control panel.
- ❑ When printing several pages from Mac OS X, you cannot cancel all of the jobs by using the control panel. In this case, cancel the print job from the computer.
- ❑ If you have sent a print job from Mac OS X v10.6.8 through the network, you may not be able to cancel printing from the computer. In this case, cancel the print job by using the printer's control panel.

Canceling Printing - Printer Button

Press the  button to cancel the print job in progress.

Canceling Printing - Status Menu

1. Press the **i** button to display **Status Menu**.
2. Select **Job Monitor > Print Job**.
Ongoing jobs and jobs that are standing by are shown in the list.
3. Select the job that you want to cancel.
4. Press **Cancel**.

Canceling Printing - Windows

1. Access the printer driver window.
2. Select the **Maintenance** tab.
3. Click **Print Queue**.
4. Right-click on the job you want to cancel and then select **Cancel**.

Related Information

➔ [“Windows Printer Driver” on page 158](#)

Canceling Printing - Mac OS X

1. Click the printer icon in the **Dock**.
2. Select the job you want to cancel.
3. Cancel the job.
 - Mac OS X v10.8.x or later
Click  next to the progress meter.
 - Mac OS X v10.6.8 to v10.7.x
Click **Delete**.

Copying

1. Load paper in the printer.

When loading in the rear paper feed slot, do not load paper until the printer prompts you to do so.

**Important:**

Make the paper settings on the control panel.

2. Place the originals.

If you want to copy multiple originals or make 2-sided copies, place all of the originals on the ADF.

3. Enter **Copy** from the home screen.

4. Enter the number of copies by using the numeric keypad.

5. Press **Layout**, and then select the appropriate layout.

6. Make other settings as necessary. You can make detailed settings by pressing **Settings**.

Note:

Press **Preset** to save your settings as a preset.

Press **Preview** to preview the copy results. However, you cannot preview when you have placed the originals on the ADF.

7. Press the  button.

Related Information

- ➔ [“Loading Paper in the Paper Cassette” on page 45](#)
- ➔ [“Loading Paper in the Rear Paper Feed Slot” on page 48](#)
- ➔ [“Placing Originals” on page 52](#)
- ➔ [“Menu Options for Copy Mode” on page 85](#)

Menu Options for Copy Mode

Note:

Available menus vary depending on the layout you selected.

Number of copies

Enter the number of copies.

Layout

- With Border

Copies with margins around the edges.

- 2-up

Copies two single-sided originals onto a single sheet in 2-up layout.

Copying

4-up

Copies four single-sided originals onto a single sheet in 4-up layout.

ID Card

Scans both sides of an ID card and copies onto one side of A4 size paper.

Split Pages

Copies two facing pages of a booklet onto separate sheets of paper.

Document Size

Select the size of your original.

Zoom

Configures the magnification ratio of the enlargement or reduction.

Custom Size

Specifies the magnification used to enlarge or reduce the original within a range of 25 to 400%.

Actual Size

Copies at 100 % magnification.

Auto Fit Page

Detects the scan area and automatically enlarges or reduces the original to fit to the paper size you selected.

When there are white margins around the original, the white margins from the corner mark of the scanner glass are detected as the scan area, but the margins at the opposite side may be cropped.

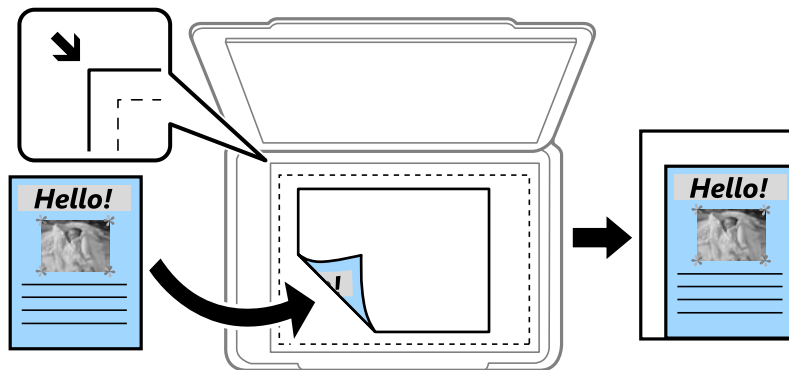

A3->A4 and others

Automatically enlarges or reduces the original to fit to a specific paper size.

Paper Source

Select the paper source that you want to use. Select **Auto** to feed paper automatically using the **Paper Setup** settings made when you loaded the paper. When you select Rear Paper Feed Slot, select the paper size and paper type you want to load in the rear paper feed slot.

2-Sided

Off

Copies one side of an original onto a single side of paper.

2>2-Sided

Copies both sides of a double-sided original onto both sides of a single sheet of paper.

Copying

1>2-Sided

Copies two single-sided originals onto both sides of a single sheet of paper. Press **Advanced** to configure the binding position of the paper.

2>1-Sided

Copies both sides of a double-sided original onto one side of two sheets of paper. Press **Advanced** to configure the binding position of your original.

Document Orientation

Select the orientation of your original.

Quality

Copies in optimal quality to match the type of original.

Density

Increase the level of density when the copying results are faint. Decrease the level of density when ink smears.

Layout Order

Select the copy layout for multiple pages when you have selected **2-up** or **4-up** as the **Layout** setting.

Scan Order

Select which page of a booklet to scan when you have selected **Split Pages** as the **Layout** setting.

Remove Shadow

Removes shadows that appear in the center of copies when copying a booklet or that appear around copies when copying thick paper.

Remove Punch Holes

Removes the binding holes when copying.

Collate Copy

Prints multiple copies of multiple originals collated in order and sorts them into sets.

Dry Time

Select the drying time for 2-sided copying. Increase the level of drying time when ink smears.

Scanning

Scanning Using the Control Panel

Scanning to an Email

You can send scanned image files by email directly from the printer through a pre-configured email server. Before using this feature, you need to configure the email server.

You can specify the email address by entering directly, but it may be easier if you register the email address in the contacts list first.

Note:

- Before you use this feature, make sure the printer's **Date/Time** and **Time Difference** settings are correct. Access the menus from **Setup > System Administration > Common Settings > Date/Time Settings**.
- Instead of this feature, you can select **Email** as a format when scanning to computer from the control panel. You can send an email by entering the address on a computer connected to this printer. When scanning to computer, make sure the computer is turned on.

1. Place the originals.

Note:

If you want to scan multiple originals or make 2-sided scans, place all of the originals in the ADF.

2. Enter **Scan** from the home screen.

3. Select **Email**.

4. Enter the email addresses.

To select from the contacts list: Press **Contacts**, select a contact, and then press **Proceed**.

To enter the email address manually: Select **Enter Email Address > Enter Email Address**, enter the email address, and then press the enter key at the bottom-right of the screen.

Note:

You can send emails to up to 10 individual email addresses and groups.

5. Press **Format**, and then select the file format.

6. Press **Menu**, and then make settings for **Email Settings** and **Basic Settings**.

Note:

You can specify the maximum size for files that can be attached to an email in **Attached File Max Size**.

When you select **PDF** as the file format, you can set a password to protect the file. Select **PDF Settings**, and then make settings.

Press **Preset** to save your settings as a preset.

7. Press the  button.

Related Information

➔ [“Configuring an Email Server” on page 225](#)

Scanning

- ➔ [“Managing Contacts” on page 58](#)
- ➔ [“Scanning to a Computer” on page 93](#)
- ➔ [“Placing Originals” on page 52](#)
- ➔ [“Presets Mode” on page 21](#)
- ➔ [“Common Menu Options for Scanning” on page 96](#)

Menu Options for Scanning to an Email

Contacts

Select email addresses to send the scanned image from the contacts list.

Format

Select the format in which to save the scanned image. When you select **TIFF (Single Page)** or **TIFF (Multi Page)**, only monochrome scanning is available.

Menu

Email Settings

Subject:

Enter a subject for the email in alphanumeric characters and symbols.

Filename Prefix:

Enter a prefix for the name of the images in alphanumeric characters and symbols.

Basic Settings

Set the scan settings for the originals. See the common setting menus in scanning for more details.

Scan Report

Prints a history that shows when and to which email address scanned images have been sent.

Related Information

- ➔ [“Common Menu Options for Scanning” on page 96](#)

Scanning to a Network Folder or FTP Server

You can save the scanned image to a specified folder on a network. You can specify the folder by entering a folder path directly, but it may be easier if you register the folder information in the contacts list first.

Note:

Before you use this feature, make sure the printer's **Date/Time** and **Time Difference** settings are correct. Access the menus from **Setup > System Administration > Common Settings > Date/Time Settings**.

1. Place the originals.

Note:

If you want to scan multiple originals or make a 2-sided scan, place all of the originals on the ADF.

2. Enter **Scan** from the home screen.

Scanning

3. Select **Network Folder/FTP**.
4. Specify the folder.
 - To select from the contacts list: Press **Contacts**, select a contact, and then press **Proceed**.
 - To enter the folder path directly: Press **Enter Location**. Select **Communication Mode**, enter the folder path as **Location**, and then make other folder settings.

Note:

Enter the folder path in the following format.

When using SMB as the communication mode:

\\host name\folder name

When using FTP as the communication mode:

ftp://host name/folder name

5. Press **Format**, and then select the file format.
6. Press **Menu**, and then make settings for **File Settings** and **Basic Settings**.

Note:

- When you select PDF as the file format, you can set a password to protect the file. Select **Basic Settings > PDF Settings**, and then make settings.
- Press **Preset** to save your settings as a preset.

7. Press the  button.

Related Information

- ➔ [“Managing Contacts” on page 58](#)
- ➔ [“Placing Originals” on page 52](#)
- ➔ [“Presets Mode” on page 21](#)
- ➔ [“Common Menu Options for Scanning” on page 96](#)

Menu Options for Network Folder or FTP Server

Contacts

Select a folder in which to save the scanned image from the contacts list. You do not need to make location settings when you have selected a folder from the contacts list.

Location

- Communication Mode
 - Select the communication mode.
- Location
 - Enter a folder path in which to save the scanned image.
- User Name
 - Enter a user name for the specified folder.
- Password

Scanning

Enter a password for the specified folder.

Connection Mode

Select the connection mode.

Port Number

Enter a port number.

Format

Select the format in which to save the scanned image. When you select **TIFF (Multi Page)**, only monochrome scanning is available.

Menu

File Settings

Enter a prefix for the name of the images in **Filename Prefix** in alphanumeric characters and symbols.

Basic Settings

Set the scan settings for the originals. See the common setting menus in scanning for more details.

Scan Report

Prints a history that shows when and to which folder the scanned images have been sent.

Related Information

➔ [“Common Menu Options for Scanning” on page 96](#)

Scanning to a Memory Device

You can save the scanned image to a memory device.

1. Insert a memory device into the printer's memory card slot or external interface USB port.

2. Place the originals.

Note:

If you want to scan multiple originals or make a 2-sided scan, place all of the originals on the ADF.

3. Enter **Scan** from the home screen.

4. Select **Memory Device**.

5. Press **Format**, and then select the file save format.

6. Press **Settings**, and then make scan settings.

Note:

*When you select PDF as the file format, you can set a password to protect the file. Select **PDF Settings**, and then make settings.*

*Press **Preset** to save your settings as a preset.*

7. Press the  button.

Scanning

Related Information

- ➔ “Part Names and Functions” on page 15
- ➔ “Placing Originals” on page 52
- ➔ “Presets Mode” on page 21
- ➔ “Common Menu Options for Scanning” on page 96

Menu Options for Scanning to a Memory Device

Format

Select the format in which to save the scanned image. When you select **TIFF (Multi Page)** only monochrome scanning is available.

Settings

Set the scan settings for the originals. See the common setting menus in scanning for more details.

Related Information

- ➔ “Common Menu Options for Scanning” on page 96

Scanning to the Cloud

You can send scanned images to cloud services. Before using this feature, make settings using Epson Connect. See the following Epson Connect portal website for details.

<https://www.epsonconnect.com/>

<http://www.epsonconnect.eu> (Europe only)

1. Make sure that you have made settings using Epson Connect.
2. Place the originals.

Note:

If you want to scan multiple originals or make a 2-sided scan, place all of the originals on the ADF.

3. Enter **Scan** from the home screen.
4. Select **Cloud**.
5. Select a destination.
6. Press **Format**, and then select the file save format.
7. Press **Settings**, and then make scan settings.

Note:

*Press **Preset** to save your settings as a preset.*

8. Press the  button.

Related Information

- ➔ “Placing Originals” on page 52

Scanning

➔ [“Common Menu Options for Scanning” on page 96](#)

Menu Options for Scanning to the Cloud

Format

Select the format in which to save the scanned image.

Settings

Set the scan settings for the originals. See the common setting menus in scanning for more details.

Related Information

➔ [“Common Menu Options for Scanning” on page 96](#)

Scanning to a Computer

You can save the scanned image to a computer.



Important:

Make sure you have installed Epson Scan 2 and Epson Event Manager on your computer before using this feature.

1. Place the originals.

Note:

If you want to scan multiple originals or make a 2-sided scan, place all of the originals on the ADF.

2. Enter **Scan** from the home screen.
3. Select **Computer**.
4. Select a computer on which to save the scanned images.

Note:

You can change the scan settings such as the scanning size, folder to save, or save format, by using Epson Event Manager.

When the printer is connected to a network, you can select the computer to which you want to save the scanned image. Up to 20 computers can be displayed on the printer's control panel.

When the computer to which you want to save the scanned images is detected on the network, the initial 15 characters of the computer name are displayed on the control panel. If you set **Network Scan Name (Alphanumeric)** in Epson Event Manager, it is displayed on the control panel.

5. Press **Format**, and then select the file format.

Note:

*When **Email** is selected, you can attach the scanned image to an email.*

6. Set the **Scan Area** and the **2-Sided** settings if necessary.

Note:

*Press **Preset** to save your settings as a preset.*

7. Press the  button.

Related Information

- ➔ [“Placing Originals” on page 52](#)
- ➔ [“Common Menu Options for Scanning” on page 96](#)

Menu Options for Scanning to a Computer**2-Sided**

Scans both sides of the original.

Scan Area

Select the scan area. To use the settings in Epson Event Manager, select **Defined by Event Manager**.

Format

Select the format in which to save the scanned image.

Scanning to a Computer (WSD)**Note:**

- This feature is only available for computers running Windows 10/Windows 8.1/Windows 8/Windows 7/Windows Vista.*
- If you are using Windows 7/Windows Vista, you need to setup your computer in advance using this feature.*

1. Place the originals.

Note:

If you want to scan multiple originals, place all of the originals on the ADF.

2. Enter **Scan** from the home screen.
3. Select **Computer (WSD)**.
4. Select a computer.
5. Press the  button.

Related Information

- ➔ [“Placing Originals” on page 52](#)

Setting Up a WSD Port

This section explains how to set up a WSD port for Windows 7/Windows Vista.

Note:

For Windows 10/Windows 8.1/Windows 8, the WSD port is set up automatically.

The following is necessary to set up a WSD port.

- The printer and the computer are connected to the network.
- The printer driver is installed on the computer.

1. Turn the printer on.

Scanning

2. Click start, and then click **Network** on the computer.
3. Right-click the printer, and then click **Install**.
Click **Continue** when the **User Account Control** screen is displayed.
Click **Uninstall** and start again if the **Uninstall** screen is displayed.

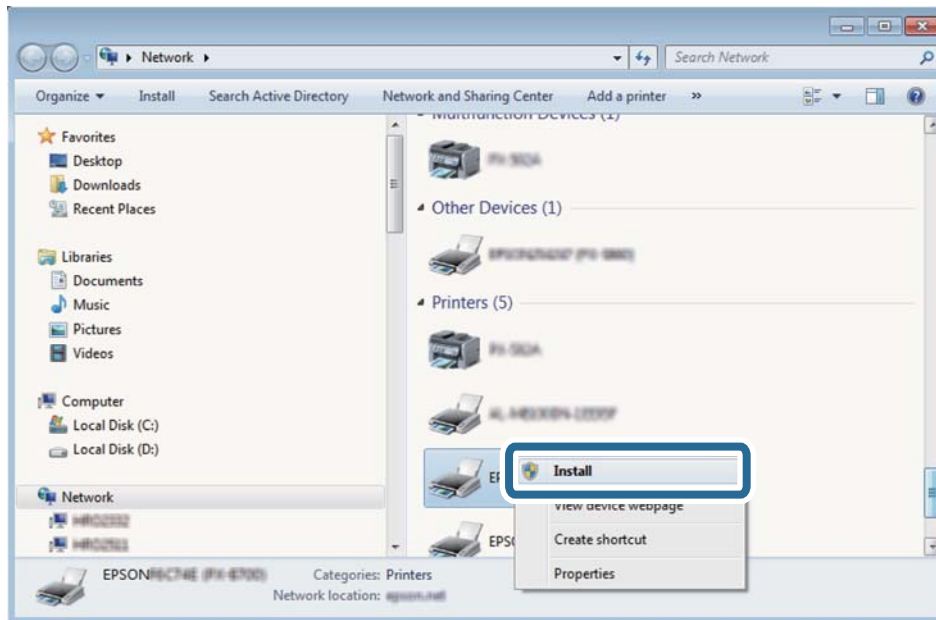

Note:

The printer name you set on the network and model name (EPSON XXXXXX (XX-XXXX)) are displayed on the network screen. You can check the printer's name set on the network from the printer's control panel or by printing a network status sheet.

4. Click **Your device is ready to use**.

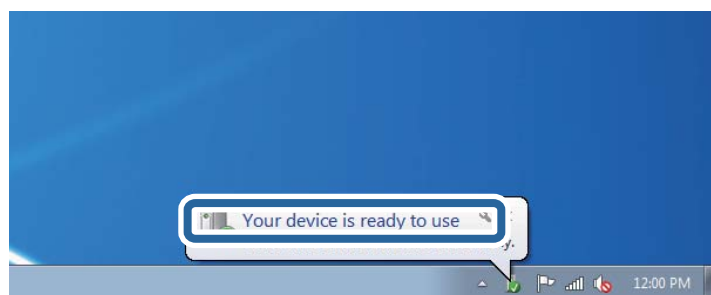

5. Check the message, and then click **Close**.



Scanning

6. Open the **Devices and Printers** screen.
 - Windows 7
Click start > **Control Panel** > **Hardware and Sound** (or **Hardware**) > **Devices and Printers**.
 - Windows Vista
Click start > **Control Panel** > **Hardware and Sound** > **Printers**.
7. Check that an icon with the printer's name on the network is displayed.
Select the printer name when using with WSD.

Related Information

➔ [“Printing a Network Status Sheet” on page 37](#)

Common Menu Options for Scanning

The following menus are available when you select **Menu** > **Basic Settings**, or select **Settings** in each scanning menu.

Note:

Available menus vary depending on the destination type, such as email or folder, and the format in which scanned images are saved.

Resolution

Select the scanning resolution.

Scan Area

Select the scan area. To crop the white space around the text or image when scanning, select **Auto Cropping**. To scan at the maximum area of the scanner glass, select **Max Area**.

2-Sided

Scans both sides of the original. When performing 2-sided scanning, select **Binding Direction** and then select the binding position of the original.

Document Type

Select the type of your original.

Density

Select the contrast of the scanned image.

Document Orientation

Select the orientation of your original.

Compression Ratio

Select how much to compress the scanned image.

PDF Settings

When you have selected **PDF** as the save format setting, use these settings to protect PDF files.

- Document Open Password

Scanning

Creates a PDF file that requires a password when opening.

- Permissions Password

Creates a PDF file that requires a password when printing or editing.

Attached File Max Size

Select the maximum file size that can be attached to the email.

Scanning from a Computer

Scanning Using Epson Scan 2

You can scan using the scanner driver "Epson Scan 2". You can scan originals using detailed settings that are suitable for text documents.

See the Epson Scan 2 help for an explanation of each setting item.

1. Place the original.

Note:

If you want to scan multiple originals, place them in the ADF.

2. Start Epson Scan 2.

Scanning

3. Make the following settings on the **Main Settings** tab.

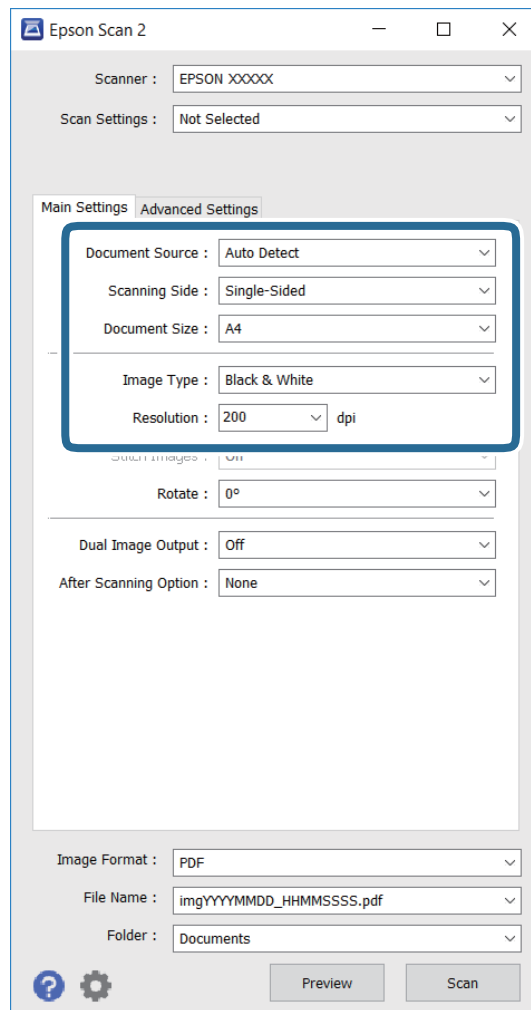

- ❑ **Document Source:** Select the source where the original is placed.
 - ❑ **Scanning Side:** Select the side of the original you want to scan when scanning from ADF.
 - ❑ **Document Size:** Select the size of the original you placed.
 - ❑ **Image Type:** Select the color for saving the scanned image.
 - ❑ **Resolution:** Select the resolution.
4. Make other scan settings if necessary.
- ❑ You can preview the scanned image by clicking the **Preview** button. The preview window opens, and the previewed image is displayed.
When you preview using the ADF, the original is ejected from the ADF. Place the ejected original again.
 - ❑ On the **Advanced Settings** tab, you can make detailed image adjustment settings that are suitable for text documents, such as the following.
 - ❑ **Unsharp Mask:** You can enhance and sharpen the outlines of the image.
 - ❑ **Descreening:** You can remove moiré patterns (web-like shadows) that appear when scanning printed papers such as a magazine.
 - ❑ **Text Enhancement:** You can make blurred letters in the original clear and sharp.

Scanning

- ❑ **Auto Area Segmentation:** You can make letters clear and images smooth when performing black and white scanning for a document that contains images.

Note:

The items may not be available depending on other settings you made.

5. Set the file saving settings.

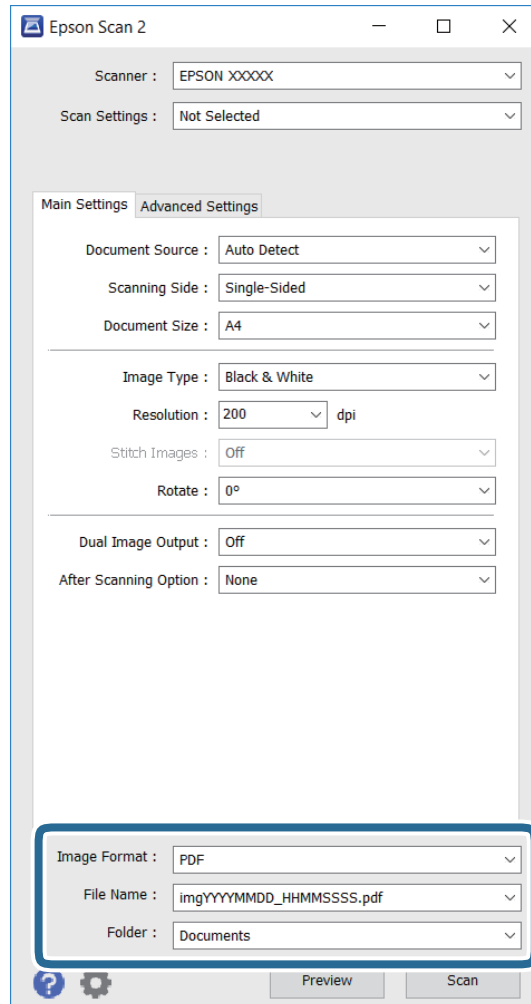

- ❑ **Image Format:** Select the save format from the list.
You can make detailed settings for each save format except BITMAP and PNG. Select **Options** from the list after selecting the save format.
- ❑ **File Name:** Confirm the save file name displayed.
You can change settings for the file name by selecting **Settings** from the list.
- ❑ **Folder:** Select the save folder for the scanned image from the list.
You can select another folder or create a new folder by selecting **Select** from the list.

6. Click **Scan**.

Related Information

- ➔ [“Placing Originals” on page 52](#)
- ➔ [“Epson Scan 2 \(Scanner Driver\)” on page 161](#)

Scanning from Smart Devices

Epson iPrint is an application that allows you to scan photos and documents from a smart device, such as a smartphone or tablet, that is connected to the same wireless network as your printer. You can save the scanned data on a smart device or to Cloud services, send it by email, or print it.



Installing Epson iPrint

You can install Epson iPrint on your smart device from the following URL or QR code.

<http://ipr.to/c>



Scanning Using Epson iPrint

Start Epson iPrint from your smart device and select the item you want to use from the home screen.

The following screens are subject to change without notice.



Scanning

①	Home screen displayed when the application is started.
②	Displays information on how to setup the printer and a FAQ.
③	Displays the screen where you can select the printer and make printer settings. Once you have selected the printer, you do not need to select it again from the next time.
④	Displays the scanning screen.
⑤	Displays the screen where you can make scan settings such as resolution.
⑥	Displays scanned images.
⑦	Starts scanning.
⑧	Displays the screen where you can save scanned data to a smart device or Cloud services.
⑨	Displays the screen where you can send scanned data by email.
⑩	Displays the screen where you can print scanned data.

Faxing

Setting Up a Fax

Connecting to a Phone Line

Compatible Telephone Lines

You can use the printer over standard analogue telephone lines (PSTN = Public Switched Telephone Network) and PBX (Private Branch Exchange) telephone systems.

You may not be able to use the printer with the following phone lines or systems.

- VoIP phone line such as DSL or fiber-optic digital service
- Digital phone line (ISDN)
- Some PBX telephone systems
- When adapters such as terminal adapters, VoIP adapters, splitters, or DSL router are connected between the telephone wall jack and the printer

Connecting the Printer to a Phone Line

Connect the printer to a telephone wall jack using an RJ-11 (6P2C) phone cable. When connecting a telephone to the printer, use a second RJ-11 (6P2C) phone cable.

Depending on the area, a phone cable may be included with the printer. If it is included, use that cable.

You may need to connect the phone cable to an adapter provided for your country or region.

 **Important:**

Remove the cap from the EXT. port of the printer only when connecting your telephone to the printer. Do not remove the cap if you are not connecting your telephone.

In areas where lightning strikes occur frequently, we recommend that you use a surge protector.

Faxing

Connecting to a Standard Phone Line (PSTN) or PBX

Connect a phone cable from the telephone wall jack or PBX port to the LINE port on the back of the printer.

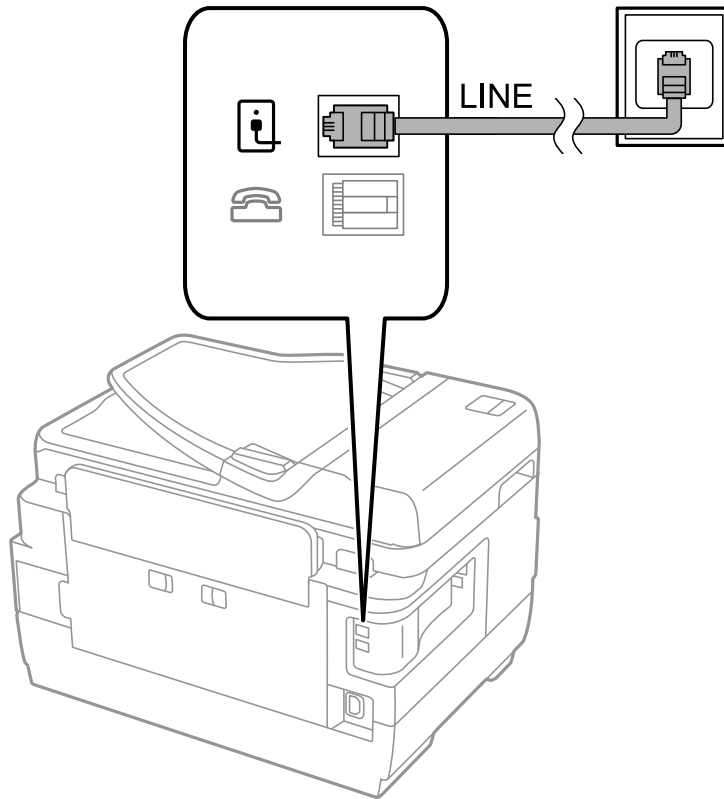

Related Information

➔ [“Making Settings for a PBX Phone System” on page 107](#)

Connecting to DSL or ISDN

Connect a phone cable from the DSL modem or the ISDN terminal adapter to the LINE port on the back of the printer. See the documentation provided with the modem or the adapter for more details.

Faxing

Note:

If your DSL modem is not equipped with a built-in DSL filter, connect a separate DSL filter.

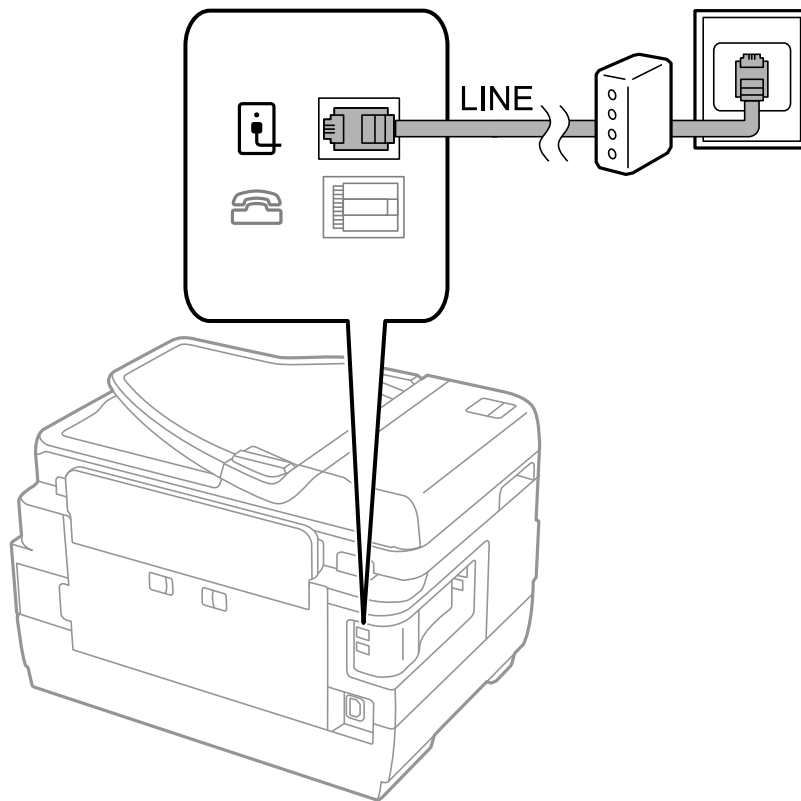

Connecting Your Phone Device to the Printer

When using the printer and your telephone on a single phone line, connect the telephone to the printer.

Note:

- If your phone device has a fax function, disable the fax function before connecting. See the manuals that came with the phone device for details.
- If you connect an answering machine, make sure the printer's **Rings to Answer** setting is set higher than the number of rings your answering machine is set to answer a call.

Faxing

1. Remove the cap from the EXT. port on the back of the printer.

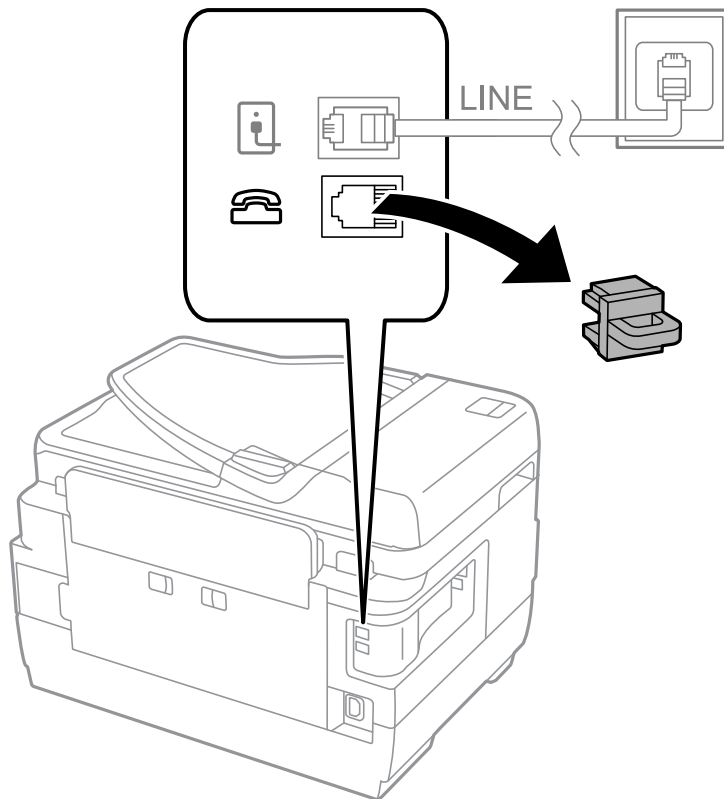

2. Connect the phone device and the EXT. port with a phone cable.

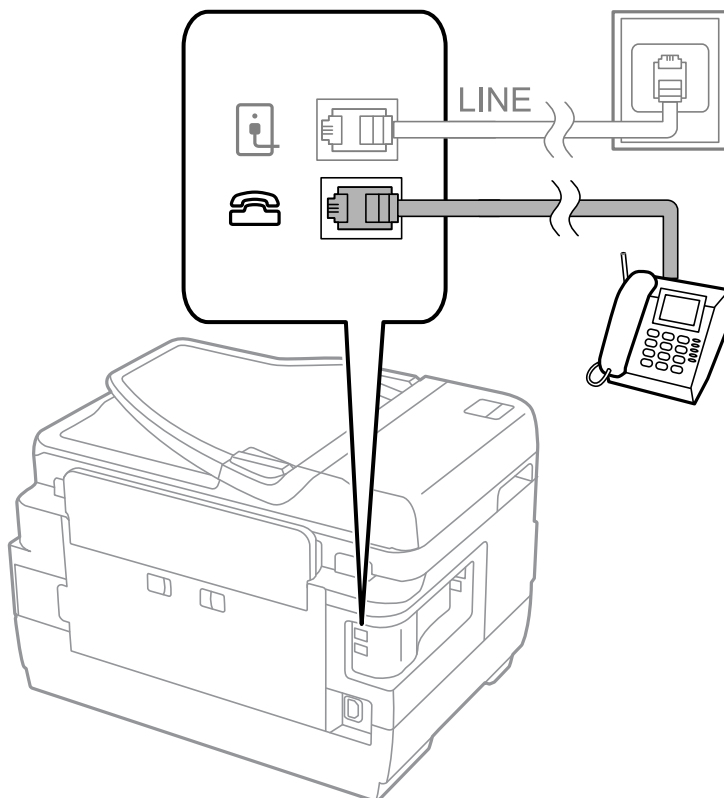

Faxing



Important:

When sharing a single phone line, make sure you connect the phone device to the EXT. port of the printer. If you split the line to connect the phone device and the printer separately, the phone and the printer do not work correctly.

- Pick up the handset of the connected phone device and confirm that the [The phone line is in use.] message is displayed on the LCD screen.

If the message is not displayed, check that the phone cable is securely connected to the EXT. port.

Related Information

➔ [“Settings for the Answering Machine” on page 114](#)

Making Basic Fax Settings

First make basic fax settings such as **Receive Mode** using the **Fax Setting Wizard**, and then configure the other settings as necessary.

The **Fax Setting Wizard** is automatically displayed when the printer is turned on for the first time. Once you have made the settings, you do not need to make them again unless the connection environment is changed.

If an administrator has locked the settings, only the administrator can make the settings.

Making Basic Fax Settings Using the Fax Setting Wizard

Make basic settings by following the on-screen instructions.

- Connect the printer to the phone line.



Important:

Because an automatic fax connection check runs at the end of the wizard, make sure you connect the printer to the phone line before starting the wizard.

- Enter **Setup** from the home screen.
- Select **System Administration > Fax Settings > Fax Setting Wizard**, and then press **Start**.

The wizard begins.

- On the fax header entry screen, enter your sender name such as your company name.



Note:

Your sender name and your fax number appear as the header for outgoing faxes.

- On the phone number entry screen, enter your fax number.
- On the **DRD Setting** screen, make the following settings.
 - If you have subscribed to a distinctive ring service from your telephone company: Press **Proceed**, select the ring pattern to be used for incoming faxes, and then go to step 9. **Receive Mode** is automatically set to **Auto**.
 - If you do not need to set this option: Press **Skip**, and then go to the next step.

Faxing

Note:

- Distinctive ring services, offered by many telephone companies (the service name differs by company), allows you to have several phone numbers on one phone line. Each number is assigned a different ring pattern. You can use one number for voice calls and another for fax calls. Select the ring pattern assigned to fax calls in **DRD**.*
 - Depending on the region, **On** and **Off** are displayed as the **DRD** options. Select **On** to use the distinctive ring feature.*
7. On the **Receive Mode Setting** screen, select whether you are using your phone device connected to the printer.
 - When connected: Press **Yes**, and go to the next step.
 - When not connected: Press **No** and go to step 9. **Receive Mode** is set to **Auto**.
 8. On the **Receive Mode Setting** screen, select whether you want to receive faxes automatically.
 - To receive automatically: Press **Yes**. **Receive Mode** is set to **Auto**.
 - To receive manually: Press **No**. **Receive Mode** is set to **Manual**.
 9. On the **Confirm Settings** screen, check the settings you made, and then press **Proceed**.
To correct or change settings, press the  button.
 10. Press **Start** to run the fax connection check, and when the screen prompts you to print the check result, press the  button.
A report of the check result that shows the connection status is printed.

Note:

- If there are any errors reported, follow the instructions on the report to solve them.*
- If the **Select Line Type** screen is displayed, select the line type. When you are connecting the printer to a PBX phone system or terminal adapter, select **PBX**.*
- If the **Select Dial Tone Detection** screen is displayed, select **Disable**.
However, setting this to **Disable** may cause the printer to skip the first digit of a fax number when dialing and send the fax to the wrong number.*

Related Information

- ➔ [“Connecting the Printer to a Phone Line” on page 102](#)
- ➔ [“Setting Receiving Mode” on page 114](#)
- ➔ [“Making Settings for a PBX Phone System” on page 107](#)
- ➔ [“Fax Settings Options” on page 126](#)

Making Basic Fax Settings Individually

You can make fax settings without using the fax setting wizard by selecting each setting menu individually. The settings configured using the wizard can also be changed. For more details, see the list of menus in fax settings.

Related Information

- ➔ [“Fax Settings Options” on page 126](#)

Making Settings for a PBX Phone System

Make the following settings when using the printer in offices that use extensions and require external access codes, such as 0 and 9, to get an outside line.

Faxing

1. Enter **Setup** from the home screen.
2. Select **System Administration > Fax Settings > Basic Settings > Line Type**.
3. Select **PBX**.
4. On the **Access Code** screen, select **Use**.
5. Press the **Access Code** field, enter the external access code used for your phone system, and then press the enter key at the bottom-right of the screen.

The access code is stored in the printer. When sending a fax to an outside fax number, enter # (hash) instead of the actual access code.

Note:

When # (hash) is entered at the beginning of the fax number, the printer replaces the # with the stored access code when dialing. Using # helps avoid connection problems when connecting to an outside line.

Making Paper Source Settings to Receive Faxes

You can set the printer so that specific paper sources are not used for printing received documents and fax reports. By default, all of the paper sources are enabled for fax printing. Use this feature if you do not want to use paper in a specific paper source for fax printing.

1. Enter **Setup** from the home screen.
2. Select **System Administration > Printer Settings > Paper Source Settings > Auto Select Settings > Fax**.
3. Select the paper source that you do not want to use for printing faxes, and then disable it.

Sending Faxes

Basic Fax Sending Operations

Send faxes in color or monochrome (B&W). When sending a fax in monochrome, you can preview the scanned image on the LCD screen before sending.

Note:

- If the fax number is busy or there is some problem, the printer automatically redials after one minute.*
- You can reserve up to 50 monochrome fax jobs even while the phone line is in use for a voice call, sending another fax, or receiving a fax. You can check or cancel reserved fax jobs from **Job Monitor** in **Status Menu**.*
- If you have enabled the **Save Failure Data** feature, failed faxes are saved, and you can resend them from **Job Monitor** in **Status Menu**.*

Sending Faxes Using the Control Panel

1. Place the originals.

Note:

You can send up to 100 pages in one transmission; however depending on the remaining amount of memory, you may not be able to send faxes even with less than 100 pages.

2. Enter **Fax** from the home screen.

Faxing

3. Specify the recipient.

- To enter manually: Enter numbers using the numerical keypad on the control panel or the LCD screen, and then press the enter key at the bottom-right of the screen.
- To select from the contacts list: Press **Contacts**, press the check box to add a check mark to a contact, and then press **Proceed**.
- To select from the sent fax history: Press **History**, select a recipient, and then press **Menu > Send to this number**.

Note:



- You can send the same monochrome fax to up to 200 recipients. A color fax can only be sent to one recipient at a time.
- To add a pause (pause for three seconds) during dialing, enter a hyphen by pressing .
- When **Direct Dialing Restrictions** in **Security Settings** is enabled, you can only select fax recipients from the contacts list or the sent fax history. You cannot manually enter a fax number.
- If you set an external access code in **Line Type**, enter "#" (hash) instead of the actual external access code at the beginning of the fax number.
- To delete recipients you entered, display the list of recipients by pressing the field on the screen that shows a fax number or the number of recipients, select the recipient from the list, and then select **Delete from the List**.

4. Press **Menu**, select **Fax Send Settings**, and then make settings such as the resolution and the sending method as necessary.

Note:

- To send 2-sided originals, enable **ADF 2-Sided**. However, you cannot send in color with this setting.
- Press **Preset** on the fax top screen to save the current settings and the recipients in **Preset**. Recipients may not be saved depending on how you specified the recipients, such as entering a fax number manually.

5. When sending a monochrome fax, press **Preview** on the fax top screen to check the scanned document.

- : Moves the screen in the direction of the arrows.
- : Reduces or enlarges.
- : Moves to the previous or the next page.
- Retry: Cancels the preview.
- View: Displays or hides the operation icons.

Note:

- You cannot send the fax in color after previewing.
- When **Direct Send** is enabled, you cannot preview.
- When the preview screen is left untouched for 20 seconds, the fax is sent automatically.
- The image quality of a sent fax may be different from what you previewed depending on the capability of the recipient machine.

6. Press the button.

Note:

- To cancel sending, press the  button.
- It takes longer to send a fax in color because the printer performs scanning and sending simultaneously. While the printer is sending a color fax, you cannot use the other features.

Faxing

Related Information

- ➔ [“Placing Originals” on page 52](#)
- ➔ [“Menu Options for Fax Mode” on page 124](#)
- ➔ [“Checking Fax Jobs” on page 122](#)
- ➔ [“Managing Contacts” on page 58](#)
- ➔ [“Presets Mode” on page 21](#)

Sending Faxes Dialing from the External Phone Device

You can send a fax by dialing using the connected telephone when you want to talk over the phone before sending a fax, or when the recipient's fax machine does not switch to the fax automatically.

1. Place the originals.

Note:

You can send up to 100 pages in one transmission.

2. Pick up the handset of the connected telephone, and then dial the recipient's fax number using the phone.
3. Press **Start Fax** on the printer's control panel, and then press **Send**.
4. Press **Menu**, select **Fax Send Settings**, and then make settings such as the resolution and the sending method as necessary.
5. When you hear a fax tone, press the  button, and then hang up the handset.

Note:

When a number is dialed using the connected telephone, it takes longer to send a fax because the printer performs scanning and sending simultaneously. While sending the fax, you cannot use the other features.

Related Information

- ➔ [“Placing Originals” on page 52](#)
- ➔ [“Menu Options for Fax Mode” on page 124](#)

Various Ways of Sending Faxes

Sending Faxes After Confirming the Recipient's Status

You can send a fax while listening to sounds or voices through the printer's speaker while dialing, communicating, and transmitting. You can also use this feature when you want to receive a fax from a fax polling service by following audio guidance.

1. Place the originals.
2. Enter **Fax** from the home screen.
3. Press **On Hook**.

Note:

You can adjust the sound volume of the speaker.

Faxing

- Specify the recipient.
- When you hear a fax tone, press **Send/Receive**, and then press **Send**.

Note:

When receiving a fax from a fax polling service, and you hear the audio guidance, follow the guidance to make the printer operations.

- Press the  button.

Related Information

- ➔ [“Sending Faxes Using the Control Panel” on page 108](#)
- ➔ [“Receiving Faxes by Polling \(Polling Receive\)” on page 116](#)
- ➔ [“Placing Originals” on page 52](#)
- ➔ [“Menu Options for Fax Mode” on page 124](#)

Sending Faxes at a Specified Time (Send Fax Later)

You can set to send a fax at a specified time. Only monochrome faxes can be sent when the time to send is specified.

- Place the originals.
- Enter **Fax** from the home screen.
- Specify the recipient.
- Press **Menu**, and then select **Send Fax Later**.
- Press **On**, enter the time to send the fax, and then press **OK**.
- Press **Menu**, select **Fax Send Settings**, and then make settings such as the resolution and the sending method as necessary.
- Press the  (B&W) button.

Note:

*To cancel the fax, cancel it from **Job Monitor** in **Status Menu**.*

Related Information

- ➔ [“Sending Faxes Using the Control Panel” on page 108](#)
- ➔ [“Placing Originals” on page 52](#)
- ➔ [“Menu Options for Fax Mode” on page 124](#)
- ➔ [“Checking Fax Jobs” on page 122](#)

Storing a Fax Without Specifying a Recipient (Store Fax Data)

You can store up to 100 pages of a single document in monochrome. This allows you to save the time spent scanning the document when you need to send the same document frequently.

Faxing

1. Place the originals.
2. Enter **Fax** from the home screen.
3. Press **Menu**, select **Store Fax Data**, and then enable the function.
4. Press **Menu**, select **Fax Send Settings**, and then make settings such as the resolution and the sending method as necessary.
5. Press the  (B&W) button.

To send or delete the stored document, press the **i** button to display **Status Menu**, select **Job Monitor > Communication Job**, select the document, and then follow the on-screen instructions.

Related Information

- ➔ [“Sending Faxes Using the Control Panel” on page 108](#)
- ➔ [“Placing Originals” on page 52](#)
- ➔ [“Menu Options for Fax Mode” on page 124](#)
- ➔ [“Checking Fax Jobs” on page 122](#)

Sending Faxes on Demand (Polling Send)

You can store up to 100 pages of a single document in monochrome for polling fax. The stored document is sent upon request from another fax machine that has a polling receive feature.

1. Place the originals.
2. Enter **Fax** from the home screen.
3. Press **Menu**, select **Polling Send**, and then enable the function.
4. Press **Menu**, select **Fax Send Settings**, and then make settings such as the resolution and the sending method as necessary.
5. Press the  (B&W) button.

To delete the stored document, press the **i** button to display **Status Menu**, select **Job Monitor > Communication Job**, select the document to delete, and then select **Delete**.

Related Information

- ➔ [“Sending Faxes Using the Control Panel” on page 108](#)
- ➔ [“Placing Originals” on page 52](#)
- ➔ [“Menu Options for Fax Mode” on page 124](#)
- ➔ [“Checking Fax Jobs” on page 122](#)

Sending Many Pages of a Monochrome Document (Direct Send)

When sending a fax in monochrome, the scanned document is temporarily stored in the printer's memory. Therefore, sending a lot of pages may cause the printer to run out of memory and stop sending the fax. You can

Faxing

avoid this by enabling the **Direct Send** feature, however, it takes longer to send the fax because the printer performs scanning and sending simultaneously. You can use this feature when there is only one recipient.

From the home screen, select **Fax > Menu > Fax Send Settings > Direct Send > On**.

Sending a Fax Preferentially (Priority Send)

You can send an urgent document ahead of the other faxes waiting to be sent.

From the home screen, select **Fax > Menu > Fax Send Settings > Priority Send > On**.

Note:

You cannot send your document preferentially while one of the following is in progress because the printer cannot accept another fax.

- Sending a monochrome fax with Direct Send enabled*
- Sending a color fax*
- Sending a fax using a connected telephone*
- Sending a fax sent from the computer*

Sending Different Size Documents Using ADF (Continuous Scan from ADF)

If you place different sized originals in the ADF, all of the originals are sent at the largest size among them. You can send them in their original sizes by sorting and placing them by size, or placing them one by one.

Before placing originals, select **Fax > Menu > Fax Send Settings > Continuous Scan from ADF > On** from the home screen. Follow the on-screen instructions to place originals.

The printer stores the scanned documents, and sends as one document.

Note:

If you leave the printer untouched for 20 seconds after prompted to set the next originals, the printer stops storing and starts sending the document.

Sending Multiple Faxes to the Same Recipient at Once (Batch Send)

If there are multiple faxes waiting to be sent to the same recipient, you can set the printer to group them together to send them at once. Up to 5 documents (up to 100 pages in total) can be sent at one time. This helps you save on connection fees by reducing the number of transmission times.

From the home screen, select **Setup > System Administration > Fax Settings > Send Settings > Batch Send > On**.

Note:

- Scheduled faxes are also grouped together when the recipient and the time to send the fax match.*
- Batch Send** is not applied to the following fax jobs.
 - Monochrome fax with **Priority Send** enabled*
 - Monochrome fax with **Direct Send** enabled*
 - Color faxes*
 - Faxes sent from the computer*

Sending a Fax from a Computer

You can send faxes from the computer by using the FAX Utility and PC-FAX driver. See the help of FAX Utility and PC-FAX driver for the operating instructions.

Related Information

- ➔ [“PC-FAX Driver \(Fax Driver\)” on page 162](#)
- ➔ [“FAX Utility” on page 162](#)

Receiving Faxes

Setting Receiving Mode

You can set **Receive Mode** using the **Fax Setting Wizard**. When you set up the fax feature for the first time, we recommend using the **Fax Setting Wizard**. If you want to change the **Receive Mode** settings individually, follow the steps below.

1. Enter **Setup** from the home screen.
2. Select **System Administration > Fax Settings > Receive Settings > Receive Mode**.
3. Select how to receive.
 - Auto**: Recommended for heavy fax users. The printer automatically receives a fax after the number of rings you specified.

**Important:**

*When you do not connect a telephone to the printer, select the **Auto** mode.*

- Manual**: Recommended for users who do not fax often, or who want to receive a fax after answering calls with the connected telephone. When receiving a fax, pick up the handset, and then operate the printer.

Note:

*If you enable the **Remote Receive** feature, you can start receiving a fax just by using the connected telephone.*

Related Information

- ➔ [“Making Basic Fax Settings Using the Fax Setting Wizard” on page 106](#)
- ➔ [“Receiving Faxes Manually” on page 115](#)
- ➔ [“Receiving Faxes Using a Connected Telephone \(Remote Receive\)” on page 115](#)

Settings for the Answering Machine

You need settings to use an answering machine.

- Set the **Receive Mode** of the printer to **Auto**.
- Set the **Rings to Answer** setting of the printer to a higher number than the number of rings for the answering machine. Otherwise, the answering machine cannot receive voice calls to record voice messages. See the manuals that came with the answering machine for its settings.

The **Rings to Answer** setting may not be displayed depending on the region.

Related Information

- ➔ [“Receive Settings” on page 127](#)

Various Ways of Receiving Faxes

Receiving Faxes Manually

When you connect a telephone and set the **Receive Mode** setting of the printer to **Manual**, follow the steps below to receive faxes.

1. When the telephone rings, pick up the handset.
2. When you hear a fax tone, press **Start Fax** on the LCD screen of the printer.

Note:

*If you enable the **Remote Receive** feature, you can start receiving a fax just by using the connected telephone.*

3. Press **Receive**.
4. Press the  button, and then hang up the handset.

Related Information

- ➔ [“Receiving Faxes Using a Connected Telephone \(Remote Receive\)” on page 115](#)
- ➔ [“Saving Received Faxes in the Inbox” on page 117](#)
- ➔ [“Making Paper Source Settings to Receive Faxes” on page 108](#)

Receiving Faxes Using a Connected Telephone (Remote Receive)

To receive a fax manually, you need to operate the printer after you pick up the handset of the telephone. By using the **Remote Receive** feature, you can start receiving a fax just by operating the phone.

The **Remote Receive** feature is available for telephones that support tone dialing.

Related Information

- ➔ [“Receiving Faxes Manually” on page 115](#)

Setting Up Remote Receive

1. Enter **Setup** from the home screen.
2. Select **System Administration > Fax Settings > Receive Settings > Remote Receive**.
3. After enabling **Remote Receive**, enter a two digit code (0 to 9, *, and # can be entered) in the **Start Code** field.
4. Press **OK**.

Using Remote Receive

1. When the telephone rings, pick up the handset.
2. When you hear a fax tone, enter the start code using the telephone.
3. After confirming that the printer has started receiving the fax, hang up the handset.

Faxing

Receiving Faxes by Polling (Polling Receive)

You can receive a fax stored on another fax machine by dialing the fax number. Use this feature to receive a document from a fax information service. However, if the fax information service has an audio guidance feature that you need to follow to receive a document, you cannot use this feature.

Note:

To receive a document from a fax information service that uses audio guidance, just dial the fax number using the **On Hook** feature or the connected telephone, and operate the phone and the printer following the audio guidance.

1. Enter **Fax** from the home screen.
2. Select **Menu > Polling Receive**, and then enable the function.
3. Enter the fax number.

Note:

When **Direct Dialing Restrictions in Security Settings** is enabled, you can only select fax recipients from the contact list or the sent fax history. You cannot manually enter a fax number.

4. Press the  button.

Related Information

- ➔ [“Sending Faxes After Confirming the Recipient's Status” on page 110](#)
- ➔ [“Sending Faxes Dialing from the External Phone Device” on page 110](#)

Saving and Forwarding Received Faxes

The printer provides the following features to save and forward received faxes.

- Saving in the printer's inbox
- Saving in an external memory device
- Saving on a computer
- Forwarding to another fax machine, an email address, or to a shared folder on a network

Note:

- The above features can be used at the same time. If you do use them all at the same time, received documents are saved to the inbox, to an external memory device, on a computer, and forwarded to the specified destination.
- When there are received documents that have not been read, saved or forwarded yet, the number of the unprocessed jobs is displayed on the fax mode icon.

Related Information

- ➔ [“Saving Received Faxes in the Inbox” on page 117](#)
- ➔ [“Saving Received Faxes in an External Memory Device” on page 118](#)
- ➔ [“Saving Received Faxes on a Computer” on page 118](#)
- ➔ [“Forwarding Received Faxes” on page 119](#)
- ➔ [“Notification of Unprocessed Received Faxes” on page 122](#)

Faxing

Saving Received Faxes in the Inbox

You can set to save received faxes in the printer's inbox. Up to 100 documents can be saved. If you use this feature, received documents are not automatically printed. You can view them on the printer's LCD screen and print only when needed.

Note:

Saving 100 documents may not be possible depending on the usage conditions such as the file size of saved documents, and using of multiple fax saving features at a time.

Setting to Save Received Faxes in the Inbox

1. Enter **Setup** from the home screen.
2. Select **System Administration > Fax Settings > Output Settings > Fax Output**.
3. Check the current settings displayed on the screen, and press **Settings**.
4. Select **Save to Inbox > Yes**.
5. Select the option to use when the inbox is full.
 - Receive and print faxes:** The printer prints all received documents that cannot be saved in the Inbox.
 - Reject incoming faxes:** The printer does not answer incoming fax calls.

Checking the Received Faxes on the LCD Screen





1. Enter **Fax** from the home screen.

Note:

When there are received faxes that have not been read, the number of unread documents is displayed on the fax mode icon on the home screen.

2. Select **Open Inbox**.
3. If the inbox has been password protected, enter the inbox password or the administrator password.
4. Select the fax to view from the list.

The contents of the fax are displayed.

- : Rotates the image to the right by 90 degrees.
- : Moves the screen in the direction of the arrows.
- : Reduces or enlarges.
- : Moves to the previous or the next page.
- View:** Displays or hides the operation icons.
- : Deletes the previewed documents.

Faxing

5. Press **Menu**, select whether to print or delete the document you have viewed, and then follow the on-screen instructions.



Important:

If the printer runs out of memory, receiving and sending faxes is disabled. Delete documents that you have already read or printed.

Related Information

- ➔ [“Notification of Unprocessed Received Faxes” on page 122](#)
- ➔ [“Fax Settings Options” on page 126](#)

Saving Received Faxes in an External Memory Device

You can set to convert received documents into PDF format and save them in an external memory device connected to the printer. You can also set to automatically print the documents while saving them in the memory device.



Important:

Received documents are saved in the printer's memory temporarily before the documents are saved in the memory device connected to the printer. Because a memory full error disables sending and receiving faxes, keep the memory device connected to the printer. The number of documents that have saved in the printer's memory temporarily is displayed on the fax mode icon on the home screen.

1. Connect an external memory device to the printer.
2. Enter **Setup** from the home screen.
3. Select **System Administration > Fax Settings > Output Settings > Fax Output**.
4. Check the current settings displayed on the screen, and press **Settings**.
5. Select **Other Settings > Create Folder to Save**.
6. Check the message on the screen and then press **Create**.
A folder to save received documents is created in the memory device.
7. Press the  button to return to the **Fax Output** screen.
8. Select **Save to Memory Device > Yes**. To print the documents automatically while saving them in the memory device, select **Yes and Print**.

Related Information

- ➔ [“Notification of Unprocessed Received Faxes” on page 122](#)

Saving Received Faxes on a Computer

You can set to convert received documents into PDF format and save them on a computer connected to the printer. You can also set to automatically print the documents while saving them on the computer.

Faxing

First, you need to use FAX Utility to make the setting. Install FAX Utility on the computer.



Important:

- ❑ Set the printer's receive mode to **Auto**.
- ❑ Received documents are saved in the printer's memory temporarily before the documents are saved on the computer that is set to save the faxes. Because a memory full error disables sending and receiving faxes, keep the computer that is set to save the faxes turned on. The number of documents that have saved in the printer's memory temporarily is displayed on the fax mode icon on the home screen.

1. Start FAX Utility on the computer connected to the printer.
2. Open the setting screen of FAX Utility.
 - ❑ **Windows**
Select **Fax Settings for Printer > Received Fax Output Settings**.
 - ❑ **Mac OS X**
Click **Fax Receive Monitor**, select the printer, and then click **Receive Settings**.
3. Click **Save faxes on this computer**, and specify the folder to save received documents.
4. Make the other settings as necessary, and then send the setting to the printer.

Note:

For details on the setting items and the procedure, see the help of FAX Utility.

5. On the printer's control panel, enter **Setup**.
6. Select **System Administration > Fax Settings > Output Settings > Fax Output**.
7. The current setting is displayed. Check that the printer is set to save faxes on a computer (Save to Computer). If you want to automatically print received documents while saving them on the computer, press **Settings** and go to the next step.
8. Select **Save to Computer > Yes and Print**.

Note:

*To stop saving received document on the computer, set **Save to Computer** to **No** on the printer. You can also use FAX Utility to change the setting, however, changing from FAX Utility is not allowed while there are received faxes that have not been saved on the computer.*

Related Information

- ➔ [“Setting Receiving Mode” on page 114](#)
- ➔ [“FAX Utility” on page 162](#)
- ➔ [“Notification of Unprocessed Received Faxes” on page 122](#)

Forwarding Received Faxes

You can set to forward received documents to another fax machine, or convert the documents into PDF format and forward them to a shared folder on a network or to an email address. Forwarded documents are deleted from the printer. First register the forwarding destinations to the contacts list. To forward to an email address, you also need to configure the email server settings.

Faxing

Note:

- Color documents cannot be forwarded to another fax machine. They are processed as documents that failed to be forwarded.
- Before you use this feature, make sure the printer's **Date/Time** and **Time Difference** settings are correct. Access the menus from **System Administration > Common Settings**.

1. Enter **Setup** from the home screen.
2. Select **System Administration > Fax Settings > Output Settings > Fax Output**.
3. Check the current settings displayed on the screen, and press **Settings**.
4. Select **Forward > Yes**.

Note:

To print the documents automatically while forwarding them, select **Yes and Print**.

5. Select **Other Settings > Where to Forward**.
 6. Select forwarding destinations from the contacts list.
- Note:**
- Press **View** to sort the contacts by printer's feature.
 - You can specify up to five forwarding destinations. Press the check box to select the destination. Press the box again to cancel the selection.
7. When finished selecting forwarding destinations, press **Proceed**.
 8. Check that the forwarding destinations you selected are correct, then press **Close**.
 9. Select **Options When Forwarding Failed**.
 10. Select whether to print received documents or save them in the printer's inbox when forwarding them is failed.

Important:

When the inbox is full, sending and receiving faxes is disabled. You should delete the documents from the inbox once they have been checked. The number of documents that have failed to be forwarded is displayed on the fax mode icon on the home screen, in addition to other unprocessed jobs.

11. When forwarding to an email address, you can specify a subject for the email. Select **Email Subject to Forward**, and enter the subject.

Note:

- If you have selected a shared folder on a network or an email address as the forwarding destination, we recommend that you test if you can send a scanned image to the destination in the scan mode. Select **Scan > Email**, or **Scan > Network Folder/FTP** from the home screen, select the destination, and then start scanning.
- You can set to receive a new fax notification on a Windows computer when received documents are saved to a shared folder on a network. Use FAX Utility to make the settings. For details, see the help of FAX Utility.

Related Information

- ➔ [“Output Settings” on page 127](#)
- ➔ [“Managing Contacts” on page 58](#)
- ➔ [“Using an Email Server” on page 225](#)

Faxing

- ➔ “Checking the Received Faxes on the LCD Screen” on page 117
- ➔ “Notification of Unprocessed Received Faxes” on page 122
- ➔ “Scanning to an Email” on page 88
- ➔ “Scanning to a Network Folder or FTP Server” on page 89
- ➔ “FAX Utility” on page 162

Using Other Faxing Features

Printing Fax Report and List

Printing Fax Report Manually

1. Enter **Fax** from the home screen.
2. Select **Menu > Fax Report**.
3. Select the report to print, and then follow the on-screen instruction.

Note:

You can change the report format. From the home screen, select **Setup > System Administration > Fax Settings > Output Settings**, and then change the **Attach Image to Report** or **Report Format** settings.

Related Information

- ➔ “Menu Options for Fax Mode” on page 124
- ➔ “Output Settings” on page 127

Setting Up to Print Fax Reports Automatically

You can make settings to print the following fax reports automatically.

Transmission Report

From the home screen, select **Setup > System Administration > Fax Settings > User Default Settings > Transmission Report**, and then select **Print** or **Print on Error**.

Note:

To change the setting when sending a fax, press **Menu** on the fax top screen, and then select **Fax Send Settings > Transmission Report**.

Forwarding Report

From the home screen, select **Setup > System Administration > Fax Settings > Output Settings > Forwarding Report**, and then select **Print** or **Print on Error**.

Fax Log

From the home screen, select **Setup > System Administration > Fax Settings > Output Settings > Fax Log Auto Print**, and then select **On(Every 30)** or **On(Time)**.

Faxing

Related Information

- ➔ [“Menu Options for Fax Mode” on page 124](#)
- ➔ [“Output Settings” on page 127](#)

Setting Security for Faxing

You can make security settings to prevent sending a fax to the wrong recipient, or prevent received documents from being leaked or lost. You can also delete backed-up fax data.

1. Enter **Setup** from the home screen.
2. Select **System Administration > Fax Settings > Security Settings**.
3. Select the menu, and then make the settings.

Related Information

- ➔ [“Security Settings” on page 129](#)

Checking Fax Jobs

Notification of Unprocessed Received Faxes

When there are unprocessed received documents, the number of unprocessed jobs is displayed on the fax mode icon on the home screen. When the number of faxes exceeds 10, the icon changes to **10+**. See the table below for a definition of the "unprocessed".



Received Fax Output Setting	Unprocessed Status
Printing ^{*1}	Received documents are waiting to be printed or printing is in progress.
Saving in the inbox	There are unread received documents in the inbox.
Saving in an external memory device	There are received documents that have not been saved in the device because there is no device containing a folder specifically created to save received documents connected to the printer or for other reasons.
Saving on a computer	There are received documents that have not been saved on the computer because the computer is in sleep mode or for other reasons.

Faxing

Received Fax Output Setting	Unprocessed Status
Forwarding	There are received documents that have not been forwarded or failed to be forwarded*2.

*1 : When you have set none of the fax output settings, or when you have set to print received documents while saving them in an external memory device or a computer.

*2 : When you have set to save documents that could not be forwarded in the inbox, there are unread documents that failed to be forwarded in the inbox. When you have set to print documents that failed to be forwarded, printing is not complete.

Note:

If you are using more than one of the fax output settings, the number of unprocessed jobs may be displayed as "2" or "3" even if only one fax has been received. For example, if you have set to save faxes in the inbox and on a computer and one fax is received, the number of unprocessed jobs is displayed as "2" if the fax has not been saved to the inbox and on a computer.

Related Information

- ➔ ["Saving Received Faxes in the Inbox" on page 117](#)
- ➔ ["Saving Received Faxes in an External Memory Device" on page 118](#)
- ➔ ["Saving Received Faxes on a Computer" on page 118](#)
- ➔ ["Forwarding Received Faxes" on page 119](#)
- ➔ ["Checking the Received Faxes on the LCD Screen" on page 117](#)
- ➔ ["Checking Fax Jobs in Progress" on page 123](#)

Checking Fax Jobs in Progress

You can check, cancel, print, resend, or delete the following fax documents.

- Received documents that have not been printed yet.
- Documents that have not be sent yet
- Documents stored using **Polling Send** or **Store Fax Data**.
- Documents that have failed to be sent (if you have enabled **Save Failure Data**)
- Received documents that have not been saved on a computer or in an external memory device

1. Press the **i** button.
2. Select **Job Monitor**, and then select **Communication Job** or **Print Job**.
3. Select a job to check.

Checking the Fax Job History

You can check the history of sent or received fax jobs. The received fax logs include the received documents so that you can reprint them. You cannot print or resend sent documents from the sent log.

1. Press the **i** button.
2. Select **Job History**, and then select **Receive Job** or **Send Job**.

Faxing

3. Select a job to check.

Note:

All the received documents are stored in **Job History** so that you can reprint them, but they are deleted in chronological order when the printer runs out of memory.

Checking the Received Documents in the Inbox

You can check received documents stored in the printer's inbox.

1. Press the **i** button.
2. Select **Job Storage** and then select **Inbox**.

Note:

Press **Menu** to display menus for printing or deleting all the documents in the inbox.

3. Select a fax to check.

The content of the document is displayed.

Note:

- Press **Menu**, and then select **Details** to see detailed information such as the date and time, and the sender.
- The printer cannot receive and send faxes when the memory is full. We recommend deleting the viewed or printed documents.

Menu Options for Fax Mode

- Enter a Fax Number

Manually enter a fax number.

- Resolution

Select the resolution of the outgoing fax. Select **Photo** for originals that contain both text and photo images.

- Density

Sets the density of the outgoing fax.

- Document Size (Glass)

Select the size and orientation of the original you placed on the scanner glass.

- ADF 2-Sided

Scans both sides of originals placed in the ADF and sends a monochrome fax.

- Contacts

Select a recipient from the contacts list. You can also add or edit a contact.

- History

Select a recipient from the sent fax history. You can also add the recipient to the contacts list.

- On Hook

You can send a fax while listening to sounds or voices through the printer's speaker while dialing, communicating, and transmitting.

Fax Send Settings

Select the menus on the control panel as described below.

Faxing

Fax > Menu > Fax Send Settings

Resolution

Select the resolution of the outgoing fax. Select **Photo** for originals that contain both text and photo images.

Density

Sets the density of the outgoing fax.

Document Size (Glass)

Select the size and orientation of the original you placed on the scanner glass.

ADF 2-Sided

Scans both sides of originals placed in the ADF and sends a monochrome fax.

Direct Send

Sends monochrome faxes to a single recipient as soon as the connection is made, without saving the scanned image to memory. If you do not enable this option, the printer starts the transmission after saving the scanned image to memory and may cause a memory full error when sending many pages. By using this option, you can avoid the error, but it takes longer to send the fax. You cannot use this option when using the **ADF 2-Sided** option and when sending a fax to multiple recipients.

Priority Send

Sends the current fax before other faxes waiting to be sent.

Continuous Scan from ADF

When sending a fax from the ADF, you cannot add originals in the ADF after starting scanning. If you place different sized originals in the ADF, all of the originals are sent at the largest size among them. Enable this option so that the printer asks if you want to scan another page after an original in the ADF has finished scanning. Then you can sort and scan your originals by size and send them as a single fax.

Transmission Report

Prints a transmission report automatically after you send a fax. Select **Print on Error** to print a report only when an error occurs.

Send Fax Later

Select the menus on the control panel as described below.

Fax > Menu > Send Fax Later

Sends a fax at a time you specified. Only a monochrome fax is available when using this option.

Polling Receive

Select the menus on the control panel as described below.

Fax > Menu > Polling Receive

Connects to the fax number you entered and receives a fax stored on the fax machine. You can use this option for receiving a fax from a fax information service.

Polling Send

Select the menus on the control panel as described below.

Faxing

Fax > Menu > Polling Send

Stores one scanned document (up to 100 monochrome pages) for polling and sends it automatically when another fax machine requests it using the device's polling receive function.

Store Fax Data

Select the menus on the control panel as described below.

Fax > Menu > Store Fax Data

Stores one scanned document (up to 100 monochrome pages) and allows you to send it whenever necessary.

Fax Report

Select the menus on the control panel as described below.

Fax > Menu > Fax Report

Fax Settings List

Prints the current fax settings.

Fax Log

Prints a transmission report automatically after you send a fax. You can set to print this report automatically using the following menu.

Setup > System Administration > Fax Settings > Output Settings > Fax Log Auto Print

Last Transmission

Prints a report for the previous fax that was sent or received through polling.

Stored Fax Documents

Prints a list of fax documents stored in the printer's memory, such as unfinished jobs.

Protocol Trace

Prints a detailed report for the previous fax that was sent or received.

Fax Settings Options

Select the menus on the control panel as described below.

Setup > System Administration > Fax Settings

User Default Settings

Select the menus on the control panel as described below.

Setup > System Administration > Fax Settings > User Default Settings

The settings made in this menu become your default settings for sending faxes. For explanations on the setting items, see the **Fax Send Settings** in Fax mode.

Faxing

Related Information

➔ [“Menu Options for Fax Mode” on page 124](#)

Send Settings

Select the menus on the control panel as described below.

Setup > System Administration > Fax Settings > Send Settings

Auto Rotation

An A4 size original placed in the ADF or on the scanner glass with its long edge facing to the left is sent as an A3 size fax. Enable this to rotate the scanned image to send it at A4 size.

Batch Send

When there are multiple faxes waiting to be sent to the same recipient, this groups them together to send them at once. Up to five documents (up to 100 pages in total) can be sent at one time. This helps you save on connection fees by reducing the number of transmission times.

Save Failure Data

Saves documents that failed to be sent in the printer's memory. You can resend the documents from the **Status Menu**.

Receive Settings

Select the menus on the control panel as described below.

Setup > System Administration > Fax Settings > Receive Settings

Receive Mode

Select the receive mode.

DRD

If you have subscribed to a distinctive ring service from your telephone company, select the ring pattern to be used for incoming faxes. The distinctive ring service, offered by many telephone companies (the service name differs by company), allows you to have several phone numbers on one phone line. Each number is assigned different ring pattern. You can use one number for voice calls and another for fax calls. Depending on the region, this option may be **On** or **Off**.

Rings to Answer

Select the number of rings that must occur before the printer automatically receives a fax.

Remote Receive

When you answer an incoming fax call on a phone connected to the printer, you can start receiving the fax by entering the code using the phone.

Output Settings

Select the menus on the control panel as described below.

Setup > System Administration > Fax Settings > Output Settings

Faxing

Fax Output

You can set to save received documents in the inbox, on a memory device, or on a computer, or forward the documents.

Auto Reduction

Reduces large received documents to fit on the paper in the paper source. Reducing may not always be possible depending on the received data. If this is turned off, large documents are printed at their original size on multiple sheets, or a blank second page may be ejected.

Auto Rotation

Rotates a landscape-oriented A5, B5, A4, or Letter size received document so that it is printed on the correct paper size. This setting is applied when two or more paper sources are set for fax printing in **Paper Source Settings > Auto Select Settings**, and the paper size settings of the paper sources are A3 and A4, B4 and B5, or A4 and A5.

Collation Stack

Prints received documents from the last page (print in descending order) so that the printed documents are stacked in the correct page order. When the printer is running low on memory, this feature may not be available.

Print Suspend Time

Saves documents received during the specified time period in the printer's memory without printing them. At the time specified to restart printing, the documents are automatically printed. This feature can be used for noise prevention at night or to prevent confidential documents from being disclosed while you are away. Before using this feature, make sure there is enough free memory. Even before the restarting time, you can check and print the received documents individually from **Status Menu**.

Forwarding Report

Prints a report after forwarding a received document.

Attach Image to Report

Prints a **Transmission Report** with an image of the first page of the sent document. Select **On(Large Image)** to print the upper part of the page without reducing. Select **On(Small Image)** to print the entire page reducing it to fit onto the report.

Fax Log Auto Print

Prints the fax log automatically. Select **On(Every 30)** to print a log every time 30 fax jobs are completed. Select **On(Time)** to print the log at a specified time. However, if the number of fax jobs exceeds 30, the log is printed before the specified time.

Report Format

Select a format for fax reports other than **Protocol Trace**. Select **Detail** to print with error codes.

Basic Settings

Select the menus on the control panel as described below.

Setup > System Administration > Fax Settings > Basic Settings

Fax Speed

Faxing

Select the fax transmission speed. We recommend selecting **Slow(9,600bps)** when a communication error occurs frequently, when sending/receiving a fax to/from abroad, or when you are using an IP (VoIP) phone service.

ECM

Automatically corrects errors in the fax transmission (Error Correction Mode), mostly caused by telephone line noise. If this is disabled, you cannot send or receive documents in color.

Dial Tone Detection

Detects a dial tone before starting to dial. If the printer is connected to a PBX (Private Branch Exchange) or digital phone line, the printer may fail to start dialing. In this situation, change the **Line Type** setting to **PBX**. If this does not work, disable this feature. However, disabling this feature may drop the first digit of a fax number and send the fax to the wrong number.

Dial Mode

Select the type of phone system to which you have connected the printer. When set to **Pulse**, you can temporarily switch the dialing mode from pulse to tone by pressing * ("T" is entered) while entering numbers on the fax top screen. Depending on the region, this setting may not be displayed.

Line Type

Select the line type to which you have connected the printer. When using the printer in an environment that uses extensions and requires an external access code, such as 0 and 9, to get an outside line, select **PBX** and register the access code. Once you have registered the access code, enter # (hash) instead of the access code when sending a fax to an outside fax number. For an environment that uses a DSL modem or terminal adapter, setting to **PBX** is also recommended.

Header

Enter your sender name and fax number. These appear as a header on outgoing faxes. You can enter up to 40 characters for your name, and up to 20 digits for your fax number.

Security Settings

Select the menus on the control panel as described below.

Setup > System Administration > Fax Settings > Security Settings

Direct Dialing Restrictions

Enable this to disable the manual entry of recipient's fax numbers allowing the operator to select recipients only from the contacts list or sent history. Select **Enter Twice** to require the operator to enter the fax number again when the number was manually entered.

Confirm Address List

Displays a recipient confirmation screen before starting the transmission.

Inbox Password Settings

Password protects the inbox to restrict users from viewing received faxes. Select **Change** to change the password, and select **Reset** to cancel password protection. When changing or resetting the password, you need the current password.

Backup Data Auto Clear

Faxing

To prepare for an unexpected power off due to an electricity failure or an incorrect operation, the printer temporarily stores backup copies of sent and received documents in its memory. Enable this option to automatically erase the backups when sending or receiving a document completes successfully and the backups become unnecessary.

Clear Backup Data

Erases all backup copies temporarily stored in the printer's memory. Run this before you give the printer to someone else or dispose of it.

Check Fax Connection

Select the menus on the control panel as described below.

Setup > System Administration > Fax Settings > Check Fax Connection

Checks if the printer is connected to the phone line and ready for fax transmission, and prints the check result on A4 size plain paper.

Fax Setting Wizard

Select the menus on the control panel as described below.

Setup > System Administration > Fax Settings > Fax Setting Wizard

Select to make basic fax settings by following the on-screen instructions. For details, see the page that describes basic fax settings.

Refilling Ink and Replacing Maintenance Boxes

Checking the Status of the Remaining Ink and the Maintenance Box

You can check the approximate ink levels from the computer.

To confirm the actual ink remaining, visually check the ink levels in all of the printer's tanks.

You can check the approximate service life of the maintenance box from the control panel or the computer.

Checking the Status of the Maintenance Box - Control Panel

1. Press the **i** button on the control panel.
2. Select **Printer Information**.

Note:

The indicator on the far right indicates the available space in the maintenance box.

Checking the Status of the Remaining Ink and the Maintenance Box - Windows

1. Access the printer driver window.
2. Click **EPSON Status Monitor 3** on the **Maintenance** tab.

Note:

*If EPSON Status Monitor 3 is disabled, click **Extended Settings** on the **Maintenance** tab, and then select **Enable EPSON Status Monitor 3**.*

Related Information

➔ [“Windows Printer Driver” on page 158](#)

Checking the Status of the Remaining Ink and the Maintenance Box - Mac OS X

1. Select **System Preferences** from the  menu > **Printers & Scanners** (or **Print & Scan**, **Print & Fax**), and then select the printer.
2. Click **Options & Supplies** > **Utility** > **Open Printer Utility**.
3. Click **EPSON Status Monitor**.

Refilling Ink and Replacing Maintenance Boxes

Ink Bottle Codes

Epson recommends the use of genuine Epson ink bottles. Epson warranty does not cover damage caused by inks other than those specified, including any genuine Epson ink not designed for this printer or any third party ink.

Other products not manufactured by Epson may cause damage that is not covered by Epson's warranties, and under certain circumstances, may cause erratic printer behavior.

The following are the codes for genuine Epson ink bottles.

BK: Black	C: Cyan	M: Magenta	Y: Yellow
774	664	664	664



Important:

Use of genuine Epson ink other than the specified ink could cause damage that is not covered by Epson's warranties.

Note:

- Ink bottle codes may vary by location. For the correct codes in your area, contact Epson support.
- For users in Europe, visit the following website for information on Epson's ink bottle yields.
<http://www.epson.eu/pageyield>

Related Information

- ➔ [“Technical Support Web Site” on page 227](#)

Ink Bottle Handling Precautions

Read the following instructions before refilling ink.

Handling precautions

- Use ink bottles with the correct part code for this printer.
- This printer requires careful handling of ink. Ink may splatter when the ink tanks are filled or refilled with ink. If ink gets on your clothes or belongings, it may not come off.
- Store ink bottles at normal room temperature and keep them away from direct sunlight.
- Epson recommends using the ink bottle before the date printed on the package.
- Store the ink bottles in the same environment as the printer.
- When storing or transporting an ink bottle after removing its seal, do not tilt the bottle and do not subject it to impacts or temperature changes. Otherwise, ink may leak even if the cap on the ink bottle is tightened securely. Be sure to keep the ink bottle upright when tightening the cap, and take measures to prevent ink from leaking when you transport the bottle.
- After bringing an ink bottle inside from a cold storage site, allow it to warm up at room temperature for at least three hours before using it.
- Do not open the ink bottle package until you are ready to fill the ink tank. The ink bottle is vacuum packed to maintain its reliability. If you leave an ink bottle unpacked for a long time before using it, normal printing may not be possible.

Refilling Ink and Replacing Maintenance Boxes

- ❑ Visually check ink levels in the actual ink tanks. Continued use of the printer when the ink is expended could damage the printer. Epson recommends filling the ink tank to the upper line when the printer is not operating to reset the ink level.
- ❑ To ensure you receive premium print quality and to help protect your print head, a variable ink safety reserve remains in the ink tank when your printer indicates to refill ink. The yields quoted for you do not include this reserve.
- ❑ To obtain optimum printing results, refill the ink tanks to the upper line at least once every year.
- ❑ Although the ink bottles may contain recycled materials, this does not affect printer function or performance.
- ❑ Specifications and appearance of the ink bottle are subject to change without prior notice for improvement.
- ❑ Quoted yields may vary depending on the images that you are printing, the paper type that you are using, the frequency of your prints and environmental conditions such as temperature.

Ink consumption

- ❑ To maintain optimum print head performance, some ink is consumed from all ink tanks not only during printing but also during maintenance operation such as print head cleaning.
- ❑ When printing in monochrome or grayscale, color inks instead of black ink may be used depending on the paper type or print quality settings. This is because a mixture of color inks is used to create black.
- ❑ The ink in the ink bottles supplied with your printer is partly used during initial setup. In order to produce high quality printouts, the print head in your printer will be fully charged with ink. This one-off process consumes a quantity of ink and therefore these bottles may print fewer pages compared to subsequent ink bottles.

Refilling the Ink Tanks

1. Enter **Setup** from the home screen.
2. Select **Maintenance > Reset Ink Levels**.
3. Press **Proceed**.
4. Open the ink tank unit cover, and then remove the cap of the ink tank. After removing the cap, place it on the protruding portion on the ink tank as shown in 3 in the illustration below.

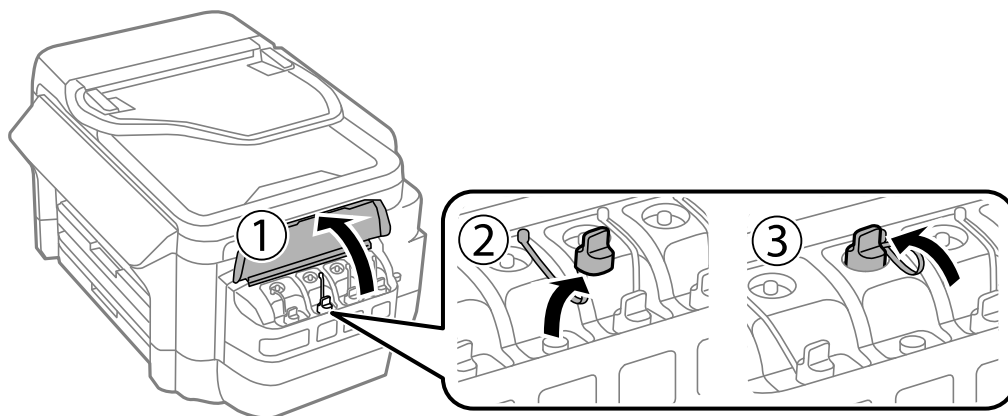

Refilling Ink and Replacing Maintenance Boxes

! *Important:*

- ❑ Be careful not to spill any ink.
- ❑ Make sure that the color of the ink tank matches the ink color that you want to refill.

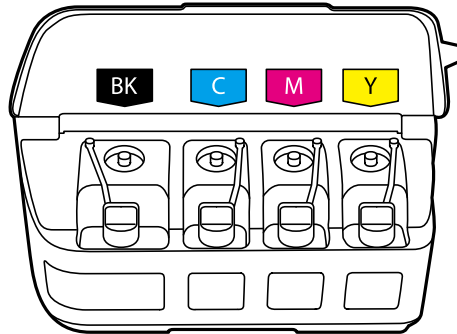

5. Snap off the top of the cap, remove the cap of the ink bottle, remove the seal from the bottle, and then install the cap.

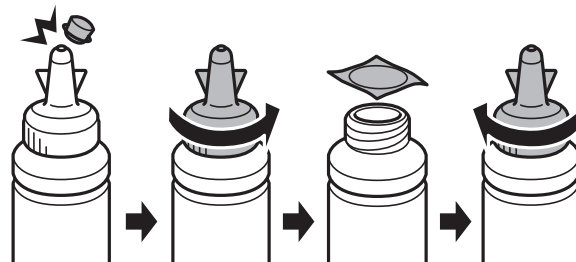

! *Important:*

Close the ink bottle cap tightly; otherwise ink may leak.

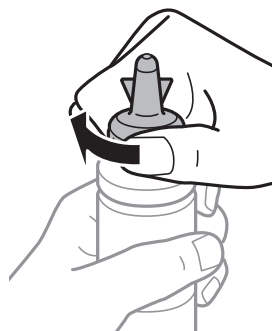

Note:

Do not dispose of the top of the cap. If any ink remains in the ink bottle after refilling the tank, use the top of the cap to seal the ink bottle cap.

Refilling Ink and Replacing Maintenance Boxes

6. Refill the ink tank with the correct colored ink up to the upper line on the ink tank.

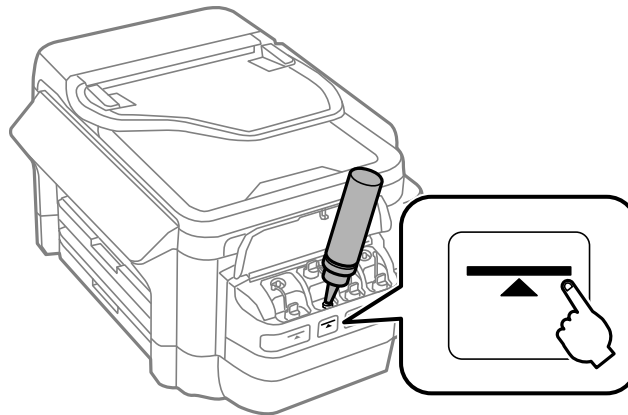

! **Important:**

It may be difficult to see inside the ink tank. Refill the ink tank carefully to prevent ink from spilling out from the ink inlet.

Note:

If any ink remains in the ink bottle after filling the ink tank up to the upper line, install the top of the cap securely and store the ink bottle upright for later use.

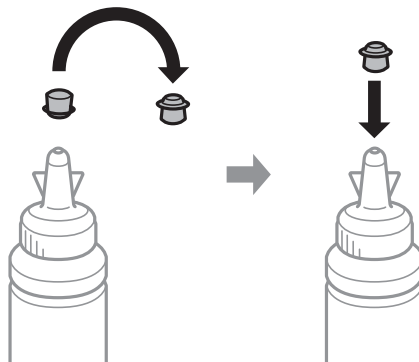

7. Close the cap onto the ink tank securely.

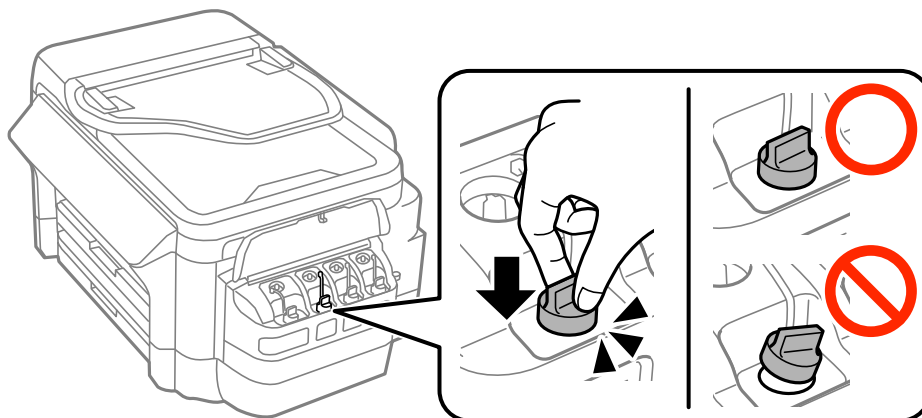

Refilling Ink and Replacing Maintenance Boxes

- Close the ink tank unit cover.

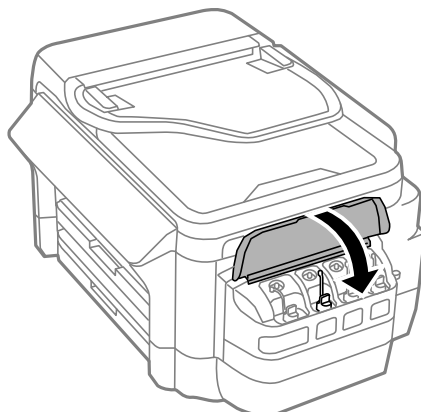

- Select the color you refilled, and then press **Done**.
- Confirm the message, and then press **OK**.

Note:

You can reset the ink levels even if you did not fill the ink to the upper line. Note that doing so may cause a difference between the approximate ink levels and the actual ink levels. To keep your printer operating at the optimum condition, refill the ink tanks up to the upper line, and then reset the ink levels.

Related Information

- ➔ [“Ink Bottle Codes” on page 132](#)
- ➔ [“Ink Bottle Handling Precautions” on page 132](#)
- ➔ [“Menu Options for Maintenance” on page 147](#)

Maintenance Box Code

Epson recommends the use of a genuine Epson maintenance box.

The following is the code for the genuine Epson maintenance box.

T6711

Maintenance Box Handling Precautions

Read the following instructions before replacing the maintenance box.

- Do not touch the green chip on the side of the maintenance box. Doing so may prevent normal operation and printing.
- Do not tilt the used maintenance box until after it is sealed in the plastic bag; otherwise ink may leak.
- Keep the maintenance box out of direct sunlight.
- Do not replace the maintenance box during printing; otherwise, ink may leak.
- Do not reuse a maintenance box which has been removed and left detached for a long period. Ink inside the box will have solidified and no more ink can be absorbed.

Replacing a Maintenance Box

In some print cycles a very small amount of surplus ink may be collected in the maintenance box. To prevent ink leakage from the maintenance box, the printer is designed to stop printing when the absorbing capacity of the maintenance box has reached its limit. Whether and how often this is required will vary according to the number of pages you print, the type of material that you print and the number of cleaning cycles that the printer performs. Replace the maintenance box when you are promoted to do so. The Epson Status Monitor, your LCD, or lights on the control panel will advise you when this part needs replacing. The need for replacement of the box does not mean that your printer has ceased to operate in accordance with its specifications. The Epson warranty does not cover the cost of this replacement. It is a user-serviceable part.

Note:

When it is full, you cannot print until the maintenance box is replaced to avoid ink leakage. However, you can perform operations such as sending faxes and saving data to an external USB device.

1. Remove the new maintenance box from its package.



Important:

Do not touch the green chip on the side of the maintenance box. Doing so may prevent normal operation and printing.

Note:

A transparent bag for the used maintenance box is provided with the new maintenance box.

2. Open rear cover 1.

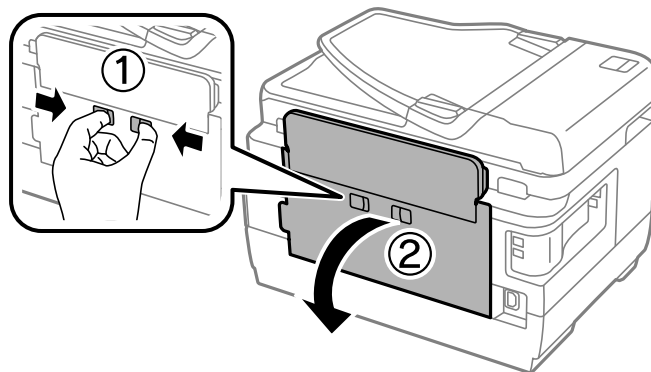

3. Remove the used maintenance box.

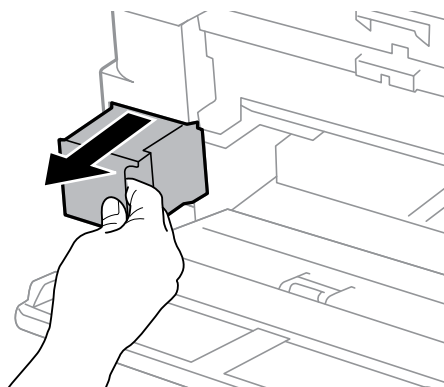

Refilling Ink and Replacing Maintenance Boxes

- Put the used maintenance box in the transparent bag that came with the new maintenance box and seal the bag shut.

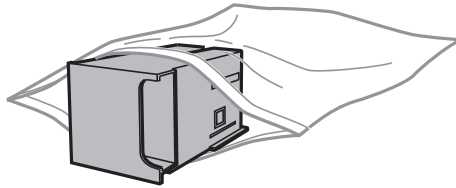

Important:

Do not tilt the used maintenance box until after it is sealed in the plastic bag; otherwise ink may leak.

- Insert the new maintenance box all the way into the printer.
- Close rear cover 1.

Related Information

- ➔ [“Maintenance Box Code” on page 136](#)
- ➔ [“Maintenance Box Handling Precautions” on page 136](#)

Maintaining the Printer

Checking and Cleaning the Print Head

If the nozzles are clogged, the printouts become faint, there is visible banding, or unexpected colors appear. When print quality has declined, use the nozzle check feature and check if the nozzles are clogged. If the nozzles are clogged, clean the print head.

Important:

- Do not open the scanner unit or turn off the printer during head cleaning. If the head cleaning is incomplete, you may not be able to print.
- Because print head cleaning uses some ink, clean the print head only if quality declines.
- When ink is low, you may not be able to clean the print head. Prepare a new ink bottle.
- If print quality has not improved after repeating nozzle check and head cleaning three times, wait for at least 12 hours without printing, and then run the nozzle check again and repeat the head cleaning if necessary. We recommend to turn off the printer. If print quality has still not improved, contact Epson support.
- To prevent the print head from drying out, do not unplug the printer while the power is on.

Checking and Cleaning the Print Head - Control Panel

1. Load A4-size plain paper in the paper cassette 1.
2. Enter **Setup** from the home screen.
3. Select **Maintenance > Print Head Nozzle Check**.
4. Follow the on-screen instructions to print the nozzle check pattern.
5. Examine the printed pattern. If there are broken lines or missing segments as shown in the "NG" pattern, the print head nozzles may be clogged. Go to the next step. If you cannot see any broken lines or missing segments as in the following "OK" pattern, the nozzles are not clogged. Close the nozzle check feature.

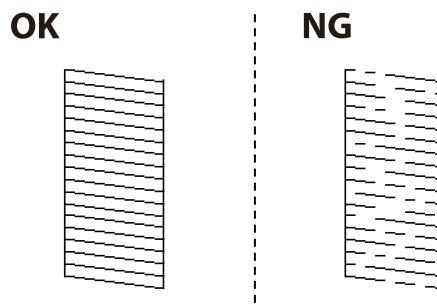

Note:

The test pattern may vary by model.

6. Select **Clean the Print Head**.

Maintaining the Printer

7. Select one of the options below according to the result of the nozzle check.
 - All Colors:** When a defect is found in the pattern of all colors (BK, Y, M, and C)
 - All except Black:** When a defect is found in the pattern of all colors except black (Y, M, and C)
 - Black Only:** When a defect is found only in the pattern of black (BK)
8. When cleaning is finished, print the nozzle check pattern again. Repeat cleaning and printing the pattern until all lines are printed completely.

Related Information

- ➔ [“Loading Paper in the Paper Cassette” on page 45](#)

Checking and Cleaning the Print Head - Windows

1. Load A4-size plain paper in the paper cassette 1.
2. Access the printer driver window.
3. Click **Nozzle Check** on the **Maintenance** tab.
4. Follow the on-screen instructions.

Related Information

- ➔ [“Loading Paper in the Paper Cassette” on page 45](#)
- ➔ [“Windows Printer Driver” on page 158](#)

Checking and Cleaning the Print Head - Mac OS X

1. Load A4-size plain paper in the paper cassette 1.
2. Select **System Preferences** from the  menu > **Printers & Scanners** (or **Print & Scan**, **Print & Fax**), and then select the printer.
3. Click **Options & Supplies** > **Utility** > **Open Printer Utility**.
4. Click **Nozzle Check**.
5. Follow the on-screen instructions.

Related Information

- ➔ [“Loading Paper in the Paper Cassette” on page 45](#)

Replacing Ink inside the Ink Tubes

If you have not used the printer for one or two months and notice banding or missing colors in the printouts, you may need to replace the ink inside the ink tubes to solve the problem. The **Power Ink Flushing** utility allows you to replace all of the ink inside the ink tubes.

Maintaining the Printer

Important:

- ❑ *This feature consumes a lot of ink. Before using this feature, make sure there is enough ink in the printer's ink tanks. If there is not enough ink, refill the ink tanks.*
- ❑ *The maintenance box reaches its capacity earlier by running this feature. Replace the maintenance box when the absorbing capacity of the maintenance box has reached its limit.*
- ❑ *After using the Power Ink Flushing utility, turn the printer off and wait for at least 12 hours. Using this feature improves the print quality after 12 hours, however it cannot be used again within 12 hours of the last use. If you still cannot solve the problem after trying all of the methods above, contact Epson support.*

Related Information

➔ [“Replacing a Maintenance Box” on page 137](#)

Replacing Ink inside the Ink Tubes - Windows

1. Access the printer driver window.
2. Click **Power Ink Flushing** on the **Maintenance** tab.
3. Follow the on-screen instructions.

Related Information

➔ [“Windows Printer Driver” on page 158](#)

Replacing Ink inside the Ink Tubes - Mac OS X

1. Select **System Preferences** from the  menu > **Printers & Scanners** (or **Print & Scan, Print & Fax**), and then select the printer.
2. Click **Options & Supplies** > **Utility** > **Open Printer Utility**.
3. Click **Power Ink Flushing**.
4. Follow the on-screen instructions.

Aligning the Print Head

If you notice a misalignment of vertical lines or blurred images, align the print head.

Aligning the Print Head - Control Panel

1. Load A4-size plain paper in the paper cassette 1.
2. Enter **Setup** from the home screen.
3. Select **Maintenance** > **Print Head Alignment**.

Maintaining the Printer

4. Select **Vertical Alignment** or **Horizontal Alignment**, and then follow the on-screen instructions to print an alignment pattern.
 - Vertical Alignment: Select this if your printouts look blurry or vertical ruled lines appear misaligned.
 - Horizontal Alignment: Select this if you see horizontal banding at regular intervals.
5. Follow the on-screen instructions to align the print head.
 - Vertical Alignment: Find and enter the number for the most solid pattern in each group.

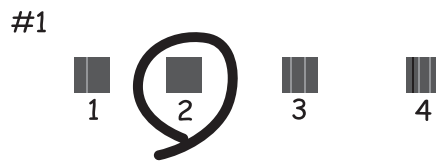

- Horizontal Alignment: Find and enter the number for the least separated and overlapping pattern.

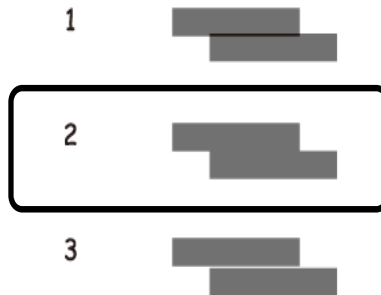

Note:

The test pattern may vary by model.

Related Information

➔ [“Loading Paper in the Paper Cassette” on page 45](#)

Cleaning the Paper Path for Ink Smears

When the printouts are smeared or scuffed, clean the roller inside.



Important:

Do not use tissue paper to clean the inside of the printer. The print head nozzles may be clogged with lint.

1. Load A3-size plain paper in the paper source that you want to clean.
2. Enter **Setup** from the home screen.

Maintaining the Printer

3. Select **Maintenance > Paper Guide Cleaning**.
4. Select the paper source, and then follow the on-screen instructions to clean the paper path.

Note:

Repeat this procedure until the paper is not smeared with ink. If the printouts are still smeared or scuffed, clean the other paper sources.

Related Information

➔ [“Loading Paper in the Paper Cassette” on page 45](#)

Cleaning the ADF

When the copied or scanned images from the ADF are smeared or the originals do not feed in the ADF correctly, clean the ADF.



Important:

Never use alcohol or thinner to clean the printer. These chemicals can damage the printer.

1. Open the ADF cover.

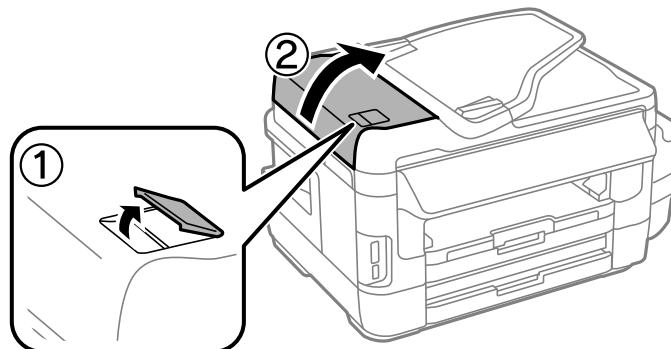

2. Use a soft, dry, clean cloth to clean the roller and the interior of the ADF.

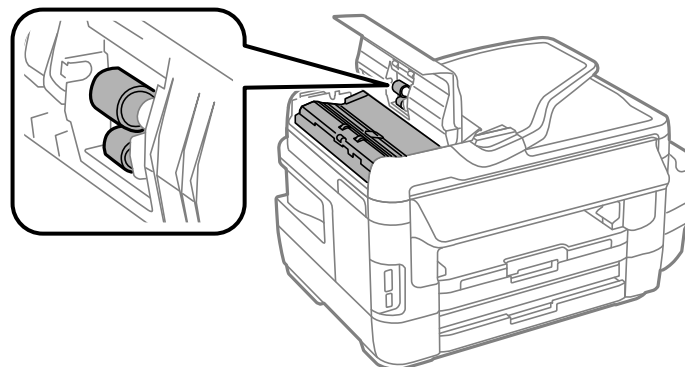

Maintaining the Printer

3. Open the document cover.

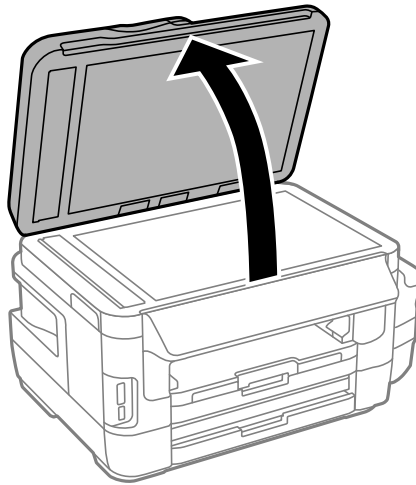

4. Clean the part that is shown in the illustration.

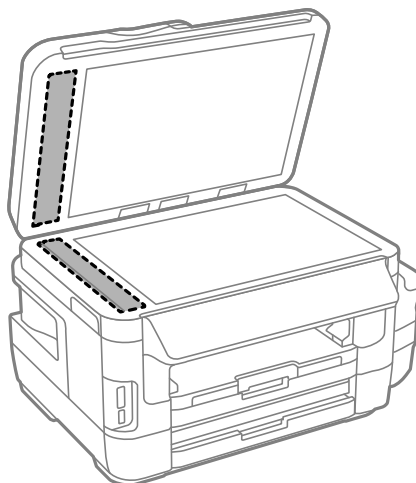

Note:

- If the glass surface is stained with grease or some other hard-to-remove material, use a small amount of glass cleaner and a soft cloth to remove it. Wipe off all remaining liquid.
- Do not press the glass surface too hard.
- Be careful not to scratch or damage the surface of the glass. A damaged glass surface can decrease the scan quality.

Cleaning the Scanner Glass

When the copies or scanned images are smeared or scuffed, clean the scanner glass.



Caution:

Be careful not to trap your hand or fingers when opening or closing the document cover. Otherwise you may be injured.

Maintaining the Printer

**Important:**

Never use alcohol or thinner to clean the printer. These chemicals can damage the printer.

1. Open the document cover.

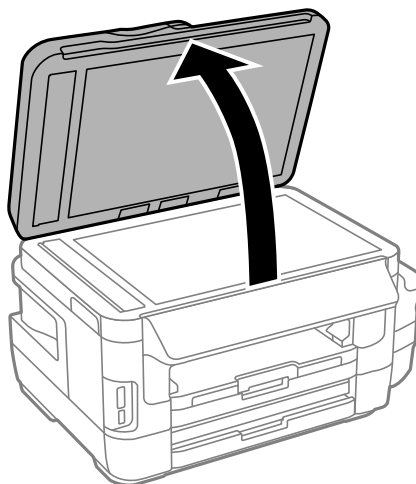

2. Use a soft, dry, clean cloth to clean the surface of the scanner glass.

Note:

- If the glass surface is stained with grease or some other hard-to-remove material, use a small amount of glass cleaner and a soft cloth to remove it. Wipe off all remaining liquid.
- Do not press the glass surface too hard.
- Be careful not to scratch or damage the surface of the glass. A damaged glass surface can decrease the scan quality.

Checking the Total Number of Pages Fed Through the Printer

You can check the total number of pages fed through the printer.

Checking the Total Number of Pages Fed Through the Printer - Control Panel

The information is printed together with the nozzle check pattern.

1. Load A4-size plain paper in the paper cassette 1.
2. Enter **Setup** from the home screen.
3. Select **Maintenance > Print Head Nozzle Check**.
4. Follow the on-screen instructions to print the nozzle check pattern.

Maintaining the Printer

Related Information

➔ [“Loading Paper in the Paper Cassette” on page 45](#)

Checking the Total Number of Pages Fed Through the Printer - Windows

1. Access the printer driver window.
2. Click **Printer and Option Information** on the **Maintenance** tab.

Related Information

➔ [“Windows Printer Driver” on page 158](#)

Checking the Total Number of Pages Fed Through the Printer - Mac OS X

1. Select **System Preferences** from the  menu > **Printers & Scanners** (or **Print & Scan**, **Print & Fax**), and then select the printer.
2. Click **Options & Supplies** > **Utility** > **Open Printer Utility**.
3. Click **Printer and Option Information**.

Saving Power

The printer enters sleep mode or turns off automatically if no operations are performed for a set period. You can adjust the time before power management is applied. Any increase will affect the product's energy efficiency. Please consider the environment before making any change.

Depending on the location of purchase, the printer may have a feature that turns it off automatically if it is not connected to the network for 30 minutes.

Saving Power - Control Panel

1. Enter **Setup** from the home screen, and then select **System Administration**.
2. Select **Common Settings**.
3. Do one of the following.
 - Select **Sleep Timer** or **Power Off Settings** > **Power Off If Inactive** or **Power Off If Disconnected**, and then make settings.
 - Select **Sleep Timer** or **Power Off Timer**, and then make settings.

Note:

*Your product may have the **Power Off Settings** or **Power Off Timer** feature depending on the location of purchase.*

Menu Options for Setup Mode

By selecting **Setup** on the home screen from the control panel, you can make printer settings or perform printer maintenance.

Maintenance Box Service Life

Select the menus on the control panel as described below.

Setup > Maintenance Box Service Life

Displays the approximate service life of the maintenance box. When an exclamation mark is displayed, the maintenance box is nearly full. When a x icon is displayed, the maintenance box is full.

Related Information

➔ [“Replacing a Maintenance Box” on page 137](#)

Menu Options for Maintenance

Select the menus on the control panel as described below.

Setup > Maintenance

Print Head Nozzle Check

Prints a pattern to check if the print head nozzles are clogged.

Print Head Cleaning

Cleans clogged nozzles in the print head.

Reset Ink Levels

Resets the ink levels to 100% when refilling the ink tank.

Print Head Alignment

Adjusts the print head to improve print quality.

Run **Vertical Alignment** if your printouts look blurry or text and lines are misaligned.

Run **Horizontal Alignment** if your printouts contain horizontal banding at regular intervals.

Thick Paper

Reduces ink smearing when printing. Enable this feature only when you see ink smearing on your printouts because it may lower the printing speed.

Paper Guide Cleaning

Use this feature to feed a plain paper for cleaning when there are ink stains on the internal rollers or a paper feed problem has occurred.

Remove Paper

Menu Options for Setup Mode

Use this feature if there are still some torn pieces of paper inside the printer even after removing jammed paper.

Related Information

- ➔ [“Checking and Cleaning the Print Head” on page 139](#)
- ➔ [“Aligning the Print Head” on page 141](#)
- ➔ [“Refilling the Ink Tanks” on page 133](#)
- ➔ [“Cleaning the Paper Path for Ink Smears” on page 142](#)
- ➔ [“Removing Jammed Paper from Inside the Printer” on page 174](#)

Menu Options for Paper Setup

Select the menus on the control panel as described below.

Setup > Paper Setup

Select the paper size and paper type you loaded in the paper source.

Related Information

- ➔ [“Loading Paper” on page 42](#)

Menu Options for Print Status Sheet

Select the menus on the control panel as described below.

Setup > Print Status Sheet

Configuration Status Sheet

Prints an information sheet showing the current printer status and settings.

Supply Status Sheet

Prints an information sheet showing the status of consumables.

Usage History Sheet

Prints an information sheet showing the usage history of the printer.

Menu Options for Network Status

Select the menus on the control panel as described below.

Setup > Network Status

Wi-Fi/Network Status

Displays or prints the current network settings.

Wi-Fi Direct Status

Menu Options for Setup Mode

Displays or prints the current Wi-Fi Direct settings.

Email Server Status

Displays the current email server settings.

Epson Connect Status

Displays whether the printer is registered and connected to Epson Connect.

Google Cloud Print Status

Displays whether the printer is registered and connected to Google Cloud Print.

Related Information

- ➔ [“Making Wi-Fi Settings from the Control Panel” on page 25](#)
- ➔ [“Checking the Network Connection Status” on page 31](#)

Menu Options for Admin Settings

Select the menus on the control panel as described below.

Setup > Admin Settings

These menus allow an administrator to register an administrator password to protect the printer settings from being changed by other users.

Admin Password

Set, change, or reset the administrator password. If you forget the password, contact Epson support.

Lock Setting

Select whether or not to lock the control panel using the password registered in Admin Password.

Related Information

- ➔ [“Locking the Printer Settings Using an Administrator's Password” on page 41](#)

Menu Options for System Administration

Printer Settings

Select the menus on the control panel as described below.

Setup > System Administration > Printer Settings

Paper Source Settings

- A4/Letter Auto Switching

Feeds paper from the paper source set as A4 size when there is no paper source set as Letter, or feeds from the paper source set as Letter size when there is no paper source set as A4.

Menu Options for Setup Mode

Auto Select Settings

Specify which paper source to feed from. When more than one paper source is enabled, paper is fed from one of the paper sources whose paper settings match with the print job.

Error Notice

Select whether or not the printer displays an error message when the paper size or type settings in **Paper Setup** from **Setup** mode and the print settings do not match.

Auto Error Solver

Select an action to perform when a 2-sided printing error occurs.

On

If a 2-sided job is sent when there is no paper available that supports 2-sided printing, the printer displays an error message, and then automatically prints on only one side of the paper.

Off

The printer displays an error message and cancels printing.

Memory Device Interface

Memory Device

Select whether or not the printer can access an inserted memory device. Disable this function to stop data from being saved to the memory device. This prevents confidential documents from being removed illegally.

File Sharing

Select whether to give write access to the memory device from a USB-connected computer or from a network-connected computer.

PC Connection via USB

Select whether or not the printer allows access from a USB-connected computer. Disable this function to restrict printing and scanning that is not sent over a network connection.

Common Settings

Select the menus on the control panel as described below.

Setup > System Administration > Common Settings

LCD Brightness

Adjust the brightness of the LCD screen.

Sound

Adjust the volume and select the type of audio.

Sleep Timer

Select the time period before the printer enters sleep mode (energy saving mode) when no operations are performed. The LCD screen turns black when the set time passes.

Power Off Settings

Menu Options for Setup Mode

Your product may have this feature or the Power Off Timer feature depending on the location of purchase .

Power Off If Inactive

Automatically turns the printer off if no operations are performed for a set time period. You can adjust the time before power management is applied. Any increase will affect the product's energy efficiency. Please consider the environment before making any change.

Power Off If Disconnected

Turns the printer off after 30 minutes when all network ports including the LINE port are disconnected.

Power Off Timer

Your product may have this feature or the Power Off Settings feature depending on the location of purchase .

Automatically turns the printer off if no operations are performed for a set time period. You can adjust the time before power management is applied. Any increase will affect the product's energy efficiency. Please consider the environment before making any change.

Date/Time Settings

Date/Time

Enter the current date and time.

Daylight Saving Time

Select the summer time setting that applies to your area.

Time Difference

Enter the time difference between your local time and UTC (Coordinated Universal Time).

Country/Region

Select the display country or region.

Language

Select the display language.

Operation Time Out

If this feature is enabled, the LCD screen returns to the home screen when no operations have been performed for about three minutes.

Wi-Fi/Network Settings

Select the menus on the control panel as described below.

Setup > System Administration > Wi-Fi/Network Settings

Wi-Fi/Network Status

Displays or prints the network settings and connection status.

Wi-Fi Setup

Menu Options for Setup Mode

Wi-Fi Setup Wizard

Select an SSID, enter a password, and then connect the printer to a wireless (Wi-Fi) network.

Push Button Setup (WPS)

Connect the printer to a wireless network by pressing the WPS button on your wireless router.

PIN Code Setup (WPS)

In the wireless router utility, enter the PIN code displayed on the printer's screen to connect the printer to a wireless (Wi-Fi) network.

Wi-Fi Auto Connect

Connects the printer to a wireless (Wi-Fi) network using a computer that is connected to the access point. Insert the software disc supplied with the printer into the computer, and then follow the on-screen instructions. When you are prompted to operate the printer, run this menu.

Disable Wi-Fi

Disables the connection by turning off the wireless signal without deleting the network information. To enable the connection, set up the wireless (Wi-Fi) network again.

Wi-Fi Direct Setup

Connects the printer to a wireless (Wi-Fi) network without a wireless router.

Connection Check

Checks the status of the network connection and prints the network connection report. If there are any problems with the connection, see the report to solve the problem.

Advanced Setup

Changes the network settings, such as the printer name or TCP/IP Address.

Related Information

- ➔ [“Making Wi-Fi Settings by Push Button Setup \(WPS\)” on page 27](#)
- ➔ [“Making Wi-Fi Settings by PIN Code Setup \(WPS\)” on page 28](#)
- ➔ [“Disabling Wi-Fi from the Control Panel” on page 39](#)
- ➔ [“Making Wi-Fi Direct Settings” on page 28](#)
- ➔ [“Messages and Solutions on the Network Connection Report” on page 33](#)
- ➔ [“Making Advanced Network Settings from the Control Panel” on page 30](#)

Epson Connect Services

Select the menus on the control panel as described below.

Setup > System Administration > Epson Connect Services

How to

Provides a short description of the Epson Connect services.

Settings

- Suspend/Resume

Menu Options for Setup Mode

Select whether to suspend or resume the Epson Connect services.

- Restore Default Settings

Resets the settings to their defaults.

For registration and usage guides, see the following portal website.

<https://www.epsonconnect.com/>

<http://www.epsonconnect.eu> (Europe only)

Related Information

➔ [“Epson Connect Service” on page 156](#)

Google Cloud Print Services

Select the menus on the control panel as described below.

Setup > System Administration > Google Cloud Print Services

How to

Provides a short description of the Google Cloud Print Services.

Settings

- Suspend/Resume

Select whether to suspend or resume the Google Cloud Print Services.

- Restore Default Settings

Resets the settings to their defaults.

For registration and usage guides, see the following portal website.

<https://www.epsonconnect.com/>

<http://www.epsonconnect.eu> (Europe only)

Universal Print Settings

Select the menus on the control panel as described below.

Setup > System Administration > Universal Print Settings

These print settings are applied when you print using an external device without using the printer driver.

Top Offset

Adjust the top margin of the paper.

Left Offset

Adjust the left margin of the paper.

Top Offset in Back

Adjust the top margin for the back of the page when performing 2-sided printing.

Menu Options for Setup Mode

Left Offset in Back

Adjust the left margin for the back of the page when performing 2-sided printing.

Check Paper Width

Checks the paper width before the printer starts printing. This prevents printing beyond the edges of the paper when the paper size setting is not correct. However, the printing time may be little longer.

Dry Time

Select the drying time when performing 2-sided printing.

Skip Blank Page

Skips blank pages in the print data automatically.

Eco Mode

Select the menus on the control panel as described below.

Setup > System Administration > Eco Mode

Applies the settings for energy and resource saving. Enabling this feature allows you to make the following settings. When **Eco Mode** is disabled, the settings made in **Common Settings** are applied.

Configure

Sleep Timer

Select the time period before the printer enters sleep mode (energy saving mode) when no operations are performed. The LCD screen turns black when the set time passes.

LCD Brightness

Adjust the brightness of the LCD screen.

2-Sided (Copy)

Sets 2-sided copying as the default setting.

Restore Default Settings

Select the menus on the control panel as described below.

Setup > System Administration > Restore Default Settings

Wi-Fi/Network Settings

Resets the network settings to the default.

Copy Settings

Resets the settings in the following menus to the default.

Setup > System Administration > Copy Settings

Scan Settings

Resets the settings in the following menus to the default.

Setup > System Administration > Scan Settings

Menu Options for Setup Mode

Fax Settings

Resets the send, receive, connection settings in the following menus to the default.

Setup > System Administration > Fax Settings

Clear All Data and Settings

Resets all settings to the default.

Network Service and Software Information

This section introduces the network services and software products available for your printer from the Epson website or the supplied CD.

Epson Connect Service

By using Epson Connect service available on the Internet, you can print from your smartphone, tablet PC, or laptop, anytime and practically anywhere.

The features available on the Internet are as follows.

Email Print	Epson iPrint remote print	Scan to Cloud	Remote Print Driver
✓	✓	✓	✓

See the Epson Connect portal website for details.

<https://www.epsonconnect.com/>

<http://www.epsonconnect.eu> (Europe only)

Web Config

Web Config is an application that runs in a web browser, such as Internet Explorer and Safari, on a computer or smart device. You can confirm the printer status or change the network service and printer settings. To use the Web Config, connect the printer and the computer or device to the same network.

Note:

The following browsers are supported.

OS	Browser
Windows XP or later	Internet Explorer 8 or later, Firefox*, Chrome*
Mac OS X v10.6.8 or later	Safari*, Firefox*, Chrome*
iOS*	Safari*
Android 2.3 or later	Default browser
Chrome OS*	Default browser

* Use the latest version.

Running Web Config on a Web Browser

1. Check the printer's IP address.

Select **Setup** > **Network Status** > **Wi-Fi/Network Status** from the home screen, and then check the printer's IP address.

2. Launch a Web browser from a computer or smart device, and then enter the printer's IP address.

Format:

IPv4: http://the printer's IP address/

IPv6: http://[the printer's IP address]/

Examples:

IPv4: http://192.168.100.201/

IPv6: http://[2001:db8::1000:1]/

Note:

Using the smart device, you can also run Web Config from the maintenance screen of Epson iPrint.

Related Information

➔ [“Printing Using Epson iPrint” on page 82](#)

Running Web Config on Windows

When connecting a computer to the printer using WSD, follow the steps below to run Web Config.

1. Access the devices and printers screen in Windows.

- Windows 10

Right-click the start button or press and hold it, and then select **Control Panel** > **View devices and printers** in **Hardware and Sound**.

- Windows 8.1/Windows 8/Windows Server 2012 R2/Windows Server 2012

Select **Desktop** > **Settings** > **Control Panel** > **View devices and printers** in **Hardware and Sound** (or **Hardware**).

- Windows 7/Windows Server 2008 R2

Click the start button, and select **Control Panel** > **View devices and printers** in **Hardware and Sound**.

- Windows Vista/Windows Server 2008

Click the start button, and select **Control Panel** > **Printers** in **Hardware and Sound**.

2. Right-click on your printer and select **Properties**.

3. Select the **Web Service** tab and click the URL.

Running Web Config on Mac OS X

1. Select **System Preferences** from the  menu > **Printers & Scanners** (or **Print & Scan**, **Print & Fax**), and then select the printer.

2. Click **Options & Supplies > Show Printer Webpage**.

Windows Printer Driver

The printer driver controls the printer according to the commands from an application. Making settings on the printer driver provides the best printing results. You can also check the status of the printer or keep it in top operating condition using the printer driver utility.

Note:

You can change the language of the printer driver. Select the language you want to use from the **Language** setting on the **Maintenance** tab.

Accessing the printer driver from applications

To make settings that apply only to the application you are using, access from that application.

Select **Print** or **Print Setup** from the **File** menu. Select your printer, and then click **Preferences** or **Properties**.

Note:

Operations differ depending on the application. See the application's help for details.

Accessing the printer driver from the control panel

To make settings that apply to all of the applications, access from the control panel.

Windows 10

Right-click the start button or press and hold it, and then select **Control Panel > View devices and printers in Hardware and Sound**. Right-click on your printer, or press and hold it and then select **Printing preferences**.

Windows 8.1/Windows 8/Windows Server 2012 R2/Windows Server 2012

Select **Desktop > Settings > Control Panel > View devices and printers in Hardware and Sound**. Right-click on your printer, or press and hold it and then select **Printing preferences**.

Windows 7/Windows Server 2008 R2

Click the start button, and select **Control Panel > View devices and printers in Hardware and Sound**. Right-click on your printer and select **Printing preferences**.

Windows Vista/Windows Server 2008

Click the start button, and select **Control Panel > Printers in Hardware and Sound**. Right-click on your printer and select **Select printing preferences**.

Windows XP/Windows Server 2003 R2/Windows Server 2003

Click the start button, and select **Control Panel > Printers and Other Hardware > Printers and Faxes**. Right-click on your printer and select **Printing preferences**.

Accessing the printer driver from the printer icon on the task bar

The printer icon on the desktop task bar is a shortcut icon allowing you to quickly access the printer driver.

If you click the printer icon and select **Printer Settings**, you can access the same printer settings window as the one displayed from the control panel. If you double-click this icon, you can check the status of the printer.

Note:

If the printer icon is not displayed on the task bar, access the printer driver window, click **Monitoring Preferences** on the **Maintenance** tab, and then select **Register the shortcut icon to the taskbar**.

Starting the utility

Access the printer driver window. Click the **Maintenance** tab.

Restricting Settings for the Windows Printer Driver

You can lock some settings of the printer driver so that other users cannot change them.

Note:

Log on to your computer as an administrator.

1. Open the **Optional Settings** tab in printer properties.
 - Windows 10
Right-click the start button or press and hold it, and then select **Control Panel > View devices and printers** in **Hardware and Sound**. Right-click on your printer, or press and hold it and then select **Printer properties**. Click the **Optional Settings** tab.
 - Windows 8.1/Windows 8/Windows Server 2012R2/Windows Server 2012
Select **Desktop > Settings > Control Panel > View devices and printers** in **Hardware and Sound**. Right-click on your printer, or press and hold it and then select **Printer properties**. Click the **Optional Settings** tab.
 - Windows 7/Windows Server 2008 R2
Click the start button, and select **Control Panel > View devices and printers** in **Hardware and Sound**. Right-click on your printer, and then select **Printer properties**. Click the **Optional Settings** tab.
 - Windows Vista/Windows Server 2008
Click the start button, and select **Control Panel > Printers** in **Hardware and Sound**. Right-click on your printer, and then select **Properties**. Click the **Optional Settings** tab.
 - Windows XP/Windows Server 2003 R2/Windows Server 2003
Click the start button, and select **Control Panel > Printers and Other Hardware > Printers and Faxes**. Right-click on your printer, and then select **Properties**. Click the **Optional Settings** tab.
2. Click **Driver Settings**.
3. Select the feature that you want to restrict.
See the online help for explanations of the setting items.
4. Click **OK**.

Making Operation Settings for the Windows Printer Driver

You can make settings such as enabling **EPSON Status Monitor 3**.

1. Access the printer driver window.
2. Click **Extended Settings** on the **Maintenance** tab.
3. Make the appropriate settings, and then click **OK**.
See the online help for explanations of the setting items.

Related Information

➔ [“Windows Printer Driver” on page 158](#)

Mac OS X Printer Driver

The printer driver controls the printer according to the commands from an application. Making settings on the printer driver provides the best printing results. You can also check the status of the printer or keep it in top operating condition using the printer driver utility.

Accessing the printer driver from applications

Click **Page Setup** or **Print** on the **File** menu of your application. If necessary, click **Show Details** (or ▼) to expand the print window.

Note:

*Depending on the application being used, **Page Setup** may not be displayed in the **File** menu, and the operations for displaying the print screen may differ. See the application's help for details.*

Starting the utility

Select **System Preferences** from the  menu > **Printers & Scanners** (or **Print & Scan**, **Print & Fax**), and then select the printer. Click **Options & Supplies** > **Utility** > **Open Printer Utility**.

Making Operation Settings for the Mac OS X Printer Driver

Accessing the Operation Settings Window of the Mac OS X Printer Driver

Select **System Preferences** from the  menu > **Printers & Scanners** (or **Print & Scan**, **Print & Fax**), and then select the printer. Click **Options & Supplies** > **Options** (or **Driver**).

Operation Settings for Mac OS X Printer Driver

- Thick paper and envelopes:** Prevents the ink from smearing when printing on thick paper. However, this may reduce print speed.
- Skip Blank Page:** Avoids printing blank pages.
- Quiet Mode:** Reduces the noise the printer makes, however, may reduce print speed.
- High Speed Printing:** Prints when the print head moves in both directions. The print speed is faster, but the quality may decline.
- Warning Notifications:** Allows the printer driver to display warning notifications.
- Establish bidirectional communication:** Usually, this should be set to **On**. Select **Off** when acquiring the printer information is impossible because the printer is shared with Windows computers on a network or for any other reason.

Epson Scan 2 (Scanner Driver)

Epson Scan 2 is an application for controlling scanning. You can adjust the size, resolution, brightness, contrast, and quality of the scanned image.

Note:

You can also start Epson Scan 2 from a TWAIN-compliant scanning application.

Starting on Windows

Note:

*For Windows Server operating systems, you need to install the **Desktop Experience** feature.*

 Windows 10

Click the start button, and then select **All apps > EPSON > Epson Scan 2**.

 Windows 8.1/Windows 8/Windows Server 2012 R2/Windows Server 2012

Enter the application name in the search charm, and then select the displayed icon.

 Windows 7/Windows Vista/Windows XP/Windows Server 2008 R2/Windows Server 2008/Windows Server 2003 R2/Windows Server 2003

Click the start button, and then select **All Programs** or **Programs > EPSON > Epson Scan 2 > Epson Scan 2**.

Starting on Mac OS X

Note:

Epson Scan 2 does not support the Mac OS X fast user switching feature. Turn off fast user switching.

Select **Go > Applications > Epson Software > Epson Scan 2**.

Epson Event Manager

Epson Event Manager is an application that allows you to manage scanning from the control panel and save images to a computer. You can add your own settings as presets, such as the document type, the save folder location, and the image format. See the application's help for details.

Note:

Windows Server operating systems are not supported.

Starting on Windows

 Windows 10

Click the start button, and then select **All apps > Epson Software > Event Manager**.

 Windows 8.1/Windows 8

Enter the application name in the search charm, and then select the displayed icon.

 Windows 7/Windows Vista/Windows XP

Click the start button, and then select **All Programs** or **Programs > Epson Software > Event Manager**.

Starting on Mac OS X

Select **Go > Applications > Epson Software > Event Manager**.

Related Information

➔ [“Scanning to a Computer” on page 93](#)

PC-FAX Driver (Fax Driver)

PC-FAX driver is an application that allows you to send a document created on a separate application as a fax directly from the computer. PC-FAX driver is installed when you install FAX Utility. See the application's help for details.

Note:

- Windows Server operating systems are not supported.*
- The operation differs depending on the application you used to create the document. See the application's help for details.*

Accessing from Windows

In the application, select **Print** or **Print Setup** from the **File** menu. Select your printer (FAX), and then click **Preferences** or **Properties**.

Accessing from Mac OS X

In the application, select **Print** from the **File** menu. Select your printer (FAX) as the **Printer** setting, and then select **Fax Settings** or **Recipient Settings** from the pop-up menu.

FAX Utility

FAX Utility is an application that allows you to configure various settings for sending faxes from a computer. You can create or edit the contacts list to be used when sending a fax, configure to save received faxes in PDF format on the computer, and so on. See the application's help for details.

Note:

- Windows Server operating systems are not supported.*
- Make sure you have installed the printer driver before installing FAX Utility.*

Starting on Windows

- Windows 10
Click the start button, and select **All apps** > **Epson Software** > **FAX Utility**.
- Windows 8.1/Windows 8
Enter the application name in the search charm, and then select the displayed icon.
- Windows 7/Windows Vista/Windows XP
Click the start button, and select **All Programs** (or **Programs**) > **Epson Software** > **FAX Utility**.

Starting on Mac OS X

Select **System Preferences** from the  menu > **Printers & Scanners** (or **Print & Scan**, **Print & Fax**), and then select the printer (FAX). Click **Options & Supplies** > **Utility** > **Open Printer Utility**.

Epson Easy Photo Print

Epson Easy Photo Print is an application that allows you to easily print photos with various layouts. You can preview the photo image and adjust the images or position. You can also print photos with a frame. See the application's help for details.

Note:

- Windows Server operating systems are not supported.*
- To use this application, the printer driver needs to be installed.*

Starting on Windows

- Windows 10

Click the start button, and then select **All apps > Epson Software > Epson Easy Photo Print**.

- Windows 8.1/Windows 8

Enter the application name in the search charm, and then select the displayed icon.

- Windows 7/Windows Vista/Windows XP

Click the start button, and then select **All Programs** or **Programs > Epson Software > Epson Easy Photo Print**.

Starting on Mac OS X

Select **Go > Applications > Epson Software > Epson Easy Photo Print**.

E-Web Print (for Windows Only)

E-Web Print is an application that allows you to easily print web pages with various layouts. See the application's help for details. You can access the help from the **E-Web Print** menu on the **E-Web Print** tool bar.

Note:

- Windows Server operating systems are not supported.*
- Check for supported browsers and the latest version from the download site.*

Starting

When you install E-Web Print, it is displayed in your browser. Click **Print** or **Clip**.

EPSON Software Updater

EPSON Software Updater is an application that checks for new or updated software on the internet and installs it. You can also update the printer's firmware and manual.

Note:

Windows Server operating systems are not supported.

Starting on Windows

- Windows 10

Click the start button, and then select **All apps > Epson Software > EPSON Software Updater**.

Network Service and Software Information

Windows 8.1/Windows 8

Enter the application name in the search charm, and then select the displayed icon.

Windows 7/Windows Vista/Windows XP

Click the start button, and then select **All Programs** (or **Programs**) > **Epson Software** > **EPSON Software Updater**.

Note:

*You can also start EPSON Software Updater by clicking the printer icon on the task bar on the desktop, and then selecting **Software Update**.*

Starting on Mac OS X

Select **Go** > **Applications** > **Epson Software** > **EPSON Software Updater**.

EpsonNet Config

EpsonNet Config is an application that allows you to set the network interface addresses and protocols. See the operations guide for EpsonNet Config or the application's help for more details.

Starting on Windows

Windows 10

Click the start button, and select **All apps** > **EpsonNet** > **EpsonNet Config V4** > **EpsonNet Config**.

Windows 8.1/Windows 8/Windows Server 2012 R2/Windows Server 2012

Enter the application name in the search charm, and then select the displayed icon.

Windows 7/Windows Vista/Windows XP/Windows Server 2008 R2/Windows Server 2008/Windows Server 2003 R2/Windows Server 2003

Click the start button, and select **All Programs** (or **Programs**) > **EpsonNet** > **EpsonNet Config V4** > **EpsonNet Config**.

Starting on Mac OS X

Select **Go** > **Applications** > **Epson Software** > **EpsonNet** > **EpsonNet Config V4** > **EpsonNet Config**.

Uninstalling Applications

Note:

Log on to your computer as an administrator. Enter the administrator password if the computer prompts you.

Uninstalling Applications - Windows

1. Press the  button to turn off the printer.
2. Quit all running applications.
3. Open **Control Panel**:
 - Windows 10

Network Service and Software Information

Right-click the start button or press and hold it, and then select **Control Panel**.

- Windows 8.1/Windows 8/Windows Server 2012 R2/Windows Server 2012

Select **Desktop > Settings > Control Panel**.

- Windows 7/Windows Vista/Windows XP/Windows Server 2008 R2/Windows Server 2008/Windows Server 2003 R2/Windows Server 2003

Click the start button and select **Control Panel**.

4. Open **Uninstall a program** (or **Add or Remove Programs**):

- Windows 10/Windows 8.1/Windows 8/Windows 7/Windows Vista/Windows Server 2012 R2/Windows Server 2012/Windows Server 2008 R2/Windows Server 2008

Select **Uninstall a program** in **Programs**.

- Windows XP/Windows Server 2003 R2/Windows Server 2003

Click **Add or Remove Programs**.

5. Select the application you want to uninstall.

6. Uninstall the applications:

- Windows 10/Windows 8.1/Windows 8/Windows 7/Windows Vista/Windows Server 2012 R2/Windows Server 2012/Windows Server 2008 R2/Windows Server 2008

Click **Uninstall/Change** or **Uninstall**.

- Windows XP/Windows Server 2003 R2/Windows Server 2003

Click **Change/Remove** or **Remove**.

Note:

*If the **User Account Control** window is displayed, click **Continue**.*

7. Follow the on-screen instructions.

Uninstalling Applications - Mac OS X

1. Download the Uninstaller using EPSON Software Updater.

Once you have downloaded the Uninstaller, you do not need to download it again each time you uninstall the application.

2. Press the  button to turn off the printer.

3. To uninstall the printer driver or PC-FAX driver, select **System Preferences** from the  menu > **Printers & Scanners** (or **Print & Scan, Print & Fax**), and then remove the printer from the enabled printers list.

4. Quit all running applications.

5. Select **Go > Applications > Epson Software > Uninstaller**.

Network Service and Software Information

6. Select the application you want to uninstall, and then click **Uninstall**.

 **Important:**

The Uninstaller removes all drivers for Epson inkjet printers on the computer. If you use multiple Epson inkjet printers and you only want to delete some drivers, delete all of them first, and then install the necessary printer driver again.

Note:

*If you cannot find the application you want to uninstall in the application list, you cannot uninstall using the Uninstaller. In this situation, select **Go > Applications > Epson Software**, select the application you want to uninstall, and then drag it to the trash icon.*

Related Information

- ➔ [“EPSON Software Updater” on page 163](#)

Installing Applications

Connect your computer to the network and install the latest version of applications from the website.

Note:

- Log on to your computer as an administrator. Enter the administrator password if the computer prompts you.
- When reinstalling an application, you need to uninstall it first.

1. Quit all running applications.
2. When installing the printer driver or Epson Scan 2, disconnect the printer and the computer temporarily.

Note:

Do not connect the printer and the computer until you are instructed to do so.

3. Access to the following website, and then enter the product name.

<http://epson.sn>

4. Go to **Setup** and then click **Download**. Click or double-click the downloaded file to run the installer. Follow the on-screen instructions.

Note:

If you are using a Windows computer and you cannot download applications from the website, install them from the software disc that came with the printer.

Related Information

- ➔ [“Uninstalling Applications” on page 164](#)

Updating Applications and Firmware

You may be able to clear certain problems and improve or add functions by updating the applications and the firmware. Make sure you use the latest version of the applications and firmware.

1. Make sure that the printer and the computer are connected, and the computer is connected to the internet.

Network Service and Software Information

2. Start EPSON Software Updater, and update the applications or the firmware.



Important:

Do not turn off the computer or the printer while updating.

Note:

If you cannot find the application you want to update in the list, you cannot update using the EPSON Software Updater. Check for the latest versions of the applications from your local Epson website.

<http://www.epson.com>

Related Information

- ➔ [“EPSON Software Updater” on page 163](#)

Solving Problems

Checking the Printer Status

Checking Messages on the LCD Screen

If an error message is displayed on the LCD screen, follow the on-screen instructions or the solutions below to solve the problem.

Error Messages	Solutions
Printer error. Turn the power off and on again. For details, see your documentation.	Remove any paper or protective material in the printer and the paper cassette. If the error message is still displayed after turning the power off and on again, contact Epson support.
No dial tone detected.	<p>This problem might be resolved by selecting Setup > System Administration > Fax Settings > Basic Settings > Line Type, and then selecting PBX. If your phone system requires an external access code to get an outside line, set the access code after selecting PBX. Use # (hash) instead of the actual access code when entering an outside fax number. This makes connection more secure.</p> <p>If the error message is still displayed, set the Dial Tone Detection settings to disabled. However, disabling this feature may drop the first digit of a fax number and send the fax to the wrong number.</p>
Failed to receive faxes because the fax data capacity is full. Press [i] for details.	<p>Received faxes may accumulate without being processed due to the following reasons.</p> <ul style="list-style-type: none"> <input type="checkbox"/> Cannot print because a printer error has occurred. Clear the printer error. To check the details and solutions to the error, press the i button and then select Printer Information. <input type="checkbox"/> Cannot save in the computer or the memory device. To check whether or not received faxes have been saved, press the i button and then select Job Monitor > Communication Job. To save received faxes, turn on the computer or connect a memory device to the printer.
Combination of the IP address and the subnet mask is invalid. See your documentation.	Enter the correct IP address or default gateway. Contact your network administrator for assistance.
Root certificate expired. Update the root certificate to use cloud services.	Run Web Config, and then update the root certificate.
Recovery Mode	<p>The printer has started in recovery mode because the firmware update failed. Follow the steps below to try to update the firmware again.</p> <ol style="list-style-type: none"> 1. Connect the computer and the printer with a USB cable. (During recovery mode, you cannot update the firmware over a network connection.) 2. Visit your local Epson website for further instructions.

Related Information

➔ [“Contacting Epson Support” on page 227](#)

Solving Problems

- ➔ “Installing Applications” on page 166
- ➔ “Updating Applications and Firmware” on page 166

Error Code on the Status Menu

If a job does not complete successfully, check the error code displayed on the history of each job. You can check the error code by pressing the **i** button, and then selecting **Job History**. See the following table to find the problem and its solution.

Code	Problem	Solution
001	The product was turned off by a power failure.	-
109	The received fax was already deleted.	-
110	The job was printed on one side only because the paper loaded does not support double sided printing.	If you want to perform 2-sided printing, load paper that supports 2-sided printing.
201	The memory is full.	<ul style="list-style-type: none"> <input type="checkbox"/> Print received faxes from Job Monitor in Job Storage. <input type="checkbox"/> Delete received faxes saved in the inbox from Job Storage in Status Menu. <input type="checkbox"/> If you are sending a monochrome fax to a single destination, you can send it by using Direct Send. <input type="checkbox"/> Divide your originals in two or more to send them in several batches.
202	The line was disconnected by the recipient machine.	Wait for a while and then try again.
203	The product cannot detect the dial tone.	<ul style="list-style-type: none"> <input type="checkbox"/> Make sure that the phone cable is connected correctly and the phone line is working. <input type="checkbox"/> When the printer is connected to the PBX or the terminal adapter, change the Line Type setting to PBX. <input type="checkbox"/> Select Setup > System Administration > Fax Settings > Basic Settings > Dial Tone Detection, and then disable the dial tone setting.
204	The recipient machine is busy.	Wait for a while and then try again.
205	The recipient machine does not answer.	Wait for a while and then try again.
206	The phone cable is incorrectly connected to the LINE and EXT. port of the product.	Check the connection of the LINE port and the EXT. port of the printer.
207	The product is not connected to the phone line.	Connect the phone cable to the phone line.
208	The fax could not be sent to some of the specified recipients.	Print a Fax Log or Last Transmission report for previous faxes from Fax Report in the Fax mode to check the failed destination. When the Save Failure Data setting is enabled, you can resend a fax from Job Monitor in Status Menu .

Solving Problems

Code	Problem	Solution
301	There is not enough storage space available to save the data in the memory device.	<ul style="list-style-type: none"> <input type="checkbox"/> Increase the storage space in the memory device. <input type="checkbox"/> Reduce the number of documents. <input type="checkbox"/> Lower the scanning resolution or increase the compression ratio to reduce the size of the scanned image.
302	The memory device is write-protected.	Disable write protection on the memory device.
303	No folder has been created to save the scanned image.	Insert another memory device.
304	The memory device has been removed.	Reinsert the memory device.
305	An error occurred while saving the data to the memory device.	If the external device is accessed from a computer, wait for a while and then try again.
306	The memory is full.	Wait until other ongoing jobs are finished.
311	A DNS error has occurred.	<ul style="list-style-type: none"> <input type="checkbox"/> Select Setup > System Administration > Wi-Fi/ Network Settings > Advanced Setup > DNS Server, and then check the DNS settings. <input type="checkbox"/> Check the DNS settings for the server, the computer, or the access point.
312	An authentication error has occurred.	Select Setup > System Administration > Wi-Fi/ Network Settings > Advanced Setup > Email Server > Server Settings , and then check the server settings.
313	A communication error has occurred.	<ul style="list-style-type: none"> <input type="checkbox"/> Print a network connection report to check if the printer is connected to the network. <input type="checkbox"/> Select Setup > System Administration > Wi-Fi/ Network Settings > Advanced Setup > Email Server > Server Settings to check if the email server settings are correct. <input type="checkbox"/> The authentication method of the settings and the email server may not match. When you select Off as the authentication method, make sure the authentication method of the email server is set to None. <input type="checkbox"/> Run Connection Check for the email server to confirm the error. See the <i>Administrator's Guide</i> for more details.
314	The data size exceeds the maximum size for attached files.	<ul style="list-style-type: none"> <input type="checkbox"/> Increase the Attached File Max Size setting in the scan settings. <input type="checkbox"/> Lower the scanning resolution or increase the compression ratio to reduce the size of the scanned image.
315	The memory is full.	Retry after other ongoing jobs are finished.

Solving Problems

Code	Problem	Solution
321	A DNS error has occurred.	<ul style="list-style-type: none"> <input type="checkbox"/> Select Setup > System Administration > Wi-Fi/ Network Settings > Advanced Setup > DNS Server, and then check the DNS settings. <input type="checkbox"/> Check the DNS settings for the server, the computer, or the access point.
322	An authentication error has occurred.	Check the Location settings.
323	A communication error has occurred.	<ul style="list-style-type: none"> <input type="checkbox"/> Print a network connection report to check if the printer is connected to the network. <input type="checkbox"/> Check if the Location settings are correct. Access the selected folder from a computer to check if it is accessible. <input type="checkbox"/> Check if communication is blocked by a Firewall.
324	A file with the same name already exists in the specified folder.	<ul style="list-style-type: none"> <input type="checkbox"/> Delete the file with the same name. <input type="checkbox"/> Change the file name prefix in File Settings.
325	There is not enough storage space available in the specified folder.	<ul style="list-style-type: none"> <input type="checkbox"/> Increase the storage space in the specified folder. <input type="checkbox"/> Reduce the number of documents. <input type="checkbox"/> Lower the scanning resolution or increase the compression ratio to reduce the size of the scanned image.
327	The memory is full.	Wait until other ongoing jobs are finished.
328	The destination was wrong or the destination does not exist.	Check the Location settings.
331	A communication error occurred while acquiring the destination list.	<ul style="list-style-type: none"> <input type="checkbox"/> Print a network connection report to check if the printer is connected to the network. <input type="checkbox"/> Check if the printer is registered to the Epson Connect services and a Destination List has been created. See the Epson Connect portal website for details. https://www.epsonconnect.com/ http://www.epsonconnect.eu (Europe only)
332	There is not enough storage space available to save the scanned image in the destination storage.	Reduce the number of documents.
333	The destination could not be found because the destination information was uploaded to the server before sending the scanned image.	Select the destination again.
334	An error occurred while sending the scanned image.	-
341	A communication error has occurred.	<ul style="list-style-type: none"> <input type="checkbox"/> Check the connections for the printer and the computer. If you are connecting over a network, print a network connection report to check if the printer is connected to the network. <input type="checkbox"/> Make sure that Epson Event Manager is installed on the computer.
401	There is not enough storage space available to save the data in the memory device.	Increase the storage space in the memory device.

Solving Problems

Code	Problem	Solution
402	The memory device is write-protected.	Disable write protection on the memory device.
404	The memory device has been removed.	Reinsert the memory device.
405	An error occurred while saving the data to the memory device.	<ul style="list-style-type: none"> <input type="checkbox"/> Reinsert the memory device. <input type="checkbox"/> Use a different memory device on which you have created a folder using the Create Folder to Save function.
411	A DNS error has occurred.	<ul style="list-style-type: none"> <input type="checkbox"/> Select Setup > System Administration > Wi-Fi/ Network Settings > Advanced Setup > DNS Server, and then check the DNS settings. <input type="checkbox"/> Check the DNS settings for the server, the computer, or the access point.
412	An authentication error has occurred.	Select Setup > System Administration > Wi-Fi/ Network Settings > Advanced Setup > Email Server > Server Settings , and then check the server settings.
413	A communication error has occurred.	<ul style="list-style-type: none"> <input type="checkbox"/> Print a network connection report to check if the printer is connected to the network. <input type="checkbox"/> Select Setup > System Administration > Wi-Fi/ Network Settings > Advanced Setup > Email Server > Server Settings to check if the email server settings are correct. <input type="checkbox"/> The authentication method of the settings and the email server may not match. When you select Off as the authentication method, make sure the authentication method of the email server is set to None. <input type="checkbox"/> Run Connection Check for the email server to confirm the error. See the <i>Administrator's Guide</i> for more details.
421	A DNS error has occurred.	<ul style="list-style-type: none"> <input type="checkbox"/> Select Setup > System Administration > Wi-Fi/ Network Settings > Advanced Setup > DNS Server, and then check the DNS settings. <input type="checkbox"/> Check the DNS settings for the server, the computer, or the access point.
422	An authentication error has occurred.	Select Setup > System Administration > Fax Settings > Output Settings > Fax Output > Other Settings , and then check the settings of the folder selected in Where to Forward .

Solving Problems

Code	Problem	Solution
423	A communication error has occurred. It is also possible that a file with the same name is open or the file is a read-only file.	<ul style="list-style-type: none"> <input type="checkbox"/> Print a network connection report to check if the printer is connected to the network. <input type="checkbox"/> Select Setup > System Administration > Fax Settings > Output Settings > Fax Output > Other Settings, and then check the settings of the folder selected in Where to Forward. <input type="checkbox"/> Close the file with the same name or disable the read-only protection. <input type="checkbox"/> Access the selected folder from a computer to check if it is accessible. <input type="checkbox"/> Check if communication is blocked by a Firewall.
425	There is not enough storage space available in the forwarding destination folder.	Increase the storage space in the forwarding destination folder.
428	The destination was wrong or the destination does not exist.	Select Setup > System Administration > Fax Settings > Output Settings > Fax Output > Other Settings , and then check the settings of the folder selected in Where to Forward .

Related Information

- ➔ [“Connecting to a Phone Line” on page 102](#)
- ➔ [“Printing a Network Connection Report” on page 32](#)
- ➔ [“Checking an Email Server Connection” on page 227](#)
- ➔ [“Epson Connect Service” on page 156](#)
- ➔ [“Menu Options for Scanning to a Computer” on page 94](#)
- ➔ [“Fax Settings Options” on page 126](#)
- ➔ [“Available Paper and Capacities” on page 43](#)

Checking the Printer Status - Windows

1. Access the printer driver window.
2. Click **EPSON Status Monitor 3** on the **Maintenance** tab.

Note:

- You can also check the printer status by double-clicking the printer icon on the taskbar. If the printer icon is not added to the taskbar, click **Monitoring Preferences** on the **Maintenance** tab, and then select **Register the shortcut icon to the taskbar**.
- If **EPSON Status Monitor 3** is disabled, click **Extended Settings** on the **Maintenance** tab, and then select **Enable EPSON Status Monitor 3**.

Related Information

- ➔ [“Windows Printer Driver” on page 158](#)

Checking Printer Status - Mac OS X

1. Select **System Preferences** from the  menu > **Printers & Scanners** (or **Print & Scan, Print & Fax**), and then select the printer.
2. Click **Options & Supplies** > **Utility** > **Open Printer Utility**.
3. Click **EPSON Status Monitor**.

Removing Jammed Paper

Check the error displayed on the control panel and follow the instructions to remove the jammed paper including any torn pieces. Next, clear the error.

**Important:**

Remove the jammed paper carefully. Removing the paper vigorously may cause damage to the printer.

Removing Jammed Paper from the Rear Paper Feed Slot

Remove the jammed paper.

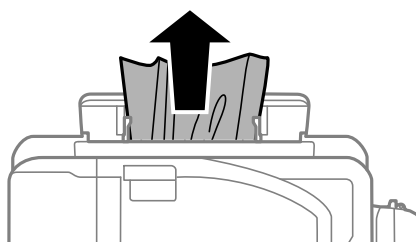

Removing Jammed Paper from Inside the Printer

**Caution:**

- Be careful not to trap your hand or fingers when opening or closing the scanner unit. Otherwise you may be injured.
- Never touch the buttons on the control panel while your hand is inside the printer. If the printer starts operating, it could cause an injury. Be careful not to touch the protruding parts to avoid injury.

Solving Problems

1. Open the scanner unit with the document cover closed.

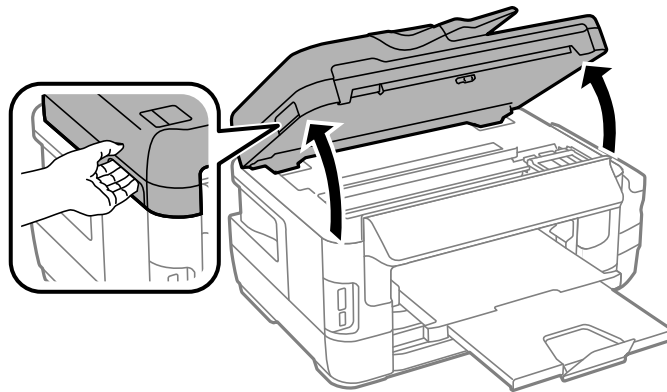

2. Remove the jammed paper.

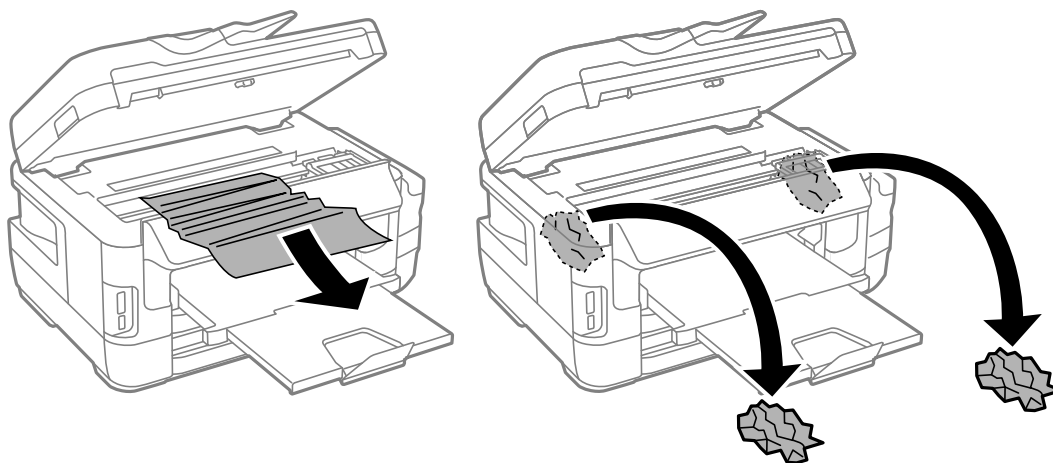

! **Important:**

Do not touch the white flat cable, translucent part, and ink tubes inside the printer. Doing so may cause a malfunction.

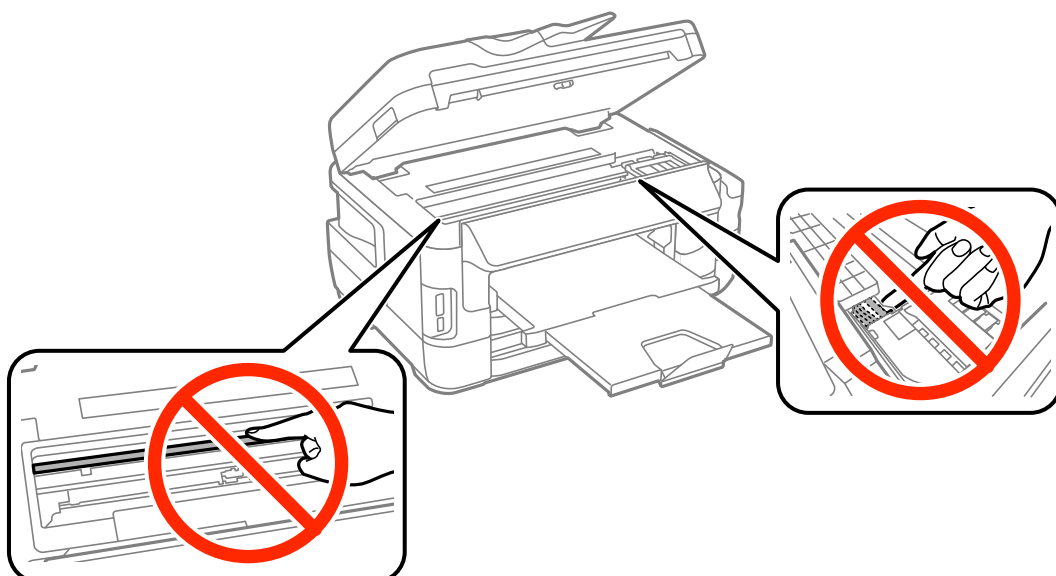

Solving Problems

3. Close the scanner unit.

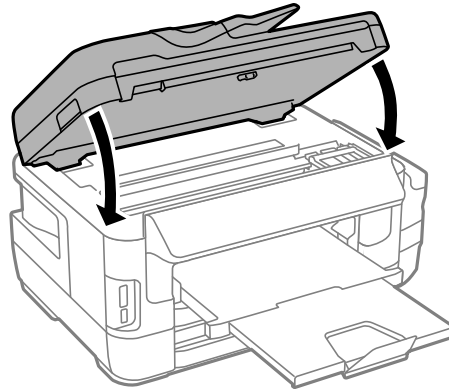

Note:

If any torn pieces of paper remain, select **Remove Paper** on the control panel as described below after clearing the paper jam error. This helps you to remove the remaining pieces of paper.

Setup > Maintenance > Remove Paper

Removing Jammed Paper from the Paper Cassette

1. Close the output tray.
2. Pull out the paper cassette.

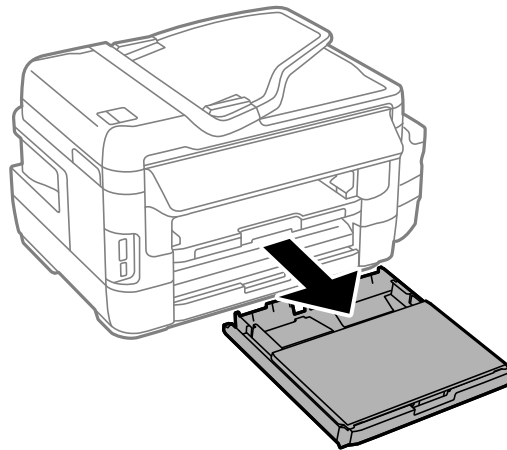

Solving Problems

3. Remove the paper cassette cover.

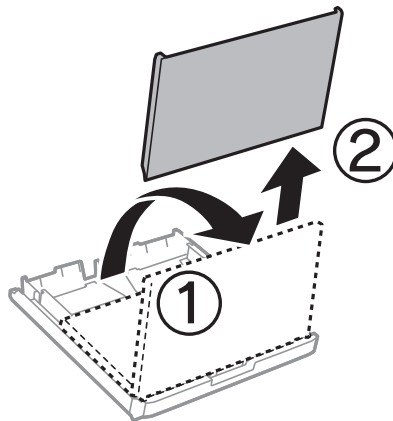

4. Remove the jammed paper from the paper cassette.
5. Remove the jammed paper inside the printer.

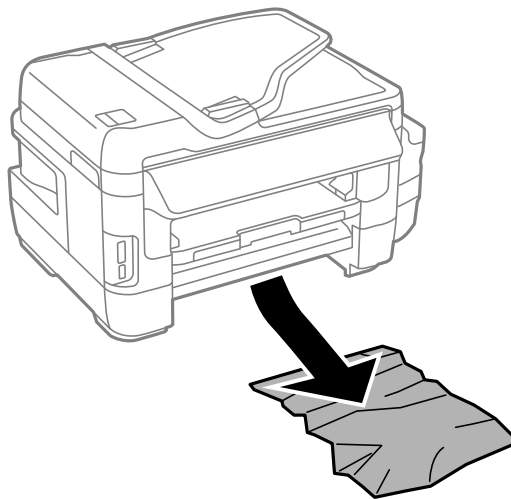

Solving Problems

- Align the edges of the paper and slide the edge guides to the edges of the paper.

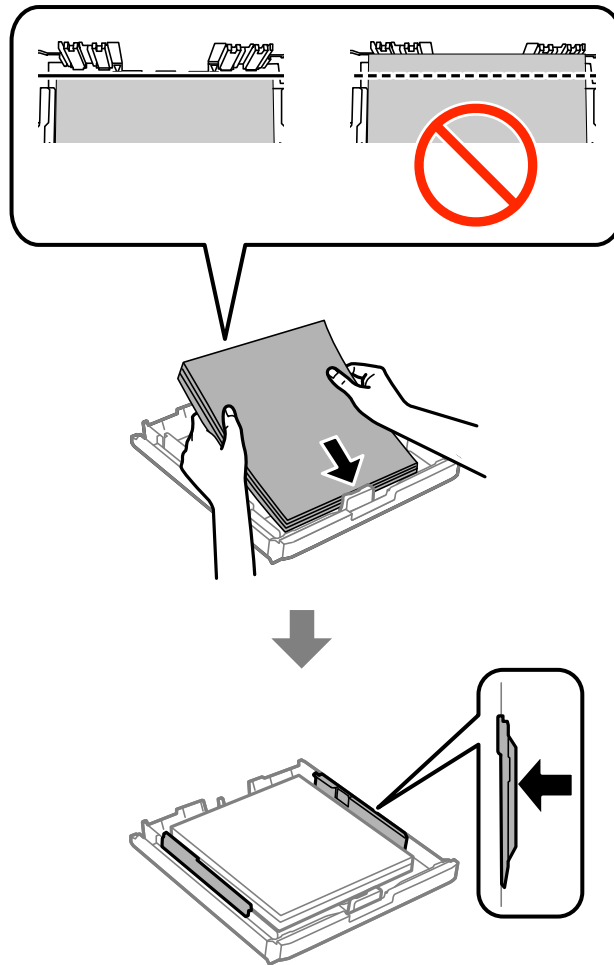

- Put the paper cassette cover back on.
- Insert the paper cassette in the printer.

Solving Problems

Removing Jammed Paper from Rear Cover 1 and Rear Cover 2

1. Turn the product around.



Important:

If you need to change the position of the printer, two people are required to lift the printer.

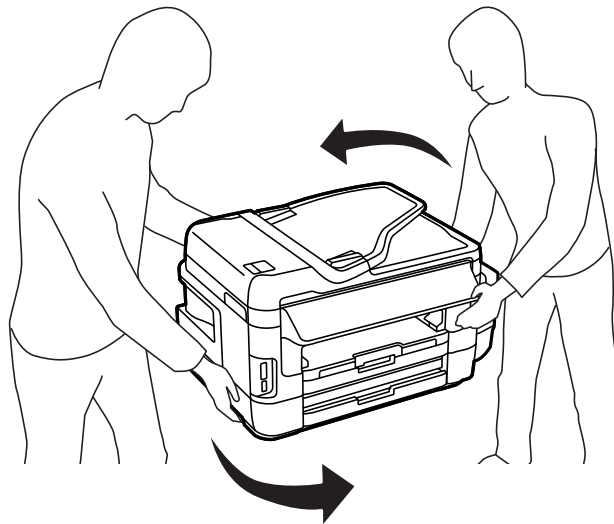

2. Open rear cover 1.

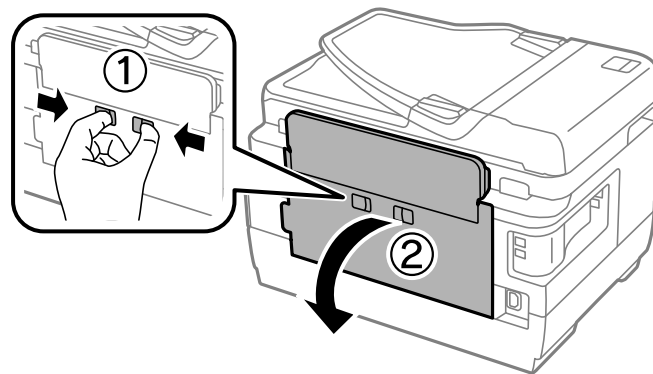

Solving Problems

3. Remove the jammed paper.

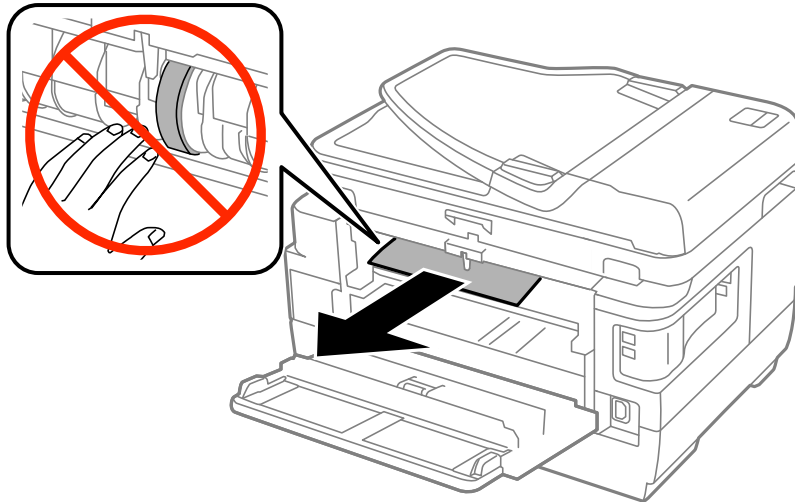

4. Pull out rear cover 2.

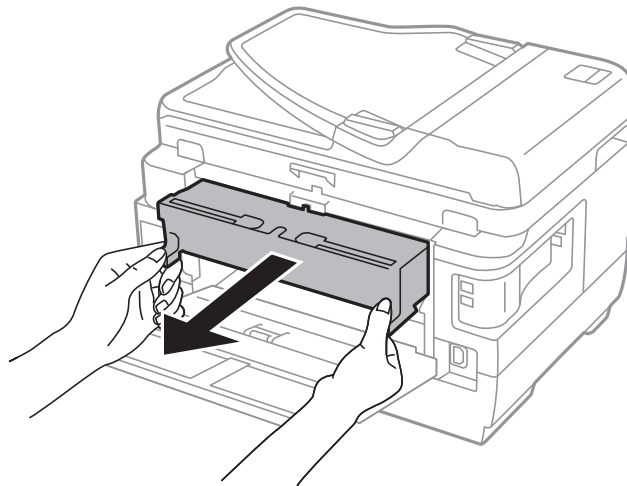

5. Remove the jammed paper.

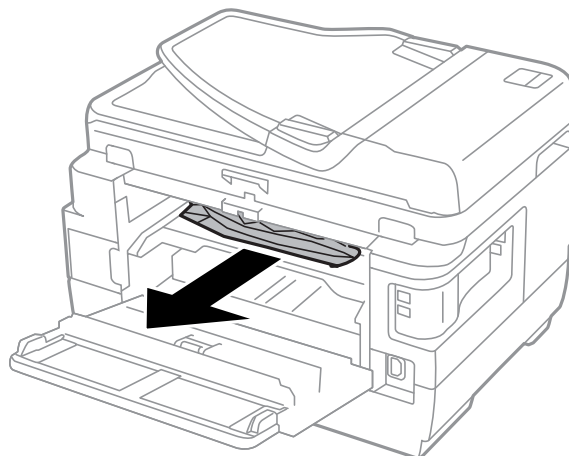

Solving Problems

6. Remove the jammed paper from rear cover 2.

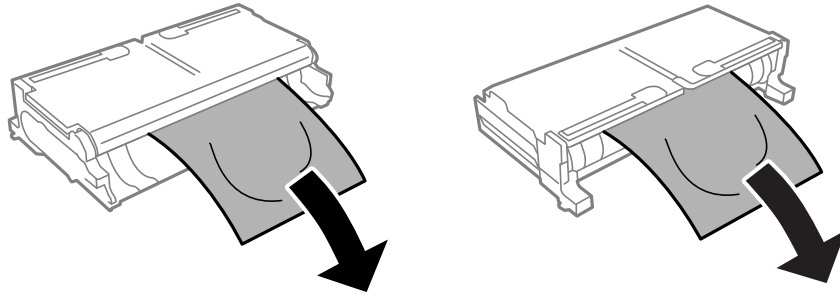

7. Open rear cover 2.

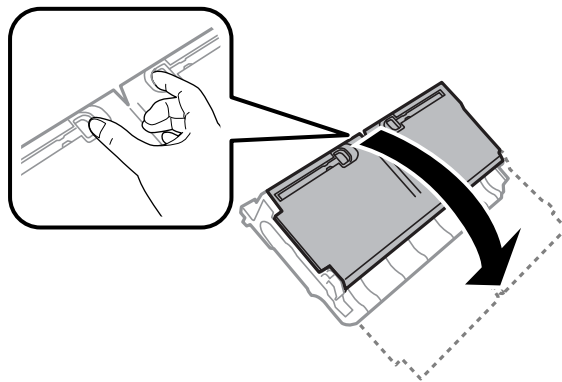

8. Remove the jammed paper.

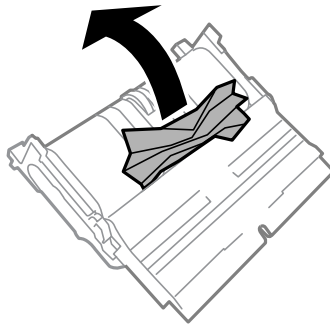

9. Close rear cover 2.
10. Insert rear cover 2 in the printer.
11. Close rear cover 1.

Removing Jammed Paper from the ADF



Caution:

Be careful not to trap your fingers when closing the document cover. Otherwise you may be injured.

Solving Problems

1. Open the ADF cover.

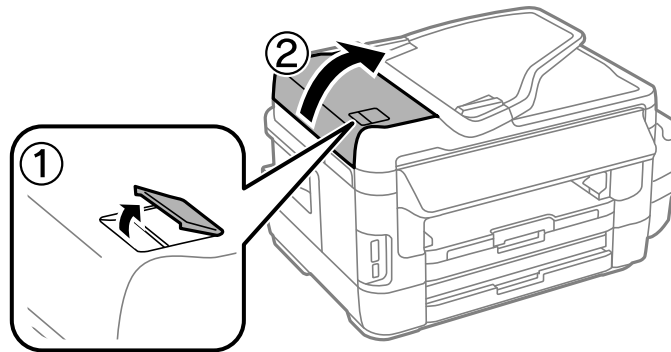

2. Remove the jammed paper.

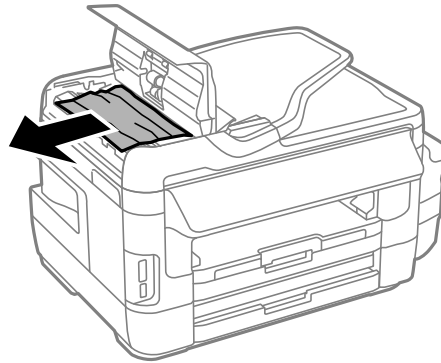

3. Close the ADF cover.

4. Open the document cover.

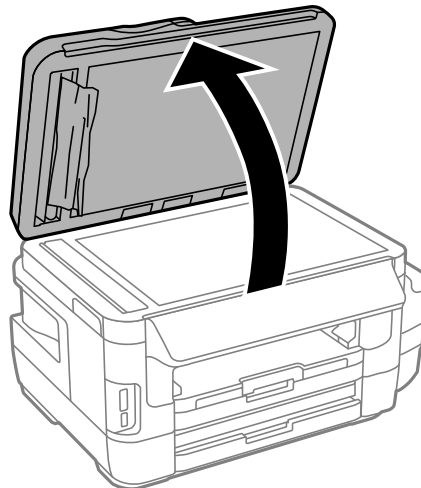

Solving Problems

- Remove the jammed paper.

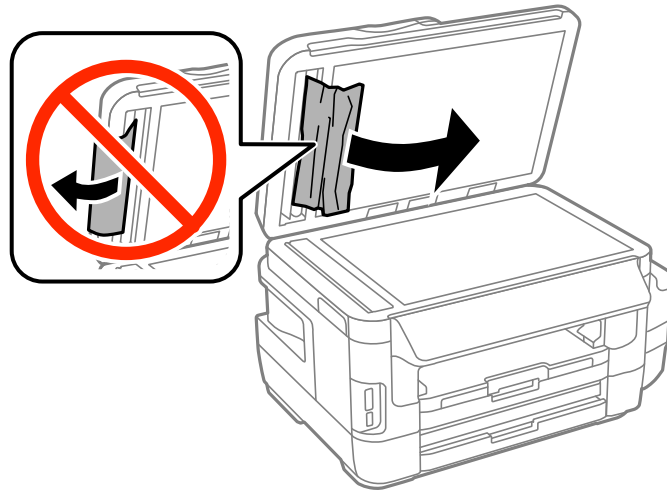

- Close the document cover.
- Raise the ADF input tray, and then remove the jammed paper.

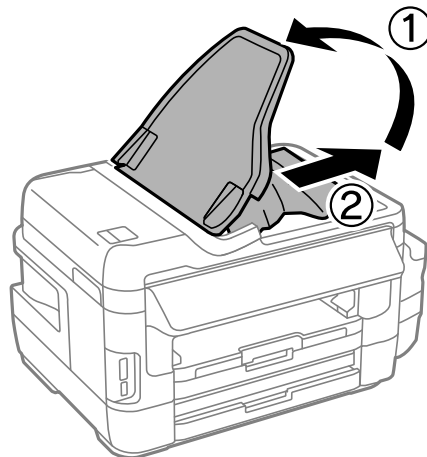

Paper Does Not Feed Correctly

Check the following points, and then take the appropriate actions to solve the problem.

- Place the printer on a flat surface and operate in the recommended environmental conditions.
- Use paper supported by this printer.
- Follow the paper handling precautions.
- Make sure the paper size and paper type settings match the actual paper size and paper type loaded in the printer.

Related Information

- ➔ [“Environmental Specifications” on page 218](#)
- ➔ [“Paper Handling Precautions” on page 42](#)
- ➔ [“Available Paper and Capacities” on page 43](#)

Solving Problems

➔ [“List of Paper Types” on page 44](#)

Paper Jams

Load paper in the correct direction, and slide the edge guides against the edges of the paper.

Related Information

- ➔ [“Removing Jammed Paper” on page 174](#)
- ➔ [“Loading Paper in the Paper Cassette” on page 45](#)
- ➔ [“Loading Paper in the Rear Paper Feed Slot” on page 48](#)

Paper Feeds at a Slant

Load paper in the correct direction, and slide the edge guides against the edges of the paper.

Related Information

- ➔ [“Loading Paper in the Paper Cassette” on page 45](#)
- ➔ [“Loading Paper in the Rear Paper Feed Slot” on page 48](#)

Several Sheets of Paper are Fed at a Time

When several sheets of paper are fed at a time during manual 2-sided printing, remove any paper which is loaded in the printer before you reload the paper.

No Paper Feeds

Do not load more than the maximum number of sheets specified for the paper. For plain paper, do not load above the line indicated by the triangle symbol on the edge guide.

Related Information

- ➔ [“Available Paper and Capacities” on page 43](#)

Original Does Not Feed in the ADF

- Use originals supported by the ADF.
- Load originals in the correct direction, and slide the ADF edge guides against the edges of the originals.
- Clean the inside of the ADF.

Solving Problems

- ❑ Do not load originals above the line indicated by the triangle symbol on the ADF.

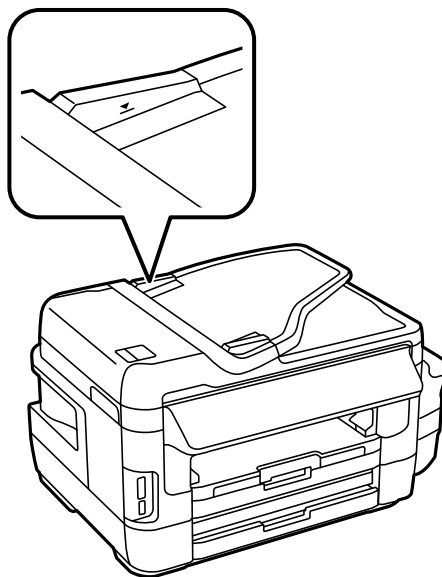

- ❑ Check that the ADF icon appears on the control panel. If it does not appear, place the originals again.

Related Information



- ➔ [“Available Originals on the ADF” on page 52](#)
- ➔ [“Placing Originals on the ADF” on page 52](#)
- ➔ [“Cleaning the ADF” on page 143](#)

Power and Control Panel Problems

Power Does Not Turn On

- ❑ Make sure the power cord is securely plugged in.
- ❑ Hold down the  button for a little longer.

Power Does Not Turn Off

Hold down the  button for a little longer. If you still cannot turn off the printer, unplug the power cord. To prevent the print head from drying out, turn the printer back on and turn it off by pressing the  button.

Power Turns Off Automatically

- ❑ Select **Setup > System Administration > Common Settings > Power Off Settings**, and then disable the **Power Off If Inactive** and **Power Off If Disconnected** settings.
- ❑ Select **Setup > System Administration > Common Settings**, and then disable the **Power Off Timer** setting.

Note:

Your product may have the **Power Off Settings** or **Power Off Timer** feature depending on the location of purchase.

LCD Screen Gets Dark

The printer is in sleep mode. Press anywhere on the LCD screen to return it to its former state.

Cannot Print from a Computer

- Install the printer driver.
- Connect the USB cable securely to the printer and the computer.
- If you are using a USB hub, try to connect the printer directly to the computer.
- If you cannot print over a network, see the page that describes the network connection method from the computer.
- If you are printing a large data size image, the computer may run out of memory. Print the image at a lower resolution or a smaller size.
- In Windows, click **Print Queue** on the printer driver's **Maintenance** tab, and then check the following.
 - Check if there are any paused print jobs.
Cancel printing if necessary.
 - Make sure the printer is not offline or pending.
If the printer is offline or pending, clear the offline or pending setting from the **Printer** menu.
 - Make sure the printer is selected as the default printer from the **Printer** menu (there should be a check mark on the menu item).
If the printer is not selected as the default printer, set it as the default printer.
 - Make sure the printer port is selected correctly in **Property** > **Port** from the **Printer** menu as follows.
Select "USBXXX" for a USB connection, or "EpsonNet Print Port" for a network connection.
- In Mac OS X, make sure the printer status is not **Pause**.
Select **System Preferences** from the  menu > **Printers & Scanners** (or **Print & Scan**, **Print & Fax**), and then double-click the printer. If the printer is paused, click **Resume** (or **Resume Printer**).

Related Information

- ➔ ["Connecting to a Computer" on page 24](#)
- ➔ ["Installing Applications" on page 166](#)
- ➔ ["Canceling Printing" on page 83](#)

When You Cannot Make Network Settings

- Turn off the devices you want to connect to the network. Wait for about 10 seconds, and then turn on the devices in the following order; access point, computer or smart device, and then printer. Move the printer and computer or smart device closer to the access point to help with radio wave communication, and then try to make network settings again.
- Press  on the home screen. Select **Menu** > **Wi-Fi/Network Settings** > **Connection Check**, and then print the network connection report. If an error has occurred, check the network connection report and then follow the printed solutions.

Solving Problems

Related Information

- ➔ “Cannot Connect from Devices Even Though Network Settings are No Problem” on page 187
- ➔ “Messages and Solutions on the Network Connection Report” on page 33

Cannot Connect from Devices Even Though Network Settings are No Problem

If you cannot connect from the computer or smart device to the printer even though the network connection report does not show any problems, see the following.

- ❑ When you are using multiple access points at the same time, you may not be able to use the printer from the computer or smart device depending on the settings of the access points. Connect the computer or smart device to the same access point as the printer.

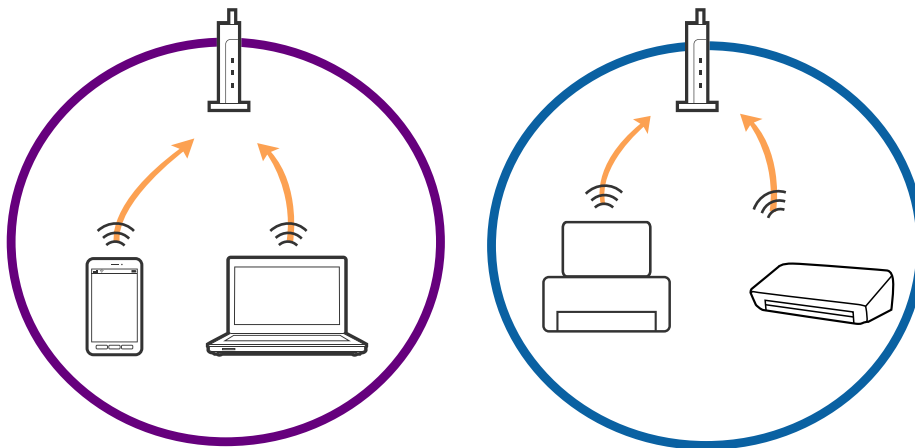

- ❑ You may not be able to connect to the access point when the access point has multiple SSIDs and devices are connected to different SSIDs on the same access point. Connect the computer or smart device to the same SSID as the printer.

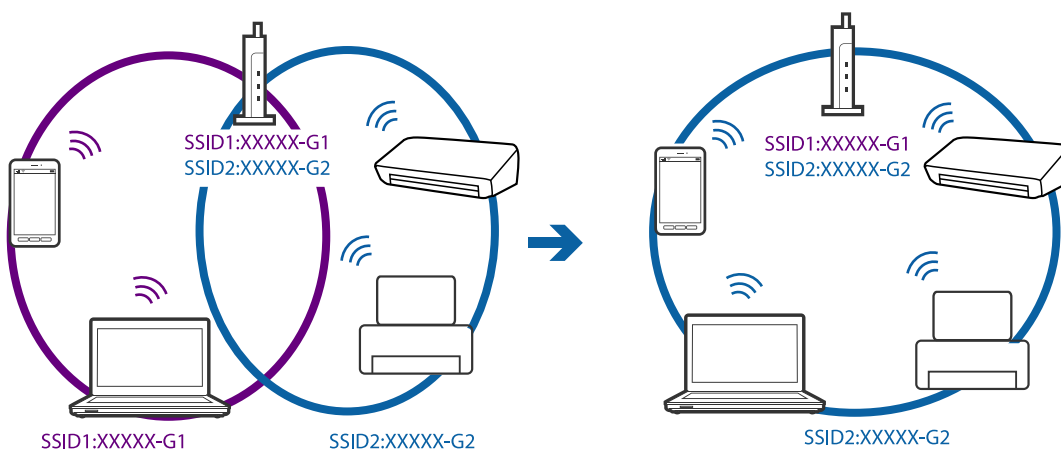

Solving Problems

- ❑ An access point that is compliant with both IEEE802.11a and IEEE802.11g has SSIDs of 2.4 GHz and 5 GHz. If you connect the computer or smart device to a 5 GHz SSID, you cannot be able to connect to the printer because the printer only supports communication over 2.4 GHz. Connect the computer or smart device to the same SSID as the printer.

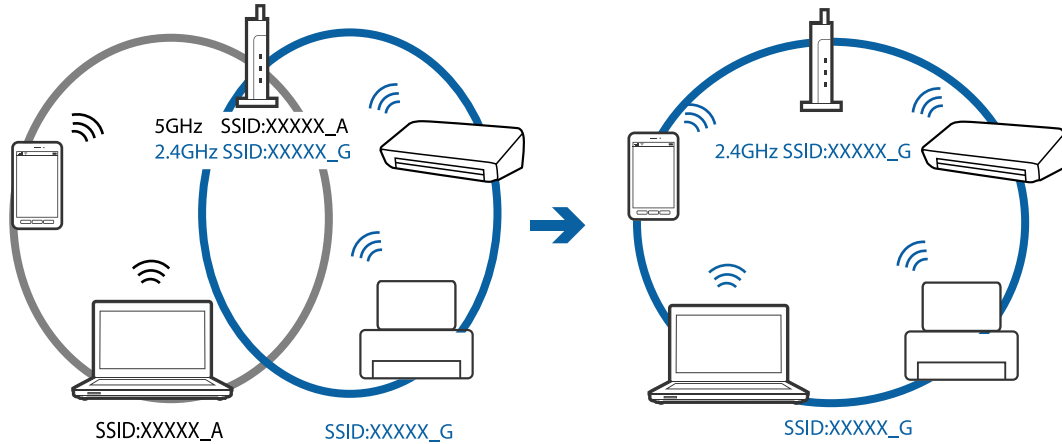

- ❑ Most access points have a privacy separator feature that blocks the communication from unauthorized devices. If you cannot connect to the network even if the devices and access point are connected to the same SSID, disable the privacy separator on the access point. See the manual provided with the access point for details.

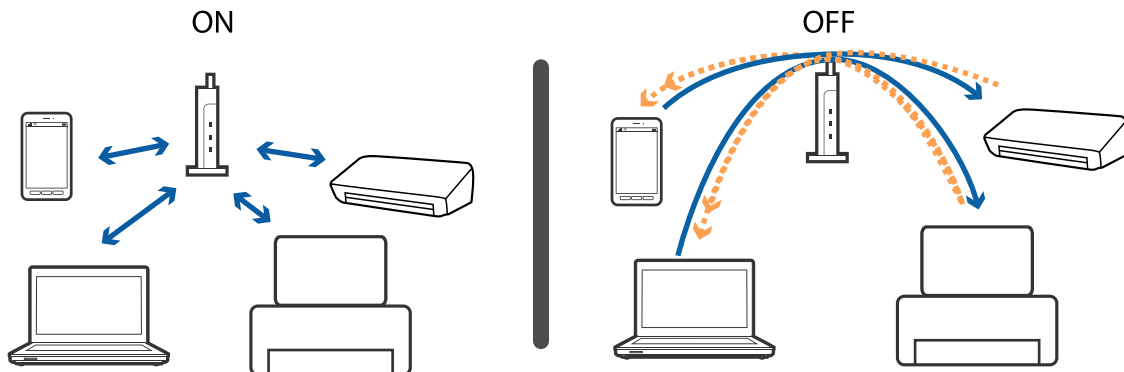

Related Information

- ➔ [“Checking the SSID Connected to the Printer” on page 188](#)
- ➔ [“Checking the SSID for the Computer” on page 189](#)

Checking the SSID Connected to the Printer

Press  on the home screen. Select **Menu > Wi-Fi/Network Settings > Wi-Fi/Network Status**. SSIDs are displayed on Wi-Fi network.

Checking the SSID for the Computer

Windows

Select **Control Panel > Network and Internet > Network and Sharing Center**.

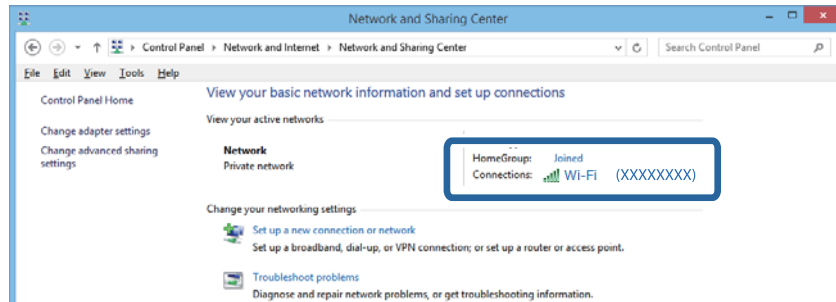

Mac OS X

Click the Wi-Fi icon at the top of the computer screen. A list of SSIDs is displayed and the connected SSID is indicated with a check mark.



Suddenly the Printer Cannot Print over a Network Connection

- ❑ When you have changed your access point or provider, try making network settings for the printer again. Connect the computer or smart device to the same SSID as the printer.
- ❑ Turn off the devices you want to connect to the network. Wait for about 10 seconds, and then turn on the devices in the following order; access point, computer or smart device, and then printer. Move the printer and computer or smart device closer to the access point to help with radio wave communication, and then try to make network settings again.

Solving Problems

- ❑ In Windows, click **Print Queue** on the printer driver's **Maintenance** tab, and then check the following.
 - ❑ Check if there are any paused print jobs. Cancel printing if necessary.
 - ❑ Make sure the printer is not offline or pending. If the printer is offline or pending, clear the offline or pending setting from the **Printer** menu.
 - ❑ Make sure the printer is selected as the default printer from the **Printer** menu (there should be a check mark on the menu item).
If the printer is not selected as the default printer, set it as the default printer.
 - ❑ Check if the selected port is correct in **Printer properties > Port**
- ❑ Press  on the home screen. Select **Menu > Wi-Fi/Network Settings > Connection Check**, and then print the network connection report. If the report shows that the network connection failed, check the network connection report and then follow the printed solutions.
- ❑ Try accessing any website from your computer to make sure that your computer's network settings are correct. If you cannot access any websites, there is a problem on the computer. See the manual provided with your computer for more details.

Related Information

- ➔ [“Checking the SSID Connected to the Printer” on page 188](#)
- ➔ [“Checking the SSID for the Computer” on page 189](#)
- ➔ [“Messages and Solutions on the Network Connection Report” on page 33](#)
- ➔ [“Cannot Connect from Devices Even Though Network Settings are No Problem” on page 187](#)

Suddenly the Printer Cannot Print Using a USB Connection

- ❑ Disconnect the USB cable from the computer. Right-click on the printer icon displayed on the computer, and then select **Remove Device**. Next, connect the USB cable to the computer and try a test print. If printing is possible, the setup is complete.
- ❑ Follow the steps in the paper manual bundled with the printer to setup the printer again.

Printout Problems

Printout is Scuffed or Color is Missing

If you have not used the printer for a long time, the print head nozzles may be clogged and ink drops may not be discharged. Perform a nozzle check, and then clean the print head if any of the print head nozzles are clogged.

Related Information

- ➔ [“Checking and Cleaning the Print Head” on page 139](#)

Banding or Unexpected Colors Appear

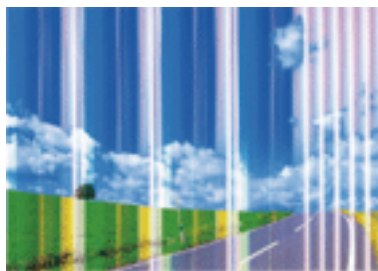

The print head nozzles may be clogged. Perform a nozzle check to check if the print head nozzles are clogged. Clean the print head if any of the print head nozzles are clogged.

Related Information

➔ [“Checking and Cleaning the Print Head” on page 139](#)

Colored Banding Appears at Intervals of Approximately 2.5 cm



- Select the appropriate paper type setting for the type of paper loaded in the printer.
- Align the print head using the **Horizontal Alignment** feature.
- When printing on plain paper, print using a higher quality setting.

Related Information

- ➔ [“List of Paper Types” on page 44](#)
- ➔ [“Aligning the Print Head” on page 141](#)

Blurry Prints, Vertical Banding, or Misalignment



enthalten alle
Aufdruck. W
↓ 5008 "Regel

Solving Problems

Align the print head using the **Vertical Alignment** feature.

Related Information

➔ [“Aligning the Print Head” on page 141](#)

Print Quality Does Not Improve Even After Aligning the Print Head

During bidirectional (or high speed) printing, the print head prints while moving in both directions, and vertical lines may be misaligned. If print quality does not improve, disable the bidirectional (or high speed) setting. Disabling this setting may slow down printing speed.

Control panel

Disable **Bidirectional** in the print settings.

Windows

Clear **High Speed** on the printer driver's **More Options** tab.

Mac OS X

Select **System Preferences** from the  menu > **Printers & Scanners** (or **Print & Scan, Print & Fax**), and then select the printer. Click **Options & Supplies > Options** (or **Driver**). Select **Off** as the **High Speed Printing** setting.

Related Information

➔ [“Menu Options for Memory Device” on page 63](#)

Print Quality is Poor

Check the following if the print quality is poor due to blurry prints, banding, missing colors, faded colors, and misalignment in the prints.

Make sure the initial ink charging is complete.

Perform a nozzle check, and then clean the print head if any of the print head nozzles are clogged.

If you have not used the printer for one or two months, replace the ink inside the ink tubes.

Align the print head.

Use paper supported by this printer.

Select the appropriate paper type setting for the type of paper loaded in the printer.

Do not print on paper that is damp, damaged, or too old.

If the paper is curled or the envelope is puffed up, flatten it.

Print using a higher quality setting.

If you have selected **Standard-Vivid** as the quality setting on the Windows printer driver, change to **Standard**. If you have selected **Normal-Vivid** as the quality setting on the Mac OS X printer driver, change to **Normal**.

Do not stack the paper immediately after printing.

Dry the printouts completely before filing or displaying them. When drying the printouts, avoid direct sun light, do not use a dryer, and do not touch the printed side of paper.

When printing images or photos, Epson recommends using genuine Epson paper rather than plain paper. Print on the printable side of the genuine Epson paper.

Solving Problems

- ❑ Try to use genuine Epson ink bottles. This product is designed to adjust colors based on the use of genuine Epson ink bottles. The use of non-genuine ink bottles may cause print quality to decline.
- ❑ Use ink bottles with the correct part code for this printer.
- ❑ Epson recommends using the ink bottle before the date printed on the package.

Related Information

- ➔ [“Refilling the Ink Tanks” on page 133](#)
- ➔ [“Checking and Cleaning the Print Head” on page 139](#)
- ➔ [“Aligning the Print Head” on page 141](#)
- ➔ [“Available Paper and Capacities” on page 43](#)
- ➔ [“List of Paper Types” on page 44](#)
- ➔ [“Paper Handling Precautions” on page 42](#)
- ➔ [“Ink Bottle Codes” on page 132](#)

Printed Photos are Sticky

You may be printing on the wrong side of the photo paper. Make sure you are printing on the printable side.

When printing on the wrong side of the photo paper, you need to clean the paper path.

Related Information

- ➔ [“Cleaning the Paper Path for Ink Smears” on page 142](#)

Images or Photos are Printed in Unexpected Colors

When printing from the control panel or from the Windows printer driver, the Epson auto photo adjustment setting is applied by default depending on the paper type. Try change the setting.

- ❑ Control panel
 - Change the **Scene Detection** setting from **Automatic** to any other option. If changing the setting does not work, select any other option other than **On** as the **Fix Photo** setting.
- ❑ Windows printer driver
 - On the **More Options** tab, select **Custom** in **Color Correction**, and then click **Advanced**. Change the **Scene Correction** setting from **Auto Correct** to any other option. If changing the setting does not work, use any color correction method other than **PhotoEnhance** in **Color Management**.

Related Information

- ➔ [“Menu Options for Memory Device” on page 63](#)
- ➔ [“Adjusting the Print Color” on page 80](#)

The Position, Size, or Margins of the Printout Are Incorrect

- ❑ Load paper in the correct direction, and slide the edge guides against the edges of the paper.

Solving Problems

- When placing the originals on the scanner glass, align the corner of the original with the corner indicated by a symbol on the frame of the scanner glass. If the edges of the copy are cropped off, move the original slightly away from the corner.
- When placing the originals on the scanner glass, clean the scanner glass and the document cover. If there is dust or stains on the glass, the copy area may extend to include the dust or stains, resulting in the wrong copying position or small images.
- Select the appropriate **Document Size** in the copy settings. If you have placed the printer in direct sunlight or near a light source, the scanner glass may not detect the document correctly.
- Select the appropriate paper size setting.
- Adjust the margin setting in the application so that it falls within the printable area.

Related Information

- ➔ [“Loading Paper in the Paper Cassette” on page 45](#)
- ➔ [“Loading Paper in the Rear Paper Feed Slot” on page 48](#)
- ➔ [“Placing Originals on the Scanner Glass” on page 54](#)
- ➔ [“Cleaning the Scanner Glass” on page 144](#)
- ➔ [“Printable Area” on page 211](#)

Paper Is Smearred or Scuffed

- When horizontal banding appears or the top or bottom of the paper is smeared, load paper in the correct direction and slide the edge guides to the edges of the paper.

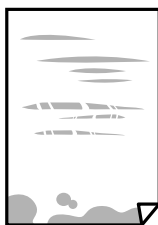

- When vertical banding appears or the paper is smeared, clean the paper path.



- Place the paper on a flat surface to check if it is curled. If it is, flatten it.

Solving Problems

- When the thick paper is scuffed, enable the reduce scuff setting. If you enable this setting, print quality may decline or printing may slow down.
 - Control panel
Select **Setup** > **Maintenance** from the home screen, and then enable **Thick Paper**.
 - Windows
Click **Extended Settings** on the printer driver's **Maintenance** tab, and then select **Thick Paper and Envelopes**.
If the paper is still scuffed after selecting the **Thick Paper and Envelopes** setting, select **Short Grain Paper** in the **Extended Settings** window of the printer driver.
 - Mac OS X
Select **System Preferences** from the  menu > **Printers & Scanners** (or **Print & Scan, Print & Fax**), and then select the printer. Click **Options & Supplies** > **Options** (or **Driver**). Select **On** as the **Thick paper and envelopes** setting.
- When performing manual 2-sided printing, make sure that the ink is completely dry before reloading the paper.

Related Information

- ➔ [“Loading Paper in the Paper Cassette” on page 45](#)
- ➔ [“Loading Paper in the Rear Paper Feed Slot” on page 48](#)
- ➔ [“Cleaning the Paper Path for Ink Smears” on page 142](#)

Paper is Smearred During Automatic 2-Sided Printing

When using the automatic 2-sided printing feature and printing high density data such as images and graphs, set the print density to lower and the drying time to longer.

Related Information

- ➔ [“Printing on 2-Sides” on page 68](#)
- ➔ [“Menu Options for Copy Mode” on page 85](#)

Printed Characters Are Incorrect or Garbled

- Connect the USB cable securely to the printer and the computer.
- Cancel any paused print jobs.
- Do not put the computer manually into the **Hibernate** mode or the **Sleep** mode while printing. Pages of garbled text may be printed next time you start the computer.

Related Information

- ➔ [“Canceling Printing” on page 83](#)

The Printed Image Is Inverted

Clear any mirror image settings in the printer driver or the application.

Solving Problems

Windows

Clear **Mirror Image** on the printer driver's **More Options** tab.

Mac OS X

Clear **Mirror Image** from the print dialog's **Print Settings** menu.

Mosaic-Like Patterns in the Prints

When printing images or photos, print using high-resolution data. Images on websites are often low resolution although they look good enough on the display, and so print quality may decline.

Uneven Colors, Smears, Dots, or Straight Lines Appear in the Copied Image

Clean the paper path.

Clean the scanner glass.

Clean the ADF.

Do not press too hard on the original or the document cover when you are placing the originals on the scanner glass.

When the paper is smeared, lower the copy density setting.

Related Information

➔ [“Cleaning the Paper Path for Ink Smears” on page 142](#)

➔ [“Cleaning the Scanner Glass” on page 144](#)

➔ [“Cleaning the ADF” on page 143](#)

➔ [“Menu Options for Copy Mode” on page 85](#)

Moiré (Cross-Hatch) Patterns Appear in the Copied Image

Change the reduce and enlarge setting or place the original at a slightly different angle.

Related Information

➔ [“Menu Options for Copy Mode” on page 85](#)

An Image of the Reverse Side of the Original Appears in the Copied Image

For a thin original, place the original on the scanner glass and then place a piece of black paper over it.

Lower the copy density setting on the control panel.

Related Information

➔ [“Menu Options for Copy Mode” on page 85](#)

The Printout Problem Could Not be Cleared



If you have tried all of the solutions and have not solved the problem, try uninstalling and then reinstalling the printer driver.

Related Information

- ➔ [“Uninstalling Applications” on page 164](#)
- ➔ [“Installing Applications” on page 166](#)

Other Printing Problems

Printing Is Too Slow

- Close any unnecessary applications.
- Lower the quality setting. High quality printing slows down the printing speed.
- Enable the bidirectional (or high speed) setting. When this setting is enabled, the print head prints while moving in both directions, and the printing speed increases.
 - Control Panel
When printing JPEGs or TIFFs, press **Settings**, and then enable **Bidirectional**.
 - Windows
Select **High Speed** on the printer driver's **More Options** tab.
 - Mac OS X
Select **System Preferences** from the  menu > **Printers & Scanners** (or **Print & Scan**, **Print & Fax**), and then select the printer. Click **Options & Supplies** > **Options** (or **Driver**). Select **On** as the **High Speed Printing** setting.
- Disable **Quiet Mode**.
 - Windows
Select **Off** as the **Quiet Mode** setting on the printer driver's **Main** tab.
 - Mac OS X
Select **System Preferences** from the  menu > **Printers & Scanners** (or **Print & Scan**, **Print & Fax**), and then select the printer. Click **Options & Supplies** > **Options** (or **Driver**). Select **Off** as the **Quiet Mode** setting.

Related Information

- ➔ [“Menu Options for Memory Device” on page 63](#)

Printing Slows Down Dramatically During Continuous Printing

Printing slows down to prevent the printer mechanism from overheating and being damaged. However, you can continue printing. To return to normal printing speed, leave the printer idle for at least 30 minutes. Printing speed does not return to normal if the power is off.

Cannot Start Scanning

- ❑ When the access control function is enabled for a printer, you need to enter a user ID and password when scanning. If you do not know the password, contact your system administrator.
- ❑ When the access control function is enabled, Mac OS X might not be able to scan. Contact your system administrator.
- ❑ If you are scanning with the ADF, check that the document cover and ADF cover are closed.
- ❑ Connect the USB cable securely to the printer and the computer.
- ❑ If you are using a USB hub, try to connect the printer directly to the computer.
- ❑ If you scan at a high resolution over a network, a communication error may occur. Lower the resolution.
- ❑ Make sure you select the correct printer (scanner) if a scanner list is displayed when you start Epson Scan 2.
- ❑ Make sure that the correct printer (scanner) is selected on Epson Scan 2.
- ❑ If you are using any TWAIN-compliant applications, select the printer (scanner) you are using.
- ❑ In Windows, make sure the printer (scanner) is displayed in **Scanner and Camera**. The printer (scanner) should be displayed as "EPSON XXXXX (printer name)". If the printer (scanner) is not displayed, uninstall and then re-install Epson Scan 2. See the following to access **Scanner and Camera**.
 - ❑ Windows 10
Right-click the start button or press and hold it, select **Control Panel**, enter "Scanner and Camera" in the search charm, click **View scanners and cameras**, and then check if the printer is displayed.
 - ❑ Windows 8.1/Windows 8/Windows Server 2012 R2/Windows Server 2012
Select **Desktop > Settings > Control Panel**, enter "Scanner and Camera" in the search charm, click **Show Scanner and Camera**, and then check if the printer is displayed.
 - ❑ Windows 7/Windows Server 2008 R2
Click the start button and select **Control Panel**, enter "Scanner and Camera" in the search charm, click **View scanners and cameras**, and then check if the printer is displayed.
 - ❑ Windows Vista/Windows Server 2008
Click the start button, select **Control Panel > Hardware and Sound > Scanners and Cameras**, and then check if the printer is displayed.
 - ❑ Windows XP/Windows Server 2003 R2/Windows Server 2003
Click the start button, select **Control Panel > Printers and Other Hardware > Scanner and Cameras**, and then check if the printer is displayed.
- ❑ If you cannot scan using any TWAIN-compliant applications, uninstall and then reinstall the TWAIN-compliant application.

Related Information

- ➔ ["Uninstalling Applications" on page 164](#)
- ➔ ["Installing Applications" on page 166](#)

Cannot Start Scanning when Using the Control Panel

- ❑ Make sure Epson Scan 2 and Epson Event Manager are installed correctly.
- ❑ Check the scanning setting assigned in Epson Event Manager.

Related Information

- ➔ [“Epson Scan 2 \(Scanner Driver\)” on page 161](#)
- ➔ [“Epson Event Manager” on page 161](#)

Scanned Image Problems

Uneven Colors, Dirt, Spots, and so on Appear when Scanning from the Scanner Glass

- Clean the scanner glass.
- Remove any trash or dirt that adheres to the original.
- Do not press with too much force on the original or the document cover. If you press with too much force, blurring, smudges, and spots may occur.

Related Information

- ➔ [“Cleaning the Scanner Glass” on page 144](#)

Straight Lines Appear when Scanning from ADF

- Clean the ADF.
Straight lines may appear in the image when trash or dirt gets into the ADF.
- Remove any trash or dirt that adheres to the original.

Related Information

- ➔ [“Cleaning the ADF” on page 143](#)

The Image Quality Is Rough

- In Epson Scan 2, adjust the image using items on the **Advanced Settings** tab, and then scan.
- If the resolution is low, try increasing the resolution and then scanning.

Related Information

- ➔ [“Scanning Using Epson Scan 2” on page 97](#)
- ➔ [“Common Menu Options for Scanning” on page 96](#)

Offset Appears in the Background of Images

Images on the back of the original may appear in the scanned image.

- In Epson Scan 2, select the **Advanced Settings** tab, and then adjust the **Brightness**.
This feature may not be available depending on the settings on the **Main Settings** tab > **Image Type** or other settings on the **Advanced Settings** tab.

Solving Problems

- ❑ In Epson Scan 2, select the **Advanced Settings** tab, and then **Image Option > Text Enhancement**.
- ❑ When scanning from the scanner glass, place black paper or a desk pad over the original.

Related Information

- ➔ [“Scanning Using Epson Scan 2” on page 97](#)
- ➔ [“Common Menu Options for Scanning” on page 96](#)
- ➔ [“Placing Originals” on page 52](#)

Text is Blurred

- ❑ In Epson Scan 2, select the **Advanced Settings** tab, and then **Image Option > Text Enhancement**.
- ❑ In Epson Scan 2, when **Image Type** on the **Main Settings** tab is set to **Black & White**, adjust the **Threshold** on the **Advanced Settings** tab. When you increase the **Threshold**, black becomes stronger.
- ❑ If the resolution is low, try increasing the resolution and then scanning.

Related Information

- ➔ [“Scanning Using Epson Scan 2” on page 97](#)
- ➔ [“Common Menu Options for Scanning” on page 96](#)

Moiré Patterns (Web-Like Shadows) Appear

If the original is a printed document, moiré patterns (web-like shadows) may appear in the scanned image.

- ❑ On the **Advanced Settings** tab in Epson Scan 2, set **Descreening**.



- ❑ Change the resolution, and then scan again.

Related Information

- ➔ [“Scanning Using Epson Scan 2” on page 97](#)
- ➔ [“Common Menu Options for Scanning” on page 96](#)

Cannot Scan the Correct Area on the Scanner Glass

- ❑ Make sure the original is placed correctly against the alignment marks.
- ❑ If the edge of the scanned image is missing, move the original slightly away from the edge of the scanner glass.
- ❑ When scanning from the control panel and selecting auto scan area cropping function, remove any trash or dirt from the scanner glass and document cover. If there is any trash or dirt around the original, the scanning range expands to include it.

Solving Problems

- ❑ Select the appropriate document size in the scan settings. If you have placed the printer in direct sunlight or near a light source, the scanner glass may not detect the document size correctly.

Related Information

- ➔ [“Placing Originals” on page 52](#)
- ➔ [“Cleaning the Scanner Glass” on page 144](#)

Text is Not Recognized Correctly when Saving as a Searchable PDF

- ❑ On the **Image Format Options** window in Epson Scan 2, check that **Text Language** is set correctly on the **Text** tab.
- ❑ Check that the original is placed straight.
- ❑ Use an original with clear text. Text recognition may decline for the following types of originals.
 - ❑ Originals that have been copied a number of times
 - ❑ Originals received by fax (at low resolutions)
 - ❑ Originals on which the letter spacing or line spacing is too small
 - ❑ Originals with ruled lines or underlining over the text
 - ❑ Originals with hand-written text
 - ❑ Originals with creases or wrinkles
- ❑ In Epson Scan 2, when **Image Type** on the **Main Settings** tab is set to **Black & White**, adjust the **Threshold** on the **Advanced Settings** tab. When you increase the **Threshold**, the black color area becomes larger.
- ❑ In Epson Scan 2, select the **Advanced Settings** tab, and then **Image Option > Text Enhancement**.

Related Information

- ➔ [“Scanning Using Epson Scan 2” on page 97](#)

Cannot Solve Problems in the Scanned Image

If you have tried all of the solutions and have not solved the problem, initialize the Epson Scan 2 settings using Epson Scan 2 Utility.

Note:

Epson Scan 2 Utility is an application that comes with Epson Scan 2.

1. Start Epson Scan 2 Utility.
 - ❑ Windows 10
Click the start button, and then select **All apps > EPSON > Epson Scan 2 Utility**.
 - ❑ Windows 8.1/Windows 8/Windows Server 2012 R2/Windows Server 2012
Enter the application name in the search charm, and then select the displayed icon.
 - ❑ Windows 7/Windows Vista/Windows XP/Windows Server 2008 R2/Windows Server 2008/Windows Server 2003 R2/Windows Server 2003
Click the start button, and then select **All Programs or Programs > EPSON > Epson Scan 2 > Epson Scan 2 Utility**.
 - ❑ Mac OS X

Solving Problems

Select **Go > Applications > Epson Software > Epson Scan 2 Utility**.

2. Select the **Other** tab.
3. Click **Reset**.

Note:

If initialization does not solve the problem, uninstall and re-install Epson Scan 2.

Related Information

- ➔ [“Uninstalling Applications” on page 164](#)
- ➔ [“Installing Applications” on page 166](#)

Other Scanning Problems

Scanning Speed Is Slow

- Lower the resolution, and then scan again. When the resolution is high, scanning may take some time.
- The scanning speed may be reduced depending on the image adjustment features in Epson Scan 2.
- On the **Configuration** screen which is displayed by clicking the  button in Epson Scan 2, if you set **Quiet Mode** on the **Scan** tab, the scanning speed may be reduced.

Related Information

- ➔ [“Scanning Using Epson Scan 2” on page 97](#)
- ➔ [“Common Menu Options for Scanning” on page 96](#)

Cannot Send the Scanned Image by Email

Make sure you have configured the email server settings.

Related Information

- ➔ [“Configuring an Email Server” on page 225](#)

Scanning Stops when Scanning to PDF/Multi-TIFF

- When scanning using Epson Scan 2, you can continuously scan up to 999 pages in PDF format and up to 200 pages in Multi-TIFF format. When scanning using the control panel, you can continuously scan up to 50 pages in single-sided scanning using the ADF, and up to 100 pages in 2-sided scanning using the ADF and when scanning using the scanner glass.
- When scanning large volumes, we recommend scanning in grayscale.
- Increase the free space on the computer's hard disk. Scanning may stop if there is not enough free space.
- Try scanning at a lower resolution. Scanning stops if the total data size reaches the limit.

Related Information



- ➔ [“Scanning Using Epson Scan 2” on page 97](#)
- ➔ [“Common Menu Options for Scanning” on page 96](#)

Problems when Sending and Receiving Faxes

Cannot Send or Receive Faxes

- Use **Check Fax Connection** on the control panel to run the automatic fax connection check. Try the solutions printed on the report.
- Check the error code displayed for the failed fax job, and try the solutions described in the error code list.
- Check the **Line Type** setting. Setting to **PBX** may solve the problem. If your phone system requires an external access code to get an outside line, register the access code to the printer, and enter # (hash) at the beginning of a fax number when sending.
- If a communication error occurs, change the **Fax Speed** setting to **Slow(9,600bps)** on the control panel.
- Check that the telephone wall jack works by connecting a phone to it and testing it. If you cannot make or receive calls, contact your telecommunication company.
- To connect to a DSL phone line, you need to use a DSL modem equipped with a built-in DSL filter, or install a separate DSL filter to the line. Contact your DSL provider.
- If you are connecting to a DSL phone line, connect the printer directly to a telephone wall jack to see if the printer can send a fax. If it works, the problem may be caused by the DSL filter. Contact your DSL provider.
- Enable the **ECM** setting on the control panel. Color faxes cannot be sent or received when **ECM** is off.
- To send or receive faxes using the computer, make sure that the printer is connected using a USB cable or a network, and that the PC-FAX Driver have been installed on the computer. The PC-FAX Driver is installed together with FAX Utility.
- In Windows, make sure the printer (fax) is displayed in **Devices and Printers**, **Printer**, or **Printers and Other Hardware**. The printer (fax) is displayed as "EPSON XXXXX (FAX)". If the printer (fax) is not displayed, uninstall and then re-install the FAX Utility. See the following to access **Devices and Printers**, **Printer**, or **Printers and Other Hardware**.
 - Windows 10
Right-click on the start button, or press and hold it and then select **Control Panel > View devices and printers** in **Hardware and Sound**.
 - Windows 8.1/Windows 8
Select **Desktop > Settings > Control Panel > View devices and printers** in **Hardware and Sound** or **Hardware**.
 - Windows 7
Click the start button, and select **Control Panel > View devices and printers** in **Hardware and Sound** or **Hardware**.
 - Windows Vista
Click the start button, and select **Control Panel > Printers** in **Hardware and Sound**.
 - Windows XP
Click the start button, and select **Settings > Control Panel > Printers and Other Hardware > Printers and Faxes**.

Solving Problems

- ❑ In Mac OS X, check the following.
 - ❑ Select **System Preferences** from the  menu > **Printers & Scanners** (or **Print & Scan, Print & Fax**), and then make sure the printer (fax) is displayed. The printer (fax) is displayed as "FAX XXXX (USB)" or "FAX XXXX (IP)". If the printer (fax) is not displayed, click [+] and then register the printer (fax).
 - ❑ Select **System Preferences** from the  menu > **Printers & Scanners** (or **Print & Scan, Print & Fax**), and then double-click the printer (fax). If the printer is paused, click **Resume** (or **Resume Printer**).

Related Information

- ➔ [“Check Fax Connection” on page 130](#)
- ➔ [“Basic Settings” on page 128](#)
- ➔ [“Error Code on the Status Menu” on page 169](#)
- ➔ [“Making Settings for a PBX Phone System” on page 107](#)
- ➔ [“Connecting the Printer to a Phone Line” on page 102](#)
- ➔ [“Uninstalling Applications” on page 164](#)
- ➔ [“Installing Applications” on page 166](#)

Cannot Send Faxes

- ❑ If the user restriction feature has been enabled, a user name and password are required to operate the printer. Contact your administrator if you do not know the password.
- ❑ If the user restriction feature has been enabled, and you send a fax from a computer, user authentication is performed using the user name and password set in the printer driver. When you cannot send a fax due to an authentication error, contact your administrator.
- ❑ Set up the header information for outgoing faxes on the control panel. Some fax machines automatically reject incoming faxes that do not include header information.
- ❑ If you have blocked your caller ID, unblock it. Some phones or fax machines automatically reject anonymous calls.
- ❑ Ask the recipient if the fax number is correct and the recipient's fax machine is ready to receive a fax.

Related Information

- ➔ [“Basic Settings” on page 128](#)
- ➔ [“Cannot Send or Receive Faxes” on page 203](#)

Cannot Send Faxes to a Specific Recipient

Check the following if you cannot send faxes to a specific recipient due to an error.

- ❑ If the recipient machine does not pick up your call within 50 seconds after the printer has finished dialing, the call ends with an error. Dial using the **On Hook** feature or using a connected telephone to check how long it takes before you hear a fax tone. If it takes more than 50 seconds, add pauses after the fax number to send the fax. Press  to enter the pause. A hyphen is entered as the pause mark. One pause is about three seconds. Add multiple pauses as needed.
- ❑ If you have selected the recipient from the contacts list, verify that the registered information is correct. If the information is correct, select the recipient from the contacts list, press **Edit** and change **Fax Speed** to **Slow(9,600bps)**.

Solving Problems

Related Information

- ➔ [“Sending Faxes After Confirming the Recipient's Status” on page 110](#)
- ➔ [“Sending Faxes Dialing from the External Phone Device” on page 110](#)
- ➔ [“Managing Contacts” on page 58](#)
- ➔ [“Cannot Send or Receive Faxes” on page 203](#)

Cannot Send Faxes at a Specified Time

Set the date and the time correctly on the control panel.

Related Information

- ➔ [“Sending Faxes at a Specified Time \(Send Fax Later\)” on page 111](#)
- ➔ [“Common Settings” on page 150](#)

Cannot Receive Faxes

- If you have subscribed to a call forwarding service, the printer may not be able to receive faxes. Contact the service provider.
- If you have not connected a telephone to the printer, set the **Receive Mode** setting to **Auto** on the control panel.
- Under the following conditions, the printer runs out of memory and cannot receive faxes. See the troubleshooting for information on handling a memory full error.
 - 100 received documents have been saved in the inbox.
 - The printer's memory is full (100%).

Related Information

- ➔ [“Receive Settings” on page 127](#)
- ➔ [“Cannot Send or Receive Faxes” on page 203](#)
- ➔ [“Memory Full Error Occurs” on page 205](#)

Memory Full Error Occurs

- If the printer has been set to save received faxes in the inbox, delete faxes you have already read from the inbox.
- If the printer has been set to save received faxes on a computer, turn on the computer that is set to save the faxes. Once the faxes are saved in the computer, they are deleted from the printer's memory.
- If the printer has been set to save received faxes on a memory device, connect the device, in which you have created a folder to save faxes, to the printer. Once the faxes are saved in the device, they are deleted from the printer's memory. Make sure that the device has enough available memory and is not write protected.
- Even though the memory is full, you can send a monochrome fax by using the **Direct Send** feature. Or you can also send a fax by dialing from the external phone device, or by using the **On Hook** feature. You can also divide your originals into two or more to send them in several batches.
- If the printer cannot print a received fax due to a printer error, such as a paper jam, the memory full error may occur. Clear the printer problem, and then contact the sender and ask them to send the fax again.

Solving Problems

Related Information

- ➔ [“Saving Received Faxes in the Inbox” on page 117](#)
- ➔ [“Saving Received Faxes on a Computer” on page 118](#)
- ➔ [“Saving Received Faxes in an External Memory Device” on page 118](#)
- ➔ [“Sending Many Pages of a Monochrome Document \(Direct Send\)” on page 112](#)
- ➔ [“Sending Faxes Dialing from the External Phone Device” on page 110](#)
- ➔ [“Sending Faxes After Confirming the Recipient's Status” on page 110](#)
- ➔ [“Removing Jammed Paper” on page 174](#)

Sent Fax Quality Is Poor

- Clean the scanner glass.
- Clean the ADF.
- Change the **Resolution** setting on the control panel. If your originals contain both text and photos, select **Photo**.
- Change the **Density** setting on the control panel.
- If you are not sure about the capabilities of the recipient fax machine, enable the Direct Send feature or select **Fine** as the **Resolution** setting.
If you select **Super Fine** or **Ultra Fine** for a monochrome fax, and send the fax without using the **Direct Send** feature, the printer may automatically lower the resolution.
- Enable the **ECM** setting on the control panel.

Related Information

- ➔ [“Menu Options for Fax Mode” on page 124](#)
- ➔ [“Basic Settings” on page 128](#)
- ➔ [“Cleaning the Scanner Glass” on page 144](#)
- ➔ [“Cleaning the ADF” on page 143](#)

Faxes are Sent at the Wrong Size

- Before you send an A3 size document, ask the recipient if the recipient's machine supports A3 size. If you see **OK (Reduced Size)** in the fax transmission report, the recipient's fax machine does not support A3 size.
- When sending a fax using the scanner glass, place the original correctly aligning its corner with the origin mark. Select your original size on the control panel.
- If you have placed the printer in direct sunlight or near a light source, the scanner glass may not detect the document correctly. Select your original size on the control panel.
- Clean the scanner glass and the document cover. If there is dust or stains on the glass, the scanning area may extend to include the dust or stains, resulting in the wrong scanning position or small images.

Related Information

- ➔ [“Menu Options for Fax Mode” on page 124](#)
- ➔ [“Placing Originals” on page 52](#)
- ➔ [“Cleaning the Scanner Glass” on page 144](#)

Received Fax Quality Is Poor

- Enable the **ECM** setting on the control panel.
- Contact the sender and ask them to send using a higher quality mode.
- Reprint the received fax. Select **Job History** from **Status Menu** to reprint the fax.

Related Information

- ➔ [“Basic Settings” on page 128](#)
- ➔ [“Checking the Fax Job History” on page 123](#)

Cannot Receive A3 Size Faxes

Check that the paper size setting of the paper source that contains A3 paper has been set to A3, and that the paper source is set for use with the fax feature. Select **Setup > System Administration > Printer Settings > Paper Source Settings > Auto Select Settings > Fax**, and then check the enabled paper source(s).

Related Information

- ➔ [“Printer Settings” on page 149](#)

Received Faxes Are Not Printed

- If an error has occurred on the printer, such as a paper jam, the printer cannot print received faxes. Check the printer.
- If the printer has been set to save received faxes in the inbox, the received faxes are not automatically printed. Check the **Fax Output** setting.

Related Information

- ➔ [“Checking the Printer Status” on page 168](#)
- ➔ [“Removing Jammed Paper” on page 174](#)
- ➔ [“Saving Received Faxes in the Inbox” on page 117](#)

Other Faxing Problems

Cannot Make Calls on the Connected Telephone

Connect the telephone to the **EXT.** port on the printer, and pick up the receiver. If you cannot hear a dial tone through the receiver, connect the phone cable correctly.

Related Information

- ➔ [“Connecting Your Phone Device to the Printer” on page 104](#)

Answering Machine Cannot Answer Voice Calls

On the control panel, set the printer's **Rings to Answer** setting to a number higher than the number of rings for your answering machine.

Related Information

- ➔ [“Receive Settings” on page 127](#)
- ➔ [“Settings for the Answering Machine” on page 114](#)

Sender's Fax Number Not Displayed on Received Faxes or the Number Is Wrong

The sender may not have set the fax header information or may have set it incorrectly. Contact the sender.

Other Problems

Slight Electric Shock when Touching the Printer

If many peripherals are connected to the computer, you may feel a slight electric shock when touching the printer. Install a ground wire to the computer that is connected to the printer.

Operation Sounds Are Loud

If operations sounds are too loud, enable **Quiet Mode**. Enabling this feature may reduce printing speed.

- Windows printer driver

Enable **Quiet Mode** on the **Main** tab.

- Mac OS X printer driver

Select **System Preferences** from the  menu > **Printers & Scanners** (or **Print & Scan**, **Print & Fax**), and then select the printer. Click **Options & Supplies** > **Options** (or **Driver**). Select **On** as the **Quiet Mode** setting.

- Epson Scan 2

Click the  button to open the **Configuration** window. Next, set the **Quiet Mode** on the **Scan** tab.

Solving Problems

Rear Paper Feed Slot is Removed

Reattach the rear paper feed slot by holding vertically shown as below.

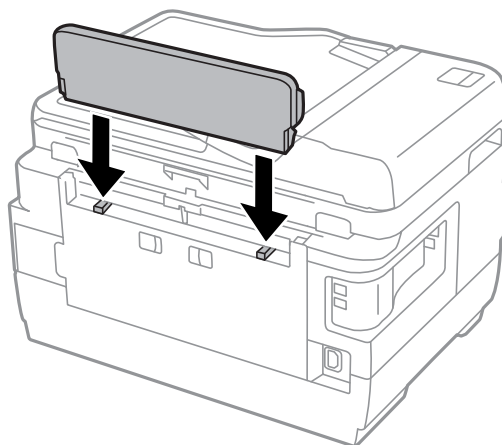

The Date and Time Are Incorrect

Set the date and the time correctly on the control panel. After a power failure caused by a lightning strike or if the power is left off for a long time, the clock may show the wrong time.

Related Information

➔ [“Common Settings” on page 150](#)

Memory Device Is not Recognized

Enable the memory device in the **Memory Device Interface** settings on the control panel.

Related Information

➔ [“Printer Settings” on page 149](#)

Cannot Save Data to a Memory Device

- Insert the memory device in the printer, and then select **Fax Output > Other Settings > Create Folder to Save** to create a folder to save documents in the memory device. You cannot use a memory device that does not have a folder.
- Check that the memory device is not write protected.
- Check that the memory device has enough available memory. If the available memory is low, data cannot be saved.

Related Information

➔ [“Saving Received Faxes in an External Memory Device” on page 118](#)

➔ [“External Storage Device Specifications” on page 215](#)

Forgot Your Password

If you forget the administrator's password, contact Epson support.

Related Information

➔ [“Contacting Epson Support” on page 227](#)

Application Is Blocked by a Firewall (for Windows Only)

Add the application to the Windows Firewall allowed program in security settings on the **Control Panel**.

"?" Is Displayed on the Photo Selection Screen

"?" is displayed on the LCD screen when the image file is not supported by the product.

Related Information

➔ [“Supported Data Specifications” on page 216](#)

A Message Prompting You to Reset the Ink Levels is Displayed

Refill all or the specified ink tanks, select the color that you refilled on the LCD screen, and then press **Done** to reset the ink levels.

Depending on the usage conditions, the message may be displayed when there is still ink in the tank.

If the message is displayed even when more than half of the ink remains in the ink tanks, the printer may be malfunctioning. Contact Epson support.

Related Information

➔ [“Refilling the Ink Tanks” on page 133](#)

Appendix

Technical Specifications

Printer Specifications

Print Head Nozzle Placement		Black ink nozzles: 400×2 rows Color ink nozzles: 128×2 rows for each color
Weight of Paper	Plain Paper	64 to 90 g/m ² (17 to 24 lb)
	Thick Paper	91 to 256 g/m ² (25 to 68 lb)
	Envelope	Envelope #10, DL, C6: 75 to 90 g/m ² (20 to 24 lb) Envelope C4: 80 to 100 g/m ² (21 to 26 lb)

Printable Area

Printable Area for Single Sheets

Print quality may decline in the shaded areas due to the printer's mechanism.

	A	3.0 mm (0.12 in.)
	B	3.0 mm (0.12 in.)
	C	47.0 mm (1.85 in.)
	D	45.0 mm (1.77 in.)

Printable Area for Envelopes

Print quality may decline in the shaded areas due to the printer's mechanism.

	A	3.0 mm (0.12 in.)
	B	5.0 mm (0.20 in.)
	C	18.0 mm (0.71 in.)
	D	47.0 mm (1.85 in.)

Scanner Specifications

Scanner Type	Flatbed
Photoelectric Device	CIS

Appendix

Effective Pixels	14040×20400 pixels (1200 dpi)
Maximum Document Size	297×431.8 mm (11.7×17 in.) A3
Scanning Resolution	1200 dpi (main scan) 2400 dpi (sub scan)
Output Resolution	50 to 4800, 7200, 9600 dpi (50 to 4800 dpi in 1 dpi increments.)
Color Depth	<p>Color</p> <ul style="list-style-type: none"> <input type="checkbox"/> 48 bits per pixel internal (16 bits per pixel per color internal) <input type="checkbox"/> 24 bits per pixel external (8 bits per pixel per color external) <p>Grayscale</p> <ul style="list-style-type: none"> <input type="checkbox"/> 16 bits per pixel internal <input type="checkbox"/> 8 bits per pixel external <p>Black and white</p> <ul style="list-style-type: none"> <input type="checkbox"/> 16 bits per pixel internal <input type="checkbox"/> 1 bits per pixel external
Light Source	LED

Interface Specifications

For Computer	Hi-Speed USB
For External USB Device	Hi-Speed USB

Fax Specifications

Fax Type	Walk-up black and white and color fax capability (ITU-T Super Group 3)
Supported Lines	Standard analogue telephone lines, PBX (Private Branch Exchange) telephone systems
Speed	Up to 33.6 kbps
Resolution	<p>Monochrome</p> <ul style="list-style-type: none"> <input type="checkbox"/> Standard: 8 pel/mm×3.85 line/mm (203 pel/in.×98 line/in.) <input type="checkbox"/> Fine: 8 pel/mm×7.7 line/mm (203 pel/in.×196 line/in.) <input type="checkbox"/> Super Fine: 8 pel/mm×15.4 line/mm (203 pel/in.×392 line/in.) <input type="checkbox"/> Ultra Fine: 16 pel/mm×15.4 line/mm (406 pel/in.×392 line/in.) <input type="checkbox"/> Photo: 8 pel/mm×7.7 line/mm (203 pel/in.×196 line/in.) <p>Color</p> <ul style="list-style-type: none"> <input type="checkbox"/> Fine: 200×200 dpi <input type="checkbox"/> Photo: 200×200 dpi

Appendix

Page Memory	Up to 550 pages (when received ITU-T No.1 chart in monochrome draft mode)
Redial*	2 times (with 1 minute intervals)
Interface	RJ-11 Phone Line, RJ-11 Telephone set connection

* The specifications may differ by country or region.

Network Function List

Functions		Supported	Remarks		
Network Interfaces	Ethernet	✓	-		
	Wi-Fi	Infrastructure	✓	-	
		Ad hoc	✓	-	
		Wi-Fi Direct	Simple AP Mode	✓	-
			Wi-Fi Direct Mode	✓	-
Concurrent Connection	Ethernet	Simple AP Mode	✓	-	
	Wi-Fi (Infrastructure)	Simple AP Mode	-	-	
	Ad hoc	Simple AP Mode	-	-	
Panel Operation	Wi-Fi Setup	Wi-Fi Setup Wizard	✓	-	
		Push Button Setup (WPS)	✓	-	
		PIN Code Setup	✓	-	
		Wi-Fi Auto Connect	✓	-	
		Wi-Fi Direct Setup	✓	-	
	General Network Setup		✓	-	
	Network Connection Check		✓	-	
	Network Status		✓	-	
	Network Status Sheet Printing		✓	-	
	Disable Wi-Fi		✓	-	
	Restore the Factory Default Settings		✓	-	
	File Sharing Setup		✓	-	

Appendix

Functions			Supported	Remarks
Network Printing	EpsonNet Print (Windows)	IPv4	✓	-
	Standard TCP/IP (Windows)	IPv4, IPv6	✓	-
	WSD Printing (Windows)	IPv4, IPv6	✓	Windows Vista or later
	Bonjour Printing (Mac OS X)	IPv4, IPv6	✓	-
	IPP Printing (Windows, Mac OS X)	IPv4, IPv6	✓	-
	UPnP Printing	IPv4	-	Information appliance
	PictBridge Printing (Wi-Fi)	IPv4	-	Digital camera
	Epson Connect (Email Print)	IPv4	✓	-
	Google Cloud Print	IPv4, IPv6	✓	-
Network Scanning	Epson Scan 2	IPv4, IPv6	✓	-
	Event Manager	IPv4	✓	-
	Epson Connect (Scan to Cloud)	IPv4	✓	-
	ADF (AutoReversing)		✓	-
Fax	Send a fax	IPv4	✓	-
	Receive a fax	IPv4	✓	-

Wi-Fi Specifications

Standards	IEEE802.11b/g/n* ¹
Frequency Range	2.4 GHz
Maximum Radio-Frequency Power Transmitted	18.2 dBm (EIRP)
Coordination Modes	Infrastructure, Ad hoc* ² , Wi-Fi Direct* ³ * ⁴
Wireless Securities	WEP (64/128bit), WPA2-PSK (AES)* ⁵

*1 Complies with either IEEE 802.11b/g/n or IEEE 802.11b/g depending on location of purchase.

*2 Not supported for IEEE 802.11n.

*3 Not supported for IEEE 802.11b.

*4 Simple AP mode is compatible with a Wi-Fi connection (infrastructure) or an Ethernet connection.

Appendix

*5 Complies with WPA2 standards with support for WPA/WPA2 Personal.

Ethernet Specifications

Standards	IEEE802.3i (10BASE-T) ^{*1} IEEE802.3u (100BASE-TX) IEEE802.3az (Energy Efficient Ethernet) ^{*2}
Communication Mode	Auto, 10Mbps Full duplex, 10Mbps Half duplex, 100Mbps Full duplex, 100Mbps Half duplex
Connector	RJ-45

*1 Use a category 5e or higher STP (Shielded twisted pair) cable to prevent risk of radio interference.

*2 The connected device should comply with IEEE802.3az standards.

Security Protocol

SSL/TLS	HTTPS Server/Client, IPPS
---------	---------------------------

Supported Third Party Services

Google Cloud Print

External Storage Device Specifications

Supported Memory Card Specifications

Compatible Memory Cards	Maximum Capacities
Memory Stick Duo [*]	128 MB
Memory Stick PRO Duo [*] Memory Stick PRO-HG Duo [*]	32 GB
MagicGate Memory Stick Duo [*]	128 MB
Memory Stick Micro [*]	32 GB
miniSD [*]	2 GB
miniSDHC [*]	32 GB
microSD [*]	2 GB
microSDHC [*]	32 GB
microSDXC [*]	64 GB

Appendix

Compatible Memory Cards	Maximum Capacities
SD	2 GB
SDHC	32 GB
SDXC	64 GB

* Attach an adapter to fit the memory card slot. Otherwise, the card may get stuck.

Supported memory card voltages

3.3 V type, dual voltage (3.3 V and 5V) type (supply voltage: 3.3 V)

5 V memory cards are not supported.

Maximum supply current

Memory Stick/PRO: 100 mA

SD: 200 mA

Supported External Storage Device Specifications

Compatible External Storage Devices	Maximum Capacities
MO Drive*	1.3 GB
Hard Disk Drive* USB Flash Drive	2 TB (formatted in FAT, FAT32, or exFAT.)

* We do not recommend using external USB devices that are powered by USB. Use only external USB devices with independent AC power sources.

You cannot use the following devices:

- A device that requires a dedicated driver
- A device with security settings (password, encryption, and so on)
- A device with a built-in USB hub

Epson cannot guarantee all operations of externally connected devices.

Supported Data Specifications

File Format	JPEG with the Exif Version 2.3 standard taken by digital cameras DCF* ¹ version 1.0 or 2.0* ² compliant TIFF 6.0 compliant images as below <input type="checkbox"/> RGB full color images (not compressed) <input type="checkbox"/> Binary images (not compressed or CCITT encoded)
Image Size	Horizontal: 80 to 10200 pixels Vertical: 80 to 10200 pixels
File Size	Less than 2 GB

Appendix

Maximum Number of Files	JPEG: 9990* ³ TIFF: 999
-------------------------	---------------------------------------

*1 Design rule for Camera File system.

*2 Photo data stored on digital cameras with a built-in memory is not supported.

*3 Up to 999 files can be displayed at a time. (If the number of files exceeds 999, the files are displayed in groups.)

Note:

"?" is displayed on the LCD screen when the printer cannot recognize the image file. In this situation, if you select a multiple image layout, blank sections will be printed.

Dimensions

Dimensions	<p>Storage</p> <ul style="list-style-type: none"> <input type="checkbox"/> Width: 666 mm (26.2 in.) <input type="checkbox"/> Depth: 486 mm (19.1 in.) <input type="checkbox"/> Height: 418 mm (16.5 in.) <p>Printing</p> <ul style="list-style-type: none"> <input type="checkbox"/> Width: 666 mm (26.2 in.) <input type="checkbox"/> Depth: 817 mm (32.2 in.) <input type="checkbox"/> Height: 418 mm (16.5 in.)
Weight*	Approx. 23.0 kg (50.7 lb)

* Without the ink and the power cord.

Electrical Specifications

Model	100 to 240 V Model	220 to 240 V Model
Rated Frequency Range	50 to 60 Hz	50 to 60 Hz
Rated Current	1.0 to 0.6 A	0.6 A
Power Consumption (with USB Connection)	<p>Standalone copying: Approx. 20 W (ISO/IEC24712)</p> <p>Ready mode: Approx. 8.9 W</p> <p>Sleep mode: Approx. 1.9 W</p> <p>Power off: Approx. 0.4 W</p>	<p>Standalone copying: Approx. 20 W (ISO/IEC24712)</p> <p>Ready mode: Approx. 9.1 W</p> <p>Sleep mode: Approx. 2.0 W</p> <p>Power off: Approx. 0.45 W</p>

Note:

Check the label on the printer for its voltage.

For European users, see the following Website for details on power consumption.

<http://www.epson.eu/energy-consumption>

For users in Belgium, power consumption when copying may vary.

Check <http://www.epson.be> for the latest specifications.

Appendix

Environmental Specifications

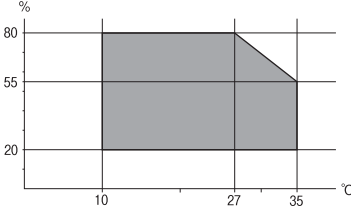
Operation	<p>Use the printer within the range shown in the following graph.</p>  <p>Temperature: 10 to 35°C (50 to 95°F) Humidity: 20 to 80% RH (without condensation)</p>
Storage	<p>Temperature: -20 to 40°C (-4 to 104°F)* Humidity: 5 to 85% RH (without condensation)</p>

* You can store for one month at 40°C (104°F).

Environmental Specifications for Ink Bottles

Storage Temperature	-20 to 40 °C (-4 to 104 °F)*
Freezing Temperature	<p>-15 °C (5 °F) Ink thaws and is usable after approximately 2 hours at 25 °C (77 °F).</p>

* You can store for one month at 40 °C (104 °F).

System Requirements

- Windows 10 (32-bit, 64-bit)/Windows 8.1 (32-bit, 64-bit)/Windows 8 (32-bit, 64-bit)/Windows 7 (32-bit, 64-bit)/Windows Vista (32-bit, 64-bit)/Windows XP SP3 or later (32-bit)/Windows XP Professional x64 Edition SP2 or later/Windows Server 2012 R2/Windows Server 2012/Windows Server 2008 R2/Windows Server 2008/Windows Server 2003 R2/Windows Server 2003 SP2 or later
- Mac OS X v10.11.x/Mac OS X v10.10.x/Mac OS X v10.9.x/Mac OS X v10.8.x/Mac OS X v10.7.x/Mac OS X v10.6.8

Note:

- Mac OS X may not support some applications and features.
- The UNIX File System (UFS) for Mac OS X is not supported.

Regulatory Information

Standards and Approvals

Standards and Approvals for U.S. Model

Safety	UL60950-1 CAN/CSA-C22.2 No.60950-1
EMC	FCC Part 15 Subpart B Class B CAN/CSA-CEI/IEC CISPR 22 Class B

This equipment contains the following wireless module.

Manufacturer: Askey Computer Corporation

Type: WLU6117-D69 (RoHS)

This product conforms to Part 15 of the FCC Rules and RSS-210 of the IC Rules. Epson cannot accept responsibility for any failure to satisfy the protection requirements resulting from a non-recommended modification of the product. Operation is subject to the following two conditions: (1) this device may not cause harmful interference, and (2) this device must accept any interference received, including interference that may cause undesired operation of the device.

To prevent radio interference to the licensed service, this device is intended to be operated indoors and away from windows to provide maximum shielding. Equipment (or its transmit antenna) that is installed outdoors is subject to licensing.

Standards and Approvals for European Model

For European users

Hereby, Seiko Epson Corporation declares that the following radio equipment model is in compliance with Directive 2014/53/EU. The full text of the EU declaration of conformity is available at the following website.

<http://www.epson.eu/conformity>

C441D

For use only in Ireland, UK, Austria, Germany, Liechtenstein, Switzerland, France, Belgium, Luxemburg, Netherlands, Italy, Portugal, Spain, Denmark, Finland, Norway, Sweden, Iceland, Croatia, Cyprus, Greece, Slovenia, Malta, Bulgaria, Czech, Estonia, Hungary, Latvia, Lithuania, Poland, Romania, and Slovakia.

Epson cannot accept responsibility for any failure to satisfy the protection requirements resulting from a non-recommended modification of the products.



Restrictions on Copying

Observe the following restrictions to ensure the responsible and legal use of the printer.

Copying of the following items is prohibited by law:

Appendix

- Bank bills, coins, government-issued marketable securities, government bond securities, and municipal securities
- Unused postage stamps, pre-stamped postcards, and other official postal items bearing valid postage
- Government-issued revenue stamps, and securities issued according to legal procedure

Exercise caution when copying the following items:

- Private marketable securities (stock certificates, negotiable notes, checks, etc.), monthly passes, concession tickets, etc.
- Passports, driver's licenses, warrants of fitness, road passes, food stamps, tickets, etc.

Note:

Copying these items may also be prohibited by law.

Responsible use of copyrighted materials:

Printers can be misused by improperly copying copyrighted materials. Unless acting on the advice of a knowledgeable attorney, be responsible and respectful by obtaining the permission of the copyright holder before copying published material.

Transporting the Printer

When you need to transport the printer to move or for repairs, follow the steps below to pack the printer.

Appendix

 **Caution:**

- Be careful not to trap your hand or fingers when opening or closing the scanner unit. Otherwise you may be injured.
- When carrying the printer, lift it using a stable position. Lifting the printer using an unstable position may result in injury.
- Because this printer is heavy, it should always be carried by two or more people when unpacking and transporting.
- When lifting the printer, place your hands in the positions shown below. If you lift the printer holding other positions, the printer may fall or you may trap your fingers when placing the printer.



- When carrying the printer, do not tilt it more than 10 degrees; otherwise the printer may fall.

Appendix

! *Important:*

- ❑ When storing or transporting the printer, avoid tilting it, placing it vertically, or turning it upside down; otherwise ink may leak.

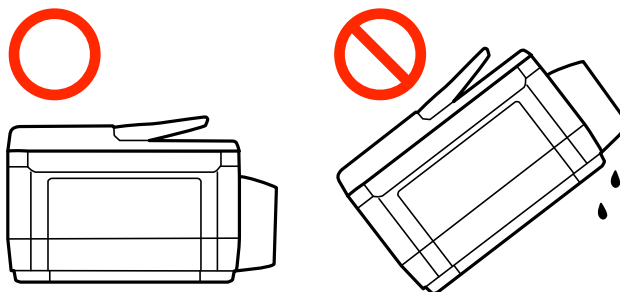

- ❑ Leave the maintenance box installed; otherwise ink may leak during transporting.
- ❑ When storing or transporting an ink bottle after removing its seal, do not tilt the bottle and do not subject it to impacts or temperature changes. Otherwise, ink may leak even if the cap on the ink bottle is tightened securely. Be sure to keep the ink bottle upright when tightening the cap, and take measures to prevent ink from leaking when you transport the bottle.
- ❑ Do not put opened ink bottles in the box with printer.

1. Turn off the printer by pressing the  button.
2. Make sure the power light turns off, and then unplug the power cord.

! *Important:*

Unplug the power cord when the power light is off. Otherwise, the print head does not return to the home position causing the ink to dry, and printing may become impossible.

3. Disconnect all cables such as the power cord and USB cable.
4. Make sure there is no memory card inserted.
5. Remove all of the paper from the printer.
6. Make sure there are no originals on the printer.

Appendix

7. Open the scanner unit with the document cover closed. Secure the print head to the case with tape.

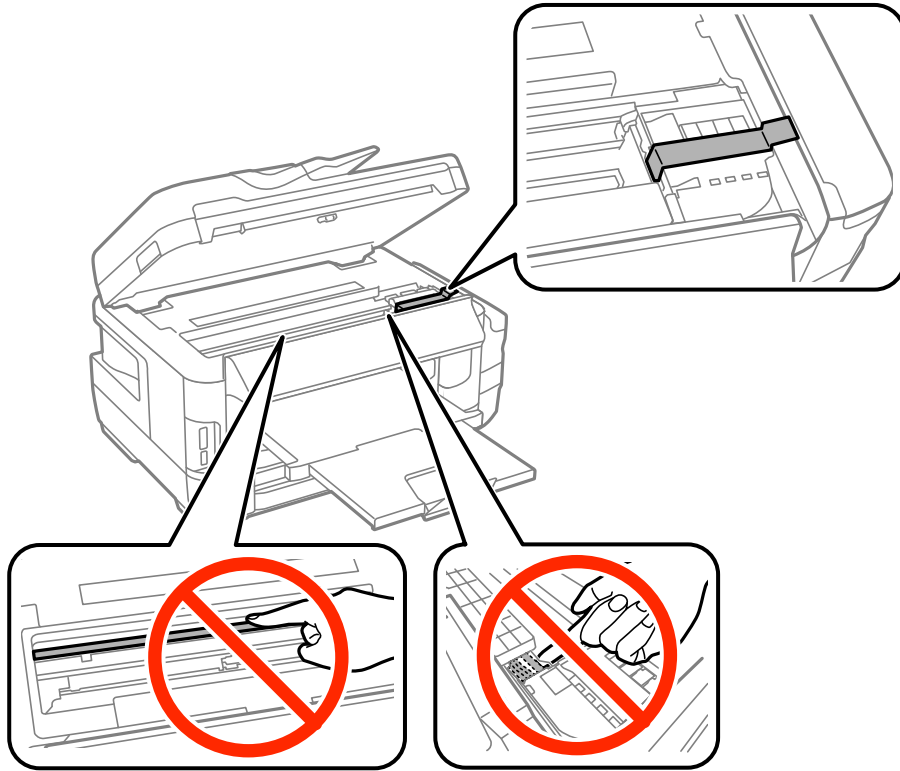

8. Close the scanner unit.

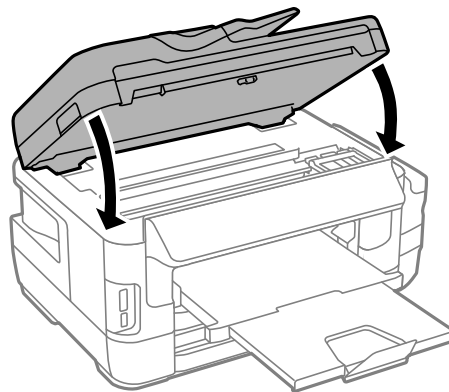

9. Prepare to pack the printer as shown below.

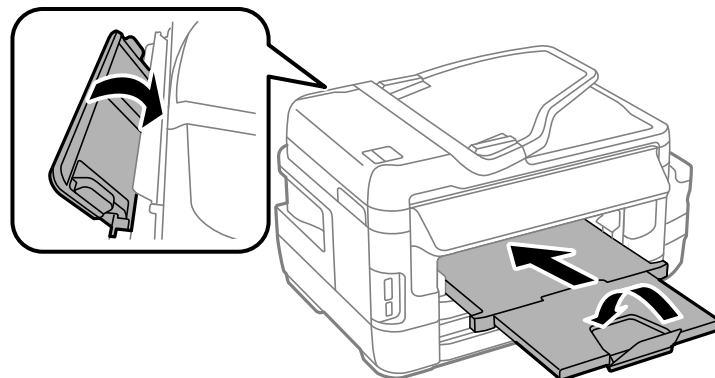

Appendix

10. Make sure to install the cap onto the ink tank securely.

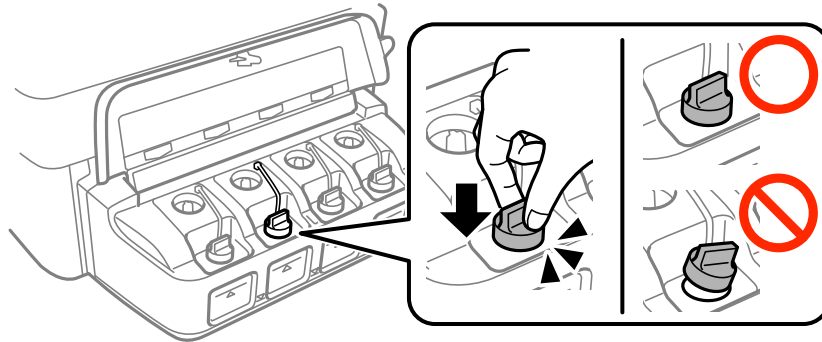

11. Pack the printer in its box using the protective materials.

When you use the printer again, make sure you remove the tape securing the print head. If print quality has declined the next time you print, clean and align the print head.

Related Information

- ➔ [“Part Names and Functions” on page 15](#)
- ➔ [“Checking and Cleaning the Print Head” on page 139](#)
- ➔ [“Aligning the Print Head” on page 141](#)

Accessing the External Storage Device From a Computer

You can write or read data on an external storage device such as a memory card that has been inserted in the printer from a computer.

Important:

- Insert a memory card after removing write protection.
- If an image is saved to the memory card from a computer, the image and the number of photos are not refreshed on the LCD screen. Remove and insert the memory card again.
- When sharing an external device inserted in the printer between computers connected over USB and over a network, write access is only allowed to the computers that are connected by the method you selected on the printer. To write to the external storage device, select a connection method in the following menu on the printer's control panel.

Setup > System Administration > Printer Settings > Memory Device Interface > File Sharing

Note:

It takes a while to recognize data from a computer if a large external storage device, such as 2TB HDD, is connected.

Windows

Select an external storage device in **Computer** or **My Computer**. The data on the external storage device is displayed.

Appendix

Note:

If you connected the printer to the network without the software disc or Web Installer, map a memory card slot or USB port as a network drive. Open **Run** and enter a printer name \\XXXXXX or a printer's IP address \\XXX.XXX.XXX.XXX to **Open**. Right-click a device icon displayed to assign the network. The network drive appears in **Computer** or **My Computer**.

Mac OS X

Select a corresponding device icon. The data on the external storage device is displayed.

Note:

- To remove an external storage device, drag and drop the device icon to the trash icon. Otherwise, data in the shared drive may not be displayed correctly when another external storage device is inserted.
- To access an external storage device through the network, select **Go > Connect to Server** from the menu on the desktop. Enter a printer name `cifs://XXXXXX` or `smb://XXXXXX` (Where "xxxxx" is the printer name) in the **Server Address**, and then click **Connect**.

Related Information

- ➔ [“Advisories and Warnings for Using Memory Cards” on page 14](#)
- ➔ [“Inserting a Memory Card” on page 56](#)
- ➔ [“External Storage Device Specifications” on page 215](#)

Using an Email Server

To use email features, such as scan or fax forwarding features, you need to configure the email server.

Configuring an Email Server

Check the following before configuring the email server.

- The printer is connected to the network.
- The email server information, such as the documents from your service provider that you used to setup the email on your computer.

Note:

If you use a free email service, such as Internet email, search the Internet to get the email server information you need.

1. Enter **Setup** from the home screen.
2. Select **System Administration > Wi-Fi/Network Settings > Advanced Setup**.
3. Select **Email Server > Server Settings**.

Appendix

4. Select the authentication method of the email server you are using.

**Important:**

The following authentication methods are available. SSL and STARTTLS are not supported.

- None
- SMTP (SMTP AUTH)
- POP Before SMTP

Contact your internet service provider to confirm the authentication method of the email server.

The printer may not be able to communicate with an email server even if the authentication method is available since security may be enhanced (for example SSL communication is necessary). Visit the Epson support website for the latest information.

<http://www.epson.eu/Support> (Europe)

<http://support.epson.net/> (outside Europe)

5. Make the appropriate settings.

The necessary settings vary depending on the authentication method. Enter the information for the email server you are using.

6. Press **OK**.

Note:

- If an error message is displayed, check if the email server settings are correct.
- When you cannot send an email even if you have completed the settings, check the authentication method for the email server you are using.

Related Information

➔ [“Email Server Setting Items” on page 226](#)

Email Server Setting Items

Items	Explanations
Authentication Method	Displays the selected authentication method.
Authenticated Account	If you select SMTP-AUTH or POP before SMTP as the Authentication Method , enter the user name (email address) registered to the email server within 30 characters or less.
Authenticated Password	If you select SMTP-AUTH or POP before SMTP as the Authentication Method , enter the password of the authenticated account within 20 characters or less.
Sender's Email Address	Specify the email address that the printer uses to send emails. You can specify the existing email address. To make it clear that the email is being sent from the printer, you can acquire an address specifically for the printer and enter it here.
SMTP Server Address	Enter the server address of the server that sends the email (SMTP server).

Appendix

Items	Explanations
SMTP Server Port Number	Enter the port number of the server that sends the email (SMTP server).
POP3 Server Address	If you select POP before SMTP as the Authentication Method , enter the server address of the server that receives the email (POP3 server).
POP3 Server Port Number	If you select POP before SMTP as the Authentication Method , enter the port number of the email server that receives the email (POP3 server).

Checking an Email Server Connection

1. Enter **Setup** from the home screen.
2. Select **System Administration > Wi-Fi/Network Settings > Advanced Setup**.
3. Select **Email Server > Connection Check** to check that the printer is connected to the email server.

Note:

- If an error message is displayed, check if the email server settings are correct.
- When you cannot send an email even if the connection check succeeds, check the authentication method for the email server you are using.

Where to Get Help

Technical Support Web Site

If you need further help, visit the Epson support website shown below. Select your country or region and go to the support section of your local Epson website. The latest drivers, FAQs, manuals, or other downloadables are also available from the site.

<http://support.epson.net/>

<http://www.epson.eu/Support> (Europe)

If your Epson product is not operating properly and you cannot solve the problem, contact Epson support services for assistance.

Contacting Epson Support

Before Contacting Epson

If your Epson product is not operating properly and you cannot solve the problem using the troubleshooting information in your product manuals, contact Epson support services for assistance. If Epson support for your area is not listed below, contact the dealer where you purchased your product.

Epson support will be able to help you much more quickly if you give them the following information:

- Product serial number

(The serial number label is usually on the back of the product.)

Appendix

- Product model
- Product software version
(Click **About**, **Version Info**, or a similar button in the product software.)
- Brand and model of your computer
- Your computer operating system name and version
- Names and versions of the software applications you normally use with your product

Note:

Depending on the product, the dial list data for fax and/or network settings may be stored in the product's memory. Due to breakdown or repair of a product, data and/or settings may be lost. Epson shall not be responsible for the loss of any data, for backing up or recovering data and/or settings even during a warranty period. We recommend that you make your own backup data or take notes.

Help for Users in Europe

Check your Pan-European Warranty Document for information on how to contact Epson support.

Help for Users in Taiwan

Contacts for information, support, and services are:

World Wide Web

<http://www.epson.com.tw>

Information on product specifications, drivers for download, and products enquiry are available.

Epson HelpDesk

Phone: +886-2-80242008

Our HelpDesk team can help you with the following over the phone:

- Sales enquiries and product information
- Product usage questions or problems
- Enquiries on repair service and warranty

Repair service center:

<http://www.tekcare.com.tw/branchMap.page>

TekCare corporation is an authorized service center for Epson Taiwan Technology & Trading Ltd.

Help for Users in Singapore

Sources of information, support, and services available from Epson Singapore are:

World Wide Web

<http://www.epson.com.sg>

Information on product specifications, drivers for download, Frequently Asked Questions (FAQ), Sales Enquiries, and Technical Support via e-mail are available.

Appendix

Epson HelpDesk

Toll Free: 800-120-5564

Our HelpDesk team can help you with the following over the phone:

- Sales enquiries and product information
- Product usage questions or problem troubleshooting
- Enquiries on repair service and warranty

Help for Users in Thailand

Contacts for information, support, and services are:

World Wide Web

<http://www.epson.co.th>

Information on product specifications, drivers for download, Frequently Asked Questions (FAQ), and e-mail are available.

Epson Hotline

Phone: 66-2685-9899

Email: support@eth.epson.co.th

Our Hotline team can help you with the following over the phone:

- Sales enquiries and product information
- Product usage questions or problems
- Enquiries on repair service and warranty

Help for Users in Vietnam

Contacts for information, support, and services are:

Epson Hotline

Phone(Ho Chi Minh City): 84-8-823-9239

Phone(Hanoi City): 84-4-3978-4785, 84-4-3978-4775

Epson Service Center

65 Truong Dinh Street, District 1, Hochiminh City, Vietnam.

29 Tue Tinh, Quan Hai Ba Trung, Hanoi City, Vietnam

Help for Users in Indonesia

Contacts for information, support, and services are:

World Wide Web

<http://www.epson.co.id>

- Information on product specifications, drivers for download

Appendix

- Frequently Asked Questions (FAQ), Sales Enquiries, questions through e-mail

Epson Hotline

Phone: 62-21-572-4350

Fax: 62-21-572-4357

Our Hotline team can help you with the following over the phone or fax:

- Sales enquiries and product information
- Technical support

Epson Service Center

Province	Company Name	Address	Phone E-mail
DKI JAKARTA	ESS Jakarta MG. DUA	RUKO MANGGA DUA MALL NO. 48 JL. ARTERI MANGGA DUA - JAKARTA UTARA-DKI	(+6221)62301104 jkt-technical1@epson-indonesia.co.id
NORTH SUMATERA	ESC Medan	Kompleks Graha Niaga, Jl. Bambu II No. A-4, Medan- 20114	(+6261)42066090/42066091 mdn-technical@epson-indonesia.co.id
WEST JAWA	ESC Bandung	JL. CIHAMPELAS NO. 48A-BANDUNG JABAR 40116	(+6222)4207033 bdg-technical@epson-indonesia.co.id
DI YOGYAKARTA	ESC Yogyakarta	YAP Square, Blok A No.6 Jl. C Simanjutak YOGYAKARTA - DIY	(+62274)581065 ygy-technical@epson-indonesia.co.id
EAST JAWA	ESC Surabaya	HITECH MALL LT.2 BLOK A NO. 24 JL. KUSUMA BANGSA NO. 116 -118 - SURABAYA JATIM	(+6231)5355035 sby-technical@epson-indonesia.co.id
SOUTH SULAWESI	ESC Makassar	JL. GUNUNG BAWAKARAENG NO. 68E - MAKASSAR SULSEL	(+62411)328212 mksr-technical@epson-indonesia.co.id
WEST KALIMANTAN	ESC Pontianak	JL. NUSA INDAH I NO. 40A PONTIANAK KALBAR 78117	(+62561)735507 pontianak-technical@epson-indonesia.co.id
PEKANBARU	ESC PEKANBARU	JL. TUANKU TAMBUSAI NO. 353 - PEKANBARU RIAU	(+62761)21420 pkb-technical@epson-indonesia.co.id
DKI JAKARTA	ESS JAKARTA KEIAI	WISMA KEIAI LT. 1 JL. JEND. SUDIRMAN KAV. 3 JAKPUS DKI JAKARTA	(+6221)5724335 ess.support@epson-indonesia.co.id

Appendix

Province	Company Name	Address	Phone E-mail
EAST JAWA	ESS SURABAYA	JL. JAWA NO. 2-4 KAV. 29, RUKO SURYA INTI, SURABAYA - JATIM	(+6231)5014949 esssby.support@epson-indonesia.co.id
BANTEN	ESS SERPONG	Ruko mall WTC MATAHARI no. 953 SERPONG - Banten	(+6221)53167051 esstag.support@epson-indonesia.co.id
CENTRAL JAWA	ESS SEMARANG	Komplek Ruko Metro Plaza Blok C20 , Jl. MT Haryono No 970 Semarang - Jawa tengah	(+6224)8313807 esssmg.support@epson-indonesia.co.id
EAST KALIMANTAN	ESC SAMARINDA	Jl. KH. Wahid Hasyim (M. Yamin) Kel. Sempaja Selatan Kec. Samarinda Utara Samarinda- Kalimantan Timur (samping kantor pos)	(+62541)7272904 escsmd.support@epson-indonesia.co.id
SOUTH SUMATERA	ESC PALEMBANG	Jl. H.M. Rasyid Nawawi no.249, kelurahan 9 ilir Palembang - Sumsel	(+62711)311330 escplg.support@epson-indonesia.co.id
EAST JAVA	ESC JEMBER	Jl. Panglima Besar Sudirman No.1 D JEMBER - JAWA TIMUR (Depan Balai Penelitian dan Pengolahan Kakao)	(+62331) 486468,488373 jmr-admin@epson-indonesia.co.id jmr-technical@epson-indonesia.co.id
NORTH SULAWESI	ESC MANADO	Tekno @Megamall, Megamall LG TK-21 Jl. Piere Tendean Kawasan Megamas Boulevard Manado 95111	(+62431)7210033 MND-ADMIN@EPSON-INDONESIA.CO.ID

For other cities not listed here, call the Hot Line: 08071137766.

Help for Users in Malaysia

Contacts for information, support, and services are:

World Wide Web

<http://www.epson.com.my>

- Information on product specifications, drivers for download
- Frequently Asked Questions (FAQ), Sales Enquiries, questions through e-mail

Epson Call Centre

Phone: +60 1800-8-17349

- Sales enquiries and product information
- Product usage questions or problems
- Enquiries on repair services and warranty

Appendix

Head Office

Phone: 603-56288288

Fax: 603-5628 8388/603-5621 2088

Help for Users in India

Contacts for information, support, and services are:

World Wide Web

<http://www.epson.co.in>

Information on product specifications, drivers for download, and products enquiry are available.

Helpline

- Service, product information, and ordering consumables (BSNL Lines)

Toll-free number: 18004250011

Accessible 9am to 6pm, Monday through Saturday (Except public holidays)

- Service (CDMA & Mobile Users)

Toll-free number: 186030001600

Accessible 9am to 6pm, Monday through Saturday (Except public holidays)

Help for Users in the Philippines

To obtain technical support as well as other after sales services, users are welcome to contact the Epson Philippines Corporation at the telephone, fax numbers and e-mail address below:

World Wide Web

<http://www.epson.com.ph>

Information on product specifications, drivers for download, Frequently Asked Questions (FAQ), and E-mail Enquiries are available.

Epson Philippines Customer Care

Toll Free: (PLDT) 1800-1069-37766

Toll Free: (Digital) 1800-3-0037766

Metro Manila: (+632)441-9030

Web Site: <http://customercare.epson.com.ph>

E-mail: customercare@epc.epson.com.ph

Our Customer Care team can help you with the following over the phone:

- Sales enquiries and product information
- Product usage questions or problems
- Enquiries on repair service and warranty

Epson Philippines Corporation

Trunk Line: +632-706-2609

Appendix

Fax: +632-706-2665