

iPECS

GDC-480H

User Guide

Please read this guide carefully before operating your new Wireless handset. Retain the guide for future reference.

iPECS is an Ericsson-LG Brand



Regulatory and Safety Notices

1. Radio Frequency Emissions:

FCCIC Compliance statement:

This device complies with Part 15RSS-GEN of the FCCIC rules. Operation is subject to the following two conditions;

1. This device may not cause harmful interference, and
2. This device must accept any interference received, including interference that may cause undesired operation.

- (1) l'appareil ne doit pas produire de brouillage, et
- (2) l'utilisateur de l'appareil doit accepter tout brouillage radioélectrique subi, même si le brouillage est susceptible d'en compromettre le fonctionnement.

This Equipment has been tested and found to comply with the limits for a Class B digital device, pursuant to Part 15 of the FCC rules. These limits are designed to provide reasonable protection against harmful interference in a residential installation. This equipment generates, uses and can radiate radio frequency energy and, if not installed and used in accordance with the instructions, may cause harmful interference to radio communications. However, there is no guarantee that interference will not occur in a particular installation. If this equipment does cause harmful interference to radio or television reception, which can be determined by turning the equipment off and on, the user is encouraged to try to correct the interference by one of the following measures:

- Reorient or relocate the receiving antenna.
- Increase the separation between the equipment and the receiver.
- Connect the equipment into an outlet on a different circuit from that to which the receiver is connected.
- Consult the dealer or an experienced radio/TV technician for help.

Canadian Compliance statement:

This Class B digital apparatus meets the requirements of the Canadian Interference-Causing Equipment Regulations, CAN ICES-3(B)/NMB-3(B)

Cet appareil numérique de la classe B respecte toutes les exigences du Règlement sur le matériel brouilleur du Canada.

CAUTION : Any changes or modifications in construction of this device which are not expressly approved by the party responsible for compliance could void the user's authority to operate the equipment.

ATTENTION: Tout changement ou modification dans la construction de cet appareil qui ne sont pas expressément approuvés par la partie responsable de la conformité pourraient annuler l'autorité de l'utilisateur à utiliser l'équipement.

RF Exposure Statement:

This equipment complies with FCCIC RF radiation exposure limits set forth for an uncontrolled environment.

Use of other accessories may not ensure compliance with FCCIC RF exposure guidelines.

This device must not be co-located or operating in conjunction with any other antenna or transmitter. The changes or modifications not expressly approved by the party responsible for compliance could void the user's authority to operate the equipment.

For hand held operation, this phone has been tested and meets the FCCIC RF exposure guidelines. Use of other accessories may not ensure compliance with FCCIC RF exposure guidelines.

GDC-480H Wireless Handset

User Guide

European Union Declarations of Conformity:

Ericsson-LG Enterprise Co., Ltd. declares that the equipment specified in this document, which bears the "CE" mark, conforms to the European Union Radio and Telecommunications Terminal Equipment Directive (R&TTE 19995EC) including,

Electromagnetic Compatibility Directive (200695EC) and

Low Voltage Directive (2004108EC)

The product fulfills the essential requirements of the harmonized standards shown above.

2. Product Safety Instructions

This product complies with and conforms to the following international Product Safety standards as applicable:

Safety of Information Technology Equipment, IEC 6095-1, including

Relevant national deviations as listed in Compliance with IEC for Electrical Equipment (IECEE)

3. E-911 and use of the GDC-480H with Multi-Line Telephone Systems:

Please note the use and operation of this phone as part of a multi-line telephone system (MLTS) may be subject to state and/or federal E-911 MLTS laws that require the MLTS to provide a caller's telephone number, extension, and physical location to applicable state and/or local emergency services when a caller initiates a 911 call. The MLTS may not provide a caller's telephone number, extension, or physical location information to emergency services when a caller dials 911, and compliance with state and/or federal E-911 MLTS laws is the sole responsibility of the purchaser of this phone.

4. Privacy:

GDC-480H implements security and encryption technologies appropriate for DECT however, privacy of communications may not be ensured when using this telephone.

5. Unit label Notice

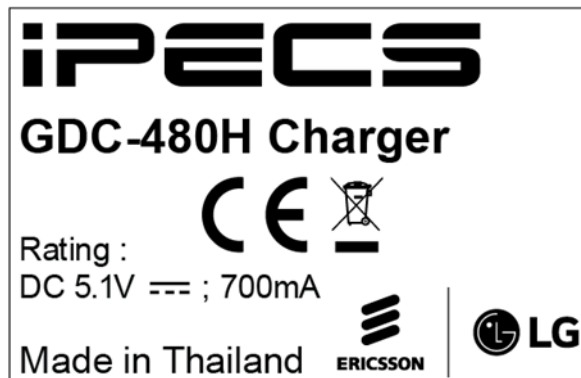

Important Care & Precautions:

Before connecting or using your new phone, take a moment to consider safety and reliability. Use common sense when locating, connecting and using your GDC-480H

- The GDC-480H uses 3.7 VDC Li-ion batteries. Replace batteries only with identical size and type available from your local Ericsson-LG Enterprise dealer. Use of a different battery type may cause damage to the phone or charger and may cause fire or explosion. Dispose of batteries in accordance with any local codes or regulation.
- The Chargerbase unit should only be used on a dry level surface. Keep the Chargerbase away from the edges of the surface to avoid the potential of a fall.
- Avoid situations where you might drop the handset. While the GDC-480H is a rugged mobile device, dropping it on to the floor may cause critical damage.
- Locate cables to avoid potential for damage. For example, do not place under rugs or carpet as damage may result from foot traffic or heavy objects. Also, do not locate cables between the desktop and walls where they may be crushed, damaging the insulation.
- Check cables regularly, and if damage is noted, disconnect your phone. Contact your local representative for a replacement.
- Should liquid spill on the handset, remove the batteries and dry with a soft cloth.
- Do not use during lightning storms. Lightning presents a potential shock hazard.
- Clean the GDC-480H with a soft dry cloth; do not use liquid cleaners.
- Always use caution when connecting to AC power. Use only with a properly grounded standard AC power outlet.

What is new in this release?

Issue	Date	Change of Contents
1.0	April, 2013	- Initial Release
1.1	July, 2015	- Added the caution of Battery handling and warranty information, etc. - Updated VSF mail content - Make the common user guide for GDC-GDC-550.

Copyright© 2013 Ericsson-LG Enterprise Co., Ltd. All Rights Reserved

This material is copyrighted by Ericsson-LG Enterprise Co., Ltd. (Ericsson-LG Enterprise). Any unauthorized reproductions, use or disclosure of this material, or any part thereof, is strictly prohibited and is a violation of Copyright Laws. Ericsson-LG Enterprise reserves the right to make changes in specifications at any time without notice. The information furnished by Ericsson-LG Enterprise in this material is believed to be accurate and reliable, but is not warranted to be true in all cases. If you are not the intended recipient, you should destroy or retrieve this material to Ericsson-LG Enterprise.

iPECS is trademark of Ericsson-LG Enterprise Co., Ltd.

All other brand and product names are trademarks or registered trademarks of their respective companies.

Important Safety Information

GDC-480H Wireless Handset

User Guide

Important safety information that will help you safely use your phone. Failure to read and follow the important safety information in this phone user guide may result in serious bodily injury, death, or property damage.



WARNING: Violation of the instructions may cause serious injury or death.



CAUTION: Violation of the instructions may cause minor or serious damage to the product.

CAUTION: Location and Environment for the Installation

- Install the product strictly following the user guide included in the product. If not, the product would not function or its lifetime could be shortened.
- Avoid installing the product towards the direct ray of the sun or in locations exposed to direct sunlight, on carpets or cushions. If not, the phone could be damaged, or fire or electric shock could be caused.
- Avoid installing the product in dusty locations. If not, sand could be intruded into the phone, and fire, electric shock or other product defects can occur.
- Avoid installing the product in the locations where a strong vibration exists. If not, the product performance could decline or its lifetime could be shortened.
- Do not place vase, cosmetics or containers filled with water, milk or beverage in proximity to the product. The liquid spilled out could cause fire, electric shock, malfunction, etc.
- Avoid installing the product near fire or in a small space with poor ventilation. If not, fire or product defects could be caused.
- Do not put the phone inside a washing machine or a microwave. It could cause explosion, problems, deformation or defects.
- Avoid installing the product on a shelf or a slanted surface. If not, the product could fall, causing personal injuries or defects on the phone.
- Avoid installing the product close to other electronic products such as TV, audio instruments, etc. It may cause some noises due to electromagnetic interference. Properly install the base away from such products.
- Avoid installing or using the product near kitchen utensils such as cooking table, humidifier, rice-cooker, etc., or in locations exposed to rain and wind or such places as bathroom where water might be splashed. Electric shock, fire, deformation or product defects could be caused.

WARNING: Power Supply

- Remove dust from the power plug pin and insert the power plug tightly into power receptacle. If not, fire or electric shock could be caused.
- Do not use a damaged or loosened plug, and do not modify or damage the power cord. Fire or electric shock could be caused.
- Do not connect a multiple number of cords into a single power connector. Fire or electric shock could be caused.
- Do not touch the power plug with wet hands and grasp the power supply plug when unplugging the power cord. Fire or electric shock could be caused.
- Do not cover the power cord and the adaptor with a pad, and do not place them near heating instruments. Do not let children or pets bite the phone or the power cable. Fire or electric shock could be caused.
- Use the adaptor that was included in the product package (See the product specification). Check the rated voltage at home. Using other voltages may cause a fire.
- Ensure that the external cords of the phone are disconnected before it is moved from the installation site. If not, fire or electric shock could be caused.
- Do not bend the power cord reluctantly, and do not place a heavy instrument on the power cord. Fire or electric shock could be caused.

WARNING: Battery Handling

GDC-480H Wireless Handset

User Guide

- Do not disassemble or revise the battery and do not use it for other purposes. Use the specified battery and adaptor only. Fire or personal injury may be caused by heat or rupture.
- If the battery is damaged, the battery liquid may leak out. Take care not to contact the battery leakage. Keep it away from your eyes, skin or cloths. If there is any contact, immediately clean it with water and take medical care as soon as possible.
- Dispose the used battery in a specified place. Improper treatment may cause an unexpected accident.
- Do not apply impact on the battery by throwing it, and do not place it close to heating instruments (microwave, heater). The battery liquid may leak out, or fire or explosion may be caused.
- Never damage the shield tube nor contact the + and - pins of the battery with a metal. Fire or physical injury may be caused by heat or rupture.
- Do not store the battery in locations exposed to direct sunlight or with high temperature and humidity (store it in a room at 0°~ +40°). Deformation or explosion could be caused.
- Do not let children or pets suck or bite the battery. Putting the battery into mouth is harmful for human body. Should a child swallow the battery, consult a physician as soon as possible.
- If you detect smokes or a strange smell while using the phone or charging the battery, unplug the power cord and contact the service center. Using it in such condition may cause fire or an electric shock.

Caring for the Battery

Protecting Your Battery

The guidelines listed below help you get the most out of your battery's performance.

- Recently there have been some public reports of phone batteries overheating, catching fire or exploding. It appears that many, if not all, of these reports involve counterfeit or inexpensive, aftermarket-brand batteries with unknown or questionable manufacturing standards. Use only Ericsson-LG Enterprise Enterprise approved batteries and accessories.
- In order to avoid damage, charge the battery only in temperatures that range from 32° F to 113° F (0° C to 50° C).
- Do not use the battery charger in direct sunlight or in high humidity areas, such as the bathroom.
- Never dispose of the battery by incineration.
- Keep the metal contacts on top of the battery clean.
- Do not attempt to disassemble or short-circuit the battery.
- The battery may need recharging if it has not been used for a long period of time.
- It is best to replace the battery when it no longer provides acceptable performance. It can be recharged hundreds of times before it needs replacing.
- Do not store the battery in high temperature areas for long periods of time. It is best to follow these storage rules:
 - Less than one month: -4° F to 113° F (-20° C to 40° C).
 - More than one month: -4° F to 113° F (-20° C to 45° C).

Disposal of Lithium Ion (Li-Ion) Batteries

Do not handle a damaged or leaking Li-Ion battery as you can be burned.

For safe disposal options of your Li-Ion batteries, contact your nearest Ericsson-LG Enterprise Enterprise authorized service center.

Special Note

Be sure to dispose of your battery properly. In some areas, the disposal of batteries in household or business trash may be prohibited.

CAUTION: Operation

GDC-480H Wireless Handset

User Guide

- Do not let anybody disassemble or alter the device other than qualified service personnel. Contact the distributor and the customer service center for the inspection and repair. Fire, an electric shock or problems could be caused.
- Do not touch the power plug during lightning storms. It can cause an electric shock or death.
- Be careful not to let any foreign materials get into the product. In particular, if a staple and pins are magnetized on the receiver, make sure to eliminate it before use. Using it in such condition may cause fire, electric shock, or injury especially on the face.
- Do not drop objects or apply impact on the phone. The phone could be damaged, or personal injury or product defects could be caused.
- If you detect a burning smell or smoke, immediately stop using the product, disconnect the power supply plug and the phone cable and contact the service center. Using it in such condition may cause fire or electric shock.
- Pay attention not to let the phone contact with volatile substances (benzene, thinner, alcohol, acetone, etc.) If not, fire, deformation or decolorization could be caused.
- Pay attention not to be stumbled over the phone cable or power cord. Accident, injury or product defects could be caused.
- Do not let water penetrate into the product. Should water penetrate into the product, disconnect the power supply plug and the phone cable and contact the distributor or the service center. Using it in such condition may cause electric shock.
- Do not drop the phone during operation and do not throw it toward a person. If the product is dropped and damaged, disconnect the power supply plug and contact the distributor or the service center. The phone could be damaged, or accident, personal injury or product defects could be caused.
- Avoid using the phone where there is a gas leakage. If there is a gas leakage, do not touch the phone, phone cord and receptacle with hands and open the window for ventilation. Flames may cause explosion, resulting in fire or burn injury.
- When the charging contacts are wet with water or stained with foreign materials, use the product after wiping them with dry towel. Using it in such condition may cause accident, injury or product problems.
- Do not cover the phone with wrap or vinyl for packing. The coating may peel away.
- Pay attention not to hurt with the edges or angles of the product, and be careful not to let a child put the mic or power cord into the mouth. If not, it can cause an accident, injury or product defects.
- Never place your ears in proximity to the speaker hole, nor insert a driver or

Table of Contents

1. Introduction	1
1.1 Description	1
1.1.1 Handset.....	1
1.1.2 GDC-480H Display	4
1.1.3 Chargerbase Unit	6
2 Getting Started	7
2.1 Unpacking the GDC-480H	7
2.2 Installing the batteries	9
2.3 Connecting the chargerbase Unit.....	10
2.4 Charging the handset without chargerbase Unit	10
2.5 Installing the Belt Clip.....	11
2.6 Installation of Wireless Terminal	11
2.7 Subscribing the GDC-480H to a System.....	12
2.7.1 Enabling Subscriptions	12
2.7.2 Subscribing to the System.....	12
2.7.3 Terminating a Subscription.....	13
2.8 Authentication	14
3 Using the Basic Features	15
3.1 Turning the GDC-480H ON and OFF.....	15
3.2 Volume Adjustments	15
3.2.1 Adjusting the Audio volume	15
3.2.2 Adjusting the Ringer volume.....	15
3.3 Muting your Microphone.....	16
3.4 Placing an Outside Call.....	16
3.5 Releasing a Call	16
3.6 Answering a Call	17
3.7 Placing a Call on Hold.....	17
3.8 Call Transfer.....	18
3.9 Do Not Disturb (DND)	18
3.10 Last Number Redial	18
3.11 System Last Number Redial	19
3.12 Handset Speed Dial	19
3.13 System Save Number Redial	19
4 Using Advance System Features	20
4.1 Program a System User Name	20

4.2	Request a Busy Station Call Back	20
4.3	Leaving a Return Call Message	21
4.4	Camping-on to a Busy Station	21
4.5	Linked Stations Pairs	21
4.6	Answering a Call Ringing at Another Station	22
4.7	Using Station Speed Dialing	22
4.8	Using System Speed Numbers	23
4.9	Call Forward.....	23
4.10	Pre-defined & Custom Text Messaging	24
4.11	Responding to a Message Wait Indication.....	25
4.12	Blocking Outgoing Calls wTemporary COS	26
4.13	Paging.....	27
4.14	Call Park	27
4.15	Conference Room.....	28
4.16	Universal Night Answer.....	28
4.17	Using the System Alarm Clock.....	29
4.18	To Register a System Access Authorization Code (PIN)	29
4.19	Responding to an Authorization (PIN) Request	30
4.20	System Voice Announcements	30
4.21	Using System Voice Mail	30
4.22	User Program Codes	30
4.23	Alarm message	32
5	GDC-480H User Menu Features	33
5.1	Call Register (Call Log).....	33
5.2	Display	34
5.3	Sound.....	35
5.4	Phonebook	36
5.4.1	Dialing from Phonebook	37
5.4.2	Adding Records to the Phonebook.....	37
5.4.3	Modifying Records in the Phonebook	38
5.4.4	Deleting records from the Phonebook	38
5.4.5	Searching the Phonebook with Find	39
5.4.6	Phonebook UploadDownload with PC.....	39
5.5	Bluetooth only for GDC-	42
5.6	Phone Settings.....	43
5.6.1	Clock, Date and Time display	44
5.6.2	Alarm Clock	44

GDC-480H Wireless Handset User Guide

5.6.3	Keypad Tones	45
5.6.4	Language	45
5.6.5	Silent Mode	45
5.6.6	Keypad Lock.....	46
5.6.7	SW Version	46
5.6.8	Edit CO Code	46
5.6.9	Missed Call Mode	47
5.6.10	Range Out Beep.....	47
5.6.11	Clock Display.....	48
5.6.12	Auto Answer Mode	48
5.6.13	Auto Release Mode	49
5.6.14	Emergency Call	49
5.6.15	Block Dialed Call	49
5.7	Phone Register	49
5.7.1	Subscription.....	50
5.7.2	Base Choice	51
5.7.3	Modify PIN.....	51
5.7.4	Base ID.....	51
5.7.5	Reset	51
5.8	Appointment.....	52
5.9	Direct Call.....	53
6	Troubleshooting.....	54
7	Specifications	55
8	Dial pad Character Charts	56
9	GDC-480H User Menu	58

1. Introduction

Thank you for selecting the Ericsson-LG Enterprise GDC-480H Wireless handset. With our GDC-480H you will experience great in-building mobility with access to all of the many features and functions of your Ericsson-LG Enterprise communication system. This guide is intended to provide you with detailed information on the use of your new Ericsson-LG Enterprise Wireless DECT handset.

GDC-480H is a wireless handset that employs DECT technology to provide local in-building mobility. Wireless Radio Frequencies (RF) signals are exchanged between the handset and base stations (GDC-400B600B600BE). Multiple base stations connect to the Wireless Management Interface (WMI) in your Ericsson-LG Enterprise phone system. The WMI links the connected base stations forming a larger Base or Zone. Within this zone, transparent handover of active communications between base stations in the zone is supported. The button and features are almost same between GDC-480H and GDC-. But GDC-480H does not support Bluetooth feature and the model name is different.

1.1 Description

1.1.1 Handset











The GDC-480H, shown in the Handset Diagram, appears much like a mobile cell phone. On the front are the dial pad, a number of control buttons (described in the Handset Buttons and Features list) and a large LCD display. In the lower rear of the unit is the battery compartment. The battery charging terminals are located at the bottom of the unit. On the right side of the GDC-480H is the headset jack.



**Handset Diagram
Handset Buttons and Features**

GDC-480H Wireless Handset

User Guide

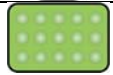
Number	Button	Description
1		<p>Navigation button:</p> <p>Left arrow – idle state=view missed call, other states=left navigation</p> <p>Right arrow – Idle state=place call (host intercom dial tone), active call state=press to Transfer call, or press and hold 1 second to place call on hold, in User Menu=right navigation.</p> <p>Up and Down arrows – Idle state=Up for Local redial, Down for Phonebook menu, active call state=adjust audio volume, in User Menu=up and down navigation.</p> <p>OK Button – Same as the Left soft button</p>
2		<p>Left & Right soft button: Interactive menu displayed directly above buttons. Selection varies as needed. To select, press the soft button directly below item.</p>
3		<p>Talk button: Connects handset to host system to answer incoming or place outgoing calls.</p>
4		<p>Recall (Flash)Clear button: active call state=register recall, flash to regain dial tone; idle state=press to clear single digit press and hold 1 second to delete all digits.</p>
5		<p>*Silent Alert button: idle and dial state=press to dial '*', press and hold 1 second to turn Silent Alert ON and OFF; active internal call=camp-on from host.</p>
6		<p>Call back button: Leave a call back or recall message</p>
7		<p>End call & Power button: Press to end a call or reject a call, press and hold 1 second to turn power ON & OFF.</p>
8	0~9	<p>Dial Pad buttons</p>
9		<p>#Lock button: idle and dial state=press for '#', press and hold 1 second to lock dial pad.</p>
10		<p>SpeedProgram button: Host dial tone=press to access Station or System Speed dial, press and hold 1 second for host program mode.</p>
11		<p>Side button: Adjust the Ringer volume and Audio volume.</p>
12		<p>Emergency button: Immediately call the designation number in emergency situations.</p>

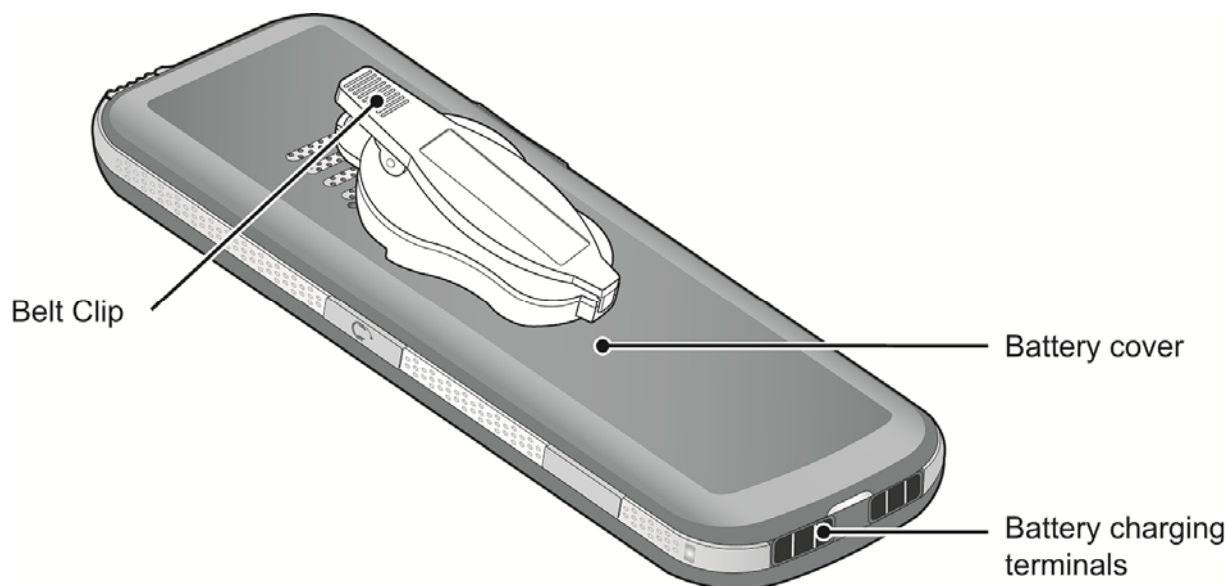

GDC-480H (rear view)

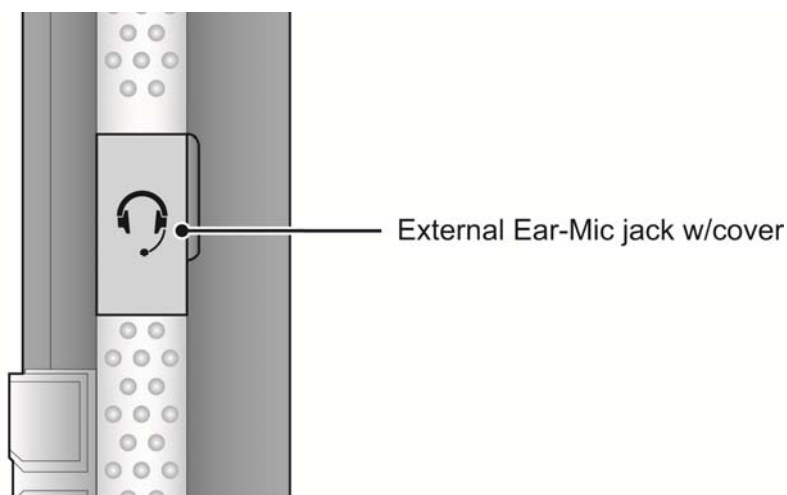

If an Ear MicrophoneHeadset is attached to a GDC-480H, it can receive or release a call. It is recommended to use a Headset meeting JIS C-6560 Specification. Press the button on the Ear MicrophoneHeadset to receive an incoming call when ringing, and do the same action to release the call. Making a call by using the Ear MicrophoneHeadset is supported, too; press the button once on the Ear MicrophoneHeadset when in the idle state, then select a number to dial from the redial list and the make the call by pressing the button.

Note:

Using a noise canceling or unidirectional Ear MicrophoneHeadset, with an impedance below 1 K Ω (usually is 1-2.2K Ω) may cause abnormal operation (unit may self-answer without pressing the button when an incoming call is received, and unit may hang-up unexpectedly while using the Ear MicrophoneHeadset).

Warning







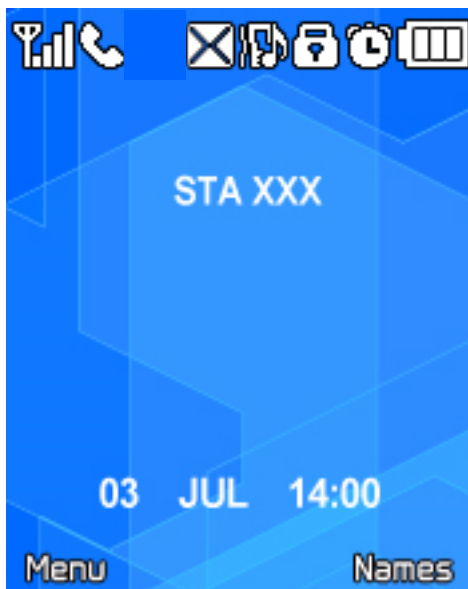

- 1) Do not insert any external substance except ear-microphone for GDC-480H in the hole. Inserting anything except for ear-microphone provided by general maker may cause severe damage to the terminal.
- 2) Be careful not to let any foreign materials get into the product. In particular, if a staple and pins are magnetized on the receiver, make sure to eliminate it before use. Using it in such condition may cause fire, electric shock, or injury especially on the face.

1.1.2 GDC-480H Display

The GDC-480H has a large 176 x 220 pixel full-color TFT LCD (Liquid Crystal Display). The display indicates the status of the handset and provides visual feedback for dialing and other actions. Various icons, detailed in the chart below, are shown at the top of the display. The central area of the display shows messages from the host Ericsson-LG Enterprise system and the phone itself. At the bottom are selections for the Left and Right soft buttons.







GDC-480H Icons

Icon	Name & Description
	<p>Antenna Icon () & RSSI Icon () The antenna icon indicates a DECT connection is established with the Base station. The RSSI (Received Signal Strength Indicator) is a meter of the RF signal strength received by the handset. The number of vertical bars (0 ~ 4) indicates the relative strength. At less than 2 bars, call quality may not be acceptable. When no vertical bars are present there is insufficient RF signal to process signals and calls can not be placed or received.</p>
	<p>Phone icon Indicates the handset is off-hook, talking or dialing and a DECT channel is established.</p>
	<p>Silent Alert icon Indicates the ringer in the phone is Off. The phone will visual notify you of incoming calls and may alert you with the vibrator. See Images & Sounds in the User Menu section.</p>
	<p>Message icon Indicates the system has at least one new message or callback message for the wireless terminal. The message information is updated at 3 minute intervals.</p>
	<p>Alarm icon When the message is sent from alarm server and the terminal receives it, the terminal will be displayed in the screen.</p>
	<p>Keypad lock icon Indicates the phone dial pad and buttons are inactive. This prevents accidental is buttons press as may happen with a wireless handset.</p>
	<p>Alarm clock icon Indicates an Appointment is set.</p>

GDC-480H Wireless Handset

User Guide

Icon	Name & Description
	<p>Battery icon Vertical lines indicate battery charge state. At one (1) bar charging is recommended, and call quality may be affected. When low battery (1 bar), backlight will turn off to save battery power.</p> <p>The last Icon means the battery is charging.</p>
	<p>Bluetooth icon: only GDC- is available. The Bluetooth is available if activation is Yes. So it allows you to use a wireless headset. Using a headset permits you to move freely around phone and maintain a conversation.</p>
	<p>Bluetooth headset icon: only GDC- is available. Before using the headset, the headset must be paired with GDC- handset. The Bluetooth headset icon is displayed if the pairing is successful.</p>
	<p>Speakerphone icon Speakerphone can be activated by pressing Hook off button during a call. Additionally, you can switch between the handset and Speakerphone during a call.</p>

Common System and Handset Messages

System Messages

Message	Description	Display Duration
STA xxxx	Station number	Idle state
CALL FROM STA xxxx	Station number of calling internal user.	Alerting and active internal call
CALL TO STA xxxx	Station number of called internal user	Alerting and active internal call
HOLDING STA xxxx	Station number of waiting call.	Call on hold or transferring
LN XXX RINGING	CO line number in host system	Alerting
LN XXX	CO line number in host system	Active external call
NO CHANNEL	No RF or system channel available	Until a channel is available
INVALID	Station dialed is not valid	About 30 seconds
NO ANSWER STA XXX	Called user does not answer	About 30 seconds
NO RESP. STA XXX	Called station is not responding, perhaps power is Off	About 30 seconds

Handset Messages

Message	Description	Display Duration
Range Out	Out-of-range of a base station or not yet subscribed to a system. Phone will not function. Walls, buildings, and other obstruction, especially large metal surfaces negatively impact useable range between the handset and Base station.	Out-of-range or not subscribed
No Channel	No available RF Channel in Base station	All RF channels busy
Silent Mode	Alert mode is vibrate, no audible ring is provide in silent alert mode	Silent alert mode
Direct call	Handset is in a Direct call (Hotline)	Active on direct call

GDC-480H Wireless Handset

User Guide

Message	Description	Display Duration
Keypad Locked	The handset dial pad is locked; no outgoing calls can be made.	Until handset is unlocked
0~9, *, #, P, D, R	Dialed digits and special characters. (P -:Pause, D -:Go to DTMF, R -:Flash)	Dialing

1.1.3 Chargerbase Unit

The Chargerbase unit (pn GDC-450SSC) is used to charge the GDC-480H handset and to house the handset when not in use. Terminals in the charger mate to terminals in the bottom of the handset to allow the batteries to charge. Fully charged batteries provide about 12 hours of talk-time or about 80 hours of standby-time. To fully charge "dead" batteries requires about 6 hours in the Charger.

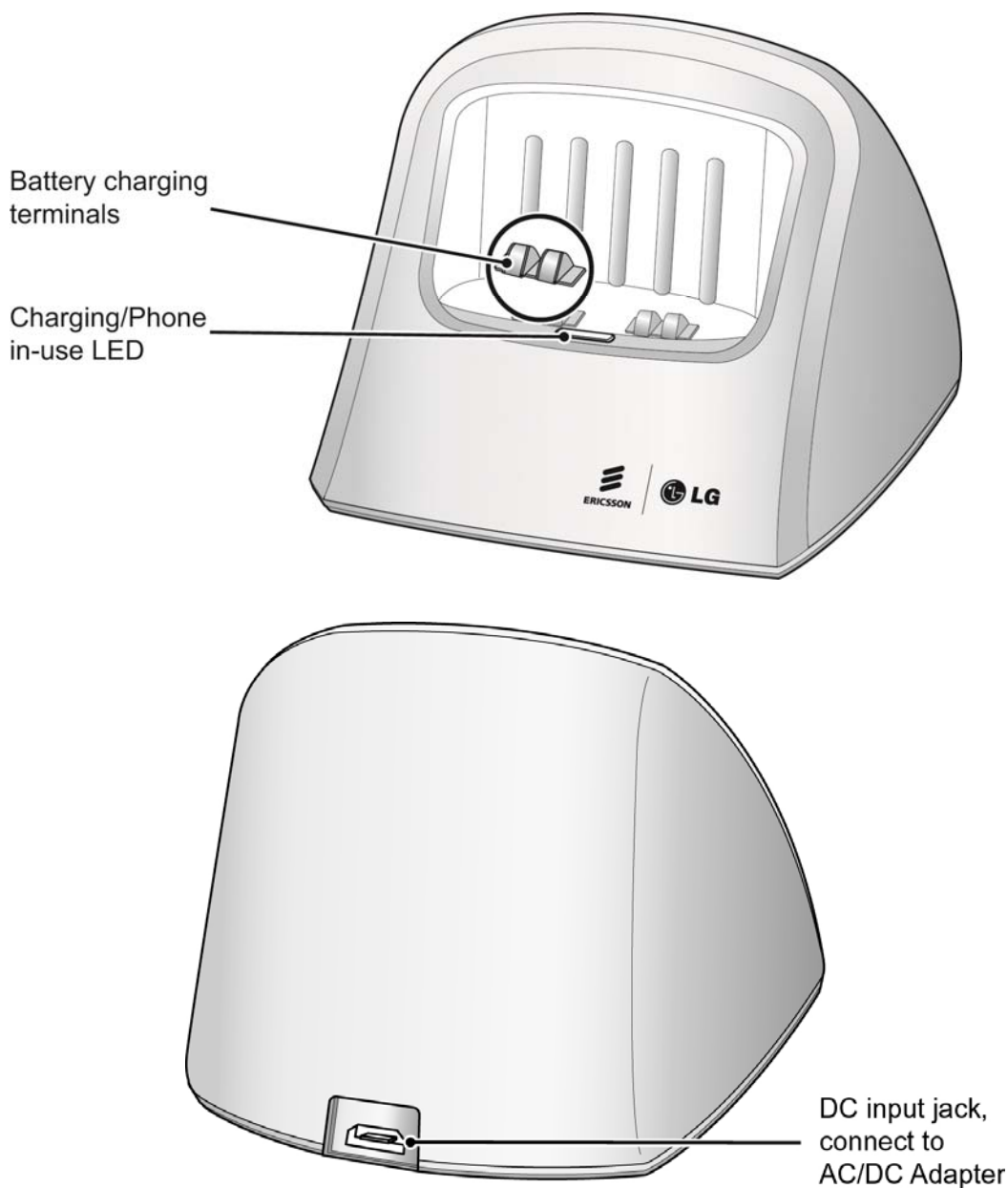

2 Getting Started

Before you can begin to use your new GDC-480H you must unpack the unit, install the batteries, charge the unit and register the item for service to your telephone system. This section provides you the information needed to complete these steps.

2.1 Unpacking the GDC-480H

Each GDC-480H package contains the items below. These items include the GDC-480H handset, Chargerbase, ACDC adapter, Li-ion batteries, this User Guide and a belt clip. Unpack the carton and assure all items are available.

GDC-480H package



Handset



ChargerBase

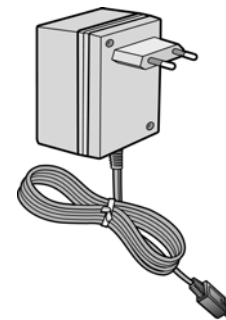

ACDC Adapter



Batteries



Quick Guide

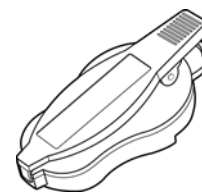

Belt Clip



Ear-Microphone

GDC-480H Wireless Handset

User Guide

GDC- package



Handset



ChargerBase

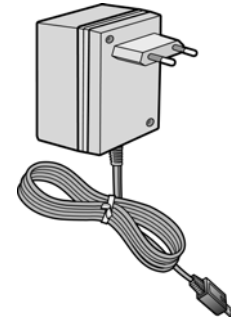

ACDC Adapter



Batteries



Quick Guide



Belt Clip



Ear-Microphone

2.2 Installing the batteries

The batteries are installed in the battery cavity in the rear of the unit. To install the batteries,

1. Remove the battery cover located on the rear of the unit. Press the latch at the top of the cover and slide the cover down to remove.
2. Insert batteries. Assure the battery polarity matches the polarity in the battery cavity.
3. Place the cover on the unit just below the cavity and push the cover upward until the latch is engaged.
4. The unit must be placed in the charger for approximately 6 hours to fully charge the batteries.

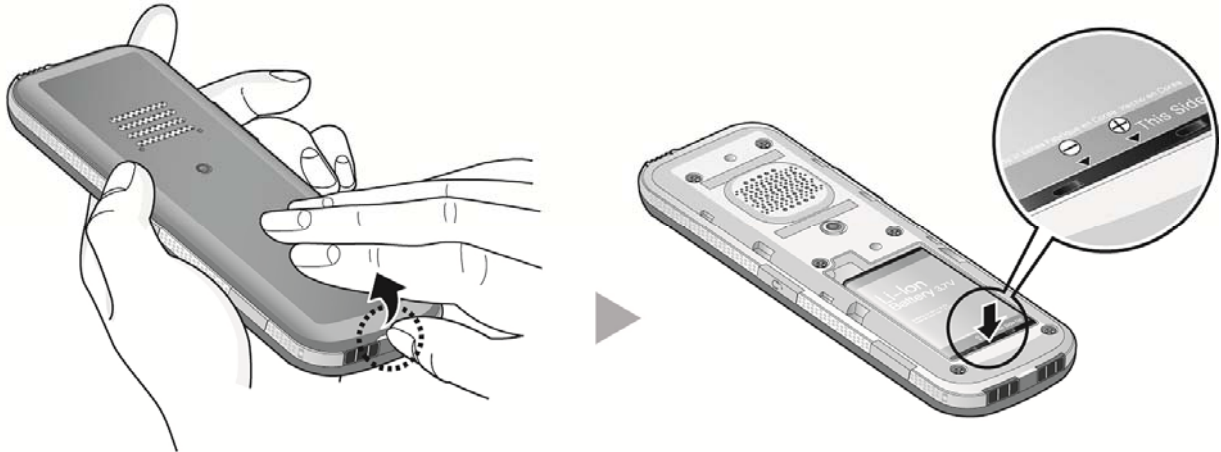

Mode	Duration	Charging Time
Talk Mode	12 hours	Full charge 9 hours
Standby Mode	80 hours	

Note:

Poor care of batteries limits their useful operating life. Keep phone in the Chargerbase when not in use.

At low battery levels (less than 1 battery power bar), the display backlight turns OFF to maximize battery charge.



CAUTION

- ✓ Use only with batteries provided for the GDC-480H. Use of other types of batteries may cause harm to the unit or explosion.
- ✓ Dispose of used batteries in accordance with local codes and regulations.
- ✓ **Battery Limited Warranty:** we warrant 6 months from the date of purchase.
- ✓ If the water damage sticker of the battery is normally white, but when it has come in contact with water or a liquid containing water, it will turn fully red. So if the battery has been damaged by liquid, the service for liquid damage is not covered by the warranty.



Water damage sticker

2.3 Connecting the chargerbase Unit

The Chargerbase unit must be connected to power using the supplied ACDC Adapter.

1. Plug the DC output plug of the adapter into the DC input of the charger.
2. Insert the AC plug of the adapter into an AC outlet.

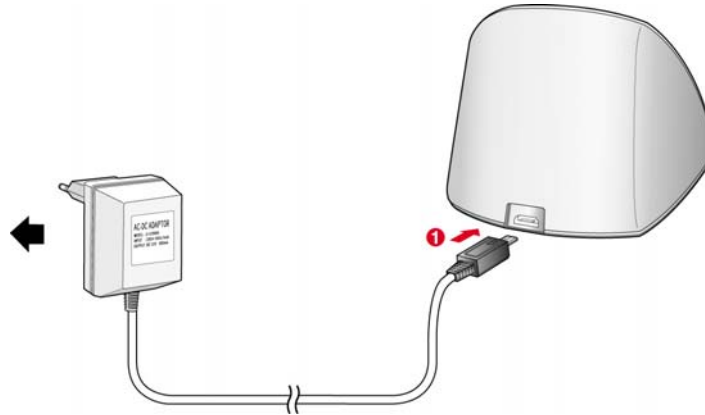

Use only the adapter provided with the unit. Use of a different adapter could damage the unit or cause a fire and will invalidate your warranty.

2.4 Charging the handset without chargerbase Unit

The handset can be charged without charger as below. Also it is available to charge Handset during a call if Auto Release Mode is OFF.

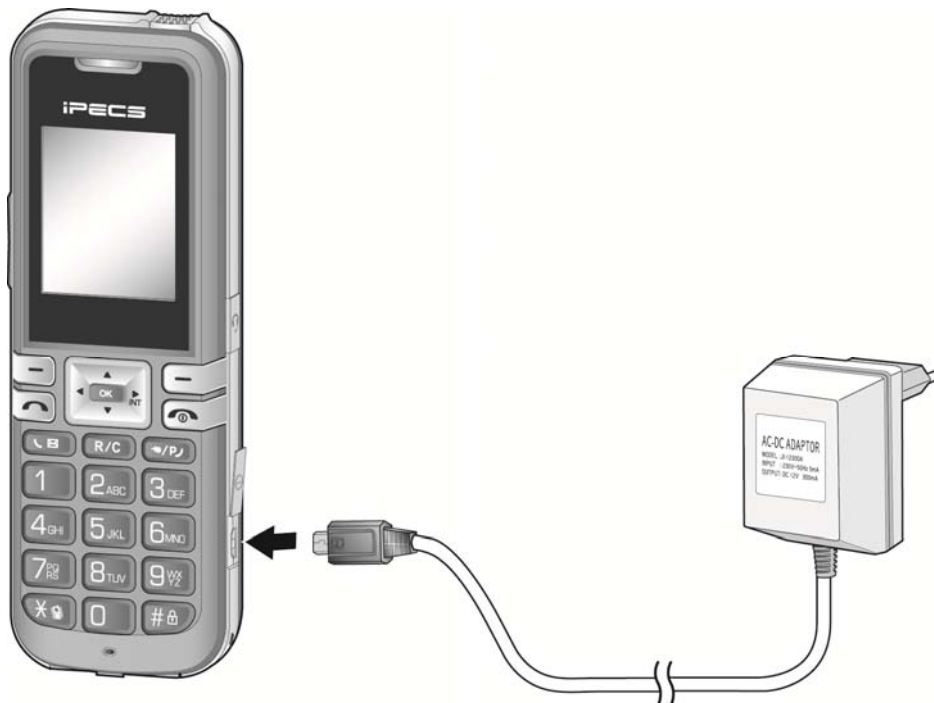

Note:

Use only the adapter provided with the unit. Use of a different adapter could damage the unit or cause a fire and will invalidate your warranty. It is not available to charge using USB port of PC.

2.5 Installing the Belt Clip

The GDC-480H comes with a belt clip that can be installed on the unit. To install the belt clip, refer to the figure and instructions below.

When installing the belt clip:

1. Turn the screw clockwise on the back of the unit.
2. The belt clip is pulled upward until the screw is inserted into the hole securely.

When uninstalling the belt clip:

1. The belt clip is pulled down with pushing the button of the belt clip until the lock is open.

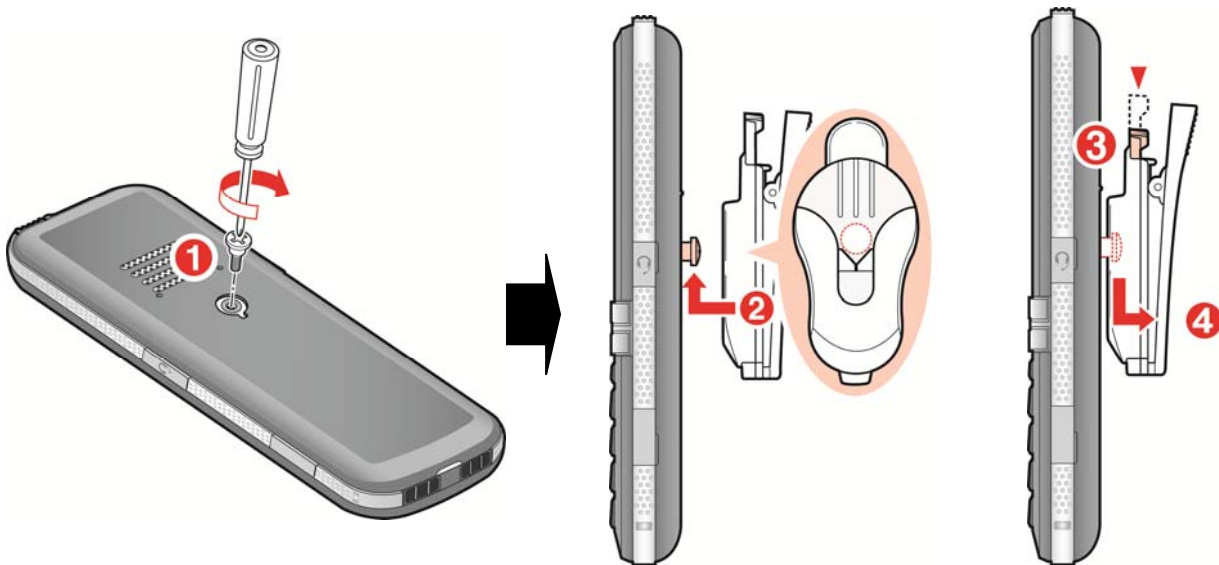

2.6 Installation of Wireless Terminal

Before using the GDC-480H, the wireless terminal must be subscribed to a System. The subscription process must be conducted at the User Station, and at the Attendant Station to ensure proper function of the wireless terminal. Proper Authorization Codes should be obtained from the System Administrator or the Attendant before processing the subscription (refer to [Subscribing the GDC-480H to a System](#)).

The wireless terminal is allowed to be subscribed to up to 4 GAP systems. If a user wants to subscribe to more than 4 systems, the wireless terminal first should be unsubscribed from one of the systems. This subscription procedure can be performed by a User. There are two methods to unsubscribe the wireless terminal from the key system:

- The User can unsubscribe from the system and the wireless terminal at the same time (details described in [Terminating a Subscription](#)).
- The second method is to unsubscribe locally in the system or at the wireless terminal separately.



Warning

If a user terminates their subscription at their terminal, the Attendant should be notified so terminal information can be deleted from the System.

2.7 Subscribing the GDC-480H to a System

Prior to accepting a connection with a GDC-480H, a subscription to services must be entered into the WMI of your telephone system. This is accomplished in a two step process: the Attendant station enables subscription of a phone to the system, then the GDC-480H subscribes to the system for services.

2.7.1 Enabling Subscriptions

To enable a subscription, from the Attendant station;

1. Press **[TransPgm]** button; the Pgm LED flashes and the Monitor-Speaker LED lights.
2. Press '0 and #'.
3. Press Flexible button 1.
4. Dial the subscribing station number.
5. Enter the Phone Type; 5 for new systems, or 1 for older systems (pre 1.0B sw).
6. Press **[HoldSave]** button.
7. When the subscription completes, a confirmation tone is received and then press Monitor-Speaker button.









📖 Note:

Don't press Monitor or Speaker button at the Attendant phone until the GDC-480H completes the subscription and subscription confirmation tone is heard.

2.7.2 Subscribing to the System

When subscribing to the system you will need the system's unique Radio Frequency Personal Identification (RFPI) and the System Authentication code (AC, available from your System Administrator). Also, before starting the subscription process make sure you are close to an active system Base station and the RSSI indicator is steady.

To subscribe to the system from the GDC-480H:

1. Press the **Menu** () button to display the menu.
2. From the menu use the **Navigation** () button to highlight Phone Register.
3. Press the **OK** () button; this displays the Phone Register menu.
4. Select "Subscription" using the up and down arrows of the **Navigation** () button and press the **OK** () button.
5. Select an available BASE station number and press the **OK** () button; the GDC-480H searches for the system, displaying and "Searching..x". When a system is found, its RFPI, is displayed. The RFPI of your system is available from your System Administrator, or perhaps the attendant.
6. Press **OK** () button while highlighting the RFPI to continue the subscription to the system, or
7. Press **No** () button to continue the search.
8. Enter your subscription Authentication code (AC); code is available from either your System Administrator, or the attendant.
9. Press **OK** () button; on successful subscription, a confirmation tone is received at the GDC-480H and the Attendant Station.
10. If the subscription fails, repeat procedure from Step 3 to 6 at the Attendant Station and Step 1 to 8 from the GDC-480H (refer to Note).

Note:

Depending on the system or radio channel environment, the system or the wireless terminal may not recognize that the system has the subscribed wireless terminal or the wireless terminal is subscribed to the system. Once a user has performed the subscription procedure, the user should attempt to make a call. Then, if a user can't make a call, the subscription procedure should be conducted again after selecting the unsubscribe menu item (refer to [Terminating a Subscription](#) section).

2.7.3 Terminating a Subscription

Unsubscribing will make a wireless terminal lose connection to the iPECS-LIKMG WOTS, UCP, and eMG80800. The subscription data of the phone (stored in MPB and WTIB or the wireless terminal) should be erased separately at both User Station and Attendant Station using the Unsubscribe procedure. To unsubscribe a wireless terminal, it should be in an idle state.

To Unsubscribe from the Attendant Station:

TRANSPGM + 0# + Flex. Button 2 + Station No. + **HOLDSAVE**

- 1) Press **TRANSPGM** button. (**TRANSPGM** LED flashes and **MON** LED lights steady.)
- 2) Press **0#**.
- 3) Press Flexible button 2.
- 4) Enter the station number.
- 5) Press **HOLDSAVE** button and confirmation tone is heard.
- 6) Confirmation tone (or error tone) will be heard at the Station, and the corresponding Attendant Station.
- 7) LCD message "No Subscription" will be displayed if there is no subscribed system.

In rare cases when subscription data must be deleted from a lost phone, etc., the following procedure may be used.

To Unsubscribe users locally in the system from the Attendant Station:

To unsubscribe all wireless terminals at once,

TRANSPGM + 0 #+ Flex. Button 7 + Password (147*) + **HOLDSAVE**

- 1) Press **TRANSPGM** button (**TRANSPGM** LED flashes and **MON** LED lights steady).
- 2) Press **0#**.
- 3) Press Flexible button 7.
- 4) Enter the Password (default=147*).
- 5) Press **HOLDSAVE** button and confirmation tone is heard.
- 6) Confirmation tone (or error tone) will be heard at the Station, and the corresponding Attendant Station.

To unsubscribe one subscribed wireless terminal,

TRANSPGM + 0 # + Flex. Button 8 + Station No + **HOLDSAVE**

- 1) Press **TRANSPGM** button (**TRANSPGM** LED flashes and **MON** LED lights steady).
- 2) Press **0#**.
- 3) Press Flexible button 8.

GDC-480H Wireless Handset User Guide

- 4) Enter the Station No.
- 5) Press **[HOLDSAVE]** button and confirmation tone is heard.
- 6) Confirmation tone (or error tone) will be heard at the Station, and the corresponding Attendant Station.

2.8 Authentication

Verifies the wireless terminal and/or the user with the System. The User inputs the User Personal Identification (UPI) or Authorization code/PIN (5-digits), when requested by System Attendant.

To Authenticate a User from the Attendant Station:

[TRANSPGM] + 0 # + Flex. Button 5 + Station No + **[HOLDSAVE]**

- 1) Press **[TRANSPGM]** button (**[TRANSPGM]** LED flashes and **[MON]** LED lights steady).
- 2) Press "0 #" ('0 #' in iPECS-LIKUCPeMG).
- 3) Press Flexible button 5.
- 4) Enter a station number to be authenticated.
- 5) Press **[HOLDSAVE]** button and confirmation tone is heard.

To Authenticate a User from the Wireless Terminal:

When the attendant presses **[HOLDSAVE]**, a message asking for User authentication will be displayed on the wireless terminal along with an audible confirmation tone.

PIN (5 digit) + **[OK]**

- 1) Enter five-digit Authorization code/PIN.
- 2) Press **OK** (**[OK]**) button longer than 1 second.
- 3) Confirmation tone (or error tone) will be heard at the Station, and the corresponding Attendant Station.

3 Using the Basic Features

Some buttons have multiple functions. In some cases, a button will activate one feature when simply pressed and activate another feature when the button is pressed and held for a little longer than 1 second. For example, turning the power ON and OFF is done using the End & Power button. Pressing the button will end an active call, holding the button turns power OFF. Buttons may also provide different functions depending on the state of the phone; when idle the button may provide one function and when busy, the button activates a different feature. Local phone features are generally accessed by a button with the handset idle while system features are accessed when the phone is in the talk mode waiting to dial.

In many cases a dial code (a series of digits) is required to activate a feature. Since dial codes are different for each system and may be changed through Admin, codes are referenced by name. Code digits are available from your System Administrator, or perhaps the Attendant.

3.1 Turning the GDC-480H ON and OFF

Your new Wireless handset operates on 1 Li-ion rechargeable batteries. When not in-use, it should be turned OFF to extend the life of the batteries. Fully charged, batteries provide about 15 hours of talk-time or about 120 hours of standby time.

To turn the power ON or OFF:

Power ON

1. Press and hold (2 second) the EndPower () button to turn power ON; the handset displays “Range Out” while searching for a base station. After the handset locates a base station, the Antenna and RSSI icon displays

Power OFF

1. Press and hold (2 second) the **EndPower** () button to turn power OFF. After a validation tone is received, the handset switches OFF.

3.2 Volume Adjustments

3.2.1 Adjusting the Audio volume

During a call, you can adjust the audio volume from the earpiece (level 1 to 6).





To adjust the audio volume:



1. While on a call, press the Up or Down arrow on the **Navigation** () button.
Or Press the Side button.

3.2.2 Adjusting the Ringer volume

You can adjust the ringer volume separately for internal and external calls (level 1 to 9).

To adjust the ringer volume level:



- 1) Press the **Menu** () button to display the menu.
- 2) In the menu, use the **Navigation** () button to highlight Sound and press the **OK** () button; this displays the Sound menu.
- 3) From this menu, select Sounds using the Up and Down arrows of the **Navigation** () button and press the **OK** () button.

- 4) From this menu select External Ring or Internal Ring to set the ringer volume for external or internal calls respectively and press the **OK** () button.
- 5) Use the Left and right arrows of the **Navigation** () button to highlight the volume level and press the **OK** () button.
Or Press the Side button.

3.3 Muting your Microphone

During a call, you can mute the microphone so that the connected party can't hear what is said in your vicinity. While the Mic. is muted you will still hear the connected party.

To mute the microphone while on a call:

1. Press the **Option** () left soft button. The handset displays the Call Options menu.
2. Use The Up and Down arrows of the **Navigation** () button to highlight Mute and press the **OK** () button; MUTED is shown in the display.



To deactivate Mute so that the connected party can hear you:

1. Press the **Enable** () right soft button, the function is deactivated.

3.4 Placing an Outside Call

While the phone is idle, you may dial a call (up to 24 digits). The display indicates the last 11 digits dialed. In case an error occurs during dialing, you may delete the last or all digits using the **delete** () right soft button. Pressing the button deletes the last digit, holding the button pressed for more than 1 second deletes all digits.

To Place a call:

1. Dial the phone number; remember you may need to dial an access code such as '9' to place an external call.
2. Press the **Talk** () button; the Phone icon () displays and the number dials.

You alternatively can press the **Talk** () button prior to dialing. In this case, when you press the button you will receive a dial tone and may then dial the number. Note that unlike the pre-dialing above, digits cannot be deleted.

3.5 Releasing a Call

While on an active call, incoming or outgoing, you may release the call at any time.



To release a call:

1. Press the **End** () button. The wireless terminal ends the call and returns to an idle state.

3.6 Answering a Call

When a call is received, you receive a visual indication of the incoming call. The Call type icon flashes EXT or INT indicating an external or internal call and the calling number is shown. If the number is stored in the local Phonebook, the associated name is displayed. In addition to the visual indication, you receive either an audible ring or the phone vibrates based on handset set-up selection (refer to incoming call alert setting). You may answer or reject the call; both will terminate the incoming call signals at the handset.

To answer an incoming call:

1. Handset rings, the Call type icon flashes and Caller ID is displayed (if available).
2. Press **Talk** () button to answer a call; the phone icon () and the Call type display.

 **Note:**

If the handset is in the Chargerbase, lifting the handset out of the charger automatically answers an incoming call. This function is available if Auto Answer Mode sets up 'Enabled'.

To reject the incoming call and stop the incoming call signal:

1. Press the **End** () button, all signaling stops, but the caller hears ring-back tone.

3.7 Placing a Call on Hold

While you are on a call using the GDC-480H, you may place the caller in a waiting state where the caller hears music on hold. This allows you to place another call or answer a call waiting.

To place a call on hold:

1. Press and hold, 1 second, the right arrow on the **Navigation** () button. The call is placed on hold and other party receives audio from the System music source. The User's GDC-480H receives dial tone from the system.

 **Note:**

If a second call is waiting, the above procedure automatically connects the waiting call.

To place another call:

1. Press the **End** () button; the wireless terminal returns to an idle state.
2. Place second call in the normal manner.



To retrieve the held call:

1. Press and hold, 1 second, the right arrow on the **Navigation** () button; the held call is re-connected.

3.8 Call Transfer

You can send an active call to another user of your Ericsson-LG Enterprise system. You can announce the transfer to the receiving party (Screened Transfer) or without an announcement (Unscreened Transfer).

To transfer an active call:

1. Press the **right arrow Navigation** () button; the call is placed on hold and dial tone is received.
2. Dial the number of the internal user to receive the call.
3. To complete the transfer without announcement, press the **End** () button,
OR
4. To announce the transfer, await answer, announce the transfer and press the **End** () button.

3.9 Do Not Disturb (DND)

When the DND (Do Not Disturb) feature is active, the GDC-480H will not notify you of an incoming call. The handset will not ring or vibrate allowing you to work without interruption from an incoming call. The host Ericsson-LG Enterprise system determines routing of the incoming call while your phone is in DND.

To activate DND:

1. Press the **Talk** () button.
2. Dial the DND code, default 553; a confirmation tone is received and the handset enters DND.
3. And then the wireless terminal returns to an idle state.





To deactivate DND:

1. Press the **Talk** () button.
2. Dial the DND code, default 553; confirmation tone is received and the handset enters DND.
3. And then the wireless terminal goes to an idle state.

3.10 Last Number Redial

The GDC-480H stores the last ten (10) numbers called in memory. These can be internal or external phone numbers. These numbers can be accessed and a number selected quickly for redialing.





To use Last Number Redial, while idle:

1. Press the up arrow on the **Navigation** () button. The last five dialed numbers are displayed.
2. Use the **Navigation** () button to highlight the desired number and press the **left** () soft button. This will access the Option menu.
3. Use the **Navigation** () button to highlight Call in the Option menu and press the **left** () soft button. The selected number is dialed.

3.11 System Last Number Redial

The host Ericsson-LG Enterprise system stores the last fifteen (15) external numbers called by the GDC-480H in system memory. These numbers can be accessed and the number selected for quick redialing.

To use System Last Number Redial:

1. Press the **Talk** () button.
2. Press the **SpeedProgram** () button.
3. Press the **asterisk** () button; the last number is shown in the display.
4. Use the up and down arrows on the **Navigation** () button to display the desired number.
5. Press and hold, 2 second, the right arrow on the **Navigation** () button with the number highlighted. The handset places a call to the selected number.

 **Note:**

This feature works with external calls only, internal calls are not registered for System Last Number Redial.

3.12 Handset Speed Dial

The GDC-480H incorporates a Phonebook that can contain up to 60 records. Each record contains a name, number and a record number. Numbers from the Phonebook can be automatically dialed by entering the Phonebook record number (1-60). Refer to the Phonebook section later in this guide for details on the Phonebook.

To speed dial a number from Phonebook:

1. Dial the Phonebook entry number (1-60), holding each digit for longer than 1 second. If a number is stored in the entry, the number is dialed automatically. If no number is stored for the Phonebook entry, the dialed digits are ignored.



3.13 System Save Number Redial

You can save a number in the host system memory for quick access at a later time.

To save a number while on an outgoing call:

1. Press **SpeedProgram** () button twice during a call.

To dial a Saved number:

1. Press **Talk** () button.
2. Press **SpeedProgram** () button.
3. Press the **pound** () button.

 **Note:**

If the line used to make the original call is busy, redial uses an available line from the same line group.



This feature works with external calls only and will not work for internal calls, calls within the host system.

4 Using Advance System Features

4.1 Program a System User Name

You can store a name in the host system for use as your id when you are called or call another station. The User name is also employed with Dial-by-Name.

To assign your User name:



1. Press the **Talk** () button, you receive dial tone.
2. Press and hold, 2 second, the **SpeedProgram** () button.
3. Dial the Name Program Code, default is 74.
4. Enter the station's name using two (2) digits for each character. Refer to the character entry chart below. Up to 12 characters can be entered.
5. Press and hold, 2 second, the **SpeedProgram** () button to store the information.
6. And then the wireless terminal goes to an idle state.

A = 2-1	B = 2-2	C = 2-3	D = 3-1	E = 3-2	F = 3-3
G = 4-1	H = 4-2	I = 4-3	J = 5-1	K = 5-2	L = 5-3
M = 6-1	N = 6-2	O = 6-3	P = 7-1	Q = 1-1	R = 7-2
S = 7-3	T = 8-1	U = 8-2	V = 8-3	W = 9-1	X = 9-2
Y = 9-3	Z = 1-2	. = 1-3	, = *-3	: = *-2	
space =*-1	0 = 0-0	1 = 1-0	2 = 2-0	3 = 3-0	
4 = 4-0]	5 = 5-0	6 = 6-0	7 = 7-0	8 = 8-0	9 = 9-0

4.2 Request a Busy Station Call Back

If you receive busy tone when calling another station, you may request to be placed in a queue to receive a Call Back. When the called station returns to idle, the system signals you with Callback ring. When you answer, the now idle station is called.

To activate a callback:

1. While receiving internal call busy tone, press the **Call back** () button, you will receive confirmation tone.
2. Press the **End** () button. The wireless terminal goes to an idle state.

When the busy station returns to idle, you receive a Callback.

1. Answer the callback in the normal manner.
2. Await answer from the previously called station.



Note:

A maximum of 5 simultaneous callbacks can be active. Call backs are returned in the order received at the Station (your callback may not be first in line). If you do not answer a callback ring within 15 seconds, the callback is cancelled.

4.3 Leaving a Return Call Message

When a station user does not answer your call or is in DND, you may request the user callback when available. The station receives a Message Wait indication and responds using the procedure in Responding to a Message Wait section discussed later in this guide.

To leave a return call request:

1. When your call to another station is unanswered or you receive DND tone, press the **Call back** () button, you will receive confirmation or, if available, the option to leave a voice message.
2. Follow the voice instructions to leave a voice message.
3. Press the **End** () button.

 **Note:**

You may wish to leave a voice message. When given the option, follow the verbal instructions of the Voice Mail system.



To hear VSF mail system, leaving a return call message:

1. Press the **Talk** button () button.
2. Press the **Call Back** button () button twice.
3. Enter the password to hear VSF mail.

4.4 Camping-on to a Busy Station

If you receive busy tone when calling another station, you may request to alert the called party of your call waiting. When camped-on, the system sends a call wait tone to the busy station. The busy user can decide to place the active call on hold to respond to your call, ignore your call, or enter DND.

To camp-on a busy station and send a Call Waiting signal:

1. While receiving internal call busy tone, press the **asterisk** () button, you and the called user receive the Call Waiting tone.
2. Wait until answered or press the **End** () button to cancel camp-on.

To answer a call waiting if you receive a call waiting tone:

1. Press and hold, 1 second, the right arrow of the **Navigation** () button. The active call is placed on hold and the new call is connected.

4.5 Linked Stations Pairs

Your handset may be linked to another station in the host system. When linked operation of the two stations is synchronized; when one is busy the other is busy and when one is in DND the other is in DND. Either can activate and deactivate user features.

 **Note:**

The system may take up to 3 minutes to notify the handset of changes to the state of user features such as DND. A linked station will display "IN USE AT LINK" when the other linked station is in use; on a call.

4.6 Answering a Call Ringing at Another Station

When another station rings and you may be allowed to answer (pick up) the call. There are two (2) types of pick-up; directed call pick up answers a call to a specific phone, and group pick-up answers a call to a group of phones.

To pick up a call for a specific ringing station:

1. Press the **Talk** () button, you receive dial tone.
2. Dial the Directed Call Pick-up code, default is 7.
3. Dial the number of the ringing station.

To answer a call to a group of ringing stations:

1. Press the **Talk** () button, you receive dial tone.
2. Dial the Group Call Pick-up code. Refer to your System Administrator or, perhaps the Attendant for the dial code.

Note:







In certain situations such as private line calls, callbacks, etc., you will not be permitted to pick up a ringing call.

4.7 Using Station Speed Dialing

In addition to the Phonebook numbers, the host system provides memory for additional Speed dial numbers. Once stored these numbers can be accessed and dialed. Each of the Station Speed dial numbers can be up to 24 digits in length and may include special instructions including:

'*' as 1st digit	Activate Display Security, do not display number.
Flash as 1st digit	Activate dial-tone detect.
'#'	Insert a pause dialing command.
'*' not 1st digit	Switch from Pulse to DTMF dialing.
[msgcallbk]	Send as ISDN Keypad Facility IE.
[hold]	Insert a Pulse to tone switch-over

To store a Station Speed dial number:

1. Press the **Talk** () button, you receive dial tone.
2. Press and hold, 2 seconds, the **SpeedProgram** () button.
3. Press the **SpeedProgram** () button.
4. Dial the Speed dial bin location (may be obtained from System Administrator).
5. If iPECS-LIKUCPeMG system, dial the CO Access code (may be obtained from System Administrator).
6. Dial the phone number to store.
7. Press and hold, 2 seconds, the **SpeedProgram** () button.
8. If desired enter a name to associate with the number. Refer to the "Programming a Name into Display" section earlier in the guide.
9. Press and hold, 2 seconds, the **SpeedProgram** () button.
10. Press the **End** () button.

Repeat the above procedure to store additional Speed dial numbers.



To delete a Station Speed Dial number:

1. Press the **Talk** () button, you receive dial tone.
2. Press and hold, 2 seconds, the **SpeedProgram** () button.
3. Press the **SpeedProgram** () button.
4. Dial the Speed dial bin location.
5. If iPECS-LIKUCPeMG system, press the **SpeedProgram** () button.

Note:

Depending on the host system, the number of Station Speed dials available, the length of the stored number, and special instructions available will vary (check with your System Administrator).



To use a Station Speed Dial:

1. Press the **Talk** () button, you receive dial tone.
2. Press the **SpeedProgram** () button.
3. Dial the Speed dial bin location.

4.8 Using System Speed Numbers

In addition to Station Speed Dials, the host system includes memory to store system speed dial numbers available to all stations connected to the system. These numbers are stored by the attendant or System Administrator.

To use a System Speed Dial:

1. Press the **Talk** () button, you receive dial tone.
2. Press the **SpeedProgram** () button.
3. Dial the Speed dial bin location. Contact your System Administrator for System Speed dial numbers available.

Note:

In some cases, your access to Speed dials may be limited in the system (check with your System Administrator).

4.9 Call Forward

You may select to have your incoming calls re-routed to another station, a station group, or voice mail.

To activate call forward for your calls:

1. Press **Talk** () button, you receive dial tone.
2. Dial the Call Forward code (default=554).
3. Dial the Call Forward type code-
 - ♦ 0 – Follow-me forward
 - ♦ 1 – Unconditional forward
 - ♦ 2 – Busy forward
 - ♦ 3 – No answer forward
 - ♦ 4 – Busy or No answer forward
 - ♦ 5-9 – Off-net forward, check with your System Administrator

- ◆ # - Cancel call forward
- 4. Dial the internal destination station, group, etc.
- 5. Press the **End** () button.

Note:

When forwarding calls to voice mail, assure you have created a voice mail greeting. In some cases, such as Follow-me forward, you must enter an Authorization Code to activate the feature. DND and Call Forward are mutually exclusive features. If DND is active, Call Forward cannot be set. You must have allowed Call Forward in the host system for Call Forward to be available at the terminal.



To hear the VSF mail system, Leaving a Return Call Message:

1. Press the talk button.
2. Press the call back button.
3. Press the call back button again.
4. Enter the password.

4.10 Pre-defined & Custom Text Messaging



You can select a text message to be shown on the display of a calling station. When active, incoming intercom callers see the text message in the phone's LCD. There are ten Pre-defined messages (01-10), ten system wide Custom messages and one User Custom Message. Several of the ten Pre-defined messages allow for auxiliary information such as a time, date or number as shown in the chart below.

To activate call forward for your calls:

1. Press the **Talk** () button, you receive dial tone.
2. Press and hold, 2 second, the **SpeedProgram** () button.
3. Dial the Text Message code, default 51.
4. Dial the message number.
5. Dial any additional information required by the message.
6. Press and hold, 2 second, the **SpeedProgram** () button.
7. And then the wireless terminal goes to an idle state.

Message Code	Message Description
0 0	User Custom Message
0 1	LUNCH TILL hh:mm
0 2	VACATION mm dd
0 3	OUT OFFICE TILL hh:mm
0 4	OUT OFFICE mm dd
0 5	OUT OFFICE UNKNOWN
0 6	T) (Telephone No. up to 17 digits)
0 7	IN OFFICE STA xxx
0 8	MEETING TILL hh:mm
0 9	AT HOME
1 0	AT BRANCH OFFICE
#	Cancel Message
1 1 ~ 2 0	Custom System Messages, contact the Attendant.

To create a User Custom Message:

1. Press the **Talk** () button, you receive dial tone.
2. Press and hold, 2 seconds, the **SpeedProgram** () button.
3. Dial the Text Message code, default 52.
4. Dial the message content using the 2 digits for each character method, see chart below.
5. Press and hold, 2 seconds, the **SpeedProgram** () button.
6. And then the wireless terminal goes to an idle state.







A = 2-1	B = 2-2	C = 2-3	D = 3-1	E = 3-2	F = 3-3
G = 4-1	H = 4-2	I = 4-3	J = 5-1	K = 5-2	L = 5-3
M = 6-1	N = 6-2	O = 6-3	P = 7-1	Q = 1-1	R = 7-2
S = 7-3	T = 8-1	U = 8-2	V = 8-3	W = 9-1	X = 9-2
Y = 9-3	Z = 1-2	. = 1-3	, = *-3	: = *-2	
space =*-1	0 = 0-0	1 = 1-0	2 = 2-0	3 = 3-0	
4 = 4-0]	5 = 5-0	6 = 6-0	7 = 7-0	8 = 8-0	9 = 9-0

4.11 Responding to a Message Wait Indication



Your system supports a number of message formats including station callback message and voice mail. Depending on the host system and configuration, you may receive missed external call messages and internal Short Message Service (SMS). When a message has been left, you receive a message waiting icon. When you respond to all outstanding messages, the icon disappears.

There are two primary message wait response procedures, one for the iPECS-LIKUCPeMG and one for the iPECS. Check with your System Administrator to determine the correct operation for your system.

To a message wait from an iPECS-LIKUCPeMG system wintegrated mail option:



1. Press the **Talk** () button, you receive dial tone.
2. Press the **Call back** () button. If you have a station callback message, the station is called.
3. If the message is a voice mail, the first voice message is played. Press and hold, 1 second, the right arrow on the **Navigation** () button for the next voice message. To replay a message press the **Call back** () button. To erase a voice message, press the **RecallClear** () button.
4. Press the **End** () button. If you have responded to all your messages, the message waiting indication is terminated.

To respond to a message wait from an iPECS system:

1. Press the **Talk** () button, you receive dial tone.
2. Press the **Call back** () button. The system sends the message summary display as below. This display shows the types of messages and the number of each waiting.

STCLVSVMSMS 000000000000

3. or, ST (station call back messages) dial 1 and press the **Call back** () button to return the message. To delete a station message without a call back, press the * and 1 digits; to delete all station messages without a call back, press the # and 1.

For CL (missed call with CLI messages), dial 2 and press the right arrow on the **Navigation** () button to return the call. To delete the current CLI message, press the **Call back** () button and to delete all CLI messages press the **SpeedProgram** () button twice.

For VS (integrated basic mail) or VM (3rd party voice mail) or UC (integrated Unified Communications server) messages, dial 3, 4 or 5 and follow the voice prompts to hear, delete and manage your messages.



For MS (internal SMS messages), dial 6 and a summary of the text messages, up to 10 are shown. Dial the SMS number (0 ~ 10) to view the entire message. To delete the SMS, dial # and 1; to cancel and return to idle, dial # and 2: to delete all internal SMS messages, dial # and 3.

4. Press the **End** () button. If you have responded to all your messages, the message waiting indication is terminated.



4.12 Blocking Outgoing Calls wTemporary COS

As an alternative to the handset Keypad Lock, you can block external calls from the handset employing the host system by activating Temporary Class-of-Service. When Temporary COS is active, the handset can make internal calls but cannot make external calls.

To activate Temporary COS and block outbound external calls:

1. Press the **Talk** () button, you receive dial tone.
2. Press and hold, 2 second, the **SpeedProgram** () button.
3. Dial the Activate Temporary COS code, default 21.
4. Press and hold, 2 second, the **SpeedProgram** () button.
5. And then the wireless terminal goes to an idle state.

To restore the normal COS and allow outbound external calls

1. Press the **Talk** () button, you receive dial tone.
2. Press and hold, 2 second, the **SpeedProgram** () button.
3. Dial the Cancel Temporary COS code, default 22.
4. DialEnter your Authorization code (PIN).
5. Press and hold, 2 second, the **SpeedProgram** () button.
6. And then the wireless terminal goes to an idle state.



Note:

A user authorization code is required to restore COS.

4.13 Paging



The host system incorporates voice broadcasts to other stations and external speakers. During a page, voice is broadcast to the speaker of idle stations assigned to receive the page. Each station is assigned to a page group, known as a zone, and individual zones are paged. The Dial code and number of page zones vary between systems (ask System Administrator for Page zone dial codes).

To Page over the host system:

1. Press the **Talk** () button, you receive dial tone.
2. Dial the Page zone, see your System Administrator for Page Zones codes.
3. After the confirmation tone, speak in a normal voice; your voice is broadcast to the zone dialed.
4. When done, press the **End** () button.

A paging party may request another user join in a conversation. The paged party can respond to the page and the two parties are joined in a private conversation.



To respond to a request to join a conversation:

1. Press the **Talk** () button, you receive dial tone.
2. Dial the Meet Me code, default is 544.
3. After the confirmation tone, a private connection is established to the paging party.
4. When done, press the **End** () button.



4.14 Call Park

Call Park is commonly used with paging and is used to transfer a call to someone not at a known station. The call is parked and the desired party paged to answer the parked call. The paged party dials the park location, known as an orbit, to answer the call.

To park an active external call:

1. Press the right arrow of the **Navigation** () button, the call is placed in parking hold.
2. Dial the Park orbit code, see your System Administrator for codes.
3. Press the **End** () button.
4. Page desired party.



To answer a park call from idle:

1. Press the **Talk** () button, you receive dial tone.
2. Dial the Park orbit code, see your System Administrator for codes.
3. After the confirmation tone, a private connection is established to parked call.
4. When done, press the **End** () button.



4.15 Conference Room

GDC-480H cannot initiate a conference. It can, however, create, join, and delete a conference room.

To activate (create) a conference room:

1. Press the **Talk** () button, you receive dial tone.
2. Press SpeedProgram button (longer than 2 sec.), and dial 53 (conference room activate code) + Room Number (1-9).
3. Enter optional 5-digit conference room password (as needed).
4. Press right arrow of the **Navigation** () button (longer than 2 sec.).

To deactivate (delete) a conference room:

1. Press the **Talk** () button, you receive dial tone.
2. Press SpeedProgram button (longer than 2 sec.), and dial 54 (conference room delete code) + Room Number (1-9).
3. Press right arrow of the **Navigation** () button (longer than 2 sec.).



To join a conference room:

1. Press the **Talk** () button, you receive dial tone.
2. Dial 59 (conference room join code) + conference room number (1-9).
3. If enabled, enter the 5-digit conference room password.

4.16 Universal Night Answer

In the Night mode, the host system changes assigned incoming call routing often to alert through external speaker systems. Universal Night Answer (UNA) permits you to answer such ringing calls at night.



To use UNA to answer a call:

1. Press the **Talk** () button, you receive dial tone.
2. Dial the UNA code, see your System Administrator for the UNA dial code.
3. After the confirmation tone, a private connection is established to the caller.
4. When done, press the **End** () button.



4.17 Using the System Alarm Clock

In addition to the handset Appointment feature, the host system incorporates a wake-up or alarm clock feature. When the alarm time is reached, the system alerts you with ring signal and displays "WAKEUP RING." The wake-up call is effective for one-day or until canceled (repetitive).

To set the wake-up time:

1. Press the **Talk** () button, you receive dial tone.
2. Press and hold, 2 second, the **SpeedProgram** () button.
3. Dial the Set Wake-up code (default=41).
4. Dial the Wake-up time as hh:mm in 24 hour format (2359).
5. Press # for a repetitive alarm, otherwise a one-time alarm is set.
6. Press and hold, 2 second, the **SpeedProgram** () button.
7. And then the wireless terminal goes to an idle state.



To set the wake-up time:

1. Press the **Talk** () button, you receive dial tone.
2. Press and hold, 2 second, the **SpeedProgram** () button.
3. Dial the Cancel Wake-up code (default= 42).
4. Press and hold, 2 second, the **SpeedProgram** () button.
5. And then the wireless terminal goes to an idle state.

4.18 To Register a System Access Authorization Code (PIN)

For certain operations the host system may require you enter a System Access Authorization code, or Personal Identification Number (PIN). These codes are used to prevent unauthorized use of external system resources and to end Temporary COS. You must create your PIN prior to attempting to activate Temporary COS or accessing restricted facilities.

To create or modify your System PIN:

1. Press the **Talk** () button, the dial tone will be heard.
2. Press and hold the **SpeedProgram** () button for 2-second.
3. Dial the Auth. Code; select to Modify dial code (as needed, ask your System Administrator for codes).
4. Press and hold the **SpeedProgram** () button again for 2-second.
5. And then the wireless terminal goes to an idle state.



Note:

Depending on the host system, an Authorization code initially may be set as the station number. Also, the number of digits may vary for different host systems (refer to the System Administrator for more details).

4.19 Responding to an Authorization (PIN) Request

In order to manage wireless terminals, the Attendant may request you to enter your PIN. When the display message “PIN” appears, you must respond by entering your PIN (Authorization code).

To enter your code:



1. Press the **Talk** () button, the dial tone will be heard.
2. Enter your password with the dial pad.
3. Press and hold, 2 seconds, the **SpeedProgram** () button.

4.20 System Voice Announcements

If the host system includes an integrated voice response system, your handset can play various announcements as well as voice mail features. Announcements include the Date & Time, Station Number and Status. The status prompt includes:

- Station number XXXX
- Listed message X
- Wake-up time XXXX AM or PM
- Do not disturb
- Forwarded to station XXXX
- Forwarded to speed binSTAHUNT XXX
- Locked (temporary COS change)
- COS X

To hear a prompt:

1. Press the **Talk** () button, you receive dial tone.
2. Press and hold, 2 seconds, the **SpeedProgram** () button.
3. Dial the Prompt code. See your System Administrator for codes.
4. Press and hold, 2 seconds, the **SpeedProgram** () button.
5. And then the wireless terminal goes to an idle state.

4.21 Using System Voice Mail

Your host system may have one of several voice mail sub-systems including integrated or 3rd party options. For details on your Voice Mail, contact your System Administrator.



4.22 User Program Codes

The host system permits user control of a number of features including Temporary COS, Wake-up Alarm Clock, etc. You access the various controls through the User Program (Pgm) feature using codes. The various codes and features vary between systems; your System Administrator can provide you with available codes. The table below is an example of User Pgm codes and their use.

GDC-480H Wireless Handset

User Guide

To access a User Program:

1. Press the **Talk** () button, you receive dial tone.
2. Press and hold, 2 second, the **SpeedProgram** () button.
3. Dial the User Pgm Code and any required entry. See your System Administrator for codes.
4. Press and hold, 2 second, the **SpeedProgram** () button.
5. And then the wireless terminal goes to an idle state.

Example of User Program Code Chart

User PGM Code	Description	Display	Remark
14 & x x=1 - 0	Call Coverage	CALL COVERAGE MODE	1=On, 0=Off
		DELAY RING CYCLE	Dial 0-9
21	Temp COS	ICM ONLY MODE	
22	Restore COS	ENTER CURRENT PASSWORD	
23	COS Override (Walking COS)	COS OVERRIDE CODE (User Authorization Code)	
31 & x (Msg Type)	Message Wait Retrieval	[1] ST: STATION MSG	
		[2] CL: CALLER ID MSG	
		[3] VS: SYSTEM VOICE MAIL	
		[4] VM: COMMERCIAL VOICE MAIL	
		[5] US: UMS SERVER VM	
		[6] SMS MESSAGE	
33 & System PIN	Authorization code	ENTER CURRENT PASSWORD	Station No. + Auth Code
34 & x x= 1 - 0	DID Call Wait	DID WAIT	1=On, 0=Off
35 & x x=1 - 0	Select Msg alert choice	CHOICE EXESEC MSG	1=On, 0=Off
36 & x (type)	Create and send or resend message	SMS SEND MODE	Resend = 1 Edit = 2
37 & x x=1 - 0	Register a mobile phone	REGISTER MOBILE-EXT	1=On, 0=Off
38 & mobile number	Activate a mobile phone registrations	ACTIVATE MOBILE-EXT	Tel number
	Register the mobile phone CLI		1=On, 0=Off
41 & time	Set wake-up alarm time	YOUR WAKEUP TIME	Hhmm, 24-hour clock
42	Cancel Wake-up Alarm	ERASED WAKEUP TIME	
51 & Msg number [xx]	Set Pre-defined Msg.	MESSAGE DEACTIVATED	
		[00] USER CUSTOM MSG	
		[01] LUNCH RETURN TIME	
		[02] VACATION TIME	
		[03] OUT OF OFFICE TIME	
		[04] OUT OF OFFICE DATE	
		[05] OUT OF OFFICE	
		[06] CALL TO STATION	
		[07] IN OFFICE STATION	
[08] IN A MEETING TIME			

GDC-480H Wireless Handset User Guide

User PGM Code	Description	Display	Remark
		[09] AT HOME	
		[10] AT BRANCH OFFICE	
		[11-20] UN-REGISTER MSG	
52	Create a Station User Message	MESSAGE : 00	
53 & Rm & Auth Code	Start a Conf Room	DIAL NO (1-9) AND PASSWD	
54 & Rm & Auth Code	Close a Conf Room	DIAL NO (1-9) AND PASSWD	
71	Set language for the display	Domestic English	
72	Software Version	SW VERSION COUNTRY	
74 & Name	User name creation	NAME	2 digit for each character
75	Display IP address	DISPLAY GATEWAY IP ADDRESS	IP Address displayed wo dot separator
77	Display MAC address	DISPLAY GATEWAY MAC ADDRESS	MAC

4.23 Alarm message

The function of alarm message is an emergency message sent by the alarm server. The features are a message display, 5 alarm tones+ no tone+ vibration, and the 9 volume level. The latest 10 messages are saved. It can be applied for the UCP system only (UCP+WTIM48+GDC-600BE+GDC-480H)

To view the message in the list,

1. Press the message button.
2. Display the message lists.
3. Select the message list using navigation button.
4. Press the **OK** () left soft button.
5. Display the message.
6. Press the Read left soft button.
7. Display the "Read message".
8. Display the checked message list .

If the message is read in the list and selected again, then the message can be deleted. The alarm message is emergency and can be displayed in the Idle or talk state. If the message is received in the idle state, then the message will be displayed until it is read. In talk state, the message will be displayed for 10 seconds only.



 : Alarm message icon





When the message is sent from alarm server and the terminal receives it, the terminal will be displayed in the screen.

5 GDC-480H User Menu Features

GDC-480H incorporates a menu you employ to control various features and attributes of the handset. The Appendix GDC-480H User Menu displays the Menu tree. The main sub-menus are:

- ♦ Call Register (Call Log)
- ♦ Display
- ♦ Sound
- ♦ Phonebook
- ♦ Bluetooth: **Not available in GDC-480H**
- ♦ Phone Settings
- ♦ Phone Register
- ♦ Appointment
- ♦ Direct Call

To display the User Menu, with the handset idle:

1. Press the **Menu** () left soft button.
2. Use the **Navigation** () button to highlight a selection.
3. Press the **OK** () left soft button to access the sub-menu.
4. Press the **Back** () right soft button to return to the previous menu.



The following sections provide details on each of these menu selections.

5.1 Call Register (Call Log)

The Call Register maintains a log of up to 100 calls to and from the handset including missed calls. There are four selections in this sub-menu.



- ♦ Missed Call logs incoming calls not answered by the handset.
- ♦ Received Call logs incoming calls answered by the handset.
- ♦ Dialed Call logs calls placed from the handset.
- ♦ Delete Call deletes records in a log or all logs.

To select an item from the Call Register sub-menu:



1. Select the Call Register menu from the User Menu.
2. Use the **Navigation** () button to highlight a selection.
3. Press the **OK** () left soft button to access the sub-menu.

Options for each of the logs (Missed, Received and Dialed) include view details, save to the Phonebook, return call and delete the record.

To access options for a log:





1. Select the Call Register menu from the User Menu.
2. Select the desired call log (Missed, Received or Dialed).
3. Press the **Option** () left soft button to display the log Options.
4. Use the **Navigation** () button to highlight a selection.
 - ♦ Details: shows caller id (number) and time of call.
 - ♦ Save to Phbk: stores the number as a record in the Phonebook, requires name entry.

GDC-480H Wireless Handset User Guide

- ♦ Delete: deletes record.
 - ♦ Call: calls number.
5. Press the **OK** () left soft button to access the sub-menu.
 6. Press the **End** () button.

Options under the delete selection allow you to delete all records in a specific call log or all records in all the logs.

To delete records in a log or all logs:







1. Select the Call Register menu from the User Menu.
2. Select the Delete sub-menu.
3. Press the **Option** () left soft button to display the log Options.
4. Use the **Navigation** () button to highlight a selection.
 - ♦ Missed calls
 - ♦ Received calls
 - ♦ Dialed calls
 - ♦ All Calls
5. Press the **OK** () left soft button to select the log.
6. Press the **OK** () left soft button again to delete the records.
7. Press the **End** () button.

5.2 Display

The Display allows the images, the backlight and dialed digit color to be adjusted. The backlight can be adjusted to standard, always on, always off or sleep mode. In Sleep mode the back-light is set to standard (back light turns OFF 20 seconds after the last button press) and turns the phone OFF after one minute after the backlight. The dialing color can be set to Yes, which varies the color of each digit, or No, which uses the same color for all digits dialed.



- ♦ Images : Support 3 images (Blank, Wallpaper1, and Wallpaper2)
- ♦ Lighting Set : Able to set up the back light
- ♦ Dialing Color : Able to set the color each digit

To adjust any of the Display characteristics:

1. Select the Menu to move to Display menu.
2. Use the **Navigation** () button to highlight the Display selection.
3. Press the **OK** () left soft button to access the sub-menu.
4. Use the left or right arrow of the **Navigation** () button to select the display characteristic.
 - Images
 - Lighting Set
 - Dialing color
5. Press the **OK** () left soft button to store the setting.
6. For dialing color use the left or right arrow of the **Navigation** () button to select **Yes** () , left soft button, or **No** () , right soft button.

For back-lighting, use the **Navigation** () button to select the desired option.

- Standard, back light turns Off 20 seconds after last button press.
- Always On, back light is always ON.

- Always Off, back light is always OFF.
 - Sleep Mode, back light turns OFF 20 seconds after last button press backlight and handset turns OFF after 1 minute.
7. Press the **OK** () left soft button to store the setting.
 8. Press the **End** () button.

Note:





To conserve battery charge, use the Standard or Sleep backlighting mode. At low battery levels (less than two bars), the backlight turns OFF until the handset batteries are recharged.

5.3 Sound



In the Sound sub-menu you can select the ring tone or melody for internal and external calls as well as the ringer volume level. Also, the alerting mode can be set with the Ringing Mode selection under this sub-menu. Under the Sound sub-menu are 4 selections:

- ♦ Internal Ring: Select the ring type (9 kinds) and the volume level from 1 to 9.
- ♦ External Ring: Select the ring type (9 kinds) and the volume level from 1 to 9.
- ♦ Ringing Mode: Select the Ring mode type (4 kinds)
- ♦ Silent In Charger: No sound and Flash LED when the handset is charging on charger.



To set the internal or external ring options:

1. Select the Sound menu from the User Menu.
2. Press the **OK** () left soft button.
3. Use the **Navigation** () button to highlight a selection.
 - ♦ Internal Ring
 - ♦ External Ring
4. Press the **OK** () left soft button to access the Internal and External Ring Options.
5. Use the **Navigation** () button to highlight a selection.
 - ♦ Ringing Type
 - ♦ Volume
6. Press the **OK** () left soft button to access the sub-menu.

For Ringing Type:

1. Use the left or right arrows on the **Navigation** () button to select the ringing type.
2. Press the **OK** () left soft button to confirm the selection.
3. Press the **End** () button.





For Volume:

1. Use the left or right arrows on the **Navigation** () button to select the ringing type.
2. Press the **OK** () left soft button to confirm the selection.
3. Press the **End** () button.

GDC-480H Wireless Handset User Guide

In the Ringing Mode sub-menu you select the alerting mode of the handset. The mode can be set to provide audible ring, vibrate combinations of ring and vibrate or visual (ring LED flashes) only.

To set the Ringing Mode:

1. Select the Sound menu from the User Menu.
2. Use the **Navigation** () button to highlight Ringing Mode.
3. Press the **OK** () left soft button to access the sub-menu.
4. Use the left and right arrows on the **Navigation** () button to select an option as below.
 - ♦ By Ring audible ring and LED flashes
 - ♦ No Sound LED flashes only
 - ♦ By Vibrator handset vibrates and LED flashes, no audible ring
 - ♦ Ring and Vib audible ring, vibrate and LED flash simultaneously
 - ♦ Ring after Vib handset vibrates for 10 seconds then audible ring, LED flashes
5. Press the **OK** () left soft button to confirm the selection.
6. Press the **End** () button.

Note:

You can quickly set the Silent (Vibrate) alert mode with the *Silent Alert button () .

5.4 Phonebook

The GDC-480H incorporates a Phonebook that stores up to 100 contact records and each record has a name and phone number. The name can be up to 14 digits in length (characters and numbers). From the Phonebook, menu records can be searched, called, added, modified or deleted.

When a call is received from a contact in the Phonebook, the name associated with the number is displayed.



There are several methods to access the Phonebook menu based on the state of the phone, idle or busy.

To access the Phonebook menu:

While idle—

1. Press the **Names** () right soft button,
OR
1. Press the Down arrow on the Navigation button.



While in Talk mode—

1. Press the **Options** () left soft button; this displays the Options menu.
2. Use the **Navigation** () to highlight the Phonebook selection and press the **OK** () left soft button.



5.4.1 Dialing from Phonebook

Records in the Phonebook can be searched and a number can be dialed.



To dial a number from the Phonebook:

1. Access the Phonebook menu as described above.
2. Use the **Navigation** () to highlight the Find selection and press the **OK** () left soft button; the “Enter Name” prompt is displayed.

Search the records:









1. Enter the first few characters of the name using the dial pad (refer to Appendix Dial Pad Character Charts). As an example, press 5 twice for ‘k’ and 3 twice for ‘e’ to search for Kenny.
2. Press the **Find** () left soft button to display the matching record.
3. When the record is found, press the **Call** () right soft button to dial the number.

Or

3. Press the **Find** () left soft button to search all records.
4. Use the Up and Down arrows on the **Navigation** () to highlight the desired record.
5. When the record is found, press the **Call** () right soft button to dial the number.



5.4.2 Adding Records to the Phonebook

To add a record to the Phonebook:



1. Access the Phonebook menu as described above.
2. Use the **Navigation** () to highlight the Add Entry selection and press the **OK** () left soft button.
3. Enter the each character of the name using the dial pad. Up to 14 characters (including numbers) may be entered. See the charts in the Appendix Dial pad Character Charts. If you enter the wrong character use the **Delete** () right soft button to delete a character. And press **OK** () soft button.
4. Enter the phone number for the record using the dial pad and press the **OK** () left soft button.
5. Select whether or not to use the CO Access code (refer to Edit CO Code) and press the **OK** () left soft button. Selecting the CO Access Code will insert the access code in front of the number during dialing. The CO Access codes are entered in the Phone Settings menu discussed later in this guide.
6. “Enter Position” and record number are displayed.
 - To save with displayed record number, press **OK** () left soft button.
 - To modify the record number, press Modify soft button and enter the record number, 1 ~ 60, using the dial pad and press the **OK** () left soft button. This will store the number as the record entered.

5.4.3 Modifying Records in the Phonebook





To modify a Phonebook record:

1. Access the Phonebook menu as described above.
2. Use the **Navigation** () to highlight the Modify selection and press the **OK** () left soft button.

Case 1:





3. Enter the first few characters of the name using the dial pad (See the charts in the Appendix Dial pad Character Charts). As an example, press 5 twice for 'k' and 3 twice for 'e' to search for Kenny.
4. Press the **Find** () left soft button to display the matching record.
5. When the record is found, press **OK** () left soft button.

Case 2:



3. Press the **Find** () left soft button to search all records
4. Use the Up and Down arrows on the **Navigation** () to highlight the desired record.
5. When the record is found, press **OK** () left soft button.
6. Modify the Name, telephone number, CO access code use and the record number as detailed in the "Adding Records to the Phonebook" section.
7. After modifying the record, press the **OK** () left soft button to store the modifications.

5.4.4 Deleting records from the Phonebook





To delete a record from the Phonebook:

1. Access the Phonebook menu as described above.
2. Use the **Navigation** () to highlight the Delete selection and press the **OK** () left soft button.
3. Use the **Navigation** () to highlight the {Delete One} selection and press the **OK** () left soft button.



Case 1:



4. Enter the first few characters of the name using the dial pad (See the charts in the Appendix Dial pad Character Charts). As an example, press 5 twice for 'k' and 3 twice for 'e' to search for Kenny.
5. Press the **Find** () left soft button to display the matching record.
6. When the record is found, press **Delete** () left soft button.
7. When "Delete One Phonebook?" is displayed, press **Delete** () left soft button.

Case 2:

4. Press the **Find** () left soft button to search all records
5. Use the Up and Down arrows on the **Navigation** () to highlight the desired record.
6. When the record is found, press **Delete** () left soft button.
7. When "Delete One Phonebook?" is displayed, press **Delete** () left soft button.







To delete all record from the Phonebook:

1. Access the Phonebook menu as described above.
2. Use the **Navigation** () to highlight the {Delete} selection and press the **OK** () left soft button.

3. Use the **Navigation** () to highlight the {Delete All} selection and press the **OK** () left soft button.
4. When “Delete Entire Phone Book?” is displayed, press **OK** () left soft button.

5.4.5 Searching the Phonebook with Find

To search the Phonebook for a record:

1. Access the Phonebook menu as described above.
2. Use the **Navigation** () to highlight the Find selection and press the **OK** () left soft button. This will display the Find Record menu below:
 - ♦ View
 - ♦ Modify
 - ♦ Delete
3. Search the Records by—
 - a. Enter the first few characters of the name using the dial pad. See the charts in the Appendix Dial pad Character Charts. As an example, press 5 twice for ‘k’ and 3 twice for ‘e’ to search for kenny.
 - b. Press the **Find** () left soft button to display matching records.
4. When the record is found, press the **Call** () right soft button to dial the number.
Or,
4. Press the **Find** () left soft button to search all records.
5. Use the Up and Down arrows on the **Navigation** () to highlight the desired record.
6. When the desired record is located, use the directions under “Modifying Records in the Phonebook” or “Deleting Records from the Phonebook sections.

5.4.6 Phonebook Upload/Download with PC

To download the phonebook

Execute the Phonebook.exe and then see the display image below.

→If you can't execute it or display the strange message, then please install the file included in the package.

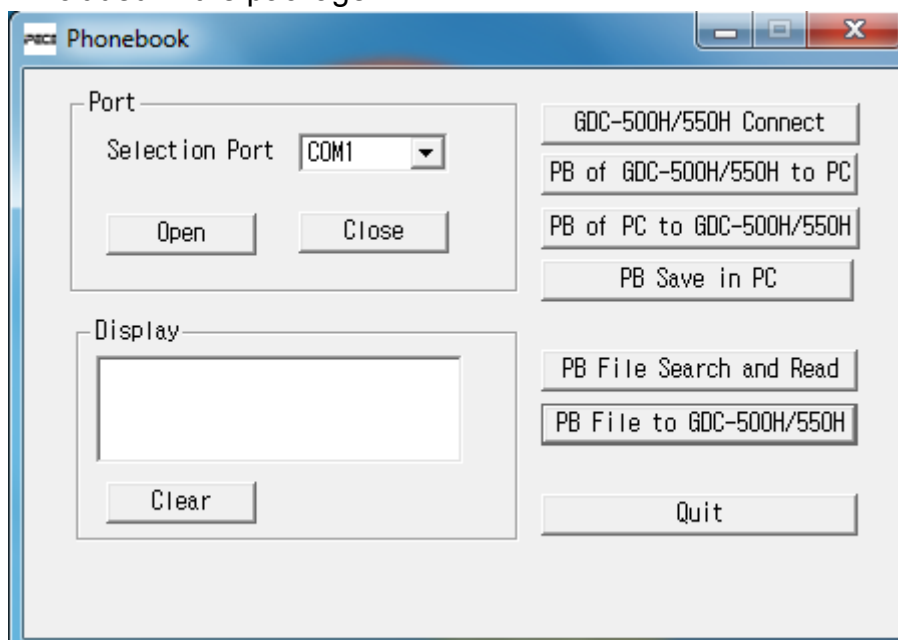

GDC-480H Wireless Handset User Guide

To explain each item in the phonebook upload and download menu.

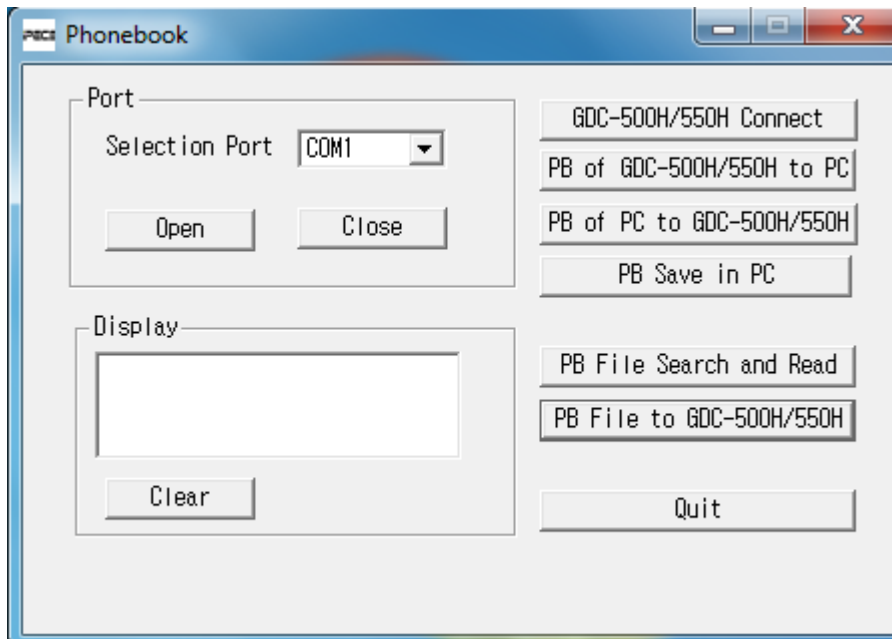

- Open: Open port.
- Close: Close port.
- GDC-480H Connect: connect to the terminal with PC.
- PB of GDC-480H to PC: read the phonebook from the terminal.
- PB of PC to GDC-480H: write the phonebook to PC internal
- PB Save in PC: save the Phonebook in PC (save the file)
- PB File Search and Read: Read the file in PC
- PB File to GDC-480H: write the phonebook to the terminal.
- Clear: clear the display
- Quit: exit the phonebook updownload

To write the other terminal for the contents of current terminal phonebook by PC

1. Select the current terminal.
2. Select the port using “Selection Port” button, and display the “Com Port change: #” in the display screen.
3. Select the “Open” button, and display the “Open Port: #” message in the display screen.
4. Select the “GDC-480H Connect” button, and display the “Connected” message in the display screen.
5. Select the “PB of GDC-480H to PC” button, and display the “...” progress status in the display screen.
 - After the upload is completed, display the “Upload Complete” message.
3. Select the other (new) terminal.
4. Select the “GDC-480H Connect” button and display the “Connected” message in the display screen.
 - Port is already opened, and press the GDC-480H Connect button only.
3. Select the “PB of PC to GDC-480H”, and display the “...” progress status in the display screen.
 - After the download is completed, display the “Download Complete” message and reboot the terminal.
 - During the downloading PB, can't receive the call.

GDC-480H Wireless Handset

User Guide

- If the PB is read from terminal and write it to the other one, should be clear using “Clear” button.
- otherwise, accumulate the PB contents and write the PB to other terminal.
- If the port number is larger than 10, then please change it between 1 and 10.

To read the PB contents of terminal and store it in PC

1. Select the current terminal.
2. Select the port using “Selection Port” button. and display the “Com Port change: #” in the display screen.
3. Select the “Open” button, and display the “Open Port: #” message in the display screen.
4. Select the “GDC-480H Connect” button, and display the “Connected” message in the display screen.
5. Select the “PB of GDC-480H to PC” button, and display the “...” progress status in the display screen.
→ After the upload is completed, display the “Upload Complete” message.
6. Select the “PB Save in PC” button.
7. Select the file name or write it, and save the file. (*.csv)
→ After PB is saved in PC, display the “PB save complete” message.

To write the terminal for the contents of the file

1. Select the PB file Search and Read and the file and display the “....” progress message in the display screen.
→ After the file upload is completed, display the “PB Read Complete” message in the display screen.
2. Select the terminal.
3. Select the port using “Selection Port” button.
4. and display the “Com Port change: #” in the display screen.
5. Select the “Open” button, and display the “Open Port: #” message in the display screen.
6. Select the “GDC-480H Connect” button, and display the “Connected” message in the display screen.
7. Select the PB file to GDC-480H button, and display the “...” progress status in the display screen.
→ After the download is completed, display the “Download Complete” message and reboot the terminal.

To display the contents of the file.

[View Excel File (.CSV)]

(1) (2) (3) (4) (5)

0	1	Gildong Hong	3354343334	0
1	0	Intaek Lim	12345567889	0
2	2	Xxxx Xxx	4947837373	0

[View Text CSV file]

(1) (2) (3) (4) (5)

00,01,Gildong Hong,3354343334,0
 01,00,Intaek Lim,12345567889,0
 02,02,Xxxx Xxx,4947837373,0

GDC-480H Wireless Handset User Guide

- (1) Index: 0 ~ 99
- (2) PB Index: Stored phonebook index
- (3) Name
- (4) Tel number
- (5) Cocode: CO Access code use or not in phonebook.

To edit the contents of the file.

1. There is a limit in each item
(0 ≤ Index ≤ 99, 0 ≤ PB index ≤ 99, name ≤ 14 bytes(include space), Number ≤ 24 digits, Cocode: 0 or 1)
2. If you use the excel application for edition, you should store the content with the text format. Otherwise, phonebook can't be read or can be stored abnormally.
3. If you use the text application for edition, you should store the text with the enter in the last items.
4. Blank should not be included in the number item. (Can't call the number)

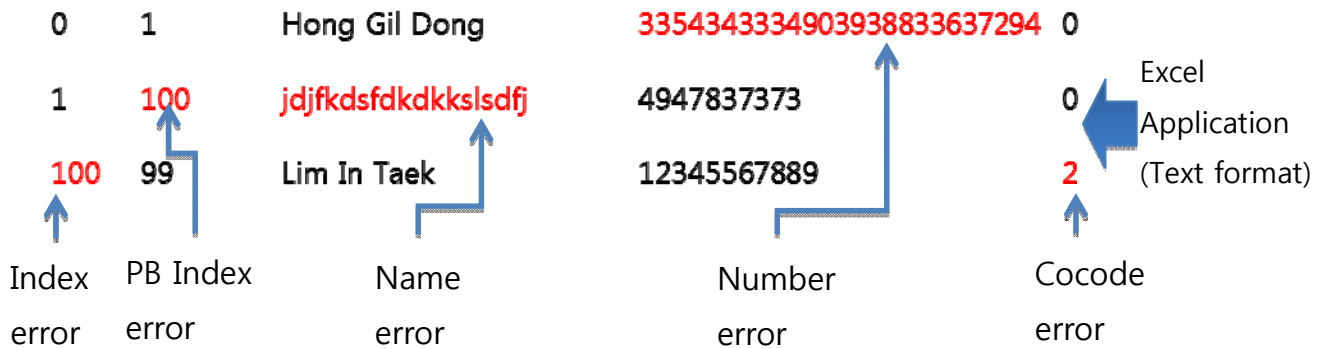

```
00,01,Gildong Hong,3354343334,0
01,00,Intaek Lim,12345567889,0
02,02,Xxxx Xxx,4947837373,0
```

Text Application (Notepad)



5.5 Bluetooth only for GDC-

GDC- supports a Bluetooth allowing you to use a wireless headset. So you can move freely around the Handset and maintain a conversation. Before using the headset, the headset must be "paired" with the Handset, and then the headset must be enabled for use.



Note:

During the pairing operation, the headset and Handset should be as close as possible but not more than 1 meter apart.





Before searching a headset, the Bluetooth of GDC- must be activated by following the below operation since the default is not activated.

1. Select the Bluetooth menu from the User Menu.
2. Use the **Navigation** () button to highlight the Bluetooth selection.
3. Press the **OK** () left soft button to access the sub-menu.





GDC-480H Wireless Handset User Guide

4. Use the Up or Down arrow of the **Navigation** () button to select the Activation.
5. Use the Left or Right arrow of the **Navigation** () button to select Yes.
6. Press the **OK** () left soft button to activate the Bluetooth of GDC-.

To pair the wireless headset to the Handset:

1. Select the Bluetooth menu from the User Menu.
2. Use the **Navigation** () button to highlight the Bluetooth selection.
3. Press the **OK** () left soft button to access the sub-menu.
4. Use the Up or Down arrow of the **Navigation** () button to select Device Scanning.
5. Press the **OK** () left soft button to search the available headset. The message 'Not Found' is displayed if it failed.
6. The available headsets are displayed and select one. Press the **OK** () left soft button to connect the headset.
7. The 'Pairing done' message is displayed if it is successful.

To show the status of the headset, delete it, and connect it again:

1. Select the Bluetooth menu from the User Menu.
2. Use the **Navigation** () button to highlight the Bluetooth selection.
3. Press the **OK** () left soft button to access the sub-menu.
4. Use the Up or Down arrow of the **Navigation** () button to select Paired Device.
5. Press the **Option** () left soft button to set up the below items.
 - ♦ View : Show information of the headset such as Name and Mac address
 - ♦ Delete : Delete the open list
 - ♦ Connection : connect the headset
6. After finishing the above option, press the End () button.

Note:

GDC- supports Bluetooth version 2.1 EDR.

Depending on the wireless environment or property of paired headset, the paired headset may not be connected automatically. In this case, please try to manually connect.

Response time about the button action of paired headset is depending on the property of paired headset.

5.6 Phone Settings

Under the Phone Settings menu are various sub-menus associated with characteristics of the handset. In total there are 14 items under Phone settings as below.

- ♦ Clock
- ♦ Alarm clock
- ♦ Keypad Tones
- ♦ Language
- ♦ Silent Mode
- ♦ Keypad Lock
- ♦ SW Version
- ♦ Edit CO Code
- ♦ Missed Call Mode
- ♦ Range Out beep
- ♦ Clock Display

- ◆ Auto Answer Mode
- ◆ Auto Release Mode
- ◆ Emergency Call





To select an item from the Phone Settings sub-menu:

1. Select the Phone Settings menu from the User Menu.
2. Use the **Navigation** () button to highlight a selection.
3. Press the **OK** () left soft button to access the sub-menu.

5.6.1 Clock, Date and Time display

When a host system does not provide the handset with the date and time, the handset clock display can be enabled and the date and time set. The display is enabled as outlined in the Clock Display menu section later in this guide.

To set the date and time,

1. Select the Phone Settings menu from the User Menu.
2. Use the **Navigation** () button to highlight the Clock selection.
3. Press the **OK** () left soft button to access the sub-menu.
4. Use the dial pad to enter the date as ddmmyy.
5. Press the **OK** () left soft button to accept the date.
6. Enter the time of day as xx:xx in a 24 hour format.
7. Press the **OK** () left soft button to accept the time.





Note:

If you set and enable the clock display and the host system provides time and date, when you press the **Talk** () button before dialing, the display will change to the system time and date. The Clock Display must be enabled to display the handset time.

5.6.2 Alarm Clock

The GDC-480H incorporates an Alarm Clock feature. When the handset clock reaches the alarm time, you are notified by the alarm.

To set the Alarm Clock:

1. Select the Phone Settings menu from the User Menu.
2. Use the **Navigation** () button to highlight the Alarm Clock selection.
3. Press the **OK** () left soft button to access the sub-menu.
4. Use the left or right arrow of the **Navigation** () button to set or cancel the alarm.
5. If you wish to set the Alarm, enter the time of day as hh:mm in a 24 hour format.
6. Press the **OK** () left soft button to accept the time.
7. Press the **End** () button.





Note:

The Alarm Clock employs the handset clock to determine the time. Assure the handset clock is set properly when using this feature. It is not required to display the handset time but, it must be set properly for the Alarm clock to work as expected. The Alarm clock will remain set and repeat on a daily basis (or cancel, as needed).

5.6.3 Keypad Tones

When a button on the handset is pressed a “keypad tone” is generated. This tone can be enabled or disabled through the Keypad tone selection under the Phone Setting menu.





To enable or disable the Keypad tone:

1. Select the Phone Settings menu from the User Menu.
2. Use the **Navigation** () button to highlight the Keypad Tone selection.
3. Press the **OK** () left soft button to access the sub-menu.
4. Use the left or right arrow of the **Navigation** () button to select Yes or No.
5. Press the **OK** () left soft button to store the setting.
6. Press the **End** () button.

5.6.4 Language

The GDC-480H supports multiple languages; you can select one of 7 languages for use in the display of handset messages.

To select a language:

1. Select the Phone Settings menu from the User Menu.
2. Use the **Navigation** () button to highlight the Language selection.
3. Press the **OK** () left soft button to access the sub-menu.
4. Use the left or right arrow of the **Navigation** () button to select a language:
 - ♦ English
 - ♦ Italian
 - ♦ Spanish
 - ♦ Russian
 - ♦ Swedish
 - ♦ Turkey
 - ♦ Deutsch
5. Press the **OK** () left soft button to store the language selection.
6. Press the **End** () button.







Note:

The selected language is used only for handset messages; messages sent to the handset by the host system are displayed in the system language.

5.6.5 Silent Mode

You can set your phone for Silent Alerting; the display and vibration will alert you of an incoming call. Silent alert can be set in several ways from the Sound menu, using the *Silent Alert () or the Silent Mode menu.







To use the Silent mode menu to set Silent Alert:

1. Select the Phone Setting menu from the User Menu.
2. Use the **Navigation** () button to highlight the Silent Mode selection.
3. Press the **OK** () left soft button to access the sub-menu.
4. Use the **Yes** () or **No** () left or right soft button to adjust the Silent Alert setting.
5. Press the **OK** () left soft button to store the alert mode.
6. Press the **End** () button.

5.6.6 Keypad Lock

When the handset is carried in a pocket or purse, buttons may be accidentally activated causing unexpected behavior. Such accidental button presses may be circumvented by locking the handset keypad. The keypad can be locked using the #Lock () button or using the Phone Settings menu.

To use the Phone Settings menu to lock the handset buttons:

1. Select the Phone Setting menu from the User Menu.
2. Use the **Navigation** () button to highlight the Keypad Lock selection.
3. Press the **OK** () left soft button to access the sub-menu.
4. Use the **Yes** () or **No** () left or right soft button to adjust the lock or unlock the handset buttons.
5. Press the **OK** () left soft button to store the selection.
6. Press the **End** () button.



Note:

When locked, the display will show “Keypad locked”. While locked the only allowable operation is unlock. All other buttons are ignored if pressed, and calls cannot be placed.

5.6.7 SW Version

For maintenance purposes you can request the GDC-480H display the handset software version.

To display the current software version of the handset:

1. Select the Phone Setting menu from the User Menu.
2. Use the **Navigation** () button to highlight the SW Version.
3. Press the **OK** () left soft button to access the sub-menu. The SW version displays.
4. Press the **End** () button.







5.6.8 Edit CO Code

The GDC-480H can subscribe to four (4) DECT zones simultaneously. Each zone may have access to a different set of external lines with different codes. The code is used to place calls from the handset Phonebook as well as for incoming call look-up in the Phonebook. If

GDC-480H Wireless Handset User Guide

desired, you can assign a CO access code the handset will send and receive in front of a Phonebook number for each separate zone. For proper operation of the Phonebook, your general CO line code should be used (ex., '9' or '0'). Each of the four CO access codes is assigned to each of the subscribed systems; CO Code 1 is for Base (zone) 1, CO Code 2 is for Base (zone) 2, etc. If a code is not entered, it must be entered as the first digit(s) of the telephone number in the Phonebook.





To assign a CO Code:

1. Select the Phone Settings menu from the User Menu.
2. Use the **Navigation** () button to highlight the CO Code selection.
3. Press the **OK** () left soft button to access the sub-menu.
4. Use the left or right arrow of the **Navigation** () button to select the code.
 - Code 1 – code for Zone 1
 - Code 2 – code for Zone 2
 - Code 3 – code for Zone 4
 - Code 4 – code for Zone 4
5. Press the **OK** () left soft button to select the code number.
6. Use the dial pad to enter a CO access code (may be provided by System Administrator).
7. Press the **OK** () left soft button to store the setting.
8. Press the **End** () button.

5.6.9 Missed Call Mode

The missed call log is maintained by the handset. In cases where the host system alerts multiple phones including your wireless handset and another phone answers, the handset registers a missed call. This may lead to a near constant display of "xx missed calls". You can enable or disable the display of this missed call message.

To enable or disable the missed call message;





1. Select the Phone Settings menu from the User Menu.
2. Use the **Navigation** () button to highlight the Missed Call selection.
3. Press the **OK** () left soft button to access the sub-menu.
4. Use the left or right arrow of the **Navigation** () button to select Yes or No.
5. Press the **OK** () left soft button to accept the date.
6. Press the **End** () button.

5.6.10 Range Out Beep

When out-of-range for more than 30 seconds, the phone will beep every 3 seconds. If you expect to be Out-Of-Range for an extended period you should turn the handset power OFF. If, for example, you leave the office with the handset on, the Out-Of-Range beep alerts you to turn the handset power OFF.

To disable the Out-Of-Range beep:





1. Select the Phone Setting menu from the User Menu.

2. Use the **Navigation** () button to highlight the Range Out beep selection.
3. Press the **OK** () left soft button to access the sub-menu.
4. Use the left or right arrow of the **Navigation** () button to select Yes or No.
5. Press the **OK** () left soft button to accept the selection.
6. Press the **End** () button.

5.6.11 Clock Display



When a host system does not provide the handset with the date and time, the handset clock display can be enabled and the date and time set. The display can be enabled as outlined below and the time and date are set as outline in the Clock, Date and Time Display section earlier in this guide.

To enable or disable use of the handset date and time:

1. Select the Phone Settings menu from the User Menu.
2. Use the **Navigation** () button to highlight the Clock Display selection.
3. Press the **OK** () left soft button to access the sub-menu.
4. Use the left or right arrow of the **Navigation** () button to select Yes or No.
5. Press the **OK** () left soft button to accept the date.
6. Press the **End** () button.

Note:





If you set and enable the clock display and the host system provides time and date, when you press the **Talk** () button before dialing, the display will change to the system time and date. The handset date and time must be adjusted as outlined in the Clock, Date and Time Display Section.

After changing the Clock Display, you must press the **Talk** () and **End** () buttons to activate the display.

5.6.12 Auto Answer Mode

You can select your phone to activate/deactivate Auto answer mode when lifting your phone from the charger after incoming call alerting.





To enable or disable use of the handset auto answer:

1. Select the Phone Setting menu from the User Menu.
2. Use the **Navigation** () button to highlight the Auto Answer Mode selection.
3. Press the **OK** () left soft button to access the sub-menu.
4. Use the left or right arrow of the **Navigation** () button to select Yes or No.
5. Press the **OK** () left soft button to accept it.
6. Press the **End** () button.

5.6.13 Auto Release Mode

The Auto Release Mode allows you to disconnect a call automatically during a conversation by putting the handset into charger. The default is ON.





To enable or disable Auto Release Mode:

1. Select the Phone Settings menu from the User Menu.
2. Use the **Navigation** () button to highlight the Auto Release Mode selection.
3. Press the **OK** () left soft button to access the sub-menu.
4. Use the left or right arrow of the **Navigation** () button to select Yes or No.
5. Press the **OK** () left soft button to accept it.
6. Press the **End** () button.

5.6.14 Emergency Call





In emergency situations you can connect the designation number by pressing Emergency button at the upper side of handset. The change of the designation number is available and the default is Off.

To enable or disable Emergency call:

1. Select the Phone Settings menu from the User Menu.
2. Use the **Navigation** () button to highlight the Emergency Call selection.
3. Press the **OK** () left soft button to access the sub-menu.
4. Use the left or right arrow of the **Navigation** () button to select Yes or No.
5. Press the **OK** () left soft button to accept it.
6. Press the **End** () button.



5.6.15 Block Dialed Call



From the User Menu, select the Phone Register menu.

1. Use the **Navigation** () button to highlight a selection.
2. Press the **OK** () left soft button; PIN request will display.
3. Use the dial pad to enter your PIN.
4. Use the left or right arrow of the **Navigation** () button to select Yes or No.
5. Press the **OK** () left soft button to accept it.
6. Press the **End** () button.

5.7 Phone Register

To register a new wireless terminal to your base or to register a wireless terminal again after base reset (refer to the [Section Reset](#)).











1. Press the **Menu** () button to display the User menu.
2. From the User Menu use the **Navigation** () button to highlight Phone Register.
3. Press the **OK** () left soft button. This displays the Phone Register menu.
 - ♦ Subscription
 - ♦ Base Choice
 - ♦ Modify PIN

- ♦ Base ID
 - ♦ Reset
4. From the Phone Register menu select “Subscription” using the up and down arrows of the **Navigation** () button and press the **OK** () button.
 5. Select an available BASE station number and press **OK** () button. The GDC-480H searches for the system, displaying and “Searching..x”. When a system is found, the corresponding Radio Fixed Part Identification (RFPI) is displayed (verify the RFPI with the System Administrator or Attendant).

5.7.1 Subscription

In order to obtain services from a base station or zone, the handset must establish a subscription with the zone. The handset may subscribe to four (4) base stations or zones simultaneously. When subscribing to the system you will need the RFPI and Authorization code, which may be available from your System Administrator. Also, before starting the subscription process make sure you are in range of the desired zone and the Received Signal Strength Indicator (RSSI) indicator is steady, showing at least 2 bars.

To subscribe to a system, from the GDC-480H:

1. Verify that press the **Menu** () button to display the menu.
2. From the menu, use the **Navigation** () button to highlight Phone Register.
3. Press the **OK** () left soft button to display the Phone Register menu.
4. Select “Subscription” using the up and down arrows of the **Navigation** () button and press the **OK** () button.
5. Select an available BASE number (up to 4) and press the **OK** () button; the GDC-480H searches for the system and displays “Searching..x”. When a system is found, its RFPI is displayed (verify with your System Administrator, or the Attendant).
6. Press the **OK** () button to subscribe to the system (RFPI shown). Press No () button to continue searching.
7. Enter the Authorization code (available from the System Administrator, as needed).
8. Press the **OK** () button; confirmation tone will be heard is received at the GDC-480H and the Attendant’s LCD will display “Subscription Done”.
9. Press the **End** () button.

If the subscription fails, repeat above Steps 3 - 6 from the Attendant Station, and Steps 1 - 8 from the GDC-480H.



Note

According to the system or radio channel environment, the system or the wireless terminal periodically may not recognize that the system has the subscribed wireless terminal or the wireless terminal is subscribed to the system. Once a user has performed the subscription procedure, try to make a call first. Then, if a user can’t make a call, try to subscribe the wireless terminal again after verifying the terminal is unsubscribed (described in the following chapter). It is recommended all other DECT systems be disabled while performing the Subscription procedure.

5.7.2 Base Choice

While the handset may subscribe to four zones simultaneously, the handset can only be active in one. You may select the active Base station to control the zone in use. If not already registered to the base, you can subscribe for services from the zone.





To change the active zone:

1. From the User Menu, select the Phone Register menu.
2. Select Base Choice from the Phone register menu.
3. Use the up down arrows on the **Navigation** () button to select a Base (1 ~ 4) or Best Choice.
4. Press the **OK** () left soft button. This handset searches for the selected zone and displays "Searching x"; when located, the idle mode display is shown and services are available.
5. Once the base is found, it is an active base.

5.7.3 Modify PIN

The Handset PIN (Authorization code) can be changed (default=0000).

To change the HS PIN:

1. From the User Menu, select the Phone Register menu.
2. Select Modify PIN from the Phone register menu.
3. Press the **OK** () left soft button.
4. Use the dial pad to input the current HS PIN.
5. Press the **OK** () left soft button.
6. Use the dial pad to input the new HS PIN.
7. Press the **OK** () left soft button.
8. Use the dial pad to input the new HS PIN again, and press the **OK** () left soft button.
9. Press the **End** () button.

5.7.4 Base ID

For information purposes, the handset can display the active zone.





To display the active zone:

1. From the User Menu, select the Phone Register menu.
2. Select Base ID from the Phone register menu, the active zone is displayed.
3. Press the **End** () button.

5.7.5 Reset

With the Reset sub-menu you can clear the Phonebook, Phone Settings or the handset settings. Selecting Handset Setting clears the Phonebook, Phone Settings, Call Logs, Direct Call number and all active subscriptions.









To use the Reset sub-menu:

1. From the User Menu, select the Phone Register menu.
2. Select Reset from the Phone register menu. The Reset sub-menu is displayed.
 - ♦ Phonebook – clears the Phonebook and Direct Call number.
 - ♦ Settings (Phone Settings) – returns Phone Settings and Handset PIN to default values.
 - ♦ Handset – clears the Phonebook, call logs, active subscriptions and the Direct Call number and resets the Phone Settings.
3. Use the **Navigation** () button to highlight a selection.
4. Press the **OK** () left soft button; PIN request will display.
5. Use the dial pad to enter your PIN.
6. Press the **OK** () left soft button; the selected reset is implemented.
7. Press the **End** () button.

5.8 Appointment

Your GDC-480H Wireless handset has an Appointment Reminder feature. When set, the handset will remind you of an Appointment with a display of the appointment text and an appointment alert (alarm sound) or vibration alert (if in silent mode). In addition to the time, you can enter the appointment text and set the appointment as daily, monthly or annual.



To set an appointment reminder:

1. Select the Appointment menu from the User Menu.
2. Press the **Set** () left soft button, the Interval menu appears.
 - ♦ Daily
 - ♦ Monthly
 - ♦ Annual
3. Use the **Navigation** () button to highlight a selection.
4. Press the **OK** () left soft button to access the sub-menu.
5. Use the dial pad to enter.
 - ♦ For daily, enter the time of day as hh:mm in a 24 hour format.
 - ♦ For monthly enter the day and time as DD:hh:mm with 2 digits for the day.
 - ♦ For annual, enter the day, month, and time as DD:MM:hh:mm with 2 digits for the month.
6. Press the **OK** () left soft button to store the appointment.
7. If desired use the dial pad and Character Chart in the Appendix to enter a 12-character reminder message.
8. Press the **OK** () left soft button to store the appointment.
9. Enable or disable the appointment with the **Enable** or **Disable** () or () left or right soft button.
10. Press the **End** () button.

Once an appointment is set, you can modify the time. When you select the Appointment menu, you can select from the sub-menu to view, modify or delete the appointment.

To view, modify or delete an appointment:





1. Select the Appointment menu from the User Menu.
2. Use the **Navigation** () button to highlight a selection.
 - ♦ Modify Date

- ♦ Modify time
 - ♦ Delete
 - ♦ View Text
3. Press the **OK** () left soft button to access the sub-menu.
 4. Use the dial pad to enter the date or time.
 5. Press the **OK** () left soft button to store new date and time.
 6. Press the **End** () button.



5.9 Direct Call

The GDC-480H can be configured to dial a specific number when any button on the handset is pushed. The Direct Call or Hotline number can be enabled and the number to call specified. The direct call (emergency) number is transmitted on input from any key. This feature may be used in cases where the User is not able to effectively dial a phone number, and would need direct access for assistance from the Attendant or another party.

To enable Direct Call and input a number,

1. From the User Menu use the **Navigation** () button to highlight Direct Call.
2. Press the **OK** () left soft button.
3. Use the **Navigation** () button to select Yes or No and press the **OK** () button.
4. If you select Yes, enter the Direct Call number and press the **OK** () button.

6 Troubleshooting

Problem	Possible Cause	Solution
LCD is blank	No power	Assure batteries are properly installed and charged. Press and hold the EndPower button for 1 second.
“NO CHANNEL” displayed when TALK button pressed	All DECT channels are in use.	Wait until a channel is available.
Low or high audio volume	Volume needs adjusting	While connected to a call, press Up or Down arrow on the Navigation button.
Low or high ringer volume	Volume needs adjusting	Adjust Ringer volume level; refer to Sound Section.
“UNREGISTERED” displayed in the LCD	No active subscription	Subscribe the handset, refer to subscribing GDC-480H to a System.
Low battery icon () is flashing on LCD with warning tone	Battery level is low	Recharge the battery.
Power-OFF right after power-ON	Battery level is below operational state.	Recharge the battery.
Tone is low or high when pressing a digit	Insufficient RF from base station, no RF-lock to base station.	Move to obtain higher RSSI; wait for RF-lock to base station.
	Keypad tones are disabled or tones volume needs adjusting.	Use Up and down arrow on Navigation button to adjust volume. Check Keypad Tones are enabled/disabled in the User Menu.
Unexpected call disconnect or call failure	Poor RF environment.	RF can change over time, move to obtain higher RSSI.
Battery duration is less than specified	Batteries failing and/or poor battery charging habits	Charge batteries and keep handset in cradle when not in use; refer to Installing the Batteries Section.
Subscription fails	Interference from other DECT system. Too far from Base station, no available channel or wrong Base station (RFPI) or Auth code selected.	Turn other DECT systems Off. Assure handset is in range of base station. Assure RFPI and AC are correct. Wait for an available wireless channel.
When pressing TALK button, the Phone icon () blinks several times and disappears	Subscription error	Terminate the subscription and re-subscribe.
When pressing TALK button, nothing happens	Out-of-range	Assure the handset is locked to a Base station and RSSI is at least two (2) bars.

7 Specifications

- ❑ Standard DECTGAP
- ❑ Frequency band 1920~1930MHz
- ❑ RF Modulation GSKF
- ❑ Range from Base Station to Handset Maximum=200 meters, Typical=70 meters

GDC-480H Wireless DECT Handset

Item	Specification
Size:	157mm x52.6mm x 19mm (HxWxD)
Weight:	136 grams
Color:	Dark
Maximum power:	250 mW
Battery Life:	
Talking Mode—	12 hours
Standby Mode—	80 hours
Charge Time—	9 hours
Type—	DC 3.7V1150mAh (Li-ion)
Programmable Ring Type:	Internal, External ring: each 9 kind
Display feature:	
Icon—	10
Type—	LCD, 65K color TFT
Dialing mode:	DTMF
Phonebook:	60 Names & numbers
Speed dial numbers:	Local: Phonebook: 60 numbers System: Refer to System manuals
Re-dial numbers:	Local: Last 10 numbers
Operating temperature:	0 ~ +40°C

GDC-480H Charger-Base

Item	Specification
Size	80mm × 80mm × 65mm(L×W×D)
Weight:	80 grams
Color:	Dark gray
Mounting:	Desk mount
Charging port:	1
Operating temperature:	0 ~ +40°C
Input power:	From Output Power Adaptor
ACDC Adaptor	AC 100V~240V 5060Hz 0.2A input DC 5.1V 700mA 3.57VA output
Charging current:	Nominal 300mA
Indication:	RedGreen color LED

8 Dial pad Character Charts

The integrated GDC-480H Phonebook permits names to be associated with a Phonebook record. The following charts provide the correlation between the dial pad digits and characters. Charts are available for English, Italian, Spanish and Russian. To insert a character, each dial pad button is pressed one or more times to select the desired character.

English Language Character Chart

Dial Pad button	Button depressions									
	1	2	3	4	5	6	7	8	9	10
1	@	:		<	>	()	1		
2	a	b	c	2	A	B	C			
3	d	e	f	3	D	E	F			
4	g	h	i	4	G	H	I			
5	j	k	l	5	J	K	L			
6	m	n	o	6	M	N	O			
7	p	q	r	s	7	P	Q	R	S	
8	t	u	v	8	T	U	V			
9	w	x	y	Z	9	W	X	Y	Z	
0	&	\$.	,	?	!	%	0		
*	*	-								
#	#		+	-						

Italian Language Character Chart

Dial Pad button	Button depressions									
	1	2	3	4	5	6	7	8	9	10
1	@	:		<	>	()	1		
2	a	b	c	2	A	B	C	á		
3	d	e	f	3	D	E	F	è		
4	g	h	i	4	G	H	I	ì		
5	j	k	l	5	J	K	L			
6	m	n	o	6	M	N	O	ò		
7	p	q	r	s	7	P	Q	R	S	
8	t	u	v	8	T	U	V	ù		
9	w	x	y	Z	9	W	X	Y	Z	
0		-	.	,	?	!	%	0		
*	*	€	\$							
#	#	&	+	-						

Spanish Language Character Chart

Dial Pad button	Button depressions									
	1	2	3	4	5	6	7	8	9	10
1	@	:		<	>	()	1		
2	a	b	c	2	A	B	C	á	à	
3	d	e	f	3	D	E	F	é	è	
4	g	h	i	4	G	H	I	í	ì	
5	j	k	l	5	J	K	L	Ç		
6	m	n	o	6	M	N	O	ñ	ó	ò
7	p	q	r	s	7	P	Q	R	S	
8	t	u	v	8	T	U	V	ú	ù	
9	w	x	y	Z	9	W	X	Y	Z	
0	.	,	?	!	%	0				
*	_	*	€	\$						
#		#	&	+	-					

Russian Language Character Chart

Dial Pad button	Button depressions									
	1	2	3	4	5	6	7	8	9	10
1	@	:		<	>	()	1		
2	α	σ	в	г	A	Б	В	Г		
3	д	е	ё	ж	з	Д	Е	Ё	Ж	З
4	и	й	к	л	И	Й	К	Л		
5	м	н	о	п	М	Н	О	П		
6	р	с	т	у	Р	С	Т	У		
7	ф	х	ц	ч	Ф	Х	Ц	Ч		
8	ш	щ	ъ	ы	Ш	Щ	Ъ	Ы		
9	ь	э	ю	ь	Э	Ю	Я			
0	&	\$.	,	?	!	%	0		
*	*	_								
#	#		+	-						

9 GDC-480H User Menu

