

Regulatory and Safety Information

Please save these instructions and read carefully

USA-FCC (Federal Communications Commission) Statement

This device complies with Part 15 of the FCC Rules. Operation is subject to the following two conditions:

- 1 This device may not cause harmful interference, and
- 2 This device must accept any interference received, including interference that may cause undesired operation.

FCC Interference Statement

Note: This equipment has been tested and found to comply with the limits for a Class B Device, pursuant to Part 15 of the FCC Rules. These limits are designed to provide reasonable protection against harmful interference in a residential installation. This equipment generates, uses and can radiate radio frequency and, if not installed and used in accordance with the instructions, may cause harmful interference to radio communications. However, there is no guarantee that interference will not occur in a particular installation. If this equipment does cause harmful interference to radio or television reception, which can be determined by turning the equipment off and on, the user is encouraged to try to correct the interference by one or more of the following measures:

- 1 Reorient or relocate the receiving antenna.
- 2 Increase the separation between the equipment and receiver.
- 3 Connect the equipment into an outlet on a circuit different from that to which the receiver is connected.
- 4 Consult the dealer or an experienced radio/TV technician for help.

Compliance Statement for Canada

This Class B digital apparatus complies with Canadian ICES-003.

Cet appareil numérique de la classe B est conforme à la norme NMB-003 du Canada.

This device complies with Class B Limits of Industry Canada. Operation is subject to the following two conditions;

- 1 This device may not cause harmful interference, and
- 2 This device must accept any interference received, including interference that may cause undesired operation.

European Union Declarations of Conformity

LG-Nortel Co. Ltd. declares that the equipment specified in this document, which bears the "CE" mark, conforms to the European Union Radio and Telecommunications Terminal Equipment Directive (R&TTE 1999/5/EC), including Electromagnetic Compatibility Directive (2004/108/EC) and Low Voltage Directive (2006/95/EC).

The product fulfills the essential requirements of the harmonized standards shown above.

Product Safety Instructions

This product complies with and conforms to the following international Product Safety standards as applicable:

Safety of Information Technology Equipment, IEC 60950-1, including Relevant national deviations as listed in Compliance with IEC for Electrical Equipment (IECEE) Safety of Information Technology Equipment, CAN/CSA-C22.2 No. 60950-1/UL 60950-1

E-911 and This Phone's Use with Multi-Line Telephone Systems

Please note that the use and operation of this phone as part of a multi-line telephone system (MLTS) may be subject to state and/or federal E-911 MLTS laws that require the MLTS to provide a caller's telephone number, extension, and physical location to applicable state and/or local emergency services when a caller initiates a 911 call. This phone does not provide a caller's telephone number, extension, or physical location information to emergency services when a caller dials 911, and compliance with state and/or federal E-911 MLTS laws is the sole responsibility of the purchaser of this phone.

Regulatory Information and Disclaimers

"Privacy of communications may not be ensured when using this telephone".

Any changes or modifications made to this device that are not expressly approved by the manufacturer may void the user's authority to operate the equipment. The Manufacturer is not responsible for any radio or television interference caused by unauthorized modification of this device, or the substitution or attachment of connecting cables and equipment other than those specified by the manufacturer. It is the responsibility for the user to correct any interference caused by such unauthorized modification, substitution or attachment.

The manufacturer and its authorized resellers or distributors will assume no liability for any damage or violation of government regulations arising from failure to comply with these guidelines.

Pursuant to Part 15 of the Federal Communications Commission(FCC) Rules, the user is cautioned that changes or modifications not expressly approved by LG-Nortel. Could void the user's authority to operate this equipment.

Important Safety Instructions

- Before connecting or using your new phone, take a moment to consider safety and reliability. Use common sense when locating, connecting and using you Phone.
- Locate on a dry level surface away. Keep the phone away from the edges of the surface to avoid the potential of a fall.
- Locate cables to avoid potential for damage. For example, do not locate under rugs or carpet as damage may result from foot traffic or heavy objects. Also, do not locate cables between the desktop and walls where they may be crushed, damaging the insulation.
- Check the cables regularly and, if damage is noted, disconnect your phone. Contact your local representative for a replacement.
- Should liquid spill on the phone, disconnect the unit from power and the network.
- Do not use during lightning storms. Lightning presents a potentially lethal shock hazard.
- Clean the phone with a soft dry cloth; do not use liquid cleaners.
- Always use caution when connecting to AC power. Use only with a properly grounded standard AC power outlet.



P/N: MMBB1234567.1.0

Printed In Thailand. Copyright © 2008 LG-Nortel Co.Ltd. All rights reserved.



IP8830 Series Quick Installation Guide

This document provides information about the IP8820, IP8830, and IP8840. You can download all required documents at www.lg-nortel.com.

Before you start

If you require a Global Power Supply for your IP Phone, use the LG-Nortel approved global power supply.

Package contents

The following items are included in your IP8800 Series package. Before installation, ensure that you have the following package contents:

- IP Phone (IP8830)

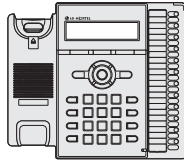

- Foot Stand

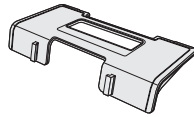

- Handset



- Handset Cord



- 2.0m CAT5 Ethernet Cable

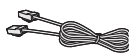

- Number Plates (2ea)
(only for IP8820/IP8830)

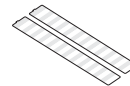

Installation

To install this IP Phone correctly, please follow the procedures. Please refer to the figures as shown below.

Attaching the foot stand

Decide if you will be attaching the foot stand angle either **35 degree** or **55 degree**.

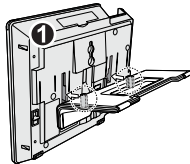
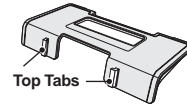

Align the top tabs on the foot stand with the slots on the back of your IP Phone. Please refer to the figures left for the correct placement of the foot stand.

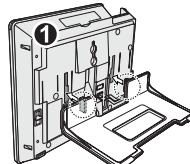

Turn the foot stand upside down; Align the top tabs on the foot stand with the slots on the back of your IP Phone. Please refer to the figures left for the correct placement of the foot stand.

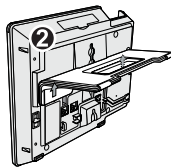

And then, move the foot stand upward until it clicks into place.

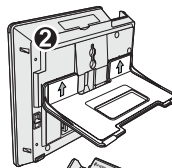

And then, move the foot stand upward until it clicks into place.

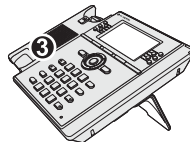

The IP Phone sits at a **35 degree angle**.

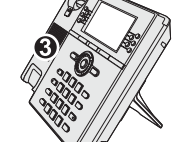



The IP Phone sits at a **55 degree angle**.





For more detailed installation instructions, see IP8820/IP8830/IP8840 Installation at www.lg-nortel.com.

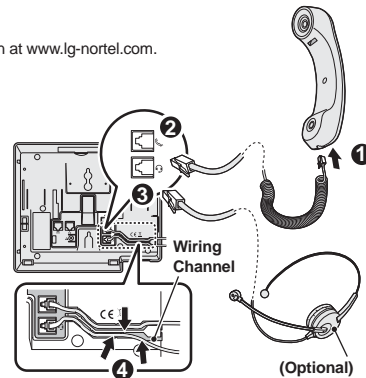

Connecting Handset and Headset

- 1 Plug one end of the handset cord (short straight section) into the handset.
- 2 Plug the other end of the handset cord (long straight section) into the handset jack on the back of the IP Phone marked with the  symbol.
- 3 (Optional) Plug one end of the cord into the headset jack on the back of the IP Phone marked with the  symbol.
- 4 From a small bend in the cord, thread the cord through the wiring channel.



Connecting Network and Power

Note: Your IP Phone supports both AC power and Power over Ethernet (PoE), (more than class 2). To use AC power, use only the LG-Nortel Approved AC power adapter (SSAD9025601), which you can order separately. To use PoE, your connected LAN must support PoE and an AC power adapter is not required.

- 1 Plug one end of the supplied LAN Ethernet cable into the LAN Ethernet port on the back of your IP Phone marked with the  symbol.
- 2 Plug the other end of the cable into your LAN Ethernet connection. (Do not extend the LAN Ethernet cable to the outside of the building.)
- 3 (Optional) If you are connecting your PC Ethernet through the IP Phone, plug one end of the LAN Ethernet cable into the PC Ethernet port on the back of your IP Phone marked with the  symbol.
- 4 (Optional) Plug the other end of the cable into your LAN Ethernet connection.
- 5 (Optional) Connect the AC power adapter (not supplied) to the AC adapter jack on the back of your IP Phone. Fasten the cord with a hook to prevent it from being disconnected.
- 6 (Optional) Plug the AC power adapter into the nearest AC power outlet. The phone will start up.

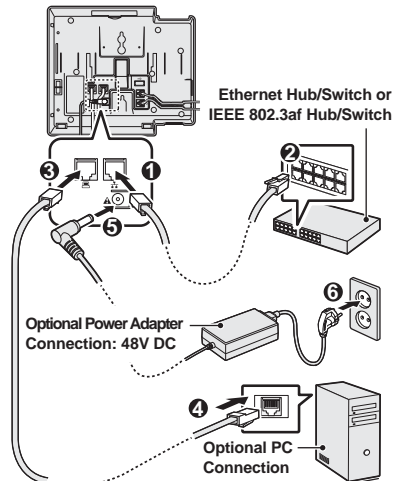

Wall-mounting the IP Phone (Optional)

Note: Ensure all cables are routed and if necessary, that power is installed.

- 1 Remove the foot stand.
- 2 Pull out the handset retainer tap out of the slot. Turn around and place in the opposite direction. Then hang up the handset.
- 3 Make a small mark on the wall where you want the top keyhole slot to align and insert a screw (not provided) so that it protrudes slightly 2.5mm from the wall.
- 4 Measure a straight line down 10cm from the mark, and insert a screw (not provided).
- 5 Align the keyholes on the back of the IP Phone with the screws in the wall, and then slide the IP Phone down on the screws to secure the IP Phone.

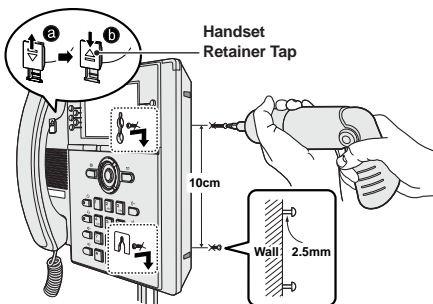

Expansion Modules for IP8830 Series

This document provides information about the LCD Expansion Module: 12-Key Self-Labeling and the LED Expansion Module: 12-Key Paper Label. You can download all required documents at www.lg-nortel.com.

Your Expansion Modules

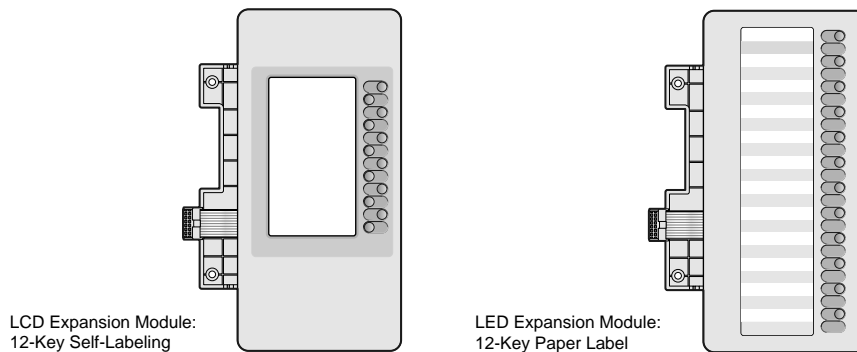

Description

The Expansion Modules for IP Phone 8800 Series provide 12 additional line/programmable feature keys for your IP Phone. You can place the IP Phone and Expansion Modules on your desktop or you can wall-mount the IP Phone and Expansion Modules.

Up to one LCD or LED Expansion Modules are supported on a single IP Phone. The Expansion Modules are supported on the IP Phone 8820, 8830 and 8840.

Installation

Caution! To avoid damaging equipment, remove the power from the IP Phone before connecting an Expansion Module. To install this Expansion Module correctly, please follow the procedures.

Installing the Expansion Modules

- 1 Remove power from the IP Phone.
- 2 Remove the foot stand from the IP Phone.
- 3 At the back of the IP Phone, remove the rubber plug from the **Accessory Expansion Module (AEM)** port.
- 4 Plug the 12-pin cable from the Expansion Module into the AEM port on the back of the IP Phone.
- 5 Place the connecting arm of the Expansion Module behind the IP Phone and align the Expansion Module connecting holes with the connecting holes on the back of the IP Phone.
- 6 Turn the screw to the right to connect the Expansion Module and IP Phone firmly together.

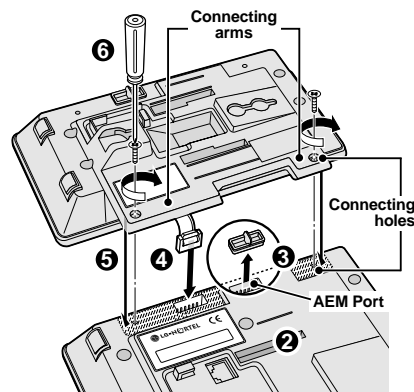

Attaching the foot stands

Set the Expansion Module and IP Phone foot stands to the same angle.

- 1 Align the Top tabs on the foot stands with the slots on the back of the Expansion Module and IP Phone.
- 2 And then, move the foot stands upward until it clicks into place.

For more detailed installation instructions, see the *IP8800 Series Quick Installation Guide*.

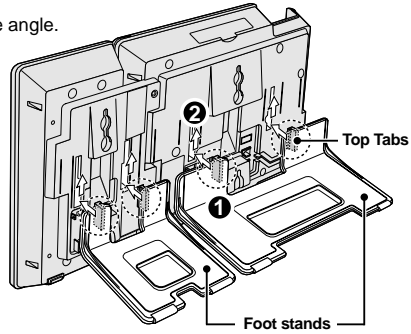

Completing the installation

- 1 Connect power to the IP Phone. The IP Phone and Expansion Modules power up. The Expansion Modules use the electrical connection of the IP Phone for power. Expansion Modules do not have their own power source.

After you power up your IP Phone, the Expansion Module LEDs or LCD display icons flash (depending on Expansion Module type), until communication with the IP Phone is established. For information about programming features, see the *IP8800 Series Installer Guide* at www.lg-nortel.com.

Wall-mounting the IP Phone and Expansion Modules

- 1 Remove the foot stands from the IP Phone and Expansion Module.
- 2 Ensure that the cables are properly connected to the IP Phone, and then connect the Expansion Module to your IP Phone, as previously described.
- 3 Wall-mount the IP Phone and Expansion Module using the keyholes in the back of the IP Phone and Expansion Module.

For more detailed installation instructions, see *IP8800 Series Quick Installation Guide* at www.lg-nortel.com.

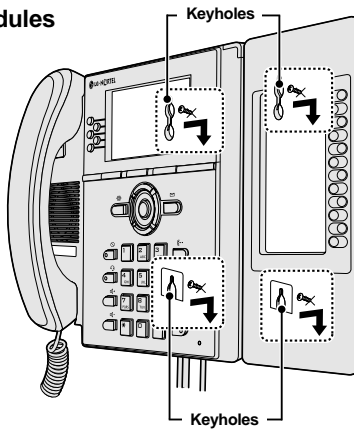

P/NO: MMB9219501,1.0

Printed In Thailand. Copyright © 2008 LG-Nortel Co.Ltd. All rights reserved.

IP8800 Series Expansion Modules Quick Installation Guide