

**W-SOHO**  
Wireless Telephone System



# LWS (LG-Ericsson Wireless SOHO) Installation & Operation Manual

## Wireless SOHO Installation & Operation Manual

---

### Copyright© 2010 LG-Ericsson Co., Ltd. All Rights Reserved

This material is copyrighted by LG-Ericsson Co., Ltd. Any unauthorized reproductions, use or disclosure of this material, or any part thereof, is strictly prohibited and is a violation of Copyright Laws. LG-Ericsson reserves the right to make changes in specifications at any time without notice. The information furnished by LG-Ericsson in this material is believed to be accurate and reliable, but is not warranted to be true in all cases.

All other brand and product names are trademarks or registered trademarks of their respective companies.

### Special notes for operation in New Zealand

The grant of a Telepermit for any item of terminal equipment indicates only that Telecom has accepted that the item complies with the minimum conditions for connection to its network. It indicates no endorsement of the product by Telecom, nor does it provide any sort of warranty. Above all, it provides no assurance that any item will work correctly in all respects with another item of Telepermitted equipment of a different make or model, nor does it imply that any product is compatible with all of Telecoms network services.

Telepermitted equipment only may be connected to this unit's SLT port. The SLT port is not specifically designed for 3-wire-connected equipment, 3-wire-connected equipment might not respond to incoming ringing when attached to this port.

Under power fail conditions, this telephone system may not operate. Please ensure that a separate telephone, not dependent on local power, is available for emergency use.

The caller's telephone numbers which are displayed and stored in this equipment include the callers area code plus the toll prefix "0". When calling-back to a local number caller using the stored CLI, the "0" and area code will be used, which may incur a toll charge, depending on your toll carrier. If a charge for local calls is unacceptable, only the 7 digits of the local number should be dialled.

The Caller Display receiver operates correctly in conjunction with Telecom's ringing cadences DA1 (normal cadence) DA2 (unused cadence) and DA4 (FaxAbility cadence). It does not operate in conjunction with ringing cadence DA3 (unused cadence).

---

## Revision History

ISSUE	DATE	Contents of Changes
1.0	Feb. 2010	Initial release
1.1	March 2010	Revised the text of Menu on LCD and corrected misspelling. And added to Special note for New Zealand.
1.2	July 2010	Change the new CI (LG-Ericsson)

## Table of Contents

<b>SPECIAL NOTES FOR OPERATION IN NEW ZEALAND</b> .....	<b>1</b>
<b>1 INTRODUCTION</b> .....	<b>1</b>
<b>1.1 Manual Usage</b> .....	<b>1</b>
<b>1.2 Package Contents</b> .....	<b>1</b>
<b>1.3 Configuration</b> .....	<b>2</b>
<b>1.4 System Capability</b> .....	<b>3</b>
1.4.1 Description .....	3
<b>1.5 Important Safety Information</b> .....	<b>4</b>
1.5.1 Installation and Environment .....	4
1.5.2 Electrical Considerations .....	4
1.5.3 Precaution.....	5
1.5.4 Caution.....	5
<b>2 INSTALLATION</b> .....	<b>6</b>
<b>2.1 Pre-Installation</b> .....	<b>6</b>
2.1.1 Safety Installation Instructions .....	6
<b>2.2 Battery Installation</b> .....	<b>7</b>
2.2.1 GDC-400H Handset Battery Installation.....	7
2.2.2 GDC-450H Handset Battery Installation.....	8
<b>2.3 LWS-BS, Handset and Peripheral Connections</b> .....	<b>10</b>
2.3.1 FAX Connection.....	11
2.3.2 AC/DC Adapter Connection.....	11
2.3.3 LWS-WK Connection.....	12
2.3.4 Wireless Handset Connection .....	12
2.3.5 Foot Stand Connection (the LWS-BS and LWS-WK) .....	13
<b>2.4 Hardware Installation</b> .....	<b>15</b>
2.4.1 Wall Mount of the LWS-BS or the LWS-WK.....	15
<b>2.5 Component Description</b> .....	<b>16</b>
2.5.1 LWS-BS Description .....	16
2.5.2 LWS-WK Description .....	17
2.5.3 Wireless Handset Description .....	18
<b>2.6 Hardware Initialization</b> .....	<b>19</b>
2.6.1 LWS-BS and LWS-WK .....	19
2.6.2 Wireless Handset.....	19

<b>2.7 Display</b> .....	<b>19</b>
2.7.1 LCD Specification .....	19
2.7.2 LCD Display .....	20
<b>2.8 Keypad Description</b> .....	<b>22</b>
2.8.1 LWS-BS .....	22
2.8.2 LWS-WK .....	22
2.8.3 GDC-400H/450H Wireless Handset .....	23
<b>2.9 LED Operation Description</b> .....	<b>25</b>
2.9.1 LWS-BS and Wireless Keypad .....	25
<b>2.10 Configuration</b> .....	<b>26</b>
2.10.1 Country code .....	26
2.10.2 LWS-BS Date and Time .....	27
<b>2.11 Terminal Registration and Termination</b> .....	<b>27</b>
2.11.1 Registering the GDC-400H/450H / LWS-WK to LWS-BS .....	27
2.11.2 Terminating a Registration .....	29
<b>2.12 Menu Trees</b> .....	<b>30</b>
2.12.1 LWS-BS Menus .....	30
2.12.2 LWS-WK Menus .....	30
<b>2.13 System Capacities</b> .....	<b>31</b>
<b>3 OPERATION INSTRUCTIONS</b> .....	<b>32</b>
<b>3.1 Call Forward</b> .....	<b>32</b>
<b>3.2 Call Pick-up</b> .....	<b>33</b>
3.2.1 Directed Call Pick-Up .....	33
3.2.2 Group Call Pick-Up .....	33
<b>3.3 Call Transfer</b> .....	<b>34</b>
<b>3.4 Call Waiting/Camp-On</b> .....	<b>35</b>
<b>3.5 LINE Access</b> .....	<b>35</b>
<b>3.6 Three-Party Voice Conference</b> .....	<b>36</b>
<b>3.7 Directory</b> .....	<b>37</b>
<b>3.8 DND(Do Not Disturb)</b> .....	<b>37</b>
<b>3.9 Headset Compatibility</b> .....	<b>38</b>
<b>3.10 Hold</b> .....	<b>39</b>
3.10.1 Hold .....	39
3.10.2 Hold Recall .....	40

3.10.3 Automatic Hold .....	40
<b>3.11 CID Blacklist</b> .....	<b>40</b>
<b>3.12 Allowed/Denied Number</b> .....	<b>41</b>
<b>3.13 MOH (Music-On-Hold)</b> .....	<b>41</b>
<b>3.14 Speed Dial</b> .....	<b>42</b>
3.14.1 Display Security .....	42
3.14.2 Station Speed Dial .....	42
3.14.3 System Speed Dial .....	43
<b>3.15 VSF Integrated Auto Attendant/Voice Mail</b> .....	<b>44</b>
3.15.1 VSF .....	44
3.15.2 Auto Attendant .....	44
3.15.3 VSF Voice Mail .....	45
<b>3.16 Wake-Up Alarm</b> .....	<b>49</b>
<b>3.17 Intercom Call (ICM Call)</b> .....	<b>50</b>
<b>3.18 Intercom Call Hold</b> .....	<b>51</b>
<b>3.19 Line Ring Assignment</b> .....	<b>51</b>
<b>3.20 Night/Weekend mode</b> .....	<b>52</b>
<b>3.21 Call Log Display</b> .....	<b>52</b>
<b>3.22 Mute</b> .....	<b>53</b>
<b>3.23 Tel/Fax Line</b> .....	<b>53</b>
<b>3.24 Feature Code for LWS-BS</b> .....	<b>54</b>
<b>3.25 Feature Code for LWS-WK</b> .....	<b>55</b>
<b>4 USEFUL INFORMATION</b> .....	<b>56</b>
<b>4.1 Trouble shooting</b> .....	<b>56</b>

# 1 INTRODUCTION

This Installation & Operation Manual is designed to provide general system features and operating instructions for the LWS (LG-Ericsson Wireless SOHO) System.

This wireless telephone system is compliant to the Digital Enhanced Cordless Telecommunication (DECT) specification, using carrier frequencies from 1.88GHz to 1.9GHz. It uses Time Division Multiple Access (TDMA) technology, providing security and protection from eavesdropping.. The system utilises duplex communication between each handset or keyset via the LWS-BS (base).

## 1.1 Manual Usage

This document provides general information about the installation, description and operation of the LWS system. While every effort has been made to ensure the accuracy of this information, LG-Ericsson takes no responsibility for the accuracy or interpretations thereof.

This section is a functional listing of features with the description and operation of each.

The structure is divided into 3 parts as listed:

- **Description:** explains the nature of the feature.
- **Operation:** describes how to use the feature.
- **NOTE:** explains any requirements or constraints of the feature related to its configuration.

## 1.2 Package Contents

The LWS-BS includes one (1) base station, one (1) AC/DC power adapter, one (1) AC power cord, one (1) antenna with rubber ring, three (3) line cords, one (1) 'Quick User Guide' and one (1) CD manual.

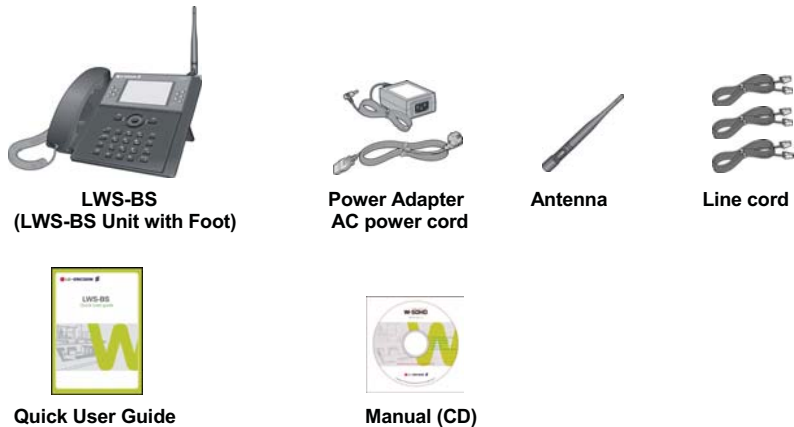

The LWS-WK includes one (1) wireless keyset, one (1) AC/DC power adapter, one (1) AC power cord, and one (1) 'Quick User Guide'. Verify that all parts shown below were provided in the package.

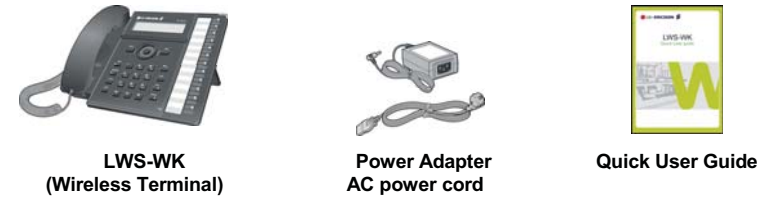

Figure 1.2-2 LWS-WK Package Contents

## 1.3 Configuration

The following image depicts a sample configuration using LWS-BS system and wireless phones, LWS-WK and GDC-400H/450H.

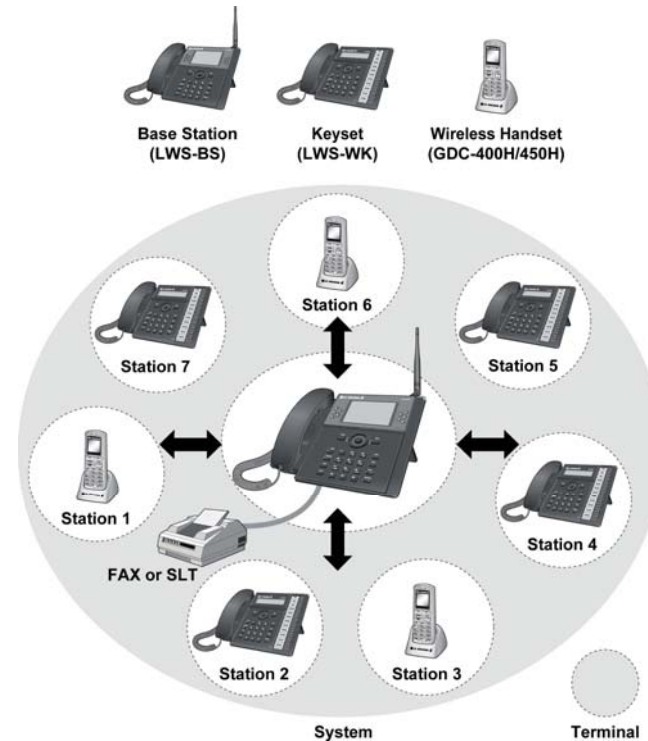

Figure 1.3-1 Sample Configuration

## 1.4 System Capability

### 1.4.1 Description

- Lines: up to 3
- Cordless Handsets: up to seven cordless handsets (provided separately)



Figure 1.4-1 LWS-BS and GDC-400H/450H

External calls (Line calls): up to 3 supported.

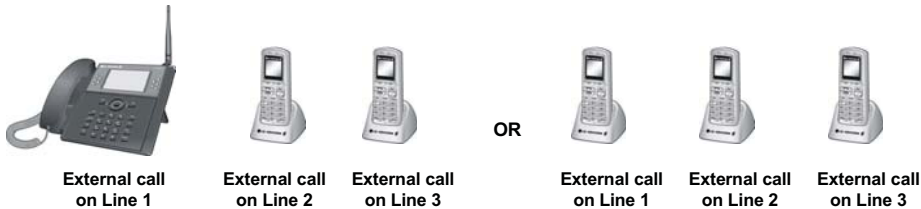

Figure 1.4-2 Three (3) External Calls Supported

Internal Calls: Three (3) internal calls can be conducted on six (6) cordless handsets while the LWS-BS simultaneously makes an external call.



Figure 1.4-3 – Internal Calls Supported

One (1) FAX call or SLT (Single Line Telephone) call can be conducted on the SLT port of the LWS-BS.



Figure 1.4-4 FAX or SLT call via SLT port of the LWS-BS

## 1.5 Important Safety Information

Read this information before installing your LWS system. Failure to comply with these guidelines could prove either dangerous or illegal. This information helps to avoid personal injury, damage to the phone, or other property damage.

### 1.5.1 Installation and Environment

1. Install all phones according to the manual, failure to do so could affect product functionality.
2. Do not install phones in direct sunlight so as to ensure full product functionality and fire prevention.
3. Do not install in non-ventilated areas such as the inside of a desk or other enclosure so as to ensure full product functionality and fire prevention.
4. Do not install the phones near appliances such as a TV, refrigerator, vacuum cleaner, audio equipment etc. which may cause interference and affect voice quality.
5. Do not install the phones in an excessively dusty area so as to ensure full product functionality, fire and electrical short prevention.

### 1.5.2 Electrical Considerations

1. Do not overload the electrical outlet with power cords so as to prevent fire or electric shock.
2. Do not touch the plug with wet hands. Failure to comply may cause electric shock.
3. To disconnect any phone from the electrical socket grasp and pull the plug not the cord. Failure to comply may cause fire or electric shock.
4. Do not cover the phones or place the phones or power adapter near a heating appliance. Failure to comply may cause fire or electric shock.
5. Do not place objects on the power cord, or allow the power cord to excessively bend. Failure to comply may cause fire or electric shock.
6. Do not modify or disassemble the power cord. If power cord or plug is impaired, do not use it. Failure to comply may cause fire or electric shock.
7. Only clean power cord and plug when not plugged into the outlet, by rubbing the cord with a soft cloth. Failure to comply may cause fire or electric shock.

### 1.5.3 Precaution

1. Keep the LWS-BS, the LWS-WK and DECT terminals away from heating appliances and electrical noise generating devices such as fluorescent lamps microwave ovens and televisions. These noise sources can interfere with the performance of the LWS system.
2. This system should be kept free of dust, moisture, high temperature (more than 40 degrees) and vibration, and should not be exposed to direct sunlight.
3. To Clean the LWS-BS, the LWS-WK and DECT Terminals, wipe with a soft cloth only. Do not use benzene, paint thinner, or an abrasive cleansing powder as these may cause damage to the system and possible fire or electric shock.

### 1.5.4 Caution

1. If the product casing is broken, disconnect the power supply cord immediately and return the system to your dealer.

### **WARNING**

**Replace batteries only with the same or equivalent type recommended by the manufacturer.  
Dispose of used batteries according to the manufacturer's instructions.**

## 2 INSTALLATION

### **2.1 Pre-Installation**

Please read the following guidelines concerning installation and connection before installing the LG-Ericsson Wireless SOHO System. Be sure to comply with any applicable local regulations.

(Note: telephone extension cabling must be performed by local regulatory each country registered installer).

#### **2.1.1 Safety Installation Instructions**

**When installing telephone wiring, basic safety precautions should always be followed to reduce the risk of fire, electric shock and personal injury:**

1. Never install telephone wiring during a lightning storm.
2. Never install a telephone jack in wet locations unless the jack is specifically designed for a wet environment.
3. Never touch un-insulated telephone wires or terminals unless the telephone line has been disconnected.

## 2.2 Battery Installation

### 2.2.1 GDC-400H Handset Battery Installation

To install a Battery to the Handset:

1. Remove the battery cover by pressing the latch as shown, and slide down to open.
2. Verify batteries are orientated correctly for polarity when inserting.
3. Close the battery cover and slide it upward until it clicks into place.

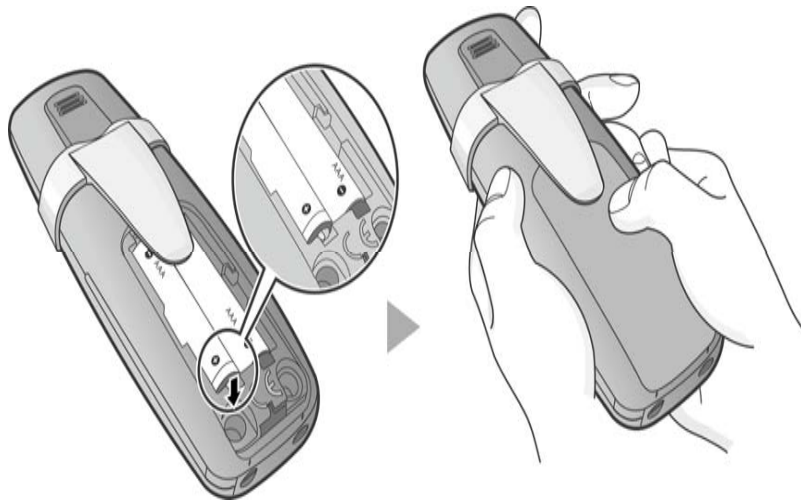

Figure 2.2.1-1 Handset Battery Installation

**NOTE:**

- Purchase new batteries from your LG-Ericsson Service Center.
- The battery has a limited operating life (warranty period for the battery is 6 months from purchase date).

#### 2.2.1.1 GDC-400H Battery Charging

To charge the handset:

1. Place handset on the plugged-in charger for 12 hours before initial use.

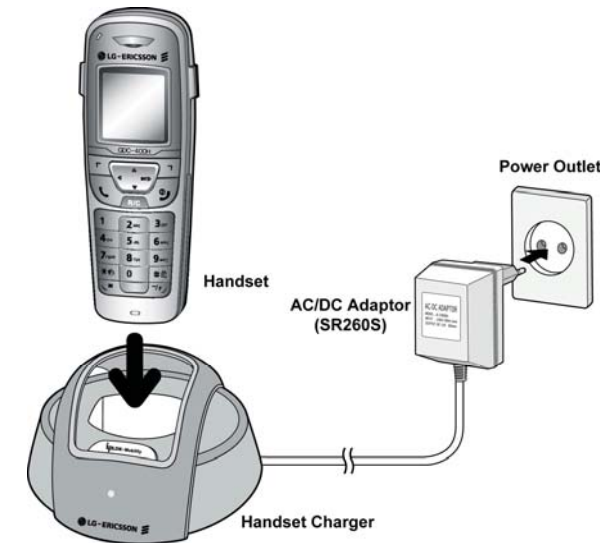

Figure 2.2.1.1-1 GDC-400H Handset Battery Charging

### 2.2.2 GDC-450H Handset Battery Installation

To install a Battery to the Handset:

1. Remove the battery cover by pressing the latch as shown, and slide down to open.
2. Verify batteries are orientated correctly for polarity when inserting.
3. Close the battery cover and slide it upward until it clicks into place.

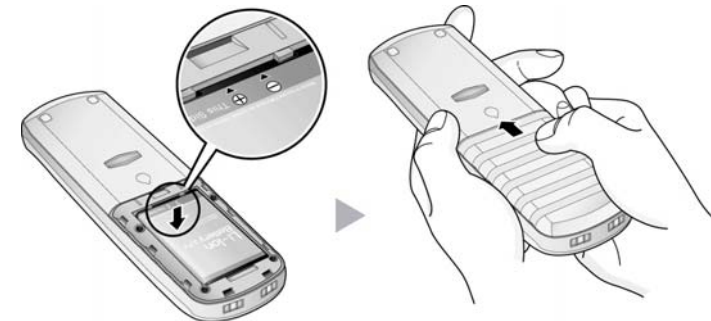

Figure 2.2.2-1 GDC-450H Handset Battery Installation

**NOTE:**

- Purchase new batteries from your LG-Ericsson Service Center.
- The battery has a limited operating life (warranty period for the battery is 6 months from purchase date).

### 2.2.2.1 GDC-450H Battery Charging

To charge the handset:

1. Place handset on the plugged-in charger for 12 hours before initial use.

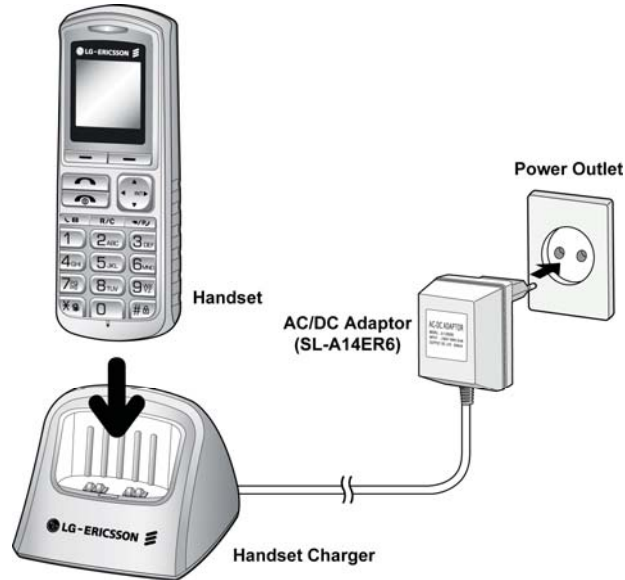

Figure 2.2.2.1-1 GDC-450H Handset Battery Charging

**NOTE:** The GDC-450H uses an advanced battery charging technology, the battery level is reviewed every 6 hours causing red recharge light to illuminate briefly.

## 2.3 LWS-BS, Handset and Peripheral Connections

To connect the LWS-BS with phone lines and its peripherals:

1. Connect the line cords to the ports on the bottom of the LWS-BS and the other ends to the wall sockets.
2. Plug the AC/DC Adaptor cord and FAX/SLT Line into the bottom of the LWS-BS.
3. Connect the handset curly cord to the handset jack on the bottom of the LWS-BS.
4. Connect the optional Headset to the headphone jack on the bottom of the LWS-BS.
5. Screw the included rubber antenna clockwise onto the terminal at right side of the top of the LWS-BS.

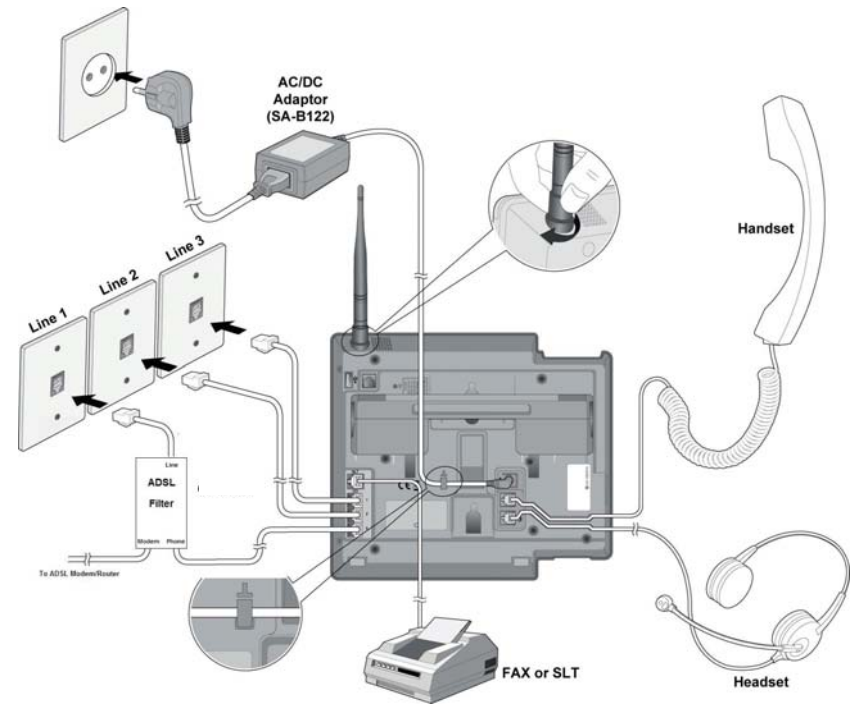

Figure 2.3-1 LWS-BS Connections

**NOTE:**

- Use only the included LG-Ericsson AC Adapter (SA-B122).
- Using a headset with the LWS-BS is optional.
- Avoid mounting near a TV, another cordless telephone or a microwave oven.
- To reduce the risk of fire, use only No. 26 AWG or larger telecommunication line cord



### 2.3.1 FAX Connection

The following figure illustrates how to connect a FAX to the LWS-B5:

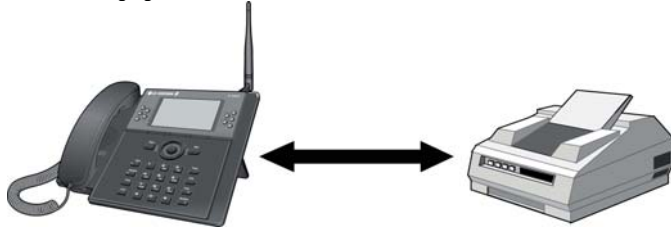

### 2.3.2 AC/DC Adapter Connection

To connect the AC/DC adapter:

1. Plug the DC outlet of the AC/DC Adapter cord into the jack on the LWS-B5.
2. Fasten the AC/DC Adapter cord to the latch hook as shown (inset detail).

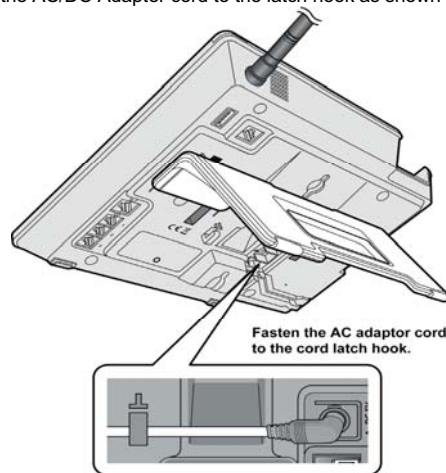

Figure 2.3.2-1 AC/DC Adapter Connection

### 2.3.3 LWS-WK Connection

To connect the LWS-WK to be used with the LWS-B5:

1. Plug the DC outlet of the AC/DC Adapter cord into the jack on the LWS-WK.
2. Fasten the AC/DC Adapter cord to the latch hook as shown (inset detail).
3. Connect the handset curly cord to the handset jack on the bottom of the LWS-WK.
4. Connect the optional headset to the headset jack on the bottom of the LWS-WK)

- NOTE:**
- > Use only the included LG-Ericsson AC Adapter (SA-B122).
  - > Using a headset with the LWS-WK is optional.
  - > Avoid mounting near TV and another cordless telephone, microwave oven, or personal computers and other electrical equipment.

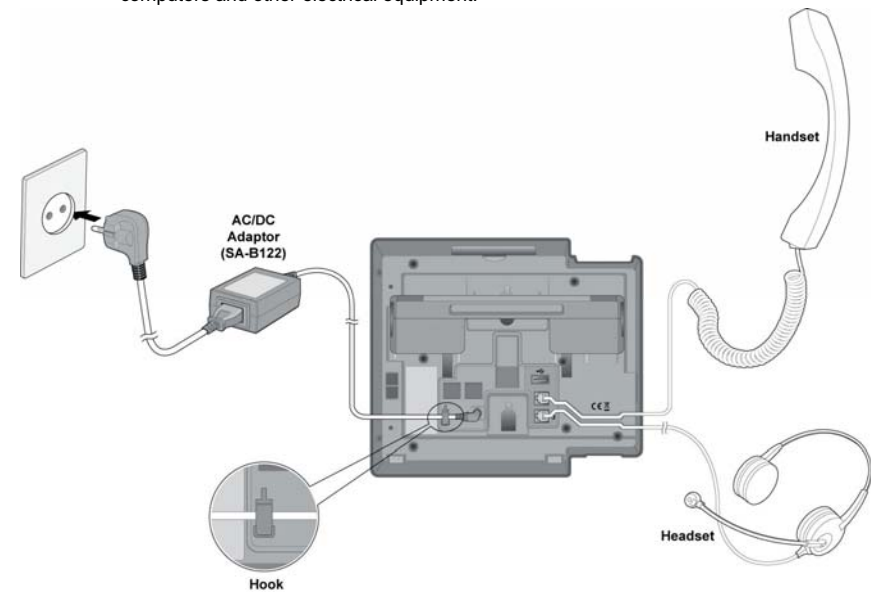

Figure 2.3.3-1 LWS-WK Connection

### 2.3.4 Wireless Handset Connection

To connect a Wireless Handset to be used with the system:

1. Plug in the AC adapter cord to the Handset Charger and plug AC outlet to the power outlet.
2. Use only the included LG-Ericsson AC/DC adapter, which is provided together with GDC-400H/450H. It is dependent on the country to provide the AC/DC adapter.

**Warning**

Use only the main power adapter supplied. Any other adapter could damage your GDC-400H and invalidate your warranty

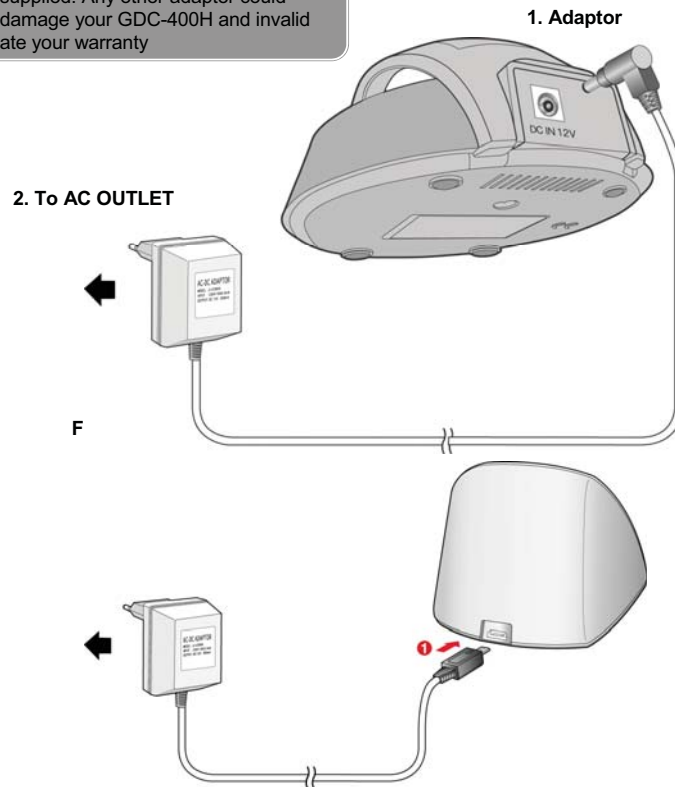

Figure 2.3.4-2 Wireless Handset Charger Connection: GDC-450H

**2.3.5 Foot Stand Connection (the LWS-BS and LWS-WK)**

When the Foot Stand to either the LWS-BS or the LWS-WK is attached, it can be connected at a 35 or 55 degree angle.

To connect the Foot Stand at a 35 degree angle, perform the following:

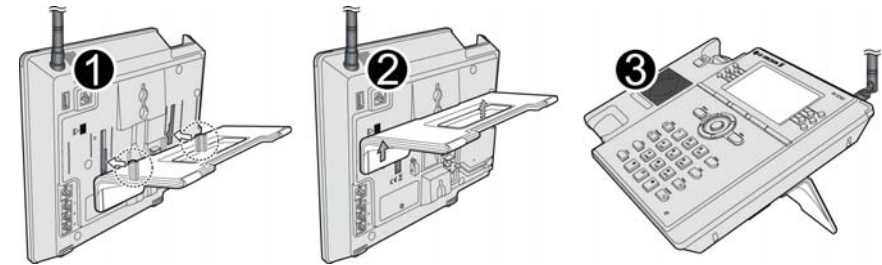

Figure 2.3.5-1 Foot Stand Connection (35 degree angle)

To connect the Foot Stand at a 55 degree angle, perform the following:

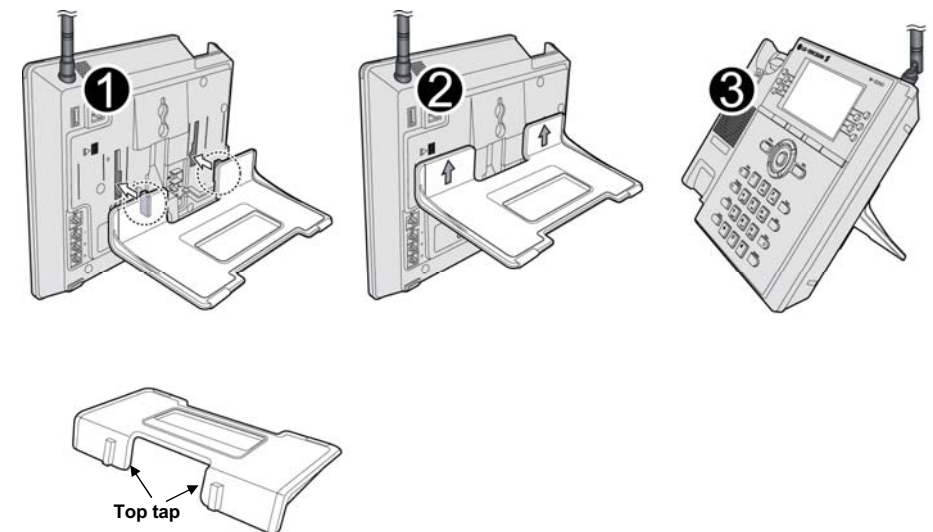

Figure 2.3.5-2 Foot Stand Connection (55 degree angle)

1. Align the top tabs on the foot stand with the slots on the back of the LWS-BS or the LWS-WK.
2. Move the foot stand upward until it clicks into place.

## 2.4 Hardware Installation

### 2.4.1 Wall Mount of the LWS-BS or the LWS-WK

To wall mount the LWS-BS or LWS-WK, perform the following:

1. Remove the foot stand.
2. Make sure the handset retainer tab is positioned at 'b' as shown below figure.

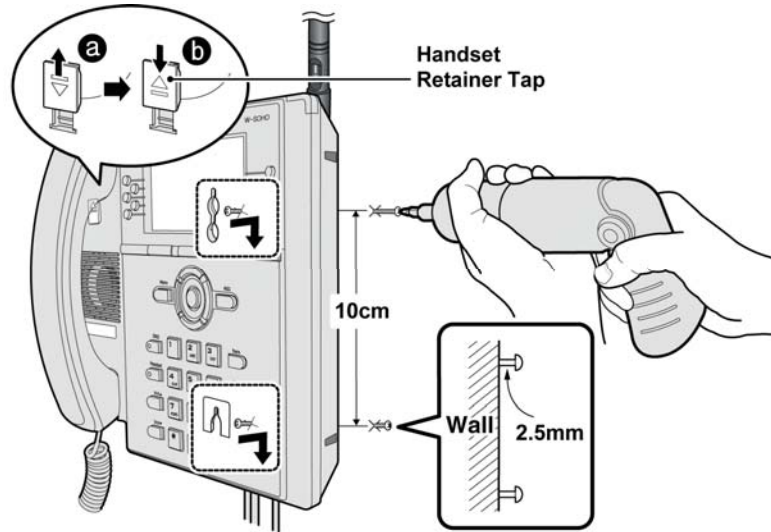

Figure 2.4.1-1 Wall Mount of LWS-BS/ LWS-WK

3. Make a small mark on the wall where you want the top keyhole slot to align and install a screw (not provided) so that it protrudes slightly, approx. 2.5mm, from the wall (Figure shown).
4. Measure a straight line down 10cm from the mark, and install another screw (not provided).
5. Align the keyholes on the back of the phone with the screws in the wall, and then slide the phone down on the screws to secure the phone.

#### Note:

- Ensure all cables are properly routed and if necessary, that power should be installed before affixing to the wall mount screws.

## 2.5 Component Description

### 2.5.1 LWS-BS Description

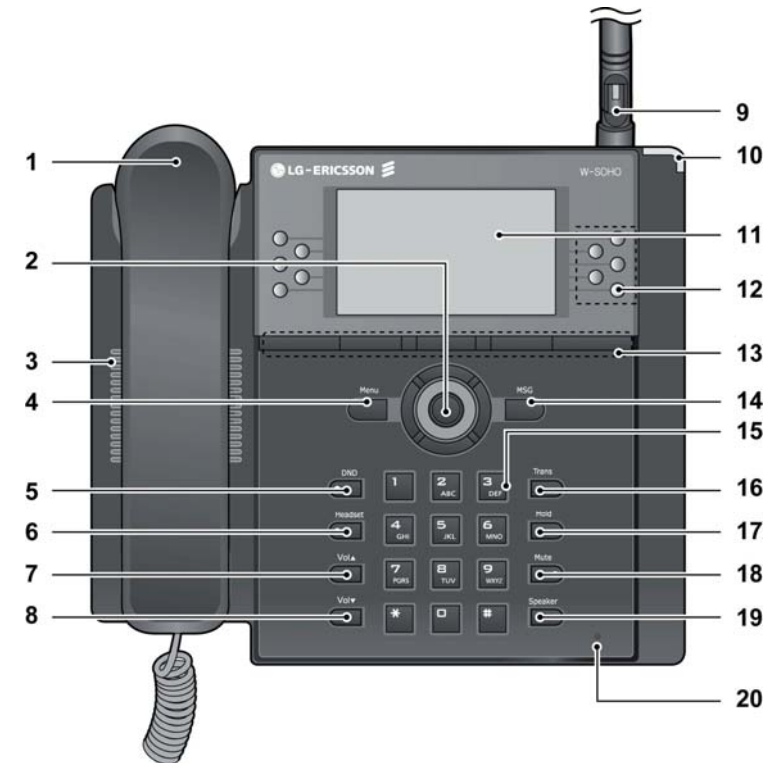

- |                     |                                    |
|---------------------|------------------------------------|
| 1. Handset          | 2. Navigation/OK Key               |
| 3. Speaker          | 4. Menu Button                     |
| 5. DND Button       | 6. Headset Button                  |
| 7. Volume Up Button | 8. Volume Down Button              |
| 9. Antenna          | 10. Ring Indication Light          |
| 11. LCD             | 12. Line/Station Selection Buttons |
| 13. Soft Buttons    | 14. MSG (Message) Button           |
| 15. Dial Buttons    | 16. Transfer Button                |
| 17. Hold Button     | 18. Mute Button                    |
| 19. Speaker Button  | 20. Microphone                     |

Figure 2.5.1-1 LWS-BS Component Description

### 2.5.2 LWS-WK Description

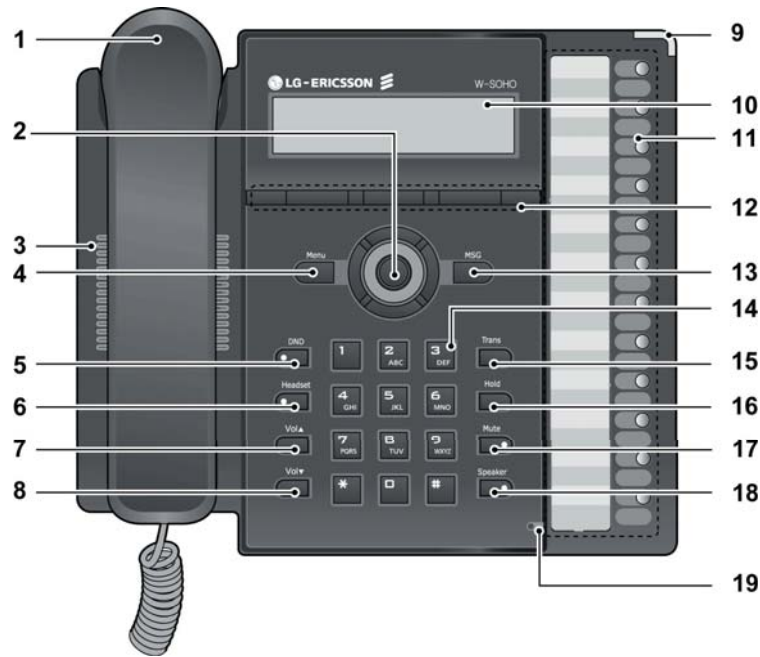

- |                                    |                       |
|------------------------------------|-----------------------|
| 1. Handset                         | 2. Navigation/OK Key  |
| 3. Speaker                         | 4. Menu Button        |
| 5. DND Button                      | 6. Headset Button     |
| 7. Volume Up Button                | 8. Volume Down Button |
| 9. Ring Indication                 | 10. LCD               |
| 11. Line/Station Selection Buttons | 12. Soft Buttons      |
| 13. MSG Button                     | 14. Dial Buttons      |
| 15. Transfer Button                | 16. Hold Button       |
| 17. Mute Button                    | 18. Speaker Button    |
| 19. Microphone                     |                       |

Figure 2.5.2-1 LWS-WK Component Description

### 2.5.3 Wireless Handset Description

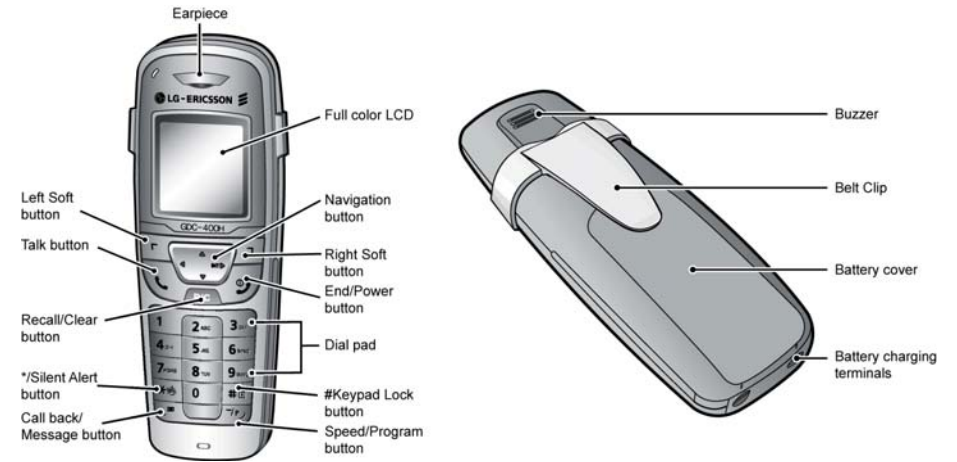

Figure 2.5.3-1 GDC-400H Component Description

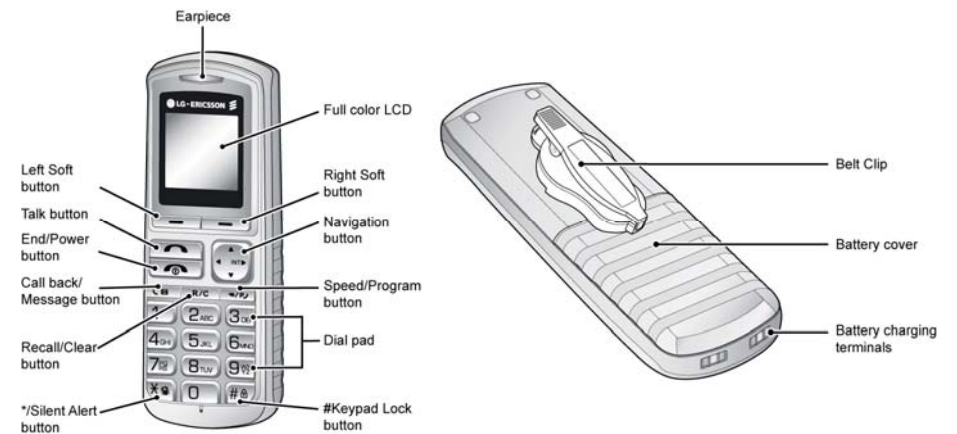

Figure 2.5.3-2 GDC-450H Component Description

## 2.6 Hardware Initialization

### 2.6.1 LWS-BS and LWS-WK

Once the LWS-BS and the LWS-WK have been properly installed in the desired locations, perform the following:

1. Plug in the AC/DC adapter to the LWS-BS or the LWS-WK (use only the included AC/DC adapter, SA-B122).
2. The LWS-BS or the LWS-WK is powered up and its display on the LCD will be activated.

### 2.6.2 Wireless Handset

To start up the Handset:

1. Press and hold [  ] for approximately 2 seconds.
2. The handset automatically enters standby mode when a signal is located.
3. The handset automatically returns to standby mode whenever it is placed on the charger.

To power-down the Handset:

1. Press and hold [  ] for approximately 3 seconds.

## 2.7 Display

### 2.7.1 LCD Specification

User can select one of backlight control options (always on, always off, busy state on).

#### 2.7.1.1 LWS-BS

- 240 x 144 Graphic LCD
- Backlit On/Off Control with 3 selectable option
- Ten-Level Contrast Setting

#### 2.7.1.2 LWS-WK

- 240 x 42 Graphic LCD
- Backlight On/Off Control
- Ten-Level Contrast Setting

## 2.7.2 LCD Display

### 2.7.2.1 LWS-BS

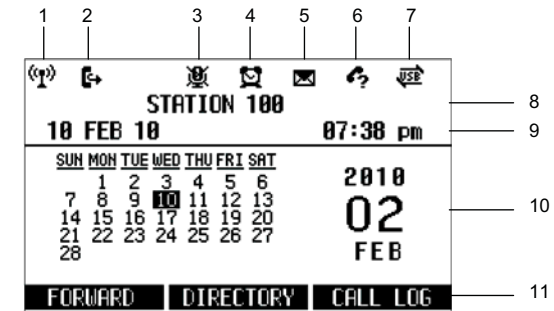
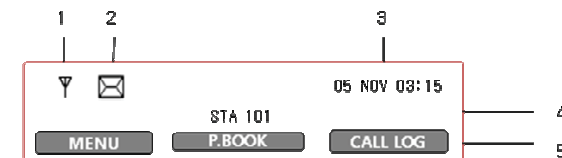

Figure 2.7.2.1-1 the LWS-BS LCD Display Screen

1. **Antenna** - Displayed when DCTU of LWS-BS works and it can be linked to DECT.
2. **Call Forward** - Icon indicates the base station is currently set for call forwarding.
3. **Mute** - Icon indicates if the mute button is activated for blocking voice transmission on your phone during a conversation.
4. **Alarm** - Icon indicates the alarm has been set.
5. **Message** - Icon indicates there is at least one new message.
6. **Missed call** - Icon indicates that there are missed calls in your absence.
7. **USB** - Icon indicates a USB memory device is inserted.
8. **Station Number** - Displayed in idle state. If the LWS-BS station has the designated name, the name is displayed.
9. **Date & Time** - Displayed in idle state.
10. **Calendar** - Displayed in idle state.
11. **Soft Menu** - Dependent on the status and menu choices, the current available selections are displayed.

### 2.7.2.2 LWS-WK



1. **Antenna** - Displayed when the LWS-WK is in the range of a LWS-BS where it can be linked. Disappears when it moves out of range. The closer it moves to the base, the stronger RSSI for reception is.
2. **Message** - Icon indicates there is at least one new message.
3. **Date & Time** - Displayed in idle state.
4. **Keyset Number** - Displayed in idle state.
5. **Soft Menu** - Dependent on the status and menu choices, the current available functions are displayed.

2.7.2.3 GDC-400H and GDC-450H Wireless Handset

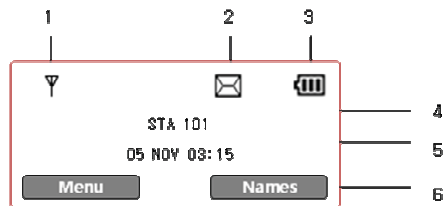

1. **Antenna** - Displayed when the handset is in the range of a LWS-BS where it can be linked. Disappears when it moves out of range. The closer it moves to the base, the stronger RSSI for reception is.
2. **Message** – Icon indicates there is at least one new message.
3. **Date & Time** – Displayed in idle state.
4. **Battery** – Displays battery level when a handset keeps operating.
5. **Handy Number** – Displayed in idle state.
6. **Soft Menu** – Dependent on the status and menu choices, the current available functions are displayed.

2.8 Keypad Description

2.8.1 LWS-BS





FUNCTIONAL CLASSIFICATION	BUTTON NAME	BUTTON DESCRIPTION
Flex Keys	Line selection button Line 1 ~ 3	Access an idle Line for making external call or answer the incoming call by pressing the line button.
	Station button Station 101~107	Allows you to make an intercom call. Station 101~107 : Wireless Terminals
Soft Menu Keys	Soft key 1,2,3	Dependent on the status and menu choices, the current available functions are displayed.
	Menu	Main Menu
	MSG	Retrieve Messages
	Navigation button	Up/down/right/left/ok
Function Keys	DND	Set Night/Weekend mode
	Headset	Headset mode or speakerphone mode is switched by pressing the [Headset] button in idle state. Headset LED will be illuminated when headset mode is selected.
	Vol. up	To turn Handset or Speaker volume up during a call/off hook. Ringer volume is turned up if phone is ringing. LCD contrast is turned up if phone is in idle state.
	Vol. down	To turn Handset or Speaker volume down during a call/off hook. Ringer volume is turned down if phone is ringing. LCD contrast is turned down if phone is in idle state.
	Trans	An intercom call or line call can be transferred to another station or line during a conversation.
	Hold	When on a call, the station user can place an active call on hold; the held party will hear a hold tone.
	Mute	During a conversation, pressing the [MUTE] button will disable the handset microphone or the speakerphone whilst continuing to listen to the other party. Pressing the [MUTE] button again, will reactivate the microphone. This button is active on all calls.
	Speaker	Pushing the [Speaker] button allows the user to make or continue a call using the Speaker for two-way communication. Pressing the [Speaker] button again, will terminate the call. EXIT on Menu
Dial Pad	0~9, *, #	Use to dial a number, select a menu item, or input values.









2.8.2 LWS-WK

FUNCTIONAL CLASSIFICATION	BUTTON NAME	BUTTON DESCRIPTION
Flex Keys	Line selection button Line 1 ~ 3	Access an idle Line for making an external call or answer the incoming call by pressing Line button.
	Station button Station 100~108	Allows you to make an intercom call. Station 100 : Base Station Station 101~107 : Wireless Terminals Station 108 : SLT/FAX
Soft Menu Keys	Soft key 1,2,3	Dependent on the status and menu choices, the current available functions are displayed.

FUNCTIONAL CLASSIFICATION	BUTTON NAME	BUTTON DESCRIPTION
Function Keys	Menu	Main Menu
	MSG	Retrieve Messages
	Navigation button	Up/down/right/left/ok
	DND	Blocks incoming calls ringing. This applies to outside calls, intercom calls and transfers
	Headset	Connecting an optional headset to the station allows hands-free conversations by pressing [Headset] button. An industry standard headset can be connected to a station
	Vol. up	To turn Handset or Speaker volume up during a call/off hook. Ringer volume is turned up if phone is ringing. LCD contrast is turned up if phone is in idle state.
	Vol. down	To turn Handset or Speaker volume down during a call/off hook. Ringer volume is turned down if phone is ringing. LCD contrast is turned down if phone is in idle state.
	Trans	An intercom call or a line call can be transferred to another station or line during a conversation.
	Hold	When on a call, the station user can place an active call on hold; the held party will hear a hold tone.
Dial Pad	Mute	During a conversation, pressing the [MUTE] button will disable the handset microphone or the speakerphone whilst continuing to listen to the other party. Pressing the [MUTE] button again, will reactivate the microphone. This button is active on all calls.
	Speaker	Pushing the [Speaker] button allows the User to make or continue a call using the Speaker for two-way communication. Pressing the [Speaker] button again, will deactivate the Speaker, and send call transmission to the handset (if in use) or terminate the call.
Dial Pad	0~9, *, #	Use to dial a number, select a menu item, or input values.

### 2.8.3 GDC-400H/450H Wireless Handset

Button	Function
	<b>[TALK]</b> <ul style="list-style-type: none"> <li>To make a call           <ul style="list-style-type: none"> <li>→ Redial number saved in handset.</li> </ul> </li> </ul>
	<b>[END/POWER]</b> <ul style="list-style-type: none"> <li><b>END/POWER]</b></li> <li>To end a call</li> <li>Press for less than 1 second : Power Off</li> <li>Press for less than 1 second :Leave a call back or a message</li> <li>Press for less than 1 second: Ignore an incoming call.</li> </ul>
 	<b>[LEFT SOFT / RIGHT SOFT]</b> Access to the current functions by pressing the soft button directly below this symbol.

Button	Function
	<b>[RECALL/CLEAR]</b> <ul style="list-style-type: none"> <li>Talk Mode : Register recall</li> <li>Recall a call and retry next call</li> <li>When using pre-dial :           <ul style="list-style-type: none"> <li>→ Press for longer than 1 second : All digits are cleared</li> <li>→ Press for less than 1 second : 1 digit backspace</li> <li>→ When using local functional operation : Function cancel (It should be pressed for longer than 1 second)</li> </ul> </li> </ul>
	<b>[SPEED/PROGRAM]</b> <ul style="list-style-type: none"> <li>Post-Dial :           <ul style="list-style-type: none"> <li>→ Press for less than 1 second: System speed dial(<b>SPEED</b>).</li> <li>→ Press for longer than 1 second: Start/Finish a system program (<b>PROGRAM</b>).</li> </ul> </li> </ul>
	<b>[LEFT]</b> <ul style="list-style-type: none"> <li>In an idle state : To view missed call</li> <li>In MENU : LEFT</li> </ul>
	<b>[RIGHT/INTERNAL/TRANSFER/HOLD]</b> <ul style="list-style-type: none"> <li>Talking Mode :           <ul style="list-style-type: none"> <li>→ Press for less than than 1 second: Transfer a call to another station(<b>TRANS</b>).</li> <li>→ Press for longer than 1 second: Hold a call / release a holding call(<b>HOLD</b>).</li> </ul> </li> <li>In an idle state :           <ul style="list-style-type: none"> <li>→ In MENU : right button</li> <li>→ To make a intercom call or a line call</li> </ul> </li> </ul>
	<b>[CALL BACK]</b> <ul style="list-style-type: none"> <li>Press less than 1 second : Leave a call back or a message</li> </ul>
	<b>[UP/DOWN]</b> <ul style="list-style-type: none"> <li>Talk Mode : Up / Down the level of Rx volume, Call by name, CLIP</li> <li>Standby Mode :           <ul style="list-style-type: none"> <li>→ In Menu: Navigate and select among function items in a menu or submenu.</li> </ul> </li> <li>No inputted state :           <ul style="list-style-type: none"> <li>→ UP : Local Redial</li> <li>→ DOWN : Phonebook list</li> </ul> </li> </ul>
	<ul style="list-style-type: none"> <li>To lock Keypad (Press for longer than 1 second)</li> <li># Display (Press less than 1 second)</li> <li>While Dialing: To insert pause (Press for longer than 1 second)</li> </ul>
	<ul style="list-style-type: none"> <li>Talk Mode : Camp-On</li> <li>Standby Mode :           <ul style="list-style-type: none"> <li>→ ** is displayed (Press for shorter than 1 second)</li> <li>→ Enable/disable manner mode(Press for less than 1 second)</li> </ul> </li> </ul>
<b>0~9</b>	- Standard dial button

## 2.9 LED Operation Description

### 2.9.1 LWS-BS and Wireless Keypad

FUNCTIONAL CLASSIFICATION	LED OPERATION	LED DESCRIPTION
Ring Indicator	RED Blink	Indicates incoming ring signal
Line Selection Button	Green/RED Blink	Line is in hold state Green blink: Line is held by the own station Red blink: Line is held by others
	Orange Blink	Indicates ringing state
	Green steady on	The green LED illuminates when you are on a call
	Red steady on	The red LED indicates that the associated line is in use by other user
Station Selection Button	ON (RED)	Illuminates when you or others are on a call
	Red Blink	Ringing state indication
	OFF	Idle State
DND, Headset Mute, Speaker	ON	Illuminates when each function is activated.
	OFF	Function is deactivated

#### Note:

##### Blinking rate:

- Base Station : 0.5/sec.
- Wireless Keypad : 0.78/sec.

## 2.10 Configuration

### 2.10.1 Country code

To set the nation code, perform the following:

1. Press the **[Menu]** button on the LWS-BS.
2. Select **1. CONFIGURATION > 2. COUNTRY**.
3. If you want to change country, press **[CHANGE]** soft key or **[OK]** Navigation key.
4. Set the Country code (refer to the below Nation Code Table).
5. When finished, press the **[SAVE]** button, and system will ask you to confirm it.
6. If you select **[YES]** as pressing digit 1, system will restart and database will be initialized.

#### Nation Code Table

NATION	CODE	NATION	CODE	NATION	CODE
America	1	Argentina	54	Australia	61
Bahrain	973	Bangladesh	880	Belgium	32
Bolivia	591	Brazil	55	Brunei	673
Burma	95	Cameroon	237	China	56
China (Taiwan)	886	CIS	7	Colombia	57
Costa Rica	506	Cyprus	357	Czech	42
Denmark	45	Ecuador	593	Egypt	20
El Salvador	503	Ethiopia	251	Fiji	679
Finland	358	France	33	Gabon	241
Germany	49	Ghana	233	Greece	30
Guam	671	Guatemala	502	Guyana	592
Haiti	509	Honduras	504	Hong Kong	852
India	91	Indonesia	62	Iran	98
Iraq	964	Ireland	353	Israel	972
Italy	39	Japan	81	Jordan	962
Kenya	254	Korea	82	Kuwait	965
Liberia	231	Libya	218	Luxembourg	352
Malaysia	60	Malta	356	Mexico	52
Monaco	377	Morocco	212	Netherlands	31
New Zealand	64	Nigeria	234	Norway	47
Oman	968	Pakistan	92	Panama	507
Papua New Guinea	675	Paraguay	595	Peru	51
Philippines	63	Portugal	351	Qatar	974
Saudi Arabia	966	Senegal	221	Singapore	65
South Africa	27	Spain	34	Sri Lanka	94
Swaziland	268	Sweden	46	Switzerland	41
Thailand	66	Tunisia	216	Turkey	90
United Arab Emirates	971	United Kingdom	44	Uruguay	598
Venezuela	58	Vietnam	84	Yemen	967

#### Note:

- It is recommended that the Country code is configured to enable proper operation of the LWS-BS according to the specific country.



## 2.10.2 LWS-BS Date and Time

The Base Date and Time can be set and adjusted by the User.. In the event of a power failure, the system will retain Date and Time including Database with internal Lithium Battery. All wireless keysets registered to the Base Station will automatically adjust Date and Time according to the Base Station value after pressing Talk key or Speaker button.

To set the Date & Time:

1. With the LWS-BS in idle state, press the **[Menu]** button.
2. Select **1. CONFIGURATION > 1. DATE / TIME**.
3. In this menu, set the Date and Time by entering the desired values using the keypad and scrolling with the navigation arrow keys.
4. When finished, press the **[SAVE]** soft key or press the **[OK]** button Navigation key and a confirmation tone will be heard.

**Note:**  
➤ **Date and Time of Wireless Keysets (LWS-WK) and Wireless Handsets (GDC-400H and GDC-450H), are automatically updated by the LWS-BS after pressing Talk key or Speaker button so there is no need to set the date and time on these.**

## 2.11 Terminal Registration and Termination

The LWS-BS controls the functional service and registration related to the LWS-WK and GDC-400H/450H including a registration function. Each LWS-WK and GDC-400H/450H must be registered to the LWS-BS (Base Station) before use.

### 2.11.1 Registering the GDC-400H/450H / LWS-WK to LWS-BS

Only one Wireless Handset or Keypad can be registered at a time.

#### 2.11.1.1 Enabling Registrations

To enable a registration, the below procedure must be performed on the LWS-BS.











1. Press **[Menu]** button.
2. Press **[Digit 1]** (CONFIGURATION submenu), or Select **[1. CONFIGURATION]** using the Navigation up/down key and then press **[OK]** soft button or Navigation 'OK' key.
3. Press **[Digit 4]** (STATION REGISTRATION submenu), or Select **[4. STATION REGISTRATION]** using the Navigation up/down key and then press **[OK]** soft button or Navigation 'OK' key.
4. Press **[Digit 1]** (REGISTER STATION submenu), or Select **[1. REGISTER STATION]** using the Navigation up/down key and then press **[OK]** soft button or Navigation 'OK' key.
5. Select the phone type using the Navigation left/right key (GDC-4XX or LWS-WK)
6. Press Navigation **[OK]** button or **[OK]** soft key.
7. Proceed to instructions below - "Registering GDC-400H/450H to the LWS-BS" or "Registering



LWS-WK to the LWS-BS.

8. When the registration is completed, below message is shown on the LCD of the LWS-BS.  
**STATION: 10X**  
**SUBSCRIBED: SUCCESS**

#### 2.11.1.2 Registering GDC-400H/450H to the LWS-BS

To register to the LWS-BS, the below procedure must be performed on the GDC-400H/450H.

1. Press **[Menu]** (  ,  ) button to display the menu.
2. Highlight [Phone Register] in the menu using the Navigation (  ) button.
3. Press **[OK]** (  ,  ) button; then the Phone Register menu will be displayed.
4. Select **[LWS Subscription]** using the up and down arrows of the Navigation (  ) button and press **[OK]** (  ,  ) button.
5. Display **[Searching.1]**.
6. The system **[RFPI : eg. 01234567890123]** will be displayed when a system is found.  
The RFPI of your system is available from your System Administrator, or perhaps the attendant.
7. Press **[OK]** (  ,  ) button; in a few seconds, a confirmation tone will be heard at the GDC-400H/450H.
8. If the registration fails, repeat the procedure from Step 1 to 7 at the LWS-BS and Step 1 to 7 from the GDC-400H/450H.

**Note:**  
➤  : [Menu], [OK] button on GDC-400H  
➤  : [Menu], [OK] button on GDC-450H  
➤ **RFPI** : Radio Fixed Part Identity  
➤ **Seven Wireless Handsets and/or Keysets can be registered to one LWS-BS.**

#### 2.11.1.3 Registering LWS-WK to the LWS-BS

To register to the LWS-BS, below procedure is performed on the LWS-WK.

1. Press **[Menu]** button to display the menu.
2. Highlight **[Phone Register]** using the Navigation up/down key, and then press **[OK]** soft button or Navigation 'OK' key.
3. Select **[Subscription]** using the Navigation up/down key, and then press **[OK]** soft button or Navigation 'OK' key.
4. Display **[Searching..1]**.
5. The system **[RFPI : eg. 01234567890123]** will be displayed when a system is found.
6. The RFPI of your system is available from your System Administrator, or perhaps the attendant.
7. Press **[OK]** soft button or 'Navigation 'OK' key. In a few seconds, a confirmation tone is received at the LWS-WK.
8. If the registration fails, repeat procedure from Step 1 to 7 at the LWS-BS and Step 1 to 6 from the LWS-WK.

## 2.11.2 Terminating a Registration

To terminate a subscription, below procedure should be performed on the LWS-BS;

1. Press **[Menu]** button.
2. Press **[Digit 1]** (CONFIGURATION submenu), or Select **[1. CONFIGURATION]** using Navigation up/down key and **[OK]** Button.
3. Press **[Digit 4]** (STATION REGISTRATION sub menu), or Select **[4. STATION REGISTRATION]** using Navigation up/down key and **[OK]** Button.
4. Press **[Digit 2]** (DEREGISTER STATION submenu), or Select **[2. DEREGISTER STATION]** using Navigation up/down key and **[OK]** Button.
5. Select the phone number using Navigation left/right key (S101~S107).
6. Press Navigation **[OK]** button or **[OK]** soft key.
7. When the subscription is complete below message is shown on LWS-BS LCD.

STATION : 10X  
UNSUBSCRIBED : SUCCESS



### Note:

- **DEREGISTER** : To erase registration information of both LWS-BS and Wireless terminals (LWS-WK and GDC-400H/450H handsets).
- **FORCED ERASE** : To erase registration information of the relevant Wireless terminal. (e.g. in case that the terminal is missing or non-functional). In this case, the registration information will be kept on the terminal itself.
- **All Data ERASE** : To erase registration information of all wireless terminals. In this case, the registration information will be kept on the terminals themselves.

### Procedure of erasing the registration information on the terminal itself:

1. Press **[Menu]** button.
2. Select **[Phone Register]** and press **[OK]** button.
3. Select **[Reset]** on the Menu and press **[OK]** button.
4. Enter HS PIN Code [default: **0000**] using dial button. And then press **[OK]** button.
5. Select **[Handset]** on the menu and **[OK]** button.

## 2.12 Menu Trees

### 2.12.1 LWS-BS Menus

1 Configuration	2 Voice Services	3 Supplementary	4 System Info	5 This Station
1 Date / Time 2 Country 3 Outside Line Setup 1) Outside line type 2) Ring Assignment 4. Station Registration 1) Register station 2) Deregister station 3) Station forced erase 4) All data erase 5) Park code 5. Station Setup 1) Outside line access restrict 2) Station name	1. Time Remaining 2. Number of Messages 3. Auto Attendant 1) Activate auto attendant 2) Record auto attendant Greeting 3) Retry count 4) Alternate destination 5) No answer timer 4. Record MDH	1 CID Blacklist 1) Blacklist destination 2) Black entry 2 Allowed numbers 3 Denied numbers 4 Call Progress Options 1) Outside line access code 2) Pause time 3) Fwd no answer timer	1 Admin Password 2 Delete Station VM Password 3 Database management 1) Load Defaults 2) DB Backup 3) DB Restore 4) System initialize 4 System S/W Version 5 System restart 1) System S/W upgrade 2) Base phone S/W upgrade 6 IP Info	1 Ring Type 2 LCD Display 3 VM Password 4 Alarm



### Note:

**SYSTEM ADMIN PASSWORD:** Should you set an ADMIN Password via Menu item 4, 1 on the LWS-BS menu, it is advised that you record this password somewhere safe should you forget this password. A service call is required if in fact you forget/lose this password.

For convenience you may record this password in the space provided below or on the last page of this manual.

SYSTEM ADMIN PASSWORD

### 2.12.2 LWS-WK Menus

Call Register	Sounds	Phone Register	Phone Settings
Missed Call Received Call Dialed Call Delete Call	Ringing Type Ringing Volume	Subscription Modify PIN Reset	Alarm Clock Display Contrast Set Lighting Set Language S/W Version Edit CO Code

## 2.13 System Capacities

The LWS system is presently available in one configuration as shown in the Table 2.13.1.

Table 2.13.1 LWS System Capacity Chart

DESCRIPTION	CAPACITY	Remark	
Stations	LWS-BS station	1	
	Wireless Terminal	7	6 (Simultaneously)
	FAX/SLT	1	
Line	3		
USB Host Port	1		
System Speed Dial	800 (200-999)	LWS-BS	
Voice Mail Box	240 minutes	Max. 3 Channel	
Allow/deny list	50/50		
Black call list	20		
System Received /Dialed call log	15/15	LWS-BS	
System Missed call log	900 pool	LWS-BS	

Table 2.13.2 Wireless Terminal Capacity

DESCRIPTION	CAPACITY	Remark
Phone book	60	
Phone Dialed call log	10	
Phone Received + missed call log	50	

## 3 OPERATION INSTRUCTIONS

### 3.1 Call Forward

#### Description

Users may have selected incoming calls re-routed to other stations or voice mail. Forward feature is applied to internal calls, auto answering line calls, & normal line calls with ring assigned only to one station.

#### Operation

##### To activate Call Forward:

##### LWS-BS station

1. Press the **[Forward]** soft button.
2. Select forward type. ("Uncondition", "Busy", "No Answer", "Busy/No Ans")
3. Select station number or VM.
4. Press **[Save]** soft button.

##### Wireless Terminal

1. Press **[Talk]** key in GDC-400H/450H or **[Speaker]** button in LWS-WK.
2. Dial {Call Forward} code (ex. 554).
3. Dial forward type (1:Unconditional, 2:Busy, 3:No Answer, 4:Busy/No Answer)
4. Dial station number or {VSF/VM access} code

##### To deactivate Call forward:

##### LWS-BS station

1. Press the **[Forward]** soft button in forward state.
2. Select "OFF" in forward type.
3. Press **[Save]** soft button.

##### Wireless Terminal

1. Press **[Talk]** key in GDC-4XX or **[Speaker]** button in LWS-WK.
2. Dial Call Forward code (ex. 554).
3. Dial '#' to cancel Call Forward.

#### Conditions

1. A station receiving a forwarded call can transfer the call to the forwarding station.
2. Calls cannot be forwarded to a station in DND; if attempted, an error tone is returned.
3. Call Forward status is maintained in the system's non-volatile memory for protection from power outage.
4. Forward feature isn't applied to SLT/Fax port.
5. A station can't forward to DND station.
6. If a line isn't auto an answering type and has 2 or more ring assigned stations, the call from the line isn't forwarded to the forwarded destination of ring assigned stations.
7. If the line has one ring assigned station, the call from the line can forward to forwarded destination of the ring assigned station.
8. A station in DND can't forward.

## 3.2 Call Pick-up

### 3.2.1 Directed Call Pick-Up

#### Description

A station may answer incoming and transferred intercom, line calls ringing at another station (Call Pick-Up). All ringing calls are subject to Directed Call Pick-up except Queue Callbacks.

#### Operation

To Pick-up a call ringing at another station:

##### LWS-BS station and LWS-WK

1. Lift the handset or press **[Speaker]**.
2. Dial **{Directed Call Pick-up}** code(ex.\*7).
3. Dial the ringing station's intercom number.

OR

##### GDC-400H/450H

1. Press  ([Talk] key).
2. Dial **{Directed Call Pick-up}** code(ex.\*7).
3. Dial the ringing station's intercom number.

#### Conditions

1. Queue callback calls are not subject to Call Pick-up; any attempt will receive an error tone.

### 3.2.2 Group Call Pick-Up

#### Description

A station can answer (Call Pick-Up) incoming and transferred intercom, line calls ringing at another station. All ringing calls, except Queue Callbacks, are subject to Pick-up by other stations.

#### Operation

To Pick-up a call ringing at another station:

##### LWS-BS station and LWS-WK

1. Lift the handset or press **[Speaker]**.
2. Dial the Group Call Pick-up code (ex. \*\*).

##### GDC-400H/450H

1. Press  ([Talk] key).
2. Dial the Group Call Pick-up code (ex. \*\*).

#### Conditions

1. Queue callback calls are not subject to Call Pick-up; any attempt will receive an error tone.
2. When several calls are ringing simultaneously, Call Pick-up will connect the first-in, highest priority call. Call priority order is: Line transferred call > Line hold-recalled call > Line incoming call > queued call.

## 3.3 Call Transfer

#### Description

Line calls can be transferred to other stations in the wireless SOHO system. Calls can be transferred announcing the call (screened) or without an announcement (unscreened).

When a Line call is transferred, the Transfer Recall Timer (30sec) is initiated. If the timer expires before the call is answered, the Hold Recall process is initiated.



Users can transfer an active Intercom call to other stations in the wireless system, using either screened or unscreened transfer. When used, the Intercom station is placed on Exclusive Hold, and the Transfer Recall timer is initiated. If the timer expires before the Intercom call is answered, the call will bounce back (recall) to the transferring station until answered or abandoned.

#### Operation

##### *While on a call, to perform a Screened Call Transfer:* LWS-BS station and LWS-WK

1. Press **[Trans]**.
2. Dial the station to receive the transfer.
3. When answered, announce the call.
4. Hang-up to complete the transfer.



##### GDC-400H/450H

1. Press  (**[Navigation right]**) shorter than 1 second.
2. Dial the station to receive the transfer.
3. When answered, announce the call.
4. Press  (**[End]** key) to complete the transfer.

##### *While on a call, to perform an Unscreened Call Transfer:* LWS-BS station and LWS-WK

1. Press **[Trans]**.
2. Dial the station to receive the transfer.
3. Hang-up to complete the transfer.

##### GDC-400H/450H

1. Press  (**[Navigation right]**) shorter than 1 second.
2. Dial the station to receive the transfer.
3. Press  (**[End]** key) to complete the transfer.

#### Conditions

1. The transferring station may camp a call at a busy station (refer to Camp-On).
2. A station in DND or out-of-service can't receive a transfer; any attempt will result in an error tone.

### 3.4 Call Waiting/Camp-On

#### Description

Call Waiting is used to notify a busy station that a call is waiting. The busy station is notified of the waiting call with a Camp-On tone.

After receiving a busy signal, the calling station camps on to the called station. The called station can respond by:

- answering the waiting call, which places the active call on hold,
- activating One-Time DND, or
- ignoring the Camp-On tone.

#### Operation

**To activate a Camp-On while receiving the Intercom busy tone:**

1. Press the "\*" button, called and calling stations receive Camp-On tone.

#### Conditions

1. The user may only Camp-On to a station in busy mode; a user may not Camp-On to a station in DND, a conference, etc.
2. If the calling station disconnects from the call after activating Camp-On, Camp-On is cancelled.
3. A Camp-On tone is sent each time the calling user presses the "\*" button.

### 3.5 LINE Access

#### Description

Stations can access outgoing lines. The LWS-BS station and LWS-WK may use flexible buttons assigned to access a specific line button for outgoing calls.

#### Operation

**To place an outgoing Line call:**

**LWS-BS station and LWS-WK**

1. Lift the handset or press the **[Speaker]** button.
2. Press desired **{LINE}** button, dial the {line access} code or {Individual Line Access} code.

**GDC-400H/450H**

1. Press  (**[Talk]** key).
2. Dial the {Line access} code or {Individual Line Access} code.

**To answer an incoming Line call:**

**LWS-BS station**

1. Lift the handset or press the **[Speaker]** button. Or,
2. Press flashing **{LINE}** and lift the handset to speak privately.

**LWS-WK**

1. Lift the handset or press the **[Speaker]** button.  
LWS-WK, does not support answering the incoming call by pressing {Line}/{Station} button in ringing state.

**GDC-400H/450H**

1. Press  (**[Talk]** key).

### 3.6 Three-Party Voice Conference

#### Description

The system will allow three internal and external parties to be connected on a conference call. An unlimited number of 3-party conferences may be established. Only the LWS-BS station may initiate a conference call. If the base station hangs up, the conference will be terminated.

#### Operation

**To establish an ad-hoc conference call:**

**LWS-BS station**

1. Establish first call.
2. Press the **[Conf]** soft button; and the connected party is placed on exclusive hold.
3. Place second call.
4. When connected, press **[Conf]** soft button to establish 3-party conference.

#### Conditions

1. There is no limit on the number of 3-way conferences the system will support.
2. If the system receives a disconnect signal and no internal parties remain in the conference, the conference is terminated and all parties are disconnected. If an internal party is still connected when a disconnect signal is received, the connection to remaining parties is maintained.
3. A station that is busy, in DND or other non-idle state cannot be added to a conference.

### 3.7 Directory

#### Description

A name of up to 12 characters, may be assigned to each Station and System Speed Dial. When assigned, a user of LWS-BS may place an external call to a Station or System Speed Dial using the name.

#### Operation

##### To use Dial by Name:

##### LWS-BS phone

1. Press the **[Directory]** soft button
2. Select "Station directory" or "System directory".
3. Select desired name and press **[Send]** soft button

To toggle between the name and number display:

1. Press the **[Select >]** soft button
2. Press the **[Name/Tel]** soft button.

#### Conditions

1. The LCD will display multiple names (one per LCD line, up to 12 characters).
2. If a user selects a directory with no entries or there is no match to the user entry, error tone is provided.

### 3.8 DND(Do Not Disturb)

#### Description

A station can be placed in DND to block incoming Line and Intercom calls and transfers.

#### Operation

##### To activate DND:

##### LWS-WK

1. Press the **[DND]** button; the **[DND]** button LED illuminates.

##### GDC-400H/450H

1. Press  (**[Talk]** key).
2. Dial **{DND}** code (ex.553).

##### To remove DND:

##### LWS-WK

1. Press the **[DND]** button; the **[DND]** button LED extinguishes.

##### GDC-400H/450H

1. Press  (**[Talk]** key) on DND state.

2. Dial **{DND}** code (ex.553).

#### Conditions

1. DND service is not available to the LWS-BS station.
2. Recalls for Line calls will override the DND feature.
3. A station in DND is bypassed by calls forwarded to the station; if the last station in a Call Forward chain is in DND, the call will ring to the previous station in the chain.
4. When calling a station in DND, the station display will indicate the DND status.
5. The forwarding station can't activate DND feature.
6. The station forwarded from the LWS-BS station can't activate DND feature.

### 3.9 Headset Compatibility

#### Description

##### the LWS-BS station

The **[Headset]** button may be used only to select the mode between headset and speakerphone in idle state. In busy/talk state, the switchover between headset and speakerphone isn't supported. In the headset mode, pressing the **[Speaker]** button will send audio to the Headset instead of the speakerphone.

##### LWS-WK

By pressing **[Headset]**, the user can use the headset, immediately.

In talk mode with headset, if the user presses the **[Speaker]** button, the user can talk with the speakerphone.

#### Operation

##### LWS-BS station

##### To select Headset mode:

1. Press the **[Headset]** button.
2. The LED of **[Headset]** button is turned on.

##### To place/answer calls using the headset:

1. Press the **[Speaker]** with the phone in Headset mode.

##### LWS-WK

##### To place/answer calls using the headset:

1. Press the **[Headset]** button.

## 3.10 Hold

### 3.10.1 Hold

#### Description

Lines may be placed in a waiting state such that other stations on the system are able to access the Line. If the call remains on hold at expiration of the System Hold Recall Timer, normal Hold Recall will be activated.

#### Operation

##### To place a call on System Hold: LWS-BS station and LWS-WK

1. Press the **[Hold]** button.



##### GDC-400H/450H

1. Press  (**[Navigation right]**) longer than 1 second.

##### To access a call from System Hold: LWS-BS station and LWS-WK

1. Press the **{LINE}** button.
- OR
1. Lift the handset or press the **[Speaker]** button.
  2. Dial **{Held Individual LINE Access}** code (ex. 8#).
  3. Dial the Line number (01-03)
- OR
1. Lift the handset or press the **[Speaker]** button.
  2. Dial **{Held Line Access}** code (ex. 8\*).

##### GDC-400H/450H

1. Press  (**[Talk]** key).
  2. Dial **{Held Individual LINE Access}** code (ex. 8#).
  3. Dial the Line number (01-03)
- OR
1. Press  (**[Talk]** key).
  2. Dial **{Held Line Access}** code (ex. 8\*).

#### Conditions

1. When a Line is placed on System Hold, the button LED will flash (it will flash at the holding station and will flash at all other stations).
2. A call on System Hold can be retrieved from any station allowed access to the Line in the system database using the Line button or the Held Line call access code.

### 3.10.2 Hold Recall

#### Description

When a user places a Line call on hold, a hold timer is activated. If the timer expires, the held call will recall at the station for the I-Hold Recall time (30sec). If the call remains unanswered, the call is placed on System Hold and the LWS-BS station also receives a recall for the Attendant Recall time (1min). If still unanswered after the Attendant Recall time, the Line call is disconnected and the appropriate circuits are returned to idle.

#### Operation

Hold Recall operation is automatic.

### 3.10.3 Automatic Hold

#### Description

While on an active Line call, the system will place the call on hold automatically if the user presses the **{Station/Line}** button. In this case, pressing a **{Line}** button while on a Line call will place the active call on hold and access the selected Line.

#### Operation

##### To use Automatic Hold while on an active Line call: LWS-BS station

1. Press the desired feature button or **{ Line }** button; the active call is placed on Hold.

#### Conditions

1. There is no limit on the number of calls that can be placed on Hold using Automatic Hold.

## 3.11 CID Blacklist

#### Description

The system can employ caller number to determine the routing of incoming external calls. The system will compare the received caller number to entries in the CID Blacklist, and if a match is found, will route the call to the Voice mail of base station or disconnect the call.

#### Programming

CONFIGURATION	Blacklist destination – [Menu] + 3 1 1
	Blacklist entry – [Menu] + 3 1 2

### 3.12 Allowed/Denied Number

#### Description

Allow/Deny list has 50 codes and each code can contain up to 20 Digits.  
This list is applied to the user with Outside Line access restrict (Menu + 1 5 1).  
As digits are dialed, they are compared to entries using the following rules to allow or deny the call.

- Rule 1 – If a table has no entries, no restrictions are applied.
- Rule 2 – If there are only Deny entries, restrictions are provided as Deny only.
- Rule 3 – If there are only Allow entries, restrictions are provided as Allow only.
- Rule 4 – If there are both Allow and Deny entries, the Deny entries are searched. If the dialed number matches a Deny entry, the call is restricted; if no match is found the call is allowed.

#### Programming

CONFIGURATION	Outside Line Access Restrict	– [Menu] + 1 5 1
	Allowed Numbers	– [Menu] + 3 2
	Denied Numbers	– [Menu] + 3 3

### 3.13 MOH (Music-On-Hold)

#### Description

When a call is placed on hold, the system will deliver a recorded message from VSF. In this way, the connected user can determine that the connection is still active.

The base station records the VSF message for MOH. If a message isn't recorded, the default MOH will be delivered.

#### Operation

##### LWS-BS station

To record a VSF message for MOH:

1. Press the [Menu] button.
2. Dial 2 4.
3. Dial '#'.
4. After the record prompt and beep-tone, record message.
5. Press the [Save] button to stop recording and save the message.

### 3.14 Speed Dial

#### 3.14.1 Display Security

##### Description

Individual and Common Speed Dial numbers may be programmed so that the digits are not displayed on the LCD of the LWS-BS station.

##### Operation

1. To assign Display Security to a Speed Dial number:
2. Dial "\*" as the first digit of the Speed Dial number.

##### Conditions

1. The number is displayed when programming a Speed Dial number.
2. Display Security is provided on all Line calls including calls that are transferred or recall.

#### 3.14.2 Station Speed Dial

##### Description

The LWS-BS station can store commonly dialed numbers for easy access using Station Speed Dial bins. The base station has access to 20 Speed Dial numbers.

##### Operation

To dial using an Station Speed Dial:

1. Lift handset or press the [Speaker] button.
2. Press the [Directory] button.
3. Press the [Speed] button.
4. Dial the desired bin number (00–19).

To program an Individual Speed Dial number:

1. Press the [Directory] button.
2. Press the [Speed] button.
3. Press the [Add] button.
4. Dial the Speed Dial bin number (00-19).
5. Press the { Line } button or dial the Line access code (ex. 9, 8801 ~ 8803).
6. Dial the number to be stored.
7. Press the [Save] soft button.
8. If desired, enter a name.
9. Press the [Save] soft button.

##### Conditions

1. Accessing an empty Speed Dial bin will return an error tone.
2. All Speed Dial numbers stored in memory are protected from power loss.
3. A name can be entered for a Speed Dial number to permit access from the Directory.



### 3.14.3 System Speed Dial

#### **Description**

---

Commonly dialed numbers can be stored by the LWS-BS station. Up to 800 System Speed Dial numbers are available. Each Speed Dial number can be up to 23 characters in length and may include special instruction codes.

#### **Operation**

---

##### **To dial using a System Speed Dial:**

1. Lift handset or press the **[Speaker]** button.
2. Press the **[Directory]** soft button.
3. Press the **[Speed]** soft button.
4. Dial the desired bin number ('200'-999').

##### **To program a System Speed Dial number: LWS-BS station**

1. Press the **[Directory]** soft button.
2. Press the **[Speed]** soft button.
3. Press the **[Add]** soft button.
4. Dial the Speed Dial bin number (200-999).
5. Press the **{ Line }** button or dial the Line access code(ex.9, 8801 ~ 8803).
6. Dial the number to be stored.
7. Press the **[Save]** soft button.
8. If desired, enter a name.
9. Press the **[Save]** soft button.

#### **Conditions**

---

1. Accessing an empty Speed Dial bin will return error tone.
2. All Speed Dial numbers are stored in memory protected from power loss.
3. A name can be entered for a Speed Dial number to permit access from the Directory.
4. If a Speed Dial number contains a "Dial-Tone Detect" command, Flash as the first entry in the bin, and dial-tone detect is enabled for the Line, the system must detect dial-tone before dialing the Speed Dial number.

### 3.15 VSF Integrated Auto Attendant/Voice Mail

#### 3.15.1 VSF

##### **Description**

---

The Voice Store & Forward (VSF) unit, which is equipped in the wireless SOHO, provides the system memory to support the integrated Auto Attendant, Voice Mail and system announcement applications available in the System. The memory is employed to store Auto Attendant announcements, voice mail, greetings and messages, and various system prompts.

The VSF has a storage capacity of up to 279 minutes of announcement and message storage.

#### 3.15.2 Auto Attendant

##### **Description**

---

When a call comes into the system through a Line, the call may be routed to recorded VSF Announcements.

If the user dials a station number, the Auto Attendant will complete an unsupervised call transfer to the station.

##### **Operation**

---

##### **To record an Auto Attendant Announcement: LWS-BS station**

1. Press the **[Menu]** button.
2. Dial 2 3 2.
3. Dial '#'.  
4. After the record prompt and beep-tone, record message.
5. Press the **[Save]** soft button to stop recording and save the message.

##### **To delete a recording:**

1. Press the **[Menu]** button.
2. Dial 2 3 2.
3. Press **[Delete]** soft button.

##### **Conditions**

---

1. If the external caller dials a station number and the station is busy or there is no answer, the call is routed by busy/error/no answer (Exception) destination (menu 2 3 4).
2. No answer routing time is set by the No answer Timer (Menu + 2 3 5).
3. The greeting is played by retry count (menu + 2 3 3).
4. The auto attendant feature isn't applied to Tel/Fax Line(Menu 1 3 1). In Tel/Fax" Line, after fax tone detection time, the call goes to ring assigned stations.

### 3.15.3 VSF Voice Mail

#### 3.15.3.1 Message Storage

##### Description

When a station activates Call Forward to the VSF Group, a call is transferred to a VSF mail box. The caller connects to the called station's User Greeting followed by a beep tone.

The remote caller can record a message and hang-up or dial \*\* for further options. When disconnection occurs, the VM application stores the message in the called user's voice mail-box and activates the Message Waiting indication at the user's station.

##### Operation

###### Remote Caller

*To leave a voice message after hearing announcement:*

1. Wait for the beep, then leave a message.
2. Hang up to quit recording,

OR

2. Dial \*\* for more options.

##### Conditions

1. If all the VSF channels are in use, the Ring Back tone is provided until a VSF channel is available.
2. Individual User Greetings and Voice Mails are protected from AC power loss.

#### 3.15.3.2 Message Retrieval

##### Description

A user can access their Mail Box locally by placing a call to the VSF Voice Mail group, by pressing the **[MSG]** button, or by dialing VSF voice mail code(ex. 620)

Prompts are then received to guide the user in the Voice Mail Box operation. The user must enter a Mail Box number, generally the station number, and a corresponding password in response to the "Request for Password" ("Please enter your password code.") prompts.

If the user enters a valid and matching Mail box and password, the "Number of Messages" prompt ("You have xx new messages, You have yy saved messages.") is received. At this point, the user also receives the "VM long option prompt" ("To play new messages, press one, to play saved messages, press two, to set greeting or password, press eight, to disconnect, press pound, Press 0 for the operator, Press nine to hear this message again.").

When the user responds by dialing 1, the first new message is played. At the end of message playback, the "New Message option" prompt is played ("To replay message, press one, to listen to the next message, press two, to delete message, press three, to forward message, press four, to call the sender, press five, to skip message, press six, to return to main menu, press nine."). This process is repeated until the last new message is played and the "No Message" prompt ("No Messages") is played.

When the user dials 2 in response to the "Number of Messages" prompt, the first-saved message is played. At the end of the message, the "Saved Message option" prompt is played ("To replay message, press one,

to listen to the next message, press two, to delete message, press three, to forward message, press four, to call the sender, press five, to return to main menu, press nine."). This process is repeated until the last new message is played and the "No Message" prompt ("No Messages") is played.

In addition to the options indicated in the prompt, a user can record a memo, which is attached to the current voice mail by dialing the digit 7. The current voice mail and memo can then be forwarded to other Office Box users.

When the user dials 9 in response to the "Number of Messages" prompt or during or at the end of a message the "VM long Options" prompt is played.

##### Operation



###### LWS-BS station

1. Press **[Menu]** button.
2. Press 5 3.
3. If a current password exists, enter the station number and current password.
4. And press **[Save]** soft button.
5. Enter the station number and new password
6. Press **[Navigation down]** button.
7. Enter the station number and new password.
8. Press **[Save]** soft button.

###### LWS-WK

1. Press **[Speaker]** button.
2. Press {Change VM password} code (ex.559).
3. If a current password exists, enter the station number and current password.
4. And press **[Hold]** button.
5. Enter the station number and new password
6. Press **[Hold]** button in LWS-WK.

###### GDC-400H/450H

1. Press  (**[Talk]** key).
2. Press {Change VM password} code (ex.559).
3. If a current password exists, enter the station number and current password.
4. Press  (**[Navigation right]**) longer than 1 second.
5. Enter the station number and new password.
6. Press  (**[Navigation right]**) longer than 1 second.

###### *To remove password for voice mail forcibly:*

1. Press **[Menu]** button in LWS-BS station.
2. Press 4 2.
3. Select the station number with **[Navigation right/left]** button.
4. Press **[OK]** soft button.

###### *To retrieve Voice Mail locally:*

###### LWS-BS station

1. Lift the handset or press the **[Speaker]** button.

## Wireless SOHO Installation and Operation Manual



---

2. Dial **{Voice mail}** code(ex. 620).
3. Dial the Mail Box and corresponding password to receive the "Number of Messages" prompt.
4. Dial desired option code.
5. At completion of session, hang-up to return to idle.

### LWS-WK

1. Lift the handset or press the **[Speak]** button.
2. Dial **{Voice mail}** code(ex. 620).
3. Dial the Mail Box password to receive the "Number of Messages" prompt.
4. Dial desired option code.
5. At completion of session, hang-up to return to idle.

### GDC-400H/450H

1. Press  (**[Talk]** key).
2. Dial Voice mail code(ex. 620).
3. Dial the Mail Box password to receive the "Number of Messages" prompt.
4. Dial desired option code.
5. At completion of session, Press  (**[End]** key) to return to idle.

### Conditions

---

1. Messages are retrieved in LIFO (Last in First out) order.
2. The default password for voice mail is '\*'.
3. If the user removes his password for voice mail, the user can't enter his voice mail box.
4. If the user has lost his password for voice mail, first force remove password at LWS-BS station and change password at his phone.(refer to operation)

#### 3.15.3.3 Message Retrieval Options

##### Description

---

The user may dial the digit 9 to receive the "VM Long Options" prompt while in the Voice Mail Box, including during or after a voice message or system prompt, except when an option has been selected that requires user dialing. Some options involving user dialing include the Message Retrieval Option 1/2 (Play New/Saved Message), 7 (Cancel or Forward message, Remote Access Only) or 8 (Mail Box settings), refer to Table. The "VM long Options" prompt is:

*"To play new messages, press one, to play saved messages, press two, to set station forwarding, press seven (This option is available only for remote access), to set greeting or password, press eight, to disconnect, press pound, Press 0 for the operator, Press nine to hear this message again."*

The VSF Voice Mail will respond to incoming digits as shown in the following table.

Digit	Function
1	Play New MSG
2	Play Saved MSG
7	Set Cancel/Fwd, available only for remote access
8	Mail Box Setting, "Mailbox Settings" prompt
9	VM Long options
#	Drop, "Goodbye"
0	Attd Call, Call to Attendant.

## Wireless SOHO Installation and Operation Manual

---

### Operation

---

To access a Message Retrieval option

At any time after the "Number of Messages" prompt, dial a Message Retrieval Option digit. The system initiates the selection providing any needed prompts.

### Conditions

---

1. If the user remains off-hook after a call placed through the voice mail is complete, the user will be returned to the previous place in the Voice Mail Box. If the user hangs up, the VSF will recall at the user Station, and upon answer will play "Request Mail Box Number" prompt.

#### 3.15.3.4 Voice Mailbox Settings

##### Description

---

The user can program the Mail Box settings for their mailbox including a security password and a greeting. When a user presses "8" while retrieving messages, the "Mailbox Setting" prompt, (*"To edit your greeting, press one, to edit you password, press two. To return to main menu, press nine"*).

### Operation

---

To program Mail Box settings while "in" the Voice Mail Box:

Press '8', for Mail Box settings; the "Mail Box Setting" prompt is received.

##### To enter a new password:

1. Dial '7' to receive the "Password Entry" prompt (*"Please enter your new password and press pound when finished."*).
2. Dial new password.
3. Press '#'; the "Reenter Password" prompt will be heard (*"Please re-enter your password to confirm and press pound when finished."*).
4. Dial new password again.
5. Press '#' and the "Password Confirmation" prompt will be heard (*"Your password is saved."*).

##### To create a new greeting:

1. Dial '4' to hear the "Greeting Option" prompt (*"To listen to your current greeting, press five to record a new greeting, press seven, to return to the main menu, press nine."*).
  2. Dial '5', to hear your greeting.
- OR
3. Dial '7' to hear the "Record Greeting" prompt (*"At the tone, record your new greeting, press # when done."*).
  4. After the beep, record your desired greeting speaking in a normal voice.
  5. Press '#' and receive the "Greeting Confirmation" prompt (*"Your greeting is saved."*).

##### To adjust Mail Box Settings:

1. Dial '9' to hear the "Mail Box Setting prompt" (*"To edit your greeting, press one, to edit you password, press two, to return to main menu, press nine"*).

### Conditions

---

1. If the dialed number is not recognized, the "Invalid Entry" prompt is played.

## Wireless SOHO Installation and Operation Manual

---

2. The user must assign a password (Authentication code, up to 12 digits) before access to the mailbox will be allowed.

### 3.15.3.5 Call Forward from VM

#### **Description**

---

External users can activate or deactivate Call Forward for their station. Pressing '7' while retrieving messages will return the "Mailbox Set Forward" prompt, ("To forward calls to another extension, press one. To cancel forwarding, press 2 to return to the main menu, press nine.").

#### **Operation**

---

1. To activate Call Forward while in the VM:
2. Press '7', for Mail Box set forward, the "Mail Box Set Forward" prompt is received.

#### **To activate Call Forward:**

1. Dial '1' and receive the "Password Entry" prompt ("Please enter the number to forward to ...").
2. Dial the Station Number as follows:
  - To forward to another station, dial the station number.

#### **To deactivate Call Forward:**

1. Dial '2' and receive the "Station forwarding is canceled" prompt.

#### **To return to the Main menu:**

1. Dial '9' and receive the "Mail Box Settings" prompt.

#### **Conditions**

---

1. If the user is external, the user must begin dialing within and dial subsequent digits within the VSF Inter-Digit Timer; if not, the call is released.
2. This Mail Box Set Forward is only available for external users.

## 3.16 Wake-Up Alarm

#### **Description**

---

This feature allows a user to set a wake-up time or desired time to be alerted. When the time is reached, the system will signal with an audible and visual signal.

#### **Operation**

---

#### **To register Wake-Up:**

##### **LWS-BS station**

1. Press the [Menu] button.
2. Dial 5 4.
3. Select "Single" or "Continuous"

## Wireless SOHO Installation and Operation Manual

---

4. Dial 2-digit hour and 2-digit minute for alerting.
5. Press [Save] button.

#### **To erase Wake-Up:**

##### **LWS-BS station**

1. Press the [Menu] button.
2. Dial 5 4.
3. Select "OFF".
4. Press [Save] button.

#### **Conditions**

---

1. The Wake-up alarm Ring signal is 30 seconds, On/90 seconds, Off (3 times). If no action is taken by the user, the ring signal is given to the Attendant with a display designating the station number that did not respond.
2. Time (hh:mm) must be entered in the Military 24-hour format.
3. The daily alarm will reset and repeat each day until erased (cancelled) the One-time alarm will reset and cancel automatically.

## 3.17 Intercom Call (ICM Call)

#### **Description**

---

A non-blocking ICM is available to all stations in the system. Users may place an intercom call to other stations in the system by dialing applicable digits as defined in the system Numbering Plan.

#### **Operation**

---

#### **To place an intercom call:**

##### **LWS-BS station and LWS-WK**

1. Lift the handset or press the [Speaker] button to receive ICM dial tone.
2. Dial station number or press the {Station} button.
3. For ring-back tone, await answer.

##### **GDC-400H/450H**

1. Press  ([Talk] key) to receive ICM dial tone.
2. Dial station number.
3. For ring-back tone, await answer.

#### **Conditions**

---

1. Intercom Dial tone will time-out if action is not taken within Dial-Tone Time or, if the time between digits exceeds the Inter-digit Timer; error tone is received on dial tone time-out.
2. ICM Dial tone is halted after dialing the first digit.
3. If the called station is busy, Intercom Busy tone is provided for the Busy Tone time (7 sec.) then, Error tone is sent by the system; the caller may disconnect or activate a feature such as Message Wait/Callback.

### 3.18 Intercom Call Hold

#### Description

---

While on an active ICM Call, Users can place the ICM Call on hold; the held station will receive the assigned MOH. The call is placed on Exclusive Hold and recalls at the holding station after the station returns to idle.

#### Operation

---

**To place an active ICM call on hold:**  
**LWS-BS station and LWS-WK**

1. Press the **[Hold]** button.

#### GDC-400H/450H

1. Press  (**[Navigation right]**) longer than 1 second;

**To retrieve the held ICM call:**  
**LWS-BS station and LWS-WK**

1. Press the **{Station}** button associated with the held station.

#### GDC-400H/450H

1. Dial a station number of held station;

#### Conditions

---

1. Only one ICM call may be placed on hold at a time.

### 3.19 Line Ring Assignment

#### Description

---

Each station in the system can be programmed to provide an audible signal when the system detects an incoming call on specified Lines.

#### Operation

---

**To set "Line ring assignment":**  
**LWS-BS station**

1. Press **[Menu]** button.
2. Dial 1 3 2.
3. Select a Line.
4. Press the button of desired station and LED of button is turned on.
5. Press **[Save]** button.

#### Conditions

---

1. A busy station receives the Muted ring or Call Waiting tones (as appropriate) for the station's off-hook ring assignment. In Night/weekend mode, Line ring assignment is disabled.
2. In case of DECT type station, maximum 6 DECT type station can be assigned each line.

### 3.20 Night/Weekend mode

#### Description

---

In night/weekend mode, a specific station is assigned as ring destination of all call from Line.

#### Operation

---

##### LWS-BS station

**To activate night/weekend mode:**

1. Press **[DND]** button.
2. Select the ring destination.
3. Press **[Save]** soft button. Then DND LED is turned on.

**To deactivate night/weekend mode:**

1. Press **[DND]** button in night/weekend mode.
2. Select "OFF".
3. Press **[Save]** soft button. Then DND LED is turned off.

#### Conditions

---

1. In night/weekend mode, the DND LED of base station is turned on.
2. If the LWS-BS station is in forwarding to other station, the user can activate/deactivate the night/weekend mode in the forwarded station.

### 3.21 Call Log Display

#### Description

---

The LWS-BS station can view a log of incoming, outgoing and missed calls on the display and place a call with call log.

#### Operation

---

##### LWS-BS station

**To place a call with Call Log:**

1. Press the **[Call log]** soft button.
2. Select "received" or "dialed" or "missed".
3. Select the desired number and press **[Send]** soft button.

**To delete Call Log:**

1. Press the **[Call log]** soft button.
2. Dial 4.
3. Select the option and press **[OK]** soft button.

### Conditions

1. Maximum count of Received and Dialed call log is 15 each.
2. Missed call has 900 pools. So, 900 missed call can be saved. If the pool is full of the 900 missed call log, the new missed call log can't be saved.
3. Missed call can be saved to speed dial, but received/dialed call can't be saved to speed dial.

## 3.22 Mute

### Description

The user can turn off audio transmission from the handset, speakerphone or headset microphone (Mic Mute).

### Operation

#### LWS-BS station

##### To Mute the Microphone:

1. Press the **[Mute]** button; the [Mute] button LED illuminates, the microphone (Handset, Speakerphone, Headset) is muted, and the connected party receives silence.

##### To activate the microphone:

1. Press the illuminated **[Mute]** button; the **[Mute]** button LED extinguishes, and the microphone is activated, transmitting audio to the connected party.

## 3.23 Tel/Fax Line

### Description

If Tel/Fax Line Mode (Menu 1 3 1) is selected, the system will detect a FAX tone within the fax tone detection time. After detecting FAX tone, the system sends the call to the SLT/FAX port to respond to it. If a FAX tone is not detected within the fax tone detection time, the system will transfer the call to the ring assigned stations for that particular Tel/Fax line.

### Operation

#### To set Tel/fax line:

##### LWS-BS station

1. Press the **[Menu]** button.
2. Dial 1 3 1.
3. Select "Tel/Fax" with [Navigation right/left] button.
4. Press **[Save]** soft button.

### Conditions

1. The fax tone detection time is 10 seconds.
2. The auto attendant feature isn't applied to Tel/Fax Line.

## 3.24 Feature Code for LWS-BS

### Description

User can access Feature Code unlocking several functions.

- NZ

Feature	Code	Remark
Intercom Call	700-708	
Group Call Pickup	*1	
Direct Call Pickup	*42	
Individual Line Access	48 XX	XX : 01 ~ 03 (line number)
Line Access Code	1	
VSF/VM access code	620	
Access individual held line	4# XX	XX : 01 ~ 03 (line number)
Access held line	4*	

- Other countries

Feature	Code	Remark
Intercom Call	100-108	
Group Call Pickup	**	
Direct Call Pickup	*7	
Individual Line Access	88 XX	XX : 01 ~ 03 (line number)
Line Access Code	0	
VSF/VM access code	620	
Access individual held line	8# XX	XX : 01 ~ 03 (line number)
Access held line	8*	

### 3.25 Feature Code for LWS-WK

#### Description

User can access Feature Code unlocking several functions.

- NZ

Feature	code	Remark
Intercom Call	700-708	
DND	553	
Call Forward	554	
Change VM password	559	
Group Call Pickup	*1	
Direct Call Pickup	*42	
Individual Line Access	48 XX	XX : 01 ~ 03 (Line number)
Line Access Code	1	
VSF/VM access code	620	
Access individual held Line	4# XX	XX : 01 ~ 03 (Line number)
Access held Line	4*	
Attendant code	0	

- Other countries

Feature	code	Remark
Intercom Call	100-108	
DND	553	
Call Forward	554	
Change VM password	559	
Group Call Pickup	**	
Direct Call Pickup	*7	
Individual Line Access	88 XX	XX : 01 ~ 03 (Line number)
Line Access Code	0	
VSF/VM access code	620	
Access individual held Line	8# XX	XX : 01 ~ 03 (Line number)
Access held Line	8*	
Attendant code	9	

## 4 USEFUL INFORMATION

### 4.1 Trouble shooting

If you experience any problems with the normal use of your phone, you should first power-off and disconnect the battery. Then connect it again, and connect the power again. If the phone continues to have problems, please check the following Table before contacting the Customer Service center.

PROBLEM	POSSIBLE CAUSE	SOLUTION
There is no dial tone	<ul style="list-style-type: none"> <li>Is the telephone line cord correctly plugged into the base and telephone socket?</li> <li>Is the Terminal registered to the base?</li> </ul>	<ul style="list-style-type: none"> <li>Check that the base is connected to the main power source and the battery is properly installed.</li> <li>If you try to make a call and the terminal is not registered, the display shows 'Out of Range'.</li> </ul>
Cannot make or receive calls	<ul style="list-style-type: none"> <li>Are the Handset batteries charged?</li> </ul>	<ul style="list-style-type: none"> <li>If the battery symbol shows empty then replace the handset on the charger and let it charge for a few hours.</li> </ul>
Terminal does not ring	<ul style="list-style-type: none"> <li>Have you set the terminal ringer volume to Volume Off?</li> </ul>	<ul style="list-style-type: none"> <li>You can set the ringer volume for LWS-BS, Wireless Keyset and Handset. Verify if the ringer volume is set too low for you, and adjust if necessary.</li> </ul>
Cannot link up with the LWS-BS station	<ul style="list-style-type: none"> <li>Is "Range Out" display?</li> </ul>	<ul style="list-style-type: none"> <li>The LWS-BS power cable may not be connected. The AC power has failed and/or the batteries in the base could be low or flat; recharge or replace the batteries.</li> <li>Verify the antenna of the LWS-BS is attached tightly. Otherwise put it into the LWS-BS and turn it clockwise.</li> <li>Verify you are in range of the LWS-BS; move closer to the base if necessary.</li> </ul>
System Power failure	<ul style="list-style-type: none"> <li>Is the power connected well?</li> </ul>	<ul style="list-style-type: none"> <li>Check all connections</li> <li>If there is an AC power failure, you must re-connect the AC adapter to turn-on the system again.</li> </ul>

#### Note:

**SYSTEM ADMIN PASSWORD:** Should you set an ADMIN Password via Menu item 4, 1 on the LWS-BS menu, it is advised that you record this password somewhere safe should you forget this password. A service call is required if in fact you forget/lose this password.

For convenience you may record this password in the space provided below.

**SYSTEM ADMIN PASSWORD**

## NOTICE

This equipment has been tested and found to comply with the limits for a Class A digital device, pursuant to Part 15 of the FCC Rules. These limits are designed to provide reasonable protection against harmful interference in a residential installation. This equipment generates uses and can radiate radio frequency energy and, if not installed and used in accordance with the instructions, may cause harmful interference to radio communications. However, there is no guarantee that interference will not occur in a particular installation. If this equipment does cause harmful interference to radio or television reception, which can be determined by turning the equipment off and on, the user is encouraged to try to correct the interference by one or more of the following measures:

- Reorient or relocate the receiving antenna.
- Increase the separation between the equipment and receiver.
- Connect the equipment into an outlet on a circuit different from that to which the receiver is needed.
- Consult the dealer or an experienced radio TV technician for help.

This device complies with part 15 of the FCC Rules. Operation is subject to the following two conditions:

(1) This device may not cause harmful interference; and (2) This device must accept any interference received, including interference that may cause undesired operation.

**CAUTION :** Any changes or modifications in construction of this device which are not expressly approved by the party responsible for compliance could void the user's authority to operate the equipment.

## RF Exposure Statement:

This equipment complies with FCC RF radiation exposure limits set forth for an uncontrolled environment. Use of other accessories may not ensure compliance with FCC RF exposure guidelines. This device must not be co-located or operating in conjunction with any other antenna or transmitter. The changes or modifications not expressly approved by the party responsible for compliance could void the user's authority to operate the equipment.

### **GDC-450H :**

The tests are performed in positions and locations (e.g., at the ear and worn on the body) as required by the FCC for each model. The SAR value for this model handset when tested for use at the ear is 0.051 W/kg and when worn on the body, as described in this user guide, is 0.065 W/kg.

### **LWK-WK & LWS-BS :**

In order to comply with FCC RF exposure requirements the base station must be installed with a minimum separation distance of 20 cm from the antennas to the user or near by persons.