

SpeedLIGHT16 User Manual

Warning

Please read the warnings before you start operating the product. Make sure to have these precautions in mind before/during installation and operation of the product.



Qualification for installation

This product should be installed by personnel who is qualified for handling network devices and fiber communication devices, or who is a skilled engineer.



Inhibition of disassembly

Disassembling this product may cause injury of personnel or loss of property due to electric shock, failure, malfunction or static electricity. Disassembling, repairing or modifying the product at your own discretion will invalidate the warranty. If you need to repair the product, please contact Technical Support Center of LG-NORTEL.



Possible risks according to the installation location

In order to prevent impact on the product or the consequential damage of personnel or property, do not install or operate the product in the area with excessively hot or cold temperature, high humidity, excessive dust or vibration. Any water permeated into the product may cause damage to personnel or property due to electric shock or failure. Please make sure to use power supply that complies with the specifications of this product, and not to use unearthed or damaged cables. And check if the installation location and conditions meet the regulations on electric safety.



Inhibition of wearing personal ornaments

Do not wear any personal ornament such as ring, necklace or watch while handling this product. Any conductive metal may cause damage to personnel or property due to electric shock, static electricity or fire. Loose clothing, neck tie or slippers may also cause accidents during operation of the product.



Precaution on EMI

EMI will affect this product and cables, causing abnormal operation of the product due to disturbance of signal handling. Therefore, do not install or operate this product in areas that are susceptible to high levels of electromagnetic interference.



Precaution on lightning

Lightening may cause severe defect of the product. Check if there are any conditions that may lead to lightning damage. If there is a flash of lightning or any such event is expected, stop handling the product and do not touch the cable.



Precaution on electric shock

Do not touch the power supply if the power code is connected. Even when the power switch is in OFF position, electric current runs inside the product if the power code is connected to the power source.



Safety handling of laser

The BMU which is one of the components of this product, emits high-power laser radiation in the infrared wave range of 100 mW or higher. Therefore, do not stare at emission during operation of the product. Exposing your eye directly to the light is very dangerous. Make sure to wear safety goggles and also be careful not to expose your eyes to any reflected light. Check if the power is OFF on the BMU before connecting the optical connector.



FDA/CDRH Class IIIb and IEC® 60825 Class 3B laser product
All versions are Class 3B laser products per IEC 60825



CAUTION: Use of controls, adjustment, and procedures other than those specified herein may result in hazardous laser radiation exposure.



CAUTION (FCC STATEMENT)

Changes or modifications not expressly approved by the party responsible for compliance could void the user's authority to operate the equipment.

* NOTE: The OLT and ONT have been tested and found to comply with the limit for a Class A and Class B digital device, respectively, pursuant to Part 15 of the FCC Rules. These limits are designed to provide reasonable protection against harmful interference in a residential installation. This equipment generates, uses and can radiate radio frequency energy and, if not installed and used in accordance with the instructions, may cause harmful interference to radio communications. However, there is no guarantee that interference will not occur in particular installation, which can be determined by turning the equipment off and on, the user is encourage to try to correct the interference by one or more of the following measures:

- Reorient or relocate the receiving antenna
- Increase the separation between the equipment and receiver
- Connect the equipment into an outlet on a circuit different from that to which the receiver is connected
- Consult the dealer or an experienced radio/TV technician for help

*NOTE: The OLT and ONT comply with Part 15 of the FCC Rules. Operation is subject to the following two conditions: (1) the OLT and ONT may not cause harmful interference, and (2) the OLT and ONT must accept any interference received, including interference that may cause undesired operation.

Precautions in installing TurboLIGHT16

Check if you have received all the parts of TurboLIGHT16.

Select the location for installation of TurboLIGHT16.

In order to ensure performance and maintainability of TurboLIGHT16, install the product at safe distances from external devices for better ventilation and to prevent interference with each other.

Precautions in using VLAN ID 4095 in TurboLIGHT16

VLAN ID 4095 is used for In-band OAM in TurboLIGHT16 and thus should not be used for other purpose. Using this VLAN ID 4095 by user can affect the TurboLIGHT16 management function where it does not affect service data traffic.

Software update

You will be informed of software update, if any, via mail or e-mail.

Refer to “5.11 LiveUpdate” of this manual for further information on software updates.

Provisions of Warranty of LG-Nortel Co. Ltd.

Thank you for purchasing our product. If you find any defects in the product or have any problem in operating the product, **LG-Nortel Co. Ltd.** will provide free or charged replacement/repair depending on the whether the warranty is expired in accordance with the below-specified warranty provisions. If you want to request replacement or repair of the product, please contact the dealer where the product is purchased or any LG-Nortel' authorized agent, and request the service.

Object of warranty

This warranty is applied to any product supplied by **LG-Nortel Co. Ltd.**

Principle of warranty

This product can be disassembled, repaired or assembled only by personnel authorized by **LG-Nortel Co. Ltd.**, No maintenance work can be performed without the consent of **LG-Nortel Co. Ltd.**

Period of warranty

This warranty is valid for 12 months from the date of purchase. Any service provided after the expiration of the warranty period will be charged in accordance with the relevant regulations of **LG-Nortel Co. Ltd.** (If the warranty period is otherwise specified in the Agreement, warranty service will be provided for the period as specified in the Agreement.)

Free service:	Within 12 months from the date of purchase
Charged service:	After 12 months from the date of purchase

Exceptions of warranty

Following exceptions are applied to the warranty.

- The customer will pay for the service, even for defects occurring within the warranty period, if the defect is caused by force majeure including fire, explosion, lightning, earthquake or flood.
- The customer will pay for the service, even for defects occurring within the warranty period, if the defect is caused by negligence of the customer (inappropriate power supply, defects in the connected devices, etc.).
- No service will be provided for any defect caused by the maintenance work performed by any personnel not authorized by LG-Nortel Co. Ltd.

Liability of transportation

Any transportation cost incurred due to defects of the product found within the warranty period will be at the cost of **LG-Nortel Co. Ltd.** In this case, transportation of the repaired product for the customer will be at the cost of **LG-Nortel Co. Ltd.** The customer is responsible for any transportation costs after the warranty period is expired.

LG-Nortel Co. Ltd. takes no responsibility for delay in transportation and/or missing of the product during the transportation caused due to incorrect information provided by the customer at the request of service.

LG-Nortel Co. Ltd. will do its best to provide the customers with satisfactory products and after-sales services.

LG-Nortel Co. Ltd.

Copyright

Copyright of this manual belongs to LG-Nortel Co. Ltd.

Reproduction, distribution or revision of part or all of contents in this manual in any form without written permission of LG-Nortel Co. Ltd. is prohibited.

Registered Trademark

LG-Nortel,  **LG-NORTEL** are registered trademarks of LG-Nortel Co. Ltd.

Other products and company names mentioned herein this manual might be trademarks or trade names of their respective owners.

The results of using the information not mentioned in this manual or the risk of misunderstanding this document remain with the user.

The information in this manual is subject to change due to function enhancement, change of design, etc. If you want the modified manual or have any question on this manual, please contact us with information below:

**Address: Customer Support Center, LG Research Complex 1, 533 Hogue 1-dong, Dongan-gu,
Anyang-shi, Kyungki-do, South Korea**

Tel: 82-1588-9388

Revision History

Version	date of revision	reason for revision	Description
V1.0	2008/10	Initial	Initial Release

Table of Contents

Chapter1	Description	1-1
1	SYSTEM OVERVIEW	1-1
2	SPEEDLIGHT™ 16 PRODUCT CONFIGURATION.....	1-2
3	SPEEDLIGHT™ 16 PRODUCT PICTURES	1-3
Chapter2	SpeedLIGHT™ 16 Specification	2-1
1	SPEEDLIGHT™ 16 SPECIFICATIONS	2-1
1.1	System specification.....	2-1
1.2	Optical Line Terminal shelf : SL16-OLT	2-1
1.3	Optical Channel Unit (100M) : SL16-OCU-125	2-2
1.4	Broadband Light Source and Mux Unit : SL16-BMU	2-2
1.5	Main Control Unit : SL16-MCU	2-2
1.6	Fan shelf : SL16-OLT-Fan	2-2
1.7	Remote Node (RN) : SL16-RN	2-3
1.8	Optical Network Terminal (100M) : SL16-ONT-125	2-3
Chapter3	How to Install SpeedLIGHT™16.....	3-1
1	SPEEDLIGHT™ 16 UNITS PORT AND LED INFORMATION.....	3-1
1.1	SL16-MCU.....	3-1
1.2	SL16-BMU.....	3-2
1.3	SL16-OCU.....	3-3
1.4	SL16-ONT.....	3-4
2	SYSTEM INSTALLATION AND CONNECTIONS.....	3-5
2.1	SL16-OLT.....	3-5
2.2	SL16-RN	3-6
2.3	SL16-ONT.....	3-8
Chapter4	How to Operate the System using software	4-1
1	CAUTIONS IN SYSTEM OPERATION.....	4-1
2	INITIAL SETTING OF TERMINAL AND ACCESSING CONSOLE.....	4-1
3	GENERAL REQUIREMENTS FOR MANAGEMENT MODULE	4-1
4	OS UPGRADE	4-2
4.1	OLT upgrade.....	4-2
4.2	ONT upgrade	4-3
Chapter5	Managing System with CLI-1.....	5-1
1	BASIC OPERATION OF CLI.....	5-1
2	COMMAND SYSTEM.....	5-1
2.1	OLT	5-1
2.2	ONT	5-5
3	HOW TO USE COMMANDS	5-7
4	CLI COMMAND.....	5-9

5	SYSTEM ACCESS AND IP SETTING.....	5-10
5.1	System login.....	5-10
5.2	Auto logout.....	5-10
5.3	Create user ID and change password.....	5-11
5.4	Protect user password.....	5-11
5.5	Clear user password protection.....	5-11
5.6	Delete user ID.....	5-12
5.7	Change privilege password.....	5-12
5.8	Remote access.....	5-12
5.9	Manage remote user.....	5-13
5.10	Reboot system.....	5-13
5.11	Set system IP address.....	5-14
5.12	View system IP address.....	5-14
5.13	Delete system IP address.....	5-15
6	SYSTEM CONFIGURATION.....	5-16
6.1	Set basic information.....	5-16
6.2	Delete basic information.....	5-16
6.3	Set date and time.....	5-17
6.4	Show date and time.....	5-17
6.5	Set time-zone.....	5-17
6.6	Set NTP(Network Time Protocols) server.....	5-18
6.7	Delete NTP (Network Time Protocols).....	5-18
7	MANAGE SYSTEM CONFIGURATION.....	5-19
7.1	Show configuration in the memory.....	5-19
7.2	Show compact flash information.....	5-20
7.3	Save information.....	5-21
7.4	Clear information.....	5-21
7.5	Back up information.....	5-22
7.6	Back up current setting.....	5-22
7.7	Import backup copy of setting information.....	5-23
8	CHECK SYSTEM.....	5-24
8.1	Show system information.....	5-24
8.2	Show memory state.....	5-24
8.3	Show process information.....	5-25
8.4	Show Flash memory state.....	5-25
9	NETWORK MANAGEMENT.....	5-26
9.1	Check network connection state.....	5-26
9.2	Set routing table.....	5-26
9.3	Show routing table.....	5-27
9.4	Delete routing table.....	5-27
9.5	Add ARP table.....	5-27
9.6	Show ARP table.....	5-28
9.7	Delete address from ARP table.....	5-28
9.8	Delete all from ARP table.....	5-28
9.9	Show MAC table.....	5-29
10	SET SNMP.....	5-31
10.1	Set access to SNMP Agent.....	5-31
10.2	Delete password for SNMP Agent.....	5-32
10.3	Set ID for SNMP Agent.....	5-32
10.4	Delete ID for SNMP Agent.....	5-32
10.5	Set SNMP Trap-host.....	5-33
10.6	Set SNMP Trap type.....	5-33
10.7	Show SNMP setting.....	5-34
10.8	SNMP connection control function of ONT.....	5-35
11	SYSLOG MANAGEMENT.....	5-36
11.1	Set Syslog host.....	5-36
11.2	Set Syslog display.....	5-36
12	LOG MANAGEMENT.....	5-37
12.1	Show command log.....	5-37

12.2	Show system log and alarm log.....	5-37
12.3	Delete log	5-38
13	ALARM MANAGEMENT	5-39
13.1	Set alarm grade	5-39
13.2	Show alarm grade.....	5-41
13.3	Delete alarm grade	5-41
13.4	Set generate alarm level.....	5-42
14	SHOW BMU & PSU & FAN STATUS	5-43
15	BMU MANAGEMENT	5-44
15.1	Show BMU status	5-44
15.2	Set ALS	5-44
16	PSU MANAGEMENT	5-45
16.1	Show PSU status	5-45
17	FAN MANAGEMENT	5-46
17.1	Show FAN status.....	5-46
18	OCU MANAGEMENT	5-47
18.1	Show OCU status.....	5-47
18.2	Show OCU Packet Counter.....	5-50
18.3	Show average packet counter of OCU.....	5-56
18.4	Show TRx information of OCU	5-58
18.5	Show in-band ID of OCU	5-60
18.6	Control OCU.....	5-62
18.7	IPM function.....	5-62
18.8	Clear IPM	5-63
18.9	Remote reset	5-63
18.10	Set port speed.....	5-63
18.11	Clear port speed	5-64
19	ONT MANAGEMENT	5-65
19.1	Show status of ONT	5-65
19.2	Show ONT Packet Counter.....	5-65
19.3	Show TRx information of ONT	5-67
19.4	Show in-band ID of ONT	5-67
19.5	IPM function.....	5-68
19.6	Clear IPM	5-68
19.7	Set port speed.....	5-69
20	DCE MANAGEMENT	5-70
20.1	Show DCE information	5-70
20.2	Set DCE.....	5-71
20.3	Clear DCE	5-71
21	HELP	5-72

Chapter6 GUI-based EMS Operation Manual..... 6-1

1	OVERVIEW.....	6-1
1.1	Features	6-1
1.2	Characteristics.....	6-1
2	SYSTEM OPERATION.....	6-2
2.1	Network connection between PC and system.....	6-2
2.2	Installing EMS program	6-3
2.3	Recommended specifications of PC for EMS operation	6-4
2.4	Console and IP setting	6-4
2.5	Starting EMS	6-5
2.6	Interworking between EMS and system	6-6
2.7	EMS window	6-7
3	SYSTEM MANAGEMENT	6-11
3.1	Time setup	6-11

3.2	Device information.....	6-11
3.3	System reset.....	6-16
4	ALARM MANAGEMENT	6-17
4.1	System log data.....	6-19
4.2	Alarm report condition setting	6-20
4.3	Alarm view according to system grade.....	6-21
5	USER MANAGEMENT.....	6-23
5.1	User account management.....	6-23
5.2	Changing user password.....	6-25
6	DB MANAGEMENT	6-26
6.1	History view and search.....	6-27
6.2	Alarm data display	6-28
6.3	Real-time alarm print.....	6-29
7	CONFIGURATION MANAGEMENT	6-30
7.1	Optical signal setting.....	6-30
7.2	DCE information.....	6-32
7.3	Remote connection to system.....	6-33
8	LIKE CLI COMMAND	6-34
8.1	Show	6-34
8.2	Config->Set	6-35
8.3	Config->No	6-36
8.4	Clear.....	6-37
9	HELP	6-38
9.1	EMS information.....	6-38
9.2	System information	6-39
9.3	Unit LED description	6-40
9.4	Customer Support center	6-41
10	QUICK BUTTON.....	6-42
11	LIVEUPDATE.....	6-43
11.1	LiveUpdate menu.....	6-43
11.2	Update procedure.....	6-44
11.3	Reservation for update.....	6-47
11.4	Changing FTP server IP.....	6-48
12	EMS MENU	6-49
12.1	Main menus	6-49
12.2	Sub menus	6-49
Chapter7	Read before requesting service.....	7-1
Chapter8	Appendix A Acronyms.....	8-1

Introduction

The Best Choice

SpeedLIGHT16 are designed for the realization of high-speed access networks. The equipment enables symmetric and dedicated high-bandwidth optical data links to deliver services such as video, Internet and voice communications. Existing subscriber devices such as xDSL or cable-modems have limitations in distance and data rates. SpeedLIGHT16 are optimum solutions for complementing these limitations by enabling efficient and cost-effective optical connectivity for FTTC and FTTB network applications.

SpeedLIGHT16 are based on Dense Wavelength Division Multiplexing (DWDM) technology, which utilizes economical and efficient use of the outside fiber plant. The system realizes a stable high-speed service by adopting highly reliable passive optical components in the fiber network to connect the central office with the curb/building/pole/wall, with an independent optical communication channel delivered to each remote location. In addition, SpeedLIGHT16 system has the additional advantages in that it is compatible with the existing Ethernet LAN-based subscriber networks. Thus, SpeedLIGHT16 is economical Ethernet system that ensures high-performance, high-reliability and stable services without the need for data protocol conversion.

Thank you for purchasing SpeedLIGHT16.

Before you read this manual

This manual provides information for users on how to operate the SpeedLIGHT16 equipment. This manual is subject to version updates to meet any future modifications of SpeedLIGHT16. This manual describes the functions of SpeedLIGHT16 and how to install, use and manage the system.

Read this manual carefully before and/or during operation of the SpeedLIGHT16 systems.

If you wish to expand functions or to repair defects, make sure to contact the dealer or the Customer Service Center of LG-Nortel. If you have any query in operating SpeedLIGHT16 or find any defect, please contact the dealer or the Customer Service Center.

Chapter1 Description

1 System Overview

SpeedLIGHT16 system consists of Optical Line Terminals (OLT), Remote Nodes (RN) and Optical Network Terminals (ONT). A fiber trunk path is used from CO to the passive RN in the subscriber area. A fiber trunk path is used from the RN to each ONT. The ONT can be connected to an electrical switch for connectivity to multiple users. The ONT converts the optical signal from the OLT into an electric signal at the remote location. It also converts the electric signal into an optical signal for transmission to the OLT. The ONT is automatically allocated with a dense WDM optical wavelength for a dedicated and independent connection to the OLT.

The main optical components of OLT include the Broadband Light Source and MUX Unit (BMU) and the Optical Channel Unit (OCU). The OCU is connected with the subscriber aggregation switch (L3 Ethernet switch), which is the upper layer device, via the UTP cable, and with BMU in the lower layer via the fiber cable. The OCU is the CO media converter that converts the optical signal from the subscriber into the electric signal for the subscriber aggregation switch. It also converts the electric signal from the subscriber aggregation switch into the optical signal for the subscriber. MUX in BMU multiplexes the downlink signal and delivers it to the fiber trunk path.

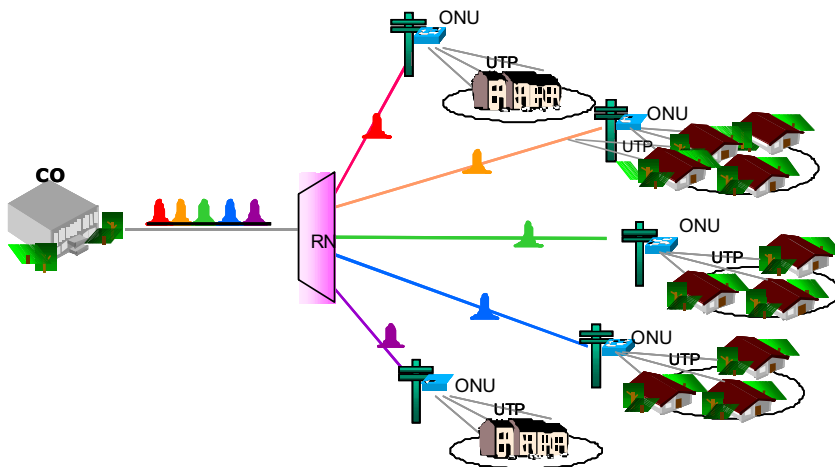

Figure 1-1 Concept of FTTC Service

The MUX also demultiplexes the upper link signal from the fiber trunk path, and delivers it to each OCU. If the OCU in the CO or the ONT at the remote location are connected to the system, the BLS allows automatic locking to the wavelength channel. Therefore, OCUs (or ONTs) are interchangeable with each other, irrespectively of the other assigned wavelength channels.

2 SpeedLIGHT™ 16 product configuration

SpeedLIGHT™16 Configuration

Position	SpeedLIGHT™16
OLT	OLT Shelf (including backplane and providing 2 PSU, 1 BMU, 1 MCU, 16 OCU slots
	SL16-PSU (2 units for redundancy)
	SL16-MCU
	SL16-BMU
	SL16-OCU-125
	SL16-OLT-FAN
RN	RN AWG
	RN Enclosure
ONT	SL16-ONT-125
	(100 / 240) Vac to 5 Vdc power adaptor

3 SpeedLIGHT™ 16 Product Pictures



Figure 1-2 OLT with full unit population



Figure 1-3 SL16-BMU



Figure 1-4 SL16-PSU, SL16-MCU, and SL16-OCU-125



The Fan shelf has three pluggable fan units that can be inserted and ejected through back side.



Figure 1-5 SL16-OLT-FAN and fan unit



Figure 1-6 RN AWG and RN Closure (Pole mount type and Rack mount type)



Figure 1-7 SL16-ONT-125

Chapter2 SpeedLIGHT™ 16 Specification

1 SpeedLIGHT™16 Specifications

1.1 System specification

- Number of ONT's per RN: 16
- Data rate per ONT: 125 Mbps
- Maximum Range from OLT to ONT: 0 to 10 km
- Number of Fibers from OLT to RN: 1 feeder fiber per OLT
- Number of Fibers from RN to each ONT: 1 distribution fiber per ONT
- Maximum loss of the transmission fibers: 4.5 dB Upstream wavelength band: 1534 – 1560 nm
- Downstream wavelength band: 1426 – 1451 nm
- BER: 10^{-10} for 125 Mbps

1.2 Optical Line Terminal shelf : SL16-OLT

Main Specifications	
SL16-OCU-125	Up to 16 channels per shelf
SL16-MCU	1 unit per shelf
SL16-BMU	1 unit per shelf
SL16-PSU	2 units per shelf (for redundancy)
Power Supply and Dimensions	
Operating voltage	-40.8 Vdc ~ 57.6 Vdc
Max. power consumption	300 W
Dimension	19" rack, Height: 5 U
Operating Environment	
Operating Temperature	0 °C ~ 50 °C
Storage Temperature	-40 °C ~ 85 °C
Humidity	5 % ~ 85%

1.3 Optical Channel Unit (100M) : SL16-OCU-125

Optical Interface	
Optical cable	Single mode optical fiber
Optical interface	1 SC/APC connector
Line Rate	125 Mbps
Input optical data power	-32 dBm to -4 dBm (C-band)
Output optical data power	-14.5 dBm to +1.5 dBm (E-band)
BLS input power	-16 dBm to -2 dBm (E-band)
Ethernet Port	
Operation mode	Fast Ethernet / Auto-Negotiation Mode
Electrical interface	RJ-45

1.4 Broadband Light Source and Mux Unit : SL16-BMU

Optical Features	
Maximum branches	16 channel (Uplink: 16 wavelengths, Downlink: 16 wavelengths)
Optical cable	Single mode optical fiber
Optical connector	SC/APC
Max output data power into feeder fiber	+13.5 dBm (E-band)
BLS power into feeder fiber	+7.5 dBm to +19.5 dBm (C-band)
BLS output power to OCU	-16 dBm to -2 dBm (E-band, including one patch cord)

1.5 Main Control Unit : SL16-MCU

Interface	
Console	RS-232
Ethernet	RJ-45

1.6 Fan shelf : SL16-OLT-Fan

Main Features	
Fan unit	3 units per shelf
Power	-48 Vdc from the OLT shelf

1.7 Remote Node (RN) : SL16-RN

Optical Features		
Maximum branches	16 channel (Uplink: 16 wavelengths, Downlink: 16 wavelengths)	
Maximum Insertion Loss at Peak	5 dB for C-band and 5.5 dB for E-band	
Optical cable	Single mode optical fiber	
Optical connection	Connection to the CO	1 core
	Connection to the subscriber	1 core
Environmental Conditions		
Operating temperature	-30 °C ~ 70 °C	
Operating humidity	5% ~ 85%	

1.8 Optical Network Terminal (100M) : SL16-ONT-125

Optical Interface	
Optical cable	Single mode optical fiber
Line Rate	125 Mbps
Optical interface	SC/APC connector
Input optical data power	-33.5 dBm to -5.5 dBm (E-band)
Output optical data power	-14.5 dBm to +3 dBm (C-band)
BLS input power	-16 dBm to +2 dBm (C-band)
Ethernet Port	
Operation mode	Fast Ethernet / Auto-Negotiation Mode
Electrical interface	RJ-45 connector
Environmental Conditions	
Operating temperature	0 °C ~ 50 °C
Operating humidity	5% ~ 85%
Input Power Supply	
Rating	5 Vdc 3A

Chapter3 How to Install SpeedLIGHT™16

1 SpeedLIGHT™16 Units port and LED information

1.1 SL16-MCU

LED information



LED	Color	Status	Description
AT (Active)	Orange	On	Displays MCU is in booting status
	Green	On	Displays MCU is in normal operation
CR (Critical Alarm)	Red	On	Displays alarm that system in critical fault/failure
MJ (Major Alarm)	Orange	On	Displays alarm that system in major fault/failure
MN (Minor Alarm)	Yellow	On	Displays alarm that system in minor fault/failure

Port information

Port	Type	Description
COM	RJ-45	Console port for RS232 Serial Terminal
LAN1	RJ-45	Port for Ethernet connection #1 (10/100 Base-T)
LAN2	RJ-45	Port for Ethernet connection #2 (10/100 Base-T)
RST	Push-Button	System reset button

1.2 SL16-BMU



BMU LED information

LED	Color	Status	Description
PWR	Green	On	Indicates that power is properly providing
FAULT	Red	On	Alarms that BMU internal temperature is abnormally high
EFLT	Red	On	Displays E-BLS Fault (high temperature, high current, optical power drop more than 3 dB)
CFLT	Red	On	Displays C-BLS Fault (high temperature, high current, optical power drop more than 3 dB)
ALS	Red	On	Automatic Link Shut down occurs (Optical cable between OLT and RN is in abnormal state (fiber cut or fiber plugged out)
BLSOFF	Red	On	E-BLS or C-BLS power down

BMU Port information

Port	Type	Description
COM	SC/APC Adaptor	Output : 16 downstream WDM signals and C-BLS Input : 16 upstream WDM signals
OCU 1 to16	SC/APC Adaptor	Output : 16 spectrum sliced E-BLS Input : 16 downstream WDM signals

1.3 SL16-OCU

OCU LED information



LED	Color	Status	Description
AT (Active)	Green	On	Displays power on and normal status
OS (Out of service)	Red	On	Displays "Out Of Service" status
	Green	On	Displays "In Service" status
FL (Fx Link)	Green	On	Displays Fx Link up status
TL (Tx Link)	Green	On	Displays Tx Link up status
FA (Fx Active)	Green	On	Displays optical signal data transmitting and receiving correctly
TA (Tx Active)	Green	On	Displays electrical signal data transmitting and receiving correctly

OCU port information

Port	Type	Description
FX	SC/APC Adaptor	100Base-FX data port
TX	SC/APC Adaptor	100Base-TX data port

1.4 SL16-ONT

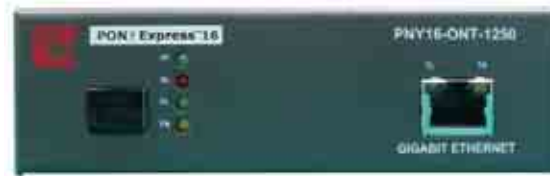

ONT LED indicator

the LED information is the same both for ONT-100M and for ONT-1G

LED	Color	Status	Description
AT	Green	On	Active
AL	Red	On	Alarm
FL	Orange	On	Fx Link up
FA	Green	On	Fx Active : receive and transmit data
TL	Orange	On	Tx Link up
TA	Green	On	Tx Active : receive and transmit data

ONT front panel port

Port	Type	Description
FX	SC/APC Adaptor	100Base-FX data port, Link to RN
TX	RJ-45	100Base-TX data port, Link to Ethernet Switch or VDSL

2 System installation and connections

2.1 SL16-OLT

- Locate and fix the OLT in a stabilized place. It can be placed on the table or installed in a rack. The selection of installation location is important in order to operate the system properly. The installation space shall have enough space distant from other equipments so that it is easy to access the OLT for maintenance.
- Locate the OLT where air flow is provided sufficiently in order to prevent overheating of equipments. Without proper air flow, the heat generated in the system can be accumulated to over heat the modules inside the OLT.
- Provide the power supply that meets the requirement described in Chapter 2. Connect –48 Vdc power cables to the screws of OLT shelf backside as shown in Fig. 3-1.

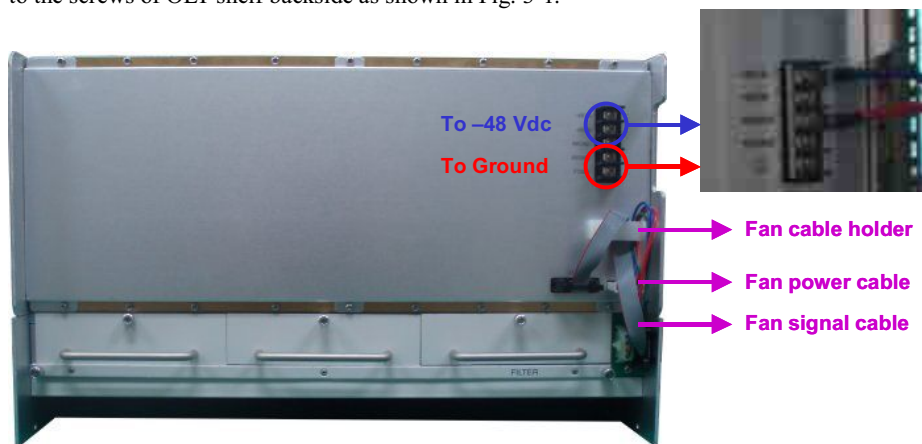

**Figure 3-1 OLT –48 Vdc connection and OLT shelf /
Fan shelf power and alarm signal connection example**

- In case of connecting external redundant power, the two pairs of power cables shall be separately connected to independent power supply.
- For connection of OLT shelf with Fan shelf, use ribbon cable for fan alarm signal and power cable for power supply to fan that are provided in the shipping box. Put fan signal cable and fan power cable through the cable holder as shown in Fig. 3-1. This holder prevents potential damage to fan signal cable when the right most fan unit is ejected.
- In case of installing the OLT in a 19 inch telecommunication rack, use the rack-mount brackets and four rack-mount screws through holes in the brackets
- For connection between OLT shelf and Fan shelf, use the alarm signal ribbon cable and power cable that are shipped with OLT together (See the connection example in Fig. 3-1).
- For optical connections between OCU and BMU, use the SC/APC type optical patch cord (2.4 mm thick, 20 cm long) that are providing in the OCU shipping boxes. (See Fig. 3-2 for connection example)
- For electrical connection (RJ45) between Aggregation switch in CO with OCU, use the straight type STP cable (Cat. 5e or Cat. 6). (See Fig. 3-2 for connection example)

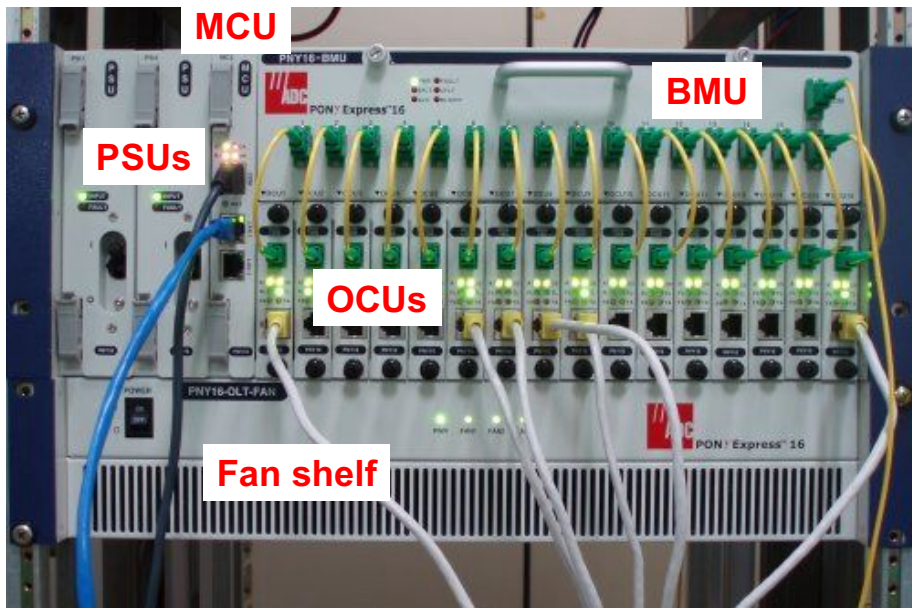

Figure 3-2 OCU and BMU optical connection, OCU and L3 switch electrical connection

2.2 SL16-RN

RN consists of an AWG (Arrayed Waveguide Grating) wavelength division multiplexer/demultiplexer and its closure. The AWG is a very high reliable passive optical component that does not need electrical power. The RN is located between the CO and ONU, it de-multiplexes 16 channel-multiplexed downstream signals received through the feeder fiber from the CO and transmits the independent de-multiplexed downstream signal to each ONT. And adversely, it multiplexes 16 independent upstream signals coming from the ONUs and transmits them to the CO. The common port of the RN connects to the OLT in the CO and consists of a 900 mm jacket optical patch cord with an SC/APC connector. The output ports to connect to the ONT consist of two 8-ribbon fibers whose ends are terminated with 900 mm jacketed optical fiber with a fan-out of 16 SC/APC connectors.



Figure 3-3 RN AWG

The RN connects to each ONU through a single optical fiber.

In case of installing RN on a Pole as shown in Fig. 3-4, the RN-enclosure has the AWG and patch panel for 17 SC/APC optical patch cord connections. An operator in the field can plug in a 24 core fiber cable with SC/APC connectors for connection to the RN common and output ports in advance. (For more detail, see the RN AWG installation procedure in closure)

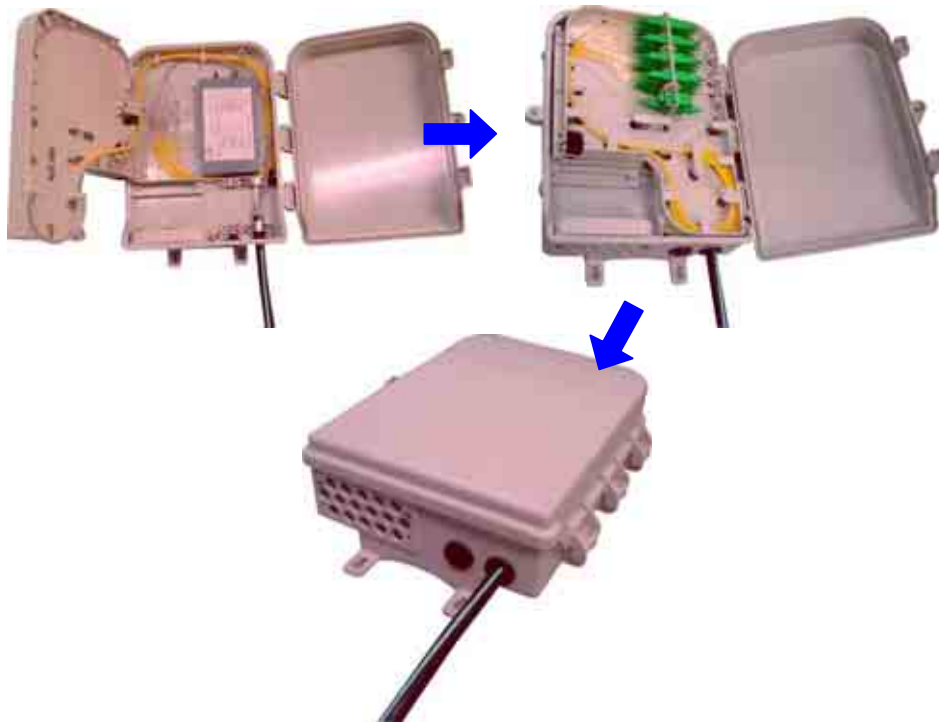

Figure 3-4 RN installed in closure for pole application

In case of installing the OLT in a 19 inch telecommunication rack as shown in Fig 3-5, use the rack-mount brackets and four rack-mount screws through holes in the brackets. For optical connections, use the SC/APC type optical patch cord.



Figure 3-5 RN installed in closure for rack mount application

2.3 SL16-ONT

ONT consists of DWDM-ONT and power adaptor pack. The power adaptor is to be connected to 110 - 240 Vac power supply and generates 5 Vdc for ONT. When connecting ONT to power adaptor, optical patch cord from RN to ONT and LAN cable to RJ45 port, the Fx port, ONT AT, FL, FA, TL, and TA LEDs will turn on in case proper data traffic is properly transmitted. Use cable holder to fix the power adaptor power cord to ONT as shown in Fig. 3-5. Holding power cord through holder prevents un-intended pulling off by mistake.



Figure 3-6 Connecting power connector to DWDM-ONT through holder

Chapter4 How to Operate the System using software

1 Cautions in system operation

The special key functions of CLI in serial communication may be restricted depending on the type of terminal (Windows hyper terminal).

2 Initial setting of terminal and accessing console

The system must be managed in the following 4 ways:

- Command Line Interface (CLI) via serial line
- CLI via Telnet or SSH
- Management via EMS
- Management via SNMP

At initial start-up, you must access the management mode via the serial port, and allocate the IP of SpeedLIGHT16 system. After that, you can manage the system via Telnet, SSH or EMS or SNMP for NMS.

Since the default rate of the serial port is 9,600 bps, set the serial port rate in the terminal to 9,600 bps, and proceed with access.

When using a terminal emulator such as a hyper terminal, set the terminal mode to VT100 as described in the following table.

How to set the hyper terminal

Bits per second	9,600 bps
Data bit	8 bit
Parity	None
Stop bit	1 bit
Flow control	None

3 General requirements for management module

The above-mentioned four management methods have the same type of management process, and hence, require the same capability in system management.

Management via Telnet, SSH or EMS is performed over IP, and access to IP is available from all the ports on the front panel. For example, if you allocate the IP number 192.168.1.10 to the SpeedLIGHT16 system, you can manage the system from a remote place through the IP address.

.....

Note



Refer to “Chapter 4. Managing System with CLI” and “Chapter 5. Managing System with EMS” for detailed operation method using CLI and EMS.

.....

4 OS upgrade

In case of modification or improvement of OS or features of the system, the program should be upgraded. The objects of upgrade are classified into OLT and ONT. You must reboot the system in order to apply the upgrade. It may take several minutes to complete upgrading as the system needs to download the new image files and write on the Flash memory. During the upgrading process “#” is displayed on the screen, and a prompt is displayed when transmission is completed. The system is not affected at all during the upgrade process, and you can operate the system with the existing OS until you reboot the system.

4.1 OLT upgrade

The OLT upgrade is performed with tftp or ftp via the network. You should start the ftp/tftp server on the client, and move the updated files to the target folder. Then, access OLT, enter the following command in the Privilege mode, and download the OS upgraded image file. You need to enter the ID and the password for security when downloading files.

Command	Mode	Description
copy { ftp tftp } ip_address filename flash	Privilege	Upgrade OS of OLT.
<pre> SL16# copy ftp 192.168.1.20 SL16-mcu-1.1.2.img flash Are you sure ? [Y/N] y username : **** password : **** Connected to 192.168.1.20 Receiving 1691602 bytes ##### Received 1691602 bytes #Image verify OK... writing to flash... ##### Flash written verifying ##### Succeed Verify flash written SL16# </pre>		

The updated files are applied automatically when you reboot the system at any time after downloading files.

4.2 ONT upgrade

Because the ONT network is not connected to the external network, you must download the upgraded file for ONT from OLT to CF. Then, you must access ONT, and import the OS upgraded image file for ONT from OLT. To ensure security, you need to enter the ID and the password. The following procedure shows how to upgrade ONT:

A) Log in to OLT, and in the Privilege mode, enter the following command to download the ONT upgrade file to CF.

Command	Mode	Description
download { ftp tftp } <i>ip_address filename</i>	Privilege	To upgrade ONT, download the OS upgraded file from ONT to CF.
<pre> SL16# download ftp 192.168.1.20 SL16-ont-1.1.0.img Are you sure ? [Y/N] y username : **** password : **** Connected to 172.30.0.150 Receiving 758817 bytes ##### Received 758817 bytes #verify OK... writing to compact flash... ##### SL16# </pre>		

B) As the file is normally transmitted, access ONT and enter the following command. Then ONT automatically accesses OLT and downloads the ONT updated file.

Command	Mode	Description
upgrade flash	Privilege	Download the ONT upgraded file from OLT, and automatically update the system.
<pre> ONT# update flash Connected to 192.0.2.254 Receiving 740701 bytes ##### ##### Receiving 740701 bytes #Verify OK... Writing to flash... ##### ##### ONT# </pre>		

The updated files are applied automatically when you reboot the system at any time after downloading files.

Chapter5 Managing System with CLI-1

1 Basic operation of CLI

This chapter describes how to use Command Line Interface (CLI) for setting of SpeedLIGHT16 environment.

2 Command system

2.1 OLT

CLI provides 5 global modes for management of OLT via the console or the remote terminal. The commands vary depending on the mode, and are restricted by the setting. When you log in the system, the default mode is the User mode.

User mode

When you first log in, the system operates in the User mode. '>' is displayed following the prompt. In the User mode, the system only supports the show function and other basic features.

You can use the following commands in the User mode.

```
SL16> ?
clear   Clear MAC table
enable  Change to enable mode
exit    Exit current mode and down to previous mode
help    Describe interactive help system
ping    Send ICMP echo messages
show    Show current system information
telnet  Connect to a remote host by TELNET
SL16>
```

Privilege mode

After logging in, enter “enable” and the password, and the system switches from the User mode to the Privilege mode. In this mode, you can view and change basic settings of the system, and switch the mode to Global or ONT. In this mode, ‘#’ is displayed following the prompt. The following table shows how to enter the Privilege mode and the list of available commands.

Command	Mode	Description
enable	user	Switch the mode to Privilege.
<pre> SL16> enable Password: ***** SL16# ? clear Clear current information config Enter configuration state copy Get IOS or Get/Put Configuration by tftp/ftp download Download ONT image exit Exit current mode and down to previous mode help Describe interactive help system ocu Set OCU parameters ont Enter ONT interface configuration state ping Send ICMP echo messages reboot Reboot system session Session control show Show current system information telnet Connect to a remote host by TELNET upload Upload file to remote host write Configuration backup to flash SL16# </pre>		

Global (setting) mode

In the Privilege mode, enter “config” to switch to the Global mode. In this mode, you can make settings for the system and the units. However, to check the setting, you need to return the mode to Privilege. To switch the mode to Privilege, enter “exit” or “end.” In this mode, ‘(config)#’ is displayed following the prompt. The following table shows how to enter the Global mode and the list of available commands.

Command	Mode	Description
config	Privilege	Switch the mode to Global.
SL16# enable		
SL16(config)# ?		
alarm	Set alarm grade	
arp	Set static ARP	
bmu	Set BMU parameters	
clock	Set system clock	
contact	Set the system contact	
dce	Set DCE parameters	
description	Set the system description	
enable	Change enable password	
end	End configuration mode	
exit	Exit current mode and down to previous mode	
hostname	Set the system name	
interface	Enter interface config mode	
ip	Internet Protocol config commands	
location	Set the system location	
no	Negate a command or set its defaults	
ntp	Set NTP parameters	
ocu	Set OCU parameters	
ont	ONT	
password	Set password encryption	
show	Show current system information	
snmp-server	Set SNMP server parameters	
syslog	Set syslog	
username	Set username and password	

Interface mode

In the Global mode, enter “interface ethernet_port” to switch the mode to Interface. In this mode, you can set or delete ip of the Ethernet port. Enter “exit” to return to the previous mode, or enter “end” to return to the Privilege mode. In this mode, ‘(config-if)#’ is displayed following the prompt. The following table shows how to enter the Interface mode and the list of available commands.

Command	Mode	Description
Interface ethernet_port	global	Switch the mode to Interface.
<pre>SL16(config)# interface eth0 SL16(config-if)# ? end End configuration mode exit Exit current mode and down to previous mode ip Internet Protocol config commands no Negate a command or set its defaults</pre>		

ONT mode

To manage ONT, you need to switch the mode to ONT. In the Privilege mode, enter “ONT ont_number” to enter the ONT mode. However, the system must be physically connected to the ONT, and the management channel must be normal. The connection error message is displayed if the connection is abnormal. In the ONT mode, you can view and change all the settings of ONT, and can monitor states of ONT. To enter the ONT mode, you need to enter the ONT user ID and password. Other ONT functions are described in the next chapter as they are the same as the console-based ONT function.

Command	Mode	Description
ont index	Privilege	Switch the mode to ONT
<pre>SL16# ont 4 Trying 192.0.2.4(23)... Connected to ont4. Escape character is '^]'. Welcome to LG-Nortel SpeedLIGHT16 User Access Verification Username: root Password: **** ONT></pre>		

2.2 ONT

CLI provides 3 global modes for management of OLT via the console or the remote terminal. The commands vary depending on the mode, and are restricted by the setting. When you log in the system, the default mode is the User mode.

User mode

When you first log in, the system operates in the User mode. '>' is displayed following the "OMT". In the User mode, the system only supports the show function and other basic features.

You can use the following commands in the User mode.

ONT>	
enable	Change to enable mode
exit	Exit current mode and down to previous mode
help	Describe interactive help system
ping	Send ICMP echo messages
show	Show current system information
telnet	Connect to a remote host by TELNET

Privilege mode

After logging in, enter "enable" and the password, the system switches from the User mode to the Privilege mode. In this mode, you can view and change basic settings of the system, and switch the mode to Global or ONT. In this mode, '#' is displayed following the prompt. The following table shows how to enter the Privilege mode and the list of available commands.

Command	Mode	Description
enable	user	Switch the mode to Privilege.
<pre> ONT> enable Password: ***** ONT# clear Clear current information config Enter configuration state copy Get IOS or Get/Put Configuration by tftp/ftp exit Exit current mode and down to previous mode help Describe interactive help system ping Send ICMP echo messages reboot Reboot system session Session control show Show current system information telnet Connect to a remote host by TELNET </pre>		

upgrade upgrade from MPU
write Configuration backup to flash

Global (Setting) mode

In the Privilege mode, enter “config” to switch to the Global mode. In this mode, you can make settings for the system and the units. However, to check the setting, you need to return the mode to Privilege. To switch the mode to Privilege, enter “exit” or “end”. In this mode, ‘(config)#’ is displayed following the prompt. The following table shows how to enter the Global mode and the list of available commands.

Command	Mode	Description
config	Privilege	Switch the mode to Global.
ONT# enable		
ONT(config)#		
arp		Set static ARP
clear		Clear current information
clock		Set system clock
contact		Set the system contact
description		Set the system description
enable		Change enable password
end		End configuration mode
exit		Exit current mode and down to previous mode
hostname		Set the system name
ipm		Set IPM value
location		Set the system location
no		Negate a command or set its defaults
ont		ONT
password		Set password encryption
show		Show current system information
username		Set username and password.

3 How to use commands

The following functions enable you to easily enter commands in CLI.

Help

If you press the < **Tab** > key on the prompt, the possible commands are listed. Or you may enter the question mark (?) to view the possible commands in the mode and the brief descriptions on the commands.

```
SL16# <Tab>
arp    clear  config  copy    exit    help
ocu    ont    ping    reboot  session
show   telnet  write
SL16# <?>
arp    Set static ARP
clear  Clear current information
config Enter configuration state
copy   Get IOS or Get/Put Configuration by tftp/ftp
exit   Exit current mode and down to previous mode
help   Describe interactive help system
ocu    Set OCU parameters
ont    Enter ONT interface configuration state
ping   Send ICMP echo messages
reboot Reboot system
session Session control
show   Show current system information
telnet Connect to a remote host by TELNET
upload upload file to remote host
write  Configuration backup to flash
```

Auto completion

Type a part of a command and press the < Tab > key. Then the entire command is completed automatically. This function also shows the next possible commands.

```
SL16# show <Tab>
alarm      arp        bmu        clock      config     dce
fan        flash     interface  ip         log        mac
memory     ocu       processes  psu        running-config snmp-server
status     system    users
SL16#
```

Command edit

You can edit the command or select a previous command as shown in the following table.

Available Key	Description
Del	Delete a character on the curser
Backspace	Delete a character in the left of the curser
↑	Call the previous command

4 CLI command

The basic CLI commands vary by the mode. The system is in the User mode when you first access the system. You must change the mode to Privilege to manage systems, to Global to make setting, to Interface mode to set the network IP, or to ONT to manage ONT. Basically, the command system and functions are the same between ONT and OLT. Because ONT performs its own functions only, it has neither Interface mode nor ONT mode, and has less commands than OLT. Therefore, this document provides description on the commands by classifying them into functions, without separating them into OLT commands and ONT commands.

5 System access and IP setting

This section describes how to set the password and IP address for system access and network communication. You can access the system, set the IP address, and make network communication with other systems via the interface.

5.1 System login

You can log in the system through the console port or the remote terminal. To use the remote terminal, you must access the system via the console and set the system IP. Check if the network and the console port are properly connected to the PC, and then, test the connection. Refer to “4.2 Initial setting of terminal and accessing console” for how to set the console port and terminal. If you access the system, the following login prompt appears. Enter the user name and password to enter the User mode. The default user name and password are “root.” Then, switch the mode to Privilege and manage the system. The default user name and password for the Privilege mode are also “root.” Refer to “4.2 Command system” on how to enter and switch modes.

Welcome to LG-Nortel SpeedLIGHT16

User Access Verification

Username: root

Password: ****

SL16>

5.2 Auto logout

If you leave your seat, other people may change the setting of the system. This command sets the auto logout function. You are automatically logged out if there is no keyboard action for a designated period of time. You can set the time or clear the function. The following table shows how to set or clear session timeout.

Command	Mode	Description
session timeout 0	Privilege	Clear auto logout.
session timeout <0-3600>		Set auto logout time in seconds. If you don't set the time, the default time of 600 seconds is applied.
SL16# session timeout 300		
SL16#		

5.3 Create user ID and change password

The default user name for system access is “root.” You can add up to 5 user IDs. If you create the first user, the “root” user ID is deleted and replaced by the new user ID. You can add from the second ID. When creating ID, you must also create the password in the same manner as you create ID.

Command	Mode	Description
username <i>id passwd</i>	global	Create user ID and change password.
SL16(config)# username LG-Nortel LG-Nortel SL16(config)#		

Note



You can check the created or changed user ID in “4.7.1 Show memory information.”

5.4 Protect user password

The password is shown as “*****” on show running-config, and not as a text.

Command	Mode	Description
password encryption	global	Set protection for the user password.
SL16(config)# password encryption SL16(config)#		

5.5 Clear user password protection

The user password protection function is cleared.

Command	Mode	Description
no password encryption	global	Clear the user password protection function.
SL16(config)# no password encryption SL16(config)#		

5.6 Delete user ID

“no” is prefixed to the commands in order to revert the default value or delete the setting. This rule is also applied to deletion of user ID.

Command	Mode	Description
no username <i>id</i>	global	Delete a user.
SL16(config)# no username LG-Nortel SL16(config)#		

5.7 Change privilege password

The administrator can change the password for the Privilege mode. To ensure security, it is recommended to change the Privilege password from time to time. You can change the password as described below.

Command	Mode	Description
passwd	global	Change the Privilege password.
SL16(config)# enable password ***** SL16(config)#		

5.8 Remote access

You can access the remote system with the following command.

Command	Mode	Description
telnet destination ip	User/Privilege	Access the remote system.
SL16# telnet x.x.x.x SL16#		

5.9 Manage remote user

The administrator can check the remote users and disconnect any user. The maximum number of sessions for remote connection is 5 including the console. To disconnect a remote user, check the line number of the user, and make the delete command.

Command	Mode	Description
show users	User/Privilege	Show the remote users.
clear line <i>line_number</i>	Privilege	Disconnect a remote user.
<pre>SL16# show users Line Location ----- 1 Console * 2 192.168.1.89 3 192.168.1.55 SL16# clear line 3 SL16#</pre>		

5.10 Reboot system

When a new OS image is downloaded via tftp/ftp, the system must be rebooted. You should also reboot the system when you need to boot the system for the management purpose.

Command	Mode	Description
reboot	Privilege	Reboot the system.
<pre>SL16# reboot Are you sure? [Y/N]</pre>		

Note



Rebooting of a system restarts the management module only, and therefore, does not interrupt service or affect the service rate.

5.11 Set system IP address

No IP address is required for the service for the subscribers. However, you need an IP to manage a remote system or to manage information or status by accessing SNMP from EMS or NMS. You can set IP address for eth0 and eth1 in the current system. Eth1 is a stacking port used to manage a number of systems in a single IP address, which is not used at the moment. Therefore, you should set an IP address for eth0 for system management. The following command is used to add, change or delete an IP.

Command	Mode	Description
ip address A.B.C.D/M	interface	Add or change IP.
SL16(config-if)# ip address 10.1.1.1/24 SL16(config-if)#		

5.12 View system IP address

You can check the IP address set for eth0. The following command is used to view the IP address.

Command	Mode	Description
Show interface eth0	User/Privilege	Show the IP address of the system.
SL16# show interface eth0 Interface eth0 is up MAC Address is 00:19:8b:00:10:20 IP Address is 10.1.1.1/255.255.255.192 Input 6145 packets, 706029 bytes, 0 error, 0 drop Output 2231 packets, 183232 bytes, 0 error, 0 drop SL16#		

5.13 Delete system IP address

You can delete an unnecessary IP address.

Command	Mode	Description
no ip address	Interface	Delete a system IP.
SL16(config-if)# no ip address SL16(config-if)#		

6 System configuration

This section describes how to set and manage the host name, the time and the version of the system.

6.1 Set basic information

You can set brief information on the system, including name, description, contact information and location.

Command	Mode	Description
hostname <i>hostname</i>	global	Set the system name.
description <i>description</i>		Write brief description on the system.
location <i>location</i>		Save the installation location.
contact <i>contact</i>		Set the contact information of the system administrator.
<pre>SL16(config)# hostname LG-Nortel SL16(config)# SL16(config)# description SpeedLIGHT16 SL16(config)# SL16(config)# location test_room SL16(config)# SL16(config)# contact home</pre>		

6.2 Delete basic information

You can delete information on the system.

Command	Mode	Description
no hostname	global	Delete the system name.
no description		Delete the description on the system.
no location		Delete the location.
no contact		Delete the contact information of the system administrator.
<pre>SL16(config)# no hostname SL16(config)# SL16(config)# no description SL16(config)# SL16(config)# no location SL16(config)# SL16(config)# no contact SL16(config)#</pre>		

6.3 Set date and time

You can set or change the current time and date on the system. The parameter “HH:MM:SS DD MM YYYY” following the command means “Hour:Minute:Second Day Month Year”.

Command	Mode	Description
clock HH:MM:SS DD MM YYYY	global	Set the current time and date on the system.
<pre>SL16(config)# clock 10:30:20 14 9 2006 SL16(config)#</pre>		

6.4 Show date and time

You can check the current time and date on the system with the following command.

Command	Mode	Description
show clock	user/Privilege	Show the current time and date of the system.
<pre>SL16# show clock Wed Sep 14 10:30:20 KST 2006 SL16#</pre>		

6.5 Set time-zone

You can set the time-zone with the following command.

Command	Mode	Description
Clock timezone <i>type no</i>	global	Set the time with time-zone.
<pre>SL16(config)# clock timezone UTC 9 SL16(config)#</pre>		

6.6 Set NTP(Network Time Protocols) server

NTP is used to ensure exact time on the network by setting the system time to 1/1000 second. When you set an NTP server, the system retrieves the current time from the NTP server by exchanging messages. To operate the system properly, the system must be set to the exact time. You can set the NTP server and enter IP with the following command.

Command	Mode	Description
ntp server A.B.C.D	global	Set IP address of the NTP server.
SL16(config)# ntp server 111.1.1.1 SL16(config)#		

6.7 Delete NTP (Network Time Protocols)

You can delete an NTP server with the following command.

Command	Mode	Description
no ntp server	global	Delete an NTP server.
SL16(config)# no ntp server 111.1.1.1 SL16(config)#		

7 Manage system configuration

You can check the system setting or save the setting in the system. This section describes the method of managing system configuration.

7.1 Show configuration in the memory

You can view the entire settings of a system with a command. Because the command shows the settings stored in the memory, any information not written in CF is not displayed after rebooting of the system.

Command	Mode	Description
show running-config	privilege/global	Show the current setting of the system.
<pre>SL16# show running-config Current running configuration: ! syslog host 192.168.1.10 ! snmp-server community public ro snmp-server community private rw snmp-server trap-host 192.168.1.10 public snmp-server trap ocu-equip snmp-server trap ocu-admin snmp-server trap ocu-ipm snmp-server trap ocu-fxlk snmp-server trap ocu-txlk snmp-server trap bmu-equip snmp-server trap bmu-cfault snmp-server trap bmu-efault snmp-server trap bmu-als snmp-server trap bmu-fan --more--</pre>		

.....

Note



'-- more --' is used after the 23rd line to indicate that there are more lines. You can stop viewing information by entering "q".

.....

7.2 Show compact flash information

This command shows setting up information of the system to be saving in the compact flash. You can use the following command to view setting up information of the system to be saving in the compact flash.

Command	Mode	Description
show config	privilege/global	Show setting up information of the system to be saving in the compact flash.
<pre>SL16# show config Saved configuration: ! syslog host 192.168.1.10 ! snmp-server community public ro snmp-server community private rw snmp-server trap-host 192.168.1.10 public snmp-server trap ocu-equip snmp-server trap ocu-admin snmp-server trap ocu-ipm snmp-server trap ocu-fxlk snmp-server trap ocu-txlk snmp-server trap bmu-equip snmp-server trap bmu-cfault snmp-server trap bmu-efault snmp-server trap bmu-als snmp-server trap bmu-fan --more--</pre>		

7.3 Save information

Because the information you set is applied to the memory only, any information not written on compact flash is deleted when the system is rebooted. The following command is used to save information on show running-config in the Flash. When changing system or MCU, if you use the compact flash with the current setting, you can easily recover the setting on the new system or MCU.

Command	Mode	Description
write	privilege	Save the setting in compact flash.
SL16# write SL16#		

7.4 Clear information

You can delete all information from the compact flash.

Command	Mode	Description
clear config	privilege	Delete all information from the compact flash.
SL16# clear config SL16#		



After deleting information, make sure to reboot the system to apply the change.

.....

7.5 Back up information

You can make a backup copy of all information in the compact flash. The backup copy can be useful to recover information when the configuration data is damaged or the system is replaced.

Command	Mode	Description
copy config ftp tftp <i>ip filename</i>	privilege	Make a backup copy of compact flash information via ftp/tftp.
<pre>SL16# copy config ftp 100.1.1.1 config.bak SL16#</pre>		

7.6 Back up current setting

You can make a backup copy of all settings shown in running-config and not stored in CF. The backup copy can be useful to recover information when the configuration data is damaged or the system is replaced.

Command	Mode	Description
copy running-config ftp tftp <i>ip filename</i>	privilege	Make a backup copy of current setting via ftp/tftp.
<pre>SL16# copy running-config ftp 100.1.1.1 config.bak SL16#</pre>		

7.7 Import backup copy of setting information

You can recover the setting information with the backup copy of setting data when the configuration data is damaged or the system is replaced.

Command	Mode	Description
copy ftp tftp <i>ip filename</i> config	privilege	Recover the setting information by importing backup copy via ftp/tftp.
SL16# copy ftp 10.1.1.1 config.bak config SL16#		



After recovering information, make sure to reboot the system.

.....

8 Check system

If there is a problem in the system, you must find the reason and the solution. You should also check the system before a problem occurs. And after changing setting, you need to check if the system is properly set. This section describes the commands you can use to check the information for basic management of the system.

8.1 Show system information

The following command shows a brief profile of the system such as the name, the version by module and the capacity.

Command	Mode	Description
show system	User/Privilege	Show system information.
<pre>SL16# show system System Information Hostname : LG-Nortel Description : SpeedLIGHT16 Location : tester_room Contact : home HWver : 2.0 SWver : 1.1.4 FWver : 1.2 DRAM : 128 MByte FLASH : 16 MByte</pre>		

8.2 Show memory state

You can view memory state of the system with the following command.

Command	Mode	Description
show memory	User/Privilege	Show memory state.
<pre>SL16# show memory total used free shared buffers Mem: 117304 21536 95768 0 812 Swap: 0 0 0 Total: 117304 21536 95768</pre>		

8.3 Show process information

This command shows the current CPU load by process. You can find the daemon that seizes the CPU most, any unnecessary daemon, and the process of the faulty daemon.

Command	Mode	Description
show processes	User/Privilege	Show system process information.
<pre>SL16# show processes < cpu usage average for > 5 sec : 16.60 % 1 min : 20.28 % 5 min : 22.19 % 10 min : 22.35 %</pre>		

8.4 Show Flash memory state

This command shows the Flash memory state of the system. You can get information on the IOS file systems, the applications and the ONT upgrade image files.

Command	Mode	Description
show flash	User/Privilege	Show system process information.
<pre>SL16# show flash ----- Total size(B) Used size(B) Unused size(B) version ----- OS File System 4194304 3932160 262144 KERNEL-1.7 Application 4194304 956724 3237580 2.0.0 ONT image name : SL16-ont.img , version = 2.0.0 SL16#</pre>		

9 Network management

This section describes the method to set the system network management functions.

9.1 Check network connection state

With the ping command, you can check if the system is properly connected to the network.

Command	Mode	Description
ping destination_ip [count] [datagram_size]	User/Privilege	Perform the ping test to check the network status. The “count” indicates the repeat counts and “datagram_size” indicates the size of data sent at a time.
<pre>SL16# ping 192.168.1.10 10 PING 192.168.1.16 (192.168.1.16): 10 data bytes 64 bytes from 192.168.1.16: icmp_seq=0 ttl=128 time=1.5 ms 64 bytes from 192.168.1.16: icmp_seq=1 ttl=128 time=1.1 ms 64 bytes from 192.168.1.16: icmp_seq=2 ttl=128 time=0.9 ms 64 bytes from 192.168.1.16: icmp_seq=3 ttl=128 time=0.9 ms 64 bytes from 192.168.1.16: icmp_seq=4 ttl=128 time=1.0 ms 64 bytes from 192.168.1.16: icmp_seq=5 ttl=128 time=0.9 ms 64 bytes from 192.168.1.16: icmp_seq=6 ttl=128 time=0.9 ms 64 bytes from 192.168.1.16: icmp_seq=7 ttl=128 time=0.9 ms 64 bytes from 192.168.1.16: icmp_seq=8 ttl=128 time=1.0 ms 64 bytes from 192.168.1.16: icmp_seq=9 ttl=128 time=0.9 ms --- 192.168.1.16 ping statistics --- 10 packets transmitted, 10 packets received, 0% packet loss round-trip min/avg/max = 0.9/1.0/1.5 ms SL16#</pre>		

9.2 Set routing table

This command creates the routing table for optimum transmission path out of various transmission paths used in the system. You can add the default gateway to the routing table.

Command	Mode	Description
ip default-gateway <i>ip</i>	global	Add the default gateway to the routing table.
<pre>SL16(config)# ip default-gateway 10.1.1.4 SL16(config)#</pre>		

9.3 Show routing table

You can check the routing table with the following command.

Command	Mode	Description
show ip route	User/Privilege	Show the contents of the routing table.
SL16# show ip route		
Destination	Subnet Mask	Gateway
-----	-----	-----
S 10.1.1.4	255.255.255.192	connected to interface eth0
S 0.0.0.0	0.0.0.0	via 10.1.1.1
SL16#		

9.4 Delete routing table

You can delete the default gateway from the routing table with the following command.

Command	Mode	Description
no ip default-gateway	global	Delete the default gateway from the routing table.
SL16(config)# no ip default-gateway		
SL16(config)#		

9.5 Add ARP table

The devices connected to the IP network have two types of addresses; the LAN address and the network address. The LAN address is called as the data link address because it is typically used in Layer 2, but is widely known as the MAC address. To transmit the data packets, you need to know the 48-bit MAC address. The process of finding the matching MAC address with the IP address is called as “address resolution,” and the process of finding the matching IP address with the MAC address is called as “reverse address resolution.” The protocol used when finding the matching MAC address with the IP address is ARP (Address Resolution Protocol). The ARP table is automatically added when the system finds the matching MAC address with the IP through ARP. The network administrator may add the matching MAC address with a specific IP address on the ARP table. To match the MAC address with a specific IP address, you must use add the IP address in the ARP table with the following command.

Command	Mode	Description
arp ip_address MAC	global	Add an IP address in the ARP.
SL16(config)# arp 192.168.1.140 00:0F:EA:50:E2:B9		
SL16(config)#		

9.6 Show ARP table

You can view the contents of the ARP table with the following command.

Command	Mode	Description
show arp	User/Privilege	Show the ARP table.
<pre>SL16# show arp IP Address HW address Iface Flags ----- 192.168.1.140 00:0F:EA:50:E2:B9 eth0 S 192.168.1.42 00:16:36:00:8C:CB eth0 D 192.0.2.1 00:D0:A6:01:08:C4 eth2 D SL16#</pre>		

9.7 Delete address from ARP table

You can delete an address from the static ARP table with the following command.

Command	Mode	Description
no arp ip_address	Global	Delete an address from the ARP table.
<pre>SL16(config)# no arp 192.168.1.140 SL16(config)#</pre>		

9.8 Delete all from ARP table

You can delete all the addresses from the ARP table with the following command.

Command	Mode	Description
clear arp all	Privilege	Delete all addresses from the ARP table.
<pre>SL16# clear arp all SL16#</pre>		

9.9 Show MAC table

This command creates and shows the MAC table for OCU and ONT. The MAC table has the ports connected to a unit, and the MAC addresses for the following OCU and ONT port.

```
[OCU-FE]      [OCU-GE]
0 : FX       10 : FX
1 : TX       9 : TX
[ONT-FE]     [ONT-GE]
0 : FX       7 : FX
4 : TX       3 : TX
```

The following table shows the command for the entire MAC table and the one for specific OCU channel.

Command	Mode	Description
show mac all	User/Privilege	Show the entire MAC table.
show mac <i>index</i>	User/Privilege	Show the MAC addresses for the selected OCU.

```
SL16# show mac all
[OCU 1]
Port  MAC address
-----
Tx[1] 00:00:f0:90:6a:6a
Tx[1] 00:14:85:d2:83:7d
Fx[0] 00:d0:a6:01:08:a8

[OCU 2]
Port  MAC address
-----
Tx[1] 00:00:f0:90:6a:6a
Tx[1] 00:14:85:d2:83:7d
Fx[0] 00:d0:a6:01:08:a0

[OCU 16]
Port  MAC address
-----
Tx[1] 00:00:f0:81:14:47
Tx[1] 00:00:f0:90:6a:6a
Tx[1] 00:0f:ea:53:99:fd
Fx[0] 00:d0:a6:01:08:a1
SL16#
SL16# show mac 1
[OCU 1]
Port  MAC address
-----
```

```
Tx[1] 00:00:f0:90:6a:6a
Tx[1] 00:14:85:d2:83:7d
Fx[0] 00:d0:a6:01:08:a0
SL16#
```

10 Set SNMP

SNMP (Simple Network Management Protocol) consists of the SNMP Manager, the systems of the network, and the SNMP agents installed in the systems. SNMP is the protocol that supports communication between the SNMP Manager and the SNMP Agents. The protocol defines the format of information exchanged between the SNMP Manager and the SNMP Agents. When setting SNMP, you must specify the relationship between the SNMP Manager and the Agents. You can provide the read-only or the read/write authority depending on the community. The system supports the V3 function for security, and you can set the ID and password for accessing SNMP. The SNMP Agent has the MIB parameter to respond for the request of the SNMP Manager. The SNMP Manager can get data from the Agent, or save data in the Agent. The Agent gets data from MIB which has information on the system and the network.

The SNMP Agent can send traps for troubles to you. Traps are warning messages on the network status sent to the SNMP Trap-host. A trap is sent to the SNMP Trap-host if there is a problem in the systems or the modules.

10.1 Set access to SNMP Agent

You should not give access authority to SNMP Agent to everybody. You can set the password to restrict the access. The community contains the general meaning of password. You can enter a password in the “community_name” parameter. You can give the read-only or read/write authority for SNMP Agent depending on the password. The following table shows the commands used to set the password for SNMP Agent. ‘ro’ and ‘rw’ at the end of the command indicate ‘read-only’ and ‘read/write’, respectively.

Command	Mode	Description
snmp-server community <i>community_name</i> { <i>ro</i> <i>rw</i> }	global	Set password for accessing agent.
<pre>SL16(config)# snmp-server community LG-Nortel ro SL16(config)# snmp-server community administrator rw SL16(config)#</pre>		

Note



You can set up to 5 SNMP communities.

10.2 Delete password for SNMP Agent

To cancel authority for SNMP Agent, you should use the following command to delete the password for SNMP Agent.

Command	Mode	Description
no snmp-server community <i>community_name</i> {ro rw }	global	Delete password for Agent.
SL16(config)# no snmp-server community LG-Nortel ro SL16(config)# no snmp-server community administrator rw SL16(config)#		

10.3 Set ID for SNMP Agent

The V3 function is supported for increased security of access to SNMP Agent. You can set ID and password for V3. The following command is used to set ID and password in SNMP Agent.

Command	Mode	Description
snmp-server user <i>id</i> auth md5 <i>password</i>	global	Create ID for SNMP Agent.
SL16(config)# snmp-server user admin auth md5 admin01 SL16(config)#		

.....

Note



You can set up to 5 SNMP users.

.....

10.4 Delete ID for SNMP Agent

With the following command, you can delete the ID for SNMP Agent.

Command	Mode	Description
no snmp-server user <i>id</i>	global	Delete ID for SNMP Agent.
SL16(config)# no snmp-server user admin SL16(config)#		

10.5 Set SNMP Trap-host

SNMP traps are the alarm messages sent by the SNMP Agent to the SNMP Manager. If you set the SNMP Trap function, you can receive information on the network management program from the system for a specific event. The receiver of the trap message is Trap-host. If you designate the trap-host with the community, the designated community has the priority. If you don't designate any community, the property set in "4.10.6 Set SNMP Trap-community." The following table shows the command used in designating the SNMP Trap-host.

Command	Mode	Description
snmp-server trap-host <i>ip_address [community_name]</i>	global	Set SNMP Trap-host.
SL16(config)# snmp-server trap-host 192.168.1.10 LG-Nortel		
SL16(config)#		

Note



You can set up to 5 SNMP Trap-hosts.

10.6 Set SNMP Trap type

You can set trap for each of the 5 modules (BMU, FAN, OCU, PSU and ONT), and set the detailed status for each module. The following table shows the types of alarms for trap by module.

Command	Mode	Description
snmp-server trap all	Global	Set all types available.
snmp-server trap bmu-als	Global	Set the trap for no optical signal in any channels.
snmp-server trap bmu-cfault	Global	Set the trap for BMU c-bls fault.
snmp-server trap bmu-efault	Global	Set the trap for BMU e-bls fault.
snmp-server trap bmu-equip	Global	Set the trap for insertion/deletion of BMU module.
snmp-server trap bmu-temp	Global	Set the trap for BMU temperature alarm.
snmp-server trap fan-equip	Global	Set the trap for insertion/deletion of the FAN module.
snmp-server trap fan-fault	Global	Set the trap for fault in any of 3 FANS in the FAN module.
snmp-server trap fan-power	Global	Set the trap for power fault in the FAN module.
snmp-server trap ocu-equip	Global	Set the trap for insertion/deletion of OCU.
snmp-server trap ocu-fxlk	Global	Set the trap for OCU FX-LINK UP/DOWN.
snmp-server trap ocu-ipm	Global	Set the trap for OCU optical input power alarm.

Command	Mode	Description
snmp-server trap ocu-txlk	Global	Set the trap for OCU TX-LINK UP/DOWN.
snmp-server trap ont-fxlk	Global	Set the trap for ONT FX-LINK UP/DOWN.
snmp-server trap ont-ipm	Global	Set the trap for ONT optical input power alarm.
snmp-server trap ont-txlk	Global	Set the trap for ONT TX-LINK UP/DOWN.
snmp-server trap psu-equip	Global	Set the trap for insertion/deletion of PSU module.
snmp-server trap psu-fault	Global	Set the trap for PSU fault.
snmp-server trap psu-power	Global	Set the trap for PSU power fault.
SL16(config)# snmp-server trap all SL16(config)# snmp-server trap bmu-als SL16(config)# snmp-server trap fan-equip SL16(config)#		

10.7 Show SNMP setting

The command shows the status of the SNMP in the system.

Command	Mode	Description
show snmp-server	User/Privilege	Show status of SNMP.
SL16# show snmp-server SNMP Information RO Community : public RW Community : private TRAP Server : 192.168.1.10 test SL16#		

10.8 SNMP connection control function of ONT

The command is backup function in case of CPU overload, a function to control SNMP connection. One can reduce CPU usage by disconnecting ONT SNMP using this function since the ONT will not try to register ONT MIB when reconnecting ONT.

Command	Mode	Description
ont snmp {enable disable}	global	Set snmp connection state of ONT.
<pre>SL16(config)# ont snmp disable SL16(config)# SL16(config)# ont snmp disable SL16(config)#</pre>		

11 Syslog Management

11.1 Set Syslog host

Syslog sends the message on system error to the administrator. It is similar with SNMP Trap in that both notify you of the system event. Syslog, however, sends the message to you through the default syslog daemon called “System logger”.

Command	Mode	Description
syslog host <i>ip_address</i>	global	Set the syslog host.
SL16(config)# syslog host 192.168.1.10		
SL16(config)#		

.....

Note



You can set up to 5 syslog hosts.

.....

11.2 Set Syslog display

If generate alarm in system display at console alarm information. This command control function display or not display alarm contact at console.

Command	Mode	Description
syslog display	global	Set the syslog at display
no syslog display	global	Clear the syslog display
SL16(config)# syslog display		
SL16(config)# no syslog display		

12 Log management

The system reports every event to the administrator and logs the result in CF as the command log, the alarm log or the system log for future usage as the fault statistics data.

12.1 Show command log

The command logs stored in the system are displayed.

Command	Mode	Description
show log history	User/Privilege	Show command log.
<pre>SL16# show log history 2006-09-14 20:08:35 [console] dce 3 type ont 2006-09-14 20:08:36 [console] end 2006-09-14 20:08:37 [console] sh rconf 2006-09-14 20:08:39 [console] sh run 2006-09-14 20:08:42 [console] wr 2006-09-14 20:22:34 [192.168.1.16] en 2006-09-14 20:22:45 [192.168.1.16] show snmp-server 2006-09-14 20:22:52 [192.168.1.16] config 2006-09-14 20:23:23 [192.168.1.16] exit SL16#</pre>		

12.2 Show system log and alarm log

The system logs and the command logs stored in the system are displayed.

Command	Mode	Description
show log	User/Privilege	Show system log and alarm log.
<pre>SL16# show log 2007-07-19 15:13:11 [192.168.1.16] telnet connection 2007-07-19 15:15:15 [192.168.1.10] telnet connection 2007-07-19 15:15:45 [210.105.79.10] telnet disconnect 2007-07-19 15:16:38 DCE-7 , CR, TX-LINK1-DOWN 2007-07-19 15:16:38 DCE-10 , CR, TX-LINK1-DOWN 2007-07-19 15:16:38 OCU1G-5 , CR, UNIT-OUT 2007-07-19 15:16:38 OCU100M-9 , CR, UNIT-OUT 2007-07-19 15:16:38 OCH-1 , CR, TX-LINK-DOWN SL16#</pre>		

12.3 Delete log

You can delete the command logs, the system logs and the alarm logs from the system.

Command	Mode	Description
clear log history	Privilege	Delete command log.
clear log		Delete system log and alarm log.
SL16# clear log history SL16# clear log		

13 Alarm management

13.1 Set alarm grade

The system provides alarms if there is any fault in a module. Each alarm has its alarm grade so that you can take the action in priority order. The alarm grades are divided into Critical (CR), Major (MJ), Minor (MN) and Cleared (NA). You can set the grade for each alarm with the following commands.

Command	Mode	Description
alarm grade all {critical major minor}	Global	Set all types of alarms available.
alarm grade bmu-als {critical major minor}	Global	Set alarm for no optical signal in any channel.
alarm grade bmu-cfault {critical major minor}	Global	Set alarm for BMU c-bls fault.
alarm grade bmu-efault {critical major minor}	Global	Set alarm for BMU e-bls fault.
alarm grade bmu-equip {critical major minor}	Global	Set alarm for deletion/insertion of BMU module.
alarm grade bmu-temp {critical major minor}	Global	Set alarm for board temp of BMU module.
alarm grade fan- equip{critical major minor}	Global	Set alarm for deletion/insertion of FAN module.
alarm grade fan-fault {critical major minor}	Global	Set alarm for fault in any of 3 FANs in FAN module.
alarm grade fan-power {critical major minor}	Global	Set alarm for FAN module power fault.
alarm grade ocu-equip {critical major minor}	Global	Set alarm for deletion/insertion of OCU.
alarm grade ocu-fx1k {critical major minor}	Global	Set alarm for OCU FX-LINK UP/DOWN.
alarm grade ocu-ipm {critical major minor}	Global	Set alarm for OCU optical input power alarm.
alarm grade ocu-tx1k {critical major minor}	Global	Set alarm for OCU TX-LINK UP/DOWN.
alarm grade ont-fx1k {critical major minor}	Global	Set alarm for ONT FX-LINK UP/DOWN.
alarm grade ont-ipm {critical major minor}	Global	Set alarm for ONT optical input power alarm.
alarm grade ont-tx1k {critical major minor}	Global	Set alarm for ONT TX-LINK UP/DOWN.
alarm grade psu-equip {critical major minor}	Global	Set alarm for deletion/insertion of PSU module.
alarm grade psu-fault	Global	Set alarm for PSU fault.

Command	Mode	Description
{critical major minor}		
alarm grade psu-power {critical major minor}	Global	Set alarm for PSU power fault.
SL16(config)# alarm grade all critical SL16(config)# alarm grade bmu-als major SL16(config)# alarm grade fan-equip minor SL16(config)#		

13.2 Show alarm grade

With this command, you can view all the alarm grades set in the system.

Command	Mode	Description
show alarm grade	User/Privilege	Show grades of all alarms.
<pre>SL16# show alarm grade alarm grade ocu-equip major alarm grade ocu-ipm minor alarm grade ocu-fxlk critical alarm grade ocu-txlk critical alarm grade bmu-equip major alarm grade bmu-cfault critical alarm grade bmu-efault critical alarm grade bmu-als critical alarm grade bmu-temp major alarm grade fan-equip major alarm grade fan-power major alarm grade fan-fault minor alarm grade psu-equip minor alarm grade psu-power minor alarm grade psu-fault critical alarm grade ont-fxlk critical alarm grade ont-txlk major alarm grade ont-ipm minor SL16#</pre>		

13.3 Delete alarm grade

You can delete the alarm grade. If you delete the grade for an alarm, it is set to “Critical (CR)”, the default alarm grade.

Command	Mode	Description
no alarm grade all	Global	Delete all alarm grades.
no alarm grade <i>alarm_type</i>		Delete the selected alarm grades.
<pre>SL16(config)# no alarm grade all SL16(config)# no alarm grade bmu-als SL16(config)# no alarm grade fan-equip</pre>		

13.4 Set generate alarm level

You can determine whether the system logs any event as an alarm. For example, alarm grades are divided into “Critical”, “Major” and “Minor”. If you select “Major”, the system does not log “Minor” alarms.

Command	Mode	Description
syslog alarm log level { critical major minor }	Global	Set alarm grade.
<pre>SL16(config)# syslog alarm log level major SL16(config)#</pre>		

14 Show BMU & PSU & FAN status

Show deletion/insertion and alarm of BMU, PSU and FAN module.

Command	Mode	Description
show status	User/Privilege	Show alarm status of BMU, PSU and FAN module.
<pre> SL16# show status < BMU Status > Admin : Equip BMU ALARM : < PSU Status > PSU Unequip : PSU-1 PSU Fail : PSU-1 < FAN Status > FAN Power : ON FAN Unequip : FAN Fail : SL16# </pre>		

15 BMU management

15.1 Show BMU status

You can receive alarm and information on BMU (Broadband Light Source and MUX Unit).

Command	Mode	Description
show bmu	User/Privilege	Show BMU status.
<pre>SL16# show bmu < BMU Status > Equip : Equip ALS : OK FAULT(BTEMP) : OK Board Temp : 30 `C CFLT : OK EFLT : OK Type : 1G Board ver : 3.0 F/W ver : 3.1 CPLD ver : 3.1 SL16#</pre>		

15.2 Set ALS

If no optical power is detected in any channel, ALS (Automatic Link Shutdown) stops transmitting BLS optical power to protect vision of the user. You can enable/disable this function with the following command. In other words, this command does not directly activate ALS, but decide whether to enable ALS to act under the given conditions.

Command	Mode	Description
bmu als enable	global	Enable BMU ALS.
bmu als disable	global	Disable BMU ALS.
<pre>SL16(config)# bmu als enable SL16(config)# bmu als disable SL16(config)#</pre>		

16 PSU management

16.1 Show PSU status

You can receive alarm and information on 2 PSU (Power Supply Unit) modules.

Command	Mode	Description
show psu	User/Privilege	Show status of PSU.
<pre> SL16# show psu < PSU Status > PSU-1 Equip : unequip PSU-1 PWR ON/OFF : - PSU-1 PWR INPUT : - PSU-1 PWR FAULT : - PSU-2 Equip : equip PSU-2 PWR ON/OFF : ON PSU-2 PWR INPUT : DC -48V PSU-2 PWR FAULT : OK SL16# </pre>		

17 FAN management

17.1 Show FAN status

You can receive alarm and information on the FAN module with 3 FANS installed in the slots.

Command	Mode	Description
show fan	User/Privilege	Show status of FAN module.
<pre> SL16# show fan < FAN Status > FAN UNIT PWR ON/OFF : ON FAN-1 Equip : equip FAN-1 PWR FAIL : OK FAN-2 Equip : equip FAN-2 PWR FAIL : OK FAN-3 Equip : equip FAN-3 PWR FAIL : OK SL16# </pre>		

18 OCU management

18.1 Show OCU status

A system can manage up to 16 OCUs (Optical Channel Units). With the following commands you can check alarm status and other information of the optical channels. When using the commands, you can view all OCUs, give range for OCU, or refresh information at every three minutes (OCU monitoring).

A) Show status of all OCUs

Command	Mode	Description
show ocu all	User/Privilege	Show status of all OCUs.
<pre> SL16# show ocu all < OCU Status > ===== CH Equip Admin IPM Type F/W FxLk TxLk Speed Auto DCE ===== 1 equip IS FAIL(-36dBm) 100M 2.10 DOWN DOWN - ON ONT 2 unequip IS - - - - - - - ONT 3 equip IS FAIL(-18dBm) 1G 1.0 DOWN DOWN - ON ONT 4 unequip IS - - - - - - - ONT 5 unequip IS - - - - - - - ONT 7 unequip IS - - - - - - - ONT 8 equip IS FAIL(-36dBm) 100M 2.10 DOWN DOWN - ON ONT 9 unequip IS - - - - - - - ONT 10 unequip IS - - - - - - - ONT 11 unequip IS - - - - - - - ONT 12 unequip IS - - - - - - - ONT 13 unequip IS - - - - - - - ONT 14 unequip IS - - - - - - - ONT 15 unequip IS - - - - - - - ONT 16 unequip IS - - - - - - - ONT SL16# </pre>		

B) Show OCU range

Command	Mode	Description
show ocu <i>start end</i>	User/Privilege	Show status of OCUs of the given range. To see a single OCU, you should enter the start number only.
<pre> SL16# show ocu 1 3 < OCU Status > ===== CH Equip Admin IPM Type F/W FxLk TxLk Speed Auto DCE ===== 1 equip IS FAIL(-36dBm) 100M 2.10 DOWN DOWN - ON ONT 2 unequip IS - - - - - - - ONT 3 equip IS FAIL(-18dBm) 1G 1.0 DOWN DOWN - ON ONT SL16# </pre>		

C) Show OCU monitor

Command	Mode	Description
show ocu monitor	User/Privilege	Show status of OCU at every three seconds.
<pre> SL16# show ocu monitor < OCU Status > ===== CH Equip Admin IPM Type F/W FxLk TxLk Speed Auto DCE ===== 1 equip IS FAIL(-36dBm) 100M 2.10 DOWN DOWN - ON ONT 2 unequip IS - - - - - - - ONT 3 equip IS FAIL(-18dBm) 1G 1.0 DOWN DOWN - ON ONT 4 unequip IS - - - - - - - ONT 5 unequip IS - - - - - - - ONT 7 unequip IS - - - - - - - ONT 8 equip IS FAIL(-36dBm) 100M 2.10 DOWN DOWN - ON ONT 9 unequip IS - - - - - - - ONT 10 unequip IS - - - - - - - ONT 11 unequip IS - - - - - - - ONT 12 unequip IS - - - - - - - ONT 13 unequip IS - - - - - - - ONT 14 unequip IS - - - - - - - ONT 15 unequip IS - - - - - - - ONT 16 unequip IS - - - - - - - ONT Press any key to turn off monitoring SL16# </pre>		

18.2 Show OCU Packet Counter

OCU packet counter shows the current traffic in FX and TX port of OCU. You can select all OCU packet counter or give a range of OCU.

A) Show packet counter of all OCUs

Command	Mode	Description
show ocu packet-counter all	User/Privilege	Show packet counter of all OCUs.
<pre>SL16# show ocu packet-counter all [OCU-1250-1] ===== Items Fx Port Tx Port ===== InUnicasts 0 0 InBroLG-Nortelasts 0 0 InMulticasts 0 0 InFCSErr 0 0 Undersize 0 0 Fragments 0 0 Oversize 0 0 InGoodOctets 0 0 InBadOctets 0 0 InPause 0 0 InJabber 0 0 InRxErr 0 0 InDiscards 0 0 In.64.Octets 0 0 In.127.Octets 0 0 In.255.Octets 0 0 In.511.Octets 0 0 In.1023.Octets 0 0 In.Max.Octets 0 0 ----- OutUnicasts 0 0 OutBroLG-Nortelasts 0 0 OutMulticasts 0 0 OutFCSErr 0 0 Collisions 0 0 OutPause 0 0 Excessive 0 0 Deferred 0 0 </pre>		

Single		0	0
Multiple		0	0
Late		0	0

[OCU-1250-2			
=====			
Items		Fx Port	Tx Port
=====			
InUnicasts		0	0
InBroLG-Nortelasts		0	0
InMulticasts		0	0
InFCSErr		0	0
Undersize		0	0
Fragments		0	0
Oversize		0	0
InGoodOctets		0	0
InBadOctets		0	0
InPause		0	0
InJabber		0	0
InRxErr		0	0
InDiscards		0	0
!			
(omitted)			
!			
[OCU-1250-16]			
=====			
Items		Fx Port	Tx Port
=====			
InUnicasts		0	0
InBroLG-Nortelasts		0	0
InMulticasts		0	0
InFCSErr		0	0
Undersize		0	0
Fragments		0	0
Oversize		0	0
InGoodOctets		0	0
InBadOctets		0	0
InPause		0	0
InJabber		0	0
InRxErr		0	0
InDiscards		0	0
In.64.Octets		0	0

In.127.Octets		0	0
In.255.Octets		0	0
In.511.Octets		0	0
In.1023.Octets		0	0
In.Max.Octets		0	0

OutUnicasts		0	0
OutBroLG-Nortelasts		0	0
OutMulticasts		0	0
OutFCSErr		0	0
Collisions		0	0
OutPause		0	0
Excessive		0	0
Deferred		0	0
Single		0	0
Multiple		0	0
Late		0	0

SL16#			

B) Show OCU Packet Counter range

Command	Mode	Description																																																																																													
show ocu packet-counter <i>start end</i>	User/Privilege	Show packet counter of OCUs of the designated range. To see packet counter of an OCU only, you should enter the start number only.																																																																																													
<pre>SL16# show ocu packet-counter 1 5 [OCU-1250-1]</pre> <table border="1"> <thead> <tr> <th>Items</th> <th>Fx Port</th> <th>Tx Port</th> </tr> </thead> <tbody> <tr> <td>InUnicasts</td> <td>0</td> <td>0</td> </tr> <tr> <td>InBroLG-Nortelasts</td> <td>0</td> <td>0</td> </tr> <tr> <td>InMulticasts</td> <td>0</td> <td>0</td> </tr> <tr> <td>InFCSErr</td> <td>0</td> <td>0</td> </tr> <tr> <td>Undersize</td> <td>0</td> <td>0</td> </tr> <tr> <td>Fragments</td> <td>0</td> <td>0</td> </tr> <tr> <td>Oversize</td> <td>0</td> <td>0</td> </tr> <tr> <td>InGoodOctets</td> <td>0</td> <td>0</td> </tr> <tr> <td>InBadOctets</td> <td>0</td> <td>0</td> </tr> <tr> <td>InPause</td> <td>0</td> <td>0</td> </tr> <tr> <td>InJabber</td> <td>0</td> <td>0</td> </tr> <tr> <td>InRxErr</td> <td>0</td> <td>0</td> </tr> <tr> <td>InDiscards</td> <td>0</td> <td>0</td> </tr> <tr> <td>In.64.Octets</td> <td>0</td> <td>0</td> </tr> <tr> <td>In.127.Octets</td> <td>0</td> <td>0</td> </tr> <tr> <td>In.255.Octets</td> <td>0</td> <td>0</td> </tr> <tr> <td>In.511.Octets</td> <td>0</td> <td>0</td> </tr> <tr> <td>In.1023.Octets</td> <td>0</td> <td>0</td> </tr> <tr> <td>In.Max.Octets</td> <td>0</td> <td>0</td> </tr> <tr> <td colspan="3">-----</td> </tr> <tr> <td>OutUnicasts</td> <td>0</td> <td>0</td> </tr> <tr> <td>OutBroLG-Nortelasts</td> <td>0</td> <td>0</td> </tr> <tr> <td>OutMulticasts</td> <td>0</td> <td>0</td> </tr> <tr> <td>OutFCSErr</td> <td>0</td> <td>0</td> </tr> <tr> <td>Collisions</td> <td>0</td> <td>0</td> </tr> <tr> <td>OutPause</td> <td>0</td> <td>0</td> </tr> <tr> <td>Excessive</td> <td>0</td> <td>0</td> </tr> <tr> <td>Deferred</td> <td>0</td> <td>0</td> </tr> <tr> <td>Single</td> <td>0</td> <td>0</td> </tr> <tr> <td>Multiple</td> <td>0</td> <td>0</td> </tr> </tbody> </table>			Items	Fx Port	Tx Port	InUnicasts	0	0	InBroLG-Nortelasts	0	0	InMulticasts	0	0	InFCSErr	0	0	Undersize	0	0	Fragments	0	0	Oversize	0	0	InGoodOctets	0	0	InBadOctets	0	0	InPause	0	0	InJabber	0	0	InRxErr	0	0	InDiscards	0	0	In.64.Octets	0	0	In.127.Octets	0	0	In.255.Octets	0	0	In.511.Octets	0	0	In.1023.Octets	0	0	In.Max.Octets	0	0	-----			OutUnicasts	0	0	OutBroLG-Nortelasts	0	0	OutMulticasts	0	0	OutFCSErr	0	0	Collisions	0	0	OutPause	0	0	Excessive	0	0	Deferred	0	0	Single	0	0	Multiple	0	0
Items	Fx Port	Tx Port																																																																																													
InUnicasts	0	0																																																																																													
InBroLG-Nortelasts	0	0																																																																																													
InMulticasts	0	0																																																																																													
InFCSErr	0	0																																																																																													
Undersize	0	0																																																																																													
Fragments	0	0																																																																																													
Oversize	0	0																																																																																													
InGoodOctets	0	0																																																																																													
InBadOctets	0	0																																																																																													
InPause	0	0																																																																																													
InJabber	0	0																																																																																													
InRxErr	0	0																																																																																													
InDiscards	0	0																																																																																													
In.64.Octets	0	0																																																																																													
In.127.Octets	0	0																																																																																													
In.255.Octets	0	0																																																																																													
In.511.Octets	0	0																																																																																													
In.1023.Octets	0	0																																																																																													
In.Max.Octets	0	0																																																																																													

OutUnicasts	0	0																																																																																													
OutBroLG-Nortelasts	0	0																																																																																													
OutMulticasts	0	0																																																																																													
OutFCSErr	0	0																																																																																													
Collisions	0	0																																																																																													
OutPause	0	0																																																																																													
Excessive	0	0																																																																																													
Deferred	0	0																																																																																													
Single	0	0																																																																																													
Multiple	0	0																																																																																													

Late		0	0

[OCU-1250-2			
=====			
Items		Fx Port	Tx Port
=====			
InUnicasts		0	0
InBroLG-Nortelasts		0	0
InMulticasts		0	0
InFCSErr		0	0
Undersize		0	0
Fragments		0	0
Oversize		0	0
InGoodOctets		0	0
InBadOctets		0	0
InPause		0	0
InJabber		0	0
InRxErr		0	0
InDiscards		0	0
!			
(omitted)			
!			
[OCU-1250-5]			
=====			
Items		Fx Port	Tx Port
=====			
InUnicasts		0	0
InBroLG-Nortelasts		0	0
InMulticasts		0	0
InFCSErr		0	0
Undersize		0	0
Fragments		0	0
Oversize		0	0
InGoodOctets		0	0
InBadOctets		0	0
InPause		0	0
InJabber		0	0
InRxErr		0	0
InDiscards		0	0
In.64.Octets		0	0
In.127.Octets		0	0
In.255.Octets		0	0

In.511.Octets		0	0
In.1023.Octets		0	0
In.Max.Octets		0	0

OutUnicasts		0	0
OutBroLG-Nortelasts		0	0
OutMulticasts		0	0
OutFCSErr		0	0
Collisions		0	0
OutPause		0	0
Excessive		0	0
Deferred		0	0
Single		0	0
Multiple		0	0
Late		0	0

SL16#			

18.3 Show average packet counter of OCU

This function displays average packet counter of OCU for 5sec, 10sec, 1min and 10min. For FE channels, packet counter is calculated severally for Fx and Tx, for IN and OUT, and for per packet and per bytes. For GE channel, because the chipsets are not divided into IN and OUT, packet counter is calculated severally for Fx and Tx only. Because the byte size is bigger than packet, 'pkt/s' is '0', but 'bytes/s' may not be '0'. The commands are divided into the ones for all OCUs and for the selected OCUs only. The following commands are used for average packet counter.

A) Show average packet counter of all OCU

Command	Mode	Description
show ocu average packet-counter all	User/Privilege	Show average packet counter of all channels.
<pre> SL16# show ocu average packet-counter all < OCU-1250 Status : Only Ingress Packet > ===== Port FX TX ----- Time pkt/s bytes/s bits/s pkt/s bytes/s bits/s ===== [OCU-1250-1] --- FX --- 5sec 0 212 1,696 1 164 1,312 10sec 1 247 1,976 1 164 1,312 1min 1 234 1,872 1 148 1,184 10min 0 105 840 0 58 464 ----- [OCU-1250-2] 5sec 0 0 0 0 0 0 10sec 0 0 0 0 0 0 1min 0 0 0 0 0 0 10min 0 0 0 0 0 0 ----- ! (omitted) ! [OCU-1250-16] 5sec 0 0 0 0 0 0 10sec 0 0 0 0 0 0 1min 0 0 0 0 0 0 10min 0 0 0 0 0 0 </pre>		

 SL16#

B) Show average packet counter of the selected OCU

Command	Mode	Description
show ocu average packet-counter {all idx1 ide2 ... (max 5 select)}	User/Privilege	Show average packet counter for the elected OCU channel of any range.
<pre> SL16# show ocu average packet-counter 1 2 < OCU-1250 Status : Only Ingress Packet > ===== Port FX TX ===== Time pkt/s bytes/s bits/s pkt/s bytes/s bits/s ===== [OCU-1250-1] --- FX --- 5sec 0 212 1,696 1 164 1,312 10sec 1 247 1,976 1 164 1,312 1min 1 234 1,872 1 148 1,184 10min 0 105 840 0 58 464 ===== [OCU-1250-2] 5sec 0 0 0 0 0 0 10sec 0 0 0 0 0 0 1min 0 0 0 0 0 0 10min 0 0 0 0 0 0 ===== SL16# </pre>		

18.4 Show TRx information of OCU

This function displays TRx information of OCU for Board Temp, VCC, TX-BC, Tx-Power and Rx-Power(IPM).

A) Show TRx information of all OCU

Command	Mode	Description
show ocu trx all	User/Privilege	Show TRx information of all channels.
<pre> SL16# show ocu trx all [OCU-1250-1 TRx Status] Board Temp : OK(42.52`C) VCC : OK(3.285V) TX-BC : OK(0.13mA) Rx-Power(IPM) : OK(-8.0Bm) [OCU-1250-2 TRx Status] Board Temp : OK(40.70`C) VCC : OK(3.271V) TX-BC : OK(0.13mA) Rx-Power(IPM) : OK(-13.0Bm) ! (omitted) ! [OCU-1250-16 TRx Status] Board Temp : OK(42.73`C) VCC : OK(3.287V) TX-BC : OK(0.00mA) Rx-Power(IPM) : FAIL(-10.0Bm) SL16# </pre>		

B) Show TRx information of the selected OCU

Command	Mode	Description
show ocu trx { <i>idx1 ~ idx16</i> }	User/Privilege	Show TRx information for the elected OCU channel.
<pre> SL16# show ocu trx 1 [OCU-1250-1 TRx Status] Board Temp : OK(42.52`C) VCC : OK(3.285V) TX-BC : OK(0.13mA) Rx-Power(IPM) : OK(-8.0Bm) SL16# </pre>		

18.5 Show in-band ID of OCU

In-band ID is internal unique ID of between OCU and ONT for ONT management through in-band communication in optical circuit. This function display default in-band ID information of OCU.

A) Show in-band ID information of all OCU

Command	Mode	Description
show ocu inband-id all	Privilege	Show in-band ID information of all channels.
<pre> SL16# show ocu inband-id all ----- CH In-Band ID ----- 1 4095 2 4095 3 4095 4 4095 5 4095 6 4095 7 4095 8 4095 9 4095 10 4095 11 4095 12 4095 13 4095 14 4095 15 4095 16 4095 ----- SL16# </pre>		

B) Show in-band ID information of the selected OCU

Command	Mode	Description
show ocu inband-id <i>index</i>	Privilege	Show in-band ID information for the elected OCU channel.
<pre> SL16# show ocu inband-id 1 ----- CH In-Band ID ----- 1 4095 SL16# </pre>		

Note



Default in-band id of OCU 4095 when system shipping.

18.6 Control OCU

You can switch OCU status to OOS (Out Of Service) or IS (In Service). If you select OOS, the OCU FX and TX port are disabled, and all the OCU services are stopped. And no alarm is generated. If you select IS, all the services are recovered to normal. In IS, the system checks and generates all alarms of OCU. This function is typically used to stop the functions of OCU as OCU is not inserted in the channels or OCU operates abnormally.

Command	Mode	Description
ocu disable { all start end }	global	Stop all services of the selected OCU.
ocu enable { all start end }	global	Resume all services of the selected OCU.
SL16(config)# ocu disable 1 4 SL16(config)#		

18.7 IPM function

OCU requires the appropriate optical input power for data transmission. The system needs to generate the IPM (Input Power Monitoring) alarm if the optical input power is out of the range. However, because the appropriate value varies depending on the external environment and channel conditions, you should measure the optical input power at each OCU channel after installing the system, and sets the standard value within the appropriate range. The following command is used to set the IPM range of OCU.

Command	Mode	Description
ocu ipm min_value max_value { all start end }	global	Set IPM range of OCU.
SL16(config)# ocu ipm -35 -4 1 SL16(config)#		

.....

Note



IPM *min-value* and *max-value* are db. The input range is FE : -36db ~ -5db and GE : -22db ~ -1db. The default min and max value of IPM are FE : -30db, -5db, and GE : -22db, -1db

.....

18.8 Clear IPM

With this command, you can clear IPM range of OCU. If the setting is cleared, the default value is applied.

Command	Mode	Description
no ocu ipm { all <i>start end</i> }	global	Clear IMP range of OCU.
SL16(config)# no ocu ipm 1 SL16(config)#		

18.9 Remote reset

Remote reset is a very useful function. If a DCE is abnormal, you can reset DCE through the electrical signal from OLT. This minimizes the maintenance work and costs, improving quality of the customer service.

Command	Mode	Description
ocu rreset <i>index</i>	Privilege	Reset DCE of an OCU.
ocu rreset all	Privilege	Reset DCEs of all OCUs.
SL16# ocu rreset 1 Are you sure ? [Y/N] SL16# ocu rreset all Are you sure ? [Y/N] SL16#		

18.10 Set port speed

You can set the data rate of the OCU port from 10Mbps, 100Mbps, 1000Mbps or auto. The auto mode adjusts the data rate to the transmission speed of the connected system and the duplex mode.

Command	Mode	Description
ocu speed {10 100 1000 auto } { full half } { all <i>start end</i> }	global	Set speed of OCU.
SL16(config)# ocu speed 100 full 1 3 SL16(config)#		

Note



The default value of port speed is auto.

18.11 Clear port speed

With the following commands, you can clear the OCU port speed. If the setting is cleared, the default value is applied.

Command	Mode	Description
no ocu speed { all start end }	global	Clear speed setting of OCU.
SL16(config)# no ocu speed 1 3 SL16(config)#		

19 ONT management

The ONT management commands can be used in the ONT mode. Many of the ONT related commands work the same with the OLT management commands. Therefore, this section only provides the ONT commands that work differently from the OLT commands.

19.1 Show status of ONT

The following command shows information on ONT status, such as the deletion/insertion of an Fx port and a Tx port, the IPM value, the hardware and firmware version, the link status and the speed.

Command	Mode	Description
show status	Privilege	Show status of ONT.
<pre> ONT# show status ===== Equip IPM H/W F/W FxLk TxLk Tx Speed Tx Auto ===== ONT-FE FAIL(-36.0dBm) DOWN DOWN - ON ONT# </pre>		

19.2 Show ONT Packet Counter

ONT packet counter enables you to view current traffic in the Fx / Tx port for OCU.

Command	Mode	Description
show ont packet-counter	Privilege	Show packet counter information of ONT.
<pre> ONT# show ont packet-counter ===== Items Fx Port Tx Port ===== InUnicasts 0 0 InBroLG-Nortelasts 0 0 InMulticasts 0 0 InFCSErr 0 0 Undersize 0 0 Fragments 0 0 Oversize 0 0 InGoodOctets 0 0 InBadOctets 0 0 InPause 0 0 InJabber 0 0 InRxErr 0 0 InDiscards 0 0 </pre>		

In.64.Octets		0	0
In.127.Octets		0	0
In.255.Octets		0	0
In.511.Octets		0	0
In.1023.Octets		0	0
In.Max.Octets		0	0

OutUnicasts		0	0
OutBroLG-Nortelasts		0	0
OutMulticasts		0	0
OutFCSErr		0	0
Collisions		0	0
OutPause		0	0
Excessive		0	0
Deferred		0	0
Single		0	0
Multiple		0	0
Late		0	0

ONT#			

19.3 Show TRx information of ONT

This function displays TRx information of ONT for Board Temp, VCC, TX-BC, Tx-Power and Rx-Power(IPM).

Command	Mode	Description
show ont trx	Privilege	Show TRx information of ONT
<pre> ONT# show ont trx Board Temp : OK(57.88°C) VCC : OK(3.295V) TX-BC : OK(0.06mA) Rx-Power(IPM) : OK(-11.9Bm) ONT#</pre>		

19.4 Show in-band ID of ONT

In-band ID is internal unique ID of between OCU and ONT for ONT management through in-band communication in optical circuit. This function display default in-band ID information of ONT.

Command	Mode	Description
show ocu inband-id	Privilege	Show in-band ID information of ONT
<pre> SL16# show ont inband-id ----- ONT IN-BAND ID ----- 4095 ----- SL16#</pre>		

Note



.....
Default in-band id of ONT 4095 when system shipping.
.....

19.5 IPM function

ONT requires the appropriate optical input power for data transmission. The system needs to generate the IPM (Input Power Monitoring) alarm if the optical input power is out of the range. However, because the appropriate value varies depending on the external environment and channel conditions, you should measure the optical input power after installing the system, and sets the standard value within the appropriate range. The following command is used to set the IPM range of ONT.

Command	Mode	Description
ipm min-value max-value	global	Set the range of IPM of ONT.
ONT(config)# ipm -35 -4 ONT(config)#		

.....

Note



IPM *min-value* and *max-value* are db. The input range is FE : -36db ~ -5db and GE : -22db ~ -1db. The default min and max value of IPM are FE : -30db, -5db, and GE : -22db, -1db.

.....

19.6 Clear IPM

You can clear IPM range of ONT. If the value is cleared, the default value is applied.

Command	Mode	Description
no ipm	global	Clear IPM range of ONT.
ONT(config)# no ipm ONT(config)#		

19.7 Set port speed

You can set the data rate of the ONT port from 10Mbps, 100Mbps, 1000Mbps or auto. The auto mode adjusts the data rate to the transmission speed of the connected system and the duplex mode.

Command	Mode	Description
ont speed {10 100 1000 auto } { full half }	global	Set the speed of ONT.
ONT(config)# ont speed auto ONT(config)#		

.....

Note  The default port speed is auto nego.

.....

20 DCE management

20.1 Show DCE information

The system has the DCE (Data Circuit-Terminal Equipment) for each channel. There are 3 types of DCE; ONT, ONU and TRC. ONT is classified into the independent pizza box type and the ONT-3 type where 3 ONTs make a single unit. ONU is an Fx-module that operates as an Up-link in the cabinet switch. TRC operates as a transceiver in a transmission system.

Command	Mode	Description
show dce	User/Privilege	Show DCE information.
<pre> SL16# show dce ===== CH Type IP Address Version ===== 1 onu 211.1.1.23 - 2 ont - 1.0.2 3 onu 211.1.1.24 - 4 onu 211.1.1.25 - 5 ont - 1.0.2 6 onu 211.1.1.26 - 7 ont - 1.0.2- 8 ont - 1.0.2 9 ont - 1.0.2 10 ont - 1.0.2 11 ont - 1.0.2 12 ont - 1.0.2 13 ont - 1.0.2 14 ont - 1.0.2 15 ont - 1.0.2 16 ont - 1.0.2 SL16# </pre>		

20.2 Set DCE

You can set DCE by designating type and IP address of DCE. You don't need to set the IP address for ONT and TRC, but can set the IP address for ONU. In order to manage DCE, you have to designate the type of DCE for each OCU channel. Especially when the DCE is ONT, if you don't designate the type, the system cannot perform communication as the in-band channel is closed. Setting ONU and the IP address shows the status of the cabinet in EMS. TRC is excluded from the object of management.

Command	Mode	Description
dce type {ont onu trc } { all start end }	global	Set the type of DCE.
dce ip ip_address dce_id	global	Set the IP address if DCE is ONU.
SL16(config)# dce type onu 1 SL16(config)# dce ip 221.11.14.52 1 SL16(config)#		

Note



.....
 Default DCE type is ONT.

20.3 Clear DCE

Releasing DCE is divided into releasing all DCEs, releasing a DCE and releasing DCEs of a given range. When you clear a DCE, the type and IP address are also cleared, and the DCE is marked as “-.”

Command	Mode	Description
no dce all	global	Clear all DCEs.
no dce index	global	Clear a DCE.
no dce start end	global	Clear DCEs of a given range.
SL16(config)# no dce all SL16(config)# no dce 1 SL16(config)# no dce 1 5 SL16(config)#		

21 Help

This function provides brief help for use of CLI commands.

Command	Mode	Description
help	User/Privilege	Provides brief help for use CLI commands.
<p>SL16# help</p> <p>If you need any help about a command and/or options, just type a question mark '?'.</p> <p>This will show you a list of help which is available now.</p> <p>See the following examples.</p> <p>1. SL16> ? -> list all commands.</p> <p>2. SL16> show ? -> list all arguments following a "show" command.</p> <p>2. SL16> show r? -> list all arguments starting with "r" following a "show" command.</p> <p>SL16#</p>		

Chapter6 GUI-based EMS Operation Manual

1 Overview

1.1 Features

This system provides the status view and control function of system configuration and alarm via LAN. EMS manages up to 50 systems and 3 types of Data Circuit-Terminal Equipment (DCE) connected with the system OCU. The system provides the in-band ONT status view and management, the SNMP-based ONU search and the TRC management function.

1.2 Characteristics

Operator EMS access: The system is easy to control, and provides access to various devices on a GUI window. You can also view status of various devices on an EMS window.

The EMS integrates up to 50 systems via the TL-1 commands, supporting NMS that manages the network.

An EMS enables the user to implement the NMS network, and to manage up to 50 systems on an EMS. LG-Nortel recommends a high-performance PC to support the NMS function.

EMS also reports occurrence and clearance of alarm in real time to the user.

You can save and retrieve history on the database, and also retrieve the stored data.

The system allows only the authorized users to control the device via limitation of user levels and the password function.

2 System operation

2.1 Network connection between PC and system

The system has no IP in default. Therefore, in order to use the system, you need to register the system IP, and register the system with this IP in EMS.

To register the system IP, refer to “5.2.4 IP Setting.”

The PC monitor for EMS is optimized at 16 bit (True color) and 1024X768 (resolution).

The following figure shows how to register IP of the operator PC.

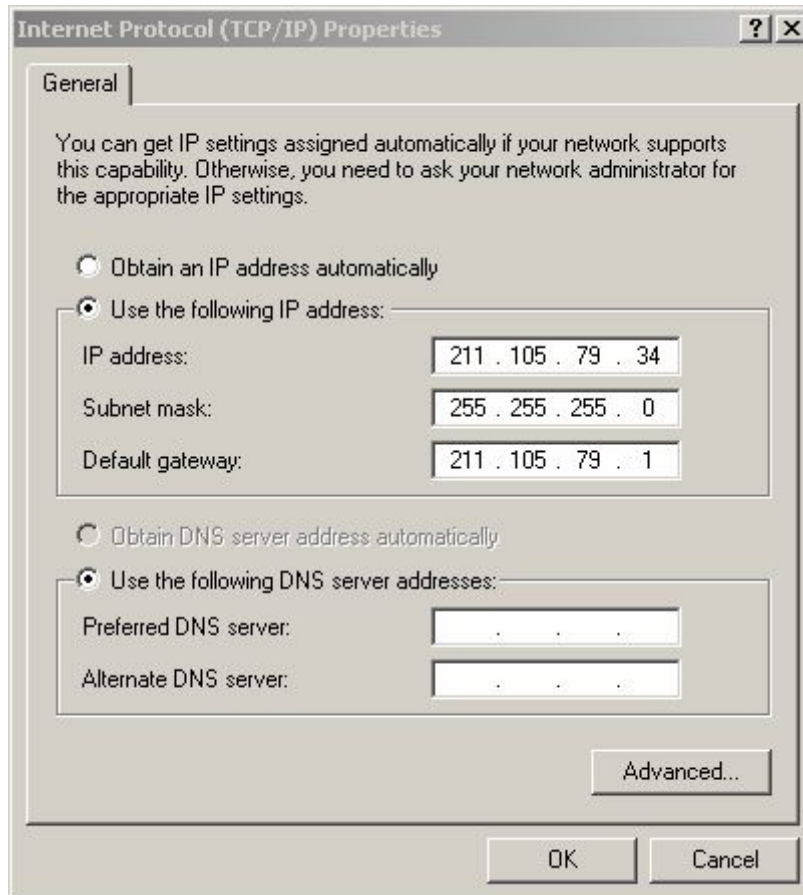

Figure 6-1. PC Network Gateway

2.2 Installing EMS program

Insert the CD-ROM to the CD-ROM driver to start the install program.

To install the program by yourself, double-click Setup.exe in the CD-ROM.

You must uninstall the old version or the existing program before installing the program. Or, the program may malfunction.

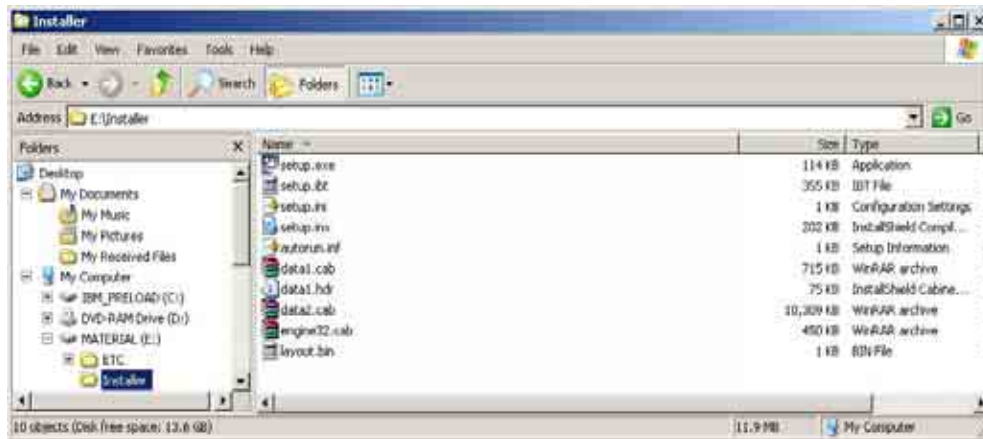

Figure 6-2 Installer Folder of EMS Program

If you double-click Setup.exe, the installer wizard is started, helping you to install the EMS program.

To uninstall the existing EMS program, select Start -> Program -> LG-Nortel -> SpeedLIGHT16 -> Uninstall SpeedLIGHT16.

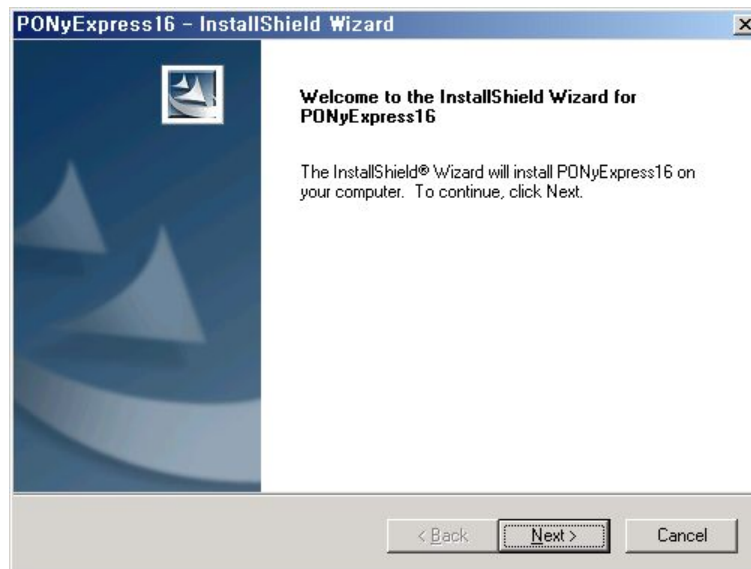

Figure 6-3 Installing EMS Program

2.3 Recommended specifications of PC for EMS operation

- 1) Pentium P4 1.5GHz or higher performance
- 2) VGA with 256 colors and 1024* 768 or higher resolution
 - ※ The screen will be crushed if you change to 1024*768 less, this time just restart EMS program.
- 3) Free memory space of 512M Byte or more
- 4) ***Microsoft Windows 2000 service pack 4 over or XP (recommended)***
- 5) LAN card
- 6) Mouse

2.4 Console and IP setting

Connect the console port of the system with the COM port of PC via the console cable, and start up the hyper terminal.

Set bits per second of the hyper terminal to 9,600 bps as shown in the following figure.

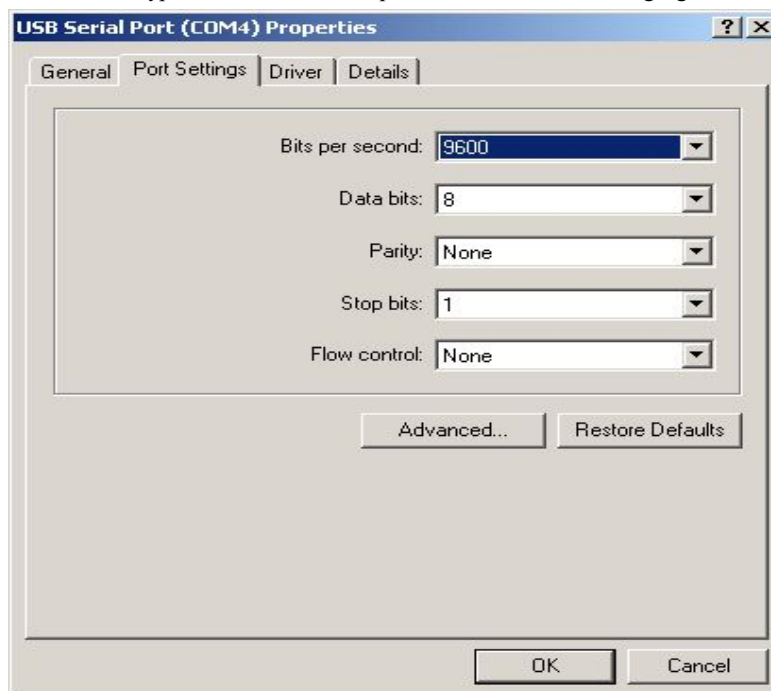

Figure 6-4 Hyper Terminal Setting

Log in to the system with the Admin ID. The initial ID and password are “root.”

Welcome to LG-Nortel SpeedLIGHT16

User Access Verification

Username: root

Password: ****

Check or change the IP setting of the system to enable network communication.

(Refer to CLI commands)

2.5 Starting EMS

- 1) Connect the EMS-installed PC to the network.
- 2) Switch on the system and start the system.
- 3) Connect the system, using the hyper terminal, to PC via the console port.
- 4) Enter the system IP on the MS-DOS screen as in “ping –
t system IP (e.g., 192.168.1.30)”, and check if the system receives the message through network. If the message “Request Time Out” is displayed on the MS-DOS screen, check the configuration of LAN. If the message continues to display, check the IP of the EMS-installed PC, so that the system can interwork with the network.
- 5) Double-click the “SpeedLIGHT16” icon which was created on the desktop through the EMS installation process.

2.6 Interworking between EMS and system

- 1) Enter the user ID on the main EMS window.
- 2) Enter the password. ID : root Pass : root
- 3) If the login success window is displayed, click OK. Then the system control mode is on.
- 4) If the login fail message is displayed, check the password, and repeat the steps 1)-3).
- 5) If you successfully log in to EMS, the EMS main window is displayed.

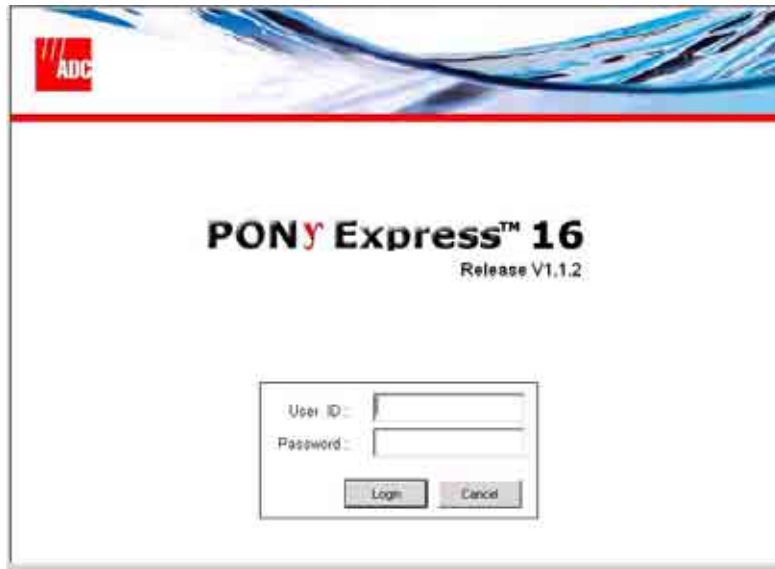

Figure 6-5 EMS Login Window

2.7 EMS window

As above mentioned in 5.2.6, if you type the password on the EMS main screen, the EMS control window is displayed. The figure shows the screenshot of the EMS window.

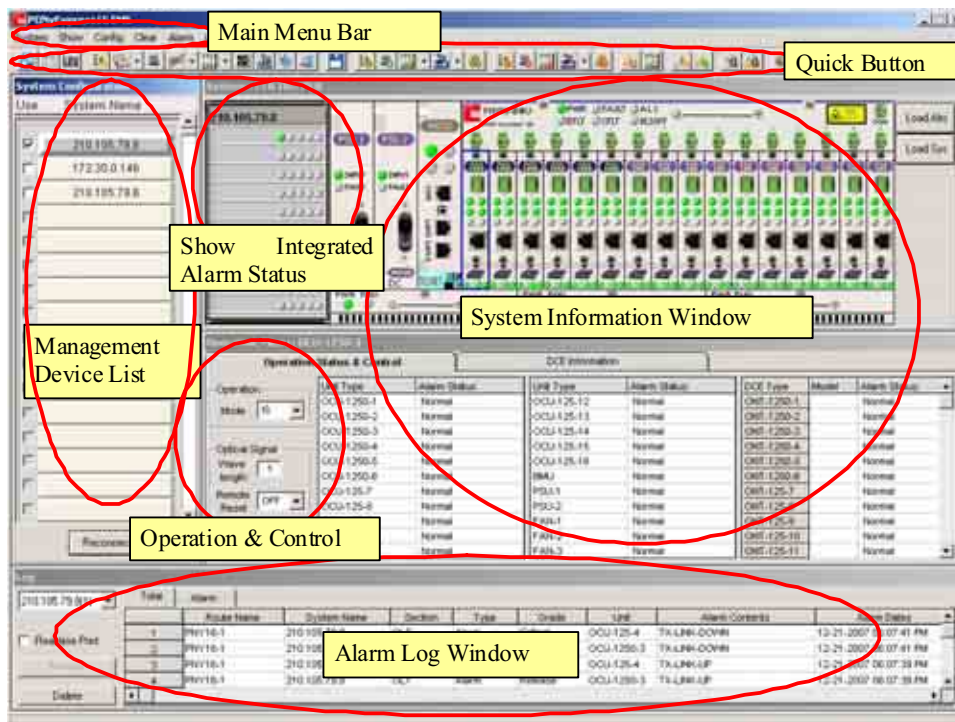

Figure 6-6 EMS Main Window

- 1) You can select System, Alarm or User on the top menu bar.
- 2) The System pane in the right shows the status of a system, OCUs mounted in the system, and the states of DCE connected to each OCU.
- 3) In the Operation menu in the center, you can view and set the fault status of OCU of OLT, operating parameters and the state of DCE.
- 4) The Alarm Log pane in the bottom of the window shows the list of events occurred in the system.
- 5) The Management Device List in the left of the window displays the list of systems managed by EMS. You can add, delete or modify information.

The following tree shows the menus you can use in this EMS.

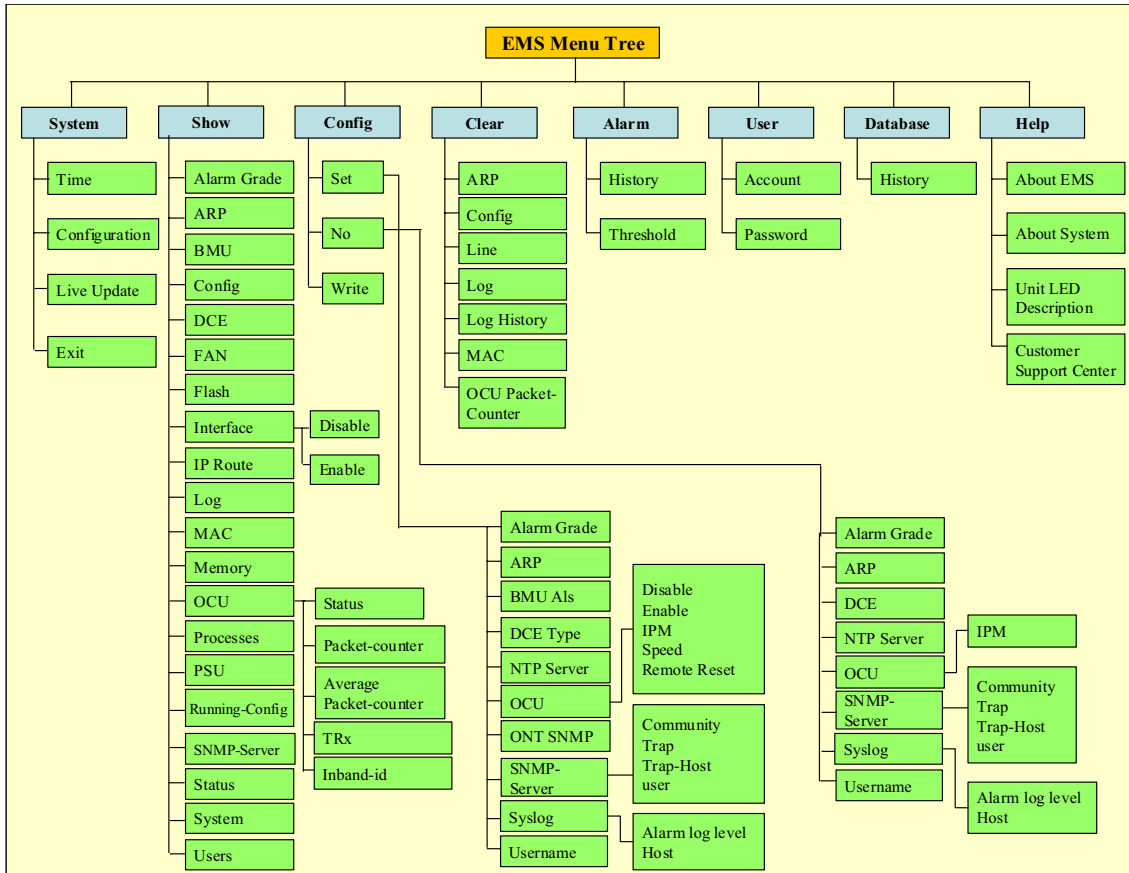

Figure 6-7 EMS Menu Tree

If you log in to EMS, you can integrate a number of systems by viewing and controlling state of up to 50 systems and their terminal devices. When started, EMS imports information on the registered systems and configures the basic data for operation of EMS.

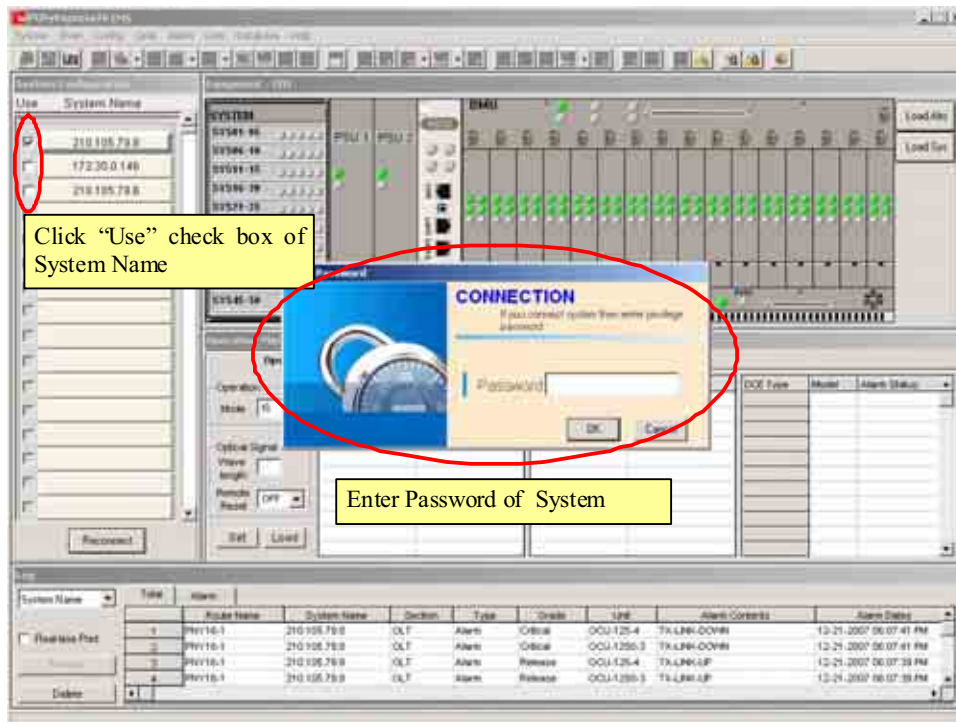

Figure 6-8 Click “Use” Check Boxes

Click the “Use” checkbox in the “System Name” list, and enter your password in the pop-up window. If the password is valid, a connection message is displayed, and the actual view of the selected device is displayed in the window, with real-time status and alarms of each unit. In case the system status does not match between EMS and actual configuration, you can retrieve the status information from the system and update the EMS program, using the two buttons in the top right of the window provide the search function.

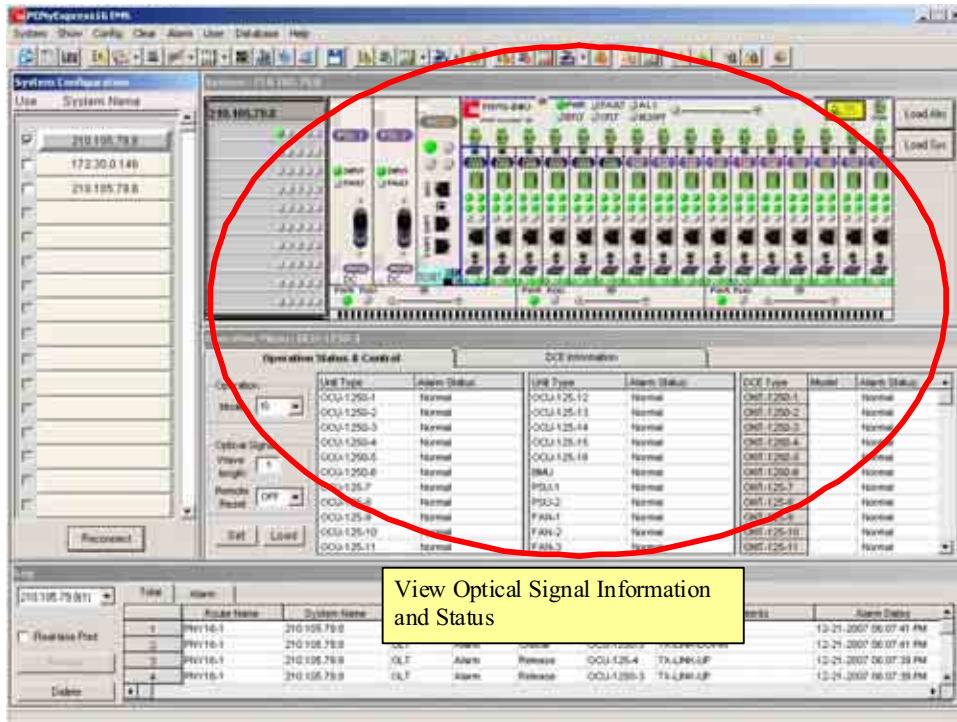

Figure 6-9 EMS Window Connected with a Specific Device

3 System management

3.1 Time setup

If you select “System” in the main menu, and then select “Time,” the system time window pops-up as shown in Figure 5-10. You can retrieve time from the system or set the time in PC.

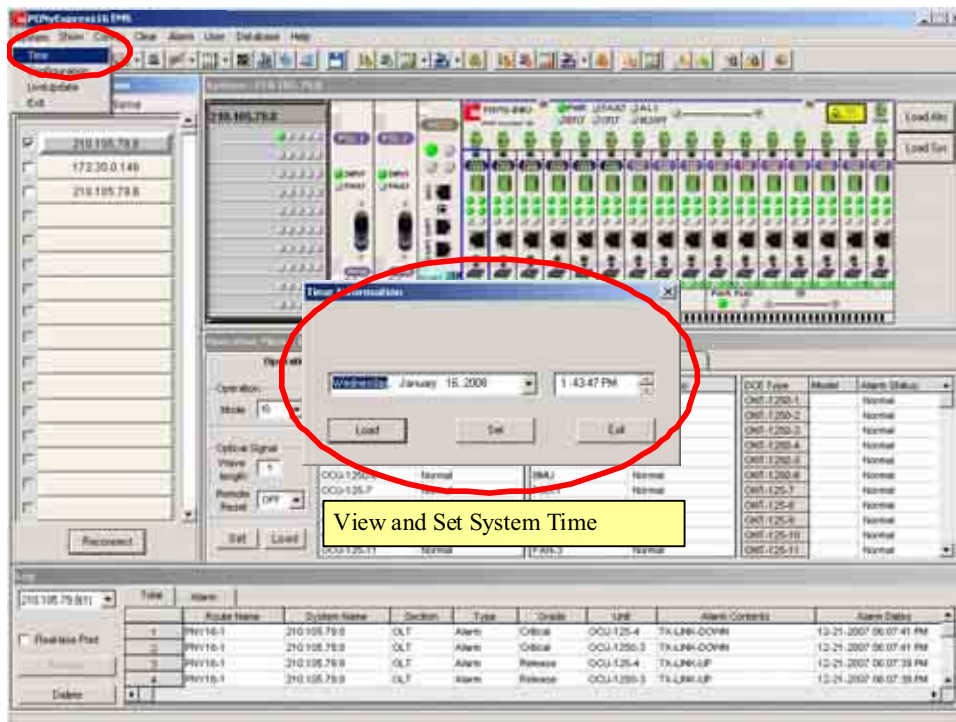

Figure 6-10 System Time View and Setup

3.2 Device information

You can modify, update and delete the management object via the device management function. Since this function interworks with the socket communication function, you can continue using EMS without restart it after you have added, modified, or deleted device.

You can configure system connection on EMS.

Select “System” and then “Configuration” from the top menu, and register system name and IP. Then, by selecting “DCE Information,” you can view and manage DCEs with the recent information received from the system.

To delete a system, double click the system name or select “Configuration,” and in the pop-up menu, click the “Delete” button.

A. Registration of system

1) System registration 1

This is used to register a new device. To add a new device, double-click a button with no “System Name” in the System Configuration list.

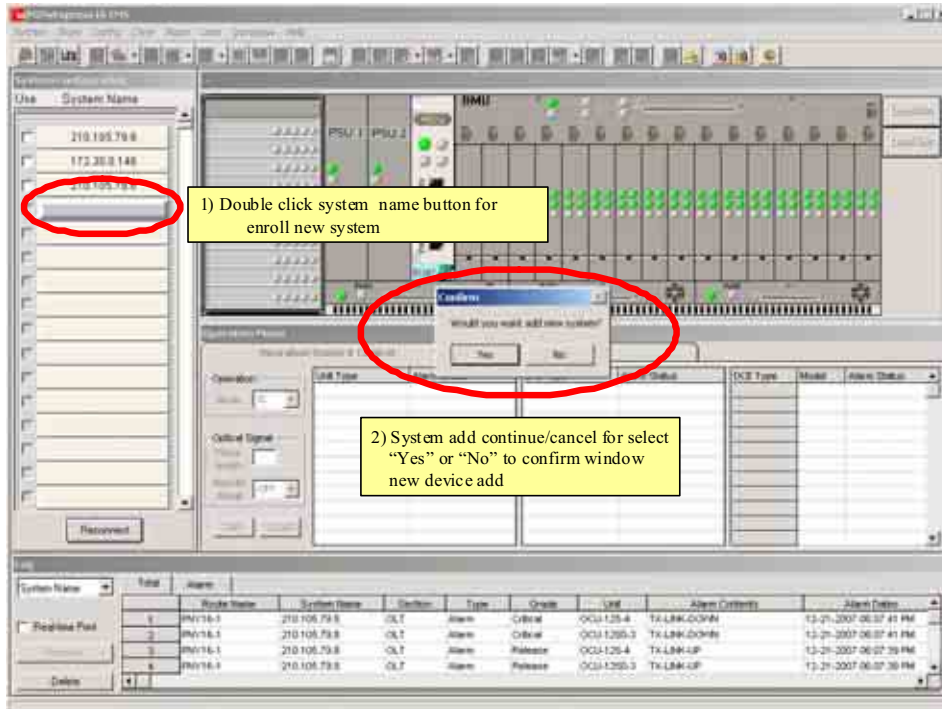

Figure 6-11 System Registration 1

2) System registration 2

If you double-click the button for the new system, the following Configuration Information window pops up. Fill in the appropriate fields and click the “Add” button.

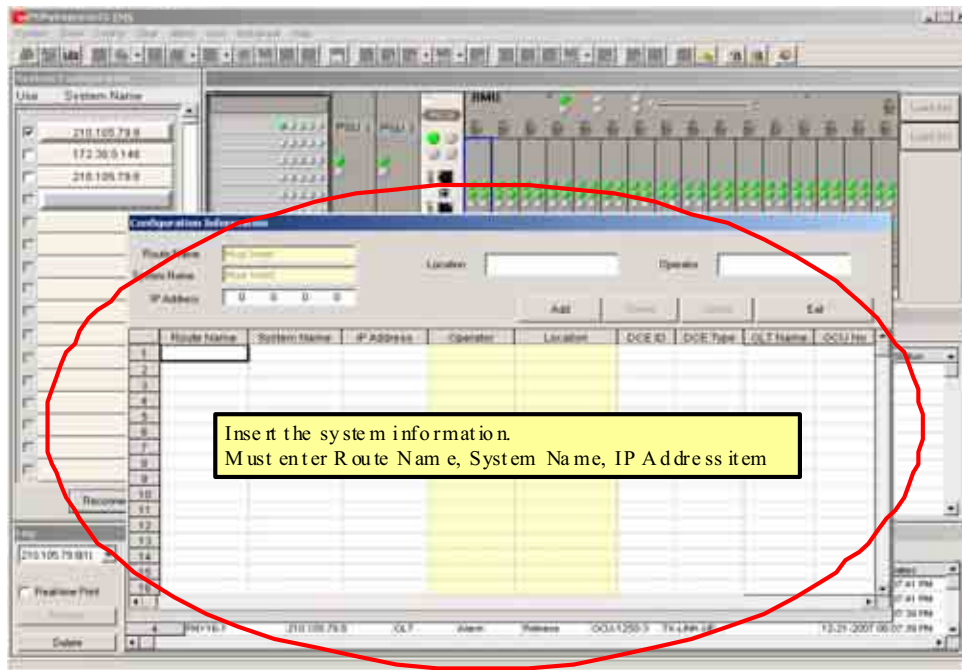

Figure 6-12 System Registration 2

3) System registration 3

If you click the “Add” button, a confirmation message box pop—up. Click the “OK” button. After registration of the system, click “Exit” to apply new configuration in the program. The list field shows the information of DCE retrieved from the system. You can enter the operator and location of DCE.

B. Updating system configuration

If you double-click the system button (the button on which the registered system name is marked), the following Configuration Information window pops up. In this window, modify information and click the “Update” button to save the modified information in the database. After finishing modification, click “Exit” and repeat the Registration Step 3 to update EMS.

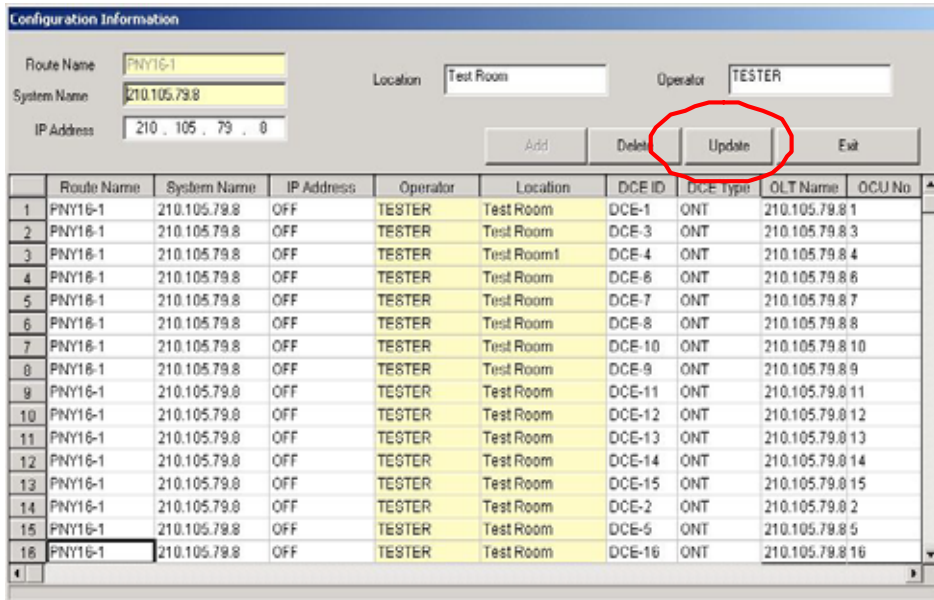

Figure 6-13 Updating System Configuration

C. Deleting system

If you double-click the system button (the button on which the registered system name is marked), the following Configuration Information window pops up. If you click the “Delete” button, the delete confirmation window is displayed. Click “OK” to delete the system. After deleting the system, click “Exit” and repeat the Registration Step 3 to update EMS.

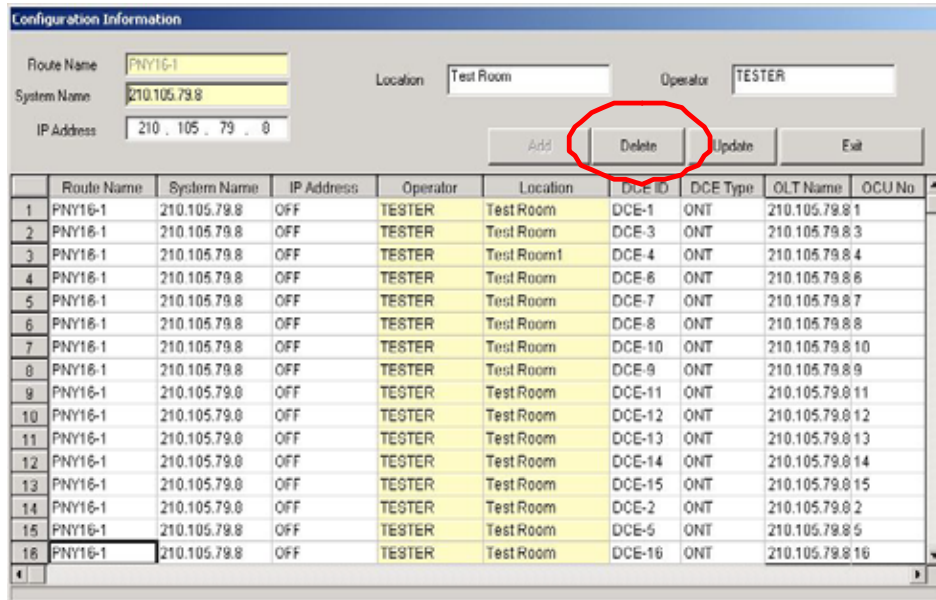

Figure 6-14 Deleting System Configuration

3.3 System reset

You can reset the system if it operates abnormally or if you wish to reboot the system. To reset the system, select “System Reset” from the pop-up menu displayed when you right click the MCU image, or double-click the Reset button image in the center of MCU. The following figure shows the image of system reset.

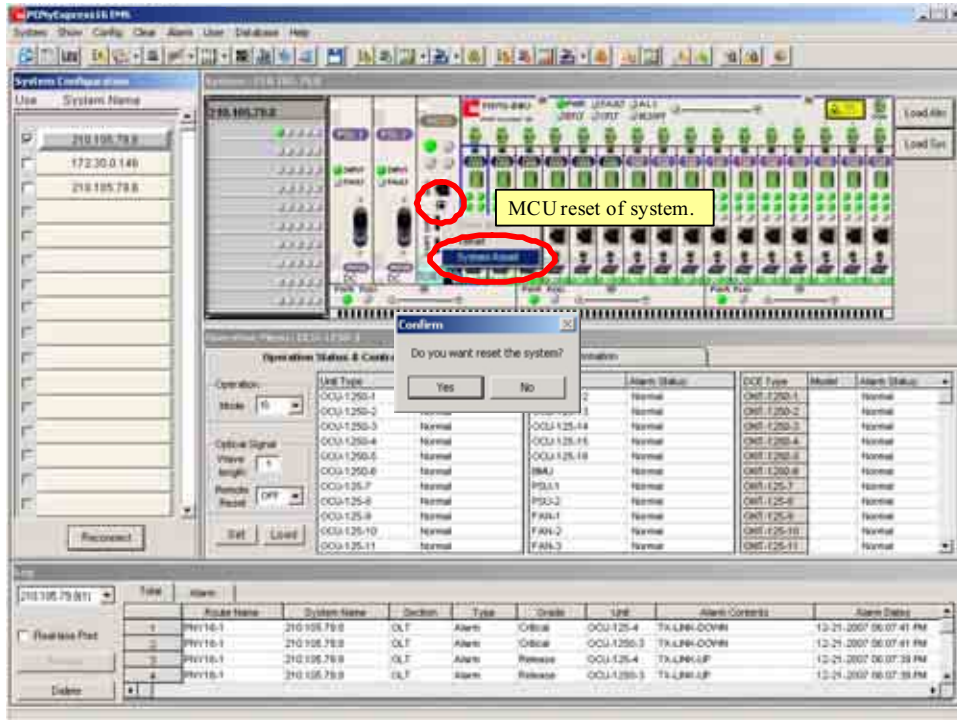

Figure 6-15 System Reset

4 Alarm management

This function enables you to view the alarm status and the system log data, and to set the alarm report/log condition. The faulty channel is indicated with red LED on the window and the front panel. Alarm status is displayed in the operation status and control in the center of the window. The following figure shows the screen shot.

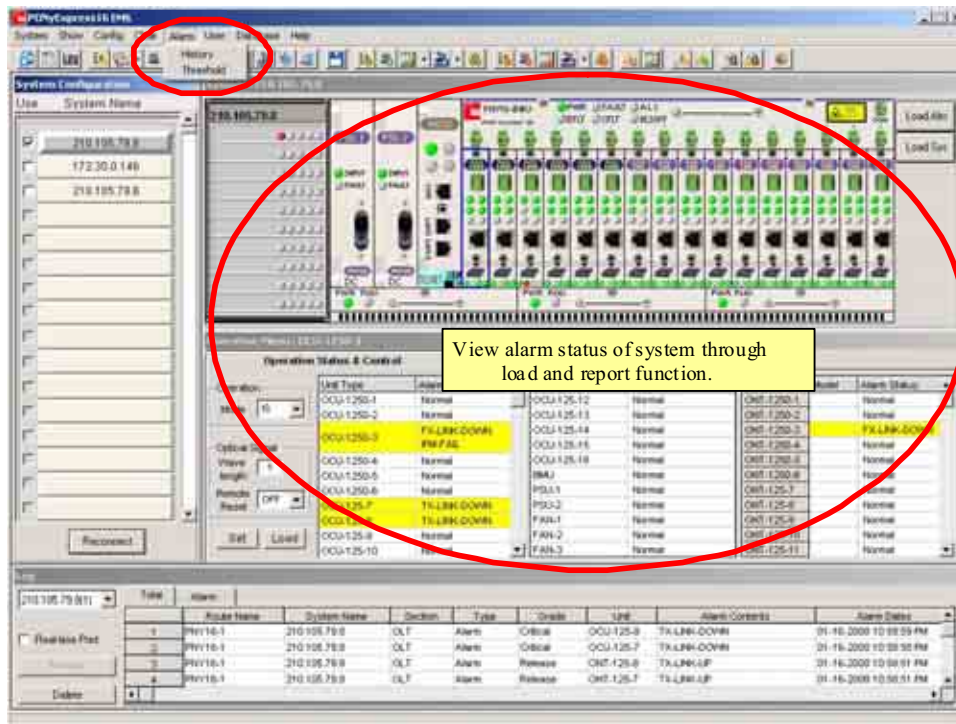

Figure 6-16 EMS Window for Alarm Management

<Table 6-1> shows the grades of alarm. The following alarm grades are default setting, and can be modified by the operator.

<Table 5-1> Types and Grades of Alarm

UNIT	ALARM	GRADE (Variable)
BMU	BMU-BTEMP	Critical, Major, Minor
	BMU-ELOS	Critical
	BMU-EDOWN	Critical
	BMU-CLOS	Critical
	BMU-CTEMP	Major
	BMU-CBIAS	Critical
	BMU-CDOWN	Critical
	BMU-ALS	Critical
	UNIT-OUT	Major
PSU A, PSU B	POWEROFF	Minor
	FAULT	Critical
	Unit OUT	Minor
OCU	FX-LINK-DOWN	Critical

UNIT		ALARM	GRADE (Variable)
		TX-LINK-DOWN	Major
		TEMP-FAIL	Critical, Major, Minor
		VCC-FAIL	Critical
		TX-BC-FAIL	Critical
		IPM-FAIL(RX-PWR)	Critical
		UNIT-OUT	Major
FAN	UNIT	POWER OFF	Major
	FAN1,FAN2,FAN3	FAIL	Minor
		UNIT-OUT	Major
ONT		FX-LINK-DOWN	Critical
		TX-LINK-DOWN	Major
		TEMP-FAIL	Critical, Major, Minor
		VCC-FAIL	Critical
		TX-BC-FAIL	Critical
		IPM-FAIL(RX-PWR)	Critical

This EMS is designed to log alarm occurrence/clearance in the database, and to report it to the operator. However, the operator can select which alarm grade will be reported.

The alarm is displayed with different colors in accordance with the severity, so that the user can easily recognize its severity: Critical alarm is displayed in red, major alarm in orange and minor alarm in yellow. Occurrence and clearance of alarm are indicated in the system in near real time.

The system provides the alarm history view function, and saves the history in non-volatile Compact Flash (CF), so that the data should not be deleted despite the system power off.

4.1 System log data

The system provides the fault history view function. You can clear alarm from the window only or delete the log data from the system.

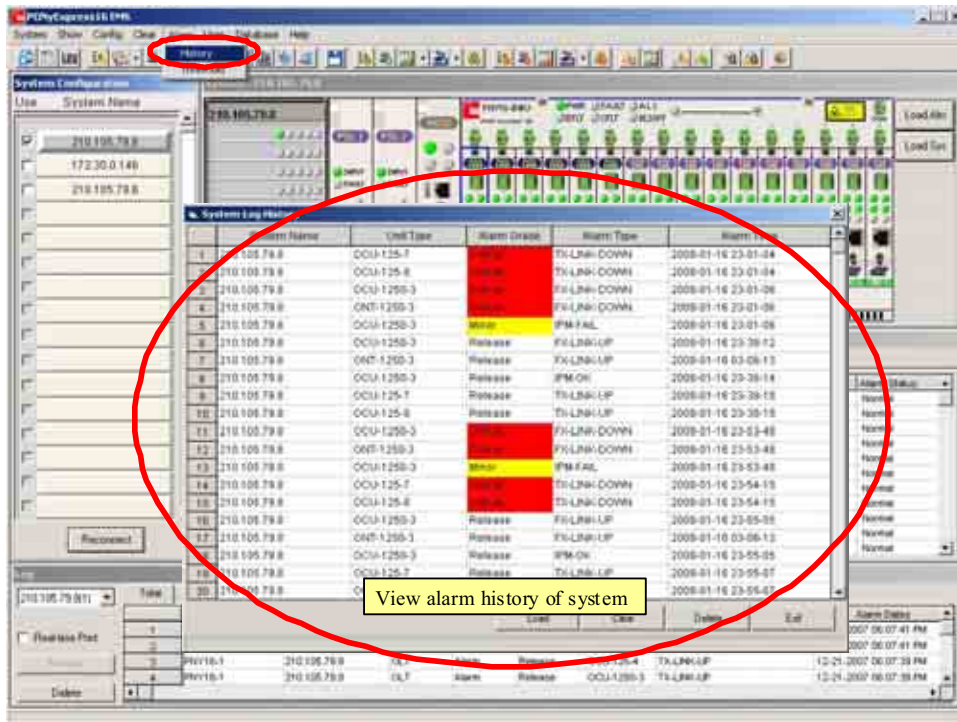

Figure 6-17 System Alarm Log

4.2 Alarm report condition setting

You can activate/deactivate report function depending on the alarm grade.

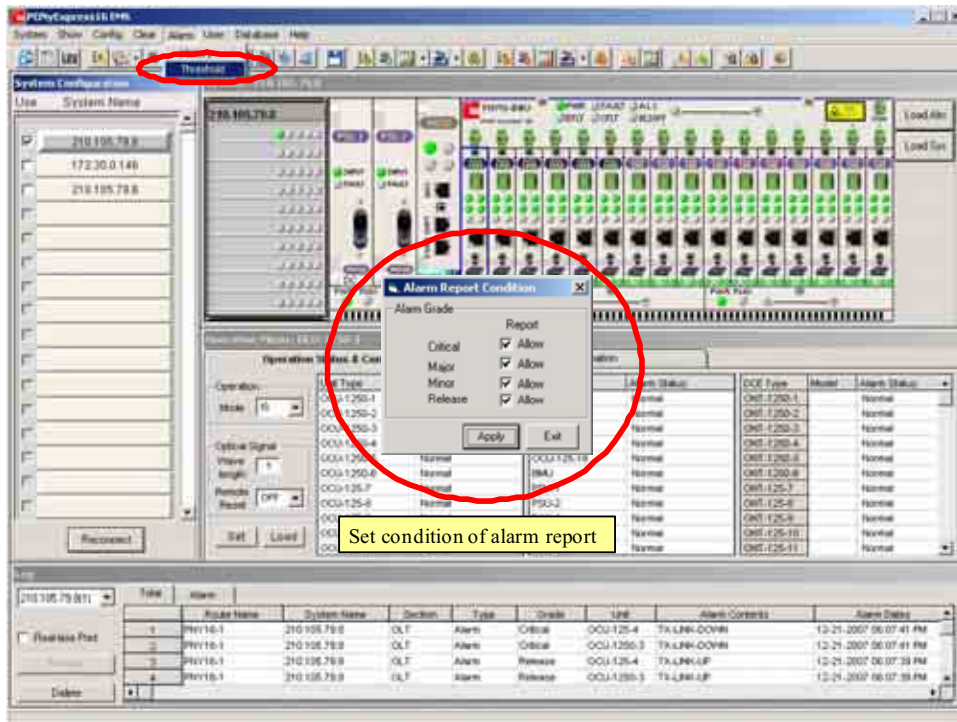

Figure 6-18 Report Condition Setting

4.3 Alarm view according to system grade

When an alarm occurs in the system, MCU LED operates according to the alarm grade. The LED indicates the grade of alarm. To see the list of alarms by grade, right-click on EMS MCU, and then, click “Show Alarm” in the pop-up menu. In the MCU Alarm window, there are 4 alarm grade buttons; “ALL,” “Critical,” “Major” and “Minor.” If you click the buttons, the window displays the alarms of the selected grade. If alarms occur in any other system than the current system selected by the operator, 50 alarm LEDs are on in red at the top left of the window. If you double-click an LED, the alarms of the system are displayed by grade. The alarm window is not displayed for any disconnected system. The following window shows the alarm window.

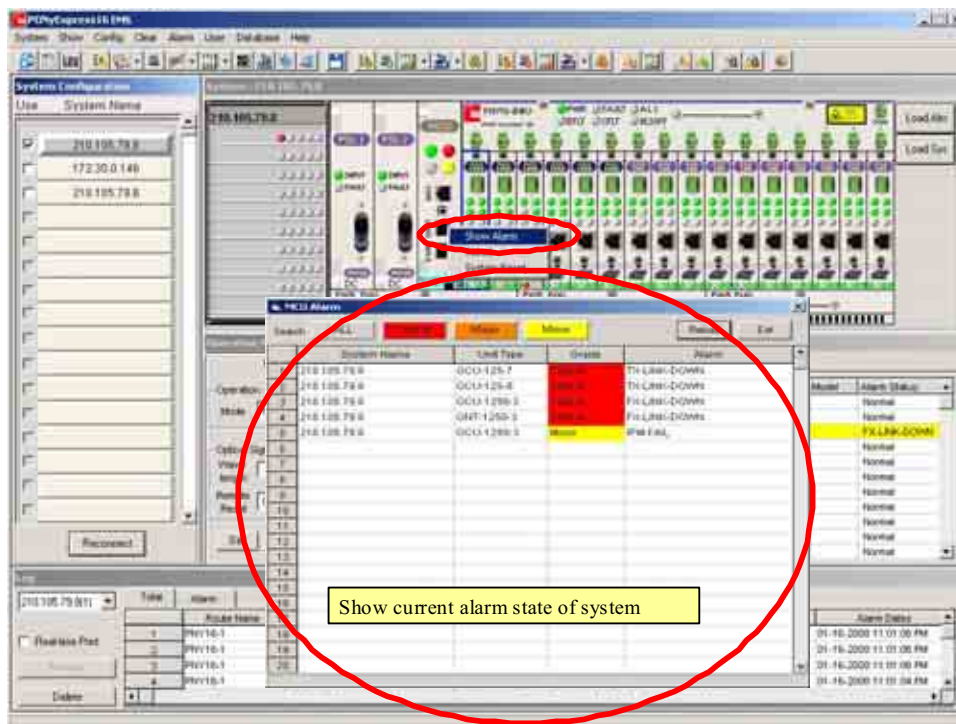

Figure 6-19 Current System Alarms View

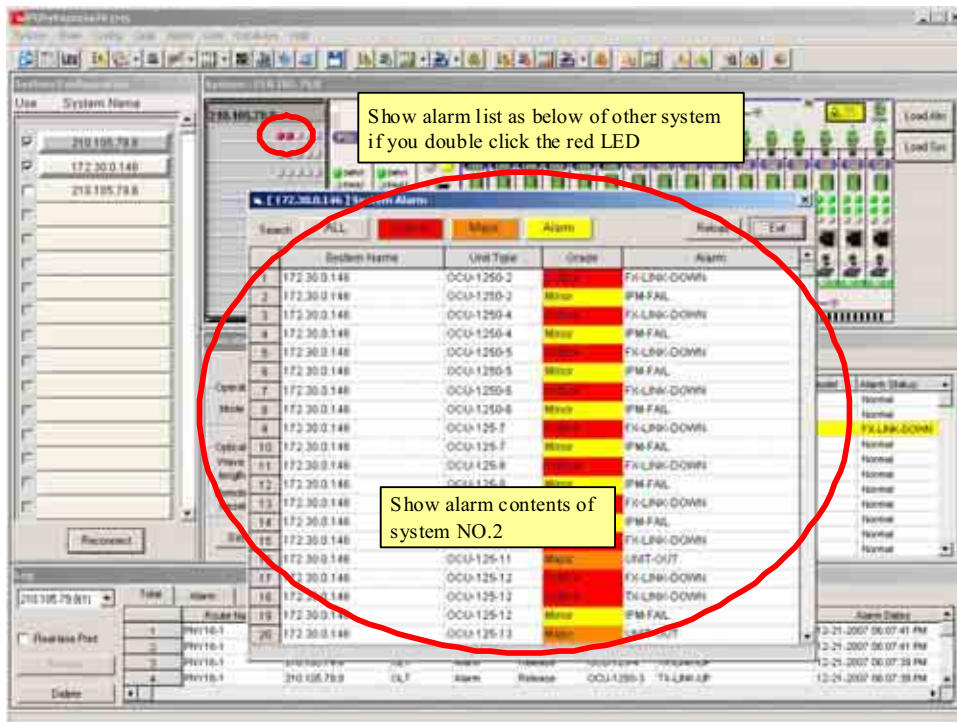

Figure 6-20 Other System Alarms View

5 User management

You can add/delete/change operator who can log in EMS and access the system. The user registered with this function has the right to access EMS only.

Accounts are divided into the “Administrator” grade users who can set/view the device status, and the “Normal” users who are authorized only to view the system status.

5.1 User account management

You can add/delete/update the user accounts for EMS.

Note



If no system is selected, the Add / Delete menus are deactivated.

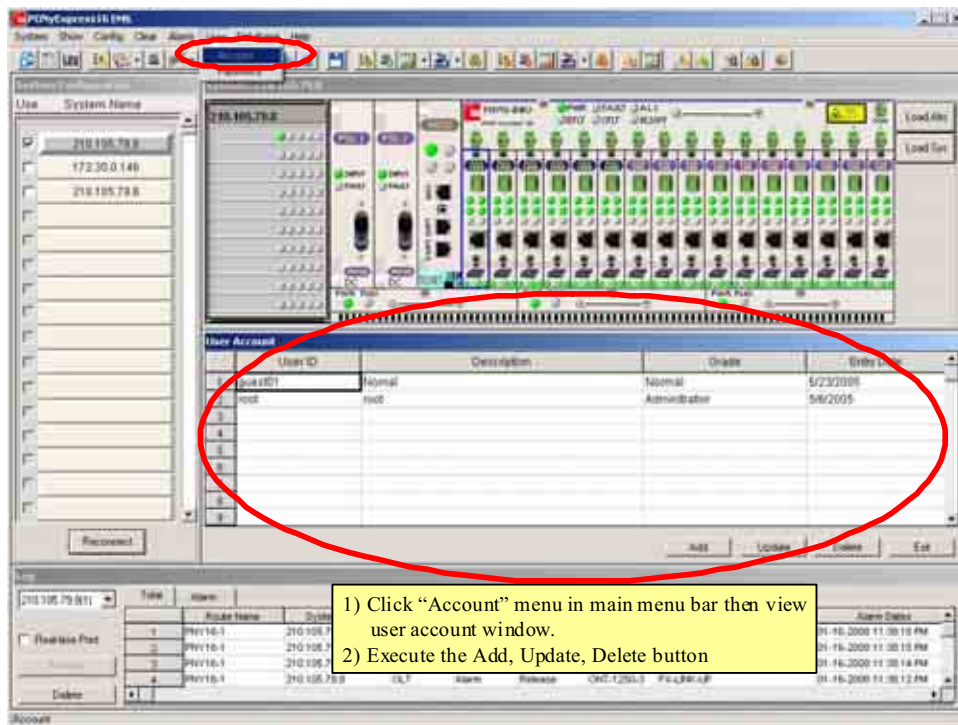

Figure 6-21 User Account Management 1

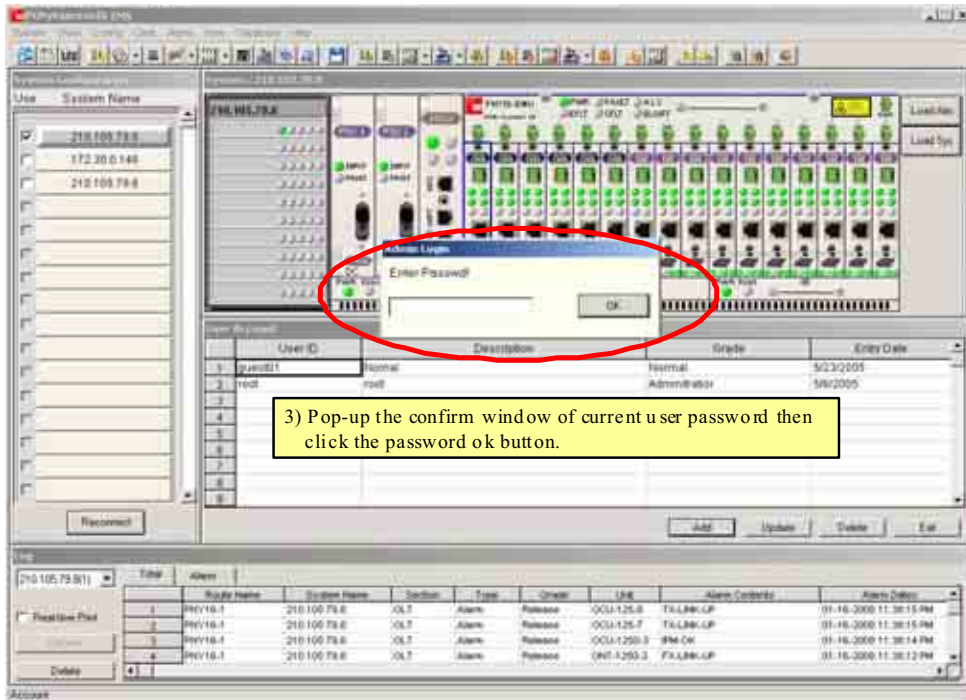

Figure 6-22 User Account Management 2

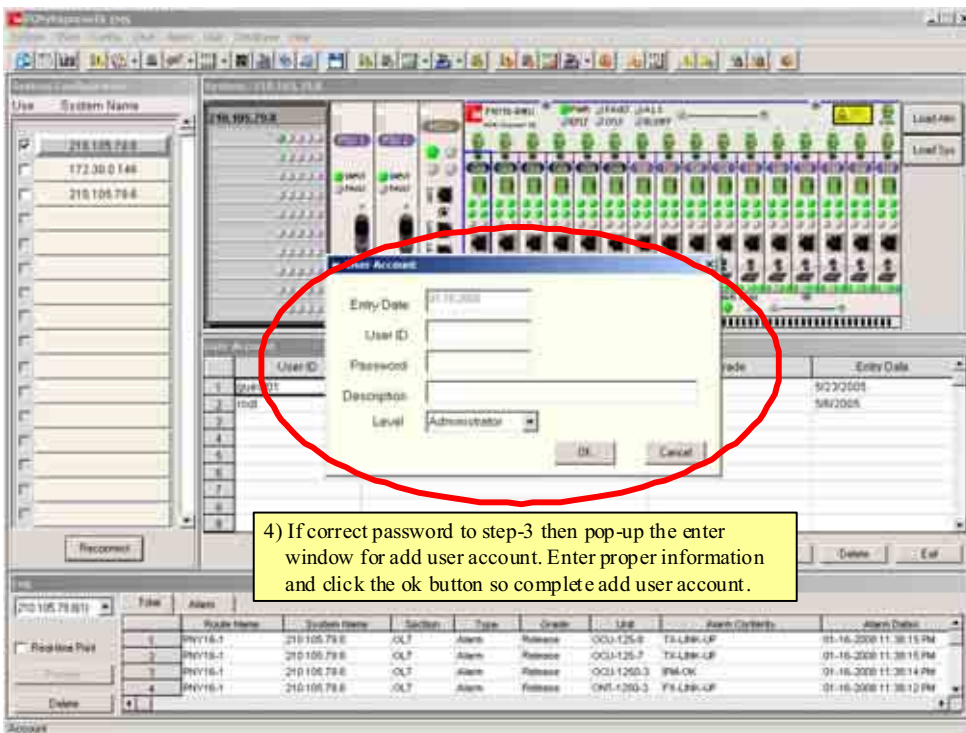

Figure 6-23 User Account Management 3

5.2 Changing user password

You can change your password while accessing EMS. To change your password, you need to select "User" in the top menu bar, and select "Password." Then the Change User Password window pops up as shown in Figure 6-24.

Type the current password in the pop-up window, and type a new password in the "New Password" field and the "Confirm Password" window.

After finishing this step, your password is changed, and you must use the new password if you want to log in the EMS from the next time.

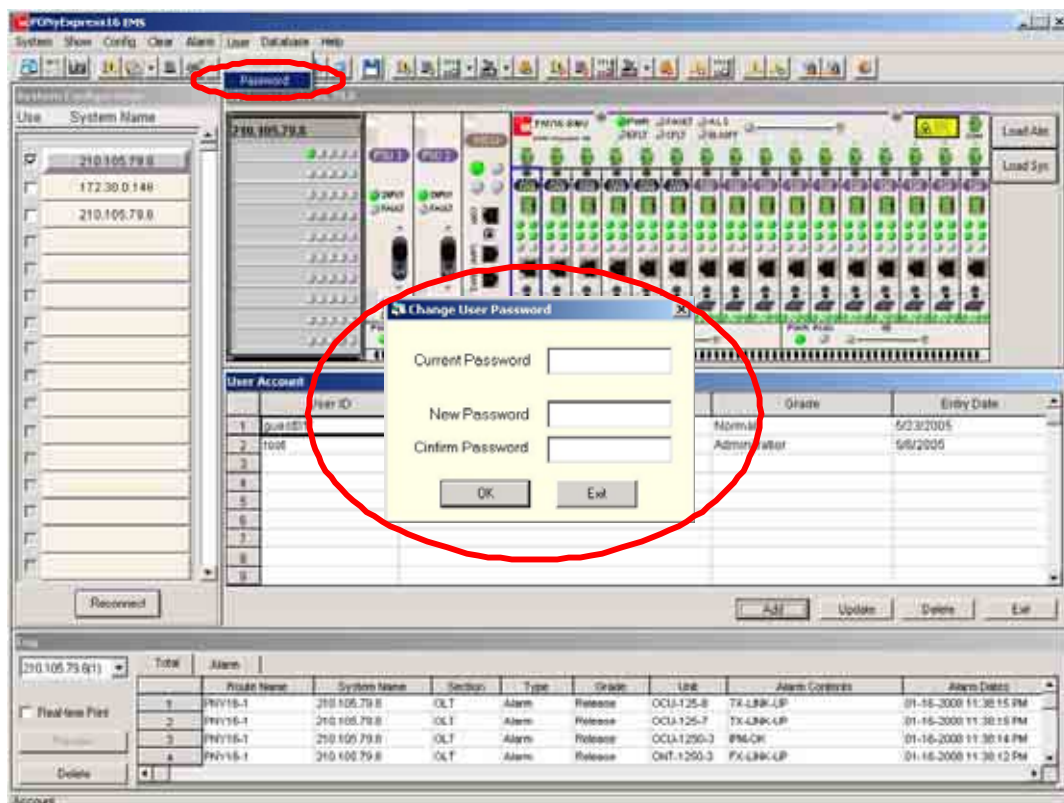

Figure 6-24 Change User Password

6 DB Management

When EMS is connected to a system, the alarm message is automatically reported to EMS. EMS stores the alarm messages in HDD, and enables you to view history. This function enables you to view command history and alarm history by time/by unit. One thing you should note is that while EMS is connected with a system, no alarm message is received. Therefore the EMS history cannot exactly match with the system. EMS retains alarm history for a year, and duplicates the database to protect the data.

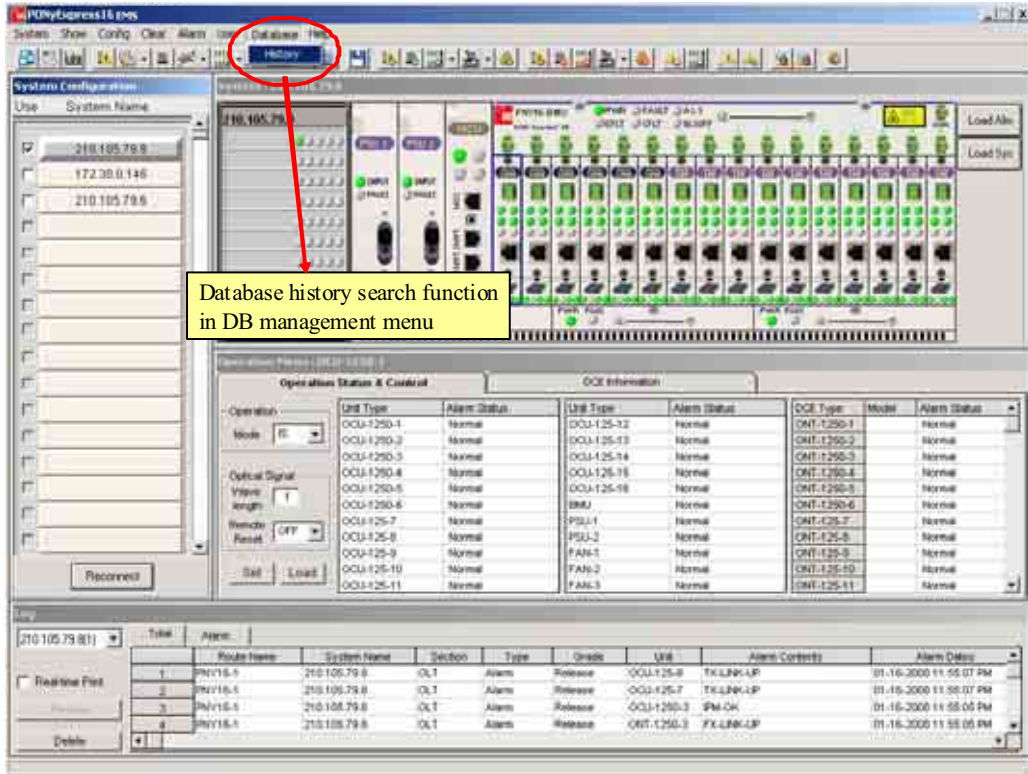

Figure 6-25 Database Management

6.1 History view and search

If you select “History” in the top menu bar, the search window pops up as shown in Figure 5-25. This window has two tabs: Command History and Alarm History. You can search history with the search conditions such as the network name, the date, the user ID, occurrence/clearance, the alarm type and the system name.

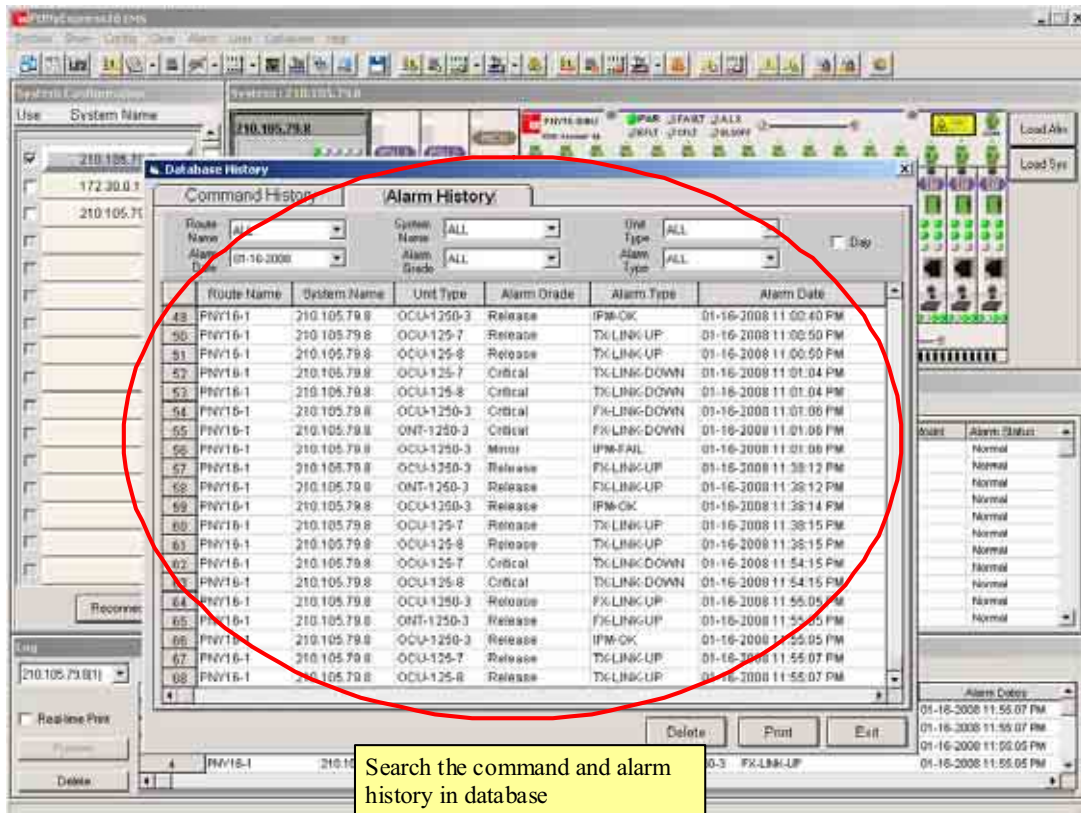

Figure 6-26 DB History View and Search

6.2 Alarm data display

EMS retries alarm data from DB at an interval of 3 seconds, and displays the data on the LOG window, with the recent data on the top. You can select the system name in the left of the LOG window.

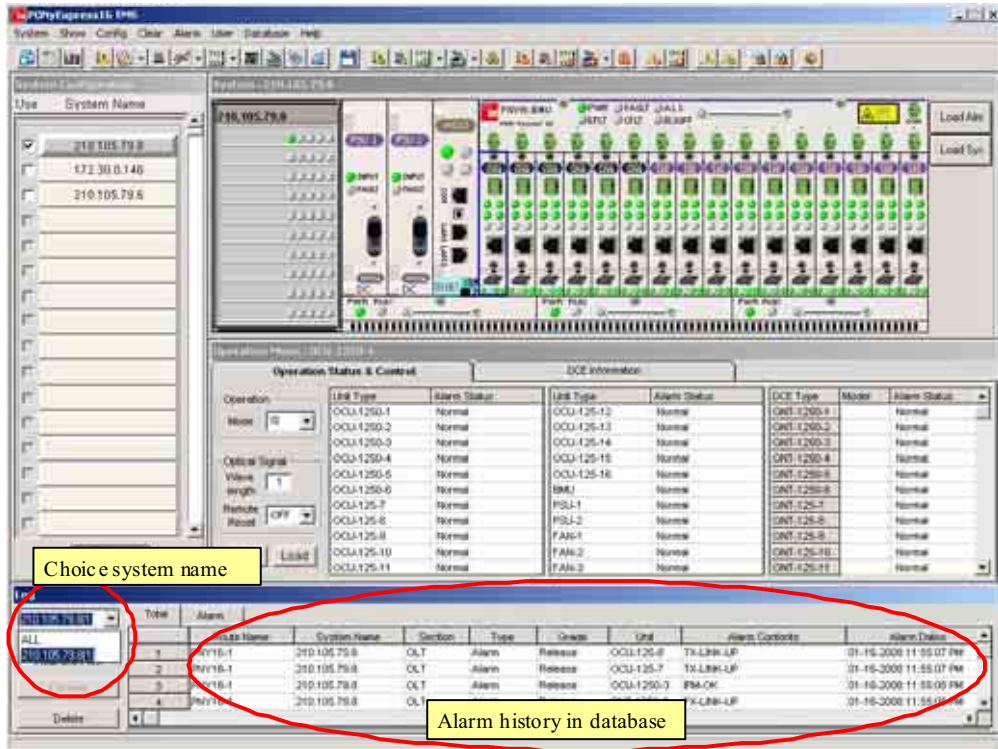

Figure 6-27 Alarm Data Display

6.3 Real-time alarm print

This function enables you to download alarm data in real-time from the system. Select the “Real-time Print” check box on the left of the Log window, and click “Preview” to display the real-time alarm data pop-up window. EMS displays the data in real-time upon receiving the alarm report from the system. The pop-up window also provides the “Clear” and “Print” buttons.

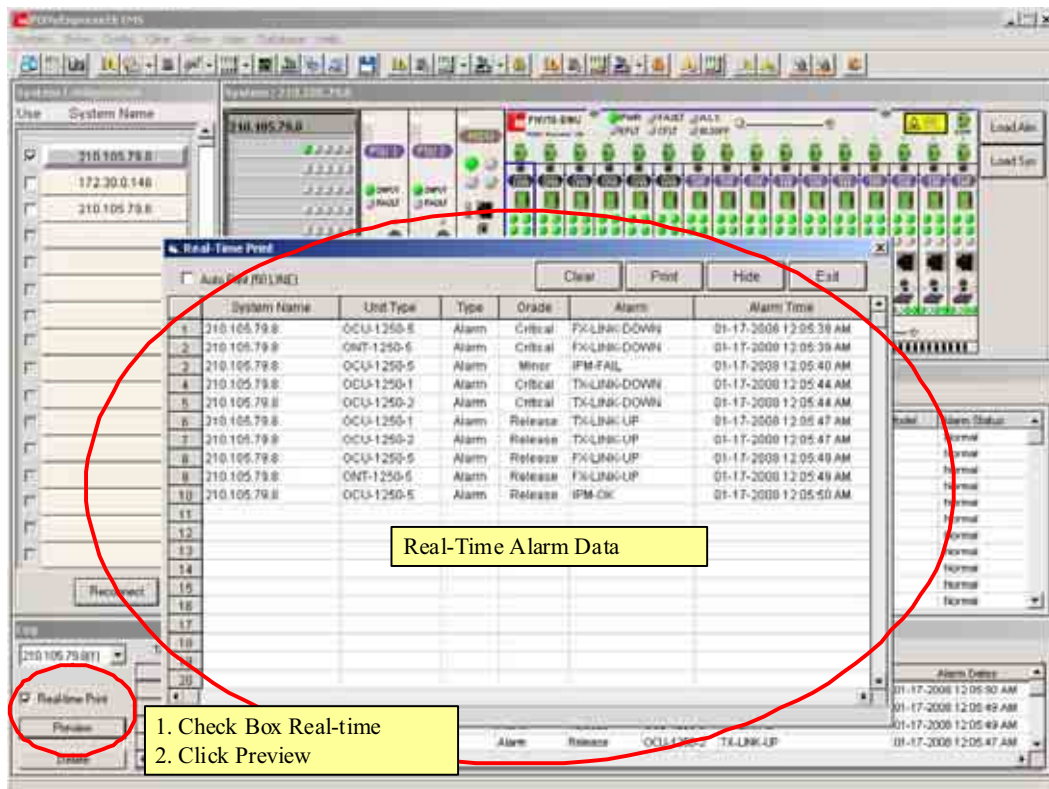

Figure 6-28 Real-time Alarm View

7 Configuration management

7.1 Optical signal setting

You can set the parameters for optical signal on the Operation Menu window in the center of the GUI window. In the “Operation status & control” window, the parameters required for operation of optical signal of each OCU in OLT are activated. The optical signal operating parameter values are as described below.

- Optical signal (Laser Diode:LD) : ON, OFF
 - Optical signal ON/OFF status of OCU is indicated. It remains ON for normal operation. You can switch OFF the function for test.
- Wavelength No. : Indicates the slot number for OCU.
- Remote Reset : ON, OFF
 - You can make the hardware-level command for remote reset from the system. It is OFF during the normal operation. This single-shot command is activated only once when the remote reset command is made. The ON status is not continued, and once the status becomes ON, it is always changed to OFF in the next system. If this function is used, the DCE which detects the signal pattern performs self-reset.

The following figures illustrate service status control and remote reset of DCE. You can use the function with the “Operation Status & Control” menu or with the pop-up menu displayed when you right-click the OCU channel card.

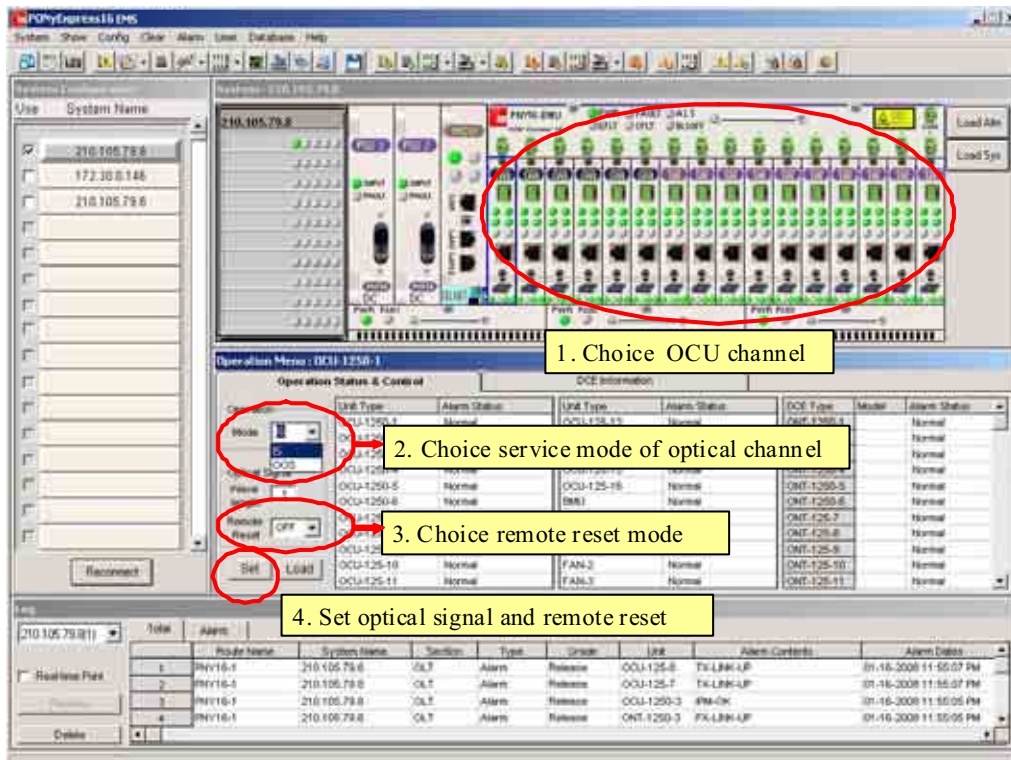

Figure 6-29 Operation Status & Control Menu

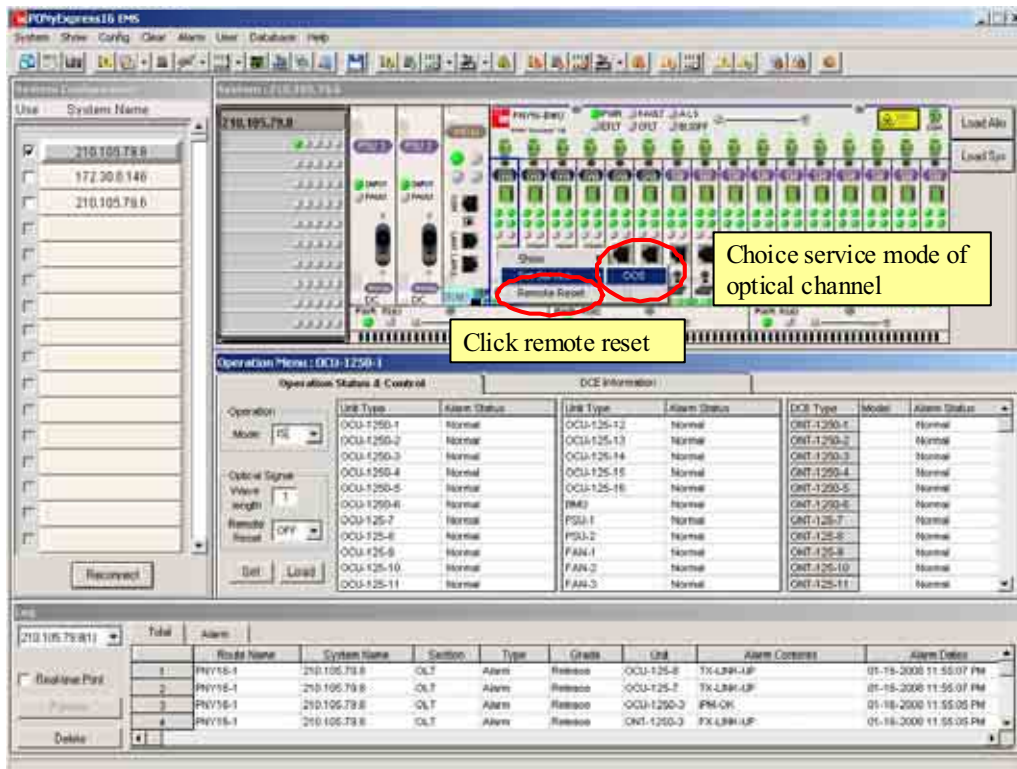

Figure 6-30 Pop-up Menu displayed when Right-Click the OCU Channel Card

7.2 DCE information

The system has a DCE per optical channel. EMS retrieves this information from the system, saves it in DB, and enables you to manage the system by entering operator and location of DCE. If you click “Load DCE” on the “DCE Information” page in the center of the EMS window, a confirmation window pops up, and EMS retrieves information on DCE from the system.

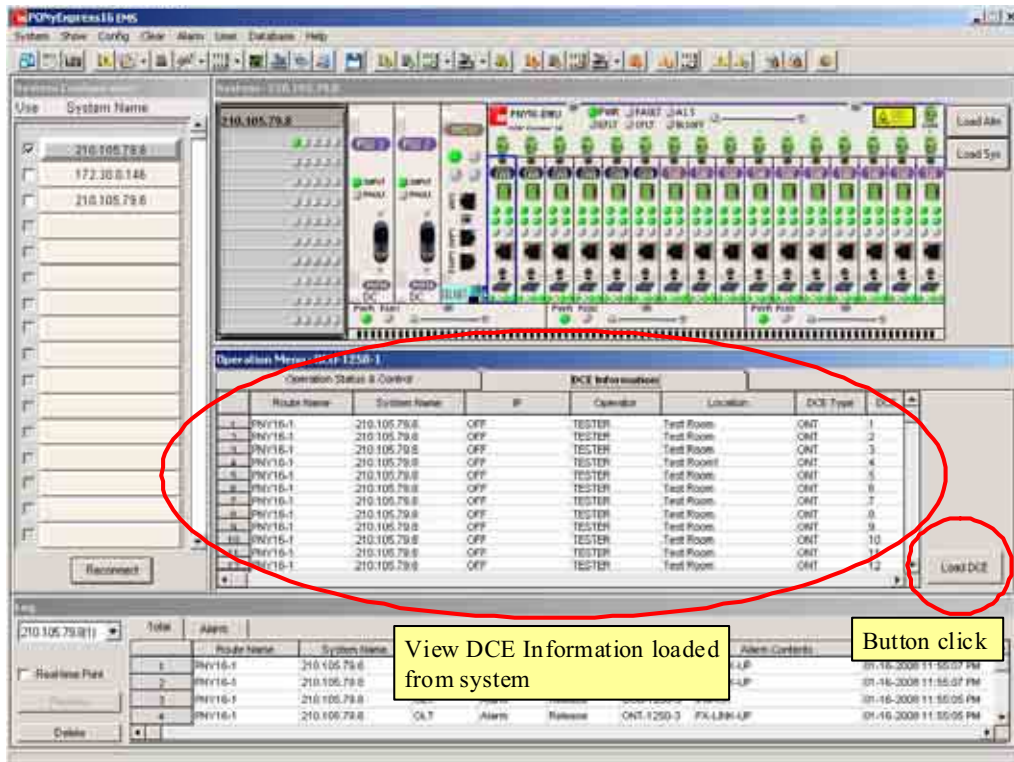

Figure 6-31 DCE Information

7.3 Remote connection to system

EMS can access the system through the remote terminal window, not with the console, for inspection and preventive maintenance of the system. If you wish to make connection to the system, double-click the Telnet image in the MCU board image on the EMS window. Then, a remote connection terminal window pops-up, makes connection to the system, and prompts you to enter the login ID and password. If you wish to make connection to an ONU for an OCU channel, you must double-click the ONT image on each channel slot image. However, you cannot make connection to ONT if the OCU channel card is deleted or the optical link is not configured.

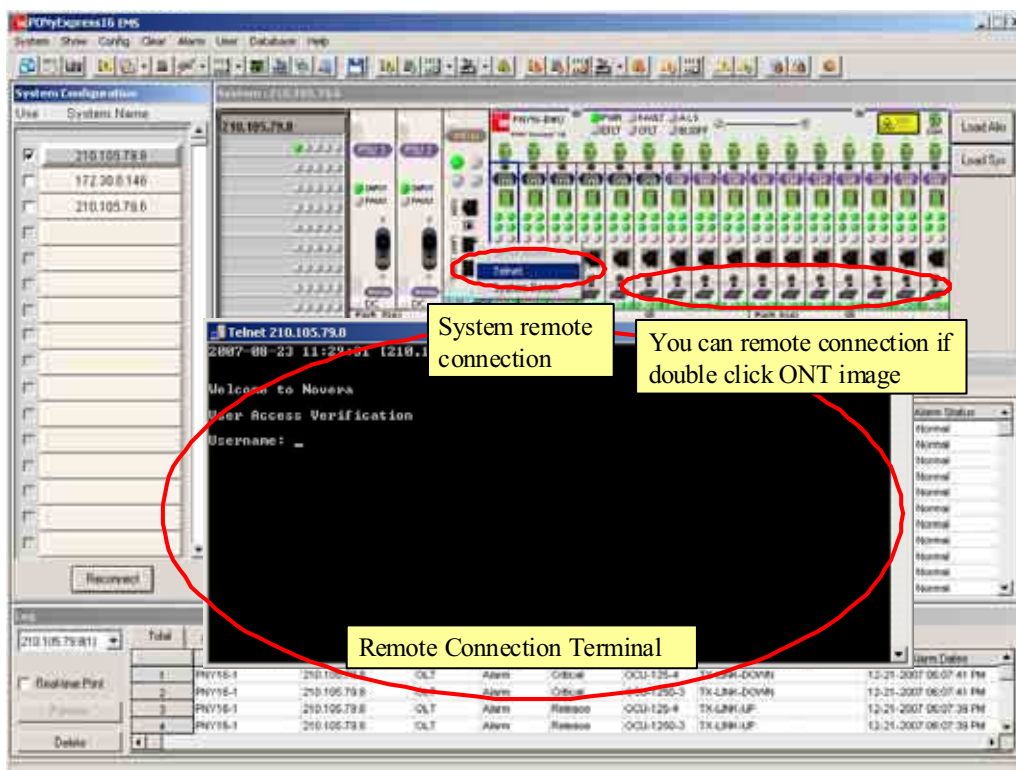

Figure 6-32 Remote Access

8 Like CLI Command

This menu provides function like CLI command of system. It consists of the menus, “show” “Config->Set” “Config->No,” and “Clear”. The detail descriptions of this function reference “Chapter 4. Managing system with CLI”.

8.1 Show

If you click the “Show” menu, shows all information of system.

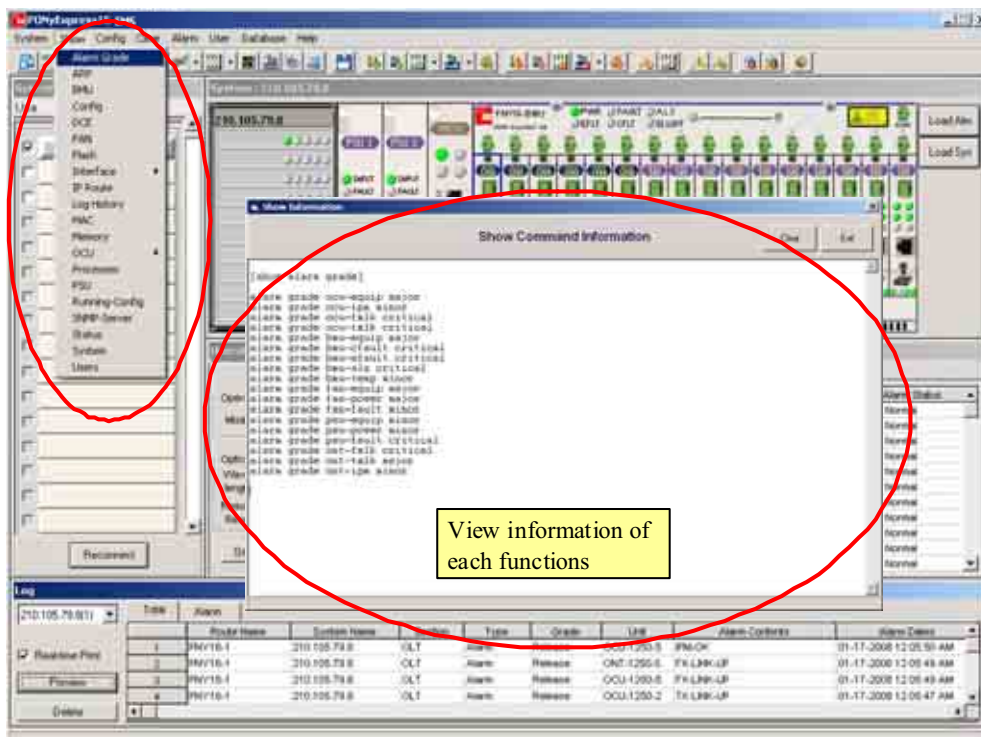

Figure 6-33 Show all information of system

8.2 Config->Set

If you click the “Config->Set” menu, set all function of system.

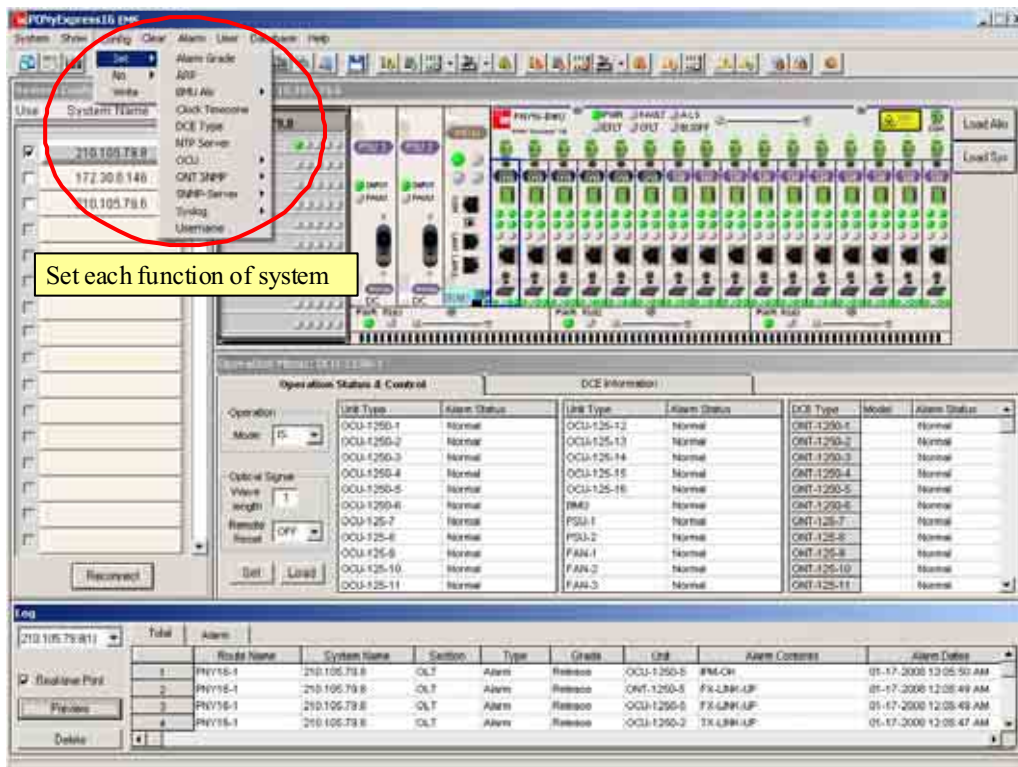

Figure 6-34 Set all function of system

8.3 Config->No

If you click the “Config->No” menu, negate all function of system.

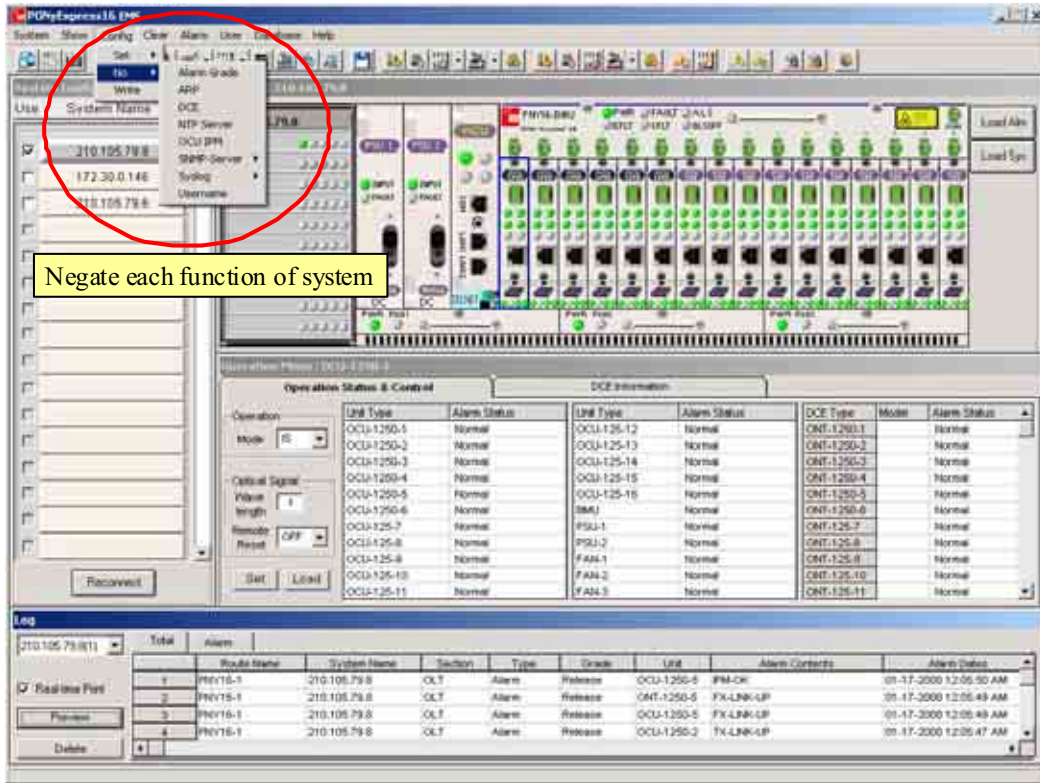

Figure 6-35 Negate all function of system

8.4 Clear

If you click the “Clear” menu, clear all function of system.

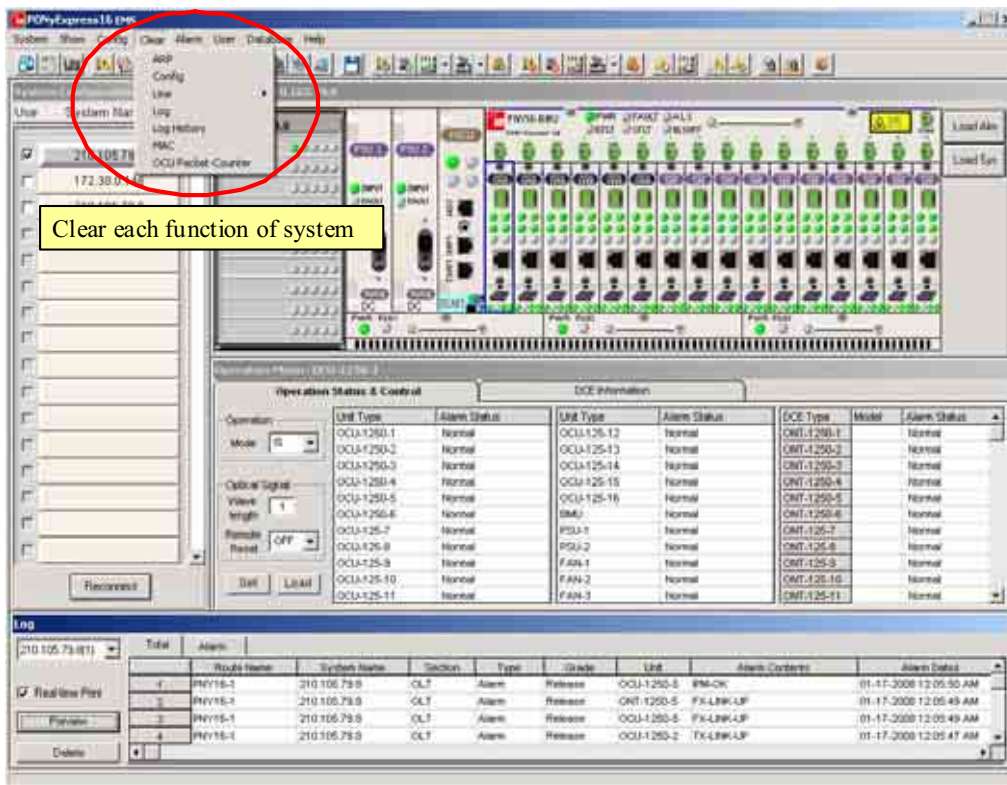

Figure 6-36 Clear all function of system

9 Help

This menu provides help for operating EMS. It consists of the sub-menus, “About EMS,” “About System,” “Unit LED Description,” “Support Center” and “User Manual.”

9.1 EMS information

If you click “About EMS” in the “Help” menu, the EMS Information window pops up. This window shows the EMS name, the version and the connected system model.

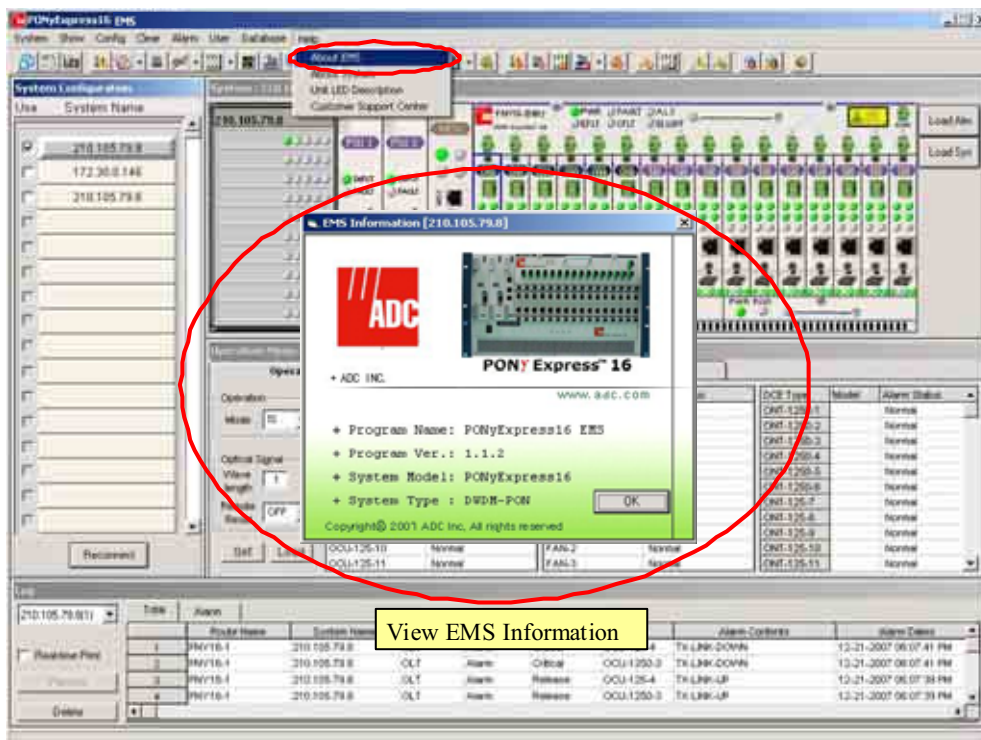

Figure 6-37 EMS Information

9.2 System information

If you click “About System,” the System Information window pops up, showing the system name, the model and the version.

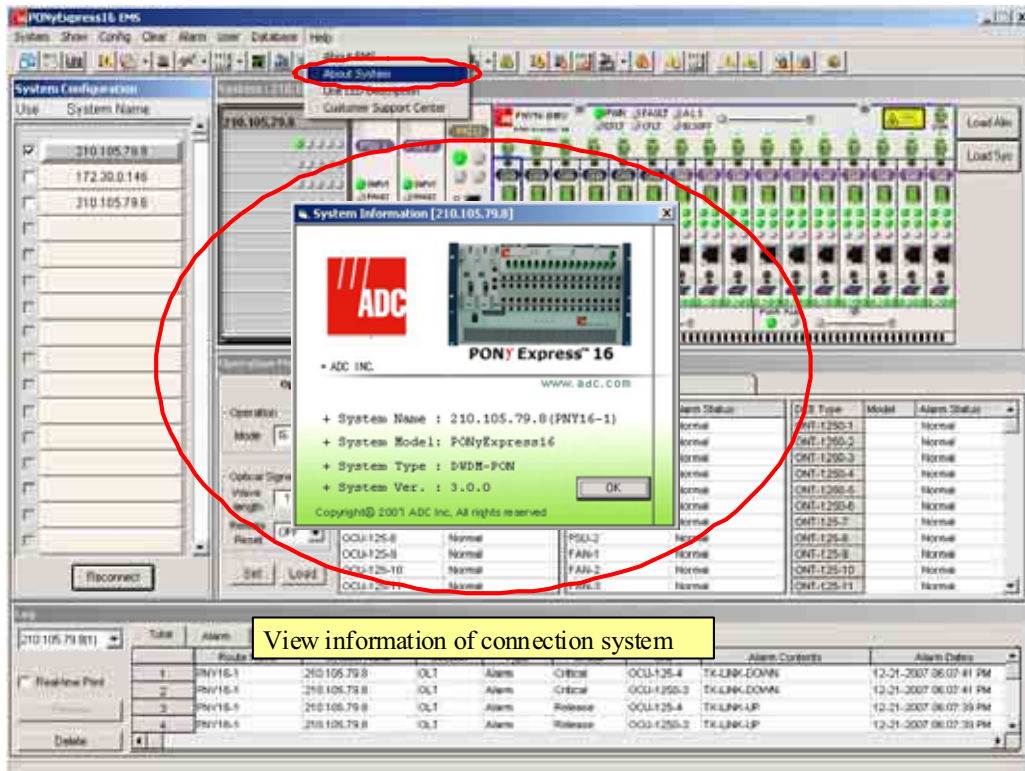

Figure 6-38 Information on Connected System

9.3 Unit LED description

If you click “Unit LED Description,” the Unit LED Description window pops up, showing LED names and operation states of OCU and ONT.

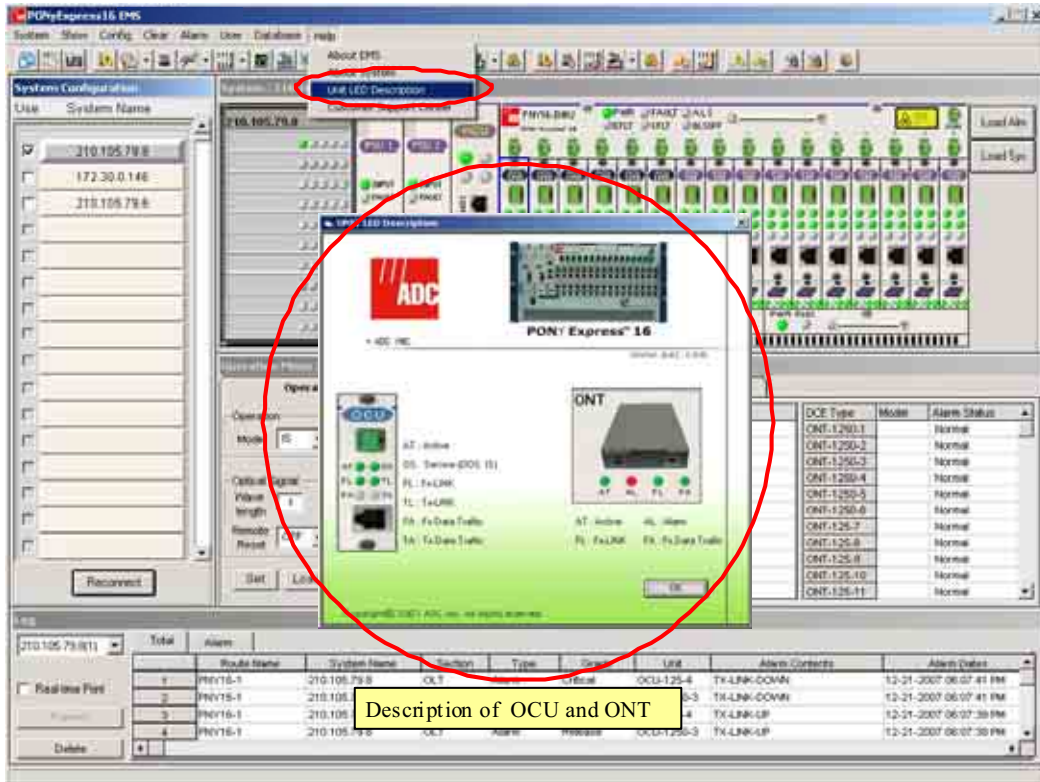

Figure 6-39 Description on OCU and ONT LED

9.4 Customer Support center

If you click “Customer Support Center,” the Support Center window pops up, showing the address and the contact information of LG-Nortel.

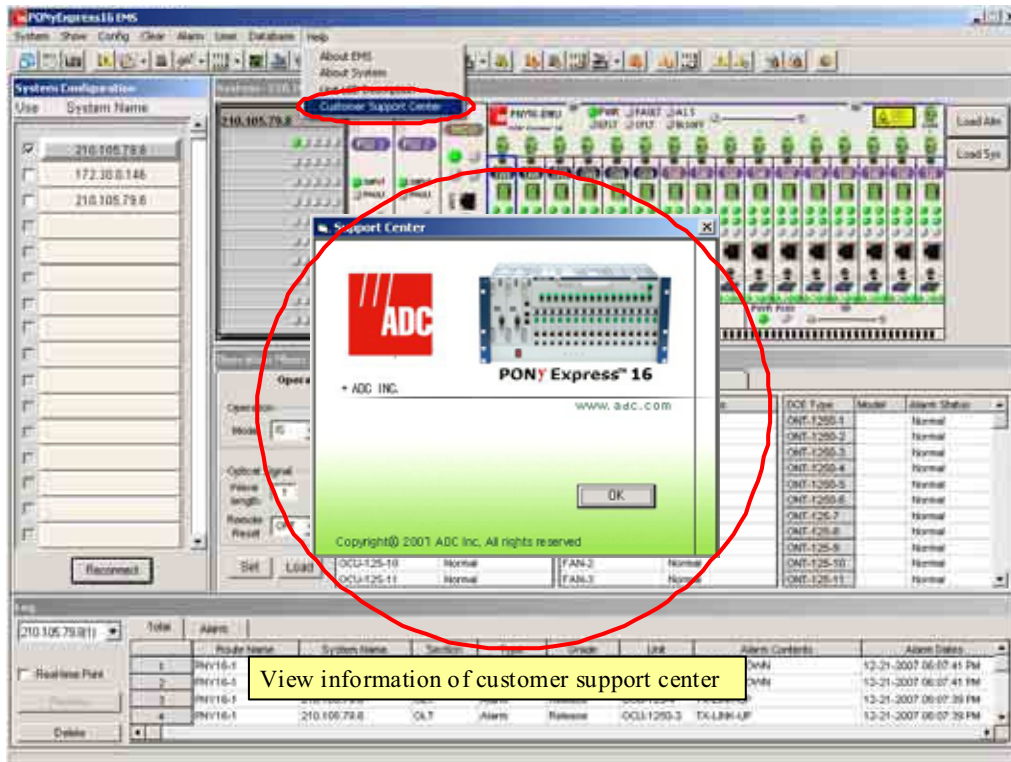

Figure 6-40 Information on Customer Support Center

10 Quick Button

The created quick buttons for each commands under the main menu. The text description for the command is shown when mouse arrow is on the quick button. It executes the commands when clicking the quick button.

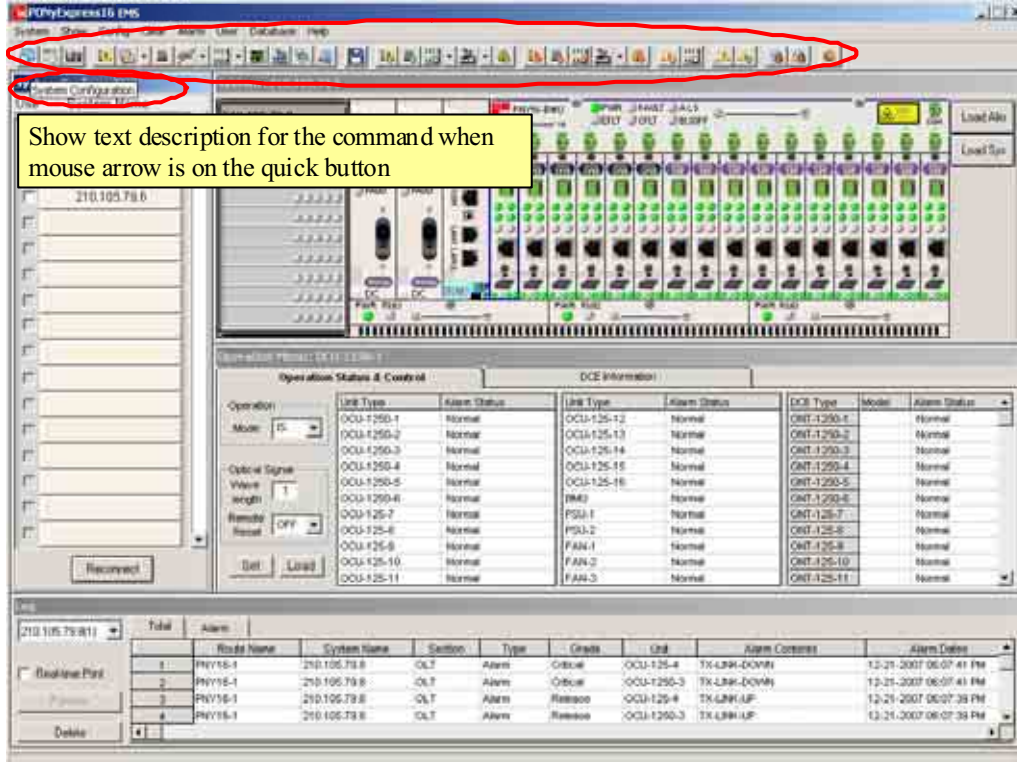

Figure 6-41 EMS quick button

11 LiveUpdate

11.1 LiveUpdate menu

LiveUpdate automatically updates the system as you select the targets for update when the system is upgraded or a new version of OS is released upon request of the customers. The LiveUpdate window pops up when you click “LiveUpdate” from the “System” menu.

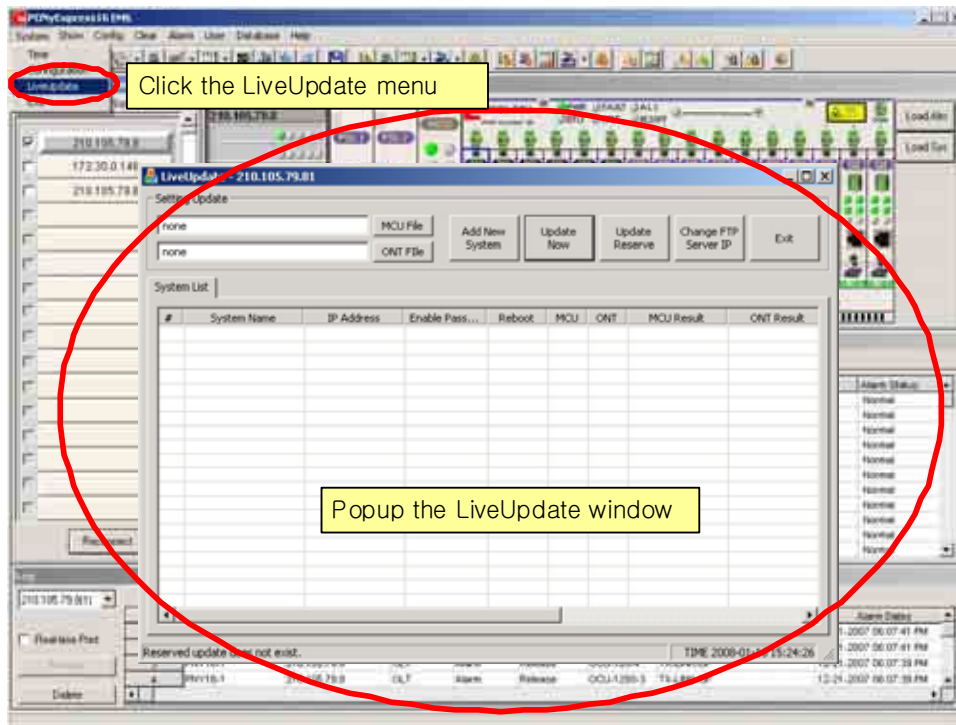

Figure 6-42 LiveUpdate Menu

11.2 Update procedure

You can perform LiveUpdate in the following procedure.

- 1) Create the list for update.

Select the system name, IP, MCU / ONT(All or select echo ONT), and whether to reboot the system after update. You can give any system name.

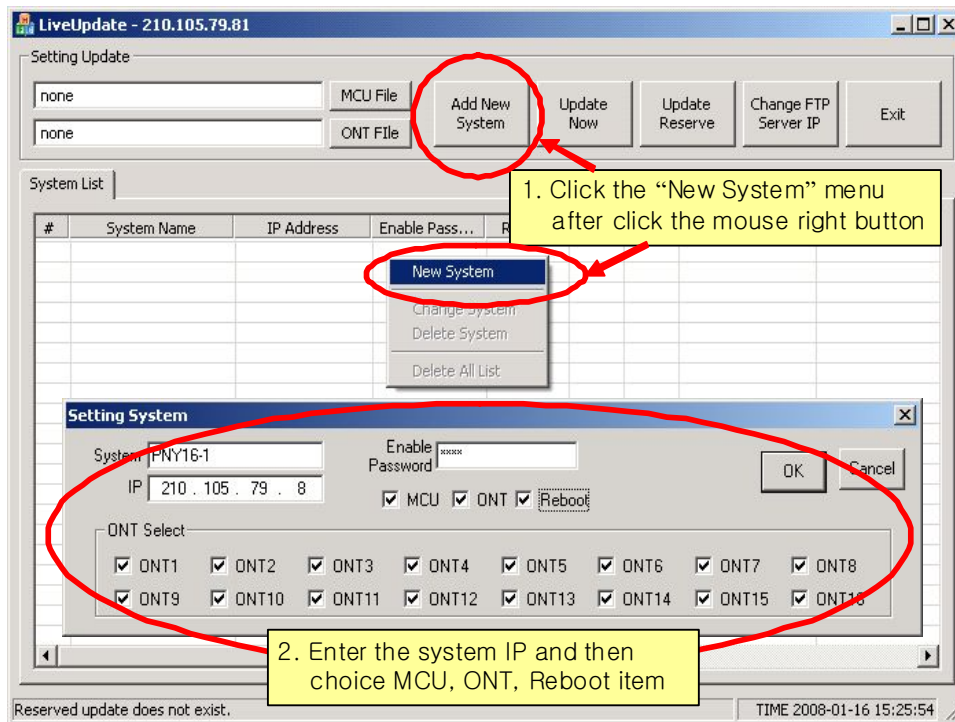

Figure 6-43 LiveUpdate Step 1

2) Click the MCU File or the ONT File button, and select the image file for update.

Click the “Update Now” button, and click “OK” in the pop-up window. If the list has a number of systems, EMS updates the systems in sequence.

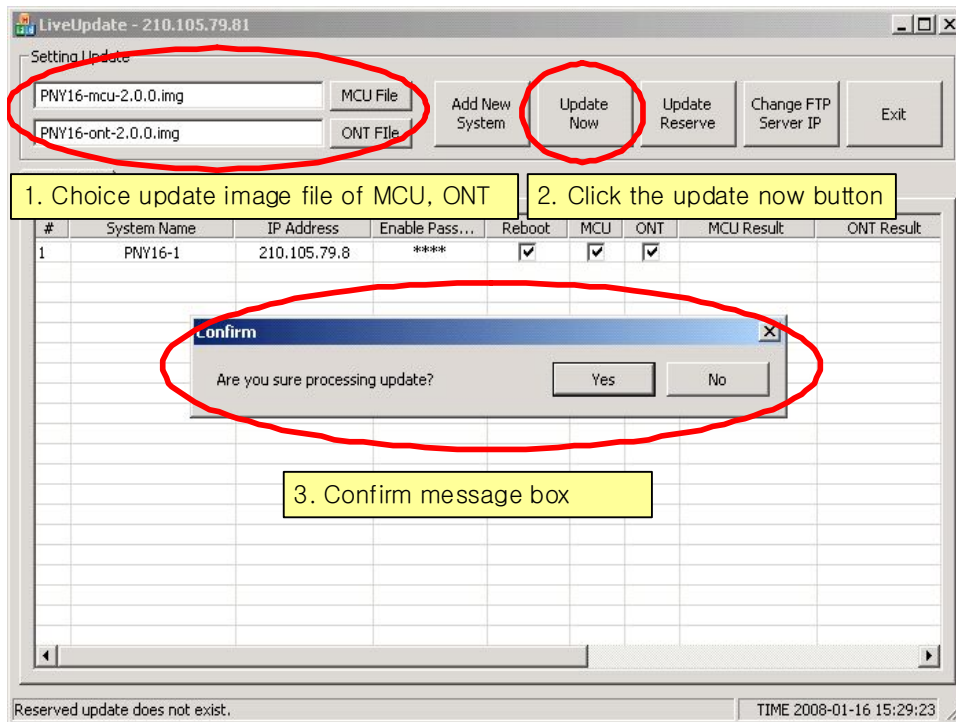

Figure 6-44 LiveUpdate Step 2

- 3) The update result is displayed on the message box during the update, and on the right side of the list after the update. Click the “Update Now” button, and the “Yes” button on the confirmation message box. If the list has a number of systems, EMS updates the systems in sequence. You can stop update at any time by clicking the “Cancel” button on the message box. If you click “Cancel,” the update process is stopped after the current update of the MCU or the ONT is completed.

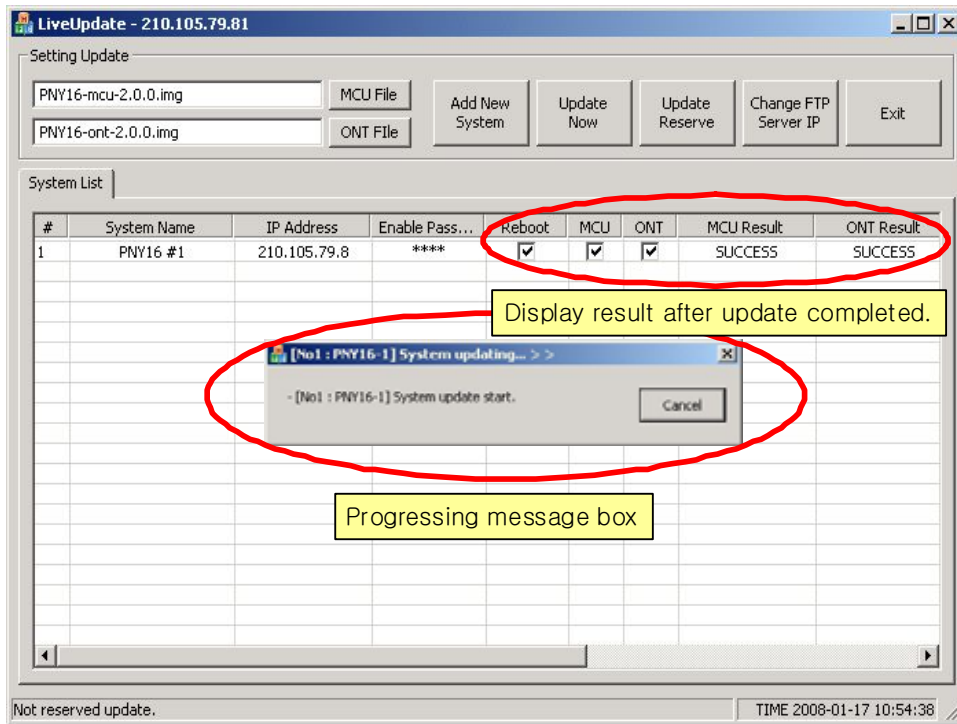

Figure 6-45 LiveUpdate Step 3

11.3 Reservation for update

Reserved update is performed in the same procedure described above. The only difference is that you can reserve the time for update. You can reserve the time for update by clicking the “Update Reserve” button as shown in the following figure. If you click the button, the Setting Reserve message box pops up. The message box remains on the window until the reserved update is started. You can cancel the reservation at any time by clicking the Cancel button on the box. The update process is performed as described above.

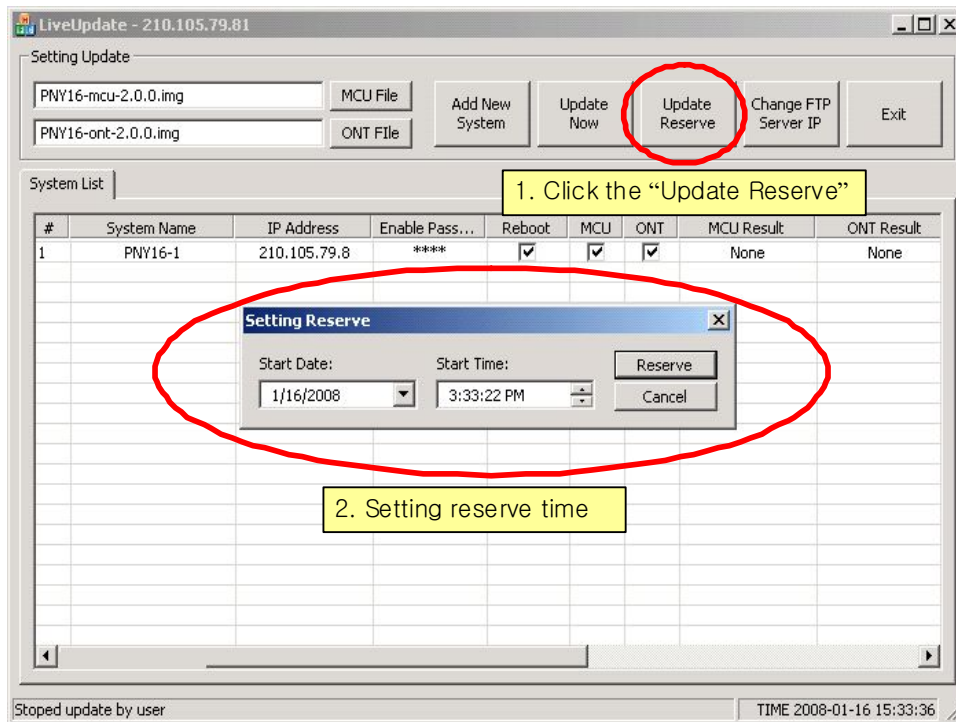

Figure 6-46 Reservation for Update

11.4 Changing FTP server IP

LiveUpdate activates the FTP server to download the MCU and ONT update image files to the program. You don't have to designate an IP if there is only one user PC. If there are a number of IP addresses, you need to select an IP as the FTP server. If you do not select an IP, the program uses any IP. If the IP band or gateway is different, the image file might not be downloaded. Therefore, you must select the FTP server IP if you use a private IP or a number of IPs. If you click "Change FTP Server IP," a window pops up. If you click the combo box in the pop-up window, all the IPs are displayed. The current FTP server IP is indicated on the title bar as shown in the following figure.

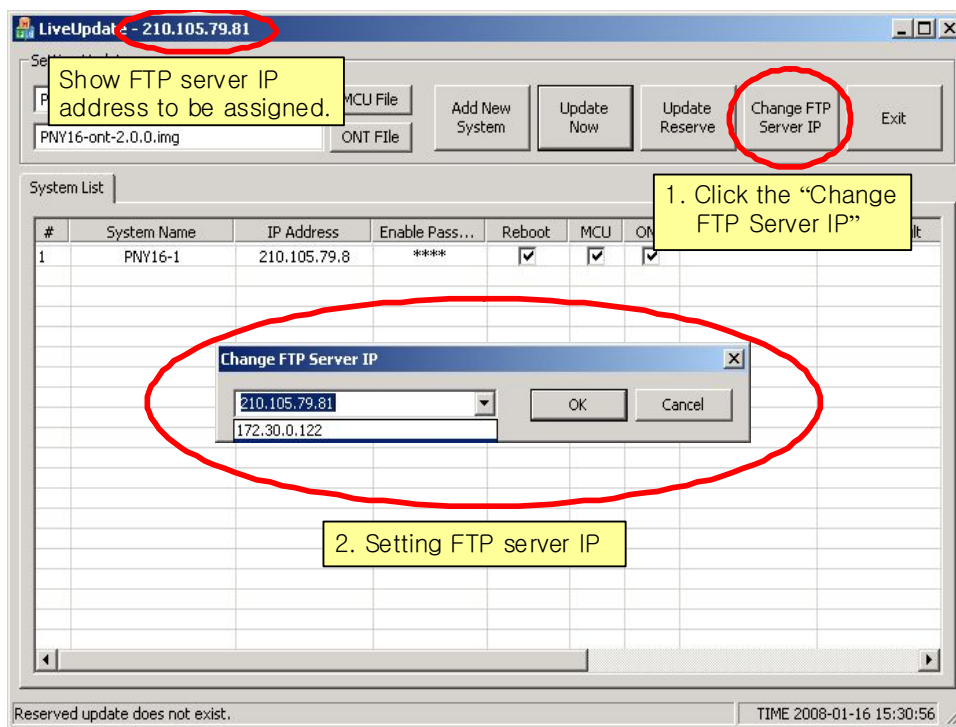

Figure 6-47 Setting FTP Server IP

12 EMS menu

12.1 Main menus

<Table 5-2> EMS Main Menus

Main menu	Description
System	Manage system by adding device, changing information.
Show	This menu is function like “Show” in CLI command of MCU NOS.
Config	This menu is function like “Set” or “No” in CLI command of MCU NOS.
Clear	This menu is function like “Clear” in CLI command of MCU NOS.
Alarm	Set general conditions of alarms
User	Manage users via EMS by adding, deleting user, and changing password.
Database	View history data from database
Help	View information on EMS, system software and customer support

12.2 Sub menus

<Table 5-3> EMS Sub Menus

Main menu	Sub menu	Description	
System	Time	View and set system time.	
	Configuration	Add a system, or view, change or delete the existing system information.	
	LiveUpdate	Update OS of OLT and ONT.	
	Exit	Exit EMS.	
Show	Alarm Grade	View all the alarm grades set in the system.	
	ARP	View the contents of the ARP table with the following command.	
	BMU	View alarm status and information of BMU.	
	Config	Show setting up information of the system to be saving in the compact flash.	
	DCE	View DCE status and information.	
	FAN	View alarm status and information of FAN.	
	Flash	This command shows the Flash memory state of the system.	
	Interface	Eth0	View Ethernet port information as IP address, MAC address, input packet and output packet of system.
		Eth1	
		IP Route	Show the contents of the routing table.
	Log History	The command logs stored in the system are displayed.	

Main menu	Sub menu		Description	
	MAC		Show the contents of the MAC table.	
	Memory		This command shows the memory state of the system.	
	OCU	Status	View alarm status and other information of the optical channels.	
		Packet-Counter	Show the current traffic in FX and TX port of OCU.	
		Average Packet-Counter	Display average packet counter of OCU for 5sec, 10sec, 1min and 10min.	
		TRx	Display TRx information of OCU for board temp, VCC, TX-BC, TX-Power and RX-Power (IPM).	
		Inband-id	Display default in-band id of OCU	
	Processes		Show the current CPU load by process in system.	
	PSU		View alarm status and information of PSU.	
	Running-Config		Show the current setting of the system.	
	SNMP-Server		Show the status of the SNMP in the system.	
	Staus		Show unit in/out and alarm status of BMU, PSU and FAN module.	
	System		Show a brief profile of the system such as the name, the version by module and the capacity.	
	Users		Show connected user information with system.	
	Config	Set	Alarm Grade	Set all the alarm grades in the system.
ARP			Add an IP and MAC address in the ARP.	
BMU AIs			Disabel	Set ALS (Automatic Link Showdown) disable/enable of BMU.
			Enable	
DCE Type			Set type and IP address of DCE.	
NTP Server			Set IP address of NTP server.	
OCU			Disable	Set disable service state of OCU.
			Enable	Set enable service state of OCU.
			IPM	Set IPM (Input Power Monitoring) range value of OCU.
			Speed	Set the data rate of the OCU port from 10Mbps, 100Mbps, 1000Mbps or auto.
			Remote Reset	Remote reset DCE through the electrical signal from OLT.
ONT SNMP			Disable	Set SNMP connection state disable/enable of ONT.
	Enable			
SNMP-	Community	Set the connection password for SNMP Agent.		

Main menu	Sub menu		Description	
	Server	Trap	Set trap for each alarm types of the 5 modules. (BMU, FAN, OCU, PSU, ONT)	
		Trap-host	Set SNMP trap host IP address and community name.	
		Users	Set ID and password for SNMP agent V3.	
	Syslog	Alarm Log Level	Set alarm log level(critical, major, minor) in system.	
		Host	Set syslog host IP address.	
	Username		Create user ID of system.	
	No	Alarm Grade		Negate all the alarm grades in the system.
		ARP		Delete an IP and MAC address in the ARP.
		DCE		Negate type and IP address of DCE.
		NTP Server		Delete IP address of NTP server.
		OCU IPM		Delete IPM (Input Power Monitoring) range value of OCU.
		SNMP-Server	Community	Delete the connection password for SNMP Agent.
			Trap	Clear trap for each alarm types of the 5 modules. (BMU, FAN, OCU, PSU, ONT)
			Trap-host	Set SNMP trap host IP address and community name.
			Users	Delete ID and password for SNMP agent V3.
		Syslog	Alarm Log Level	Negate alarm log level in system.
			Host	Delete syslog host IP address.
		Username		Delete user ID of system.
	Clear	ARP		Clear all contents of ARP table in system.
		Config		Delete all information from the compact flash.
Line		Disconnect connection user in system.		
Log		Delete the system logs and the alarm logs from the system.		
Log History		Delete the command logs from the system.		
MAC		Clear all contents of MAC table in system.		
OCU Packet-Counter		Clear all packet counter values of OCU.		
Alarm	History		View log data of the system.	
	Threshold		Determine whether to receive report on the system alarms by alarm grade.	
User	Password		Change password of the user on EMS.	
	Account		Add, change or delete account of EMS user.	

Main menu	Sub menu	Description
Database	History	View and search commands and alarms stored in DB of the operating PC.
Help	About EMS	View information on name and version of EMS.
	About System	View type and version of the connected system.
	UNIT LED Description	Describe LED for OCU and ONT displayed on EMS window.
	Customer Support Center	View address and contact information of the customer center.

Chapter7 Read before requesting service

Cannot switch the system on.

1. Are +/- of DC -48V properly connected?
 - ✓ Check if +/- of the PDP or power codes are reversed.
 - ✓ Check the power at the PDP port.

Communication is disabled.

1. Is the subscriber aggregation switch set properly?
 - ✓ Check the LAN cable, and replace the LAN and check the communication status.
2. Check if Tx/Rx ports of OCU in the OLT shelf are properly connected?
 - ✓ Check if Tx/Rx port of OCU are reversed.
3. Is the optical power measured at the OCU card in OLT shelf and the BMU below the specification?
 - ✓ Clean the optical jumper code of the optical output port in each card of each shelf, and then, check the followings. Also check if the optical fiber is bent.
 - ✓ Check if the BLS output power from the BMU channel ports meets specification.
 - ✓ Check if the output power of the OCU card meets the specification.
 - ✓ Check if the output power of BMU common port meets specification.
4. Was the fiber properly terminated during installation of RN?
 - Check if the radius of the end coil of the terminated optical fiber is less than 15cm. Also check if the optical fiber was broken when RF cabinet door was closed.
5. Internet rate is lower than expected.
 - Check the rate of NIC of the subscriber PC. Some of the NIC cards is for 10M. In this case, replace the NIC. Also check if NIC is set to auto nego.
6. IP is received normally, and then, disconnected.
 - The switch blocks the connection at L3 if the subscriber PC is affected by a virus. Check the virus in your PC. (You may have to format the PC.)
7. If you have had used two or more PCs, and now use only one, it is blocked by the max mac filtering function of the switch.

Chapter8 Appendix A Acronyms

ADSL	Asymmetrical Digital Subscriber Line
ARP	Address Resolution Protocol
BLS	Broadband Light Source
BMU	Broadband Light Source and MUX Unit
CLI	Command Line Interface
CoS	Class of Service
DCE	Data Circuit-Terminal Equipment
DWDM	Dense Wavelength Division Multiplexing
SL16	Dense Wavelength Division Multiplexing Passive Optical Network
DEMUX	De-multiplex
EMC	Electro Magnetic Compatibility
EMI	Electro Magnetic Interference
EMS	Element Management System
FES	Fast Ethernet Switch
FTTB	Fiber To The Business
FTTC	Fiber To The Curb
FTTH	Fiber To The Home
H/W	Hardware
ICMP	Internet Control Message Protocol
IGMP	Internet Group Multicast Protocol
IPM	Input Power Monitoring
L2	Layer 2
L3	Layer 3
L4	Layer 4
LAN	Local Area Network
LED	Light Emitting Diode
MAC	Media Access Control
MCU	Main Control Unit
MIB	Management Information Base
MUX	Multiplex
NMS	Network Management Server
OCU	Optical Channel Unit
OFD	Optical Fiber Distribution
OLT	Optical Line Terminal
ONU	Optical Network Unit
OS	Operating System
PIM	Protocol Independent Multicast

Chapter8 Appendix A Acronyms

PON	Passive Optical Network
PSU	Power Supply Unit
QoS	Quality of Service
RN	Remote Node
SMF	Single Mode Fiber
SNMP	Simple Network Management Protocol
S/W	Software
ToS	Type of Service
UTP	Unshielded Twist Pair
VDSL	Very high data rate Digital Subscribe Line
VLAN	Virtual Local Area Network
WDM	Wavelength Division Multiplexing
WDM-PON	Wavelength Division Multiplexing Passive Optical Network
WFQ	Weighted Fair Queue
WRED	Weighted Random Early Detection
WRR	Weighted Round Robin
XDSL	ADSL or VDSL

SpeedLIGHT16 User Manual

Copyright © 2006 LG-Nortel Co. Ltd.
All Rights Reserved

Copyright of this manual belongs to LG-Nortel Co. Ltd.
Reproduction, distribution or revision of part or all of contents in
this manual in any form without written permission of LG-Nortel
Co. Ltd. is prohibited.

The information in this manual is subject to change for the reason of function improvement, design alteration, etc. without any prior notification.

<http://isupport.lge.co.kr>

