

ESCORT *iX*

INTELLIGENT LONG-RANGE RADAR-LASER DETECTOR

Instant Bluetooth® Connectivity

PRELIMINARY - DRAFT

Quick Reference

Congratulations



ESCORT iX

You've just purchased the ESCORT iX with long-range radar-laser performance, GPS-based intelligence and instant Bluetooth® connectivity.

Go to EscortRadar.com for the full featured ESCORT iX Owner's Manual.

Guía de Referencia Rápida Española traducida y manual con todas las funciones también son disponibles a www.EscortRadar.com

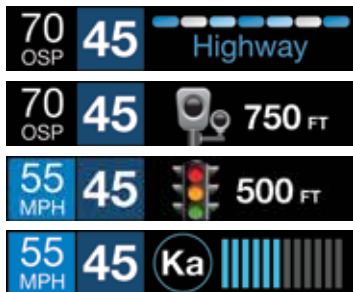

ESCORT iX features

a new multi-color

OLED display.

Brilliant graphics

illuminate intuitive

icons that identify

the type of threat at

a glance.

ESCORT iX Features

- The ESCORT iX delivers long-range warning on all radar bands including X, K, Superwide Ka.
- ESCORT iX's GPS location-based intelligence automatically locks out false alerts and allows you to mark locations for future reference.
- ESCORT iX gives you access to ESCORT's DEFENDER Database, which warns you of verified speed traps, speed cameras, and red light cameras.
- The ESCORT iX with built in **Bluetooth**® technology gives you access to ESCORT's award winning app, ESCORT Live. Our exclusive real-time ticket-protection, the network which warns you of upcoming alerts received and reported by other users in the area, and gives you access to local speed limit data for over-speed alerts.



Live Ready!

INTELLIGENT LONG-RANGE RADAR-LASER DETECTOR

PRELIMINARY²-DRAFT

Registration



Before downloading ESCORT Live, you must first register your ESCORT iX device. Be sure to have your ESCORT iX unit nearby, as you will need the serial number.

- 1 Visit www.EscortRadar.com and click Product Registration.
- 2 Click the “Registration for all devices” link.
- 3 Follow the onscreen instructions to register your device.

Be sure to write down the username and password you create, as you will need this information to access and download ESCORT Live. (You will also receive an e-mail with this information, once you have registered your device.)

ESCORT Live

For iPhone:

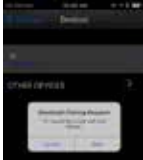
- 1 Ensure ESCORT iX power is ON
- 2 Open the App Store on your iPhone and search for **ESCORT Live Radar**. 
- 3 Follow the onscreen instructions to download **ESCORT Live Radar** and then open the app.
- 4 When prompted, enter the username and password you created when registering your product at EscortRadar.com.
- 5 Press the Settings button  then select **Devices**.
- 6 You should see **iX** listed with Not Connected underneath. Press the **iX** device entry and when prompted select Pair. 
- 7 The Bluetooth icon on the ESCORT iX display will appear to confirm that it is paired to your iPhone.

PRELIMINARY³-DRAFT

Warranty

For Android based smartphones:

- 1 Ensure ESCORT iX power is ON.
- 2 On your smartphone go to Bluetooth® Settings and make sure that Bluetooth® is ON.
- 3 Press Scan for devices and wait for the device list to populate, **iX Live** should appear under Available devices.
- 4 Press the **iX** device entry.
- 5 The Bluetooth icon on the ESCORT iX display will appear to confirm that it is paired to your smartphone.
- 6 Open Google Play on your smartphone and search for **Escort Live Radar**.
- 7 Follow the onscreen instructions to download **Escort Live Radar** and then open the app.
- 8 When prompted, enter the username and password you created when registering your product at EscortRadar.com.
- 7 Open the app, walk through the tutorial, and you're ready to hit the road!



ESCORT One Year Limited Warranty

What this warranty covers: Escort, Inc. ("Escort") warrants your Product against all defects in materials and workmanship.

For how long: One (1) year from the date of original purchase from an authorized Escort dealer.

What we will do: If a breach of warranty occurs, Escort, at its discretion, will either repair or replace your Product free of charge.

What we will not do: Escort will not pay shipping charges that you incur for sending your Product to us.

What you must do to maintain this warranty: Show original proof of purchase or receipt from an authorized Escort dealer.

Warranty exclusions: This warranty does not apply to your product under any of the following conditions: 1. The serial number has been removed or modified. 2. Your product has been subjected to misuse or damage (including water damage, physical abuse, and/or improper installation). 3. Your product has been modified in any way. 4. Your receipt or proof-of-purchase is from a nonauthorized dealer or internet auction site, including E-bay, U-bid, or other non-authorized resellers. 5. You are not the original purchaser of the Product from an authorized dealer or did not receive it as a gift from the original purchaser of the Product from an authorized dealer.

To obtain service: 1. Contact ESCORT (1-800-543-1608) to obtain a Return Authorization Number. 2. Properly pack your Product and include: your name, complete return address, written description of the problem with your Product, daytime telephone number, and a copy of the original proof of purchase or receipt. 3. Label the outside of the package clearly with your Return Authorization Number. Ship the Product pre-paid (insured, for your protection) to: ESCORT, Inc., 5440 West Chester Rd., West Chester, OH 45069.

LIMITATION OF WARRANTY: The obligations set forth above are ESCORT's sole obligations and your exclusive remedy. **ESCORT makes no other express warranty. Any implied warranty of merchantability or fitness for a particular purpose that may be applicable to the Product is limited in duration to the duration of this warranty.** Some States do not allow limitations on how long an implied warranty lasts, so the above limitation may not apply to you. **ESCORT SHALL NOT BE LIABLE FOR CONSEQUENTIAL, SPECIAL OR INCIDENTAL DAMAGES INCLUDING, WITHOUT LIMITATION, DAMAGES ARISING OUT OF THE USE, MISUSE OR MOUNTING OF THE PRODUCT.**

Some States do not allow the exclusion or limitation of incidental or consequential damages, so the above limitation or exclusion may not apply to you. ESCORT is not responsible for products lost in shipment between the owner and our service center.

Other legal rights: This warranty gives you specific legal rights, and you may also have other rights which vary from State to State.

©2015 ESCORT Inc. ESCORT® is a registered trademark of ESCORT Inc.

PRELIMINARY⁴-DRAFT

Installation

Your new detector comes with our latest **EZ Mag Mount™**. Simply tilt the display end of the detector up and slide it onto the mounting bracket. The magnetic mount holds the detector in place. To remove the detector from the mount, simply lift the display end of the detector and the detector releases from the mount.

Mounting Tips:

- Center of windshield between driver and passenger.
- Ensure clear view of road ahead and sky above.
- Avoid windshield wipers and heavily tinted areas.

To mount the detector in your vehicle:

- 1 Remove paper backing from EZ Mag Mount™ StickyCup.
- 2 Ensure the locking clamp is open.

- 3 Firmly press EZ Mag Mount™ StickyCup onto windshield and close the locking clamp to secure.
- 4 To adjust view, loosen thumb wheel and adjust angle of mounting bracket. Tighten thumb wheel to secure.
- 5 Tilt the display end of the detector slightly upward and engage with the flanged edge of the mounting bracket. The EZ Mag Mount™ magnet holds the detector in place.
- 6 To remove the detector, simply lift the display end of the detector upward. The ESCORT iX will release from the mount.
- 7 To remove mount from windshield, release locking clamp and pull tab on top of StickyCup.

EZ Mag Mount™ Care Instructions:

Should the EZ Mag Mount™ StickyCup accumulate debris and lose its stickiness, simply rinse under warm water, gently wipe off debris and allow to air dry.

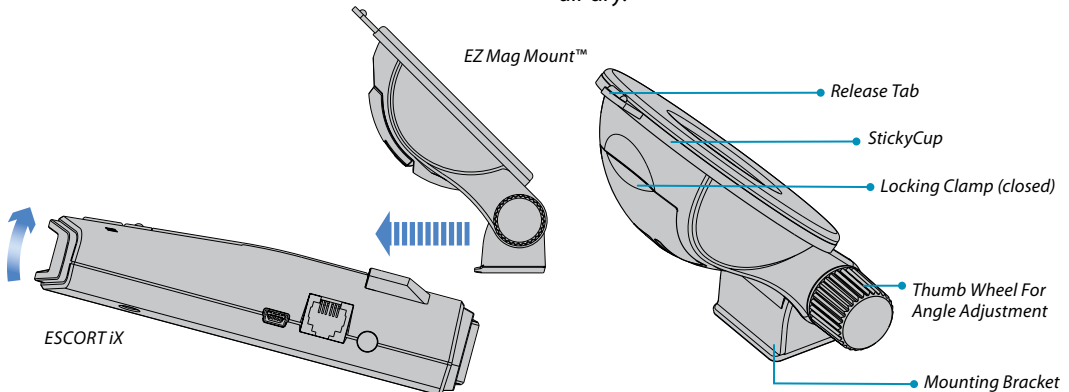

PRELIMINARY⁵-DRAFT

Controls & Features

Using ESCORT iX

- 1 Plug small end of SmartCord USB into modular jack on ESCORT iX and large end of SmartCord USB into your car's lighter/accessory socket.
- 2 ESCORT iX should power on automatically. If not, press the device's power button. 

NOTE: You can easily access and customize all of your Settings and Preferences by pressing and holding the MRK and SEN buttons. See Settings & Preferences for details.

Using SmartCord USB

- **Mute Button:**
 - Press to mute the audio for a specific alert.
 - Press three times to lock out a false alert.
 - Press twice while receiving a locked-out alert to unlock.
 - When connected to ESCORT Live press and hold mute button on unit or cord to manually report to other users a verified X or K-band alert, or a police officer observing traffic.
- **Alert Light:** Blinks red when receiving a radar or laser alert.
- **Power Light:** Lights green when receiving power.
- **USB Charging Port:** Charge smartphones, tablets and other USB-charged Devices.

Earphone Jack

Connects to optional 3.5 mm stereo earphone

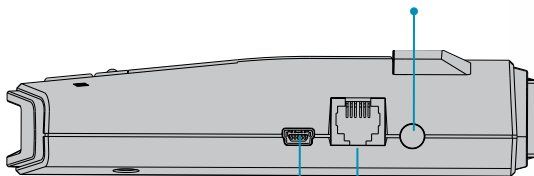

Mini USB Jack

Connects to your computer via USB A / Mini B cable for downloading software updates

Modular Jack

Connects to SmartCord USB for powering your device



Modular Connector

Plugs into detector jack

SmartCord USB Adapter

Connects to lighter/accessory socket

Continued →

PRELIMINARY⁶-DRAFT

Controls & Features

Mount Area
The EZ Mag Mount™ attaches to device here

Power 
Press to turn ESCORT iX on or off

Volume
Press and hold + or – to adjust volume

Brightness (BRT)
Press to adjust display brightness (Min, Med, Max, Auto, Dark)

Sensitivity (SEN)
Press to adjust detector sensitivity (Highway, Auto, Auto NoX)

Mark Location (MRK)

To mark a location for future alerts, press MRK twice, then VOL + or – to select the type of marker, then MRK again to confirm. Press twice while receiving marker alert to unmark

Display
Alert area

Display
Current speed

Mute
Press to mute an alert; press three times to lock out a false alert; press twice while receiving a locked-out alert to unlock

Display (OSP)

OverSpeed alert setting that can be adjusted in Preferences. **Bluetooth** icon will appear on display screen blue when paired to phone and Speed limit data will show here when ESCORT Live App is open.



PRELIMINARY⁷-DRAFT

Settings & Preferences

Press and hold the MRK and SEN buttons to access Preferences. To exit Preferences, simply wait a few seconds without pressing a button. The unit will display **Completed** to confirm your selections.

Press MRK to go from one category to the next

Press VOLUME + or - to change your setting within a category

User Mode

Advanced*
Novice

Access and customize all Settings and Preferences
Access and customize units and display color, (all other Settings are set to factory defaults)

NOTE: Switch back to advance mode to view all Preferences.

Pilot

Scan Bar*
Full Word

Scanning Bar with Full Word.
Full Word: Auto, Auto NoX, or Highway

Display Color

Blue*/Green/Red/Amber

Set color to match your vehicle's dash display

Speed Display

On*
Off

Displays current speed
Displays battery voltage

Cruise Alert

20 mph*
Off / 20-160 mph

Offers double beep alert tones below specified speed

Over Speed

70 mph*
Off / 20-160 mph

Reminds you when you exceed a specified speed

Meter Mode

Standard*
Spec
Expert
Simple

Single band with bar graph of signal strength
Single band with numeric frequency
Multiple bands with bar graph of signal strengths
Simple messages replace bands:
Caution (if traveling below cruise alert limit)
Slow Down (if traveling above cruise alert limit)

Tones

Standard*
Mild

Standard ESCORT alert tones
Mild doorbell chime alert tones

AutoMute

On* / Off

Automatically reduces audio during alert

AutoLearn

On* / Off

Automatically stores and locks out false alarms

Units

English* / Metric

Units for distance and speed

Language

English* / Espanol

Language for voice and text

Voice

On* / Off

Voice announcements

GPS Filter

On* / Off

Enables GPS-powered features

PRELIMINARY⁸ -DRAFT

| | | |
|--------------|--|--|
| AutoPower | Off 1 Hour 2 Hours 4 Hours* 8 Hours | Power turns on or off depending on your vehicle's ignition type (constant power or switched) Powers off automatically after 1 hour Powers off automatically after 2 hours Powers off automatically after 4 hours Powers off automatically after 8 hours <i>NOTE: If AutoPower is on, to save screen life the display screen goes blank after 30 minutes without moving. Displays screen will turn on automatically after you reach 10MPH.</i> |
| | | <i>NOTE: AutoPower only works with constant power ignition.</i> |
| Band Enables | Default* Modified | Default Settings for North America Customize the bands you want to monitor |

Press SEN to go from one band category to the next

Press VOLUME + or - to change your setting within a category

| | | |
|---------|------------------|---|
| X Band | On* / Off | |
| K Band | On* / Off | |
| Ka Band | On* / Off | Freq: 33.400-36.000 Ghz <i>NOTE: When Ka Band is off, you can select separate segments of the band to turn on and off.</i> |
| KaN1 | On* / Off | Freq: 33.660-33.900 Ghz |
| KaN2 | On* / Off | Freq: 34.200-34.400 Ghz |
| KaN3 | On* / Off | Freq: 34.600-34.800 Ghz |
| KaN4 | On* / Off | Freq: 35.400-35.600 Ghz |
| Ka-POP | On / Off* | |
| Laser | On* / Off | |
| TSR | On* / Off | Automatically rejects traffic flow sensors-monitoring false alarms |
| RDR | On* / Off | Radar Detector Rejection |

Marker Enables

Default*
Modified

Other, Red Light Camera, Red and Speed Camera, and Speed Trap
Customize the types of locations you want to mark for future reference

Press SEN to go from one marker category to the next

Press VOLUME + or - to change your setting within a category

| | | |
|-----------------|--|--|
| Other | On* / Off | Other location |
| Redlight | On* / Off | Red light camera |
| Red & Speed | On* / Off | Red light & speed camera |
| Speed Cam | On* / Off | Speed camera |
| Speed Trp | On* / Off | Speed trap |
| Air Patrol | On / Off* | Known aircraft patrolled areas <i>NOTE: User cannot mark an air patrol location.</i> |
| Clear Locations | Marked Lockouts Defender Format | Clear all user Marked locations. Press SEN button to confirm Clear all lockouts. Press SEN button to confirm Clear all DEFENDER data. Press SEN button to confirm Clear DEFENDER database, all markers, and all lockouts Press SEN button to confirm |

Contact Us

Notes for Settings & Preferences

For descriptions of features and functions available when connected to ESCORT Live, visit EscortRadar.com and download the ESCORT iX Owner's Manual.

To view serial number and software revision press MRK and MUTE while powering on detector.

To restore ESCORT iX to its original factory Settings, press and hold SEN and BRT while turning the power on. A "Restored" message will display, acknowledging the reset.

Software Updates

ESCORT iX's red light and speed camera DEFENDER database is easily updated using our exclusive detector software tools found on our web site. Firmware, or the operating software for the detector, can also be updated using these tools.

In order to have access to these updates, please register your ESCORT iX at www.EscortRadar.com. Once registered, you will receive email notifications that updates are now available for your database or firmware. To handle your software and DEFENDER updates you need to connect your ESCORT iX to a computer first. You can connect ESCORT iX to a computer via USB A / Mini B cable (not included).



800.433.3487



EscortRadar.com

Designed in the USA

ESCORT Inc.
5440 West Chester Road
West Chester OH 45069

Sales / Service 800.433.3487
www.EscortRadar.com

©2016 ESCORT Inc. Escort®, Escort iX, Escort Live!™, Defender®, AFR®, TrueLock™, SmartShield™, SpecDisplay™, AutoSensitivity™, ExpertMeter™ and Cincinnati Microwave are trademarks of ESCORT Inc. Manufactured in Canada. Features, specifications and prices subject to change without notice.

FCC NOTE: Modifications not expressly approved by the manufacturer could void the user's FCC granted authority to operate the equipment.

FCC ID:QKLM4IX. CONTAINS FCC ID:QKLBT2.

This device complies with part 15 of the FCC rules. Operation is subject to the following two conditions: (1) This device may not cause harmful interference, and (2) This device must accept any interference received including interference that may cause undesired operation.



Made for iPhone 5, iPhone 5c, iPhone 5s, iPhone 6, iPhone 6s. iPhone is a trademark of Apple Inc., registered in the U.S. and other countries. "Made for iPhone" means that an electronic accessory has been designed to connect specifically to iPhone and has been certified by the developer to meet Apple performance standards. Apple is not responsible for the operation of this device or its compliance with safety and regulatory standards. Please note that the use of this accessory with iPhone may affect wireless performance. Android is a registered trademark of Google Inc. The Bluetooth® word mark and logos are registered trademarks owned by Bluetooth SIG, Inc. and any use of such marks by ESCORT is under license.

PRELIMINARY¹⁰-DRAFT