



# WeR@Home™

## Installation Guide

ESUGSL019  
Version 2.3  
January 2018

## Table of Contents

1.	Introduction .....	3
2.	Installing WeR@Home™ .....	5
2.1.	Preparing the Required Equipment .....	5
2.2.	Downloading the WeR@Home™ App .....	6
2.3.	Installing the WeR@Home™ Hub.....	6
2.3.1	Choosing a Location .....	7
2.3.2	Setting up the Hub.....	7
2.3.3	Registering the Hub .....	8
2.4.	Activating the Remote Control.....	10
2.5.	Installing the Peripheral Devices.....	11
2.5.1	Installing a Motion Detector .....	12
2.5.2	Installing a Camera Detector.....	14
2.5.3	Installing a Door/Window Sensor.....	17
2.5.4	Installing a Siren .....	22
2.5.5	Installing a Tag Reader and Tag.....	24
2.5.6	Installing a Flood Detector .....	29
2.5.7	Installing a Universal Transmitter .....	31
2.5.8	Installing a Z-Wave Plus Extender.....	33
2.5.9	Installing an HD Camera.....	34
2.6.	Installing a Smart Repeater .....	34
2.6.1	Finding a Suitable Location .....	34
2.6.2	Setting up the Repeater .....	35
2.6.3	Adding Peripheral Devices to the Repeater .....	36
2.7.	Testing the Signal Strength of Peripheral Devices .....	37
3.	Setting-Up Your WeR@Home™ .....	38
Appendix A	Technical Specifications.....	39
Appendix B	Pairing a Device.....	50
Appendix C	The WeR@Home™ Kit .....	51
Appendix D	Installing with Screws.....	52
Appendix E	Installing a Pet Immune Lens.....	59
Appendix F	Battery Information.....	64
	Legal Notice.....	65

## 1. Introduction

WeR@Home™ is based on a combination of independent components designed to help you manage your home activities. The floor plan of your home determines the arrangement of the components and their placement in your home. Work with your service provider to determine the peripherals you would like to install initially. In the future, you can add more peripherals as needed.

WeR@Home™ includes the following devices:

- Hub
- Remote Control (Key Fob)
- Motion Detector
- Camera Detector
- Door/Window Sensor
- Siren
- Tag Reader and Tag
- Flood Detector
- Universal Transmitter
- Z-Wave® Plus Extender
- Smoke Alarm
- Smart Repeater

For information about the maximum number of each peripheral device allowed in a WeR@Home™ hub's system configuration, refer to Maximum System Configuration per Hub on page 46.



**Figure 1: WeR@Home™ Product Suite**



**NOTE:** Some features described in this guide may be disabled depending on your service level. For information about different service levels, or to change your service level, contact your service provider.

## 2. Installing WeR@Home™

The WeR@Home™ installation involves the deployment of the WeR@Home™ hub and peripherals in your home. This guide provides the deployment instructions for the hub and each device type. Installing WeR@Home™ includes the following:

- Preparing the required equipment
- Downloading the WeR@Home™ app
- Installing the WeR@Home™ hub
- Installing the peripheral devices



**NOTE:** For information about the smoke alarm, refer to the ESUG05023 WeR@Home™ Smoke Alarm User Guide.

---

### 2.1. Preparing the Required Equipment

Ensure you have the following before you install WeR@Home™:

- AA alkaline batteries for the devices, as listed in Battery Quantities and Specifications on page 64. Remember to recycle your used batteries.



**WARNING!** A new battery can explode if it is incorrectly installed.

---

- If you are using cellular communications, a SIM card is either provided by your distributor or can be purchased from your cellular service provider.



**NOTE:** Contact your cellular service provider for APN support.

---

- If you are using mounting-tape for installation, the tape is included. If you are using screws for installation, refer to Appendix D Installing with Screws on page 52.

## 2.2. Downloading the WeR@Home™ App

You can download the WeR@Home™ app from the Apple® App Store or the Google™ Play Store. Make sure your device meets the following requirements:

- Apple: iOS 8.0 or later
- Android™: OS 4.1.2 or later



Scan the QR code to download the app.



## 2.3. Installing the WeR@Home™ Hub

Training Video

The central component of WeR@Home™ is the two-way, wireless WeR@Home™ hub. The hub manages the peripheral devices, acts a gateway to the Essence Cloud, and communicates with the Essence servers which provide data to the app.



Figure 2 – The Hub

You can install one or more hubs in WeR@Home™. To install an additional hub in an existing WeR@Home™ network, see the section **Working with Multiple Places** in the ESUGSL018 WeR@Home™ User Guide.

Installing the hub includes the following:

- Choosing a location
- Setting up the hub
- Registering the hub

### 2.3.1 Choosing a Location

To choose a location, consider the following:

- Install on a flat surface in a central location.
- If you are using internet communications (LAN) for your external communications channel, install close to your internet modem or router.
- If you are using cellular communications for your external communications channel or as a backup, choose a location with adequate cellular reception.
- It is recommended to position the hub at least 1 m (3.3 ft.) away from the planned peripheral locations.

### 2.3.2 Setting up the Hub

To set up the hub:

1. Plug the power adapter cable into the mini-USB connector on the back of the hub and the power adapter cube into a power outlet. The LED on the front panel lights up **red**.
2. Remove the back cover.

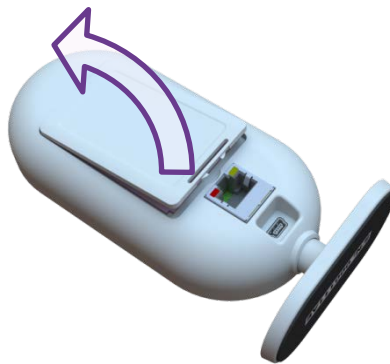

**Figure 3: Remove Back Cover**

3. If you are using a cellular channel, ensure that the SIM card is securely installed.
4. Insert the backup battery into the battery compartment, above the SIM card, such that the battery label faces upward and the battery contacts face the hub's base.



**Figure 4: Insert Backup Battery**

5. If you are using your LAN, plug the LAN cable into the network port on the back of the hub and the other end of the cable into the Internet router or modem. The LED on the front panel lights up **orange**.



**NOTE:** If both the SIM card and the LAN cable are installed, the LAN cable is the external communications channel and the cellular channel is used for backup.

6. Return the back cover to the hub.
7. Wait for the hub front panel LED to switch from **orange** to **green**. This may take a few minutes.

### 2.3.3 Registering the Hub

To finish the hub installation, you need to register the hub.

To register the hub:

1. Tap  to open the WeR@Home™ app. The **Login** screen appears.
2. Tap **Register**. The **Registration** screen appears.
3. Enter the hub's 8-digit serial number, which can be found on the base of the hub, and tap **Next**. The **User Type** screen appears.
4. Choose the type of user to add to the hub and enter user details as required:
  - If the user is not registered on another hub, tap **New User**. The **New User** screen appears. Enter the user personal details, according to the table below, and tap **NEXT**.



Table 1: New User Registration Information

Field	Definition and Instructions
<b>Email</b>	Enter the email address to use for your user credentials during login. This is the email address to which you want the system messages and notifications sent.
<b>Password</b>	Enter the password to use for your user credentials during login. The password must be at least six characters long. It is recommended to include capital letters, numbers and special characters, such as “!” or “#”.
<b>Confirm Password</b>	Re-enter the password to verify that the password is entered correctly.
<b>Your Name</b>	Enter the name you want to appear in the WeR@Home™ app.
<b>Phone Number</b>	Enter the number of the mobile device to receive text messages.

- If the user is registered on another hub, tap **Existing User**. For example, tap **Existing User** when adding another hub to your WeR@Home™ network. The Existing User screen appears. Enter your existing user name and password and tap **LOGIN**. The Hub Configuration registration screen appears.
5. Enter the hub configuration details, as defined in the table below.

Table 2: Hub Configuration Registration Information

Field	Definition and Instructions
<b>Hub</b>	Enter a descriptive name that identifies the hub location.
<b>Country</b>	Select the country where the hub is located.
<b>Time Zone</b>	Select the time-zone for the country you selected in the previous field. The time-zone is used to synchronize the system clock for the timestamps of email messages and notifications. <b>Default:</b> UTC.

6. Tap **NEXT**. The **Congratulations** screen appears.
7. Tap **Continue to App**. A message window appears assigning 1234 as your default PIN.
8. Tap **Cancel** to go to the **Home** screen.
9. Tap **OK** to personalize your PIN. For detailed instructions, refer to ESUGSL018 WeR@Home™ User Guide.

## 2.4. Activating the Remote Control



Training Video

The remote control is used to arm and disarm WeR@Home™, and as an SOS button.



Figure 5: The Remote Control

To activate the remote control:

1. Remove the battery compartment cover by inserting a coin into the slot and turning counter-clockwise until the two dots align.

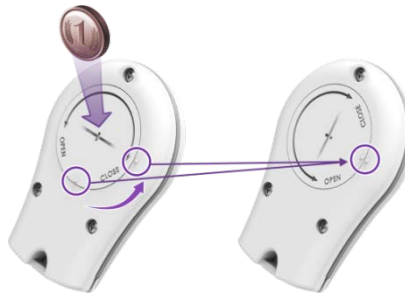



Figure 6: Releasing the Remote Control Battery Cover

2. Open the WeR@Home™ app.
3. Tap . The main menu appears.
4. Tap **DEVICES**. The **Devices** screen appears.
5. Tap **Add device**. The **Add New Devices** screen appears.
6. Select **Remote Control**. The **Select Owner User** screen appears.
7. Choose the user you want to assign to the remote control. The **Remote Control** pairing screen appears.
8. Place the remote control close to the hub.
9. Press any button several times.
10. Insert the battery into the battery compartment with the **+** pole facing out and close the cover by turning it clockwise. The front panel LEDs blink twice.



**Figure 7: Insert the Battery and Close the Remote Control**

When pairing succeeds, a screen appears displaying the default remote control name.

11. Tap **OK**. The remote control appears in the list on the **Devices** screen.

## 2.5. Installing the Peripheral Devices

Installing the peripheral devices involves:

- Choosing a suitable location
- Adding each device to WeR@Home™ by pairing the device with the hub. Pairing allows the device to communicate with the hub. Devices included in a kit are pre-paired.
- Installing the device in the chosen location

---

### NOTE:



- If there are difficulties in communications between the hub and an installed device, consider using a smart repeater. Refer to 2.6 Installing a Smart Repeater on page 34.
  - Peripherals are installed using mounting-tape. As an alternative, you can install using screws. Refer to Appendix D Installing with Screws on page 52.
-

### 2.5.1 Installing a Motion Detector

The motion detector is a battery-operated, bi-directional, wireless, passive infrared detector.



**Figure 8: Motion Detector**

To install the motion detector:

1. Choose a location according to the following recommendations:
  - On a smooth surface, on either a flat wall or in a corner
  - At a height where the lens is 2.1 m (6.9 ft.) to 2.3 m (7.5 ft.) above the floor
  - Not opposite a window, facing sunlight, or any other strong light sources
  - Within 12 m (39.4 ft.) of the desired coverage area
2. Release the motion detector mounting-base by lifting the tab and pushing it forward.



**Figure 9: Release the Mounting-Base**

3. If the motion detector is not included in the WeR@Home™ kit, pair the motion detector as described in Appendix B Pairing a Device on page 50. Continue to step 7.

4. Gently shake the device.
5. Insert two AA alkaline batteries, observing the correct polarity.



**Figure 10: Battery Insertion**

The LED in the lens compartment flashes **red**, indicating that the motion detector has powered up successfully.

6. When prompted, enter a name and/or location for the device and tap **OK**. The motion detector appears in the list on the **Devices** screen.
7. Clean and dry the mounting location surface.
8. Peel off the mounting-tape protective strips, required for the installation location.

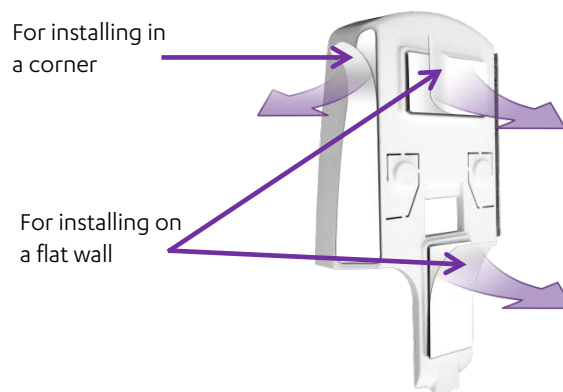

**Figure 11: Mounting Tape Protective Strips**

9. Press the mounting-base into place.
10. If you have a pet on the premises, install a pet immune lens. Refer to Appendix E Installing a Pet Immune Lens on page 59.

11. Insert the motion detector into the mounting-base until the motion detector clicks into place. Ensure that the lens is facing downward.

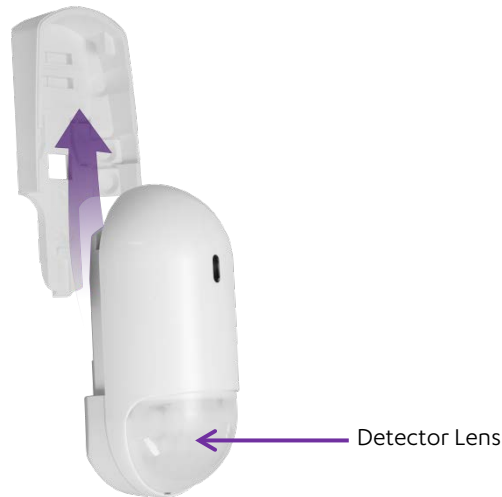

**Figure 12: Insert with Lens Facing Downward**

12. Test by walking by the motion detector within 30 minutes after you install. The LED should turn **red**. Check if events are reported in your app **History** event list.

### 2.5.2 Installing a Camera Detector

The camera detector is an indoor sensor combining a battery-operated, bi-directional, wireless passive infrared motion detector with a JPEG-image-capturing camera.



**Figure 13: Camera Detector**

To install the camera detector:

1. Choose a location according to the following recommendations:
  - On a smooth surface, on either a flat wall or in the corner
  - At a height where the camera lens is 2.1 m (6.9 ft.) to 2.3 m (7.5 ft.) above the floor
  - Not opposite a window, facing sunlight, or other strong light sources
  - In a position to capture images for monitoring activities such as intrusions, entrance, and exit
  - Within 12 m (39.4 ft.) of the desired coverage area.
2. Release the camera detector mounting-base by lifting the tab and pushing it forward.

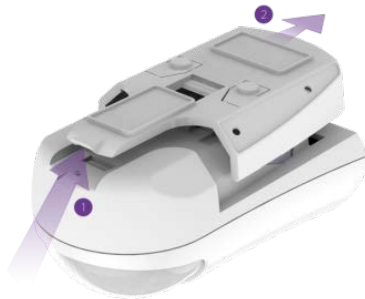

**Figure 14: Release the Mounting-Base**

3. Open the battery compartment by pushing the tab and lifting the cover up and off.

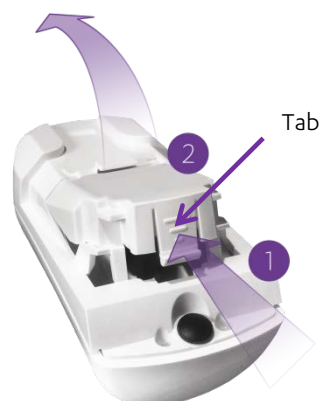

**Figure 15: Battery Compartment Cover**

4. If the camera detector is not included in the WeR@Home™ kit, pair the camera detector as described in Appendix B Pairing a Device on page 50. Continue to step 8.
5. Gently shake the device.
6. Insert three AA alkaline batteries, observing the correct polarity.

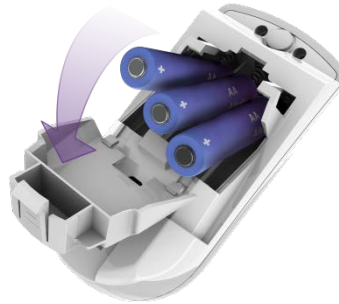

**Figure 16 – Battery Insertion**

The LED in the lens compartment flashes **red**, indicating that the camera detector has powered up successfully.

7. When prompted, enter a name and/or location for the device and tap **OK**. The camera detector appears in the list on the **Devices** screen.
8. Clean and dry the mounting location surface.
9. Peel off the mounting-tape protective strips, according to the chosen location:
  - On a flat wall
  - In a corner

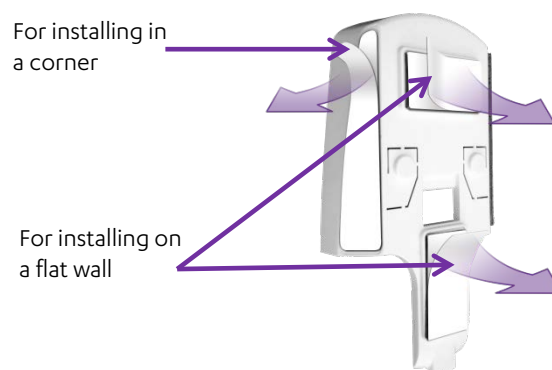

**Figure 17: Mounting Tape Protective Strips**

10. Press the mounting-base into place.
11. If you have a pet on the premises, install a pet immune lens. Refer to Appendix E Installing a Pet Immune Lens on page 59.



12. Close the battery compartment.
13. Insert the camera detector into the mounting-base until the camera detector clicks into place. Ensure that the lens is facing downward.



**Figure 18: Insert with Lens Facing Downward**

14. Test by walking by the camera detector within 30 minutes after you install. The LED should turn **red**. Check if events are reported in your app **History** event list.

### 2.5.3 Installing a Door/Window Sensor

The door/window sensor is a magnetic sensor for detecting opening and closing of doors, windows, cabinets, and other similar items. Optionally, the sensor may include a tamper switch.

This sensor device consists of two parts:

- The magnet
- The transmitter



**Figure 19: Door/Window Sensor**

To install the door/window sensor:

1. Choose a location according to the following recommendations:
  - A smooth, flat surface on a window, door, or other open/close item
  - Attach the transmitter to the fixed frame of the open/close item
  - Attach the magnet to the moving edge of the open/close item

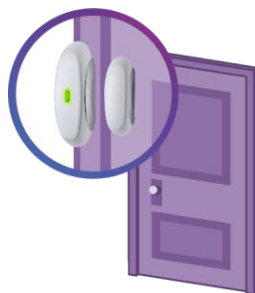

**Figure 20: Door/Window Sensor Location Example**

2. Release the transmitter from its mounting base by inserting and twisting a coin to separate the cover from the base.



**Figure 21: Releasing the Transmitter**

3. If the door/window sensor is not included in the WeR@Home™ kit, pair the door/window sensor as described in Appendix B Pairing a Device on page 50. Continue to step 7.

If the device includes a tamper switch, press the switch several times.

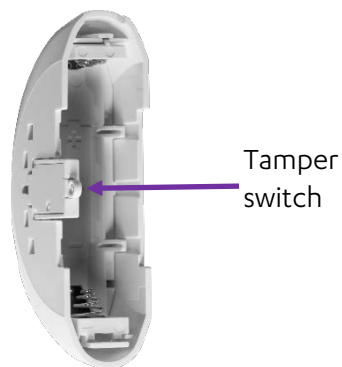

**Figure 22: Press MGL Tamper**

4. Insert one AA alkaline battery observing the correct polarity.
5. When prompted, enter a name and/or location for the device and tap **OK**.
6. If you want a chime to sound when the door/window opens:
  - a. Tap **Configure**
  - b. Tap 
  - c. Tap **OK**

7. Insert the transmitter into the mounting base:
  - With tamper switch: align the tamper switch with the opening.

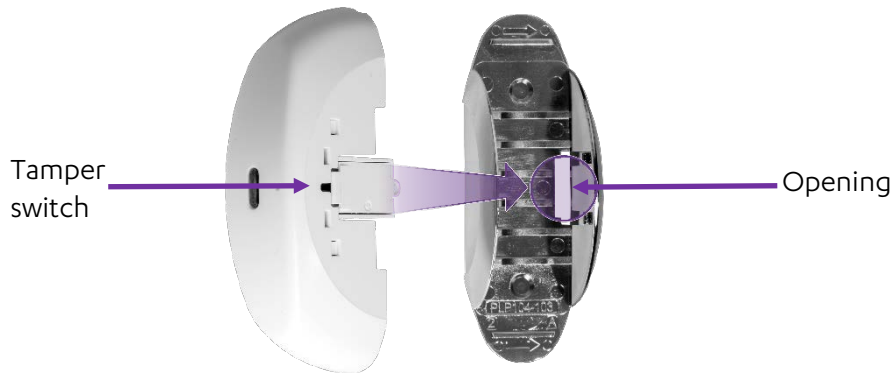

**Figure 23: Aligning the Tamper Switch Opening**

- Without tamper switch: align as in the figure below.

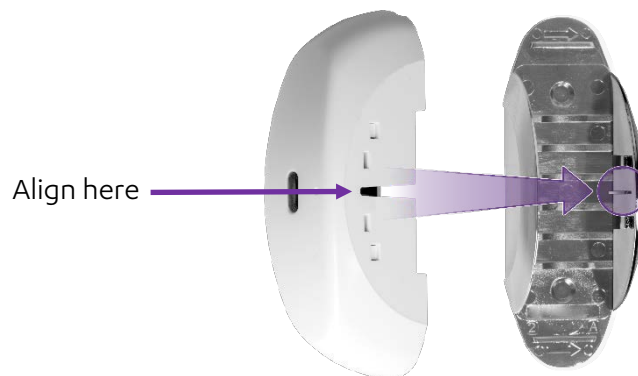

**Figure 24: Aligning the Transmitter and Base**

8. Clean and dry the mounting location surfaces.
9. Peel off the mounting-tape protective strips from both parts.



**Figure 25: Mounting Tape Protective Strips**

10. Mount the parts, as follows:

- Within 2.5 - 3 cm (1 - 1.2 in.) of each other when closed.
- Aligned using the dots.



**Figure 26: Dot Alignment of the Door/Window Sensor**

11. Test by opening and closing the door or window. The LED should turn **red** when you open and **green** when you close. Check if events are reported in your app **History** event list.

## 2.5.4 Installing a Siren

The siren is a battery-operated, wireless, acoustic warning device. You can also use the siren as a door bell.



**Figure 27: Siren**

To install the siren:

1. Choose a location according to the following recommendations:
  - A smooth surface on a flat wall
  - Accessible for maintenance yet not easily found by intruders
2. Release the siren mounting-base by lifting the tab and sliding the base in the tab's direction.

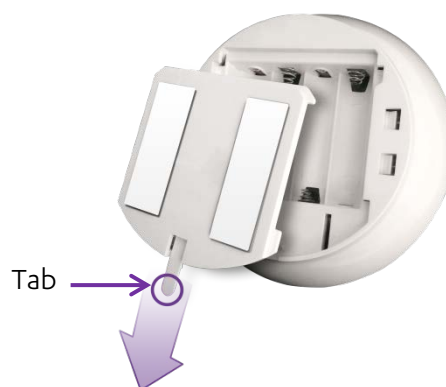

**Figure 28: Release Mounting-Base**

3. If the siren is not included in the WeR@Home™ kit, pair the siren as described in Appendix B Pairing a Device on page 50. Continue to step 7.

4. Press the tamper switch several times as in the figure below.

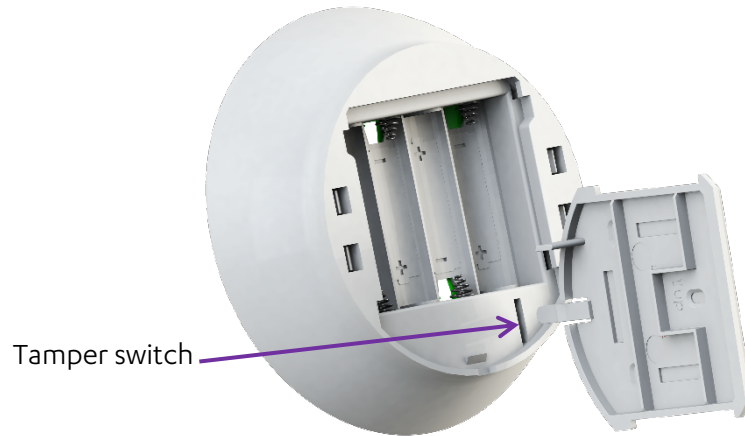

**Figure 29: Pressing Tamper**

5. Insert four AA alkaline batteries, observing the correct polarity.



**Figure 30: Siren Battery Insertion**

6. When prompted, enter a name and/or location for the device and tap **OK**. The siren appears in the list on the **Devices** screen.
7. Replace the mounting base onto the back of the siren.
8. Clean and dry the mounting location surface.
9. Peel off the mounting-tape protective strips.

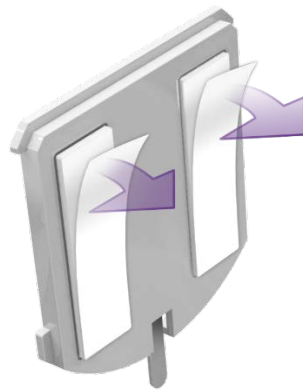

**Figure 31: Mounting Tape Protective Strips**

10. Press the siren into place.

### 2.5.5 Installing a Tag Reader and Tag

The tag reader is a battery operated, wireless, access control and system arming device.

Use your tag to arm and disarm your WeR@Home™. You can configure the tag reader for indoor or outdoor use. Outdoor use also allows you to use the tag reader as a doorbell. By default, the tag reader is configured for outdoor use.

---

 **NOTE:** When you use the tag reader as an indoor device, the tag is not required to arm your WeR@Home™.

---



**Figure 32: Tag Reader and Tag**



### 2.5.5.1 Installing the Tag Reader

To install the tag reader:

1. Choose a location that is near the premises' entrance, indoors or outdoors. Find a smooth, flat, vertical surface at the chosen location.
2. Release the tag reader mounting base by lifting the tab and sliding the base in the tab's direction.

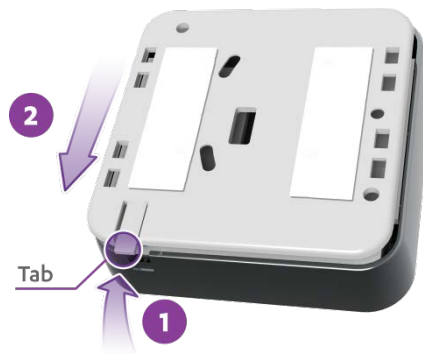

**Figure 33: Release Mounting Base**

3. If the tag reader is included in the WeR@Home™ kit, skip to step 3g.

Add the tag reader to WeR@Home™:

- a. Open the WeR@Home™ app.
- b. Tap . The main menu appears.
- c. Tap **DEVICES**. The **Devices** screen appears.
- d. Tap **Add device**. The **Add New Devices** screen appears.
- e. Select **Tag Reader**. The **Tag Reader** pairing screen appears as the device scan begins.
- f. Place the tag reader close to the hub.

- g. Press the tamper switch several times.

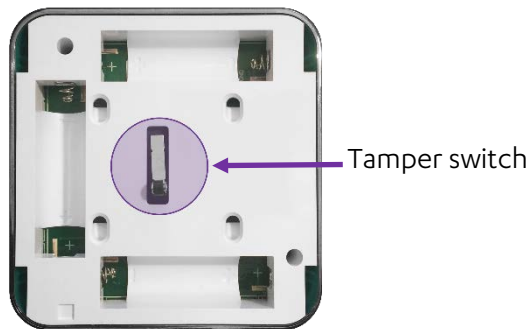

**Figure 34: Pressing Tamper**





- h. Insert three AA alkaline batteries, observing the correct polarity.

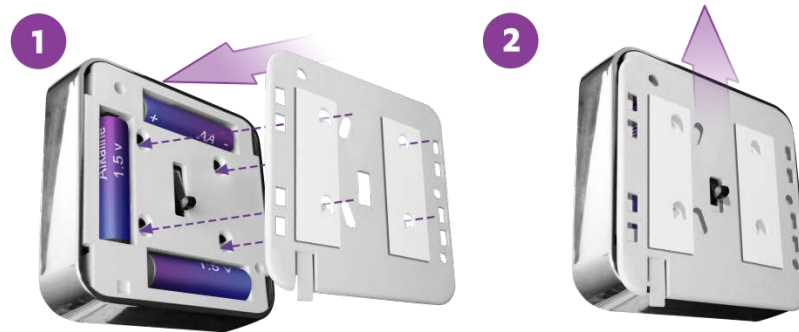

**Figure 35 – Inserting Batteries**

If the tag reader is included in the WeR@Home™ kit, skip to step 4.

When pairing is successful, a window appears prompting you to configure the tag reader.

- i. Enter a name and/or location for the device.
  - j. Tap  to configure the tag reader:
    -  outdoor use
    -  indoor use
  - k. If the tag reader is configured for outdoor use and you want to use the tag reader as a doorbell, tap **Configure**, for bell, tap , and tap **OK**. Otherwise, tap **OK**.
4. Align the mounting base onto the tag reader, guided by the curved latch tabs and the tamper switch and slide the base into place.



**Figure 36: Replace the Mounting Base**

5. Clean and dry the mounting location surface.
6. Peel off the mounting-tape protective strips.

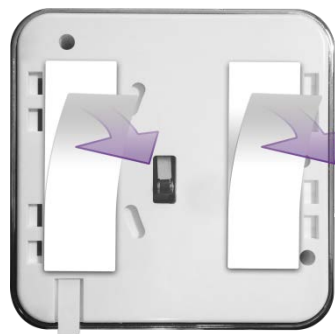

**Figure 37: Mounting Tape Protective Strips**

7. Press the tag reader into place.

### 2.5.5.2 Configuring the Tag Reader for an Access Code

You can configure your tag reader to require an access code together with the tag to disarm WeR@Home™.

To enable an access code:

1. Open the WeR@Home™ app.
2. Tap . The main menu appears.
3. Tap **SETTINGS**. The **Settings** screen appears.
4. Tap **Tag Access Code**. The **TR5 Access Code** screen appears.

5. Select the number of digits you want for your access code (4-10). A confirmation message appears.
6. Tap **Yes**.





**NOTE:** To disable the access code, select **None** and tap .

### 2.5.5.3 Activating Tags

Assign the tag to a user defined in WeR@Home™. To add a user, refer to the section on user management in the ESUGSL018 WeR@Home™ User Guide.

To add a tag:

1. Open the WeR@Home™ app.
2. Tap . The main menu appears.
3. Tap **DEVICES**. The **Devices** screen appears.
4. Tap **Add device**. The **Add New Devices** screen appears.
5. Select **Tag**. The **Select Owner User** screen appears.
6. Choose the user from the list. The **Tag** pairing screen appears.
7. Hold the tag against  on the tag reader and wait for the tag reader to detect the tag. When pairing succeeds, the LEDs on the tag reader light up.  
If you configured your tag reader to require an access code, a window appears prompting you to enter the access code.
8. If you configured your tag reader to require an access code, enter the access code.  
A window appears, prompting you to enter the tag name.
9. Enter the user's name as the tag name, and tap **OK**. The tag appears in the list on the **Devices** screen.

## 2.5.6 Installing a Flood Detector

The flood detector is a battery-operated, bi-directional, wireless sensor that detects water accumulation.

The flood detector consists of two connected parts:

- The transmitter
- The flood sensor

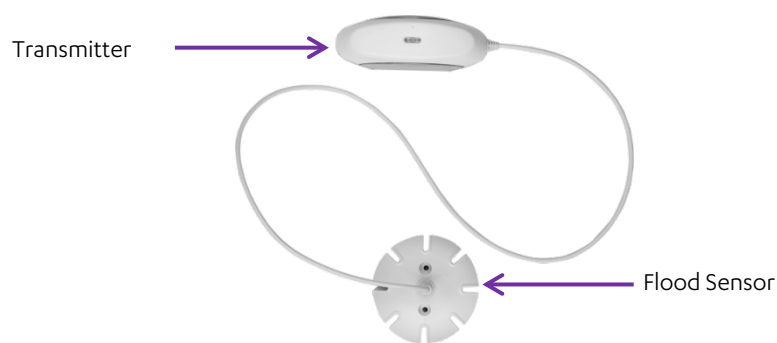



Figure 38: Flood Detector

To install the flood detector:

1. Choose a location according to the following recommendations:
  - In a location that may flood, like near the washing machine or bathtub
  - A flat smooth vertical surface for the transmitter
  - A flat smooth horizontal surface for the sensor
2. If the flood detector is included in the WeR@Home™ kit, skip to step 2g.  
Otherwise, add the flood detector to WeR@Home™:
  - a. Open the WeR@Home™ app.
  - b. Tap . The main menu appears.
  - c. Tap **DEVICES**. The Devices screen appears.
  - d. Tap **Add device**. The **Add New Devices** screen appears.
  - e. Select **Flood Detector**. The Flood Detector pairing screen appears as the device scan begins.
  - f. Place the transmitter close to the hub.
  - g. Release the transmitter from its mounting base by inserting and twisting a coin to open the cover.



**Figure 39: Releasing the Transmitter**

- h. Insert one AA alkaline battery, observing the correct polarity.
  - i. Insert the transmitter into its mounting base. If the flood detector is included in the WeR@Home™ kit, skip to step 3. When pairing is successful, a window appears prompting you to enter the device name.
  - j. Enter a name and/or location for the device and tap **OK**. The flood detector appears in the list on the **Devices** screen.
3. Clean and dry the surfaces of the mounting locations.
  4. Peel off the mounting-tape protective strips from both parts.



**Figure 40: Mounting Tape Protective Strips**

5. Press the sensor onto the floor.
6. Press the transmitter onto a nearby wall or furniture.



Figure 41: Example of Flood Detector Installation

### 2.5.7 Installing a Universal Transmitter

The universal transmitter enables you to detect changes in the state of third-party or legacy devices.



Figure 42: Universal Transmitter

To install the universal transmitter:

1. Choose an installation location. Find a flat, smooth, vertical surface at the location.
2. If the universal transmitter is included in the WeR@Home™ kit, skip to step 2l.

Otherwise, add the universal transmitter to WeR@Home™:

- a. Open the WeR@Home™ app.
- b. Tap . The main menu appears.
- c. Tap **DEVICES**. The **Devices** screen appears.
- d. Tap **Add device**. The **Add New Devices** screen appears.
- e. Select **Universal Transmitter**. The **Add UT Device** screen appears.

- f. Tap > to select device type. The **Select Device Type** screen appears displaying a list of third-party device types supported by WeR@Home™.
- g. Tap the device type you want. The **Add UT Device** screen appears for the selected device type.
- h. Set **Wire state open**:
  - the device circuit is open.
  - the device circuit is closed.
- i. For a security device, set **Report device status change**:
  - report changes to the hub.
  - do not report changes to the hub.
- j. Tap **OK**. The **Universal Transmitter** pairing screen appears as the device scan begins.
- k. Place the transmitter close to the hub.
- l. Release the transmitter from the mounting base by inserting and twisting a coin to separate the cover from the base.



**Figure 43: Releasing the Transmitter Base**

- m. Insert one AA alkaline battery, observing the correct polarity.
  - n. Insert the transmitter into the mounting base. If the universal transmitter is included in the WeR@Home™ kit, skip to step 3.  
When pairing is successful, a window appears prompting you to enter the device name.
  - o. Enter the device's system name and/or location and tap **OK**. The universal transmitter appears in the list on the **Devices** screen.
3. Clean and dry the mounting location surface.



4. Peel off the mounting-tape protective strips from the transmitter.



**Figure 44: Mounting Tape Protective Strips**

5. Press the transmitter into place.
6. Connect the Universal Transmitter with a third-party ON/OFF-type device, by connecting the wires at the end of the cord. The **red** wire is positive (+) and the **black** wire is negative (-).

The device must have a **+/- circuit** such that:

- When the circuit is closed, the device is ON.
- When the circuit is open, the device is OFF.

### 2.5.8 Installing a Z-Wave Plus Extender

Z-Wave allows you to convert your home into a Smart Home by giving you the ability to control and monitor your household devices. WeR@Home™ integrated with Z-Wave provides you with the tools to remotely manage your devices using a mobile app.

Z-Wave is a wireless technology designed for home automation. The core of Z-Wave technology is **interoperability**, enabling the incorporation of third-party devices with your WeR@Home™ network, to enhance your Smart Home experience.

When you connect the Z-Wave Plus extender to your WeR@Home™ hub, your WeR@Home™ becomes a Smart Home network that can support the following Z-Wave device types:

- Door locks
- Lock sensors
- On/Off switches
- Dimmers
- Thermostats
- Power strips
- Multi-channel devices with endpoints for the supported Z-Wave devices
- Multi-colored (RGBW) LED bulbs
- Multi-input/ multi-output devices
- Glass break detectors
- Garage door controllers

For information about installing the Z-Wave Plus extender and WeR@Home™ working with Z-Wave, refer to the ESUGSL015 WeR@Home™ Z-Wave User Guide.

## 2.5.9 Installing an HD Camera

You can integrate HD network cameras with your WeR@Home™.

For information about installing the HD camera, refer to the ESUGSL022 WeR@Home™ HD Camera User Guide.

## 2.6. Installing a Smart Repeater

The WeR@Home™ Smart Repeater extends the range of your WeR@Home™ hub, to help you maximize the coverage of your home by WeR@Home™. The repeater allows you to connect devices to WeR@Home™ which could not otherwise connect to the hub. The repeater manages the peripheral devices connected to it, acts as a gateway to the Essence Cloud, and communicates with the Essence servers which provide data to the app.

You install a repeater by adding it to an existing WeR@Home™.

Installing the repeater involves:

- Ensuring you have the supplied:
  - Backup battery
  - SIM-card
- Choosing a suitable location
- Setting up the repeater



**NOTE:** For information about installing the repeater, refer to [Finding a Suitable Location](#), [Setting up the Repeater](#), and [Adding Peripheral Devices to the Repeater](#). For all other information about the repeater, refer to ESUGSL038 WeR@Home Smart Repeater User Guide.

### 2.6.1 Finding a Suitable Location

To choose a location for the repeater, consider the following:

- Install on a flat surface

- Choose a location with adequate cellular reception
- It is recommended to position the repeater at least 1 m (3.3 ft.) away from the planned location of the peripheral devices to be connected to the repeater.

## 2.6.2 Setting up the Repeater



**NOTE:** WeR@Home™ must be disarmed when you set up a repeater.

To set up the repeater:

1. Open the WeR@Home™ app.
2. Tap . The main menu appears.
3. Tap **DEVICES**. The **Devices** screen appears.
4. Tap **Add device**. The **Add New Devices** screen appears.
5. Select **Repeater**. The installation tutorial appears.
6. Follow the instructions in the tutorial:
  - a. Remove the back cover from the repeater.



**Figure 45: Remove Back Cover**

- b. Ensure the SIM-card is securely installed.

- c. Insert the backup battery into the battery compartment, above the SIM-card, such that the battery label faces upward and the battery contacts face the repeater's base.



**Figure 46: Insert Backup Battery**

- d. Return the back cover to the repeater.
  - e. Plug the power adapter cable into the mini-USB connector on the back of the repeater and the power adapter cube into a power outlet. The LED on the front panel lights up red.
  - f. Wait for the LED on the front panel to light up green.
  - g. Take a note of the serial number on the bottom of the repeater.
7. In the app, tap **Register now**.
  8. In the app, enter the serial number and tap **Next**. The server checks if the repeater and the hub are using the same version of the software. If there is a difference, the server upgrades the lower version to match the other, then updates the repeater's configuration.
  9. Give the repeater a name, and the repeater is then added to the list of devices.
  10. Put the repeater in its location. You can now add peripheral devices to the repeater.



**NOTE:** You can add up to two repeaters to each hub.

### 2.6.3 Adding Peripheral Devices to the Repeater

You can add up to 63 devices to a repeater.

Adding a new peripheral device to the repeater involves:

- Adding each device to WeR@Home™ by pairing the device with the repeater
- Installing the device in the chosen location



**NOTE:** You must connect the Z-Wave dongle, any Z-Wave or NEST devices, or HD cameras, to a hub and not to a repeater.

Refer to Pairing a Device on page 50.

## 2.7. Testing the Signal Strength of Peripheral Devices

Once you have added a peripheral device to your WeR@Home™, you can test the signal strength.



**NOTE:** You cannot check the signal coverage for a tag or a remote control.

To test the signal strength:

1. Tap . The main menu appears.
2. Tap **DEVICES**. The **Devices** screen appears.
3. Tap the device whose signal strength you want to check. Device settings are displayed.
4. Tap **Test Signal Strength**, and follow the on-screen instructions. WeR@Home™ tests the signal strength and displays the result as one of the following:
  - Red – signal strength is low. Find a location for the device with better signal coverage.
  - Orange – signal strength is acceptable. Consider finding a location for the device with better signal coverage.
  - Green – signal strength is good.
  - Green with red exclamation mark – signal strength is good, but the device is too close to the hub. Find a location for the device that is further away from the hub.

### 3. Setting-Up Your WeR@Home™

To set up the way you use WeR@Home™, you can configure the following:

- Customizing PIN protection
- Arming and disarming WeR@Home™
- Working with multiple places
- Configuring devices
- Managing users
- Using Smart Rules

For detailed instructions, refer to ESUGSL018 WeR@Home™ User Guide.

## Appendix A Technical Specifications

This section includes the following:

- Hub (ES8000CP)
- Remote Control (ES800KF)
- Camera Detector (ES800IPD)
- Motion Detector (ES800PIR)
- Door/Window Sensor (ES800MGL)
- Siren (ES800SRN)
- Tag Reader (ES800TR)
- Flood Detector (ES800FL)
- Universal Transmitter (ES800UT)
- Z-Wave Plus Extender (ES800ZWP)
- Smart Repeater (ES800RP)
- Maximum System Configuration per Hub
- FCC and IC Safety Notice



**NOTE:** The full part number is required when ordering components. Contact your Essence account manager or professional services personnel to receive the part numbers.

**Table 3: Hub (ES8000CP)**

Category	Specifications
Communications	<ul style="list-style-type: none"> <li>■ <b>Maximum RF range:</b> 600 m (1,968 ft.) open air</li> <li>■ ECOP bi-directional radio protocol</li> <li>■ <b>Modulation and frequency:</b> DSSS, 2.4GHz</li> <li>■ <b>Maximum transmission:</b> 25 mW (14 dBm)</li> <li>■ <b>Data security:</b> 128-bit AES encryption</li> <li>■ <b>Cloud (internet):</b> <ul style="list-style-type: none"> <li>● LAN/Ethernet port: downlink 384 kBps, uplink 120 kBps</li> <li>● Optional 3G/4G(HSPA+) support (separate PN)</li> </ul> </li> </ul>

Category	Specifications
<b>Power</b>	<ul style="list-style-type: none"> <li>■ 100-240 V AC to 5 V DC power adapter/charger</li> <li>■ 3.7 V 1.4 Ah Li-polymer rechargeable backup battery</li> <li>■ Maximum three hours battery life</li> </ul>
<b>Dimensions</b>	<ul style="list-style-type: none"> <li>■ <b>Size (H x W x D):</b> 141 x 75 x 41 mm (5.6 x 3 x 1.6 in.)</li> <li>■ <b>Weight:</b> 125 g (0.28 lb.) + 35 g (0.08 lb.) backup battery</li> <li>■ <b>LAN cable:</b> UTP unshielded twisted-pair cable, maximum length 3 m (10 ft.)</li> </ul>
<b>Environment</b>	<ul style="list-style-type: none"> <li>■ <b>Storage ambient temperature range:</b> -20°C to 60°C (-4°F to 140°F)</li> <li>■ <b>Operating ambient temperature range with battery:</b> -5°C to 50°C (23°F to 122°F)</li> <li>■ <b>RF operating humidity:</b> up to 95% non-condensing</li> </ul>
<b>Compliance</b>	<ul style="list-style-type: none"> <li>■ <b>FCC:</b> cellular/non-cellular versions - YXG-ES8000GP/Y4I-ES8000CP</li> <li>■ <b>IC:</b> cellular version - 11061A-ES8000GP</li> </ul> <p>NOTE: The <a href="#">FCC and IC Safety Notice</a> applies to this device</p>

**Table 4: Remote Control (ES800KF)**

Category	Specifications
<b>Communications</b>	<ul style="list-style-type: none"> <li>■ <b>Maximum RF range:</b> 600 m (1,968 ft.) open air</li> <li>■ ECOP bi-directional radio protocol</li> <li>■ <b>Modulation and frequency:</b> DSSS, 2.4 GHz</li> <li>■ <b>Maximum transmission:</b> 25 mW (14 dBm)</li> <li>■ <b>Data security:</b> 128-bit AES encryption</li> </ul>
<b>Power</b>	<ul style="list-style-type: none"> <li>■ One 3 V CR2450 lithium battery</li> <li>■ Three-year battery life</li> </ul>
<b>Dimensions</b>	<ul style="list-style-type: none"> <li>■ <b>Size (H x W x D):</b> 61 x 43 x 12 mm (2.4 x 1.7 x 0.5 in.)</li> <li>■ <b>Weight:</b> 25 g (0.06 lb.) including the battery</li> </ul>
<b>Environment</b>	<ul style="list-style-type: none"> <li>■ <b>Storage ambient temperature range:</b> -10°C to 55°C (14°F to 131°F)</li> <li>■ <b>Operating ambient temperature range with battery:</b> -5°C to 55°C (23°F to 131°F)</li> <li>■ <b>RF operating humidity:</b> up to 95% non-condensing</li> </ul>
<b>Compliance</b>	<ul style="list-style-type: none"> <li>■ <b>FCC:</b> Y4I-M801EKFB</li> <li>■ <b>IC:</b> 11061A-ES800KF</li> </ul> <p>NOTE: The <a href="#">FCC and IC Safety Notice</a> applies to this device</p>



**Table 5: Camera Detector (ES800IPD)**

Category	Specifications
<b>Communications</b>	<ul style="list-style-type: none"> <li>■ <b>Maximum RF range:</b> 500 m (1,640 ft.) open air</li> <li>■ <b>Maximum transmission:</b> 25 mW (14 dBm)</li> <li>■ ECOP bi-directional radio protocol</li> <li>■ <b>Modulation and frequency:</b> DSSS, 2.4 GHz</li> <li>■ <b>Data security:</b> 128-bit AES encryption</li> </ul>
<b>Security</b>	<ul style="list-style-type: none"> <li>■ <b>Tamper alarm:</b> when unit is tilted</li> <li>■ <b>Detection range:</b> up to 12 m (39.4 ft.)</li> </ul>
<b>Image Capture</b>	<ul style="list-style-type: none"> <li>■ <b>Captures color motion:</b> JPEG photos (up to 5 frames per second)</li> <li>■ <b>Supported video resolutions:</b> 80 x 60 (QQQVGA) to 640 x 480 (VGA)</li> <li>■ <b>Illumination</b> (at night or in low-light conditions) auto-activated super-bright white LED</li> <li>■ <b>Diagonal shooting angle:</b> 90°</li> </ul>
<b>Special Features</b>	<ul style="list-style-type: none"> <li>■ 4G DragonFlyEye™ lens technology for optional pet immunity</li> <li>■ Optional up to 30 kg (66 lb.) pet immune lens</li> <li>■ Temperature compensation for the motion detector element</li> </ul>
<b>Power</b>	<ul style="list-style-type: none"> <li>■ Three AA size alkaline batteries</li> <li>■ One-year battery life</li> </ul>
<b>Dimensions</b>	<ul style="list-style-type: none"> <li>■ <b>Size (H x W x D):</b> 123 x 58 x 60 mm (4.8 x 2.4 x 2.4 in.)</li> <li>■ <b>Weight:</b> 160 g (0.35 lb.) + 45 g (0.1 lb.) batteries</li> </ul>
<b>Environment</b>	<ul style="list-style-type: none"> <li>■ <b>Storage ambient temperature range:</b> -20°C to 50°C (-4°F to 122°F)</li> <li>■ <b>Operating ambient temperature range with batteries:</b> 0°C to 50°C (32°F to 122°F)</li> <li>■ <b>RF operating humidity:</b> up to 95% non-condensing</li> </ul>
<b>Compliance</b>	<ul style="list-style-type: none"> <li>■ FCC: Y4I-M800IPD</li> <li>■ IC: 11061A-ES800IPD</li> </ul> <p>NOTE: The <a href="#">FCC and IC Safety Notice</a> applies to this device</p>

**Table 6: Motion Detector (ES800PIR)**

Category	Specifications
<b>Communication</b>	<ul style="list-style-type: none"> <li>■ <b>Maximum RF range:</b> 500 m (1,640 ft.) open air</li> <li>■ <b>Maximum transmission:</b> 25 mW (14 dBm)</li> <li>■ ECOP bi-directional radio protocol</li> <li>■ <b>Modulation and frequency:</b> DSSS, 2.4 GHz</li> <li>■ <b>Data security:</b> 128-bit AES encryption</li> </ul>
<b>Security</b>	<ul style="list-style-type: none"> <li>■ <b>Tamper alarm:</b> when unit is tilted</li> <li>■ <b>Detection range:</b> up to 12 m (39.4 ft.)</li> </ul>
<b>Power Consumption</b>	<ul style="list-style-type: none"> <li>■ Two AA-size alkaline batteries</li> <li>■ Three-year battery life</li> </ul>

Category	Specifications
Special Features	<ul style="list-style-type: none"> <li>■ 4G DragonFlyEye™ lens technology for optimal pet immunity</li> <li>■ Optional up to 30 kg (66 lb.) pet immune lens</li> <li>■ Temperature compensation for the motion detector element</li> </ul>
Dimensions	<ul style="list-style-type: none"> <li>■ <b>Size (H x W x D):</b> 114 x 60 x 50 mm (4.5 x 2.4 x 2.0 in.)</li> <li>■ <b>Weight:</b> 90 g (0.2 lb.) + 30 g (0.07 lb.) batteries</li> </ul>
Environment	<ul style="list-style-type: none"> <li>■ <b>Storage ambient temperature range:</b> -20°C to 50°C (-4°F to 122°F)</li> <li>■ <b>Operating ambient temperature range with batteries:</b> 0°C to 50°C (32°F to 122°F)</li> <li>■ <b>RF operating humidity:</b> up to 95% non-condensing</li> </ul>
Compliance	<ul style="list-style-type: none"> <li>■ FCC: Y4I-M800PIR</li> <li>■ IC: 11061A-ES800PIR</li> </ul> <p>NOTE: The <a href="#">FCC and IC Safety Notice</a> applies to this device</p>

**Table 7: Door/Window Sensor (ES800MGL)**

Category	Specifications
Communication	<ul style="list-style-type: none"> <li>■ <b>Maximum RF range:</b> 500 m (1,640 ft.) open air</li> <li>■ <b>Maximum transmission:</b> 25 mW (14 dBm)</li> <li>■ ECOP bi-directional radio protocol</li> <li>■ <b>Modulation and frequency:</b> DSSS, 2.4 GHz</li> <li>■ <b>Data security:</b> 128-bit AES encryption</li> </ul>
Security	<ul style="list-style-type: none"> <li>■ <b>Optional tamper mechanism with double trigger:</b> <ul style="list-style-type: none"> <li>● When the transmitter is removed from its mounting base</li> <li>● When the device is removed from its location</li> </ul> </li> </ul>
Power	<ul style="list-style-type: none"> <li>■ One AA size alkaline battery</li> <li>■ Two-year battery life</li> </ul>
Dimensions	<ul style="list-style-type: none"> <li>■ <b>Transmitter</b> <ul style="list-style-type: none"> <li>● Size (H x W x D): 72 x 30 x 25 mm (2.8 x 1.2 x 1.0 in.)</li> <li>● Weight: 25 g (0.06 lb.) + 15 g (0.03 lb.) battery</li> </ul> </li> <li>■ <b>Magnet</b> <ul style="list-style-type: none"> <li>● Size (H x W x D): 52 x 24 x 18 mm (2 x 0.9 x 0.7 in.)</li> <li>● Weight: 25 g (0.06 lb.)</li> </ul> </li> </ul>
Environment	<ul style="list-style-type: none"> <li>■ <b>Storage ambient temperature range:</b> -20°C to 50°C (-4°F to 122°F)</li> <li>■ <b>Operating ambient temperature range with battery:</b> 0°C to 50°C (32°F to 122°F)</li> <li>■ <b>RF operating humidity:</b> up to 95% non-condensing</li> </ul>
Compliance	<ul style="list-style-type: none"> <li>■ FCC: YXG-ES800MGL</li> <li>■ IC: 11061A-ES800MGLI</li> </ul> <p>NOTE: The <a href="#">FCC and IC Safety Notice</a> applies to this device</p>

**Table 8: Siren (ES800SRN)**

Category	Specifications
<b>Communications</b>	<ul style="list-style-type: none"> <li>■ <b>Maximum RF range:</b> 500 m (1,640 ft.) open air</li> <li>■ <b>Maximum transmission:</b> 25 mW (14 dBm)</li> <li>■ ECOP bi-directional radio protocol</li> <li>■ <b>Modulation and frequency:</b> DSSS, 2.4 GHz</li> <li>■ <b>Data security:</b> 128-bit AES encryption</li> </ul>
<b>Security</b>	<ul style="list-style-type: none"> <li>■ <b>Tamper Alarm:</b> when removed from mounting base</li> </ul>
<b>Power</b>	<ul style="list-style-type: none"> <li>■ Four AA-size alkaline batteries</li> <li>■ Two-year battery life</li> </ul>
<b>Dimensions</b>	<ul style="list-style-type: none"> <li>■ <b>Size (H x W x D):</b> 120 x 120 x 39 mm (4.7 x 4.7 x 1.5 in.)</li> <li>■ <b>Weight:</b> 150 g (0.33 lb.) + 100 g (0.22 lb.) batteries</li> </ul>
<b>Environment</b>	<ul style="list-style-type: none"> <li>■ <b>Storage ambient temperature range:</b> -20°C to 50°C (-4°F to 122°F)</li> <li>■ <b>Operating ambient temperature range with batteries:</b> 0°C to 50°C (32°F to 122°F)</li> <li>■ <b>RF operating humidity:</b> up to 95% non-condensing</li> </ul>
<b>Compliance</b>	<ul style="list-style-type: none"> <li>■ <b>FCC:</b> Y4I-M800SRN</li> <li>■ <b>IC:</b> 11061A-ES800SRN</li> </ul> <p>NOTE: The <a href="#">FCC and IC Safety Notice</a> applies to this device</p>

**Table 9: Tag Reader (ES800TR)**

Category	Specifications
<b>Communications</b>	<ul style="list-style-type: none"> <li>■ <b>Maximum RF range:</b> 500 m (1,640 ft.) open air</li> <li>■ <b>Maximum transmission:</b> 25 mW (14 dBm)</li> <li>■ ECOP bi-directional radio protocol</li> <li>■ <b>Modulation and frequency:</b> DSSS, 2.4 GHz</li> <li>■ <b>RFID band:</b> ISO 14443<sup>3</sup>/MiFare, 106 kbps, 13.56 MHz</li> <li>■ <b>Data security:</b> 128-bit AES encryption</li> </ul>
<b>Security</b>	<ul style="list-style-type: none"> <li>■ <b>Tamper alarm:</b> when detached from wall</li> <li>■ Support for up to 8 tags</li> </ul>
<b>Power</b>	<ul style="list-style-type: none"> <li>■ Three AA size alkaline batteries (reader only)</li> <li>■ One-year battery life</li> </ul>
<b>Dimensions</b>	<ul style="list-style-type: none"> <li>■ <b>Reader</b> <ul style="list-style-type: none"> <li>● Size (H x W x D): 98 x 98 x 28 mm (3.9 x 3.9 x 1.0 in.)</li> <li>● Weight: 135 g (0.3 lb.) + 45 g (0.1 lb.) batteries</li> </ul> </li> <li>■ <b>Tag</b> <ul style="list-style-type: none"> <li>● Size (H x W x D): 47 x 33 x 10 mm (1.9 x 1.3 x 0.4 in.)</li> <li>● Weight: 10 g (0.02 lb.)</li> </ul> </li> </ul>

Category	Specifications
Environment	<ul style="list-style-type: none"> <li>■ Storage ambient temperature range: -20°C to 50°C (-4°F to 122°F)</li> <li>■ Operating ambient temperature range with battery: 0°C to 50°C (32°F to 122°F)</li> <li>■ RF operating humidity: up to 95% non-condensing</li> </ul>
Compliance	<ul style="list-style-type: none"> <li>■ FCC: YXG-ES800TR5</li> <li>■ IC: 11061A-ES800TR5</li> </ul> <p>NOTE: The <a href="#">FCC and IC Safety Notice</a> applies to this device</p>

**Table 10: Flood Detector (ES800FL)**

Category	Specifications
Communications	<ul style="list-style-type: none"> <li>■ Maximum RF range: 500 m (1,640 ft.) open air</li> <li>■ ECOP bi-directional radio protocol</li> <li>■ Modulation and frequency: DSSS, 2.4 GHz</li> <li>■ Data security: 128-bit AES encryption</li> </ul>
Power	<ul style="list-style-type: none"> <li>■ One AA size alkaline battery</li> <li>■ Two-year battery life</li> </ul>
Dimensions	<ul style="list-style-type: none"> <li>■ Transmitter                             <ul style="list-style-type: none"> <li>● Size (H x W x D): 72 x 25 x 30 mm (2.8 x 1.0 x 1.2 in.)</li> <li>● Weight: 25 g (0.06 lb.) + 15 g (0.03 lb.) battery</li> </ul> </li> <li>■ Sensor                             <ul style="list-style-type: none"> <li>● Size (H x W x D): 50 x 50 x 22 mm (2 x 2 x 0.9 in.)</li> <li>● Weight: 25 g (0.06 lb.)</li> </ul> </li> <li>■ Cable length: 30 cm (11.8 in.)</li> </ul>
Environment	<ul style="list-style-type: none"> <li>■ Storage ambient temperature range: -20°C to 50°C (-4°F to 122°F)</li> <li>■ Operating ambient temperature range with battery: 0°C to 50°C (32°F to 122°F)</li> <li>■ RF operating humidity: up to 95% non-condensing</li> </ul>
Compliance	<ul style="list-style-type: none"> <li>■ FCC: YXG-ES800FL</li> <li>■ IC: 11061A-ES800FL</li> </ul> <p>NOTE: The <a href="#">FCC and IC Safety Notice</a> applies to this device</p>

**Table 11: Universal Transmitter (ES800UT)**

Category	Specifications
<b>Communications</b>	<ul style="list-style-type: none"> <li>■ <b>Maximum RF range:</b> 500 m (1,640 ft.) open air</li> <li>■ ECOP bi-directional radio protocol</li> <li>■ <b>Modulation and frequency:</b> DSSS, 2.4 GHz</li> <li>■ <b>Data security:</b> 128-bit AES encryption</li> </ul>
<b>Power</b>	<ul style="list-style-type: none"> <li>■ One AA size alkaline battery</li> <li>■ Two-year battery life</li> </ul>
<b>Dimensions</b>	<ul style="list-style-type: none"> <li>■ <b>Size (H x W x D):</b> 72 x 30 x 25 mm (2.8 x 1.2 x 1.0 in.)</li> <li>■ <b>Weight:</b> 25 g (0.06 lb.) + 15 g (0.03 lb.) battery</li> <li>■ <b>Cable length:</b> 30 cm (11.8in.)</li> </ul>
<b>Environment</b>	<ul style="list-style-type: none"> <li>■ <b>Storage ambient temperature range:</b> -20°C to 50°C (-4°F to 122°F)</li> <li>■ <b>Operating ambient temperature range with battery:</b> 0°C to 50°C (32°F to 122°F)</li> <li>■ <b>Humidity:</b> up to 95% non-condensing</li> </ul>
<b>Compliance</b>	<ul style="list-style-type: none"> <li>■ <b>FCC:</b> YXG-ES800UT</li> <li>■ <b>IC:</b> 11061A-ES800UT</li> </ul> <p>NOTE: The <a href="#">FCC and IC Safety Notice</a> applies to this device</p>

**Table 12: Z-Wave Plus Extender (ES800ZWP)**

Category	Specifications
<b>Technology</b>	<ul style="list-style-type: none"> <li>■ Uses the Z-Wave® 500-series chip</li> </ul>
<b>Supported Z-Wave Device Types</b>	<ul style="list-style-type: none"> <li>■ Binary switches (For example, ON/OFF devices)</li> <li>■ Multi-level switches (For example, dimmers)</li> <li>■ Thermostats</li> <li>■ Door locks</li> <li>■ Multi-channel devices (For example, power strips)</li> <li>■ RGBW LED bulbs</li> </ul>
<b>Controller Capacity</b>	The maximum capacity for a single Z-Wave Plus Extender is up to 232 Z-Wave devices.

Category	Specifications
Communications	<ul style="list-style-type: none"> <li>■ <b>Maximum RF range:</b> 30 m (98 ft.) open air</li> <li>■ Z-Wave bi-directional radio protocol (onboard)</li> <li>■ Modulation and frequency: GFSK Modulation                             <ul style="list-style-type: none"> <li>● 868.4 MHz (Europe)</li> <li>● 908.4 MHz (USA, Canada, Mexico)</li> <li>● 921.4 MHz (Australia)</li> <li>● 869 MHz (Russia)</li> <li>● 926.3 MHz (Japan)</li> <li>● 916 MHz (Israel)</li> </ul> </li> <li>■ <b>Bit Rate:</b> up to 100 kbps</li> </ul>
Security	<ul style="list-style-type: none"> <li>■ <b>Data security:</b> 128-bit AES encryption</li> <li>■ Unique electronic serial number</li> </ul>
Power	<ul style="list-style-type: none"> <li>■ Powered only by the hub's power adapter</li> </ul> <p><b>Note:</b> In the event of a power outage, the Z-Wave Plus Extender is not powered by the hub's backup battery</p>
Dimensions	<ul style="list-style-type: none"> <li>■ <b>Size (H x L x D):</b> 5 x 58 x 24 mm (0.2 x 2.3 x 0.9 in.)</li> <li>■ <b>Weight:</b> 10 g (0.03 lb.)</li> <li>■ <b>Cable length:</b> 15 cm (5.9 in.)</li> </ul>
Environment	<ul style="list-style-type: none"> <li>■ <b>Storage ambient temperature range:</b> -20°C to 50°C (-4°F to 122°F)</li> <li>■ <b>Operating ambient temperature range with battery:</b> 0°C to 50°C (32°F to 122°F)</li> <li>■ <b>RF operating humidity:</b> up to 95% non-condensing</li> </ul>
Compliance	<ul style="list-style-type: none"> <li>■ FCC: YXG-ES800ZWP</li> <li>■ IC: 11061A-ES800ZWP</li> </ul> <p><b>NOTE:</b> The <a href="#">FCC and IC Safety Notice</a> applies to this device</p> <ul style="list-style-type: none"> <li>■ CE: Safety: EN 60950-1; Radio: EN 300 220-2; EMC EN 301 489-1; EN 301 489-3</li> <li>■ Z-Wave Plus certification</li> </ul>

**Table 13: Smart Repeater (ES800RP)**

Category	Specifications
Communications	<ul style="list-style-type: none"> <li>■ <b>Maximum RF range:</b> 600 m (1,968 ft.) open air</li> <li>■ ECOP bi-directional radio protocol</li> <li>■ <b>Modulation and frequency:</b> DSSS, 2.4 GHz</li> <li>■ <b>Maximum transmission:</b> 25 mW (14 dBm)</li> <li>■ <b>Data security:</b> 128 bit AES encryption</li> <li>■ <b>Cloud (internet):</b> 3G/4G (HSPA+)</li> </ul>

Category	Specifications
<b>Power</b>	<ul style="list-style-type: none"> <li>■ 100-240 V AC to 5 V DC power adapter/charger</li> <li>■ 3.7 V 1.4 Ah Li-polymer rechargeable backup battery</li> <li>■ Maximum three hours battery life</li> </ul>
<b>Dimensions</b>	<ul style="list-style-type: none"> <li>■ <b>Size (H x W x D):</b> 141 x 75 x 41 mm (5.6 x 3 x 1.6 in.)</li> <li>■ <b>Weight:</b> 125 g (0.27 lb.) + 35 g (0.08 lb.) backup battery</li> </ul>
<b>Environment</b>	<ul style="list-style-type: none"> <li>■ <b>Storage ambient temperature range:</b> -20°C to 60°C (-4°F to 140°F)</li> <li>■ <b>Operating ambient temperature range with battery:</b> -5°C to 50°C (23°F to 122°F)</li> <li>■ <b>RF operating humidity:</b> up to 95% non-condensing</li> </ul>
<b>Compliance</b>	<ul style="list-style-type: none"> <li>■ <b>FCC:</b> Y4I- ES8000CP, YXG-ES8000GP</li> <li>■ <b>IC:</b> 11061A-ES8000GP</li> </ul> <p>NOTE: The <a href="#">FCC and IC Safety Notice</a> applies to this device</p> <ul style="list-style-type: none"> <li>■ <b>CE – EMC:</b> <ul style="list-style-type: none"> <li>● ETSI EN 301 489-1 V1.9.2</li> <li>● ETSI EN 301 489-3 V1.6.1</li> <li>● EN 61000-6-3: 2007/A1: 2011</li> </ul> </li> <li>■ <b>CE – Radio:</b> <ul style="list-style-type: none"> <li>● ETSI EN 300 220-1 V3.1.1: 2017</li> <li>● ETSI EN 300 220-2 V3.1.1:2017</li> </ul> </li> <li>■ <b>CE – Safety:</b> <ul style="list-style-type: none"> <li>● EN 60950-1: 2006/A11: 2009/A1: 2010/A12: 2011/A2: 2013</li> </ul> </li> </ul>

**Table 14: Maximum System Configuration per Hub**

Device or Group	Maximum	Maximum Within Group	
<b>Total Devices</b>	91		
<b>Security Group</b>	64	Camera Detector	8
		Motion Detector	64
		Door/Window Sensor	64
		Tag Reader	8 with 8 tags
		Universal Transmitter	64
<b>Safety Group</b>	16	Smoke Alarm	16
		Flood detector	16
		Universal Transmitter	16
<b>Siren</b>	3		
<b>Remote Control</b>	8		
<b>Smart Repeaters*</b>	2		
<b>Z-Wave Plus Extender</b>	1 for up to 232 Z-Wave devices		
<b>HD Camera</b>	Depends on the service package		

\*You can add up to 63 devices to a repeater.

## FCC and IC Safety Notice

This device complies with Part 15 of the FCC Rules.

Operation is subject to the following two conditions:

1. This device may not cause harmful interference, and
2. This device must accept any interference received, including interference that may cause undesired operation.

Le présent appareil est conforme aux CNR d'Industrie Canada applicables aux appareils radio exempts de licence. L'exploitation est autorisée aux deux conditions suivantes:

1. l'appareil ne doit pas produire de brouillage;
2. l'utilisateur de l'appareil doit accepter tout brouillage radioélectrique subi, même si le brouillage est susceptible d'en compromettre le fonctionnement.



Changes or modifications to this equipment not expressly approved by the party responsible for compliance (Essence Security International Ltd.) could void the user's authority to operate the equipment.

**WARNING!** To comply with FCC and IC RF exposure compliance requirements, the device should be located at a distance of at least 20 cm from all persons during normal operation. The antennas used for this product must not be co-located or operated in conjunction with any other antenna or transmitter.

Le dispositif doit être placé à une distance d'au moins 20 cm à partir de toutes les personnes au cours de son fonctionnement normal. Les antennes utilisées pour ce produit ne doivent pas être situés ou exploités conjointement avec une autre antenne ou transmetteur.

**NOTE:** This equipment has been tested and found to comply with the limits for a Class B digital device, pursuant to Part 15 of the FCC Rules. These limits are designed to provide reasonable protection against harmful interference in a residential installation. This equipment generates, uses and can radiate radio frequency energy and, if not installed and used in accordance with the instructions, may cause harmful interference to radio communications. However, there is no guarantee that interference will not occur in a particular installation. If this equipment does cause harmful interference to radio or television reception, which can be determined by turning the equipment off and on, the user is encouraged to try to correct the interference by one or more of the following measures:

- Reorient or relocate the receiving antenna.
- Increase the separation between the equipment and receiver.
- Connect the equipment into an outlet on a circuit different from that to which the receiver is connected.
- Consult the dealer or an experienced radio/TV technician for help.

This Class B digital apparatus complies with Canadian ICES-003.

Cet appareil numérique de la classe B est conforme à la norme NMB-003 du Canada.

## Appendix B Pairing a Device

To pair a device:

1. Tap . The main menu appears.
2. Tap **DEVICES**. The **Devices** screen appears.
3. Tap **Add device**. The **Add New Devices** screen appears displaying a list of the available device types.
4. Select a device type. The **Connect to** screen appears displaying the hub and repeaters.



**NOTE:** If you select a device which must be connected to the hub, the Connect to screen is not displayed, and instead the Pairing screen appears.

---

5. Tap the hub or the repeater you want to add the device to. The **Pairing** screen appears and WeR@Home™ scans for the device.
6. Place the device close to the hub or smart repeater.
7. If the device has a tamper switch, activate the tamper.
8. Insert the batteries.
9. When prompted by the app, enter the device's system name and/or location and other device attributes.
10. Tap **OK**.

## Appendix C The WeR@Home™ Kit

WeR@Home™ products are usually sold as boxed kits which include a predefined set of devices similar to the one shown in Figure 47. The components included in the kit, except for the remote control, are pre-paired with the hub in the kit. The remote control is not pre-paired because the device must be assigned to a specific user.



Figure 47: A Sample WeR@Home™ Kit

## Appendix D Installing with Screws

As an option, you can install WeR@Home™ devices with screws.

Installing with screws:

- Allows more flexibility in choosing installation locations
- Provides support when installing at a difficult angle
- Can reinforce the tape installation

Prepare the following equipment:

- A drill with an appropriate bit
- A Philips screwdriver
- 3 x 35 DIN 7982 C screws and wall anchors. The number of the screws and wall anchors is determined by the device being installed. Screws and wall anchors are not provided.

The table below is a summary of Essence recommendations regarding screws and wall anchors.

**Table 15: Screws and Wall Anchors**

Device	Components	Quantity per Device
Camera Detector		2-6
Motion Detector		
Door/Window Sensor	Transmitter	2
	Magnet	
Siren		3
Tag Reader		4
Flood Detector	Transmitter	2
	Sensor	
Universal Transmitter	Transmitter	2

The following are instructions for installing with screws by device type.

## Motion and Camera Detectors

The mounting-base has eight holes to allow for installation flexibility. Varying combinations of holes allows you to install the camera or motion detector:

- Flat on a wall
- On an angle facing to the right
- On an angle facing to the left
- In a corner

The thin plastic covering over the holes can be removed, if necessary. All the corner support holes are blocked by the mounting-tape. You can drill through the tape, if needed.

To install the motion or camera detector using screws:

1. Release the mounting-base by lifting the tab and pushing it forward.



**Figure 48: Release Mounting-Base**

2. **For wall mounting:**

- a. Remove the punch-outs 1 and 2 using a flat screwdriver.

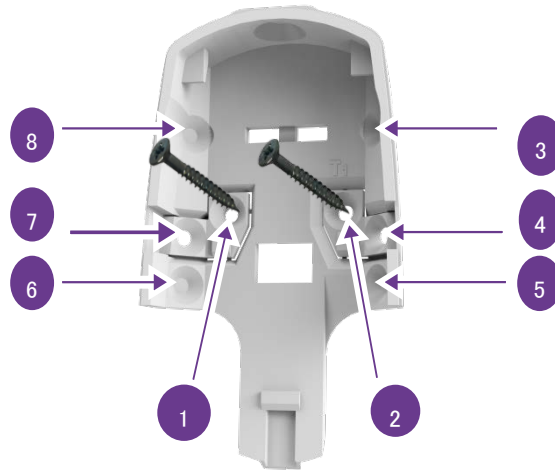

**Figure 49: Mounting-Base Screw Punch-outs**

- b. Place and hold the base on the desired mounting location and mark the drilling spots.
- c. Drill the holes.
- d. Insert the wall anchors, if needed.
- e. Place the base over the wall anchors and screw in the screws.
3. **For corner mounting**, repeat the above procedure for punch-outs 3 through 8, using six screws and six wall anchors.

## Door/Window Sensor, Flood Detector, or Universal Transmitter

For the Door/Window Sensor, you can install the transmitter using screws. The magnet is installed only using mounting tape. You can also install the flood sensor using screws.

To install the transmitter using screws:

1. Insert a coin into one of the edge slots of the transmitter and twist the coin to release the mounting base cover.



**Figure 50: Releasing the Transmitter Base**

2. Remove punch-outs 1 and 2 using a flat screwdriver.

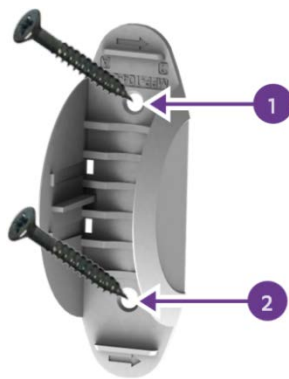

**Figure 51: Transmitter Mounting with Screws**

3. Place and hold the base on the desired mounting location.
4. Mark the drilling locations of the punch-outs 1 and 2.
5. Drill the holes.
6. Insert the wall anchors, if needed.
7. Place the base over the wall anchors.
8. Screw in the screws.
9. Attach the mounting base cover onto its base.

To install the flood sensor using screws, position the sensor in the desired location and perform steps 4 through 8 of the transmitter installation procedure.



**Figure 52: Mounting the Sensor Base with Screws**

## Siren

The mounting base has three holes for installation using screws.

To install the siren using screws:

1. Release the siren mounting base by lifting the tab and sliding the base in the tab's direction.

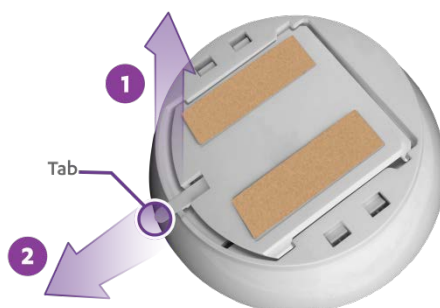

**Figure 53: Releasing the Siren Mounting Base**

2. Remove the punch-outs using a flat screwdriver.
3. Place and hold the base on the desired mounting location.



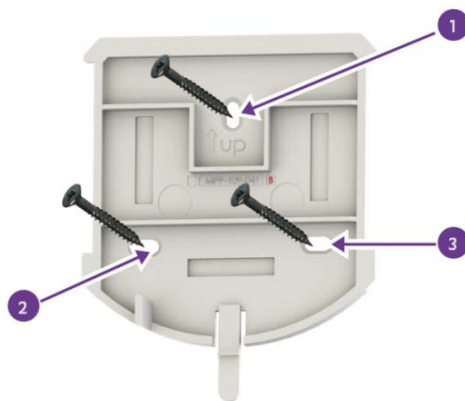

**Figure 54: Siren Mounting Base with Screws**

4. Mark the drilling locations for the punch-outs.
5. Drill the holes.
6. Insert the wall anchors if needed.
7. Place the base over the wall anchors.
8. Screw in the screws.
9. Slide the siren back into its mounting base.

## Tag Reader

The tag reader mounting base has three holes for installation using screws.

To install the tag reader using screws:

1. Release the tag reader mounting base by lifting the tab and sliding the base in the tab's direction.

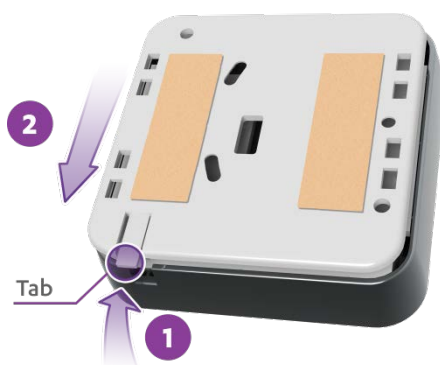

**Figure 55: Releasing the Tag Reader Mounting Base**

2. Place and hold the base on the desired mounting location.

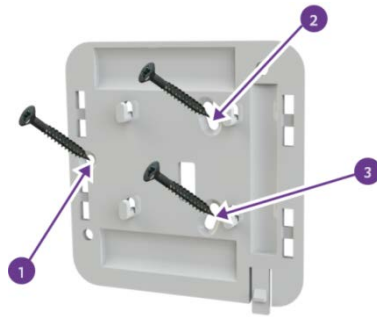

**Figure 56: Tag Reader Mounting Base with Screws**

3. Mark the drilling locations according to the specific holes.
4. Drill the holes.
5. Insert the wall anchors, if needed.
6. Place the base over the wall anchors.
7. Screw in the screws.
8. Insert the tag reader into its mounting base.

## Appendix E Installing a Pet Immune Lens

If you have a pet, use a pet immune lens to avoid your pet triggering alarms. The pet immune lens reduces false detections by suppressing detections of small moving objects such as pets.



Figure 57: The Pet Immune Lens

To install the pet immune lens in the motion or camera detectors:



**Caution:** Perform this procedure with special care since the top part of the front panel is breakable.

1. Release the device from the mounting base.

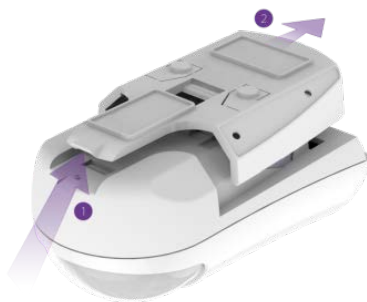

Figure 58: Releasing the Mounting Base

2. For the camera detector:
  - Unscrew the two screws above the battery compartment at the top of the back cover.



**Figure 59: Unscrew the Screws**

- Detach the back cover from the front panel. The circuit board is attached to the inner compartment of the camera detector back cover.



**Caution:** When working within the inner compartment of the camera detector, be careful not to damage the circuit board and other parts of the device.

3. Use a flat screwdriver to release the three latch tabs.

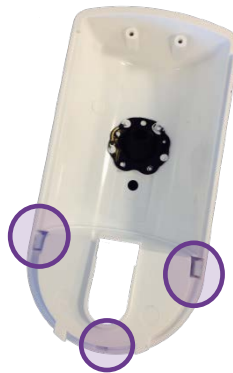

**Figure 60: Lens Latch Tabs**

The lens falls free of the panel. If the lens is not released, insert a dull, thin object through the oval opening and gently push the lens.



**Figure 61: Front Panel Oval Opening**

4. Insert the pet immune lens into the lens opening in the front panel. The pet immune lens fits inside the lens opening.



**Figure 62: Assembling the Pet Immune Lens**

5. Insert the lens in the groove surrounding the lens opening, placing the lens on top of the pet immune lens.
6. Insert the latch tabs at the bottom center and at the side of the lens into the latch tab slots on the lens opening. Figure 63 illustrates where and how to install the lens.

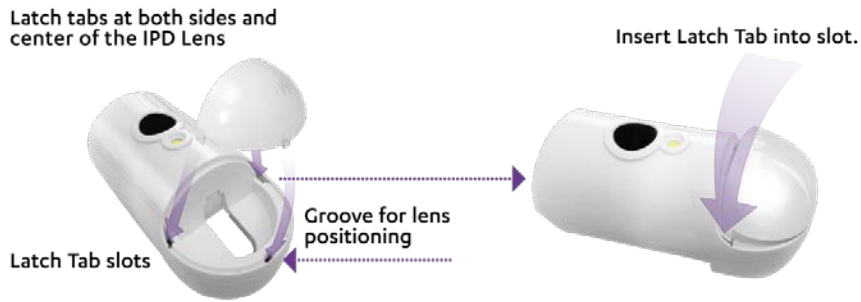

**Figure 63: Lens Tabs for Lens Insertion**

The side and center latch tabs hold both lenses in place.

7. Insert the tabs, at the bottom end of the front panel, into the inner square slots, at the bottom end of the back cover, as illustrated in Figure 64.

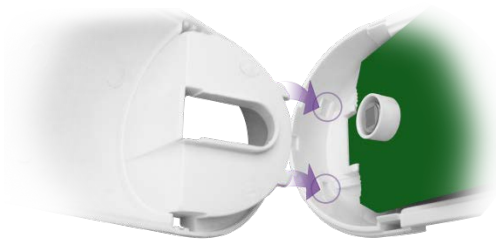

**Figure 64: Align and Insert Tabs in Square Slots**

8. For the camera detector:
  - a. Position the top of the back cover onto the top of the front cover, while aligning the holes for the screws.



**Figure 65: Align Holes for Screws**

- b. Attach the front panel to the back cover using the two screws.

9. Insert the batteries.
10. Return the device onto the mounting-base such that the lens is facing downward.



**Figure 66: Insert Device with the Lens Facing Downward**

## Appendix F Battery Information

Only batteries thoroughly tested and approved by Essence should be used to meet the device's specifications. The following battery manufacturers are approved by Essence:

- GP
- Energizer
- Duracell

To comply with the UL certification standards, use GP International Limited batteries.

The table below defines the battery specifications and quantities for WeR@Home™ devices.

**Table 16: Battery Quantities and Specifications**

Device	Quantity	Type	Voltage	Chemistry	Maximum Battery Life
Remote Control	1	CR2450	3V	Lithium	3 years
Siren	4	AA	1.5V	Alkaline	2 years
Motion Detector	2	AA	1.5V	Alkaline	3 years
Camera Detector	3	AA	1.5V	Alkaline	1 year
Door/Window Sensor	1	AA	1.5V	Alkaline	2 years
Tag Reader	3	AA	1.5V	Alkaline	1 year
Smoke Alarm	2	AA	1.5V	Alkaline	2 years
Flood Detector	1	AA	1.5V	Alkaline	2 years
Universal Transmitter	1	AA	1.5V	Alkaline	2 years



**NOTE:** The battery images included in this guide are for illustration purposes only.



## Legal Notice

*Usage of this document, and all information (including product information) provided within, are subject to the following terms and conditions, and all applicable laws. If you do not agree with these terms, please do not access or use the remainder of this document.*

*This document contains highly confidential information, which is proprietary to Essence Security International (E.S.I.) Ltd. and/or its affiliates (hereafter, "Essence"). No part of this document's contents may be used, copied, disclosed or conveyed to any third party in any manner whatsoever without prior written permission from Essence.*

*The information included in this document is intended for your knowledge and for negotiation purposes only. Essence makes no implicit representations or warranties with respect to such information.*

*The information included in this document is subject to change without notice. Any decision to rely on the information contained herein shall be at your sole responsibility, and Essence will not accept any liability for your decision to use any information or for any damages resulting therefrom.*

*Certain laws do not allow limitations on implied warranties or the exclusion or limitation of certain damages. If these laws apply to you, some or all of the above disclaimers, exclusions, or limitations may not apply to you.*

*By using the information contained herein, you agree that the laws of the State of Israel, without regard to principles of conflict of laws, will govern any dispute of any sort that might arise between you and Essence regarding the information contained herein, and any such dispute shall be settled exclusively in the competent courts of Tel Aviv-Jaffa, Israel.*

*All registered or unregistered trademarks, product names, logos and other service marks mentioned within this document are the property of Essence, or their respective owners. Nothing contained herein shall be construed as conferring by implication, estoppels, or otherwise any license or right, either express or implied, under any patent or trademark of Essence or any third party. No use of any trademark may be made without the prior written authorization of Essence.*

*This document and all of its contents are protected intellectual property of Essence. Any copying, reprinting, reuse, reproduction, adaptation, distribution or translation without the prior written permission of Essence is prohibited.*

*Please check your End User License Agreement (EULA) for terms and conditions.*

*© 2018 All rights reserved to Essence Security International (E.S.I.) Ltd.*

For more information, please contact:      Essence Security International (E.S.I.) Ltd.  
12 Abba Eban Avenue,  
Ackerstein Towers Bldg. D  
Herzliya Pituach, 4612001 Israel  
[www.essence-grp.com](http://www.essence-grp.com)  
Tel:                    +972-73-2447777  
Fax:                    +972-9-7729962