

# SP817

# MOTION DETECTOR

The SP817 Motion Detector is a Z-Wave™ enabled device which is fully compatible with any Z-Wave™ enabled network. The device can be set up in a Z-wave network to communicate directly with other end devices such as lighting controllers, or to report directly to a Z-wave controller (usually a gateway).

The Motion Detector is designed with two detecting sensors, Passive Infra-Red (PIR) sensor and light sensor, in order to fulfill the purpose of security and home automation. When the detector is cooperated with security appliances, it is acting as a security device by detecting changes in infra-red radiation levels. If a person moves within or across the device field of vision, a trigger radio signal will be transmitted to cause full alarm condition in order to frighten intruders away. Alternatively, when the detector is worked with home automation appliances, the detector can be set to perform the role of home automation device by detecting both changes in infra-red radiation levels and percentage of lux levels. Once night falls, the percentage of ambient illumination is lower than preset value. If a person moves within or across the device field of vision, a trigger radio signal will be transmitted so as to turn on the connected lightings for better illumination.

The PIR Detector adopts a CR123 3.0V Lithium battery which under normal conditions will have typical life in excess of 1 year. When the battery level drops to an unacceptable level, the detector will emit Battery report to the Z-wave controller. When this occurs the batteries should be replaced as soon as possible.

## Product Overview

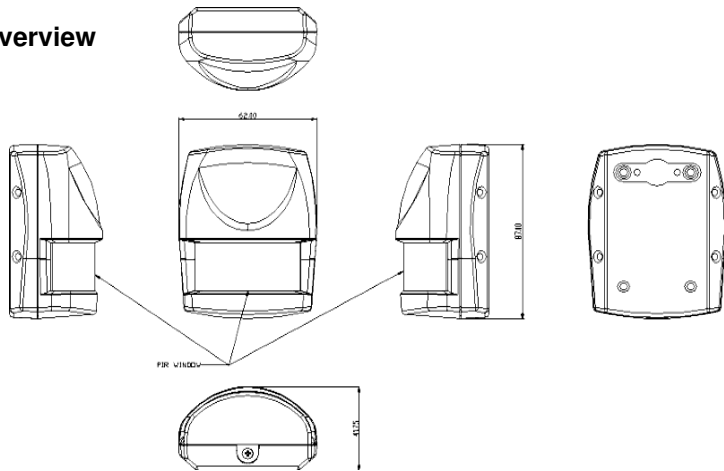

## Adding to Z-Wave™ Network

### Auto Inclusion

The detector supports Auto Inclusion feature where it will automatically enter Inclusion mode when first powered up after a factory reset.

1. Use a screwdriver to detach the rear cover.

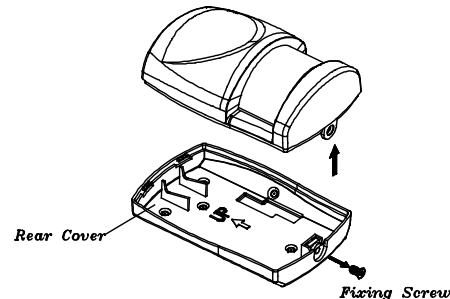

2. Put a Z-Wave Controller into inclusion mode.
3. Insert 1 CR123 3V batteries to the battery compartment with the correct polarity. The LED on the device should turn ON.

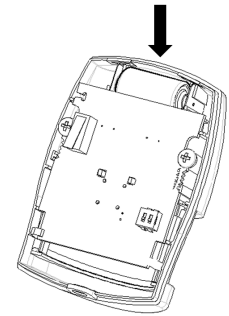

4. The Inclusion process should be completed when the LED stops blinking.
5. Do not refit the rear cover yet.

Note: If Auto Inclusion fails, refer to the Troubleshooting section regarding Manual Inclusion.

## Testing

### Warm-Up

It will take approximately 2 minutes to warm up for the detector after battery is inserted. During this period the LED behind the lens will turn on. When the red LED turns off, it implies warm-up procedure is completed and the detector is ready for detection.

- This will not affect the Inclusion/Exclusion process.
- After removing batteries, wait for 5 seconds to refit batteries.

### Quick Test

1. With the tamper switch not being pressed after inclusion, the unit will enter Test mode to allow the user to test the device before it is mounted on the wall.
2. During Test mode, if movement is detected, the LED on the detector will light up once implying the unit is working properly, and retrigger time is about 5 sec.
3. To exit the Test mode, simply press the Tamper switch for more than 10 seconds to enter Normal mode.
4. During normal mode, when PIR is triggered, the red LED will not light up and retrigger time is based on set up value.

## Mounting the Detector

### Choosing the location

The PIR Detector is suitable for mounting in dry interior locations only.

The recommended position for a PIR Detector is in the corner of a room mounted at a height between 1.8 and 2m. At this height, the detector will have a maximum range of up to 9m with a field of view of 110°, subject to the position for the PCB being set in 5. (FIGURE 1&2) The position of the PCB inside the PIR can be set to 5 different positions to adjust the range of the detector. Setting the PCB in position 3 will reduce the range to 6m approximately, with position 1 providing a range of 3m approximately. The recommended position setting for the PCB is in position 5.

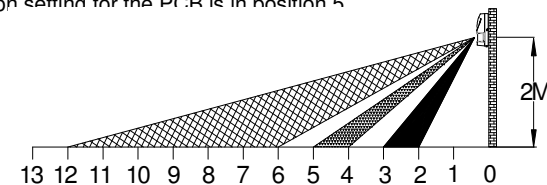
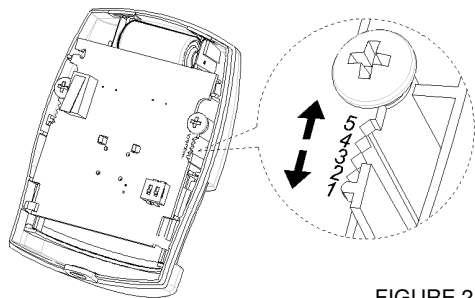

FIGURE 1



PCB Position	Range
1	3m
3	6m
5	9m

FIGURE 2

When considering and deciding upon the mounting position for the detector the following points should be considered to ensure trouble free operation:

1. Do not locate the detector facing a window or where it is exposed to or facing direct sunlight. PIR Detectors are not suitable for use in conservatories.
2. Do not locate the detector where it is exposed to ventilators.
3. Do not locate the detector directly above a heat source, (e.g. fire, radiator, boiler, etc).
4. Where possible, mount the detector in the corner of the room so that the logical path of an intruder would cut across the fan detection pattern. PIR detectors respond more effectively to movement across the device than to movement directly towards it. (FIGURE 3)

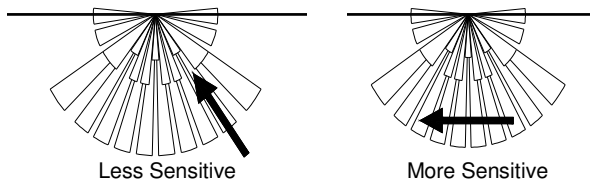

FIGURE 3

5. Do not locate the detector in a position where it is subject to excessive vibration.
6. Ensure that the position selected for the PIR detector is within effective range of the system, (refer to System Installation and Operating Manual).

**Note:** When the system is armed, household pets should not be allowed into an area protected by a PIR detector as their movement would trigger the PIR and generate an alarm.

## Installation

1. Carefully drill out the required mounting holes in the rear cover using 3mm drill according to whether the unit is being mounted in a corner or against a flat wall.

**Note:** Using 1<sup>st</sup> mounting hole to fulfill corner mounting installation, while 2<sup>nd</sup> mounting hole for flat wall installation. (FIGURE 4a & 4b)

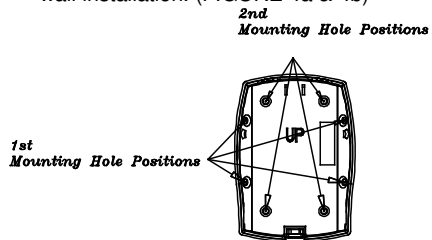

FIGURE 4a

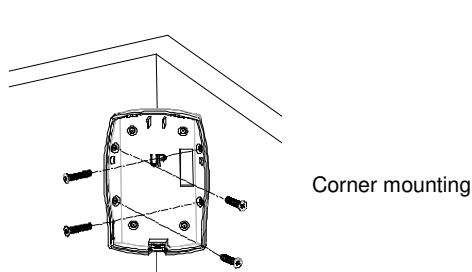

FIGURE 4b

3. Using the rear cover as a template, mark the positions of the fixing holes on the wall.
4. Fix the rear cover to the wall using the two 18mm No.4 screws and 25mm wall plugs, (a 5mm hole will be required for the wall plugs). Do not over-tighten the fixing screws as this may distort or damage the cover.
5. Configure the detector as described below. Remember that on initial installation that the device needs to be tested.
6. Check that the detector PCB is located and set in the correct position to provide the required detection range. To adjust the PCB position, simply slide it up or down ensuring that the location legs are aligned with the required position number marked on the board.
7. To refit the detector to the rear cover and locate the clips in the top edge into the rear cover. Push the lower edge of the detector into place and refit the fixing screw in the bottom edge of the detector to secure in position. Do not over-tighten the fixing screws as this may damage the casing.
8. By walking into a protected area within coverage of 110 degrees, the detector will now be triggered each time the detector senses movement. The associated appliances will be activated. For example, siren will be sounded or indication of movement detection will be shown on the controller. It implies that the unit is working properly.

## Programming

### Z-Wave Group

The detector supports either one of two Z-wave Association Groups:

**Group 1:** Association with 1 Controller node.

**Group 2:** Association with 4 nodes (i.e. end devices such as smart plugs and other lighting controllers). This allows the detector to transfer commands directly to end devices without the participation of the controller. This has the effect that when the detector triggers, all devices associated with detector will be operated.

Group 1 commands:

- When the unit is powered up and was already a part of a Z-Wave network, the unit will send a Notification Report to the node in Group 1.
- When the detector senses a movement, the unit will send a Notification Report to the nodes of Group 1. Once the movement is stopped, a Notification Report will be sent again to Group 1.
- Upon detector status being changed, the unit will check its battery status simultaneously. When the battery level of the unit drops to an unacceptable level, the unit will emit Battery report to the nodes of Group 1.
- When performing Factory Reset the unit will send Device Reset Locally Notification to the node of Group1.

Group 2 commands:

- When the detector is triggered, the unit will send BASIC\_SET command which contains a value to the nodes of Group 2.

### Z-Wave Plus Info

Role Type	Node Type	Installer Icon	User Icon
Slave Sleeping report	Z-Wave Plus node	Sensor Notification Device Type (Home Security)	Sensor Notification Device Type (Home Security)

### Version

Protocol Library	3 (Slave_Enhance_232_Library)
Protocol Version	4.3D ( 6.71.01)

### Manufacturer

Manufacturer ID	Product Type	Product ID
0x0060	0x0001	0x0006

## AGI (Association Group Information) Table

Group	Profile	Command Class & Command (List) N bytes	Group Name(UTF-8)
1	General	Battery Report Notification Report Device Reset Locally Notification	Lifeline
2	Control	Basic Set	PIR Control

## Notification

Event	Type	Event	Event Parameters Length	Event Parameters
The power is applied for the first time	0x08	0x01	0x00	
PIR Trigger ON	0x07	0x08	0x00	
PIR Trigger OFF	0x07	0x00	0x01	0x08
Tamper switch being press more than 10 seconds	0x07	0x00	0x01	0x03
Tamper switch being press more than 10 seconds and released	0x07	0x03	0x01	

## Battery

Battery Report (value)	Description
20~100	Battery Level (%)
0xFF	Low Battery

## Command Classes

The module supports Command Classes including...

- COMMAND\_CLASS\_ZWAVEPLUS\_INFO\_V2
- COMMAND\_CLASS\_ASSOCIATION\_V2\*
- COMMAND\_CLASS\_ASSOCIATION\_GRP\_INFO\*
- COMMAND\_CLASS\_TRANSPORT\_SERVICE\_V2
- COMMAND\_CLASS\_VERSION\_V2\*
- COMMAND\_CLASS\_MANUFACTURER\_SPECIFIC\_V2\*
- COMMAND\_CLASS\_DEVICE\_RESET\_LOCALLY\*
- COMMAND\_CLASS\_POWERLEVEL\*
- COMMAND\_CLASS\_SECURITY
- COMMAND\_CLASS\_SECURITY\_2
- COMMAND\_CLASS\_SUPERVISION\*
- COMMAND\_CLASS\_FIRMWARE\_UPDATE\_MD\_V4\*
- COMMAND\_CLASS\_BATTERY\*
- COMMAND\_CLASS\_WAKE\_UP\_V2\*
- COMMAND\_CLASS\_NOTIFICATION\_V4\*
- COMMAND\_CLASS\_CONFIGURATION\*

\*Items marked an asterisk are secure command classes.

### WakeUp Command Class

After it has been included into a Z-wave network, the detector will go to sleep but will send a Wakeup Notification Command periodically at preset period to the controller. The Motion detector will stay awake for 10 seconds at least and then go back to sleep to conserve battery life.

The time interval between Wakeup Notification Commands can be set in the Wakeup Command Class based on the range values below:

Minimum Wake Up Interval	600s (10 minutes)
Maximum Wake Up Interval	86400s (1 day)
Default Wake Up Interval	14400s (4 hours)
Wake Up Interval Step Seconds	600s (10 minutes)

## Z-Wave's Configuration

The following information is for someone that has some experience in setting up a Z-Wave system or someone that has computer software running a Z-Wave controller. Please get familiar with software of Z-Wave controller before getting started.

To save power consumption for the battery, RF power of SP817 is in off mode ordinarily. Pls press Tamper switch once to on the RF power for 30 sec. in order to start function set up, and the user can see the LED start lighting up shortly every sec.. If set up is not finished within 30 sec., please press Tamper switch one more time to continue the set up.

### 1-1 Basic Set Level

When Basic Set Command is sent where contains a value, the receiver will take it for consideration; for instance, if a lamp module is received the Basic Set command of which value is decisive as to how bright of dim level of lamp module shall be.

Example:

1-99: ON (Binary Switch Device)  
Dim Level (Multilevel Switch Device)

Function	Parameter Number	Size	Range	Default
Basic Set level	1	1	1~99	99

### 1. Sensitivity Level (PIR sensor only)

In order to provide a best efficiency of the detector, it is recommended to test the detector with movements from a farthest end of the coverage area at first time of use. If movements cannot be detected sensitively, simply adjust the sensitivity level with Configuration Parameter #3. This parameter can be configured with the value of 1 through 10, where 1 means low sensitivity and 10 means highest sensitivity.

Function	Parameter Number	Size	Range	Default
Sensitivity Level	3	1	1~10	6

### 2. Re-trigger Interval Setting (PIR sensor only)

The Configuration parameter that can be used to adjust the interval of being re-triggered after the detector has been triggered as Configuration Parameter #4. No response will be made during this interval if a movement is presented. The time interval can be set between 5 secs to 3600 secs.

Function	Parameter Number	Size	Range	Default
Re-trigger Interval	4	2	5~3600(sec)	180

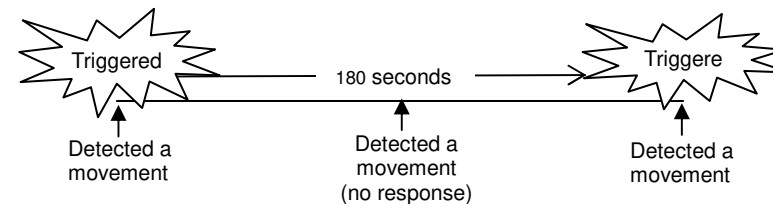

### 3. Lux Level

The user can set a detecting percentage of lux level which determines when the light sensor will be activated. If percentage of lux level of ambient illumination falls below this percentage, and a person moves across or within the protected area, the detector will emit Z-Wave ON Command (i.e. Basic Set Command (Value = Basic Set Level)) to controller and activate connected modules and lighting. Percentage can be set between 1% to 100%.

Function	Parameter Number	Size	Range	Default
Lux Level	5	1	1~100 %	20

### 4. On-Off Duration

The function of on-off duration setting will be useful if the detector is connected with a module or lighting. The duration determines how long the module/lighting should stay ON. For instance,

Lamp Module turns off 100 secs after it has been turned on. This parameter can be configured with the value of 5 through 3600, where 5 means 5 second delay and 3600 means 3600 seconds of delay.

Function	Parameter Number	Size	Range	Default
On-Off Duration	6	2	5~3600(sec)	15

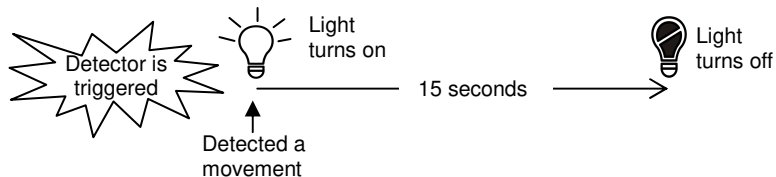

## Troubleshooting

The table below lists the several steps involved when adding or removing the detector from the Z-wave network.

Action/Status	Description	LED indication
No node ID	The Z-Wave Controller does not allocate a node ID to the unit.	2-second on, 2-second off For 2 minutes
Auto Inclusion	The power is applied for the first time and no node ID has been stored in the module, or after executing reset.	
Manual Inclusion	1. Put the Z-Wave Controller into inclusion mode. 2. Press the tamper switch 3 times within 1.5 seconds to put the unit into inclusion mode.	
Exclusion	1. Put the Z-Wave Controller into exclusion mode. 2. Press the tamper switch 3 times within 1.5 seconds to put the unit into exclusion mode.	
Factory Reset (This procedure should only be used when the controller is inoperable.)	1. Press the tamper switch 3 times within 1.5 seconds to put the unit into exclusion mode. 2. Within 1 second of step 1, press the tamper switch again and hold until LED is off (about 5 seconds). 3. Node ID is excluded. The device reverts to factory default state and will be in auto-inclusion mode for 4 minutes.	2-second on, 2-second off For 2 minutes
* Failed or successful results in including/excluding the ID can be viewed on the Z-Wave Controller.		

Table below lists typical problems encountered:

Symptom	Possible Cause	Recommendation
Cannot carry out inclusion and association	1. Run out of battery power 2. Check if reverse battery polarity 3. Check if the detector is out of order	1. Replace a new battery 2. Refit the battery with correct polarity 3. Ensure the detector is working properly
Cannot control the connected modules	1. Run out of battery power 2. Check if the detector is out of order	1. Replace a new battery 2. Ensure the detector is working properly
The detector not working	1. Run out of battery power 2. Check if the mounting location is proper 3. Check if the detector is mounted above a radiator or heater 4. Check if the detector is out of order	1. Replace a new battery 2. Reposition its mounting location 3. Remove the source of interference or reposition its mounting location 4. Ensure the detector is working properly

## Specifications

Battery	CR123 3.0V 1700mAh Lithium Battery
Battery Life	1 year*
Range	Up to 100 meters line of sight
Warm Up Time	About 2 minutes
PIR Detection Coverage	Up to 10m x 110° (at 1.8m mounting height & 25°C)
Operating Frequency	EU: 868.42MHz US: 908.42 MHz JP: 922.5MHz
FCC ID	FU5SP817
IC	23210-SP817

*Specifications are subject to change without notice  
\*measured at 10 triggers per day*



## Federal Communication Commission Interference Statement

This device complies with Part 15 of the FCC Rules. Operation is subject to the following two conditions: (1) This device may not cause harmful interference, and (2) this device must accept any interference received, including interference that may cause undesired operation.

This equipment has been tested and found to comply with the limits for a Class B digital device, pursuant to Part 15 of the FCC Rules. These limits are designed to provide reasonable protection against harmful interference in a residential installation. This equipment generates, uses and can radiate radio frequency energy and, if not installed and used in accordance with the instructions, may cause harmful interference to radio communications. However, there is no guarantee that interference will not occur in a particular installation. If this equipment does cause harmful interference to radio or television reception, which can be determined by turning the equipment off and on, the user is encouraged to try to correct the interference by one of the following measures:

- Reorient or relocate the receiving antenna.
- Increase the separation between the equipment and receiver.
- Connect the equipment into an outlet on a circuit different from that to which the receiver is connected.
- Consult the dealer or an experienced radio/TV technician for help.

FCC Caution: Any changes or modifications not expressly approved by the party responsible for compliance could void the user's authority to operate this equipment.

This transmitter must not be co-located or operating in conjunction with any other antenna or transmitter.

## Radiation Exposure Statement:

This equipment complies with FCC radiation exposure limits set forth for an uncontrolled environment. This equipment should be installed and operated with minimum distance 20cm between the radiator & your body.

## Industry Canada statement:

This device complies with ISED's licence-exempt RSSs. Operation is subject to the following two conditions: (1) This device may not cause harmful interference, and (2) this device must accept any interference received, including interference that may cause undesired operation.

Le présent appareil est conforme aux CNR d' ISED applicables aux appareils radio exempts de licence. L'exploitation est autorisée aux deux conditions suivantes : (1) le dispositif ne doit pas produire de brouillage préjudiciable, et (2) ce dispositif doit accepter tout brouillage reçu, y compris un brouillage susceptible de provoquer un fonctionnement indésirable.

**Radiation Exposure Statement:**

This equipment complies with ISED radiation exposure limits set forth for an uncontrolled environment. This equipment should be installed and operated with minimum distance 20cm between the radiator & your body.

**Déclaration d'exposition aux radiations:**

Cet équipement est conforme aux limites d'exposition aux rayonnements ISED établies pour un environnement non contrôlé. Cet équipement doit être installé et utilisé avec un minimum de 20 cm de distance entre la source de rayonnement et votre corps.

**WARNING:**

Do not dispose of electrical appliances as unsorted municipal waste, use separate collection facilities.

Contact your local government for information regarding the collection systems available.

If electrical appliances are disposed of in landfills or dumps, hazardous substances can leak into the groundwater and get into the food chain, damaging your health and well-being.

When replacing old appliances with new ones, the retailer is legally obligated to take back your old appliance for disposal at least for free of charge.



EVERSPRING®  
www.everspring.com

50 Sect. 1 Zhonghua Rd Tucheng  
New Taipei City 236 Taiwan

A501112657R