

r-Series

Digital Microwave Radios

Installation and Management Manual



Includes Models:
EX-4.9r, EX-4.9r-c, EX-4.9r-x, EX-4.9r-xc
EX-5r, EX-5r-c, EX-5r-x, EX-5r-xc

Part Number: 50000007 (ETSI)

Date: 2007-02-12

Legal Notice

The information contained herein is the property of Exalt Communications, Inc. (“Exalt”) and is supplied without liability for errors or omissions. No part of this document may be reproduced, in any form, except as authorized by contract or other written permission from the owner.

Any brand names and product names included in this manual are trademarks, registered trademarks, or trade names of their respective holders.

The contents of this document are current as of the date of publication. Exalt reserves the right to change the contents without prior notice.

The publication of information in this document does not imply freedom from patent or other rights of Exalt or others.

© 2007 Exalt Communications Inc. All rights reserved.

The Exalt logo is a trademark of Exalt Communications, Inc.

Open-Source License Information

In addition to proprietary software/firmware, which is the sole intellectual property of Exalt, the EX-5r Digital Microwave Radios make use of public (open-source) software/firmware within the terms of use of their respective shared license agreements. Exalt will supply copies of any of this code, within the terms of their individual licensing agreements, upon request.

Open-Source Code	License Agreement	Website
Linux Operating System	GNU GPL Version 2	www.gnu.org
BusyBox CLI	GNU GPL Version 2	www.gnu.org ; www.busybox.net
GoAhead Web Server	Copyright (c) 2003 GoAhead Software, Inc. All Rights Reserved.	www.goahead.com
U-boot Boot Code	GNU GPL Version 2	www.gnu.org www.sourceforge.net
Net-SNMP	(see Copyright Notices on page 89)	www.sourceforge.net

About this Document

This manual provides a complete description of the EX-5r family of Digital Microwave Radios and related software. This manual provides planners, engineers, installers, system administrators, and technicians general and specific information related to the planning, installation, operation, management, and maintenance of these devices.

Revision History

Date	Detail
2006-09-18	EX-5r release 1.0.0
2006-12-20	Draft for ETSI/CE
2007-02-12	Draft for 4.9r series

Icons

The following icons denote specific types of information.



(Warning) Denotes information pertaining to potential danger to human life.



(Caution) Denotes information pertaining to potential danger to property.



(Note) Denotes useful or unique information.

General Compliance and Safety

The usage of radio transmission devices is subject to specific regulatory requirements governed by regional legislation. In most cases, the specific device must be authorized for use in a given country and must be installed and adjusted in accordance with specific radio-frequency settings and in a manner that has been authorized specific to the device itself in accordance with the specific location of the device. Some users may be completely or partially restricted from use of the device. Please consult local governmental agency/agencies for regulatory requirements before use, or contact Exalt or your Exalt authorized dealer for assistance.

Do not modify this device in any way without the express written consent of Exalt. Modification voids the manufacturer warranty, and may also be illegal in accordance to government regulations. In addition, there are no user-serviceable parts or assemblies inside the product housing. There may also be voltages, signals, and mechanisms within the device that could be harmful to human safety.

The mounting of this device and associated peripherals and connections (inclusive of antenna mast, antenna, cabling, egress, lightning protection devices, grounding, power, and so on) may be subject to regional requirements for health and human safety. A qualified professional installer and an electrician are highly recommended, and may be required by law.

Exalt cannot warranty the device or be found liable for any unauthorized use or installation of the device.

Regulatory Notices

Federal Communications Commission (FCC), United States

The device is allowed to be used provided it does not cause interference to other devices. It is not guaranteed to provide protection against interference from other electronic and radio devices.

The system has been tested and found to comply with the limits of a class B digital device, pursuant to Part 15 of the FCC Rules. These limits are designed to provide reasonable protection against harmful interference in a residential installation. This equipment generates uses and can radiate radio frequency energy and, if not installed and used in accordance with the instructions, may cause harmful interference to radio communications. However, there is no guarantee that interference will not occur in a particular installation. If this equipment does cause harmful interference to radio or television reception, which can be determined by turning the equipment off and on, the user is encouraged to try to correct the interference by one of more of the following measures:

- Reorient or relocate the receiving antenna.
- Increase the separation between the equipment and receiver.
- Connect the equipment into an outlet on a circuit different from that to which the receiver is connected.
- Consult the dealer or an experienced radio/TV technician for help.

Shielded cables and I/O cords must be used for this equipment to comply with the relevant FCC regulations.

Changes or modifications not expressly approved in writing by Exalt may void the user's authority to operate this equipment.

This device must be professionally installed.

To comply with regulations, the output power of this device may need to be adjusted in accordance to the associated transmission system. See RF Output Power Setting on page 10 for details.

The antenna associated with this device shall be mounted in a location that is at least 10'/3m away from humans that may be subject to long-term or continuous exposure.

Industry Canada (IC), Canada

This Class B Digital apparatus meets all the requirements of the Canadian Interference-Causing Equipment Regulations.

Cet appareil numérique de la classe B respecte les exigences du Règlement sur le matériel brouilleur du Canada.

This device complies with RSS-210 of Industry Canada. Operation is subject to the following two conditions:

1. this device may not cause interference, and
2. this device must accept any interference, including interference that may cause undesired operation of the device.

Antennas Supported in Canada

The device is designed to operate with the antennas listed in Table 1, which have a maximum gain of 37.5dBi. Antennas not included in the list or having a gain greater than 37.5dBi are strictly prohibited for use with this device. The required antenna impedance is 50 Ohms.

Table 1 Supported antennas—Canada

Manufacturer	Model #	Description	Gain dBi (mid-band)
Andrew	P2F-52-N	2-foot Dish	29.4
Andrew	PX2F-52-N	2-foot Xpol Dish	29.4
Andrew	P3F-52-N	3-foot Dish	33.4
Andrew	PX3F-52-N	3-foot Xpol Dish	33.4
Andrew	P4F-52-N	4-foot Dish	34.9
Andrew	PX4F-52-N	4-foot Xpol Dish	34.9
Andrew	HP2F-52-NPA	2-foot HP Dish	29.0
Andrew	HPX2F-52-NPA	2-foot Xpol HP Dish	29.0
Andrew	HP3F-52-NPA	3-foot HP Dish	33.0
Andrew	HPX3F-52-NPA	3-foot Xpol HP Dish	33.0
Andrew	HP4F-52-NPA	4-foot HP Dish	34.5

Exalt Communications Inc.

r-series Installation and Management Manual

Andrew	HPX4F-52-NPA	4-foot Xpol HP Dish	34.5
Andrew	HP6F-52-NPA	6-foot HP Dish	37.2
Andrew	HPX6F-52-NPA	6-foot Xpol HP Dish	37.2
Andrew	FPA5250D06-N	6-inch Panel	18.0
Andrew	FPA5250D12-N	1-foot Panel	23.6
Exalt	(Integral)	1-foot Xpol Panel	20.0
Gabriel	DFPS.5-52	6-inch Panel	18.0
Gabriel	DFPD1-52	1-foot Panel	23.5
Gabriel	DFPD2-52	2-foot Panel	28.0
Gabriel	QF2-52-N	2-foot Dish	28.5
Gabriel	QF2.5-52-N	2.5-foot Dish	31.2
Gabriel	QF4-52-N	4-foot Dish	34.8
Gabriel	QFD2-52	2-foot Xpol Dish	28.4
Gabriel	QFD2.5-52	2.5-foot Xpol Dish	31.1
Gabriel	QFD4-52	4-foot Xpol Dish	34.7
Gabriel	HQF2-52-N	2-foot HP Dish	28.2
Gabriel	HQF4-52-N	4-foot HP Dish	34.4
Gabriel	HQF6-52-N	6-foot HP Dish	37.4
Gabriel	HQFD2-52	2-foot Xpol HP Dish	28.1
Gabriel	HQFD2.5-52	2.5-foot Xpol HP Dish	30.7
Gabriel	HQFD4-52	4-foot Xpol HP Dish	34.3
Gabriel	HQFD6-52	6-foot Xpol HP Dish	37.3
MTI	MT-485001	7.5-inch Panel	19.0
MTI	MT-485002	1-foot Panel	23.0
MTI	MT-486004	18-inch Panel	26.0
MTI	MT-486001	2-foot Panel	28.0
MTI	MT-485005	7.5-inch Xpol Panel	18.0
MTI	MT-485025	15-inch Xpol Panel	23.0
Proxim	5054-WA-15-STN	Window Panel	15.0
Radio Waves	FP.5-5-18	6-inch Panel	18.0
Radio Waves	FP1-5-24	1-foot Panel	23.8
Radio Waves	FP2-5-28	2-foot Panel	28.0
Radio Waves	FPD.5-5-18	6-inch Xpol Panel	18.0
Radio Waves	SP1-5.2	1-foot Dish	22.5
Radio Waves	SP2-5.2	2-foot Dish	29.0
Radio Waves	HP2-5.2	2-foot HP Dish	28.6
Radio Waves	SP3-5.2	3-foot Dish	32.0
Radio Waves	SP4-5.2	4-foot Dish	34.8
Radio Waves	SPD2-5.2	2-foot Xpol Dish	28.1
Radio Waves	SPD3-5.2	3-foot Xpol Dish	31.1
Radio Waves	SPD4-5.2	4-foot Xpol Dish	34.4
Radio Waves	SPD6-5.2	6-foot Xpol Dish	37.5
RFS	SPF2-52A	2-foot Dish	27.9
RFS	SPF3-52A	3-foot Dish	31.4
RFS	SPF4-52A	4-foot Dish	33.9
RFS	SPF6-52A	6-foot Dish	37.4
RFS	SDF4-52A	4-foot HP Dish	33.9

RFS	SDF6-52A	6-foot HP Dish	37.4
RFS	MA0528-19AN	7.5-inch Panel	19.0
RFS	MA0528-23AN	1-foot Panel	23.0
RFS	MA0528-28AN	2-foot Panel	28.0

The antenna associated with this device shall be mounted in a location that is at least 10'3m away from humans that may be subject to long-term or continuous exposure.

Europe/ITU (ETSI and CE Mark)

The EX-5r family complies with ETS 301 893 for the 5.3 and 5.47 GHz bands for license-exempt use for most countries recognizing ETSI or ITU band assignments. These bands require Dynamic Frequency Selection (DFS) and Transmitter Power Control (TPC) for radar-detection and avoidance. There is a +30dBm EIRP limit applied to this band. Transmitter power must be adjusted accordingly with respect to the RF cabling losses and antenna gains associated with each terminal.

The EX-5r family complies with ETS 302 502 for the 5.8GHz band. This band is **not** yet harmonized for all countries recognizing ETSI or ITU band assignments. Consult the individual country regulations or your Exalt Communications representative for details. This band requires DFS and TPC for radar-detection and avoidance. There is a +33dBm EIRP limit for use of the 10MHz BW setting (called 8MHz on GUI), and a +36dBm EIRP limit for use of the 20MHz BW setting (called 16MHz on GUI).

All models comply with the requirements for CE Mark (EN 60950) and EMC (EN 301-489-17) when used with the AC adapter included with each model. No substitutions shall be made, and all wiring and grounding instructions contained in this manual must be followed to ensure safety in accordance to the standards.

Regulatory Notices (4.9GHz Model)

The EX-4.9r is a licensed-band product operating within Part 90 of the FCC regulations and RSS-111 of Industry Canada. These bands are specifically reserved for Public Safety applications and related agencies, in accordance with these regulations.

Professional installation is required, and transmitter power reduction may be required, depending on transmission system gains and losses, in accordance with instructions found in RF Output Power Setting on page 10.

The transmitter power of the device must be reduced by 1dB for every 1dB that the antenna gain exceeds 26dBi (inclusive of transmission system losses).

Safety Notices

1. Review this entire guide for important installation instructions **BEFORE** attempting to install this product.
2. This product is intended to be installed, used, and maintained by experienced telecommunications personnel only.
3. Employ a properly licensed or authorized electrician to install or evaluate/certify the installation of all power and grounding related to the use of this equipment and all connected devices.
4. The device(s) shall only be connected to AC power sources provided by the supplier or to DC sources within the device specifications (FCC/IC only). Use a separate breaker circuit at the power source.
5. Lightning, surge protection devices, and earth grounding are required for most installations to ensure human safety. Consult a qualified electrician.
6. Servicing of this device should be performed by authorized personnel only. Do not disassemble this device. By opening or removing any covers you may expose yourself to hazardous energy parts. Incorrect reassembly of this product can cause a malfunction, and/or electrical shock, when the unit is subsequently used.
7. Do not connect or disconnect the power connection to the device when the power supply is plugged into an AC outlet. To connect, first connect the power connection to the device, and then apply power (or plug in) at the outlet. To disconnect, disengage power at the outlet or unplug, and then disconnect the direct connection to the device.
8. Do not insert any object of any shape or size inside this product at any time, whether powered or not. Objects may contact hazardous energy components that could result in a risk of fire or personal injury.
9. Liquids shall not come in contact with, or enter the inside of the device at any time.
10. Proper ventilation and/or airflow shall be provided surrounding the equipment. Items shall not come in contact with heat-sinking materials. Ensure that ambient operational and storage temperature specifications are maintained at all times.
11. Equipment is suitable for mounting on noncombustible surfaces only.
12. Do not move or alter the marking labels.

Exalt Limited Hardware Warranty

Exalt Communications, Inc. (“Exalt”) warrants solely to the original purchaser (“Purchaser”) that the EX-5r series or the EX-4.9r Series (the “Product”) will substantially conform in all material respects to the relevant Exalt published specifications that apply at the time of manufacture of such Product for two (2) years from the date of tender of Product by Exalt from FOB point designated by Exalt (the “Warranty Period”). Proof-of-purchase in the form of an invoice, payment of invoice, or delivery waybill must be supplied, if requested by Exalt, in case of any dispute of warranty start date. Exalt shall within the Warranty Period, at its own option: (A) use reasonable efforts to remedy any reproducible Product defect covered by this limited warranty within a reasonable period of time; (B) replace the defective Product with a functionally equivalent product (repair parts and products may be either reconditioned or new, but, if reconditioned, shall be of the same quality as new parts or products); or (C) if Exalt determines that it is unable to repair or replace such Product, Exalt will refund to Purchaser the amount actually paid by Purchaser for the applicable Product. All replaced parts become the property of Exalt. Exalt may, at its sole option, refuse to accept as defective Product that (i) is subject to the exclusions set forth below; or (ii) cannot be demonstrated to be defective by Exalt and Purchaser is unable to provide adequate information describing how the Product failed. Such Product will, at Purchaser’s option and expense, either be: (a) returned to Purchaser in the state received, or (b) repaired and returned to Purchaser. Repaired or replaced Product will be warranted for the remainder of the original Warranty Period, but not less than ninety (90) days.

Registration

Purchaser is required to register its Product, within ninety (90) days of purchase, for full warranty support. Unregistered or late-registered Product will receive a Warranty Period of only one (1) year.

Exclusions

This limited warranty will not apply to: (A) any Product that: (i) has been modified or altered by any party other than Exalt; (ii) has been subject to accident, misuse, abnormal wear and tear, neglect, or mistreatment; (iii) has been damaged during installation of the Product; (iv) has been damaged by the equipment or system with which the Product is used; (v) has sustained damage to the Products’ interface or power connectors; (vi) are determined to be stolen; or (vii) has been damaged caused by fire, power changes, other hazards, or acts of God (including without limitation lightning); or (B) any software included in any such Product. The warranty applies only to Products that can be identified by the Exalt trademark, trade name, serial number or logo affixed to them. Exalt does not warrant any Product that is not manufactured by, for, or with permission from Exalt. The Products covered by this warranty are not consumer products and are not intended for personal, family, or household purposes.

RMA Procedures

A return material authorization (RMA) is required prior to returning Product to Exalt for warranty or out-of-warranty repair/evaluation. As such, Purchaser must use the following procedure:

1. Contact Exalt (see Introduction on page 1 for current contact data) and request an RMA number. Please be prepared to provide the serial number of the Product, the date of purchase, and a description of the failure that is as complete as possible.
2. Pack the Product in its original container and packing or an equivalent.
3. Write the RMA number CLEARLY on the outside of the shipping box.
4. For services during the Warranty Period, cost of shipment to Exalt's authorized service center, taxes, duty, tariffs, risk of loss and insurance charges to Exalt shall be borne by the Purchaser. Cost of return shipment and insurance charges shall be borne by Exalt and will be made by Exalt's choice of carrier and method/schedule of shipment. Purchaser may expedite return shipments, upon request, at its own expense.

PRODUCTS RETURNED WITHOUT A DULY ISSUED RMA NUMBER WILL BE RETURNED TO PURCHASER AT PURCHASER'S EXPENSE.

THIS EXPRESS WARRANTY IS IN LIEU OF ALL OTHER WARRANTIES, EXPRESSED, IMPLIED OR STATUTORY, REGARDING THE PRODUCT, AND EXALT, ITS SUPPLIERS AND LICENSORS HEREBY EXPRESSLY DISCLAIM ALL SUCH IMPLIED AND EXPRESS WARRANTIES, INCLUDING WITHOUT LIMITATION ANY AND ALL IMPLIED WARRANTIES OF FITNESS FOR A PARTICULAR PURPOSE, TITLE, INTERFERENCE WITH QUIET ENJOYMENT, NON-INFRINGEMENT OF THIRD-PARTY RIGHTS AND MERCHANTABILITY. FURTHER, EXALT DOES NOT WARRANT RESULTS OF USE OR THAT PURCHASER'S USE OF THE PRODUCT WILL BE UNINTERRUPTED OR ERROR FREE. NO WARRANTIES ARE MADE BY EXALT'S SUPPLIERS OR LICENSORS. EXCEPT FOR THE EXPRESS WARRANTY STATED HEREIN, THE PRODUCT IS PROVIDED "AS IS" AND WITH ALL FAULTS. THE ENTIRE RISK AS TO SATISFACTORY QUALITY, ACCURACY, AND EFFORT IS WITH PURCHASER.

REGARDLESS OF WHETHER ANY REMEDY SET FORTH HEREIN FAILS OF ITS ESSENTIAL PURPOSE OR OTHERWISE, AND EXCEPT FOR BODILY INJURY, IN NO EVENT WILL EXALT, ITS SUPPLIERS OR LICENSORS BE LIABLE TO PURCHASER OR TO ANY THIRD PARTY UNDER ANY TORT, CONTRACT, NEGLIGENCE, STRICT LIABILITY OR OTHER LEGAL OR EQUITABLE THEORY FOR ANY LOST PROFITS, LOST OR CORRUPTED DATA, COMPUTER FAILURE OR MALFUNCTION, INTERRUPTION OF BUSINESS, OR OTHER SPECIAL, INDIRECT, INCIDENTAL OR CONSEQUENTIAL DAMAGES OF ANY KIND ARISING OUT OF THE USE OR INABILITY TO USE THE PRODUCT, EVEN IF EXALT HAS BEEN ADVISED OF THE POSSIBILITY OF SUCH LOSS OR DAMAGES AND WHETHER OR NOT SUCH LOSS OR DAMAGES ARE FORESEEABLE.

IN NO EVENT SHALL EXALT'S AND ITS SUPPLIERS' AGGREGATE LIABILITY EXCEED AN AMOUNT EQUAL TO THE PURCHASE PRICE OF THE PRODUCT PAID BY PURCHASER THAT IS THE SUBJECT OF A CLAIM. ANY CLAIM ARISING OUT OF OR RELATING TO THIS AGREEMENT MUST BE BROUGHT WITHIN ONE (1) YEAR AFTER THE OCCURRENCE OF THE EVENT GIVING RISE TO SUCH CLAIM. IN ADDITION, EXALT DISCLAIMS ALL LIABILITY OF ANY KIND OF EXALT'S SUPPLIERS.

Table of Contents

Legal Notice.....	ii
Open-Source License Information.....	ii
About this Document.....	iii
Revision History.....	iii
Icons.....	iii
General Compliance and Safety.....	iv
Regulatory Notices.....	iv
Federal Communications Commission (FCC), United States.....	iv
Industry Canada (IC), Canada.....	v
Antennas Supported in Canada.....	v
Europe/ITU (ETSI and CE Mark).....	vii
Regulatory Notices (4.9GHz Model).....	vii
Safety Notices.....	viii
Exalt Limited Hardware Warranty.....	ix
Registration.....	ix
Exclusions.....	ix
RMA Procedures.....	x
List of Figures.....	xvi
List of Tables.....	xvii
Introduction.....	1
Related Documentation and Software.....	1
The Exalt r-Series Digital Microwave Radios.....	1
Basic Features.....	3
Pre-installation Tasks.....	6
Link Engineering and Site Planning.....	6
Familiarization with the r-Series.....	7
ETSI Compliance – EIRP limits.....	7
Shipping Box Contents.....	8
Back-to-Back Bench Test and Configuration.....	9
RF Output Power Setting.....	10

United States Compliance.....	10
EX-4.9r FCC (USA) EIRP.....	11
FCC (USA) EIRP.....	11
Canada Compliance	12
IC (Canada) EIRP	12
EX-4.9r Series IC (Canada) EIRP	12
EX-5r Series IC (Canada) EIRP	12
ETSI Compliance – EIRP limits.....	13
Time Division Duplex (TDD) Factors.....	14
Link Orientation and Synchronization.....	15
Radio A/B Configuration.....	15
System Installation and Initiation Process	17
Record Keeping	19
Installation.....	20
Mechanical Configuration and Mounting.....	20
Mounting the System	20
Radio Ports and Indicators	22
Connector Overview	22
LED Indicators.....	23
RESET Button	24
Power	24
Terminating the RF Connectors r-(x)c Series models only).....	25
AC Power.....	25
Power Injector.....	26
Reset to Critical Factory Settings	27
Antenna/Transmission System.....	27
Initial Antenna Mounting r-(x)c Series models only).....	29
Transmission Line from Antenna to Radio r-(x)c Series models only	30
RF Lightning Arrestor.....	32
Antenna Alignment.....	32
Configuration and Management	34
Telnet into the Command Line Interface (CLI).....	34

Connect to the Radio in a Telnet Session	34
Telnet	34
Exalt Graphical User Interface (GUI).....	35
Preparing to Connect.....	35
Make Connections	36
Log In.....	36
Login Privileges	37
Quick-Start.....	38
Navigating the GUI.....	39
Summary Status Section	39
Navigation Panel.....	40
Radio Information Page	41
Administration Settings Page.....	42
System Configuration Page.....	44
ETSI Compliance – EIRP limits	47
Ethernet Interface Configuration Page.....	49
T1/E1 Configuration Pages.....	50
T1 Interface Configuration Page.....	51
E1 Interface Configuration Page.....	52
T1/E1 Loopback.....	52
File Transfer Page	54
File Activation Page.....	57
Simple Network Management Protocol (SNMP) Configuration.....	58
Alarms Page	59
Performance Page	61
Event Log Page.....	64
Diagnostic Charts Page.....	65
Spectrum Analyzer Page.....	66
Reboot Page	67
Manual Page.....	68
Troubleshooting	69
General Practices	69

Typical Indications of Issues	70
Improper RF Cable Termination.....	71
Multipath Propagation	72
RF Interference	72
Path Obstruction.....	73
Misaligned Antenna	73
Faulty Antenna.....	73
Improper Grounding	73
Insufficient Link Margin.....	74
Moisture in the Transmission System.....	74
Specifications	75
Physical Specifications	75
Common System Specifications	75
EX-4.9r System Specifications	76
System Specifications, 5.3GHz Band	77
System Specifications, 5.4GHz Band	78
System Specifications, 5.8GHz Band	79
Interfaces.....	80
Back-to-back Bench Testing.....	82
Basic Test.....	82
Connections EX-5r-c only	82
EX-5r Basic Test Configuration	83
Verify Connection.....	83
Specification Performance Verification—EX-5r-(x)c only	83
Interface Connections	86
T1/E1 Connections.....	86
RSL & GPS Sync Connector	87
Power/Ethernet Connector	87
Copyright Notices	89
Net-SNMP.....	89
Index	94

List of Figures

Figure 1	Exalt EX-5r (integrated antenna model).....	2
Figure 2	Mounting and cabling—integrated antenna model.....	4
Figure 3	Cabling and mounting—external antenna model	4
Figure 4	Radio installation tasks	18
Figure 5	Pole-mount example	20
Figure 6	EX-5r pole and wall mount (with azimuth and elevation adjustment)	21
Figure 7	EX-5r-c pole/wall mount	21
Figure 8	EX-5r connectors	22
Figure 9	Power injector connectors.....	26
Figure 10	CLI main menu	34
Figure 11	Initiating the browser connection.....	37
Figure 12	Browser Login screen	37
Figure 13	Radio Information page	38
Figure 14	Exalt GUI window description	39
Figure 15	Summary status information.....	40
Figure 16	Radio Information page	41
Figure 17	Administration Settings page.....	42
Figure 18	System Configuration page.....	44
Figure 19	Ethernet Interface Configuration page.....	49
Figure 20	T1 Interface Configuration page.....	51
Figure 21	E1 Interface Configuration page.....	52
Figure 22	External (remote) loopback.....	53
Figure 23	External (local) loopback.....	53
Figure 24	Internal loopback	53
Figure 25	File Transfer page	54
Figure 26	File Transfer page—download file link.....	55
Figure 27	File Activation page.....	57
Figure 28	Alarms page	59
Figure 29	Performance page.....	61
Figure 30	Event Log page	64
Figure 31	Diagnostic Charts page	65

Figure 32	Reboot page	67
Figure 33	Manual page.....	68
Figure 34	Basic back-to-back bench test configuration	83
Figure 35	Ex-5r connector orientation	86
Figure 36	T1/E1 connectors	86
Figure 37	RSL & GPS connector	87
Figure 38	Power/Ethernet connector.....	88

List of Tables

Table 1	Supported antennas—Canada	v
Table 2	Factory default settings.....	15
Table 3	Connectors	22
Table 4	LED indicators	23
Table 5	Supported antennas	27
Table 6	Recommended transmission line	30
Table 7	Default login information	37
Table 8	Alarm status indicators	59

Introduction

Exalt Communications, Inc. thanks you for your purchase. Our goal is to build the highest quality, highest reliability digital microwave radio products. This commitment to quality and reliability extends to our employees and partners alike. We appreciate any comments on how we can improve our products, as well as your sales and Customer Care experience.

Customer Care Hotline (USA):	(408) 871-9890
Toll-Free Customer Care Hotline (USA):	(877) EXALT-01 (392-5801)
Direct-Dial Telephone (USA):	(408) 871-1804
Website:	www.exaltcom.com
Sales e-mail:	sales@exaltcom.com
Customer Care e-mail:	support@exaltcom.com
Mailing Address:	Exalt Communications, Inc. 580 Division St. Campbell, CA 95008 USA

Related Documentation and Software

This manual makes reference to other documentation and software files that may be necessary. Any document or software mentioned in this manual can be found at:

<http://www.exaltcom.com/support/downloads.htm>

The Exalt r-Series Digital Microwave Radios

The Exalt r-series of Digital Microwave Radios is the most advanced carrier-class point-to-point terrestrial radio communications devices operating in the 4940 to 4990 MHz and 5250 to 5850 MHz frequency bands. The EX-5r comes in the following configurations:

- r-Series has integrated software selectable polarization antenna
- r-c Series has external antenna connectors, which allows connection of either one single- or dual-polarized antenna (with software selectable polarization)
- r-x Series is a dual-radio with integrated dual-polarized antenna
- r-xc Series is a dual-radio with external antenna connectors designed for use with a dual-polarized antenna, or two separate single-polarization antennas mounted for dual-polarization.

The r-Series connects voice and/or digital data from one location to another, obviating the need for copper or fiber connectivity, or enhancing existing connectivity by providing a redundancy solution, a primary solution, and/or additional capacity. Figure 1 shows the Exalt r-series Digital Microwave radio.



Figure 1 Exalt EX-5r (integrated antenna model)

Generally, the r-Series requires a clear line-of-sight and proper path clearance to achieve a high-performance, reliable connection. Perform professional path engineering and site planning *before* installing this equipment.

The primary focus of this document is the installation and maintenance of the digital microwave radio, and assumes that path engineering and site planning has already been performed. Please refer to the Exalt document, ***Guidance for Engineering and Site Planning of Terrestrial Wireless Links***, for detailed information on these activities.

The EX-5r utilizes radio frequencies in the range of 5250 to 5850 MHz. In most countries these frequency bands are considered as ‘license-exempt’ or ‘unlicensed.’ This means that virtually any user may use these frequencies freely, without paying for access, or any type of pre-notification, post-notification or registration. As a result of this designation, users may also move or change these systems at any time, with significant flexibility to the location, orientation and configuration of the system. However, due also to this designation, there may be uncontrolled interference from other similar devices that occupy this spectrum. In these cases, it is up to engineering and maintenance personnel to design the system with existing and future interference sources in mind, recognizing that there is a chance that the interference conditions could be very dynamic, and outages may occur on the system as a result, and that, in some very rare cases, the system may cause interference into another system and may be required to be disengaged or modified/re-oriented to eliminate the interference.

If the spectrum in your country is designated as ‘license-exempt’ or similar, this does not infer that the installer may configure the system in **any** manner at **any** location. In most cases, there are regulations, or device-based conditions that limit the use of the device, such as maximum gain antenna, antenna types and maximum output power, as well as, in some cases, application limits, limited geography of use, and other unique regulations. **The link design engineer and/or professional installer must determine these limitations and engineer/install the system within the confines of all local regulations.** Also, it is required to examine any regulations that may apply to peripheral equipment, installation and cabling of the system that may be regulated for human safety, electrical code, air-traffic control, and other safety-related categories.

In certain countries, the spectrum for this product is **NOT** considered to be license-exempt. In these cases, there may be additional regulatory requirements concerning the location, frequency, power, orientation, configuration, and other aspects of the system, including, in some cases, a need for link registration, coordination, and fees that may apply to the system usage. Please consult your local regulatory organization(s) to determine usage requirements.

The EX-4.9i utilizes frequencies in the 4940-4990MHz range, and is typically a licensed band reserved for use by Public Safety agencies and applications. This band is not generally available outside of North America.

In almost all cases, either for license-exempt or other designation, the product itself must be authorized for use in your country. Either Exalt or Exalt's agent must have applied for certification or authorization to allow the sale and deployment of the system within the country. It is also possible that only certain versions or configurations of the device are allowed within a particular country. Please contact Exalt or your authorized Exalt representative for information pertaining to your country.



It is the (professional) installer's responsibility to ensure that the radio system is implemented in a legal fashion. Exalt is not liable for any unsafe or illegal installations.

Basic Features

The r-Series Digital Microwave Radio is intended for all-outdoor mounting. It is accompanied with an indoor-mounted power injector. In some cases, the EX-5r may also be mounted indoors or in an enclosure. Depending on the configuration purchased, the associated antenna is either integrated as part of the unit or connected separately.

For the integrated antenna model, the entire unit is typically mounted on a tower or rooftop mast structure, with Ethernet/Power and other optional interface cables running from the unit location, through a structure penetration, and to the power injector and connected communications equipment.

For the external antenna model, the unit is typically mounted very close to the external antenna to minimize RF cabling and associated losses. Alternatively, the unit may be mounted at an easily-accessible location with longer RF cabling to the antenna. Proper lightning or surge suppression devices and associated grounding are required for all connections.

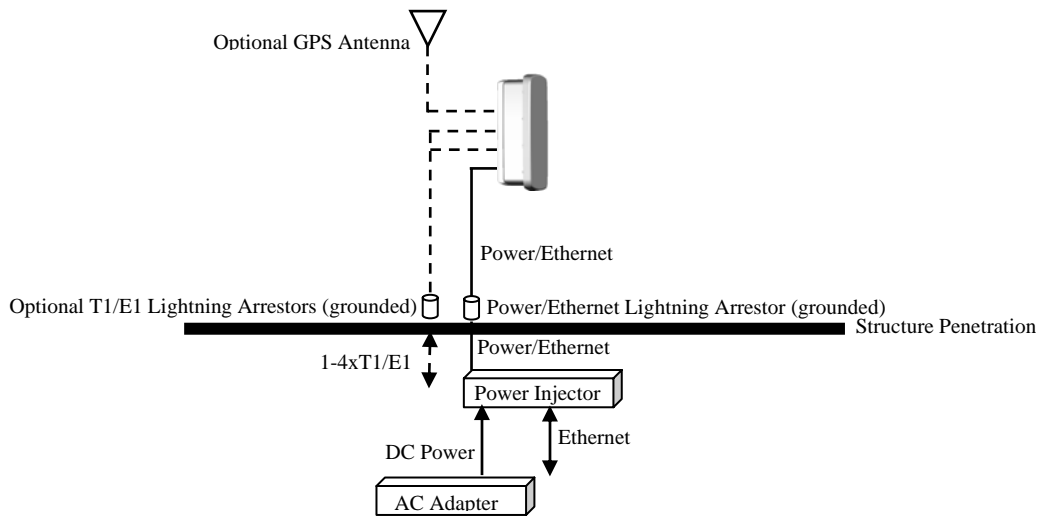

Figure 2 Mounting and cabling—integrated antenna model

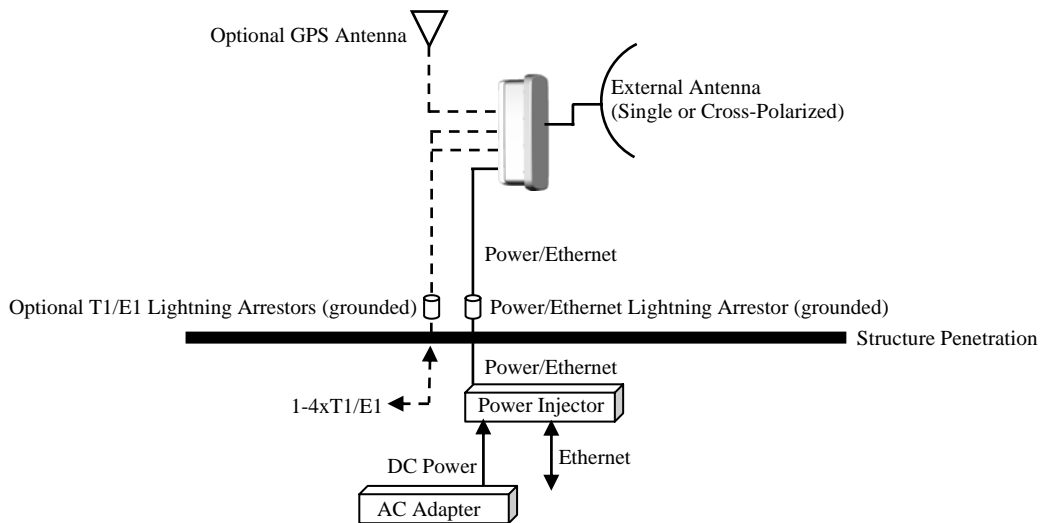

Figure 3 Cabling and mounting—external antenna model

For highest performance and reliability, it is advised to minimize the length of RF cable and associated transmission system losses between the antenna and the radio's antenna port.

The r-Series provides connections for a combination of the following data communication interfaces:

- 10/100BaseT Ethernet
- 4xT1/E1 interfaces for synchronous voice traffic

The EX-5r is powered by a combined Power/Ethernet cable, and associated power injector. The power injector provides 48VDC to the unit.

The EX-5r provides the following primary features and benefits:

- Low-latency optimization and control for voice and data connections
- Very high throughput and flexible interface configurations with voice+data combinations
- Encryption for extreme wireless security
- Easy-to-use management and configuration
- Flexible utilized channel bandwidth selection for interference avoidance and frequency coordination
- Flexible center frequency tuning for interference avoidance and frequency coordination
- Flexible capacity to meet current connection requirements and future growth needs
- Carrier-class reliability and performance
- Intuitive graphical user interface for fast and easy configuration and management
- Advanced diagnostics monitoring and analysis tools for fast and easy troubleshooting

Pre-installation Tasks

This section describes the steps necessary to prepare a site for the installation of the Exalt Digital Microwave Radio.

Link Engineering and Site Planning

Design all terrestrial wireless links prior to purchase and installation. Generally, professional wireless engineering personnel are engaged to determine the viability and requirements for a well-engineered link to meet the users' needs for performance and reliability.

The reader is referred to the Exalt document, ***Guidance for Engineering and Site Planning of Terrestrial Wireless Links*** and the ***ExaltCalc*** path calculator. This document and calculator aid in the pre-planning and engineering required to determine following attributes:

- Antenna type/gain at each end of the link
- Antenna mounting height/location for proper path clearance
- Antenna polarization orientation
- RF cabling type, length, connectors, route, and mounting
- Antenna system grounding
- Lightning arrestor type(s), location(s), and grounding
- Radio mounting location and mechanisms
- Radio grounding
- Radio transmitter output power setting
- Anticipated received signal level (RSL) at each end
- Anticipated fade margin and availability performance at each end
- Radio settings for TDD frame length and occupied bandwidth
- Anticipated throughput performance (TDM circuit support and Ethernet)
- Anticipated system latency

With respect to radio path and site planning, these radios are generally identical to other microwave terrestrial wireless systems. Engineering of these systems requires specific knowledge about the radios, including:

- RF specifications (transmitter output power, receiver threshold, occupied channel bandwidth, and carrier-to-interference tolerance)
- Regulatory limitations on transmitter output power setting and antenna type/gain
- Noise/interference profile for the intended location

- Impact on throughput and latency relative to link distance, occupied bandwidth, and TDD frame size setting, and the planned implementation of these parameters

Familiarization with the r-Series

The r-Series utilizes time division duplex (TDD) radio transmission. This means that the transmitted signal in both directions uses the same center frequency and transmits in one direction for a period of time, and then in the opposite direction for another period of time. This total period of time is referred to as the *frame length* or *TDD frame length*, and is further discussed in The professional installer is responsible to ensure that RF output power is properly adjusted so that it does not exceed the regulatory limit of these conditions.

ETSI Compliance – EIRP limits

For the EX-5r family, a +30dBm EIRP limit applies for operation in the 5250-5350 MHz or 5470-5725 MHz bands. Adjust the output power in accordance with the following formula:

$$P = 30 - G + L$$

where:

P = Maximum transmitter output power of radio, in dBm

G = Specified gain of antenna, in dBi within the operational band

L = Total transmission system losses of all elements between the radio's RF connector and the antenna's RF connector (all cables, connectors, lightning suppressors), in dB, as specified or measured in the operational band

For the EX-5r family, operation in the 5725-5850 MHz band, using a 10 MHz BW setting (shown as 8MHz in the GUI), a +33dBm EIRP limit applies. Using the same definitions as above, set the transmitter according to this equation:

$$P = 33 - G + L$$

For the EX-5r family, operation in the 5725-5850 MHz band, using a 20 MHz BW setting (shown as 16 MHz in the GUI), a +36dBm EIRP limit applies. Using the same definitions as above, set the transmitter according to this equation:

$$P = 36 - G + L$$

Time Division Duplex (TDD) Factors on page 13.

The two radio terminals are identical hardware, except for the TDD setting in software. When the radios are in their default state, both radios are configured as Radio B. **One end of the link must be configured as Radio A before the two ends of the radio system can communicate.**

It can be considered that Radio A is the primary radio in the link. Radio A provides the master clock and control to Radio B. For most applications, it is not important how the radio link is oriented, only that one end is configured for Radio A and the other for Radio B. For some applications (such as, multi-radio hub sites or repeaters), the orientation of the radio systems may be more critical. See Link Orientation and Synchronization on page 15 for details.

There are two ways to configure the radios for Radio A/B determination:

1. Use the Exalt browser-based graphical user interface (GUI) – preferred.
2. Connect to the radio using Telnet.

Exalt recommends using the Exalt GUI for radio configuration. This interface requires a computer with an Ethernet port and web browser software, such as Microsoft Internet Explorer 5.0 or above. See Configuration and Management on page 34 for details on how to connect to and use the browser-based GUI interface.

Shipping Box Contents

Unless purchased as a spare terminal, the radios are shipped as a complete *hop* (that is, a radio link pair consisting of two terminals). An outer box has labeling that indicates the contents of the box, with the part number and serial number details for both radio terminals.

Inside the outer box are two identical boxes, each of these boxes is also marked with the part number and serial number of the individual terminal contained inside the box. The terminal box contains the following items:

- Radio terminal (configured as Radio B)
- AC adapter
- Power injector
- Mounting kit (for pole or wall mounting)
- Accessory kit
 - Grounding screw/washers
 - Connector covers with safety ring (for covering and securing unused connectors)
 - Weather-sealing tape (required for RF connectors on the EX-5r-c)
 - RF connector cover (for the EX-5r-c, covering the unused RF connector, where applicable)
 - RSL adapter cable
- Registration card
- Quick-start guide
- 3-foot PoE cable (with safety ring)

Inspect the outer packaging and the contents of the boxes upon receipt. If you suspect any shipping damage or issues with the contents, contact Exalt Customer Care.



Register your system as soon as possible. A 2-year Warranty period applies to products registered within 90 days of purchase. The Warranty period is reduced to 1-year for unregistered products and products registered after the first 90 days.

The radio terminal boxes contain a single pre-terminated PoE cable intended for bench testing and to make the short connection between the radio and the PoE lightning arrestor near the radio. If running a longer cable from the radio to the PoE lightning protector (such as at the egress point), use pre-terminated cables (sold separately). Pre-terminated cables are available in different lengths to meet a variety of applications, and can also be used for the T1/E1 connections.

Back-to-Back Bench Test and Configuration

Every Exalt digital microwave radio goes through extensive quality testing and performance evaluation over the full operating temperature range prior to shipment. However, before installation, it is strongly advised to perform several tests and tasks that are much more difficult to perform once the radio link endpoints are distant from one another. A back-to-back bench test and pre-configuration will provide confidence that the radio link is operational and properly configured *prior* to installation, so that if troubleshooting is necessary, the radio hardware and configuration settings are eliminated from the troubleshooting process. Verify the following in the back-to-back testing:

- Confirm that the radio system is generally operational
 - Radios power-up with planned power and wiring solutions
 - RF link connects in both directions
 - Traffic passes across the link
- Configure connected equipment and cabling
 - Test Ethernet (CAT5) cabling, and/or T1/E1 cabling, any auxiliary connector cabling and configure all interfaces
 - Configure IP settings for configuration and management
 - Configure passwords and security modes
 - Become familiar with the configuration and management interfaces through the Exalt GUI interface
 - Configure radio parameters
 - Set transmitter output power to engineered or allowed level (see RF Output Power Setting)
 - Set operating center frequency
 - Set link distance, occupied channel bandwidth, and frame length
- Make detailed radio performance measurements

- Measure transmitter output power
- Measure receiver threshold performance
- Confirm unfaded error-free performance

Some of these tasks may not be possible or practical within a bench test environment due to the nature of the remote connectivity of peripheral equipment. However, it is good practice to perform as much as possible in this environment to minimize field/installation time and troubleshooting efforts.

Detailed performance measurements are usually not required for pre-installation, but can be easily performed at this stage and may be helpful for later troubleshooting efforts or for internal records. During troubleshooting, there may often be a point at which a back-to-back bench test should be performed to verify many or all of the above items, and in the case of a suspected faulty device, to help confirm the fault and determine which end of the system is at fault and in need of repair or replacement.



See Back-to-back Bench Testing on page 82 for detailed instructions.

RF Output Power Setting

The maximum RF output power is bounded by one of the following criteria:

- Maximum RF output power setting capability of the radio device
- Maximum RF output power allowed/authorized by the local government regulations and for this specific device
- Maximum effective isotropic radiated power (EIRP) of the transmission system allowed/authorized by the local government regulations and for this specific device
- Desired RSL to not exceed the maximum RSL allowed by the device
- Desired RSL to minimize/eliminate interference into neighboring systems



In many cases the radio must be pre-configured for legal maximum output power before connecting to the antenna and transmission system. Instructions for adjusting the output power can also be found in System Configuration Page on page 44.

The following information pertains to specific regulatory requirements based on up-to-date information for countries where these radios are authorized. A list of recommended antennas is listed in Antenna/Transmission System on page 27.

United States Compliance

The EX-5r operates under FCC Rule Parts 15.247 and/or 15.407 as a license-exempt device. The EX-4.9i operates under FCC Rule Part 90 as a licensed device. All of these devices must be professionally installed. It may only be used as a point-to-point transmission device for fixed or temporary-fixed (non-mobile) installations. The device is subject to the following restrictions:

- Do not use external amplifiers to boost the power or overcome transmission system losses, unless the specific amplifier/cable/antenna combination has expressly been authorized by the FCC. The output power must never exceed +30dBm.
- Cross-border transmissions are expressly prohibited, except with written permission from both the FCC and the governing body of the neighboring country (Cofetel for Mexico; Industry Canada for Canada).
- Use only parabolic dish antennas or directional flat-panel antennas. No other types of antennas (omni-directional, yagi, and so on) are authorized. Parabolic dishes of either grid or solid type are allowed. Maximum mid-band gain of each type of antenna certified is:
 - EX-4.9i models:
 - Parabolic dish: 26dBi (larger gains are allowed, with Tx power reduction)
 - Directional flat panel: 26 dBi (larger gains are allowed, with Tx power reduction)
 - EX-5i models:
 - Parabolic dish: 37.9 dBi (6'/1.8m diameter)
 - Directional flat panel: 28 dBi (~2'/61cm square)

EX-4.9r FCC (USA) EIRP

For the EX-4.9r model, within the 4940–4990 MHz band, the maximum EIRP allowed is +50dBm. The maximum output power of the radio shall never exceed +24dBm.

For the EX-4.9r models, the transmit power must be reduced from maximum (+20dBm for 40 MHz BW, +24dBm for 20MHz BW, +22dBm for 10MHz) by 1 dB for every 1dB that the antenna gain exceeds 26dBi (including transmission system losses).

The professional installer is responsible to ensure that RF output power is properly adjusted so that it does not exceed the regulatory limit of these conditions.

FCC (USA) EIRP

Within the 5725–5850 MHz band, the maximum EIRP allowed is 61.5dBm. The maximum output power of the radio shall never exceed +24dBm.

Within the 5250–5350 MHz band, the maximum transmit power with respect to FCC (USA) regulations is determined using the following equation:

$$P = 30 - G + L$$

where:

P = Maximum transmitter output power of radio, in dBm

G = Specified gain of antenna, in dBi, from 5250 to 5350 MHz

L = Total transmission system losses of all elements between the radio's RF connector and the antenna's RF connector (all cables, connectors, lightning suppressors), in dB, as specified or measured between 5250 and 5350 MHz

For the 5250–5350 MHz band, the maximum EIRP allowed for this device is 30dBm. The maximum output power of the radio shall never exceed +13dBm.

The professional installer is responsible to ensure that RF output power is properly adjusted so that it does not exceed the regulatory limit of these conditions.

Canada Compliance

The EX-5r Series operates under RSS-210 of Industry Canada regulations. The EX-4.9r Series operates under RSS-111 of Industry Canada regulations. Operation is subject to the following conditions, unless express permission is granted by Industry Canada to operate in a different manner:

- External amplifiers cannot be used to boost the power or to overcome transmission system losses, unless the specific amplifier/cable/antenna combination is expressly authorized by Industry Canada.
- Cross-border transmissions are expressly prohibited, except with written permission from both Industry Canada and the governing body of the neighboring country (FCC for USA)
- Only parabolic dish antennas or directional flat-panel antennas may be used. No other types of antennas (omni-directional, yagi, and so on) are authorized. Parabolic dishes of either grid or solid type are allowed. Maximum gain of each type of antenna allowed is:
 - Parabolic dish: 37.5 dBi (6'/1.8m diameter)
 - Directional flat panel: 28 dBi (~2'/61cm square)

A complete list of allowed antennas can be found in [Industry Canada \(IC\), Canada](#) on page v.

IC (Canada) EIRP

EX-4.9r Series IC (Canada) EIRP

For the EX-4.9i model, within the 4940–4990 MHz band, the maximum EIRP allowed is +50dBm. The maximum output power of the radio shall never exceed +24dBm.

For the EX-4.9i models, the transmit power must be reduced from maximum (+20dBm for 40MHz BW, +24dBm for 20MHz BW, +22dBm for 10MHz) by 1 dB for every 1dB that the antenna gain exceeds 26dBi (including transmission system losses).

The professional installer is responsible to ensure that RF output power is properly adjusted so that it does not exceed the regulatory limit of these conditions.

EX-5r Series IC (Canada) EIRP

Within the 5725–5850 MHz band, the maximum EIRP allowed is 61.5dBm. The maximum output power of the radio shall never exceed +24dBm.

Within the 5250–5350 MHz band, the maximum transmit power with respect to FCC (USA) EIRP regulations is determined using the following equation:

$$P = 30 - G + L$$

where:

P = Maximum transmitter output power of radio, in dBm

G = Specified gain of antenna, in dBi, from 5250 to 5350 MHz

L = Total transmission system losses of all elements between the radio's RF connector and the antenna's RF connector (all cables, connectors, lightning suppressors), in dB, as specified or measured between 5250 and 5350 MHz

For the 5250–5350 MHz band, the maximum EIRP allowed for this device is 30dBm. The maximum output power of the radio shall never exceed +13dBm.

The professional installer is responsible to ensure that RF output power is properly adjusted so that it does not exceed the regulatory limit of these conditions.

ETSI Compliance – EIRP limits

For the EX-5r family, a +30dBm EIRP limit applies for operation in the 5250-5350 MHz or 5470-5725 MHz bands. Adjust the output power in accordance with the following formula:

$$P = 30 - G + L$$

where:

P = Maximum transmitter output power of radio, in dBm

G = Specified gain of antenna, in dBi within the operational band

L = Total transmission system losses of all elements between the radio's RF connector and the antenna's RF connector (all cables, connectors, lightning suppressors), in dB, as specified or measured in the operational band

For the EX-5r family, operation in the 5725-5850 MHz band, using a 10 MHz BW setting (shown as 8MHz in the GUI), a +33dBm EIRP limit applies. Using the same definitions as above, set the transmitter according to this equation:

$$P = 33 - G + L$$

For the EX-5r family, operation in the 5725-5850 MHz band, using a 20 MHz BW setting (shown as 16 MHz in the GUI), a +36dBm EIRP limit applies. Using the same definitions as above, set the transmitter according to this equation:

$$P = 36 - G + L$$

Time Division Duplex (TDD) Factors

The r-Series radios are very dynamic, allowing the installer to optimize and control the performance of the radio system for the intended application. The following parameters must be carefully determined during the link engineering phase:

- Link distance
- Bandwidth
- TDD frame size
- Mode (modulation)

The setting of the above parameters determines the following performance factors:

- Number of supported T1/E1 channels
- Ethernet throughput
- System latency (delay)

Use the *ExaltCalc* calculator to determine optimum settings for the above parameters to meet the needs of your application.

The following generalizations can be made with regards to these factors:

- The shorter the TDD frame size, the lower the latency
- The shorter the link distance, the lower the latency, the higher the throughput
- The longer the TDD frame size, the higher the throughput
- The higher the bandwidth, the higher the capacity
- The higher the mode, the higher the capacity



Disable all T1/E1 ports if there are no T1/E1 interfaces connected. This shifts all available throughput to the Ethernet interface.

If a selected combination of the Link Distance, Frame Size, Bandwidth, and Mode parameters cannot support all four T1 or E1 ports, the ports that cannot be supported are automatically disabled. Priority is placed on the T1/E1 port number. That is, the first port to be disabled, if necessary, is the highest port number, such as Port 4.

Link Orientation and Synchronization

Link *orientation* refers to the Radio A and Radio B placement in your network. Link *synchronization* refers to using external or internal timing to coordinate multiple links.

For every link, one end of the radio link must be configured as Radio A, while the other end is configured as Radio B. In single-link systems, it does not matter which end of the system is mounted at which end of the link, and there is typically no requirement for any link synchronization.

Link orientation and synchronization are more important for networks with site(s) where there is more than one link of the same type or for sites using the same type of radio that are very close to each other at one or both ends.

Configure collocated radio terminals for the same link orientation. That is, configure all radios at the same location as Radio A or Radio B.

In addition, it can be advantageous to utilize link synchronization for collocated links. The radios allow the use of an optional GPS synchronization kit. This synchronization controls the transmitter and receiver frame timing so that collocated radios are transmitting at the same time and receiving at the same time. This can substantially reduce the opportunity for self-interference. Without synchronization, collocated radios may be transmitting and receiving at the same time, incurring near-end interference.



It is not always necessary to synchronize collocated radios. If antennas are substantially separated or blocked from one another and/or frequency separation tuning is used, the opportunity for near-end interference can be eliminated.



When synchronization is required or desired, one GPS kit is required for each EX-5r link in the connected or collocated network.

Radio A/B Configuration

Use the Exalt GUI to configure the radio terminals for Radio A and Radio B orientation. Since many other parameters also need to be set, and the Exalt GUI is needed for these configurations, this is the best way to completely configure the radio terminals.

Radios arrive from manufacture in default configuration, orientated as Radio B and configured as shown in Table 2.

Table 2 *Factory default settings*

Parameter	EX-4.9r Series	EX-5r Series
Frequency	4965 MHz	5788 MHz
Transmit Power	+4dBm	+4dBm
Link Distance	<10 miles	
Bandwidth	8 MHz	
Mode	Mode 1	
TDD Frame Size	2ms	

Parameter	EX-4.9r Series	EX-5r Series
Link Security Key	000000000000	
Administration Password	password	
User Password	password	
IP Address	10.0.0.1	
IP Mask	255.0.0.0	
IP Gateway	0.0.0.0	
Ethernet Interface	Alarm Enabled, 100/Full	
T1/E1 Enabling	All Disabled	



In many cases, the system design will not be identical to the factory default configuration, and in some cases, these differences prohibit the installation of the radio. If at all possible, obtain a computer and configure the radio terminals using the browser-based GUI. See [Exalt Graphical User Interface \(GUI\)](#) on page 35 for details.

Radio Reset

Use the reset function if the IP address and/or passwords are lost. Use the following steps to perform a critical parameter reset:

1. Remove power from the radio by disconnecting the AC adapter from the power injector.
2. Hold down RESET button on the power injector while applying power.

Hold the RESET button down through the entire power cycle and monitor the DATA+POWER left LED on the power injector. Release the RESET button only after the LED is in the steady state (45 to 60 seconds).

3. Release the RESET button.

The following configurations are reset on the radio:

- IP address = 10.0.0.1
- IP mask = 255.0.0.0
- IP gateway = 0.0.0.0
- Administration password = password
- User password = password
- Endpoint Identifier = Radio B

System Installation and Initiation Process

The tasks required for radio installation and initiation are outlined in the following figure.

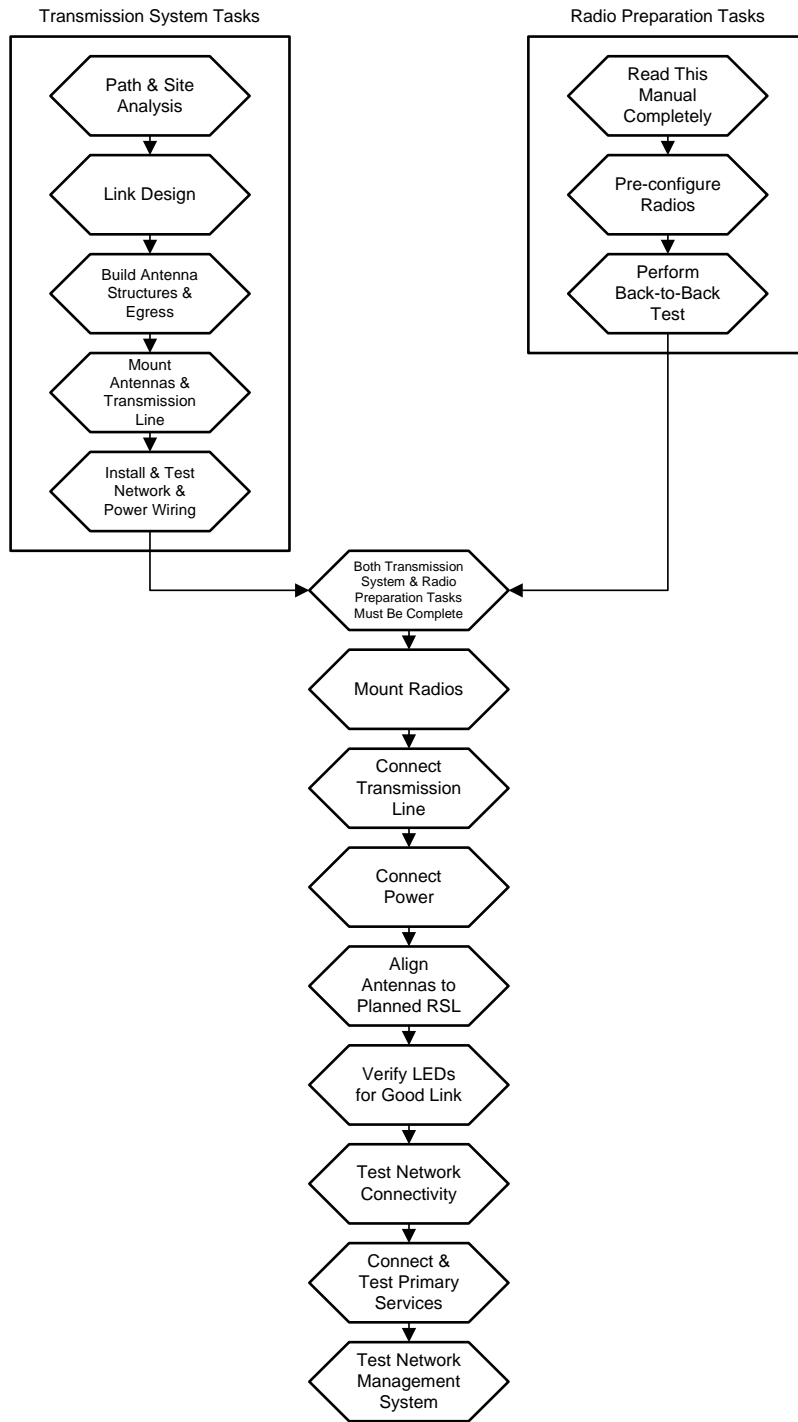

Figure 4 Radio installation tasks

Record Keeping

After installation, record the following items for ongoing maintenance and future troubleshooting. Keep a record for each end of the radio link and store a copy of these records at the radio location, at the opposite end radio location, and a central record storage location.

- GPS coordinates for antenna locations at each site
- Antenna heights above ground level (AGL), as mounted
- Antenna model numbers, serial numbers, and specifications
- Antenna polarization as mounted
- Length/type of primary transmission lines at each site (r-c Series only)
- Model number and serial number of RF lightning arrestors (r-c Series only)
- Transmitter output power setting as installed at each site
- RSL as measured after antenna alignment at each site
- Designed RSL per original design at each site
- RSL reading with far-end power off (from each end)
- Spectrum analyzer plot with far end off at each site
- (r-c Series only) Voltage standing wave ratio (VSWR)/return loss at the antenna connector(s) at each site
- Model number and serial number of PoE and/or T1/E1 lightning arrestor(s) used
- Length(s) of PoE and/or T1/E1 cables from radio, through lightning arrestor(s) to termination points
- Radio's network management IP address at each site
- Radio's network management gateway address at each site
- Radio's operating frequency, bandwidth setting, and mode of operation
- Optionally purchased extended warranty and/or emergency service contract details

In addition, certain information may be desired for central record-keeping only:

- Security codes and login passwords (kept in a secure place)
- Photographs of complete installation
- End-user sign-off/acceptance documentation (if any)
- Photo of product identification label (part number, serial number, MAC address information)
- Site access information phone numbers, access codes, directions

Installation

This section presents all tasks required to install the Exalt Digital Microwave Radio.

Mechanical Configuration and Mounting

The Exalt r-Series are environmentally sealed units intended for deployment outdoors. The device must be deployed within an ambient temperature range as specified, and with non-restrictive airflow around the chassis. The r-c and r-xc Series' can also be mounted in an enclosure or indoors. The same airflow and temperature conditions apply. All r-Series models can be mounted behind a window if window losses are considered in the link budget calculation.



The power injector and power supply must be placed indoors or in an enclosure.

Provide proper clearance for all cables and connectors attached to the device. Note that for the r-(x)c Series, the RF cable connector may require significant clearance for the bend radius of the coaxial cable assembly. All RF connectors, cables, and adapters must be rated for operation within the radio's frequency range. RF connector losses must be accounted for within the link engineering design and output power settings.



There are two RF connectors on the r-(x)c Series, which facilitate connection to a cross-polarized antenna for polarization diversity. Seal the secondary connector when using a single-polarized antenna. Use the N-type cover cap and weather-seal tape included in the accessory kit to weatherproof this connector.

Mounting the System

Use the mounting system supplied with each terminal for wall or pole mounting (Figure 5). The pole mounting kit can accommodate a pole 2–5"/5-13cm in diameter. Install the mounting system first, and then affix the radio to the mount. The radio can also be affixed to the mount, and the entire assembly (including radio) mounted.

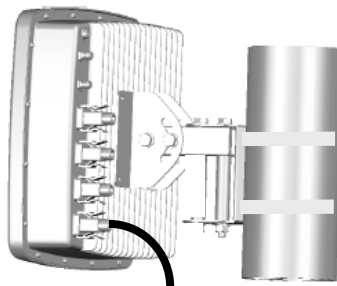

Figure 5 Pole-mount example

Figure 6 illustrates the r-Series pole/wall mount assembly, showing the azimuth and elevation adjustment points.

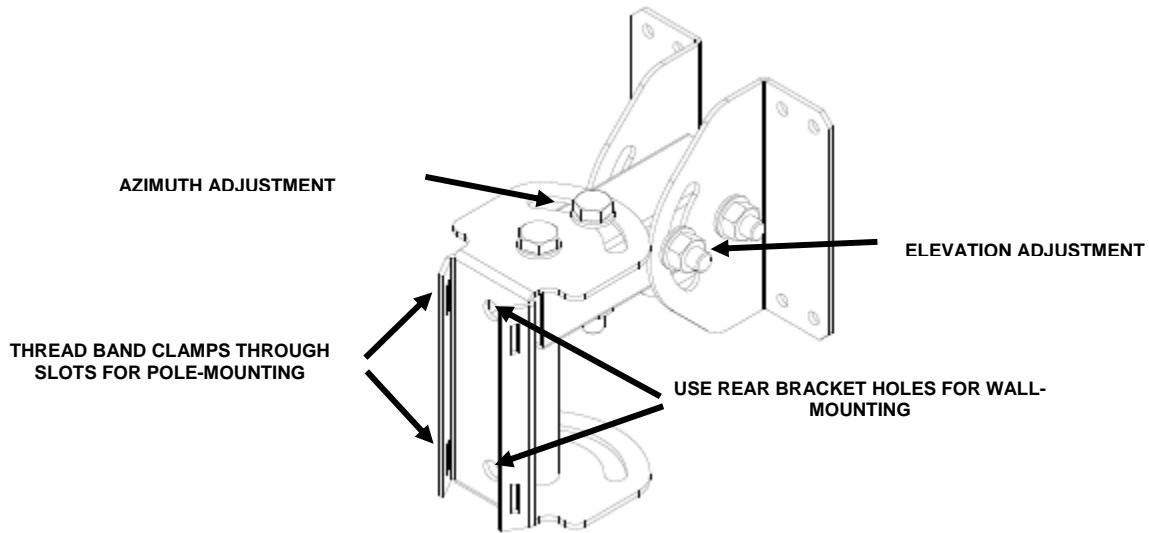

Figure 6 EX-5r pole and wall mount (with azimuth and elevation adjustment)

Figure 7 illustrates the r-c Series pole/wall mount assembly.

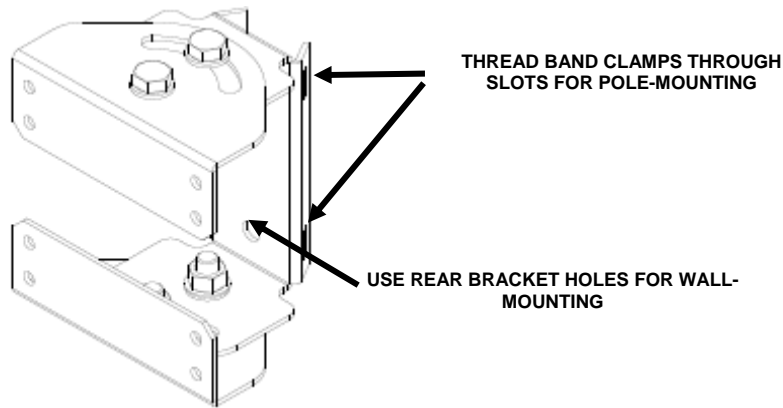

Figure 7 r-c Series pole/wall mount

For the integrated antenna model, it is critical to mount the entire device at the predetermined location for proper path clearance to the link end. Ensure that there is adequate space around the mounting system and the radio to allow for antenna alignment for both azimuth and elevation adjustments.



Mount the r-c Series as close as possible to the antenna to minimize the length and associated losses of RF cabling.

Radio Ports and Indicators

This section provides a brief overview of the connectors, controls, and indicators on the device. Details about each item are in other sections of this document. Figure 8 shows the connectors on the r-Series.

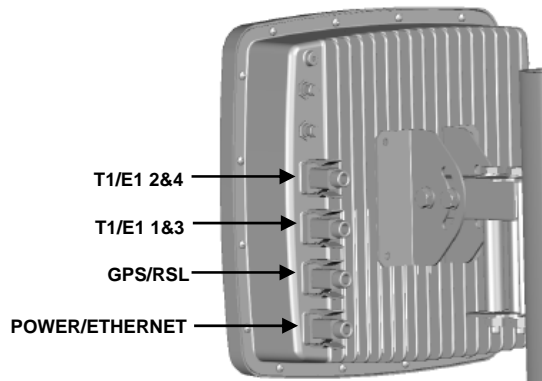

Figure 8 EX-5r connectors

Connector Overview

The primary user interfaces are shown in Figure 8. Table 3 provides details of the connectors. Detailed pin structures for each connector are in [Interface Connections](#) on page 86.

Table 3 Connectors

Connector	Description
GPS/RSL	(1) Connection to (optional) external GPS antenna for network synchronization. (2) Antenna alignment RSL voltage (during installation)
T1/E1 2&4	Ports for up to two user T1 or E1 circuits to traverse link, port numbers 2 and 4
T1/E1 1&3	Ports for up to two user T1 or E1 circuits to traverse link, port numbers 1 and 3
Power/Ethernet	Connected cables traverse to the power injector (Data+Power side), and provide the following functions: <ul style="list-style-type: none"> • Primary ports for user Ethernet data (10BaseT or 100BaseT) to traverse link • DC power from power injector
⬇ (Ground)	Threaded (M5) receptacle



Use a connector cover on all unused connectors for weatherproofing. The connector covers are included in the accessory kit. Use a safety ring on each connector to secure the connector covers.

LED Indicators

Table 4 provides details of the LED indicators on the r-Series radios. Note that there are two LEDs, labeled top and bottom, associated with each connector. See [Alarms Page](#) on page 59 for information on how the Exalt GUI displays LED status.

Table 4 *LED indicators*

Location	Type	Function
T1/E1 2&4 Top	Green LED	Solid when T1 clocking is present for input #2.
T1/E1 2&4 Bottom	Green LED	Solid when T1 clocking is present for input #4.
T1/E1 1&3 Top	Green LED	Solid when T1 clocking is present for input #1.
T1/E1 1&3 Bottom	Green LED	Solid when T1 clocking is present for input #3.
GPS/RSL Top	Green LED	(Future implementation)
GPS/RSL Bottom	Green LED	(Future implementation)
Power/Ethernet Top	Green LED	Solid when proper power is applied.
Power/Ethernet Bottom	Green LED	(Future implementation)
<i>Power Injector</i>		
DATA+POWER Left	Green LED	Solid when no alarm conditions are present. Flashing when in alarm condition. While RESET button is pressed: Solid when in major alarm condition (traffic affecting). Flashing when in minor alarm condition (not traffic affecting). Off when no alarm conditions are present.
DATA+POWER Right	Green LED	Solid when proper power is applied.

During boot up, the DATA+POWER left LED on the power injector is solid green for approximately 30 seconds, and then turns off briefly. The antenna alignment buzzer then activates for approximately two seconds, and then the LED flashes once. After boot up

completes, the LED is solid when no alarm conditions are present, and flashes continuously if alarms conditions are detected. The LED remains in this state until another boot up or until alarm conditions change.

RESET Button

There is only one external control on the r-Series system, a button labeled “RESET” which is located on the Power Injector. This button performs two functions: critical system parameter reset and summary alarm information.

Use the reset function if the IP address and/or passwords are lost. Use the following steps to perform a critical parameter reset:

1. Remove power from the radio by disconnecting the AC adapter from the power injector.
2. Hold down RESET button on the power injector while applying power.

Hold the RESET button down through the whole power cycle and monitor the DATA+POWER left LED on the power injector. Release the RESET button only after the LED is in the steady state (45 to 60 seconds).

3. Release the RESET button.

The following configurations are reset on the radio:

- IP address = 10.0.0.1
- IP mask = 255.0.0.0
- IP gateway = 0.0.0.0
- Administration password = password
- User password = password
- Endpoint Identifier = Radio B

A flashing left DATA+POWER LED on the power injector indicates that alarm conditions exist on the radio. To access summary alarm information during normal operation, press and hold the RESET button. The following is status for the left the DATA+POWER LED while holding the RESET:

- Solid on is a link alarm (link is down or errored)
- Flashing indicates a minor alarm (does not affect traffic)

Power

The radio requires a DC power source within specifications. DC can be provided from a DC battery source, central lab/rack supply, or from the supplied AC adapter.



Read this section completely before applying power.

Terminating the RF Connectors r-(x)c Series models only)

Before applying power, the RF connectors must be properly terminated into a 50-Ohm load. If this is not performed, the radio may be damaged by simply applying power. Also, there are human safety factors to consider regarding potentially harmful RF radiation.

The following lists a few simple ways to achieve proper termination:

- Connect a 50-Ohm coaxial termination device to the RF port of the radio. The termination must be rated to 1W (or more). Example(s) include:
 - Broadwave Technologies P/N 552-200-002, or similar
- Connect the complete transmission system. That is, the RF cabling including the antenna. The cabled antenna provides a proper termination for the RF output.
- Connect a fixed (or a series of fixed) 50-Ohm attenuator(s) to the RF connector, either directly or at the end of an RF transmission line. The attenuator must be at least 30dB as specified at the operating frequency and rated for a minimum of 1W input power. Examples include:
 - Broadwave Technologies P/N 352-103-xxx
 - Bird 2-A-MFN-xx
 - JFW Industries 50FP-xxx-H6-N

Cover any unused connector with the connector cap and apply the weather-seal tape. Both cap and tape are included in the accessory kit.

AC Power

The AC adapter easily connects to the power injector. Refer to the input voltage requirements stated on the label affixed to the adapter to ensure that the adapter can be used with the AC mains supply.

The AC plug outlet provided with the adapter may need to be replaced to match the country configuration. The adapter cable uses a standard connector for this cable for use of a pre-wired cable appropriate to the outlet configuration. If the appropriate cable is not available, the existing AC plug end can be severed and a replacement plug affixed. Consult a qualified electrician for this activity.

Do not plug the adapter into the mains power. First, verify that the RF connector is properly terminated (see Power on page 24), and then plug in the radio-side connector from the AC adapter to the radio. If the AC mains can be turned off using a switch, disable the power, plug the AC side of the adapter into the AC mains socket, and then enable power to the circuit. If the AC mains cannot be turned off, plug in to the AC main socket to apply power.

Verify that the radio is active by observing LED activity on the injector and radio. All LEDs on the radio flash at initial power cycle.

Exalt strongly recommends that the AC mains supply be fused or on a separate breaker to ensure against over-voltage and/or over-current situations and to provide some form of protection to the radio electronics and other devices connected to the same supply. In addition, if the AC power is

subject to significant spikes or variation, power conditioning is a worthwhile investment, as the quality of mains power may have a direct impact on the device operation, performance and/or reliability. An Uninterruptible Power Source (UPS) or other form of battery-backed system protects against brown-out and black-out conditions, and condition the power presented to the adapter.

Evaluate the opportunity for lightning or other similar surges to be present on the powering system, including the ability for surges to couple to the power wiring system. If an evaluation indicates that there is a potential likelihood for these conditions to occur, additional surge protection is recommended for the input power wiring, especially to protect the radio electronics between the adapter and the radio's DC input connector.

The above statement is similarly true for every wired connection to the device. While the configuration for surge suppression or line conditioning is of a different type for each kind of signal interface, the opportunity for damage to the device, loss of communications and property is significant. In some cases, there can also be a risk to human life by not protecting against lightning entering a building through wiring or improper grounding. If you do not have experience in this type of installation practice, consult a qualified electrician and/or telecoms professional during the installation and wiring of the equipment.

Power Injector

The r-Series uses a power injector to send DC power to the radio over the CAT5 cable, and including the Ethernet connections. Figure 9 shows the power injector connectors that connect the AC adapter (included with the system) and the radio.

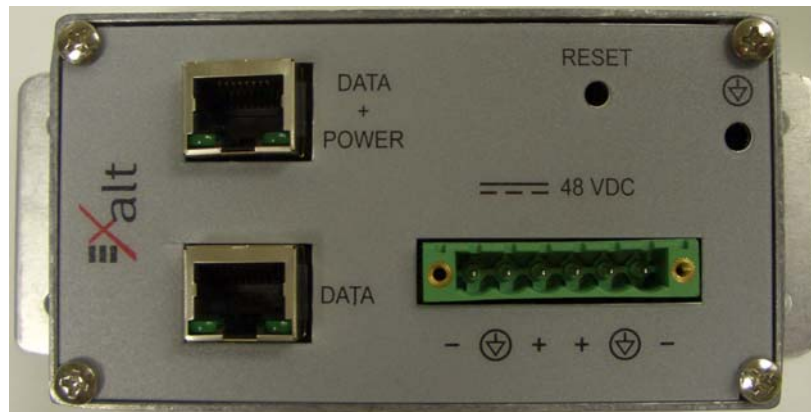

Figure 9 Power injector connectors

Connect the network Ethernet connection to the DATA connection of the power injector.

Connect the cable for the radio to the DATA+POWER connection of the power injector.

Ground the power injector using the grounding receptacle. The injector can also be mounted to a wall using the bottom panel brackets. For proper safety, the ground source should be the same as that used for AC power ground into the included AC adapter.

Reset to Critical Factory Settings

If necessary, the radio terminal may be reset to critical factory settings. This may be necessary if the IP address and/or passwords for the system are not known. All other configurations are left at their current settings. If a complete default factory configuration is desired, load the Default Configuration File into the system, as described in [System Configuration Page](#) on page 44.

The following parameters are configured after a reset to critical factory settings:

- IP Address = 10.0.0.1
- IP Mask = 255.0.0.0
- IP Gateway = 0.0.0.0
- Administration password = password
- User password = password

See [Radio Reset](#) on page 16 for instructions on performing a reset to critical factory settings.

Antenna/Transmission System

This section provides general guidance to the mounting and connecting of the RF transmission system, consisting of the antenna, RF cabling, and RF lightning arrestors. Consult the manufacturer's instructions for proper mounting, grounding, and wiring of these devices, and for definitive direction. These manufacturer's instructions supersede any information in this section.

Table 5 lists antennas supported by the EX-5r Digital Microwave Radios for use in the USA. In some countries, antennas exceeding a certain level of gain may be unlawful. Refer to [RF Output Power Setting](#) on page 10 for details on regulatory limits. See [Regulatory Notices](#) on page iv for supported antennas in Canada.

Table 5 *Supported antennas*

Manufacturer	Model #	Description	Midband Gain (dBi)	3dB (Azimuth/Elevation)
Andrew	P2F-52-N	2-foot Dish	29.4	5.4
Andrew	PX2F-52-N	2-foot Xool Dish	29.4	5.4
Andrew	P3F-52-N	3-foot Dish	33.4	3.8
Andrew	PX3F-52-N	3-foot Xool Dish	33.4	3.8
Andrew	P4F-52-N	4-foot Dish	34.9	3.0
Andrew	PX4F-52-N	4-foot Xool Dish	34.9	3.0
Andrew	HP2F-52-NPA	2-foot HP Dish	29.0	5.4
Andrew	HPX2F-52-NPA	2-foot Xool HP Dish	29.0	5.4
Andrew	HP3F-52-NPA	3-foot HP Dish	33.0	3.8
Andrew	HPX3F-52-NPA	3-foot Xool HP Dish	33.0	3.8
Andrew	HP4F-52-NPA	4-foot HP Dish	34.5	3.0
Andrew	HPX4F-52-NPA	4-foot Xool HP Dish	34.5	3.0
Andrew	HP6F-52-NPA	6-foot HP Dish	37.2	1.8
Andrew	HPX6F-52-NPA	6-foot Xool HP Dish	37.2	1.8
Andrew	FPA5250D06-N	6-inch Panel	18.0	19.3
Andrew	FPA5250D12-N	1-foot Panel	23.6	9.6

Manufacturer	Model #	Description	Midband Gain (dBi)	3dB (Azimuth/Elevation)
Exalt	(Intebral)	1-foot Xool Panel	20.0	15.0
Gabriel	DFPS.5-52	6-inch Panel	18.0	19.0
Gabriel	DFPD1-52	1-foot Panel	23.5	9.4
Gabriel	DFPD2-52	2-foot Panel	28.0	4.6
Gabriel	QF2-52-N	2-foot Dish	28.5	5.6
Gabriel	QF2.5-52-N	2.5-foot Dish	31.2	4.4
Gabriel	QF4-52-N	4-foot Dish	34.8	2.7
Gabriel	QFD2-52	2-foot Xool Dish	28.4	5.6
Gabriel	QFD2.5-52	2.5-foot Xool Dish	31.1	4.4
Gabriel	QFD4-52	4-foot Xool Dish	34.7	2.7
Gabriel	HQF2-52-N	2-foot HP Dish	28.2	5.7
Gabriel	HQF4-52-N	4-foot HP Dish	34.4	2.8
Gabriel	HQF6-52-N	6-foot HP Dish	37.4	1.9
Gabriel	HQFD2-52	2-foot Xool HP Dish	28.1	5.7
Gabriel	HQFD2.5-52	2.5-foot Xool HP Dish	30.7	4.5
Gabriel	HQFD4-52	4-foot Xool HP Dish	34.3	2.8
Gabriel	HQFD6-52	6-foot Xool HP Dish	37.3	1.9
MTI	MT-485001	7.5-inch Panel	19.0	18.0
MTI	MT-485002	1-foot Panel	23.0	9.0
MTI	MT-486004	18-inch Panel	26.0	6.0
MTI	MT-486001	2-foot Panel	28.0	4.5
MTI	MT-485005	7.5-inch Xool Panel	18.0	17.0
MTI	MT-485025	15-inch Xool Panel	23.0	9.0
Radio Waves	FP.5-5-18	6-inch Panel	18.0	20.0
Radio Waves	FP1-5-24	1-foot Panel	23.8	10.0
Radio Waves	FP2-5-28	2-foot Panel	28.0	4.5
Radio Waves	FPD.5-5-18	6-inch Xool Panel	18.0	20.0
Radio Waves	SP1-5.2	1-foot Dish	22.5	11.1
Radio Waves	SP2-5.2	2-foot Dish	29.0	6.1
Radio Waves	HP2-5.2	2-foot HP Dish	28.6	6.1
Radio Waves	SP3-5.2	3-foot Dish	32.0	4.0
Radio Waves	SP4-5.2	4-foot Dish	34.8	3.0
Radio Waves	SPD2-5.2	2-foot Xool Dish	28.1	6.2
Radio Waves	SPD3-5.2	3-foot Xool Dish	31.1	4.2
Radio Waves	SPD4-5.2	4-foot Xool Dish	34.4	3.1
Radio Waves	SPD6-5.2	6-foot Xool Dish	37.5	2.1
RFS	SPF2-52A	2-foot Dish	27.9	6.2
RFS	SPF3-52A	3-foot Dish	31.4	4.2
RFS	SPF4-52A	4-foot Dish	33.9	3.1
RFS	SPF6-52A	6-foot Dish	37.4	2.1
RFS	SDF4-52A	4-foot HP Dish	33.9	3.1
RFS	SDF6-52A	6-foot HP Dish	37.4	2.1
RFS	MA0528-19AN	7.5-inch Panel	19.0	18.0
RFS	MA0528-23AN	1-foot Panel	23.0	9.0
RFS	MA0528-28AN	2-foot Panel	28.0	4.5

Initial Antenna Mounting r-(x)c Series models only)

The antenna must be an exact model recommended by the path and site planning engineer(s). Mount the antenna at the proper height, mast/mounting location and polarization orientation as determined by the path and site planning engineer(s). The model type, location, and orientation of the antenna is critical with respect to achieving proper path clearance, as well as to mitigate external or self-interference from nearby or collocated systems operating in or near the same frequency band.



Mount the antenna in a restricted area and in a manner preventing long-term human exposure to the transmitted RF energy. To comply with FCC and Industry Canada regulations, the minimum safe distance from the antenna for continuous human exposure is $10\sqrt{3}m$.

The antenna structure must be secure and safe with respect to the mounting of the antenna, transmission system weight, radio housing, and the combined weight of any personnel that may climb or attach to the structure.

The combined weight of items and forces on the structure must be carefully considered in the design and construction of the structure. This must include the weight bearing on the structure in the highest wind conditions possible in the region, and with respect to all objects affixed to the structure.

If additional objects are affixed to the structure in the future, it may be important to evaluate both the mechanical impact of these planned additions (with respect to wind and weight loading), as well as the potential impact to RF interference and frequency coordination (if additional radio equipment is anticipated). This is especially important if future equipment is likely to operate within the same frequency band.

Once the antenna is mounted, cabled, and aligned, your goal is to never require modification. This prior planning is important in the path and site planning stages and in construction of the antenna structure.

Follow the antenna manufacturer's instructions for mechanical mounting of the antenna. Ensure that there is enough room around the antenna for alignment activities (moving the antenna in vertical and horizontal arcs), and for the RF transmission line to connect to the antenna connector unobstructed and within the specified bend radius requirements of the transmission line.

At this point, the antenna mounts should be fully secure to the structure, the feed of the antenna securely mounted to the antenna (if the feed is a separate assembly), and the azimuth and elevation adjustments not completely tightened in preparation of the antenna alignment activity. It is a good practice to connect the transmission line to the antenna connector as early in the process as possible, to reduce the opportunity for debris or moisture to enter either the antenna connector or the transmission line connector. Use a connector cover or other temporary measures to ensure that the connector is kept clear. Take extra care if the antenna is installed during inclement weather to ensure that no moisture gets inside the antenna connector at any time.

Now the antenna can be aimed in the general direction required for the link. Use a compass, a reference bearing, binoculars or any other similar device to point the antenna in the direction

(generally) of the far end radio, and then slightly tighten the azimuth and elevation adjustments so that the antenna maintains its general position and is safe to be left without additional securing. Refer to the Exalt white paper, *Antenna Alignment*, for more information on antenna alignment techniques.

Transmission Line from Antenna to Radio r-(x)c Series models only

Most installations use a very short length of coaxial transmission line for the connection between the antenna and the radio device. Coaxial transmission line can either have a solid or braided shield. Solid-shield cables are more resistant to external signal coupling and interference, but are generally stiffer than braided cables. Consult the path or site engineer(s) to ensure that the proper materials are chosen for the installation and that all factors were considered.

Generally, the larger the diameter of the transmission line, the lower the loss. So for longer runs of transmission line, larger diameter cables are highly advised. However, at every frequency, there is a maximum diameter cable that supports the operating frequency. Verify the specifications. This should be determined in the path and site planning process.

Table 6 lists representative samples of transmission line types recommended for the Exalt Digital Microwave Radio.

Table 6 *Recommended transmission line*

Manufacturer	Type	Description	Loss at 4.9GHz	Loss at 5.3GHz	Loss at 5.8GHz
Andrew	LDF4-50	1/2-inch solid shield	5.6dB/100ft.	5.7dB/100'	6.0dB/100'
Andrew	LDF4.5-50	5/8-inch solid shield	4.3dB/100ft.	4.4dB/100'	4.7dB/100'
Times	LMR-600	1/2-inch braided shield	6.8dB/100ft.	6.9dB/100'	7.3dB/100'
Times	LMR-900	5/8-inch braided shield	4.5dB/100ft.	4.6dB/100'	4.9dB/100'
RFS	LCF12-50J	1/2-inch solid shield	5.5dB/100ft.	5.6dB/100'	5.9dB/100'
RFS	LCF12-58J	5/8-inch solid shield	4.4dB/100ft.	4.5dB/100'	4.8dB/100'

It is critical that the transmission line and antenna be capable of supporting the same type of connector, or easily adapted. It can be important to minimize the number of connectors and adapters, and it is ideal that they match directly without adaptation. In most cases, transmission line allows for N-type male connectors and antennas have N-type female connectors.

If possible, connect the primary transmission line directly to the antenna. It is desired to have the fewest possible pieces of transmission line in the system, to minimize losses and points of failure from connectors. The antenna can typically accommodate a direct connection if planned in advance. Use a 90° adapter for the connection to the antenna, if necessary, but confirm that all connectors and transmission lines are properly specified for the operating frequency with minimum loss, proper impedance (50 Ohm) and proper VSWR characteristics.

Transmission line connector termination is a critical element of the installation. Many 'factory built' RF transmission lines do not provide the proper characteristics for proper transmission, despite their published specifications, often due to the fully or semi-automated process of factory

termination, which may not have considered the frequency of your system. When buying pre-terminated transmission line, it is strongly advised to obtain the documentation of test measurements on the connected transmission line showing that the loss characteristics and VSWR are within the specified limits specifically at your operating frequency. In addition to factory-built transmission line, self-terminated transmission line can suffer the same issues.



Always follow the manufacturer's termination process EXACTLY, and only use the manufacturer's authorized tools and connectors for a given transmission line type.

The manufacturers of transmission line typically offer instruction and certification for transmission line termination, and may also provide videos illustrating the process. There is no amount of extra care, education, precision, and effort that can be overstated for this process.

There is often a need for a small excess of transmission line near the antenna to accommodate both the need for extra slack as the antenna is loosened and moved for the alignment process, and to accommodate a drip loop for the transmission line and the initial transmission line securing hardware and grounding near the antenna. In addition, the transmission line is typically very stiff, and can provide undue pulling force on the antenna or radio connector. Take care to align the cable with the connector so that it does not provide any torque or strain on the connector.

Consult your transmission line manufacturer for the proper transportation, hoisting, securing, and grounding process. Always be very mindful of the entire length of transmission line to ensure that the transmission line is never twisted, kinked, or over-bent beyond the specified bend radius. Once a transmission line is over-bent or kinked, it will likely never recover its specified characteristics, even after straightening, and will often be completely unusable.

The opposite end of this primary transmission line typically terminates at the radio connector. If using a long transmission line (in excess of 3'/1m), an RF lightning arrestor is recommended to protect the radio equipment.

As soon as practical, weatherproof the connected ends of the transmission line to the antenna and lightning arrestor and radio. This process should be delayed as long as possible to ensure that all systems are working properly before applying the weatherproofing. Once weatherproofing is applied, it may have to be removed for testing or installation modification. With this in mind, if the installation is occurring during inclement weather, take extra care at all times to ensure that no moisture enters any connector at any time. If moisture is suspected to have compromised the antenna or transmission line, it may render those devices useless without any means for remedy except for full replacement.

Cap and weatherproof the second antenna connector on the radio if using a single-polarity antenna.

Indoor Mounting

On rare occasions the antenna can be mounted indoors behind a window. In these cases, there would not be a need for drip loops or an RF lightning arrestor. Use a very short transmission line connected directly between the antenna and the radio mounted nearby. The weatherproofing process can also be omitted.

RF Lightning Arrestor

RF lightning arrestors provide a direct path to ground for lightning strikes that may couple to or directly hit the outdoor transmission system or antenna structure. The RF lightning arrestor prevents any associated voltage and current from entering the radio equipment, other equipment, or humans.

The following lightning arrestors are examples of proper devices for Exalt Digital Microwave Radios:

- Polyphaser AL-LSXM
- Andrew BB-BNFE-26

Mount and ground the RF lightning arrestor in accordance to the manufacturer's recommendations. Place it as close as possible to the radio equipment. Minimize the distance to the radio to lessen the opportunity for lightning to couple to or strike the unprotected section of transmission line (if any). Consult a qualified electrician or installer in all cases of grounding and lightning arrestor implementation.

Antenna Alignment

Antennas must be installed at both ends of the planned link to commence precision alignment. Refer to the Exalt white paper, *Antenna Alignment*. The r-Series has an integrated antenna.

Antennas are typically aligned using the radio hardware for precise alignment. However, there are many very useful tools available to aid in this process, inclusive of devices specifically designed for the purpose of aligning antennas. Some examples are:

- XL Microwave Path Align-R
- Teletronics 17-402

Use of these devices may be extremely advantageous as compared to using the radio, because they employ many unique facilities to aid in this process. Using these tools also makes it possible to align the antennas before the radio equipment is delivered. However, many installers successfully use the radios as the means for antenna alignment.

The following are the primary facilities when using the radio to align the antenna:

- RSL voltage connection using a volt meter (recommended)

Insert the included adapter into the GPS connector on the radio housing and the opposite end connected to a volt meter.

The RSL test point DC voltage is inversely proportional and numerically calibrated to the received signal level. The voltage rises as the antennas are less in alignment, and falls as antennas are more in alignment. The voltage measurement corresponds to the received signal level in measurements of dBm (a negative number for RSL measurements). For example, an RSL of -60dBm yields an RSL voltage measurement of 0.60VDC; an RSL of -45dBm measures 0.45VDC.

- Audio alignment buzzer

Enable the audio alignment buzzer through the Exalt GUI. When enabled, the radio enclosure emits a sound. The pitch rises when higher (better) levels of RSL are achieved. Align the antennas until the highest pitch is accomplished. The tone is continuous when the two ends of the radio system are in communication. Otherwise, the buzzer beeps.

- Exalt GUI RSL reading indicates the current RSL in dBm.



There is a slight delay in RSL readings in the GUI as the RSL levels change. In this case, fine alignment can be done in small adjustments allowing a small gap of time so that the impact of the adjustment on the GUI display catches up to real time.



Only use the browser-based GUI for antenna alignment if there are no other means available. If this method is required, refer to Exalt Graphical User Interface (GUI) on page 35. The RSL reading can be read on a PC or any handheld computing device that supports an HTML browser and Ethernet connectivity.

Configuration and Management

This section describes the command line interface (CLI) and Exalt graphical user interface (GUI).

Telnet into the Command Line Interface (CLI)

Use a Telnet connection to access the CLI in the Exalt Digital Microwave Radios. Use the CLI to set key parameters on the system.

Connect to the Radio in a Telnet Session

Make the Telnet connection to the radio through the Ethernet port. Use Windows and perform the following steps:

1. Open a command prompt or MS-DOS prompt (**Start>Run**).
2. Type `C:\>Telnet <IP Address>` at the command line:

The default IP address is **10.0.0.1**



The accessing computer must be on the same IP subnet as the radio.

Telnet

Use Telnet when prompted to enter the administration level login and password. The default administration login is *admin* and password is *password*. It is recommended that the default administration password be reset by performing a radio reset (see [Reset to Critical Factory Settings](#) on page 27).

Figure 10 shows the three menu choices available after log in.

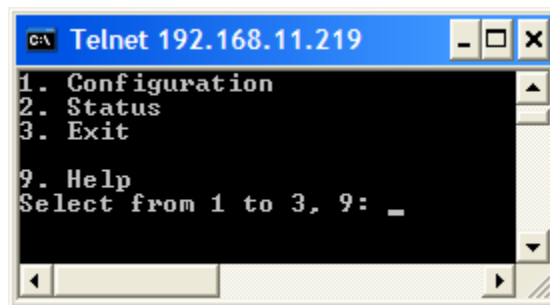

Figure 10 CLI main menu

Select 1 or 2 to display the Configuration or Status menus, respectively. Select 3 to exit the session. The following selections can be made on all screens:

- 0 = back to previous screen
- 9 = help

- Ctrl+\ (control and backslash keys) = exit session

The following depicts the complete tree structure:

1. Radio information
2. Configuration
 - a. Current IP settings
 - b. Current system configuration
 - c. Set IP address and mask (admin only)
 - d. Set IP default gateway (admin only)
 - e. Administration (admin only)
 - System time and date
 - System reboot
 - Password
 - File transfer
 - File activation
3. Status
 - Alarm summary
 - Radio alarm
 - Radio status
 - Radio performance
 - Radio performance reset (admin only)
4. Exit

Exalt Graphical User Interface (GUI)

The Exalt GUI is the primary user interface for configuring and troubleshooting the radio and radio system. A computer or hand-held device with a conventional HTML browser and Ethernet port is required. Microsoft Internet Explorer is the preferred browser. Netscape, Mozilla, and Firefox are also supported.

Preparing to Connect

If the radios are new, both radios are preconfigured as Radio B, and have the same IP address. The initial priority is to configure one radio to Radio A and assign different IP addresses, unique to each radio.

There are two ways to change the IP address:

1. Reset the radio to the critical default factory settings (see [Radio Reset](#) on page 16)

2. Connect to the GUI using the default IP address (10.0.0.1), and change the IP address through the GUI interface.



To connect to the radio's Ethernet port and use the GUI interface, the accessing computer must match the radio's IP address subnet. It is therefore necessary to either change the radio's IP address through the CLI to match the subnet of the computer, or change the computer's IP address to match the subnet of the radio (such as, a computer IP address of 10.0.0.10 if trying to connect to a radio set to the factory default IP address of 10.0.0.1).

To configure a radio as Radio A, connect to the GUI and change the configuration, as discussed in this section.

Make Connections

It is recommended that one radio at a time be configured, on a bench, before taking the radios to the field for installation:

- (EX-5r-(x)c only) Terminate the RF connector with a 50-Ohm termination or a fixed attenuator of at least 20dB (see [Terminating the RF Connector](#) on page 25).
- Apply power to the radio (see [Power](#) on page 24).



Do not connect the radios in a back-to-back configuration. If the radios are set to their factory default settings, both radios are configured as Radio B and cannot communicate. Both radios also have the same IP address, which causes IP address conflicts.



The IP address subnet of the accessing computer must match the radio's IP address subnet to connect using Ethernet (see [Preparing to Connect](#)).

Once connected to the radio using Ethernet, log in to the Exalt GUI.

Log In

Use the following steps to log in to the Exalt GUI.

1. Open a browser window.

Microsoft Internet Explorer is the recommended browser. Netscape, Mozilla, and Firefox are also supported. If there are issues with your browser, please report it to Exalt Customer Care. You may be required to use a different browser to immediately overcome issues.

2. Type the IP address of the radio in the address bar.

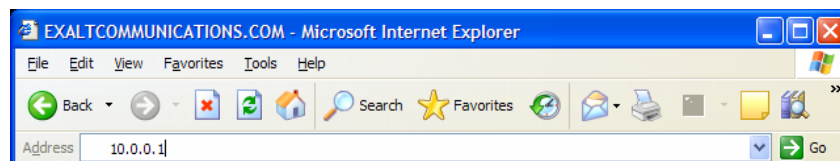

Figure 11 Initiating the browser connection

The following window displays after pressing the Enter key or clicking the Go button in the browser window.



Figure 12 Browser Login screen

Login Privileges

There are two levels of login privileges:

- Administrator (admin) – assigned complete permissions to view, edit, and configure
- User (user) – assigned limited, view-only permissions with no edit or configuration rights

The default login names and passwords are as follows:

Table 7 Default login information

Privilege level	User name	Default password
Administrator	admin	password
User	user	password

Administrator login credentials are required for configuration purposes. Type the user name and passwords for Administrator level and click OK. The following screen displays.

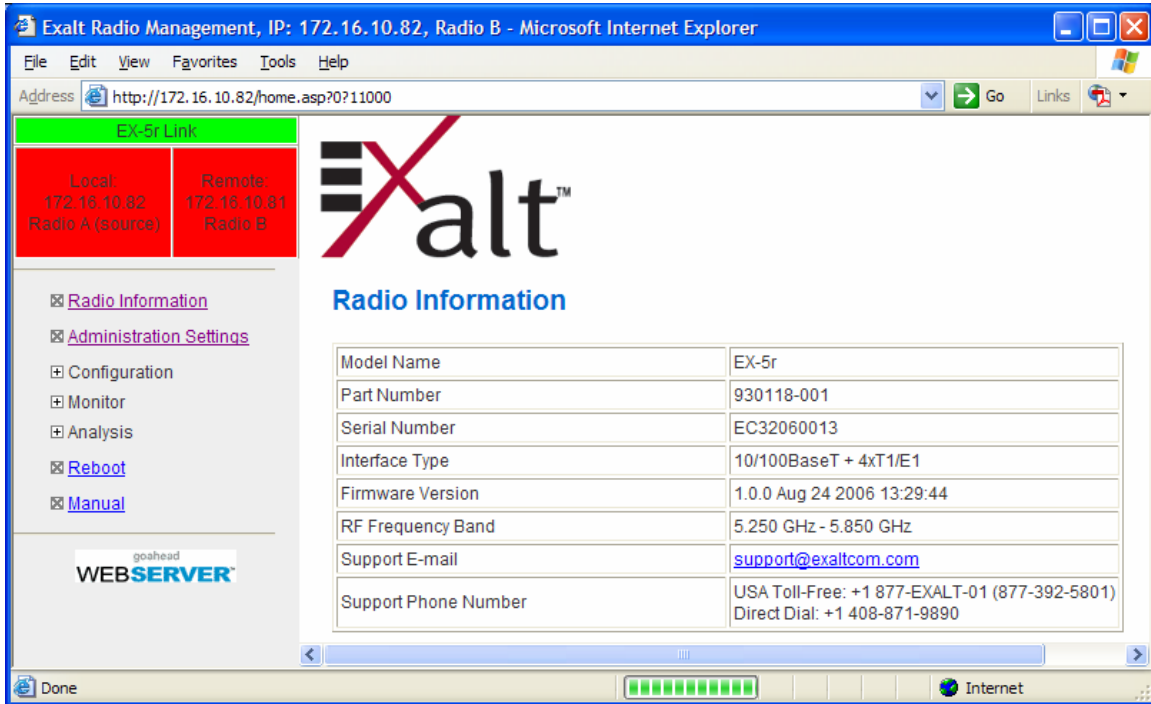

Figure 13 Radio Information page

Quick-Start

To establish a link on the bench, apply the following basic configurations to the radio terminal. Use the steps in the *Quick Start Guide* included with the radio. A summary of the items that need to be configured are:

- Radio IP address for each end.
 - Each end must have a different IP address and cannot match the accessing computer's IP address or any address assigned if radios are part of a larger network.
 - It may be required to change the IP address of the accessing computer after changing the IP address of the radio so that the IP subnet matches.
 - The radio IP address is listed on the Administration Settings page.
- Set one radio as Radio A.
 - The radio selected as Radio A must be configured.
 - Radio A/B selection is the Endpoint Identifier parameter on the System Configuration page.
 - Even though both radios are set as Radio B by default, confirm this configuration on the radio intended to be Radio B.

If all other parameters are still configured at their factory default settings, the radios can now be connected back-to-back to verify that the link is communicating and perform any other desired tests. See [Back-to-back Bench Testing](#) on page 82 for test information.

[Navigating the GUI](#) describes each page of the GUI. Most configuration parameter settings are intuitive. The following link parameters must match at both ends for the link to communicate:

- Link Security Key (Administration Settings page)
- Bandwidth (System Configuration page)
- RF Frequency (System Configuration page)
- Link Distance (System Configuration page)
- TDD Frame Size (System Configuration page)



Changing any of these parameters causes a temporary loss of link. The GUI displays a warning and provides an opportunity to cancel changes.

Navigating the GUI

The GUI provides the primary interface for all configuration and management. There are three sections of the main GUI window:

- Summary status information section (upper-left corner)
- Navigation panel
- Main window

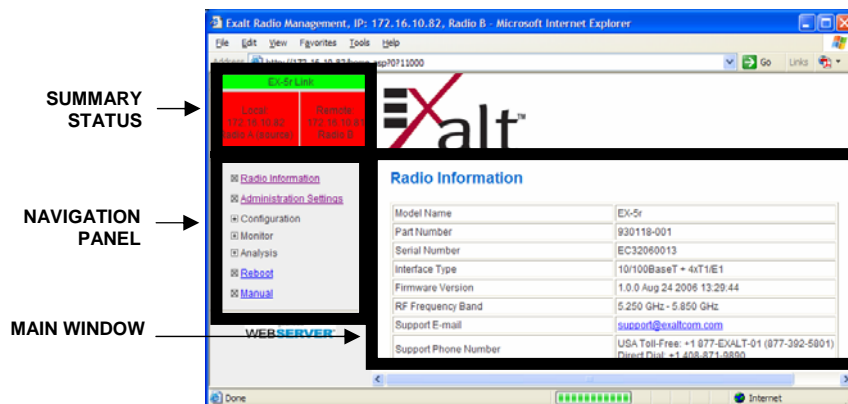

Figure 14 Exalt GUI window description

Summary Status Section

This section of the Exalt GUI provides a review of the system status.

In the screens in Figure 15, the top bar illustrates the alarm condition of the link. The information inside the bar is equivalent to the entry of the Link Name set by the administrator in the Administration Settings page (see [Administration Settings Page](#) on page 42).

The color of the panel indicates alarm status:

- Green indicates the system is communicating and all functions are normal
- Yellow indicates a minor non-traffic affecting alarm condition
- Red indicates a major traffic affecting alarm condition

The left panel summarizes the alarm conditions of the local radio (the radio that matches the IP address). The information displayed is the IP address and the endpoint identifier (Radio A or Radio B). The right panel summarizes the alarm conditions of the remote radio (the radio linked to the local radio).



The **'local' radio might be the near-end or the far-end radio**, depending on the management interface connection. The terms local and remote refer to the orientation of the radio terminals relative to the IP address you are managing. When making certain changes to a near-end radio without first making changes to the far-end radio, the link may become disconnected unless configuration changes are reverted to their original settings. When making changes that may disrupt the link, **always change the far-end radio first, and then the near-end radio to match.**

The Summary Status Section allows the Exalt GUI to be a rudimentary management system. Minimize the browser window to display just the top bar or the top bar and radio information, and open several browsers on the desktop. When a window status changes to yellow or red, you can quickly maximize that window to determine the issues.

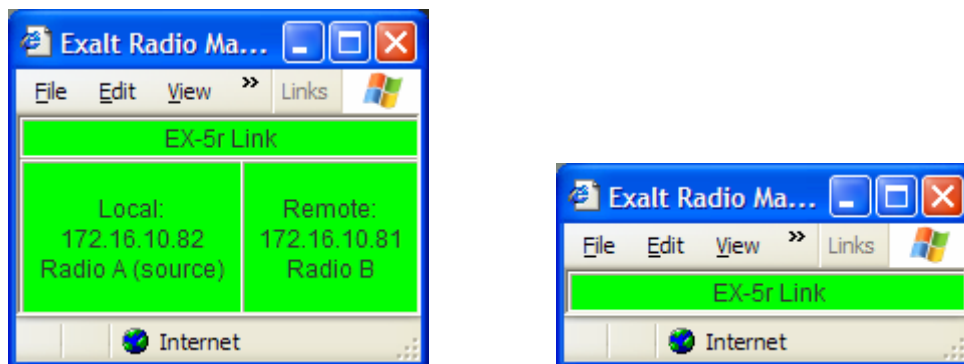

Figure 15 Summary status information

Navigation Panel

In the navigation panel, pages with sub-pages have a plus (+) to the left of the page link. Click the plus sign or page name title to view sub-page titles. The pages can be collapsed to hide the sub-pages when a minus (–) sign appears to the left of the page link.

Management pages are indicated with an X to the left of the page name. Click the X or page name to display the page within the main window.

Radio Information Page

This page provides general information about the local radio terminal. This information is helpful for troubleshooting and for record keeping.

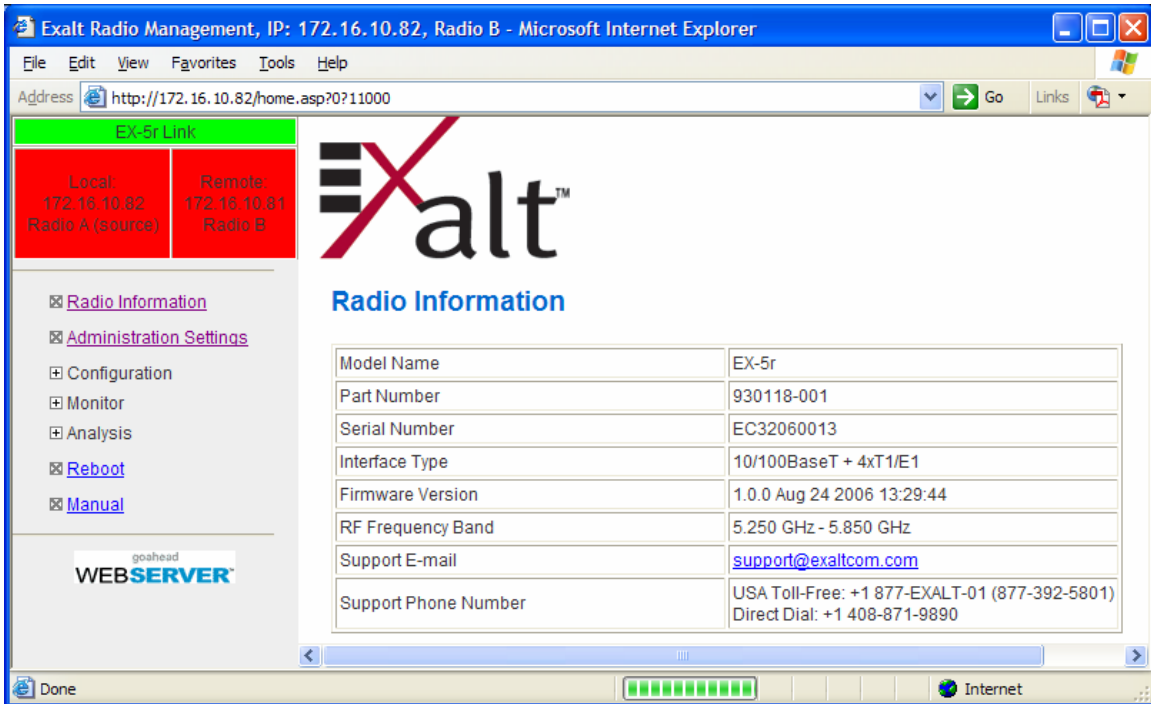

Figure 16 Radio Information page

Administration Settings Page

This page allows contains general parameters for the radio system. The Current Value column lists entries actual settings. Desired changes are entered in the New Value column.

After all desired changes are entered, click the **Update** button to accept and enable changes.

	Current Value	New Value
Date (mm/dd/yyyy)	09/01/2006	<input type="text"/> / <input type="text"/> / <input type="text"/>
Time (hh:mm:ss 24h)	07:34:49	<input type="text"/> : <input type="text"/> : <input type="text"/>
Radio Name	Radio B	<input type="text"/>
Link Name	EX-5r Link	<input type="text"/>
Link Security Key	000000000000	<input type="text"/>
Admin Password	*****	<input type="text"/>
Confirm Admin Password	*****	<input type="text"/>
User Password	*****	<input type="text"/>
Confirm User Password	*****	<input type="text"/>
IP Address	172.16.10.82	<input type="text"/>
IP Mask	255.255.0.0	<input type="text"/>
Default Gateway	172.16.1.1	<input type="text"/>
License Key	000000-000000-000000	<input type="text"/> - <input type="text"/> - <input type="text"/>

Figure 17 Administration Settings page

Most entries on this page are self-explanatory. The following lists unique or important parameters.

- Fill in the date and time fields as soon as practical. Events are captured with time/date stamps, which is valuable information for troubleshooting.
- Set the Link Security Key to something other than the factory default setting (12 characters, all zeros) at each end. The link security key must match at both sides of the link. If the

security key remains at the factory setting, the radio link is open to sabotage by a party with the same radio model. Each link should have a unique security key. If using the same security key for every link in the network, the radio could link to any other radio with the same security key. This is problematic in multi-radio networks.

- Note that the security key must be exactly 12 characters. Any printable ASCII character can be used. The link security key is case sensitive.



Changing the link security key interrupts transmission until the opposite end is changed to match. **Always change the far-end radio first, and then change the near-end radio.**

- Reset the admin and user passwords. These passwords should not match. If the admin password remains at the factory default setting, it provides an opportunity for random reassignment by a network-connected user.
 - The new password must be entered twice: once in the main window and again in the confirmation window. If the passwords do not match and the Update button clicked, the password is not changed and remains set to the previous password.
- The License Key is set to all zeros. Enter the license key provided by Exalt to access extended features or diagnostic capabilities. Click **Update** to accept the changes and enable the new features. License keys are issued by radio serial number, so ensure that the license key used was issued for this particular radio.

System Configuration Page

This page contains several critical system parameters.

	Current Value	New Value
Radio Transmit Power (dBm)	13	13
Bandwidth (MHz)	32	32
Mode	Mode 2 (16QAM)	Mode 2 (16QAM)
RF Frequency (GHz)	5.277	Select Frequency Band: <input checked="" type="radio"/> 5.3 <input type="radio"/> 5.4 <input type="radio"/> 5.8 Select Frequency: <input type="radio"/> Preferred <input checked="" type="radio"/> All 5.277
Endpoint Identifier	Radio A	Radio A
Link Distance (miles)	< 2	< 2
TDD Frame Size (ms)	2.0	2.0
Antenna Port	Port A	Port A
Buzzer Timeout (min)	off	Off

Figure 18 System Configuration page

Most entries on this page are self-explanatory. The following lists unique or important parameters.

- Set the Radio Transmit Power (dBm) parameter to the designed level. The professional installer sets this value or dictates the value of this setting to the system administrator following the system design and local regulations. In many cases, this value must be set to a proper value to comply with legal restrictions. Improper values can result in liability to the user and/or installer.



Changing Radio Transmit Power *may temporarily interrupt traffic.* Small changes in output power do not normally interrupt traffic, but larger changes may.

- Do not adjust the Radio Transmit Power parameter to a value higher than is legally allowed.
- Do not adjust the Radio Transmit Power parameter lower than the link budget and fade margin can afford.

The link may be lost and unrecoverable through GUI control. If the link is lost due to reduction of Radio Transmit Power, travel to the radio location(s) may be required to reset the value.

- Set the Bandwidth (MHz) parameter to the designed level. The value of this is determined in the design/engineering stage. The Bandwidth parameter must also match at both ends of the link. In conjunction with the Mode parameter, the Bandwidth parameter directly relates to the capacity, latency, and the number of TDM circuits supported. The transmitter and receiver bandwidth are modified using this parameter, making it critical that it be set with respect to the local RF noise and interference profile, and/or in relation to any multi-link network design.



Changing Bandwidth will temporarily interrupt traffic. The Bandwidth parameter must match at each end. Adjust the far-end radio first, and then the near-end radio. Changing Bandwidth changes the radio's threshold. A narrower bandwidth has better threshold performance and improved interference immunity, therefore if changing to a wider bandwidth, there is an opportunity that the link may be lost and unrecoverable through GUI control. Check the available fade margin and interference profile to determine if the impact to threshold and increased bandwidth is acceptable to maintain the link and the desired performance. If the link is lost due to increasing the Bandwidth parameter, travel to the radio location(s) may be required to reset the value.

- Set the Mode parameter to the designed selection. The value of this setting is determined in the design/engineering stage. The Mode parameter must match at both ends of the link. In conjunction with the Bandwidth parameter, the Mode parameter setting directly relates to the capacity of the system, as well as critical RF parameters, including receiver threshold, carrier-to-interference ratio, and in some cases, maximum radio transmit power.



Changing Mode will temporarily interrupt traffic. The Mode setting must match at each end. Adjust the far-end radio first, and then the near-end radio. Changing Mode changes the radio's threshold, carrier-to-interference ratio, and also may have impact on the Radio Transmit Power. A lower mode has better threshold performance and carrier-to-interference ratio, and in some cases, higher output power, therefore if changing to a higher mode (for example, from Mode 1 to Mode 2), there is an opportunity that **the link may be lost and unrecoverable** through GUI control. Check the available fade margin and interference profile, and determine if the impact to RF performance is sufficient to maintain the link and desired performance. If the link is lost due to increasing the Mode parameter, travel to the radio location(s) may be required to reset the value.

- Set the RF Frequency (GHz) parameter to the designed point. The value of this setting is determined in the design/engineering stage. RF Frequency must match at both ends of the link. It may be critical to set RF Frequency with respect to the local RF noise and interference profiles, and/or in relation to any multi-link network design.

The frequency selection section includes the ability to select from either the complete list of frequencies (“All”) that can be tuned for the selected band and bandwidth, or a pre-selected list of non-overlapping center frequencies (“Preferred”) that Exalt determined provides the most flexible collocation opportunities for large networks of Exalt radios

The frequency selection section includes a band selection button that must be enabled for the frequency band of operation for which the link was engineered. In some cases, some bands may not be selectable due to regulatory constraints.



Changing RF Frequency will temporarily interrupt traffic. The RF Frequency parameter setting must match at each end. Adjust the far-end radio first, and then the near-end radio. If the RF Frequency parameter is changed to a frequency with interference, the link may be lost and unrecoverable through GUI control. If the link is lost due to changing the RF Frequency parameter, travel to the radio location(s) may be required to reset the value.

- Set the Endpoint Identifier so that one end of the link is set to Radio A and the opposite end set to Radio B. In single-link networks, it is unimportant which end is designated A or B. In multi-link networks, however, it may be important to orient the links so that at any collocation site (where there are multiple radios of the same type at the same site), all radios are set to the same Endpoint Identifier (A or B). See [Link Orientation and Synchronization](#) on page 15.



Changing Endpoint Identifier parameter requires a reboot of the radio to take effect. The reboot temporarily interrupts traffic.

- Set the Link Distance (miles) parameter to the range that is equal to or greater than the actual link distance. The value of this setting is determined in the design/engineering stage.



Changing Link Distance parameter will temporarily interrupt traffic. The Link Distance setting must match at each end and must not be less than the actual link distance. Adjust the far-end radio first, and then the near-end radio. If the Link Distance parameter is changed to a setting less than the actual distance, the link may be lost and unrecoverable through GUI control. If the link is lost due to this situation, travel to the radio location(s) may be required to reset the value. If the Link Distance parameter setting is set to a distance unnecessarily higher than the actual link distance, the radio may have substantially reduced performance with respect to throughput and latency.

- Set the TDD Frame Size (ms) parameter to the designed level. The value of this setting is determined in the design/engineering stage. The TDD Frame Size parameter must match at both ends of the link. The TDD Frame Size parameter setting directly relates to the capacity,

latency, and number of TDM circuits that can be supported over the given link distance. In multi-link networks, especially where there are collocated links, it is also important to set all radios to the same TDD Frame Size setting to avoid self-interference. **Future enhancement:** The GPS or internal sync function may be necessary for these networks. See The professional installer is responsible to ensure that RF output power is properly adjusted so that it does not exceed the regulatory limit of these conditions.

ETSI Compliance – EIRP limits

For the EX-5r family, a +30dBm EIRP limit applies for operation in the 5250-5350 MHz or 5470-5725 MHz bands. Adjust the output power in accordance with the following formula:

$$P = 30 - G + L$$

where:

P = Maximum transmitter output power of radio, in dBm

G = Specified gain of antenna, in dBi within the operational band

L = Total transmission system losses of all elements between the radio's RF connector and the antenna's RF connector (all cables, connectors, lightning suppressors), in dB, as specified or measured in the operational band

For the EX-5r family, operation in the 5725-5850 MHz band, using a 10 MHz BW setting (shown as 8MHz in the GUI), a +33dBm EIRP limit applies. Using the same definitions as above, set the transmitter according to this equation:

$$P = 33 - G + L$$

For the EX-5r family, operation in the 5725-5850 MHz band, using a 20 MHz BW setting (shown as 16 MHz in the GUI), a +36dBm EIRP limit applies. Using the same definitions as above, set the transmitter according to this equation:

$$P = 36 - G + L$$

- Time Division Duplex (TDD) Factors and Link Orientation and Synchronization for more information.



Changing the TDD Frame Size parameter *will temporarily interrupt traffic.* TDD Frame Size parameters must match at each end. Adjust the far-end radio first, and then the near-end radio. If the TDD Frame Size parameter is set to a value that cannot be supported for the link distance, **the link may be lost and unrecoverable** through GUI control. If the link is lost due to this situation, travel to the radio location(s) may be required to reset the value.

- Antenna Port parameter

- r-c Series only: The antenna port selection allows selection of either the A or B connector on the front face of the radio housing. Only set this parameter if using a dual-polarized antenna or two separate antennas.
- r-Series only: The antenna port selection toggles between the vertically and horizontally polarized integrated antennas. Ensure that both link ends match polarization.



Changing antenna port will temporarily interrupt traffic. The polarization of the antennas at each end must match at each end – adjust the far-end radio first, then the near-end radio.

- Buzzer Timeout (minutes) parameter creates an audio signal for antenna alignment. Turn on the buzzer continuously during antenna alignment or preset a period of time that the buzzer will sound. If the buzzer stops before alignment activities are complete, change the selection and press the Update button or select the ON option until alignment activities are complete.

Ethernet Interface Configuration Page

This page allows the administrator to set the alarm, and duplex settings of the Ethernet connection.

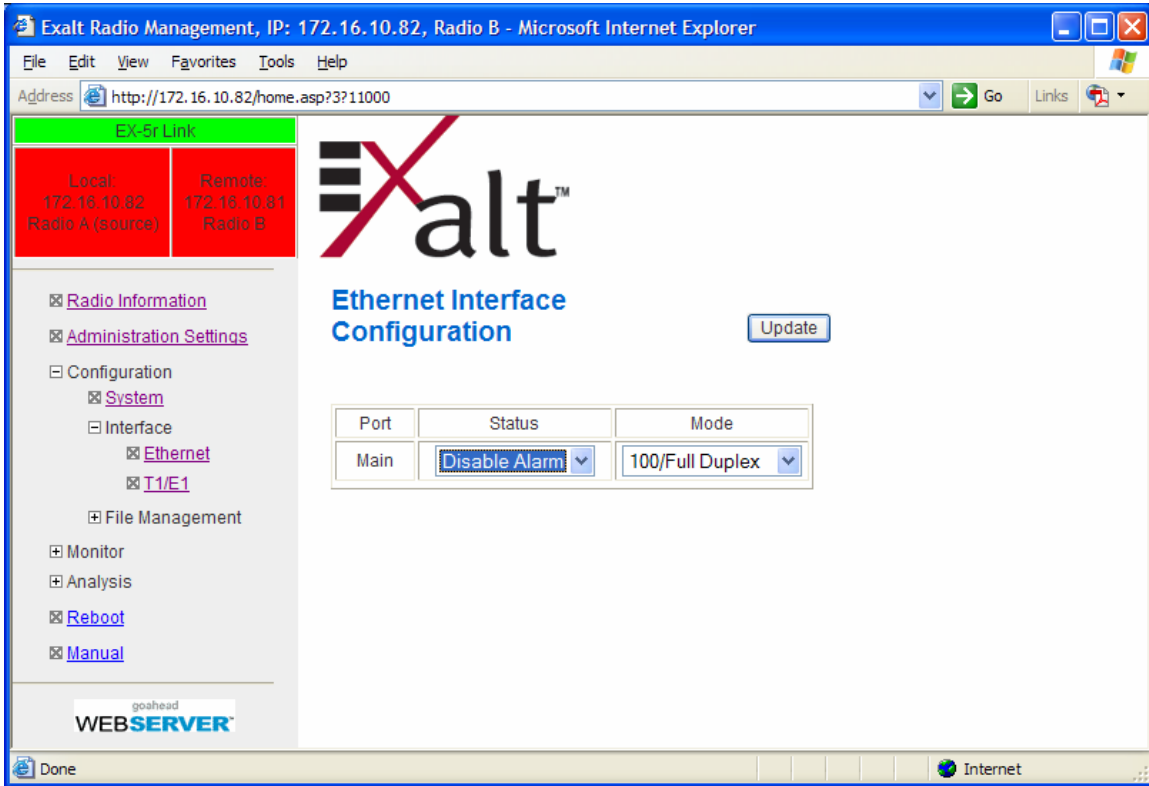

Figure 19 Ethernet Interface Configuration page

To ignore Ethernet alarms, disable the alarming of the MAIN connector.

Set the Ethernet interfaces on the radio and connected equipment to 100/full-duplex for best performance. If the Ethernet ports are set to auto-negotiation, poor throughput performance may be a result, as well as intermittent disconnections of the Ethernet connection.

T1/E1 Configuration Pages

These pages allow the administrator to selectively enable or disable the T1 or E1 circuits, one at a time. For enabled T1/E1 circuits, additional configuration, including loopback functions, are available. Disable the unused T1 or E1 so that the alarms are turned off and more throughput is allocated to the Ethernet interface. Every enabled T1 or E1 input, even if there is no T1 or E1 signal present, reduces the aggregate throughput of the Ethernet interface by roughly 3Mbps (for T1) or 4Mbps (for E1).

This page toggles between T1 and E1, as required, by clicking the Set to T1 or Set to E1 button. A warning displays that a reboot is necessary, and the radio reboots if the administrator continues. *This will interrupt traffic.* It may be necessary to re-login to the radio after the reboot completes. T1/E1 mode self-coordinates across the link if the link is active. This means that it only needs to be set while connected at one end. In addition, enabling and disabling T1/E1 circuits also self-coordinates across the link if the link is active. If a link is not active and T1/E1 enabling is a mismatch when a link is first created, the Radio A configuration for T1/E1 enabling supersedes the settings on the Radio B configuration, and changes the settings on Radio B.



Certain combinations of the TDD Frame Size, Link Distance, Mode, and Bandwidth parameter settings limit the number of T1/E1 circuits that can be carried by the radio. In these cases, certain fields on the T1/E1 Interface Configuration pages are not available, starting with the highest port number. For example, for a 4x T1/E1 radio version, if only three (3) circuits can be carried, port 4 is not available for configuration and is disabled. If only two circuits can be carried, both ports 3 and 4 are not available. Increasing the TDD frame size and Mode parameters, and/or increasing the Bandwidth parameter results in an increase in the supported number of T1/E1 circuits. For '-16' models, the highest number channels that are configurable (based on the currently installed license key) are disabled if they cannot be supported with the current settings.

T1 Interface Configuration Page

This page allows the administrator to enable/disable each individual T1 channel, set the Line Build Out (LBO), Line Code (either AMI or B8ZS), and AIS enabling/disabling for each input. If enabled, the radio places an AIS code on the output of the associated interface if and when the link fails or when there is no T1 signal available from the far end to provide the user at the local end. Loopback controls are also provided (see [T1/E1 Loopback](#) on page 52).

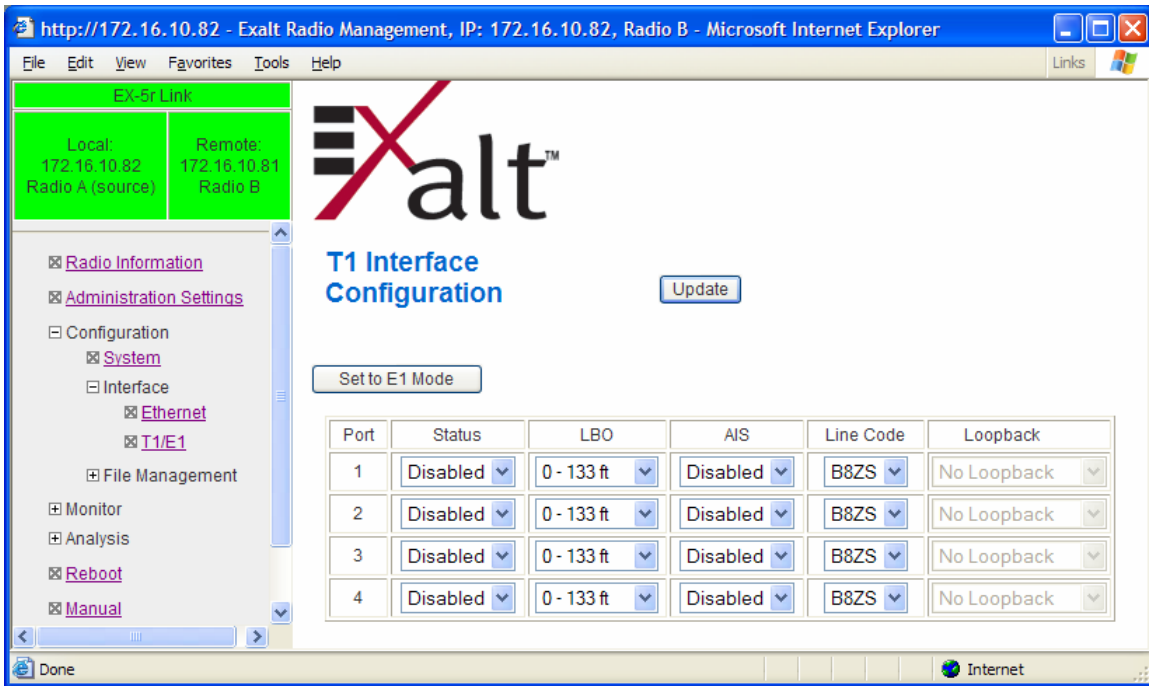

Figure 20 T1 Interface Configuration page

E1 Interface Configuration Page

This page allows the administrator to enable/disable each individual E1 channel. The AIS can also be enabled and disabled for each input. If enabled, the radio places an AIS code on the output of the associated interface if and when the link fails or when there is no E1 signal available from the far end to provide the user at the local end. Loopback controls are also provided (see [T1/E1 Loopback](#)).

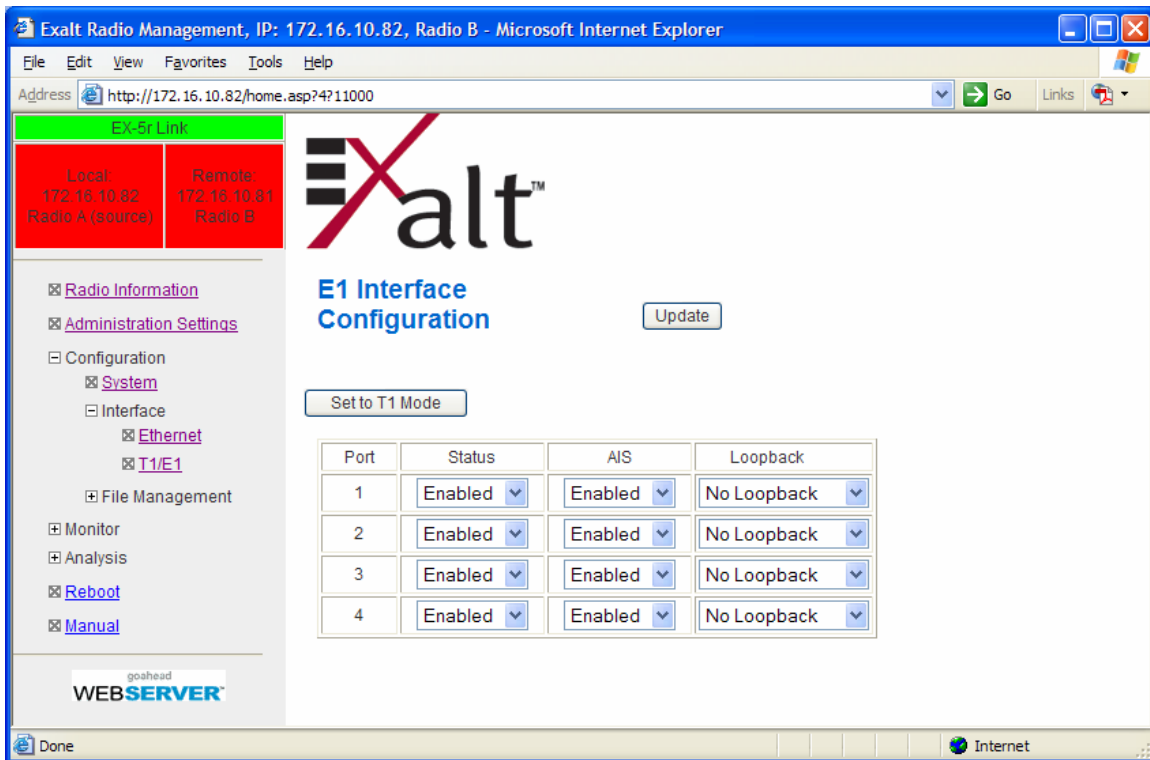

Figure 21 E1 Interface Configuration page

T1/E1 Loopback

Loopback is provided for any enabled T1 or E1 port. As shown in Figure 22 and Figure 23, the choices are:

- No Loopback (default)
- External (local)
- External (remote)
- Internal



Only one Internal loopback can be enabled at any time.

All loopback configurations control the loop at the Line Interface integrated circuit, which is the device wired directly to the front panel ports.

External loopback modes are used in conjunction with an external test source. The designation of ‘local’ or ‘remote’ refers to where the loopback is occurring relative to the location where the loopback is implemented. That is, on the radio being accessed, if External (remote) is selected, this loops the signal back at the remote radio interface back towards the local radio. Likewise, if External (local) is selected, the signal loops back at the local interface towards the remote radio (Figure 22 and Figure 23).

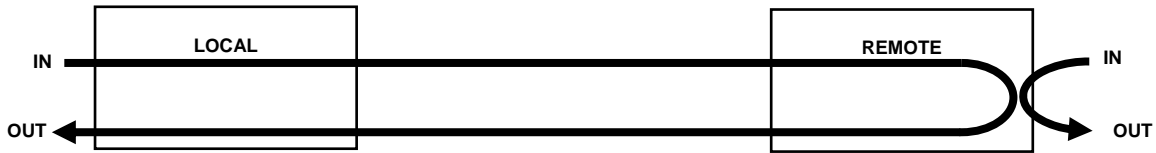

Figure 22 External (remote) loopback

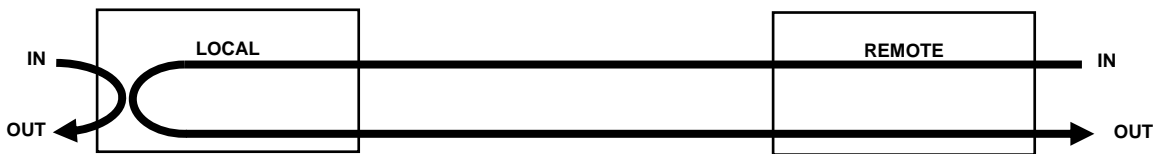

Figure 23 External (local) loopback

When a local T1/E1 port is configured for External (remote) loopback, it is the same as configuring the remote radio for External (local) loopback.

Internal loopback uses an internal test source, and sends the test source signal across the link, looped at the remote radio’s interface, returned to the local radio, and looped at the local radio’s interface back to the source. The inputs at both ends are looped back at the line level. Figure 24 illustrates the internal loopback function.

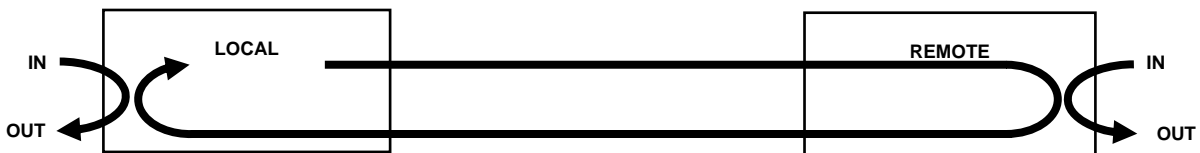

Figure 24 Internal loopback

File Transfer Page

This page allows the administrator to upload and download files to and from the radio. Two types of files can be uploaded: configuration and radio firmware. **When uploading Configuration Files, current configuration parameters are immediately overwritten, and the unit automatically reboots.** When uploading radio firmware files, the file is placed into reserve memory space. After the new radio firmware file uploads, use the File Activation page to enable the files (see [File Activation Page](#) on page 57).

Up to three types of files can be downloaded: configuration, radio firmware, and MIB. The MIB file refers to the Management Information Base related to the Simple Network Management Protocol (SNMP) function, and is only available on models which support SNMP. See [Simple Network Management Protocol \(SNMP\)](#) on page 58 for more information.



Check the File Activation page before uploading radio firmware files. New file uploads overwrite the secondary file location. If important files reside in the primary or secondary file location, download them before uploading the new files. Only the active radio firmware file can be downloaded. Therefore, to download the reserve file, it must first be activated (using the Swap button). See [File Activation Page](#) on page 57.

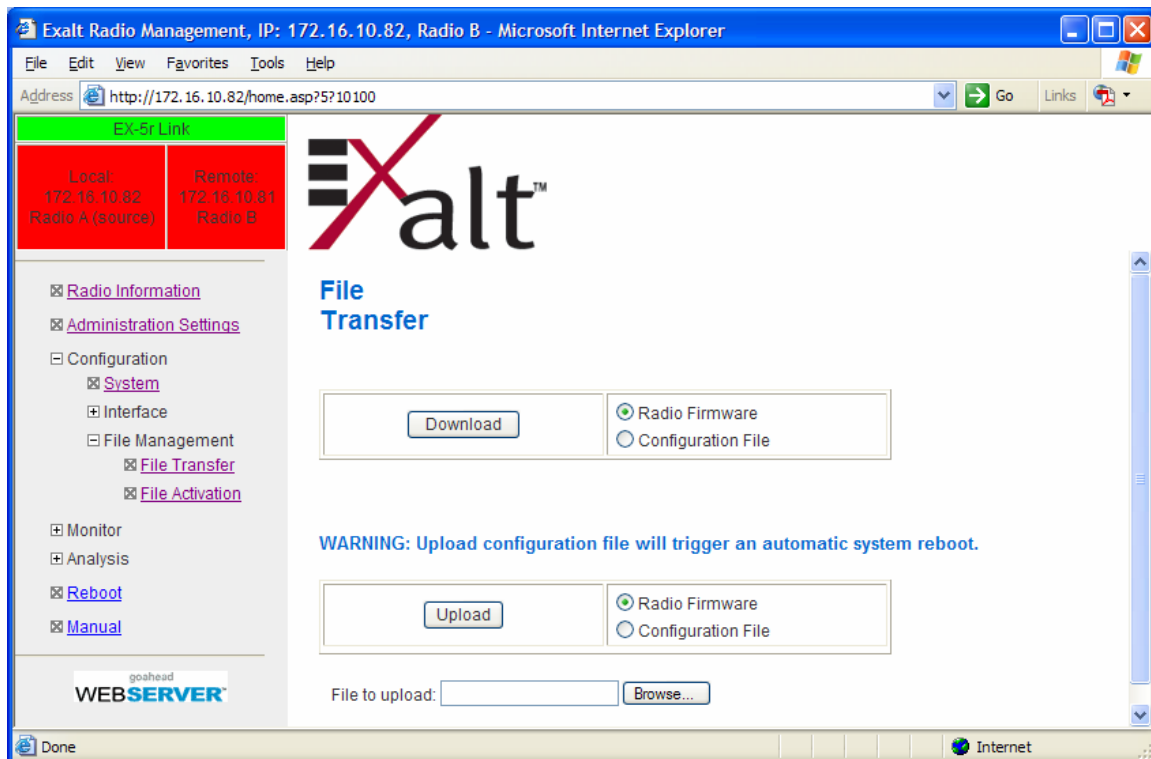

Figure 25 File Transfer page

Use the following steps to download a file.

1. Select the type of file to download (configuration or radio firmware).
2. Click the **Download** button and wait for the radio to prepare the file for download.
For the MIB file download, a second page/link appears (Figure 26).
3. Left-click the link on the page to download the file to a desired location.

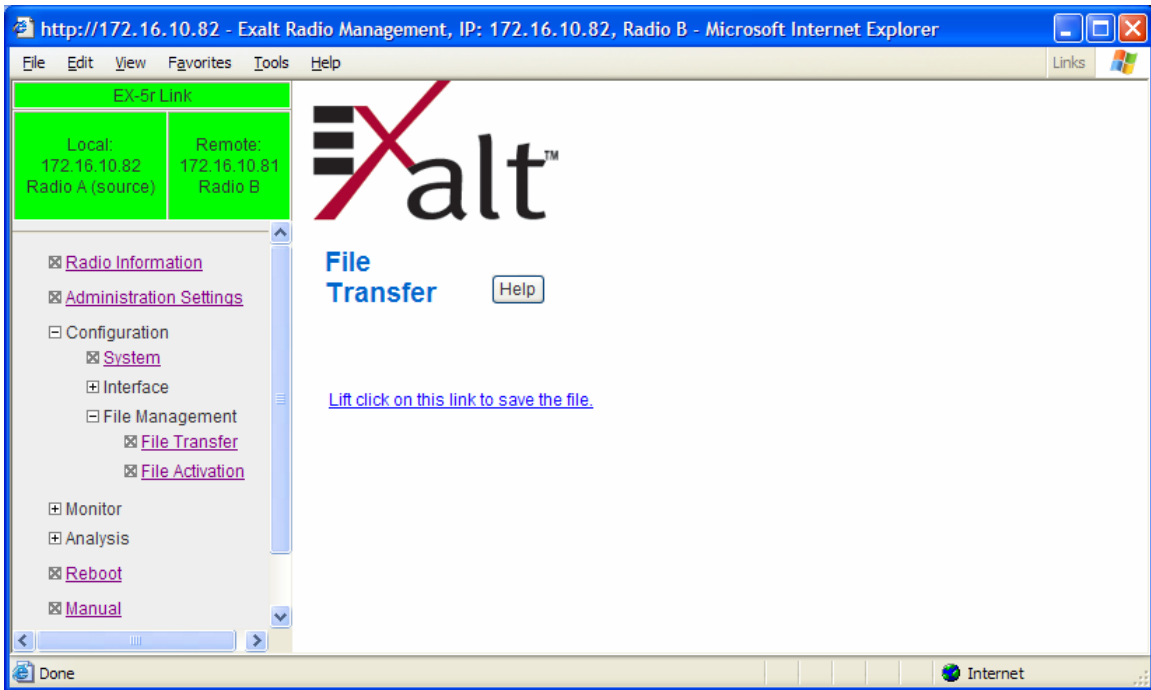

Figure 26 File Transfer page—download file link

File download and upload is useful when configuring several radios with similar settings. A copy of the configuration file can also help restore radio settings. In addition, a copy of the Exalt default configuration file is helpful to restore the radio to factory settings.



Do not change the name of any download file. The configuration file must be named config.nv. To keep track of multiple configuration files, use a folder naming system or temporarily rename the file, however, it must be named config.nv before it can be uploaded to a radio. Never change radio firmware file names under any circumstances.

If copying the same configuration file into multiple radios, take as some parameters will match and that may be undesirable. However, it may be easier to change just a subset of parameters rather than every parameter. The following parameters can cause problems or confusion if they match at each of a link:

- Radio Name

- Endpoint Identifier
- IP Address
- IP Subnet Mask
- Default Gateway

The following parameters can match at both ends of the link:

- Link Name
- Link Security Key (although each link should be different)
- Admin and User passwords
- Bandwidth
- RF Frequency
- Link Distance
- TDD Frame Size
- T1/E1 configurations
- Ethernet configurations

File Activation Page

Use this page to move stored or uploaded files for use on the radio. The page indicates which file is currently in use, and which file is available for use. Click the Swap button to place the file in the Alternative File column into the active state and move the file in the Current File column to the Alternative File column.

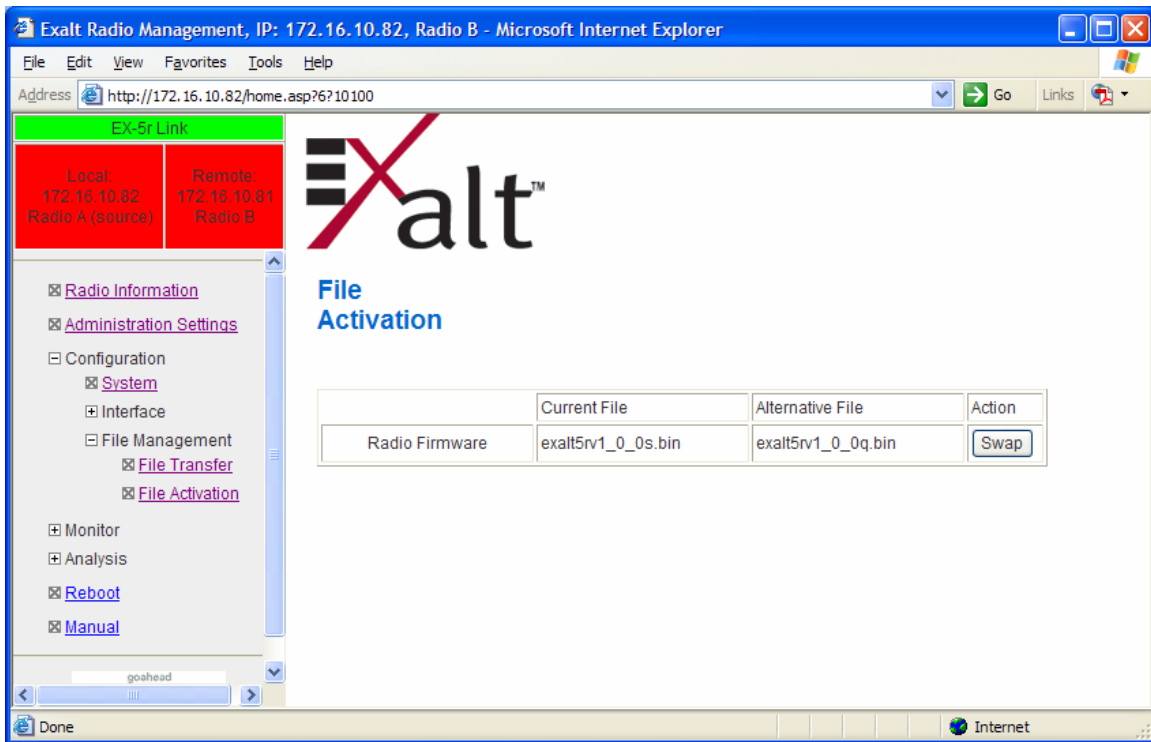

Figure 27 File Activation page



In all cases, the radio reboots after a new file is selected using the Swap function. This places the radio out of service for a short time.

Simple Network Management Protocol (SNMP) Configuration

Use SNMP to manage networked devices and execute the following functions:

- GET: Obtain information from the device, such as a configuration setting or parameter.
- SET: Change a configuration setting on the device.
- TRAP: The device proactively informs the management station of a change of state, usually used for critical alarms or warnings.



Currently the SNMP implementation does not support TRAP functions. For critical alarms, use the GET command for specific alarm conditions.

One feature of the SNMP implementation is that system configuration changes do not take effect using the SET command. Instead, groups of configuration settings can be preconfigured for global change, and a single 'Save' (Commit) command implements all changes.

When some parameters are changed, a link may drop and/or management control lost. MIB files allow many parameters to be set at once, allowing only a temporarily dropped link or management control issue. The opposite end radio can be quickly reconfigured, with little downtime for the link and management control. The save (Commit) command is similar to the Update button.

Dropped links or management control issues do not occur with every parameter change. Many configuration changes do not impact traffic or management access.

EX-series radios utilize SNMPv3, a high security version of SNMP, to ensure secure access to and storing of management data. The SNMPv3 security string matches the admin and user passwords. Passwords must be eight characters or longer.



Currently not all EX-series radios implement SNMP. Check the software release notes to verify that the function is available. Generally, the radio supports SNMP when MIB files are listed on the [File Activation Page](#).

The SNMP MIBs are organized similar to the GUI. Become familiar with the GUI before using the SNMP function.

Alarms Page

This page provides an easy-to-read summary of the alarm status of both local and remote radios. The colors on this page reflect the color of the alarms displayed on the radio front panel. However, additional detail displays on this page to aid in quick assessment of issues and status.

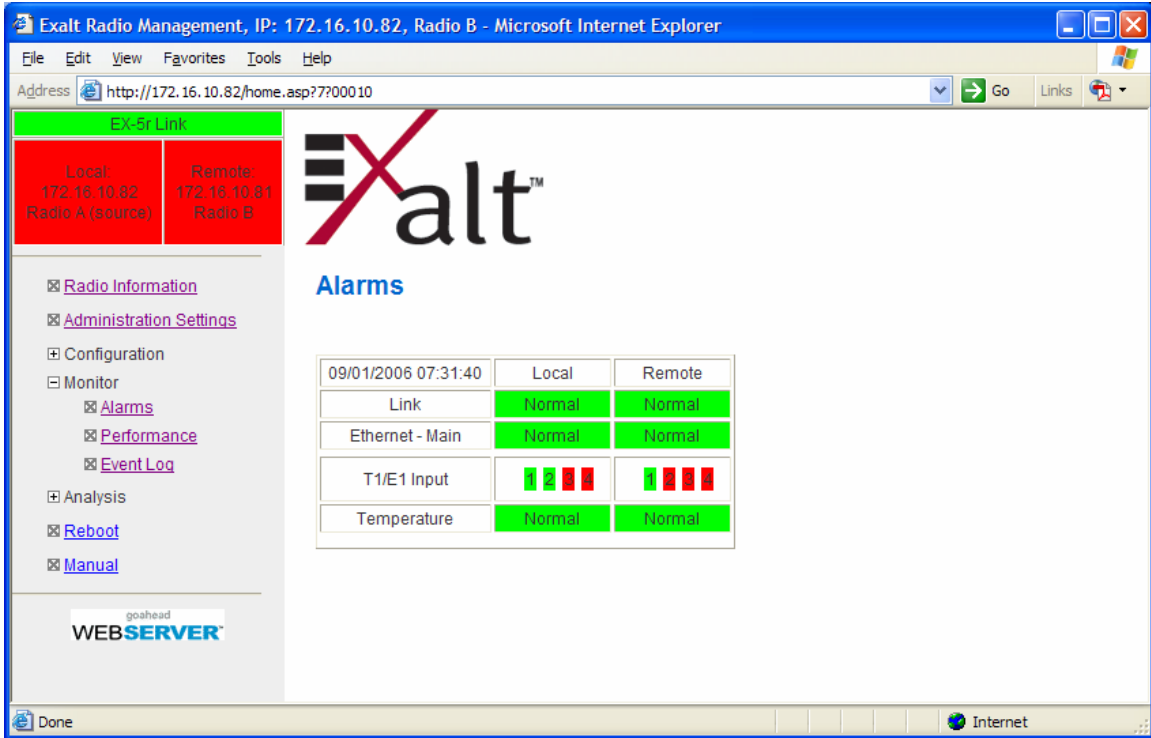

Figure 28 Alarms page

Table 8 lists alarm status conditions that appear on this page.

Table 8 Alarm status indicators

Label	Status
Link	Indicates RF link status: Green Solid = Error-free connection (BER<10e-6) Yellow Solid = Errored connection (10e-3>BER >10e-6) Red Solid = No link (BER>10e-3)
Ethernet Main	Green Solid = Data present Off = No data present

Label	Status
T1/E1 Input	Green = Enabled and connection present (clocking confirmed) Red = Enabled and no connection present Grey = Disabled or unavailable due to configuration
Temperature	Green Solid = Normal temperature range Yellow Solid = Exceeding normal temperature range

The Temperature alarm monitors the internal temperature of the unit based on specific points inside the radio chassis. It is normal for the internal temperature to be above the ambient temperature, so the temperature reading may be higher than the highest specified ambient temperature. When the internal electronics reach a point that is higher than the normal temperature rise at the highest ambient temperature, the temperature alarm turns yellow. Power down the radio as soon as possible, and investigate the cause of the temperature rise before the radio is put back into service. In almost all cases, a temperature alarm is due to an external cause.

Performance Page

This page provides statistical information about the performance of the system in relation to the integrity of the user data and the RF link.

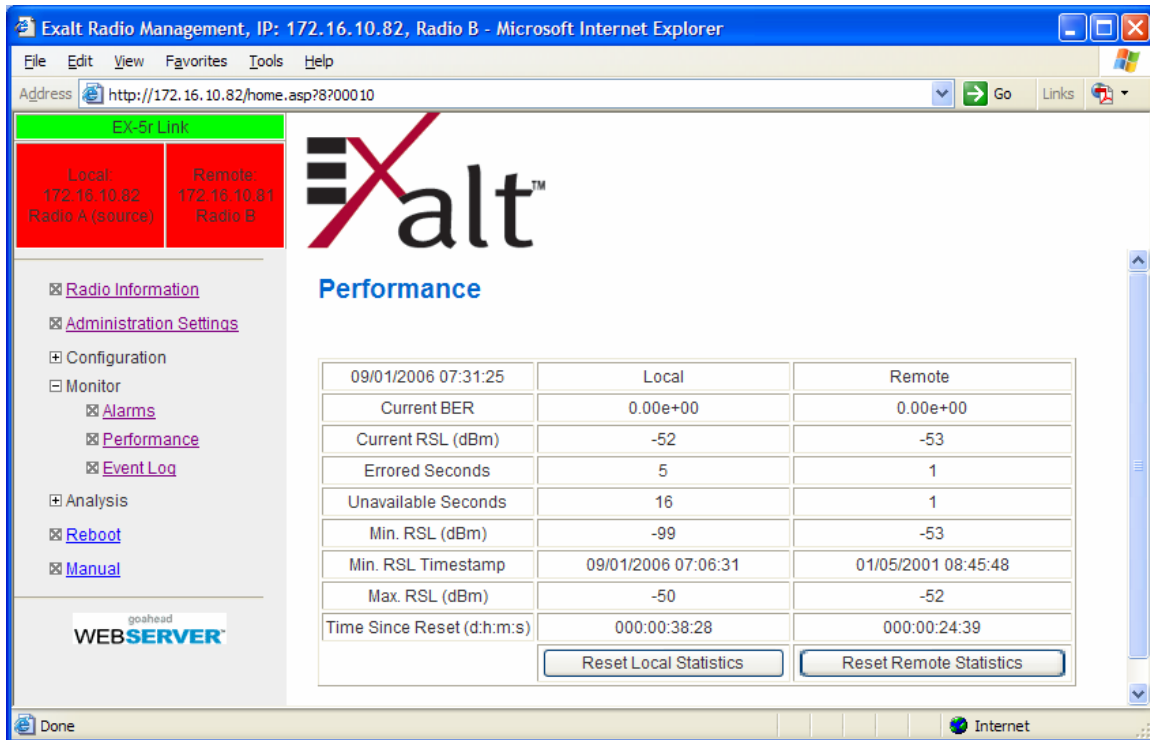

Figure 29 Performance page

- The Current BER field indicates the current bit error rate of the link. If the link is operating perfectly, this should indicate zero. Generally, the link should remain at a BER less than 1×10^{-6} (1 bit out of every million bits errored). This is the threshold performance specification and the standard to which the link was engineered. However, radio links can and are affected by weather, interference, and other external sources and will occasionally have a higher error rate. A link remains operational unless the BER exceeds 1×10^{-3} (1 bit out of every hundred bits errored). Consult the link design engineer for an understanding of the predicted error rate of the radio link as it has been designed. Many applications are unaffected by bit errors, but TDM circuits (for example, T1 or E1) are more sensitive. Also, if the link operator is providing a service guarantee, this value may need to be monitored or examined in cases of service issues. The behavior of BER in relation to other alarms or measurements and external events can be very helpful in troubleshooting activities.
- Current RSL is the measurement of the received signal level at the radio antenna port. This is the measured level of the RF signal coming from the opposite end of the radio link. The link was engineered to a specific RSL by the link design engineer, and this RSL should be obtained during installation and remain relatively stable during the operation of the link. RSL

can and will vary as a result of weather changes and other external sources, such as path obstructions. Once again, this variation was part of the original design to achieve a certain level of performance over time. Bit errors occur when the RSL falls to a level within roughly 3dB of the threshold specification. When the RSL falls below the threshold specification, the link disconnects and will not reconnect until the RSL is above the threshold specification. The behavior of RSL in relation to other alarms or measurements and external events can be very helpful in troubleshooting activities.

- Errored Seconds (ES) indicates the total number of seconds that occurred where there was at least one bit error since the last time that the radio statistics counter was reset. Generally, ES are not a significant concern, so long as they are not continuous or above the anticipated performance based on the original link engineering goals. If ES are continuous or at a high rate, this is normally an indication of poor link performance due to poor RSL or interference, or severe impact by weather or other environmental factors. However, similar to the performance factors previously listed, ES can and will occur in any radio link. Once again, consult the link engineer to determine the original design goals, and compare actual performance to these expectations to determine if any improvements are necessary or if other problems may be causing excessive ES.



Unavailable Seconds do not register as ES. In other words, the ES counter counts all seconds that are errored NOT INCLUDING the seconds that were classified as unavailable. The total number of seconds with errors or outages is the sum of ES and Unavailable Seconds.

- Unavailable Seconds (also called UAS) are similar to ES, but this counter keeps track of every second where the bit error rate equals or exceeds 1×10^{-3} , as well as any seconds where there is a complete loss of radio communication, over the period since the last counter reset. If Unavailable Seconds are continuous or at a high rate, this is normally an indication of poor link performance due to poor RSL or interference, or severe impact by weather or other environmental factors. However, similar to the performance factors listed above, Unavailable Seconds can and do occur in any radio link. Consult the link engineer to determine the original design goals, and compare actual performance to these expectations to determine if any improvements are necessary or if other problems may be causing excessive Unavailable Seconds.
- Minimum RSL indicates the worst (lowest) received signal level that occurred since the last counter reset. It is helpful to know if the RSL dropped significantly from the normal level, or has reached a level near or below threshold.
- Minimum RSL Timestamp indicates the date and time when the Minimum RSL occurred. This is helpful for general troubleshooting, and especially comparing to items in the event log or diagnostic charts from the same time period.
- Maximum RSL indicates the best (highest) RSL that occurred since the last counter reset. This indicates the best performance of the radio link, which is normally equal to the installed value, and is usually the designed value.

- Time Since Reset indicates the amount of time passed since the last counter reset. This helps to quantify the seriousness of other statistics, such as ES and Unavailable Seconds, if there have been high numbers of ES and/or Unavailable Seconds over a relatively short period of time.

Each end of the link statistics on this page can be independently reset using the Reset Statistics button for the local or remote radio. It is good practice to reset the statistics at the time that the link is commissioned (after all antenna alignment is complete and stable RSL at designed levels is achieved, and no more system reboots are anticipated). Make a habit of viewing this page regularly, make records of the performance, and reset the statistics so that the counters can more precisely pinpoint issues.



Resetting statistics from one end also resets the statistics for the same radio at the opposite end. That is, if the Local statistics are reset, logging into the remote end shows the Remote statistics on that end (which is the local radio in the first condition) as being reset at the same time.

Event Log Page

Use this page to review a list of the events logged by the radio. The following items are listed in the event log:

- Alarms
- Alarms clearing (Normal)
- Radio Reboots

Every event is tagged with the time that the event occurred, and a severity and type. The event log also allows filtering to limit the view of the log to the lowest level of desired information. For example, a filter level of Minor displays Minor, Major, and Critical severity events.

The log contains the last 200 events. Events are deleted on a FIFO basis, erasing the oldest entries to make room for the newest entries.

The event log can be cleared and be downloaded from the radio (some models may require a software upgrade to enable this feature). A screen capture of the browser window can serve as a useful record.

The screenshot shows the 'Event Log' page of the Exalt Radio Management interface. The browser window title is 'Exalt Radio Management, IP: 172.16.10.82, Radio B - Microsoft Internet Explorer'. The address bar shows 'http://172.16.10.82/home.asp?9700010'. The page features a navigation menu on the left with options like 'Radio Information', 'Administration Settings', 'Configuration', 'Monitor', 'Analysis', 'Reboot', and 'Manual'. The main content area displays the Exalt logo and the 'Event Log' title. Below the title, there is a 'Viewing filter' section with radio buttons for 'All', 'Normal', 'Warning', 'Minor', 'Major', and 'Critical'. The 'All' filter is selected. There are 'Refresh' and 'Clear' buttons. A table of event logs is displayed with the following data:

Date/Time	Description	Severity	Status
9/ 1/2006 7: 6:48	BER 10 ⁻³	Major	Normal
9/ 1/2006 7: 6:43	RF Sync loss	Critical	Normal
9/ 1/2006 7: 6:42	BER 10 ⁻³	Major	Alarm
9/ 1/2006 7: 6:32	RF Sync loss	Critical	Alarm
9/ 1/2006 7: 5:13	T1/E1 channel 2 input alarm	Major	Normal
9/ 1/2006 6:55:51	T1/E1 channel 1 input alarm	Major	Normal
9/ 1/2006 6:55:47	T1/E1 channel 2 input alarm	Major	Alarm

Figure 30 Event Log page

Diagnostic Charts Page

Use this page as an aid in troubleshooting. This page illustrates the historical (and current) performance for three parameters: RSL, Radio Temperature, and BER.

The horizontal scale illustrates 120 points of time measurement and is synchronized on all three graphs. The scale displays in minutes, hours, or days from the last two hours (120 minutes), five days (120 hours), or four months (120 days). All information is stored, so all of these periods are available for short- and long-term performance analysis. The right side of a graph represents the most recent measurement, and data ‘marches’ from the right-to-left at every interval.

The vertical scale of each chart independently scales to show the maximum resolution based on the maximum variation of the data over the selected time measurement.

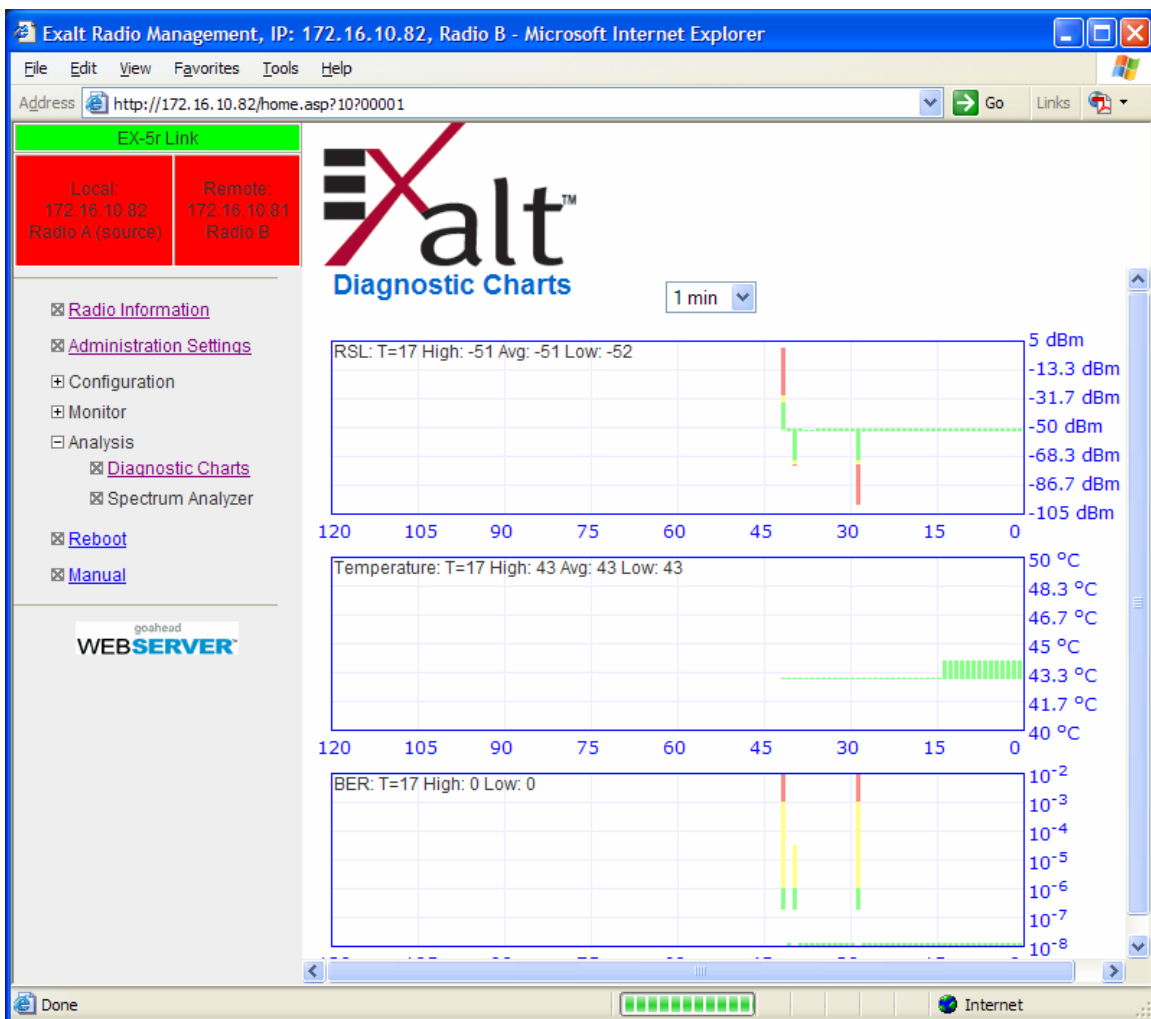

Figure 31 Diagnostic Charts page

Use the cursor to point to any spot on any of the three charts, and all three charts illustrate the measurements taken for that time interval in the upper-left corner of each chart. The time interval

is indicated by T=(value). This is followed by the value of the measurement, listing the highest value, lowest value and average value measured over that time interval.

For example, in Figure 31 the displayed time interval is minutes, and the cursor is held at the T=17 mark on the horizontal axis. The measurements shown indicate performance from 17 minutes ago. The high/low/average values shown on each chart are measurements made across that specific one-hour interval.

Changes in RSL often have an impact on BER, and this can be confirmed by looking for synchronized events. When BER events occur without corresponding changes in RSL, this normally indicates interference, atmospheric changes, transmission system issues (such as problems with cables, connectors or antennas), or possibly radio hardware problems.

It is also useful to help determine if changes in radio temperature are occurring, and if they are having any impact on RSL or BER. If the radio is mounted in an environmentally controlled location, this has less relevance. However, temperature monitoring can be helpful to ensure that the radio is operating within specifications.

Spectrum Analyzer Page

This page is not currently available. A built-in spectrum analyzer will be available in future releases, and documented.

Reboot Page

Use this page to reboot the radio. The function may never be required, but can be used in emergencies. All configurations that require a reboot automatically reboot on administrator confirmation.

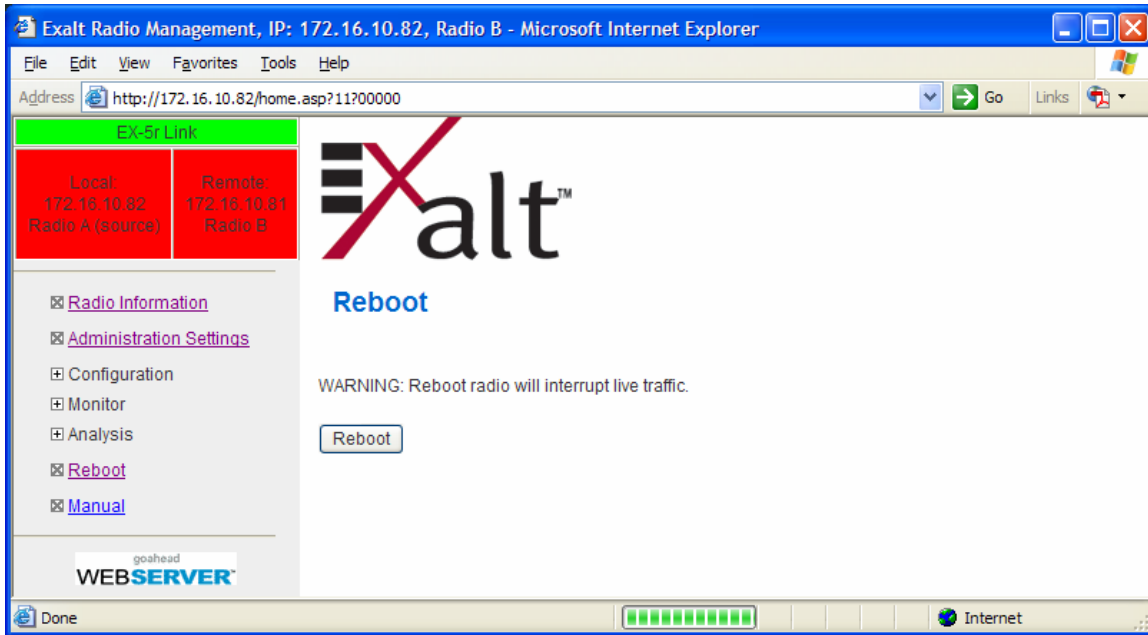

Figure 32 Reboot page

Manual Page

The manual (this document or the version that matches the installed firmware) is available within the GUI. Adobe Acrobat Reader 5.5 or higher is required (go to www.adobe.com to download Acrobat Reader). Click the Manual link and the manual displays within the browser window. Once the manual displays, click the save button on the PDF toolbar to download the manual locally.

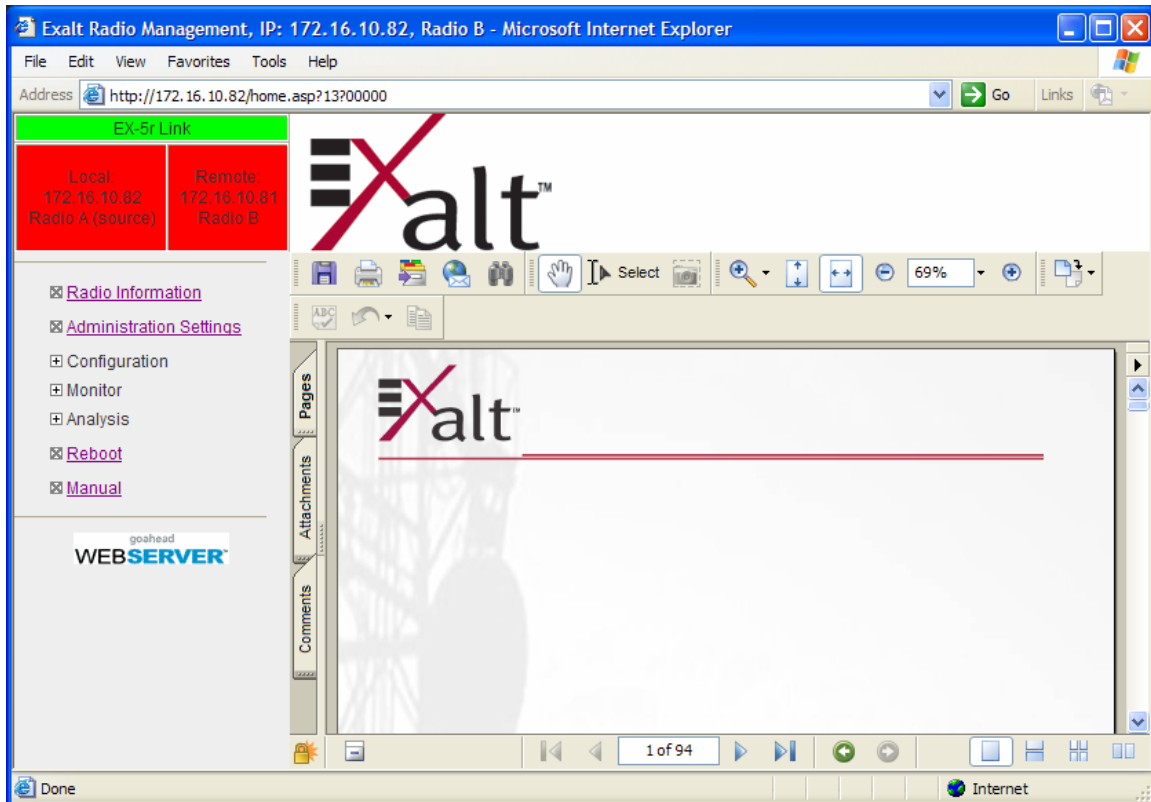

Figure 33 Manual page

Troubleshooting

This section provides information regarding troubleshooting of common issues and alarms on these radios. Exalt Digital Microwave Radio systems are designed by Exalt's expert engineers with extensive experience through multiple generations of microwave radio design. These new-generation systems contain extensive diagnostic tools, alarm indications, and troubleshooting aids. And, as compared to other systems in their class, are easier to install, maintain, and troubleshoot. The GUI provides information to aid in troubleshooting (see Diagnostic Charts Page on page 65).

Contact Exalt Customer Care for further assistance with issues with your Exalt radio and with suggestions on how the radio and documentation can be improved.

General Practices

Troubleshooting a microwave radio link can be a complex task. Approach troubleshooting as a process of elimination, and first determine which portions of the system are operating properly.

In a vast majority of cases, failures or poor performance of microwave links is attributed to something other than the microwave radio hardware. In this respect, the back-to-back bench test (see Back-to-back Bench Testing on page 82) is very important to determine if radio hardware is operating properly and eliminate many variables in the troubleshooting process.

If a back-to-back bench test fails, then the radio hardware is either broken or the radios are improperly configured. Upgrade the radio to the most current release of firmware, and/or reset the radio to its critical factory settings, following the quick start guide instructions and those in Configuration and Management, helps to confirm if configuration issues cause failure. The most common issues with microwave radio links are:

- An improperly terminated RF cable
- Multipath propagation
- RF interference
- Path obstruction
- Misaligned antenna
- Faulty antenna
- Improper grounding
- Insufficient link margin in the design/implementation
- Moisture in the transmission system (antenna feed and/or RF cable)

If the radio link has been operating without issues and is exhibiting new poor performance behavior or becomes completely inoperative, the troubleshooting process should pay close attention to any conditions that may have changed between the time when the system was working without issue and the time when the issues started.

Also, it can be helpful to compare some performance parameters of the system before and after the presence of issues. Often the source of the issues can be determined by thoughtful consideration of changes, such as:

- Changes in weather, including high winds
- Changes made to the radio equipment, transmission system, or connected equipment
- New radio systems or electronic equipment the nearby radio or transmission system
- New construction nearby either end of the link, or along the path
- Tree growth, flooded fields, or changes in rivers/lakes along the path

Verify that configurations are set as follows:

- RF matches at each end of the link
- Bandwidth matches at each end of the link
- Link distance matches at each end of the link
- TDD Frame Length matches at each end of the link
- Endpoint Identifier is different at each end of the link (one end Radio A, one end Radio B)
- Ethernet interfaces are enabled, as desired
- AUX Ethernet is set for in-band or out-of-band NMS, as desired
- T1/E1 enabling matches at each end of the link
- Link security key matches at each end of the link

Also, use the *ExaltCalc* tool in the design phase to determine the optimum setting for the Bandwidth and TDD Frame Length parameters for the given link distance, and provides guidance to the expected RF link performance, as well as throughput, latency, and number of supported T1/E1 circuits.

Typical Indications of Issues

In many cases, microwave radio users do not notice changes or degradation to the radio system until the radio system fails completely or becomes highly errored or significantly intermittent. However, regular management of the radio system can help indicate changes in performance that have not yet impacted user performance, but may impact performance at a later date if left unchecked or unaddressed. The administrator can use this as an opportunity to be proactive and monitor the radio link performance regularly, watching for unexplained or unexpected changes in performance and trends in performance changes.

Most importantly, monitoring radio system RSL over time indicates the performance of the radio system. Address any long-term drop in RSL and erratic or unsteady RSL. Some RSL changes are expected and weather patterns and the related multipath can cause dramatic RSL changes resulting in system outage. However, that outage should not occur at a significantly greater rate

than the designed long-term performance. Consult the path design engineer for more information about link reliability expectations and anticipated RSL deviation.

In addition, regular inspection of the transmission system (RF cables and antennas) and paying close attention to changes along the path, such as construction or tree height, or new microwave radio installations nearby, can be extremely helpful and proactive.

When link performance is very poor, alarms on the radio front panel and within the radio's management system indicates particular failures. Consult this manual for more information on the specific alarms and diagnostics, or contact Exalt Customer Care for assistance.

Exalt Customer Care is primarily motivated to determine if the radio hardware is faulty and require return for repair, and to help execute an effective and efficient repair and return process for radio terminals believed to be faulty. However, Exalt Customer Care provides advice regarding the total radio system and RF path engineering and environment, and advises on troubleshooting.

End users should first contact the installer and/or designer of the system. In many cases, an in-depth understanding of RF design is required, and on-site analysis and special test equipment, may be necessary. Compared to phone support from Exalt Customer Care, troubleshooting is much more expeditious if the professional installer and/or link designer examines the system and reviews the management information in the GUI. In turn, if the professional installer and/or link designer contacts Exalt Customer Care, the process to rectify the system is much more expedient due to the in-depth knowledge related to the implementation and the RF environment.

Improper RF Cable Termination

Improper RF cable termination is a very common problem. In many cases, this is a problem that occurs during installation and is not a problem that suddenly appears. However, if cables are moved or flexed, especially near the termination points, and radio errors, changes in RSL, or other performance issues occur, this is a certain sign of this issue.

Another relatively easy method to test for this condition is to decrease the output power of the radio system (at each end, one end at a time). A poor RF cable termination may be reflecting too much RF energy back into the radio system, and reducing output power reduces the reflected energy at a faster rate than the transmitted energy towards the far end. Be careful not to reduce the output power to the point where the radio's threshold is reached. Typically, a reduction of just 3 to 6dB is enough to determine if this is the issue. If the reduction of output power clears the error condition, this is the likely cause.

Use a reflectometer or meter that can read VSWR at the operating frequency to identify poor terminations as well as poor antenna feeds.



The Praxsym VSWR meter is an excellent tool for this purpose

Multipath Propagation

Multipath propagation is a term that encompasses changes to the RF path, such as reflections and/or refraction, causing partial or complete destruction of the radio signal, and thus excessive bit errors and/or system outages.

Rapid changes in temperature, inversion layers, humidity, air pressure, water evaporation, as well as standing water or moisture on objects along the path are all examples of changes that can cause multipath propagation. New building construction near either end of the path or along the path can cause new reflection characteristics.

If your system has been operating without issue and is suddenly experiencing issues that are symptomatic of a certain time of day or related to change in climatic events or some of the external factors listed above, this is likely the cause. Consult a professional RF path engineer in these cases. Often, minor repositioning of the antennas at either or both ends can reduce or eliminate these problems.

RF Interference

RF interference is usually indicative of another radio system nearby either end of your radio system or aimed towards one or both ends of your radio system – usually at or near the same frequency and usually with a similar signal level.

Other forms of RF interference also exist, such as electronic equipment placed close to the radio chassis or transmitters that couple onto the cabling or grounding system of the radio. Microwave ovens and wireless communication devices used near the equipment or cabling are examples of electronic equipment interference.



The Exalt EX-5 series Digital Microwave Radios operate in license-exempt bands. Microwave ovens, wireless Internet devices and cordless phone technology may also use this frequency band. It may be necessary to separate the radio chassis, cabling system and antenna from these devices.

RF interference, like most other causes of problems, is indicated by significant bit errors and/or system outages.

One means to determine presence of interference is the use of a spectrum analyzer that covers the same range as the radio system. A professional RF engineer can use a spectrum analyzer to locate sources of interference, measure these sources, and determine potential remedies to take to operate in the presence of interference.

If a spectrum analyzer is not available, the radio's RSL port can help determine RSL levels of interfering signals. By turning the far-end radio off, the residual RSL measured by the radio indicates the level of interference seen by the radio. It is possible that interference levels below that which can be measured still have an impact on the radio system – especially if the radio system has low fade margin or is using a high order modulation.

Exalt Digital Microwave Radios provides considerable flexibility to tune to different frequencies across the bands within which they operate. This is the easiest method to use to try to avoid

existing interference. In addition, the occupied bandwidth of the radio can be reduced. This, along with re-tuning, can be very effective, however throughput is reduced.

Repositioning the antenna and/or changing polarization, or upgrading the antenna to a higher gain, and/or using a high-performance antenna, are all secondary means that can be used. It may be necessary to perform combinations of both radio changes (retuning, occupied bandwidth reduction) and antenna system changes (position, polarization, upgrade).

The EX-4.9r radio operates under licensed regulations. If interference is suspected, the local frequency coordination organization, or other users of the spectrum should be consulted before re-tuning the radio to a different frequency channel.

Path Obstruction

A path obstruction is defined as an object, such as a building or tree, impeding the proper path of the radio system. If the system design was proper at the time of installation and issues arise at a later date, an updated path profile and survey may be necessary to identify changes in path clearance.

Misaligned Antenna

At the time of initial installation, it is critical that the antennas at each end are properly aligned and that the designed RSL is achieved. However, antennas may become misaligned due to high winds, changes in the guy-wiring systems keeping the antenna mast stable, or loosening of the antenna mounting hardware. A reduction in the RSL of the link is symptomatic of this condition, but this condition is not the only condition that results in a reduction of RSL. However, if conditions occur where the antenna alignment may be suspected, the mechanics must be inspected and the antennas realigned.

Faulty Antenna

A faulty antenna is rare, but is still a possibility. In some cases, the mechanics of the antenna feed can get moisture inside, or a bad or weak connection in the pin and connector structure of the antenna may occur. A VSWR measurement of the antenna connection can be made to verify this condition.

Improper Grounding

In addition to being a potential human safety issue, improper system grounding is a somewhat common condition that can cause continuous bit errors or bit errors when metal objects come in contact with the radio, transmission system, or racking system. If touching the radio causes errors, grounding is the cause. It can be difficult to identify grounding problems, but a professional electrician can normally inspect a system and identify if there are deficiencies in the grounding system.

Insufficient Link Margin

Ideally, the link was designed with enough link margin (fade margin) to allow for multipath propagation and atmospheric fading and still remain reliable. In some cases, link margin is compromised by economic factors, such as using low-cost RF cabling or lower-cost antennas that have less gain or deficient performance compared to higher cost transmission system components. In some cases, there may be antenna size restrictions that forced the design to not have the desired amount of link margin.

If the link was designed with poor link margin, there are likely many cases of bit errors and outages. The antenna system and transmission line can be upgraded to help reduce this. If the link design was installed with sufficient margin, but RSL is reduced, the remaining link margin may no longer be enough to maintain a reliable link. The causes of RSL reduction were previously described, but are usually due to new path obstruction(s) or antenna misalignment due to wind or mechanical factors. The antenna height or location can be changed to overcome new obstructions. Realignment of the antenna, and/or improvement to mechanical structures can help overcome antenna misalignment.

Moisture in the Transmission System

If the connectors on cables and antennas and egress junctions are not properly weatherproofed, moisture can get into the transmission system and cause significant error conditions and erratic performance. In many cases, the transmission system must be replaced. A VSWR meter is one means to identify such issues. Physical inspection can be helpful, and if changes to the weatherproofing occur (such as cracks), the weatherproofing must be replaced before it leaks.

Specifications

This section presents specifications for the EX-5r series of Digital Microwave Radios.

Physical Specifications

Physical Configuration	Outdoor unit (ODU)
Dimensions (H x W x D)	13 x 13 x 4.25"/33 x 33 x 10.8 cm
Weight	15 lbs; 6.8 kg
Operating Temperature	-40 to +149°F / -40 to +65°C;
Altitude	15,000'/4.6 km
Humidity	100% condensing
Environmental	NEMA4/IP56
Safety/EMC	EN 60950; EN 301-489-17

Common System Specifications

Tuning Resolution	1MHz (5MHz for 4.9 GHz Products)
Power Control Step Size	0.5dB
Selectable Modulation Modes	Mode 1 (QPSK); Mode 2 (16QAM)
Selectable Channel Bandwidths	8MHz, 16MHz, 32MHz*, 64MHz*
Selectable Frame Lengths (ms)	0.5, 1, 2, 2.5, 4, 5

Maximum Aggregate User Capacity

Mbps	Mode 1	Mode 2
8 / 10 MHz	13	27
16 / 20 MHz	27	54
32 / 40 MHz*	55	110
64 MHz*	110	216

Error Floor	10^{-12}
Frequency Stability	± 7 ppm
Link Security	96-bit Security Code

*Not all BW selections are available in every country. And, in some cases, certain BW selections are only available after purchasing a software upgrade license key, for countries where wider operating bandwidths are allowed.

EX-4.9r System Specifications

Frequency Band	4940 to 4990 MHz
Tunable Range	4945 to 4985 MHz
Output Power (at full power, Mode 1)	+24dBm (20MHz BW) +22dBm (10MHz BW) +20dBm (40MHz BW)
Output Power (at minimum power)	+4dBm
Selectable Channel Bandwidths	10MHz, 20MHz,*

Receiver Threshold (BER=10⁻⁶)

dBm	Mode 1	Mode 2
10MHz	-86	-78
20MHz	-83	-75*

Maximum RSL	Mode 1: -25dBm error-free; 0dBm no damage
Non-overlapping channels	10MHz: 5; 20MHz: 2
Regulatory Compliance	FCC Part 90; IC RSS-111
FCC ID	TTM-104P90R
IC ID	6254A-104P90R

Emission Designator(s)

10MHz	10M9W7D
20MHz	21M8W7D

*For the EX-4.9i, firmware options are required to enable Mode 2/20MHz BW

System Specifications, 5.3GHz Band

Frequency Band	5250 to 5350 MHz
Tunable Range	5260 to 5332 MHz
Output Power (at full power)	+13dBm (0.02W)
Output Power (at minimum power)	-7dBm

Receiver Threshold (BER=10 ⁻⁶)	dBm	Mode 1	Mode 2
	8MHz	-86	-78
	16MHz	-83	-75
	32MHz*	-80	-72
	64MHz*	-77	-69

Maximum RSL	Mode 1: -25dBm error-free; 0dBm no damage								
Non-overlapping channels	8MHz: 10; 16MHz: 5; 32MHz*: 2; 64MHz*: 1								
Regulatory Compliance	FCC 15.407; IC RSS-210; EN 301 893								
FCC ID	TTM-105P25R								
IC ID	6254A-105P25R								
Emission Designator(s)	<table border="1"> <tr> <td>8MHz</td> <td>8M7W7D</td> </tr> <tr> <td>16MHz</td> <td>17M2W7D</td> </tr> <tr> <td>32MHz*</td> <td>34M5W7D</td> </tr> <tr> <td>64MHz*</td> <td>67M9W7D</td> </tr> </table>	8MHz	8M7W7D	16MHz	17M2W7D	32MHz*	34M5W7D	64MHz*	67M9W7D
8MHz	8M7W7D								
16MHz	17M2W7D								
32MHz*	34M5W7D								
64MHz*	67M9W7D								

*Not all BW selections are available in every country. And, in some cases, certain BW selections are only available after purchasing a software upgrade license key, for countries where wider operating bandwidths are allowed.

System Specifications, 5.4GHz Band



Presently this band is not enabled. This band will be enabled through a free software upgrade upon regulatory approval.

Frequency Band 5470 to 5725 MHz

Tunable Range 5488 to 5715 MHz

Output Power (at full power) +13dBm (0.02W)

Output Power (at minimum power) -7dBm

Receiver Threshold (BER=10⁻⁶)

dBm	Mode 1	Mode 2
8MHz	-86	-78
16MHz	-83	-75
32MHz*	-80	-72
64MHz*	-77	-69

Maximum RSL

Mode 1: -25dBm error-free; 0dBm no damage

Non-overlapping channels

8MHz: 29; 16MHz: 14; 32MHz*: 7; 64MHz*: 3

Regulatory Compliance

FCC 15.407; IC RSS-210; EN 301 893

FCC ID

TTM-105P25R

IC ID

6254A-105P25R

Emission Designator(s)

8MHz	8M7W7D
16MHz	17M2W7D
32MHz*	34M5W7D
64MHz*	67M9W7D

*Not all BW selections are available in every country. And, in some cases, certain BW selections are only available after purchasing a software upgrade license key, for countries where wider operating bandwidths are allowed.

System Specifications, 5.8GHz Band

Frequency Band	5725 to 5850 MHz
Tunable Range	5731 to 5844 MHz
Output Power (at full power)	+24dBm (0.25W), Mode 1 +21dBm (0.13W), Mode 2
Output Power (at minimum power)	+4dBm

Receiver Threshold (BER=10⁻⁶)

(dBm)	Mode 1	Mode 2
8MHz	-86	-78
16MHz	-83	-75
32MHz*	-80	-72
64MHz*	-77	-69

Maximum RSL	Mode 1: -25dBm error-free; 0dBm no damage
Non-overlapping channels	8MHz: 15; 16MHz: 7; 32MHz*: 3; 64MHz*: 1
Regulatory Compliance	FCC 15.247; IC RSS-210; EN 302 502
FCC ID	TTM-105P25R
IC ID	6254A-105P25R

Emission Designator(s)

8MHz	9M1W7D
16MHz	16M5W7D
32MHz*	31M8W7D
64MHz*	61M6W7D

*Not all BW selections are available in every country. And, in some cases, certain BW selections are only available after purchasing a software upgrade license key, for countries where wider operating bandwidths are allowed.

Interfaces***RF (x2, EX-5r-(x)c only)***

Connector	N-type female
Impedance	50 Ohms

T1/E1 (x2, 2 interfaces each)

Connector	RJ-45 (RJ48C), female
T1 Impedance	100 Ohms, balanced
T1 Line Codes	AMI, B8ZS, selectable
T1 LBO Settings (in ft.)	0-133, 133-266, 266-399, 399-533, 533-655
T1 Clocking Speed	1.544 Mbps
T1 Compliance	ANSI T1.102-1987; ITU-T; G.823; GR-49T-CORE
E1 Impedance	120 Ohms, balanced
E1 Line Codes	HDB3
E1 Clocking Speed	2.048 Mbps
E1 Compliance	CEPT-1; G.703; ITU-T-G703

Ethernet

Connectors	RJ-45, female, auto-MDIX
Interface Speed	10 or 100 Mbps
Duplex	Half, full, auto, selectable
Compliance	802.3

Sync-In

Connector	RJ-45, female
Signal	1pps (GPS)

Power — Power Injector

Connector	6-pin barrier strip
Input Voltage	48VDC
Consumption	<60 W (1.25A)

Integrated Antenna (EX-5r(-x) only)

Gain (midband)	20dBi
3dB Beamwidth	15 degrees
Polarization	Switch-selectable vertical or horizontal

Back-to-back Bench Testing

Use back-to-back bench testing to test the radio before installation, pre-configure the radio and connected equipment before installation, or in the troubleshooting process to identify if the radio hardware is the source of a system issue. It is a critical process, and often required or highly desirable for any installation or troubleshooting exercise. This section describes how to properly configure the radio hardware and accessories for a proper back-to-back bench test.

For radio testing, there are two types of back-to-back configurations:

1. Basic test (test general operation)
2. Specification performance verification (EX-5r-c only)

Basic Test

The basic test is a simple test of radio functionality. It verifies that the radios are properly configured to communicate to one another, and verifies general radio performance as operational.

For the basic test, the following items are needed:

- Radio pair
- Powering source
- Computer/terminal with Ethernet port

EX-5r-c only

- RF interconnect cable(s) (any length – short is best)
- Fixed or variable attenuation, between 60 and 90dB (note: attenuation for basic test does not to be calibrated or precise)

Connections EX-5r-c only

Connect the items as follows:

1. Connect attenuation and (known-good) RF cable(s) between radio pair, shown in Figure 34.
2. Configure one radio as Radio A; the other as Radio B
3. Power on radio pair

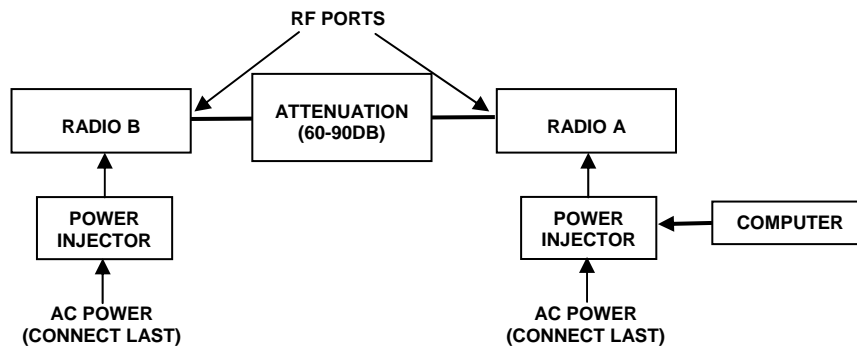

Figure 34 Basic back-to-back bench test configuration

EX-5r Basic Test Configuration

When the radios are near one another, the integral antenna provides the connection. Place an RF-absorptive material such as wood or RF absorbing foam between the units to provide attenuation.



Do **not** point the radios directly towards one another when they are in close proximity.

Power received from an adjacent radio at full power will damage both radios. Turn the transmitter power down and separate the radios as far apart as possible. Use an RF-absorptive material in between the antennas for additional safety.

Verify Connection

After connecting and powering on, observe the front panel LEDs to verify that the LINK and STATUS LEDs are green. If so, the radios are communicating and all radio-related alarm conditions are normal.

It can be beneficial to have a computer to verify configuration in case of red LEDs or to pre-configure the radio as desired for operation. Follow the instructions in [Configuration and Management](#).

Specification Performance Verification—EX-5r-(x)c only

The specification performance verification is a more detailed test that allows you to verify that the radio's output power and threshold specifications are being met. This is typically a test that would only be performed in a troubleshooting scenario, but can be performed before installation to provide a detailed record or ensure radio performance before installation.

This test is identical to the basic test, but in place of the fixed attenuation, it requires the use of calibrated variable attenuation, or a set of calibrated fixed attenuators, or a combination of both, adding to a total attenuation value of 120dB, as measured at the operating frequency of the radio. In addition, a volt meter or computer is also required.

Connect the system as shown in Figure 34, using the combination of fixed and variable attenuation between the radio's RF ports. Connect the volt meter to either radio's RSL test point and associated reference ground connection.

In this test, it is desirable to use pre-tested RF cables, known to be good, and the insertion loss is known at the operating frequency. If the cables are short (6'/2m or less), you can estimate the loss, including connectors, to be less than 1dB each. The estimate of cable loss is critical to the overall confidence of the measurements made in this test.

There are two critical specifications that can be tested in this configuration:

1. RF output power
2. Radio receiver threshold

To measure transmitter output power, simply insert any value of attenuation between the radios between 60 and 90dB. Ensure that both RF output power settings are at maximum. Use the volt meter to measure RSL in both directions. The RSL measured value should match the appropriate value according to the inserted attenuation, such as:

$$RSL = RF \text{ Output Power} - \text{cabling losses} - \text{total attenuation}$$

Verify output power by adjusting output power using the Exalt GUI (in administration mode) and evaluate the corresponding change to the RSL measurement.

For threshold testing, the key is to insert a measured amount of loss that is close to, but not exceeding the radio's specified system gain. System gain is the difference between RF output power and receiver threshold. At your selected modulation and bandwidth settings, determine the specified threshold performance, and choose a value of attenuation (including cable losses) that adds to roughly 5 to 15dB less than the system gain.

For example, for a setting of Mode1 and 8 MHz, if the threshold for your measurement is -86dBm, the output power is +24dBm, so the system gain is 110dB. Choose a value of total attenuation in the range of roughly 100–105dB. Once this attenuation is inserted, verify RSL readings as in the first step, and then, using the GUI, reduce radio output power in 1dB steps until the receiving radio (the one whose output power not being adjusted) Link LED turns from green to yellow. This indicates that threshold has been reached. At this point, verify the equation for system gain using the new output power level setting and verify that the threshold performance is meeting or exceeding the published specification.



Due to the variation of measurements and accuracies involved in this test, you may read a measurement that is 1dB to as much as 2dB off of the expected value. It should be of no concern unless the value is more than 3dB worse than expected.

Once threshold is verified in this direction, repeat the process in the opposite direction by adjusting RF output power of the radio at the opposite end. Return the first radio to its original power setting before adjusting the second radio.

Perform threshold measurement tests for all combinations of bandwidth and mode (modulation) being used—especially when troubleshooting. It should not be necessary to vary center frequency,

as this does not have any appreciable impact on system gain performance, however, try any setting combination to gain confidence in the radio performance parameters.

Interface Connections

This section provides the pin number assignment and wiring information for the connectors on the EX-5r. All connectors are shown as viewed from the radio front panel, as shown in Figure 35.

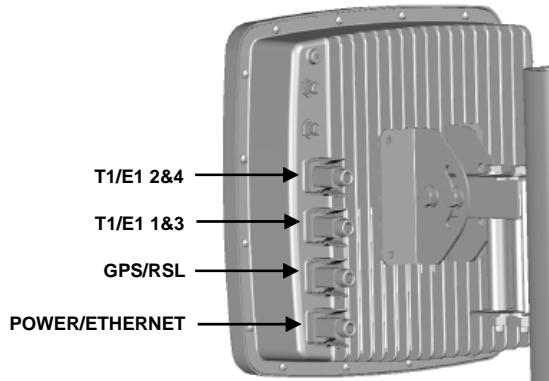
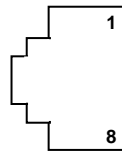

Figure 35 Ex-5r connector orientation

T1/E1 Connections

There are two connectors for T1/E1, each connector has two T1/E1 circuits available. Figure 36 illustrates the pin orientation and functionality of these connectors.



Pin	Function
1	Tip Out (from radio) – Ch.1 & 2
2	Ring Out (from radio) – Ch.1 & 2
3	Tip Out (from radio) – Ch.3 & 4
4	Tip In (to radio) – Ch.1 & 2
5	Ring In (to radio) – Ch.1 & 2
6	Ring Out (from radio) – Ch.3 & 4
7	Tip In (to radio) – Ch.3 & 4
8	Ring In (to radio) – Ch.3 & 4

Figure 36 T1/E1 connectors

RSL & GPS Sync Connector

This connector can be used during the antenna alignment process, to provide a received signal level (RSL) voltage to a voltmeter. The connector is also used for connection to an optional Exalt GPS antenna for the purposes of GPS synchronization. The figure below illustrates the pin orientation and functionality for this connector.

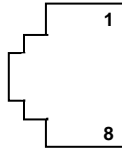

Pin	Function
1	+5V out to GPS antenna
2	Ground
3	Tx Data to GPS antenna
4	Enable signal to GPS antenna
5	Rx Data from GPS antenna
6	1pps signal from GPS antenna
7	Received Signal Level (RSL)
8	Unused

Figure 37 RSL & GPS connector

Power/Ethernet Connector

This connector is the primary connector on the radio, and must be connected to provide power to the radio, and primary Ethernet communications for traffic and Ethernet. The figure below illustrates the pin orientation and functionality for this connector.

The Ethernet connector implements Auto-MDIX, and therefore either 'straight' or 'crossover' Ethernet cables may be used, independent of the wiring of the connected device. The wiring follows typical wiring for Power-over-Ethernet (PoE), however the power consumption requirement for the EX-5r does not allow for 'standard' (802.3af) PoE, and only the Exalt power injector shall be used. In addition, the Exalt power injector provides critical reset and alarm capability that would not be available from a generic PoE injector, even if the power consumption requirement is met.

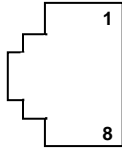

Pin	Function
1	Paired with Pin 2
2	Paired with Pin 1
3	Paired with Pin 6
4	+DC Power (48V) In
5	+DC Power (48V) In
6	Paired with Pin 3
7	-DC Power (48V) In
8	-DC Power (48V) In

Figure 38 Power/Ethernet connector

Copyright Notices

This section presents copyright notices for third-party software licensed to Exalt Communications, Inc.

Net-SNMP

The following copyright notice applies to the open-source licensing agreement for Net-SNMP.

Copyright 1989, 1991, 1992 by Carnegie Mellon University

Derivative Work - 1996, 1998-2000

Copyright 1996, 1998-2000 The Regents of the University of California

All Rights Reserved

Permission to use, copy, modify and distribute this software and its documentation for any purpose and without fee is hereby granted, provided that the above copyright notice appears in all copies and that both that copyright notice and this permission notice appear in supporting documentation, and that the name of CMU and The Regents of the University of California not be used in advertising or publicity pertaining to distribution of the software without specific written permission.

CMU AND THE REGENTS OF THE UNIVERSITY OF CALIFORNIA DISCLAIM ALL WARRANTIES WITH REGARD TO THIS SOFTWARE, INCLUDING ALL IMPLIED WARRANTIES OF MERCHANTABILITY AND FITNESS. IN NO EVENT SHALL CMU OR THE REGENTS OF THE UNIVERSITY OF CALIFORNIA BE LIABLE FOR ANY SPECIAL, INDIRECT OR CONSEQUENTIAL DAMAGES OR ANY DAMAGES WHATSOEVER RESULTING FROM THE LOSS OF USE, DATA OR PROFITS, WHETHER IN AN ACTION OF CONTRACT, NEGLIGENCE OR OTHER TORTIOUS ACTION, ARISING OUT OF OR IN CONNECTION WITH THE USE OR PERFORMANCE OF THIS SOFTWARE.

Network Associates Technology, Inc.

Copyright (c) 2001-2003, Networks Associates Technology, Inc

All rights reserved.

Redistribution and use in source and binary forms, with or without modification, are permitted provided that the following conditions are met:

* Redistributions of source code must retain the above copyright notice, this list of conditions and the following disclaimer.

* Redistributions in binary form must reproduce the above copyright notice, this list of conditions and the following disclaimer in the documentation and/or other materials provided with the distribution.

* Neither the name of the Networks Associates Technology, Inc nor the names of its contributors may be used to endorse or promote products derived from this software without specific prior written permission.

THIS SOFTWARE IS PROVIDED BY THE COPYRIGHT HOLDERS AND CONTRIBUTORS "AS IS" AND ANY EXPRESS OR IMPLIED WARRANTIES, INCLUDING, BUT NOT LIMITED TO, THE IMPLIED WARRANTIES OF MERCHANTABILITY AND FITNESS FOR A PARTICULAR PURPOSE ARE DISCLAIMED. IN NO EVENT SHALL THE COPYRIGHT HOLDERS OR CONTRIBUTORS BE LIABLE FOR ANY DIRECT, INDIRECT, INCIDENTAL, SPECIAL, EXEMPLARY, OR CONSEQUENTIAL DAMAGES (INCLUDING, BUT NOT LIMITED TO, PROCUREMENT OF SUBSTITUTE GOODS OR SERVICES; LOSS OF USE, DATA, OR PROFITS; OR BUSINESS INTERRUPTION) HOWEVER CAUSED AND ON ANY THEORY OF LIABILITY, WHETHER IN CONTRACT, STRICT LIABILITY, OR TORT (INCLUDING NEGLIGENCE OR OTHERWISE) ARISING IN ANY WAY OUT OF THE USE OF THIS SOFTWARE, EVEN IF ADVISED OF THE POSSIBILITY OF SUCH DAMAGE.

Cambridge Broadband, Ltd.

Portions of this code are copyright (c) 2001-2003, Cambridge Broadband Ltd.

All rights reserved.

Redistribution and use in source and binary forms, with or without modification, are permitted provided that the following conditions are met:

* Redistributions of source code must retain the above copyright notice, this list of conditions and the following disclaimer.

* Redistributions in binary form must reproduce the above copyright notice, this list of conditions and the following disclaimer in the documentation and/or other materials provided with the distribution.

* The name of Cambridge Broadband Ltd. may not be used to endorse or promote products derived from this software without specific prior written permission.

THIS SOFTWARE IS PROVIDED BY THE COPYRIGHT HOLDER ``AS IS" AND ANY EXPRESS OR IMPLIED WARRANTIES, INCLUDING, BUT NOT LIMITED TO, THE IMPLIED WARRANTIES OF MERCHANTABILITY AND FITNESS FOR A PARTICULAR PURPOSE ARE DISCLAIMED. IN NO EVENT SHALL THE COPYRIGHT HOLDER BE LIABLE FOR ANY DIRECT, INDIRECT, INCIDENTAL, SPECIAL, EXEMPLARY, OR CONSEQUENTIAL DAMAGES (INCLUDING, BUT NOT LIMITED TO, PROCUREMENT OF SUBSTITUTE GOODS OR SERVICES; LOSS OF USE, DATA, OR PROFITS; OR BUSINESS INTERRUPTION) HOWEVER CAUSED AND ON ANY THEORY OF LIABILITY, WHETHER IN CONTRACT, STRICT LIABILITY, OR TORT (INCLUDING

NEGLIGENCE OR OTHERWISE) ARISING IN ANY WAY OUT OF THE USE OF THIS SOFTWARE, EVEN IF ADVISED OF THE POSSIBILITY OF SUCH DAMAGE.

Sun Microsystems, Inc.

Copyright © 2003 Sun Microsystems, Inc., 4150 Network Circle, Santa Clara,
California 95054, U.S.A. All rights reserved.

Use is subject to license terms below.

This distribution may include materials developed by third parties.

Sun, Sun Microsystems, the Sun logo and Solaris are trademarks or registered trademarks of Sun Microsystems, Inc. in the U.S. and other countries.

Redistribution and use in source and binary forms, with or without modification, are permitted provided that the following conditions are met:

- * Redistributions of source code must retain the above copyright notice, this list of conditions and the following disclaimer.
- * Redistributions in binary form must reproduce the above copyright notice, this list of conditions and the following disclaimer in the documentation and/or other materials provided with the distribution.
- * Neither the name of the Sun Microsystems, Inc. nor the names of its contributors may be used to endorse or promote products derived from this software without specific prior written permission.

THIS SOFTWARE IS PROVIDED BY THE COPYRIGHT HOLDERS AND CONTRIBUTORS "AS IS" AND ANY EXPRESS OR IMPLIED WARRANTIES, INCLUDING, BUT NOT LIMITED TO, THE IMPLIED WARRANTIES OF MERCHANTABILITY AND FITNESS FOR A PARTICULAR PURPOSE ARE DISCLAIMED. IN NO EVENT SHALL THE COPYRIGHT HOLDERS OR CONTRIBUTORS BE LIABLE FOR ANY DIRECT, INDIRECT, INCIDENTAL, SPECIAL, EXEMPLARY, OR CONSEQUENTIAL DAMAGES (INCLUDING, BUT NOT LIMITED TO, PROCUREMENT OF SUBSTITUTE GOODS OR SERVICES; LOSS OF USE, DATA, OR PROFITS; OR BUSINESS INTERRUPTION) HOWEVER CAUSED AND ON ANY THEORY OF LIABILITY, WHETHER IN CONTRACT, STRICT LIABILITY, OR TORT (INCLUDING NEGLIGENCE OR OTHERWISE) ARISING IN ANY WAY OUT OF THE USE OF THIS SOFTWARE, EVEN IF ADVISED OF THE POSSIBILITY OF SUCH DAMAGE.

Sparta, Inc.

Copyright (c) 2003-2005, Sparta, Inc
All rights reserved.

Redistribution and use in source and binary forms, with or without modification, are permitted provided that the following conditions are met:

- * Redistributions of source code must retain the above copyright notice, this list of conditions and the following disclaimer.
- * Redistributions in binary form must reproduce the above copyright notice, this list of conditions and the following disclaimer in the documentation and/or other materials provided with the distribution.
- * Neither the name of Sparta, Inc nor the names of its contributors may be used to endorse or promote products derived from this software without specific prior written permission.

THIS SOFTWARE IS PROVIDED BY THE COPYRIGHT HOLDERS AND CONTRIBUTORS "AS IS" AND ANY EXPRESS OR IMPLIED WARRANTIES, INCLUDING, BUT NOT LIMITED TO, THE IMPLIED WARRANTIES OF MERCHANTABILITY AND FITNESS FOR A PARTICULAR PURPOSE ARE DISCLAIMED. IN NO EVENT SHALL THE COPYRIGHT HOLDERS OR CONTRIBUTORS BE LIABLE FOR ANY DIRECT, INDIRECT, INCIDENTAL, SPECIAL, EXEMPLARY, OR CONSEQUENTIAL DAMAGES (INCLUDING, BUT NOT LIMITED TO, PROCUREMENT OF SUBSTITUTE GOODS OR SERVICES; LOSS OF USE, DATA, OR PROFITS; OR BUSINESS INTERRUPTION) HOWEVER CAUSED AND ON ANY THEORY OF LIABILITY, WHETHER IN CONTRACT, STRICT LIABILITY, OR TORT (INCLUDING NEGLIGENCE OR OTHERWISE) ARISING IN ANY WAY OUT OF THE USE OF THIS SOFTWARE, EVEN IF ADVISED OF THE POSSIBILITY OF SUCH DAMAGE.

Cisco, Inc.

Copyright (c) 2004, Cisco, Inc and Information Network
Center of Beijing University of Posts and Telecommunications.

All rights reserved.

Redistribution and use in source and binary forms, with or without modification, are permitted provided that the following conditions are met:

- * Redistributions of source code must retain the above copyright notice, this list of conditions and the following disclaimer.
- * Redistributions in binary form must reproduce the above copyright notice, this list of conditions and the following disclaimer in the documentation and/or other materials provided with the distribution.
- * Neither the name of Cisco, Inc, Beijing University of Posts and Telecommunications, nor the names of their contributors may be used to endorse or promote products derived from this software without specific prior written permission.

THIS SOFTWARE IS PROVIDED BY THE COPYRIGHT HOLDERS AND CONTRIBUTORS "AS IS" AND ANY EXPRESS OR IMPLIED WARRANTIES, INCLUDING, BUT NOT LIMITED TO, THE IMPLIED WARRANTIES OF MERCHANTABILITY AND FITNESS FOR A PARTICULAR PURPOSE ARE DISCLAIMED. IN NO EVENT SHALL THE COPYRIGHT HOLDERS OR CONTRIBUTORS BE LIABLE FOR ANY DIRECT, INDIRECT, INCIDENTAL, SPECIAL,

EXEMPLARY, OR CONSEQUENTIAL DAMAGES (INCLUDING, BUT NOT LIMITED TO, PROCUREMENT OF SUBSTITUTE GOODS OR SERVICES; LOSS OF USE, DATA, OR PROFITS; OR BUSINESS INTERRUPTION) HOWEVER CAUSED AND ON ANY THEORY OF LIABILITY, WHETHER IN CONTRACT, STRICT LIABILITY, OR TORT (INCLUDING NEGLIGENCE OR OTHERWISE) ARISING IN ANY WAY OUT OF THE USE OF THIS SOFTWARE, EVEN IF ADVISED OF THE POSSIBILITY OF SUCH DAMAGE.

Fabasoft R&D Software GmbH & Co.

Copyright (c) Fabasoft R&D Software GmbH & Co KG, 2003

oss@fabasoft.com

Author: Bernhard Penz

Redistribution and use in source and binary forms, with or without modification, are permitted provided that the following conditions are met:

- * Redistributions of source code must retain the above copyright notice, this list of conditions and the following disclaimer.
- * Redistributions in binary form must reproduce the above copyright notice, this list of conditions and the following disclaimer in the documentation and/or other materials provided with the distribution.
- * The name of Fabasoft R&D Software GmbH & Co KG or any of its subsidiaries, brand or product names may not be used to endorse or promote products derived from this software without specific prior written permission.

THIS SOFTWARE IS PROVIDED BY THE COPYRIGHT HOLDER ``AS IS" AND ANY EXPRESS OR IMPLIED WARRANTIES, INCLUDING, BUT NOT LIMITED TO, THE IMPLIED WARRANTIES OF MERCHANTABILITY AND FITNESS FOR A PARTICULAR PURPOSE ARE DISCLAIMED. IN NO EVENT SHALL THE COPYRIGHT HOLDER BE LIABLE FOR ANY DIRECT, INDIRECT, INCIDENTAL, SPECIAL, EXEMPLARY, OR CONSEQUENTIAL DAMAGES (INCLUDING, BUT NOT LIMITED TO, PROCUREMENT OF SUBSTITUTE GOODS OR SERVICES; LOSS OF USE, DATA, OR PROFITS; OR BUSINESS INTERRUPTION) HOWEVER CAUSED AND ON ANY THEORY OF LIABILITY, WHETHER IN CONTRACT, STRICT LIABILITY, OR TORT (INCLUDING NEGLIGENCE OR OTHERWISE) ARISING IN ANY WAY OUT OF THE USE OF THIS SOFTWARE, EVEN IF ADVISED OF THE POSSIBILITY OF SUCH DAMAGE.

Index

A

AC adapter, 22, 23
 accessory kit contents, 7
 Administration Settings page, 40
 administrator privileges, 35
 AIS enabling/disabling, 48
 alarm conditions, 38
 alarms, 46, 56, 61
 clearing, 61
 Temperature, 57
 Alarms page, 56
 AMI, 48
 antenna port parameter, 45
 antennas
 alignment, 30, 70
 Canada, v
 mounting, 3, 26
 indoor, 29
 mounting height, 6
 polarization orientation, 6
 site preparation considerations, 6
 system grounding, 6
 transmission line, 27
 troubleshooting, 70
 USA, 25

B

B8ZS, 48
 back-to-back bench test, 8, 78
 back-to-back bench test configuration, 79
 bandwidth, 5, 6
 Bandwidth parameter, 43, 53
 battery source, 22
 BER, 62
 browsers, 33
 buzzer timeout selection parameter, 45

C

cables
 Ethernet (CAT5), 8
 RF, 4, 6
 T1/E1, 8
 troubleshooting
 improper RF cable termination, 68
 carrier-to-interference tolerance, 6
 center frequency, 9
 center frequency tuning, 5
 channel bandwidth, 5
 CLI, 32
 main menu, 32
 menu options, 32
 configuration file, 51
 connectors, 20

5000007 (ETSI)

2007-02-12 (draft)

GPS/RSL, 20
 Power/Ethernet, 20, 82
 T1/E1, 81
 T1/E1 1&3, 20
 T1/E1 2&4, 20
 contact information, 1
 Current BER field, 58
 Current RSL field, 58

D

data communication interface, 4
 date and time, 40
 DC power source, 22
 Diagnostic Charts page, 62
 dimensions, 72
 documentation, related, 1
 duplex
 100/full-duplex, 46
 duplex settings, 46

E

E1 channels, 49
 E1 Interface Configuration page, 49
 effective isotropic radiated power (EIRP), 9
 encryption, 5
 Endpoint Identifier, 36, 44, 52
 Errored Seconds (ES) field, 59
 Ethernet, 6
 Ethernet configuration parameters, 53
 Ethernet connectors, 82
 Ethernet interface, 76
 throughput settings, 47
 Ethernet Interface Configuration page, 46
 Event Log page, 61
 ExaltCalc tool, 12, 67
 external loopback modes, 50

F

factory default settings, 24, 52
 fade margin, 6, 70
 features, 4
 File Activation page, 51, 54
 File Transfer page, 51
 file transfers, 51
 files
 activating stored, 54
 default configuration file, 52
 frame length. *See* TDD frame
 frequency
 center, 7

G

- gateway (default), 53
- GPS/RSL connector, 20
- GPS/RSL LED, 21
- grounding, 70
- GUI
 - Administration Settings page, 40
 - Alarms page, 56
 - browsers supported, 33
 - description, 33
 - Diagnostic Charts page, 62
 - E1 Interface Configuration page, 49
 - Ethernet Interface Configuration page, 46
 - Event Log page, 61
 - File Activation page, 51, 54
 - File Transfer page, 51
 - IP address (default), 33
 - log in, 34
 - login privileges, 35
 - navigation panel, 37, 38
 - Performance page, 58
 - Radio A configuration, 34
 - Radio Information page, 38
 - Reboot page, 64
 - Spectrum Analyzer page, 63
 - summary status information, 37
 - System Configuration page, 42
 - T1 Interface Configuration page, 48
 - T1/E1 Configuration page, 47

H

- hop, 7

I

- interfaces
 - Ethernet, 76
 - power, 76
 - RF, 76
 - T1/E1, 76
- interference, 59
- interference profile, 6
- IP address, 53
- IP address conflicts, 34
- IP address subnet, 34
- IP settings, 8
- IP subnet mask, 53

L

- latency optimization, 5
- LEDs
 - GPS/RSL, 21
 - Power Injector, 21
 - Power/Ethernet, 21
 - T1/E1 1&3, 21
 - T1/E1 2&4, 21

- License Key, 41
- lightning arrestor, 6
- lightning arrestors, 29
- Line Build Out (LBO), 48
- Line Code, 48
- link, 6
 - orientation, 13
 - RF link testing, 8
 - synchronization, 13
- Link Distance parameter, 44, 53
- link margin, 70
- Link Name parameter, 63
- link parameters, 37
- Link Security Key, 40
- Link Security Key parameter, 53
- login names, 35
- login privileges, 35
- loopback, 48, 49
 - external (local), 49
 - external (remote), 49
 - internal, 49

M

- Maximum RSL field, 59
- MIB files, 51
- Minimum RSL field, 59
- Minimum RSL Timestamp field, 59
- Mode parameter, 43
- mounting
 - hardware, 18
- multipath, 67
- multipath propagation, 68
- muting, 46

N

- noise profile, 6

P

- parameters
 - antenna port, 45
 - buzzer timeout selection, 45
- passwords, 8, 35, 53
- path obstruction, 70
- performance degradation, 67
- Performance page, 58
- power
 - system LEDs and, 23
- Power connector, 82
- power injector, 23
- power interface, 76
- Power/Ethernet connector, 20

R

- radio
 - default settings, 14

- grounding, 6, 70
- initiation tasks, 16
- installation tasks, 16
- maximum transmit power setting, 43
- mounting, 6, 18
- parameters, 9
- rebooting, 61, 64
- transmitter output power, 6
- Radio A, 14
- Radio A configuration, 7
- radio configuration, 7
- radio features, 4
- radio firmware files, 51
- radio frequency, 2
- Radio Information page, 38
- radio mount
 - enclosure, 3
 - connections, 4
 - indoor, 3
 - connections, 4
- Radio Name parameter, 52
- Radio Transmit Power parameter, 42
- Reboot page, 64
- received signal level (RSL). *See* RSL
- receiver threshold, 6
- receiver threshold performance, 9
- record keeping, 17
- regulatory requirements, 10
 - EIRP Canada, 11
 - FCC EIRP, 10
 - USA, 10
- regulatory requirements
 - Canada, 11
- RESET button, 22
- RF cable length, 4
- RF connector termination, 22
- RF Frequency parameter, 44, 53
- RF interface, 76
- RF interference, 69
- RF lightning arrestor, 29
- RF output power, 9
- RSL, 9
 - current RSL readings, 58
 - diagnostics, 62
 - Maximum RSL field, 59
 - Minimum RSL Timestamp field, 59
 - monitor for performance, 67
- RSL voltage, 30

S

- security mode, 8
- Set to E1 button, 47
- Set to T1 button, 47
- shipping box contents, 7
- site preparation, 6
- SNMP, 55
- specifications, 72
- Spectrum Analyzer page, 63
- Swap button, 51, 54

- System Configuration page, 42
- system latency, 6
- system parameters
 - default settings, 24
- system performance, 58
- system reboot, 61
- system settings
 - Current BER field, 58
 - Errored Seconds (ES) field, 59
 - grounding, 70
 - Maximum RSL, 59
 - Minimum RSL field, 59
 - Time Since Reset field, 59
 - Unavailable Seconds field, 59
- system specifications, 72

T

- T1 clocking, 21
- T1 Interface Configuration page, 48
- T1/E1 1&3 connector, 20
- T1/E1 2&4 connector, 20
- T1/E1 2&4 LED, 21
- T1/E1 circuits, 47
- T1/E1 Configuration page, 47
- T1/E1 configuration parameters, 53
- T1/E1 connections, 81
- T1/E1 connectors, 81
- T1/E1 interfaces, 76
- T1/E1 loopback, 49
- TDD factors, 12
- TDD frame length, 6, 7
- TDD frame size, 6
- TDD Frame Size parameter, 44, 53
- TDM circuit, 6
- TDM circuits, 43
- TDM interfaces, 13
- Telnet session, 32
- temperature, 62
- Temperature alarm, 57
- testing, 78
 - back-to-back bench, 8
 - threshold, 80
 - threshold measurement, 80
 - threshold measurement tests, 80
 - threshold testing, 80
- time division duplex (TDD). *See* TDD frame
- Time Since Reset, 59
- transmission line
 - coaxial, 27
- transmitter
 - output power, 9
 - transmitter output power, 6
- troubleshooting, 62, 66

U

- Unavailable Seconds (UAS), 59
- unfaded error-free performance, 9

Update button, 40
user privileges, 35

V

voltage test, 30
VSWR, 68



© 2006 Exalt Communications Inc.
580 Division St. Campbell, CA 95008 USA