

# **i-Series**

## **Digital Microwave Radios**

### **Installation and Management Guide**



#### **Models included:**

**EX-2.4i**  
**EX-2.4i-16**  
**EX-4.9i**  
**EX-5i**  
**EX-5i-16**



## Legal Notice

The information contained herein is the property of Exalt Communications, Inc. (“Exalt”) and is supplied without liability for errors or omissions. No part of this document may be reproduced, in any form, except as authorized by contract or other written permission from the owner.

Any brand names and product names included in this manual are trademarks, registered trademarks, or trade names of their respective holders.

The contents of this document are current as of the date of publication. Exalt reserves the right to change the contents without prior notice.

The publication of information in this document does not imply freedom from patent or other rights of Exalt or others.

© 2007 Exalt Communications Inc. All rights reserved.

The Exalt logo is a trademark of Exalt Communications, Inc.

## Open-Source License Information

In addition to proprietary software/firmware, which is the sole intellectual property of Exalt, the Exalt i-Series of Digital Microwave Radios make use of public (open-source) software/firmware within the terms of use of their respective shared license agreements. Exalt will supply copies of any of this code, within the terms of their individual licensing agreements, upon request.

<b>Open-Source Code</b>	<b>License Agreement</b>	<b>Website</b>
Linux Operating System	GNU GPL Version 2	<a href="http://www.gnu.org">www.gnu.org</a>
BusyBox CLI	GNU GPL Version 2	<a href="http://www.gnu.org">www.gnu.org</a> ; <a href="http://www.busybox.net">www.busybox.net</a>
GoAhead Web Server	Copyright (c) 2003 GoAhead Software, Inc. All Rights Reserved.	<a href="http://www.goahead.com">www.goahead.com</a>
U-boot Boot Code	GNU GPL Version 2	<a href="http://www.gnu.org">www.gnu.org</a> <a href="http://www.sourceforge.net">www.sourceforge.net</a>
Net-SNMP	(see <a href="#">Copyright Notices</a> on page 117)	<a href="http://www.sourceforge.net">www.sourceforge.net</a>

## About this Document

This manual provides a complete description of the Exalt i-Series of Digital Microwave Radios and related software. This manual provides planners, engineers, installers, system administrators, and technicians general and specific information related to the planning, installation, operation, management, and maintenance of these devices.

## Revision History

<b>Date</b>	<b>Products and Release code</b>
2006-04-28	EX-2.4i initial release v1.0
2006-05-03	EX-2.4i maintenance release v1.0.1
2006-07-06	EX-5i initial release v1.0.0
2006-09-01	EX-2.4i release v1.1.0 (Mode2 feature release) EX-2.4i-16 and EX-5i-16 initial release v1.0.0
2006-09-27	EX-5i release 1.1.0 (SNMP feature release)
2006-10-27	EX-2.4i v1.2.0 (Sync and VLAN feature releases) EX-5i release v2.0.0 (Sync and VLAN feature releases) EX-2.4i and EX-5i-16 v1.1.1 (Sync feature release)
2007-01-03	EX-4.9i initial release
2007-04-15	Draft for WEEE, RoHS, DFS
2007-06-11	Draft for RLK, EU, Regulatory Compliance Appendix
2007-06-25	Update for DFS, removed Proxim antenna

## General Compliance and Safety

The usage of radio transmission devices is subject to specific regulatory requirements governed by regional legislation. In most cases, the specific device must be authorized for use in a given country and must be installed and adjusted in accordance with specific radio-frequency settings and in a manner that has been authorized specific to the device itself in accordance with the specific location of the device. Some users may be completely or partially restricted from use of the device. Please consult local governmental agency/agencies for regulatory requirements before use, or contact Exalt or your Exalt authorized dealer for assistance.

Do not modify this device in any way without the express written consent of Exalt. Modification voids the manufacturer warranty, and may also be illegal in accordance to government regulations. In addition, there are no user-serviceable parts or assemblies inside the product housing. There may also be voltages, signals, and mechanisms within the device that could be harmful to human safety.

The mounting of this device and associated peripherals and connections (inclusive of antenna mast, antenna, cabling, egress, lightning protection devices, grounding, power, and so on) may be subject to regional requirements for health and human safety. A qualified professional installer and an electrician are highly recommended, and may be required by law.

**Exalt cannot warranty the device or be found liable for any unauthorized use or installation of the device.**

### Safety Icons

The following icons denote specific types of information.

 **Note** This symbol means take note. Notes contain helpful suggestions or references to materials not contained in the manual.

 **Caution** This symbol means be careful. There is a risk of equipment damage, loss of data, or injury to persons. To reduce the risk, follow the instructions. This is a general warning, caution, or risk of danger.

 **Warning** This warning symbol means there is a risk of electric shock. This situation could cause bodily injury. To reduce the risk, before working on any equipment, be aware of the hazards involved with electrical circuitry and be familiar with standard practices for preventing accidents.

## **Safety Notices**

1. Review this entire guide for important installation instructions **BEFORE** attempting to install this product.
2. This product is intended to be installed, used, and maintained by experienced telecommunications personnel only.
3. Employ a properly licensed or authorized electrician to install or evaluate/certify the installation of all power and grounding related to the use of this equipment and all connected devices.
4. The device(s) shall only be connected to AC or DC sources within the device specifications. Use a separate breaker circuit at the power source.
5. Lightning, surge protection devices, and earth grounding are required for most installations to ensure human safety. Consult a qualified electrician.
6. Servicing of this device should be performed by authorized personnel only. Do not disassemble this device. By opening or removing any covers you may expose yourself to hazardous energy parts. Incorrect reassembly of this product can cause a malfunction, and/or electrical shock, when the unit is subsequently used.
7. Do not connect or disconnect the power connection to the device when the power supply is plugged into an AC outlet. To connect, first connect the power connection to the device, and then apply power (or plug in) at the outlet. To disconnect, disengage power at the outlet or unplug, and then disconnect the direct connection to the device.
8. Do not insert any object of any shape or size inside this product at any time, whether powered or not. Objects may contact hazardous energy components that could result in a risk of fire or personal injury.
9. Liquids shall not come in contact with, or enter the inside of the device at any time.
10. Proper ventilation and/or airflow shall be provided surrounding the equipment. Do not block any intake or exhaust vents. Items shall not come in contact with heat-sinking materials. Ensure that ambient operational and storage temperature specifications are maintained at all times.
11. Equipment is suitable for mounting on noncombustible surfaces only.
12. Do not move or alter the marking labels.
13. A CSU or similar isolating device is necessary between the equipment and the public telecommunications network. The equipment has not been evaluated for direct connection to the public telecommunications network.

## **Exalt Limited Hardware Warranty**

Exalt Communications, Inc. (“Exalt”) warrants solely to the original purchaser (“Purchaser”) that the EX-2.4i, EX-2.4i-16, the EX-5i, EX-5i-16 or the EX-4.9i (the “Product”) will substantially conform in all material respects to the relevant Exalt published specifications that apply at the time of manufacture of such Product for two (2) years from the date of tender of Product by Exalt from FOB point designated by Exalt (the “Warranty Period”). Proof-of-purchase in the form of an invoice, payment of invoice, or delivery waybill must be supplied, if requested by Exalt, in case of any dispute of warranty start date. Exalt shall within the Warranty Period, at its own option: (A) use reasonable efforts to remedy any reproducible Product defect covered by this limited warranty within a reasonable period of time; (B) replace the defective Product with a functionally equivalent product (repair parts and products may be either reconditioned or new, but, if reconditioned, shall be of the same quality as new parts or products); or (C) if Exalt determines that it is unable to repair or replace such Product, Exalt will refund to Purchaser the amount actually paid by Purchaser for the applicable Product. All replaced parts become the property of Exalt. Exalt may, at its sole option, refuse to accept as defective Product that (i) is subject to the exclusions set forth below; or (ii) cannot be demonstrated to be defective by Exalt and Purchaser is unable to provide adequate information describing how the Product failed. Such Product will, at Purchaser’s option and expense, either be: (a) returned to Purchaser in the state received, or (b) repaired and returned to Purchaser. Repaired or replaced Product will be warranted for the remainder of the original Warranty Period, but not less than ninety (90) days.

### ***Registration***

Purchaser is required to register its Product, within ninety (90) days of purchase, for full warranty support. Unregistered or late-registered Product will receive a Warranty Period of only one (1) year.

### ***Exclusions***

This limited warranty will not apply to: (A) any Product that: (i) has been modified or altered by any party other than Exalt; (ii) has been subject to accident, misuse, abnormal wear and tear, neglect, or mistreatment; (iii) has been damaged during installation of the Product; (iv) has been damaged by the equipment or system with which the Product is used; (v) has sustained damage to the Products’ interface or power connectors; (vi) are determined to be stolen; or (vii) has been damaged caused by fire, power changes, other hazards, or acts of God (including without limitation lightning); or (B) any software included in any such Product. The warranty applies only to Products that can be identified by the Exalt trademark, trade name, serial number or logo affixed to them. Exalt does not warrant any Product that is not manufactured by, for, or with permission from Exalt. The Products covered by this warranty are not consumer products and are not intended for personal, family, or household purposes.

## **RMA Procedures**

A return material authorization (RMA) is required prior to returning Product to Exalt for warranty or out-of-warranty repair/evaluation. As such, Purchaser must use the following procedure:

1. Contact Exalt and request an RMA number. Please be prepared to provide the serial number of the Product, the date of purchase, and a description of the failure that is as complete as possible.
2. Pack the Product in its original container and packing or an equivalent.
3. Write the RMA number CLEARLY on the outside of the shipping box.
4. For services during the Warranty Period, cost of shipment to Exalt's authorized service center, taxes, duty, tariffs, risk of loss and insurance charges to Exalt shall be borne by the Purchaser. Cost of return shipment and insurance charges shall be borne by Exalt and will be made by Exalt's choice of carrier and method/schedule of shipment. Purchaser may expedite return shipments, upon request, at its own expense.

**PRODUCTS RETURNED WITHOUT A DULY ISSUED RMA NUMBER WILL BE RETURNED TO PURCHASER AT PURCHASER'S EXPENSE.**

**THIS EXPRESS WARRANTY IS IN LIEU OF ALL OTHER WARRANTIES, EXPRESSED, IMPLIED OR STATUTORY, REGARDING THE PRODUCT, AND EXALT, ITS SUPPLIERS AND LICENSORS HEREBY EXPRESSLY DISCLAIM ALL SUCH IMPLIED AND EXPRESS WARRANTIES, INCLUDING WITHOUT LIMITATION ANY AND ALL IMPLIED WARRANTIES OF FITNESS FOR A PARTICULAR PURPOSE, TITLE, INTERFERENCE WITH QUIET ENJOYMENT, NON-INFRINGEMENT OF THIRD-PARTY RIGHTS AND MERCHANTABILITY. FURTHER, EXALT DOES NOT WARRANT RESULTS OF USE OR THAT PURCHASER'S USE OF THE PRODUCT WILL BE UNINTERRUPTED OR ERROR FREE. NO WARRANTIES ARE MADE BY EXALT'S SUPPLIERS OR LICENSORS. EXCEPT FOR THE EXPRESS WARRANTY STATED HEREIN, THE PRODUCT IS PROVIDED "AS IS" AND WITH ALL FAULTS. THE ENTIRE RISK AS TO SATISFACTORY QUALITY, ACCURACY, AND EFFORT IS WITH PURCHASER.**

**REGARDLESS OF WHETHER ANY REMEDY SET FORTH HEREIN FAILS OF ITS ESSENTIAL PURPOSE OR OTHERWISE, AND EXCEPT FOR BODILY INJURY, IN NO EVENT WILL EXALT, ITS SUPPLIERS OR LICENSORS BE LIABLE TO PURCHASER OR TO ANY THIRD PARTY UNDER ANY TORT, CONTRACT, NEGLIGENCE, STRICT LIABILITY OR OTHER LEGAL OR EQUITABLE THEORY FOR ANY LOST PROFITS, LOST OR CORRUPTED DATA, COMPUTER FAILURE OR MALFUNCTION, INTERRUPTION OF BUSINESS, OR OTHER SPECIAL, INDIRECT, INCIDENTAL OR CONSEQUENTIAL DAMAGES OF ANY KIND ARISING OUT OF THE USE OR INABILITY TO USE THE PRODUCT, EVEN IF EXALT HAS BEEN ADVISED OF THE POSSIBILITY OF SUCH LOSS OR DAMAGES AND WHETHER OR NOT SUCH LOSS OR DAMAGES ARE FORESEEABLE.**



IN NO EVENT SHALL EXALT'S AND ITS SUPPLIERS' AGGREGATE LIABILITY EXCEED AN AMOUNT EQUAL TO THE PURCHASE PRICE OF THE PRODUCT PAID BY PURCHASER THAT IS THE SUBJECT OF A CLAIM. ANY CLAIM ARISING OUT OF OR RELATING TO THIS AGREEMENT MUST BE BROUGHT WITHIN ONE (1) YEAR AFTER THE OCCURRENCE OF THE EVENT GIVING RISE TO SUCH CLAIM. IN ADDITION, EXALT DISCLAIMS ALL LIABILITY OF ANY KIND OF EXALT'S SUPPLIERS.

## Table of Contents

Legal Notice.....	1
Open-Source License Information.....	1
About this Document.....	2
Revision History.....	2
General Compliance and Safety.....	3
Safety Icons.....	3
Safety Notices.....	4
Exalt Limited Hardware Warranty.....	5
Registration.....	5
Exclusions.....	5
RMA Procedures.....	6
Introduction.....	15
Related Documentation and Software.....	15
The Exalt i-Series of Digital Microwave Radios.....	16
Basic Features.....	18
Pre-installation Tasks.....	21
Link Engineering and Site Planning.....	21
Familiarization with i-Series Radios.....	22
Shipping Box Contents.....	23
Back-to-Back Bench Test and Configuration.....	24
RF Output Power Setting.....	25
Time Division Duplex (TDD) Factors.....	25
Link Orientation and Synchronization.....	26
Radio A/B Configuration.....	27
Radio Synchronization.....	28
Synchronization Modes.....	29
Internal Synchronization.....	29
External Synchronization.....	31
Offset Timing.....	31
When Sync is Lost.....	32

LEDs .....	32
System Installation and Initiation Process .....	33
Record Keeping .....	34
Installation.....	35
Mechanical Configuration and Mounting.....	35
Rack Mounting.....	35
Table or Rack Shelf Mounting the System.....	37
Radio Ports and Indicators .....	37
Connector Overview .....	37
LED Indicators.....	39
RMT (Remote) Button.....	41
Power .....	41
Terminating the RF Connector .....	41
AC Power.....	42
DC Power.....	43
Reset to Critical Factory Settings .....	44
Antenna/Transmission System.....	45
Initial Antenna Mounting.....	45
Transmission Line from Antenna to Egress.....	46
RF Lightning Arrestor.....	48
Transmission Line from Egress to Radio.....	49
Antenna Alignment.....	50
Configuration and Management .....	52
Command Line Interface (CLI) .....	52
Connect to the Radio with a Serial Connection .....	52
Connect to the Radio through a Telnet Connection.....	52
CLI Screens and Menus .....	53
Exalt Graphical User Interface (GUI).....	54
Preparing to Connect.....	54
Make Connections .....	55
Log In.....	55
Login Privileges .....	56

Quick-Start.....	57
Navigating the GUI.....	58
Summary Status Section .....	59
Navigation Panel.....	60
Radio Information Page .....	61
Administration Settings Page.....	62
System Configuration Page.....	64
Ethernet Interface Configuration Page.....	68
T1/E1 Configuration Pages.....	69
T1 Interface Configuration Page.....	69
E1 Interface Configuration Page.....	70
T1/E1 Loopback.....	71
File Transfer Page .....	73
File Activation Page.....	76
Simple Network Management Protocol (SNMP) Configuration.....	77
Alarms Page .....	78
Performance Page .....	80
Event Log Page .....	83
Diagnostic Charts Page.....	85
Spectrum Analyzer Page.....	87
Reboot Page .....	88
Manual Page.....	89
Troubleshooting .....	90
General Practices .....	90
Typical Indications of Issues .....	91
Improper RF Cable Termination.....	92
Multipath Propagation .....	93
RF Interference .....	93
Path Obstruction.....	94
Misaligned Antenna .....	94
Faulty Antenna.....	94
Improper Grounding .....	95

Insufficient Link Margin.....	95
Moisture in the Transmission System.....	95
Specifications .....	96
Physical Specifications .....	96
Common System Specifications .....	96
EX-2.4i System Specifications .....	97
EX-4.9i System Specifications .....	98
EX-5i System Specifications, 5.3 GHz Band .....	99
EX-5i System Specifications, 5.4 GHz Band .....	100
EX-5i System Specifications, 5.8 GHz Band .....	101
Interfaces.....	102
Back-to-back Bench Testing.....	104
Basic Test.....	104
Specification Performance Verification.....	105
DC Coupler for Antenna Alignment.....	107
Required Items .....	107
Interconnections .....	107
Interface Connections .....	109
T1/E1 Connections.....	109
Ethernet Connections .....	110
Sync Connections.....	111
Alarm Connector.....	112
Console Connector.....	113
DC Power Connector .....	113
DIP Switch Settings (-16 Models Only).....	114
Copyright Notices .....	117
Net-SNMP.....	117
General Regulatory Notices.....	123
Dynamic Frequency Selection .....	123
Antennas .....	123
Region 1 Specifics .....	127
Federal Communications Commission (FCC), United States .....	127

Industry Canada (IC), Canada.....	128
Antennas Supported in Canada.....	129
4.9 GHz Model.....	127
United States Compliance.....	128
Canada Compliance .....	129
EX-2.4i EIRP for the USA and Canada.....	131
EX-4.9i EIRP for the USA and Canada.....	131
EX-5i EIRP for the US and Canada.....	132
Region 2 Specifics .....	134
Europe/ITU (ETSI and CE Mark).....	134
Declaration of Conformity to the R&TTE Directive 1999/5/EC.....	135
EU WEEE .....	135
EU RoHS .....	136
Europe Compliance.....	136
EX-2.4i EIRP by Country .....	138
EX-5i EIRP by Country .....	140
5250–5350 MHz band.....	140
5470–5725 MHz band.....	140
5725-5850 MHz band .....	140
Index .....	143

## List of Figures

Figure 1	EX-2.4i Digital Microwave Radio.....	16
Figure 2	Indoor mount interconnection.....	19
Figure 3	Enclosure mount interconnection .....	19
Figure 4	Basic radio interconnectivity using internal synchronization.....	29
Figure 5	Collocated radios, one in AUTO SYNC mode to provide redundancy .....	30
Figure 6	Multiple-link site configuration, using AUTO SYNC for redundancy .....	30
Figure 7	GPS as primary sync source using AUTO SYNC .....	31
Figure 8	Synchronized GPS sources using AUTO SYNC.....	31
Figure 9	Radio installation tasks .....	33

Figure 10	Front flush mount configuration .....	35
Figure 11	Front projection mount configuration.....	36
Figure 12	Rear-mount locations .....	36
Figure 13	Front panel (EX-2.4i, EX-4.9i or EX-5i).....	37
Figure 14	Front panel (EX-2.4i-16 or EX-5i-16) .....	37
Figure 15	Primary front panel connectors (standard models) .....	38
Figure 16	DC connector .....	44
Figure 17	CLI main menu .....	53
Figure 18	Initiating the browser connection.....	55
Figure 19	Browser Login screen .....	56
Figure 20	Radio Information page .....	57
Figure 21	Exalt GUI window description .....	59
Figure 22	Minimized browser windows for summary status of multiple radios.....	59
Figure 23	Radio Information page .....	61
Figure 24	Administration Settings Page.....	62
Figure 25	System Configuration Page.....	64
Figure 26	Ethernet Interface Configuration Page.....	68
Figure 27	T1 Interface Configuration page (standard models) .....	70
Figure 28	E1 Interface Configuration page (standard models) .....	71
Figure 29	External (remote) loopback.....	72
Figure 30	External (local) loopback.....	72
Figure 31	Internal loopback .....	72
Figure 32	File Transfer Page.....	73
Figure 33	File Transfer page—download file link.....	74
Figure 34	File Activation page.....	76
Figure 35	Alarms page (standard models) .....	78
Figure 36	Performance page.....	80
Figure 37	Event Log page .....	83
Figure 38	Diagnostic Charts page .....	86
Figure 39	Reboot page .....	88
Figure 40	Manual page.....	89
Figure 41	Basic back-to-back bench test configuration .....	105

Figure 42	DC coupler interconnection .....	108
Figure 43	T1/E1 connectors .....	109
Figure 44	Ethernet connectors (MAIN and AUX).....	110
Figure 45	Sync In connector .....	111
Figure 46	Sync Out connector.....	111
Figure 47	Alarm Connector.....	112
Figure 48	Console Connector.....	113
Figure 49	DC Power connector .....	113
Figure 50	DIP Switch Orientation.....	114

## List of Tables

Table 1	Factory Default Settings .....	27
Table 2	Connectors .....	38
Table 3	LED indicators .....	39
Table 4	Recommended transmission line .....	46
Table 5	Default Login Information.....	56
Table 6	DIP Switch Functions .....	114
Table 7	Standard Factory Defaults (-16 Models).....	115
Table 8	Common DIP Switch Applications.....	115
Table 9	Product Approvals .....	122
Table 10	EX-2.4i supported antennas.....	124
Table 11	EX-5i supported antennas.....	125
Table 12	Region 2 Country Specific Power Levels for EX-2.4i Series.....	139
Table 13	Region 2 Country Specific Power Levels for EX-5i Series.....	142



## **Introduction**

Exalt Communications, Inc. thanks you for your purchase. Our goal is to build the highest quality, highest reliability digital microwave radio products. This commitment to quality and reliability extends to our employees and partners alike. We appreciate any comments on how we can improve our products, as well as your sales and Customer Care experience.

Customer Care Hotline (USA):	(408) 871-9890
Toll-Free Customer Care Hotline (USA):	(877) EXALT-01 (392-5801)
Direct-Dial Telephone (USA):	(408) 871-1804
Website:	www.exaltcom.com
Sales e-mail:	sales@exaltcom.com
Customer Care e-mail:	support@exaltcom.com
Mailing Address:	Exalt Communications, Inc. 580 Division St. Campbell, CA 95008 USA

## ***Related Documentation and Software***

This manual makes reference to other documentation and software files that may be necessary. Any document or software mentioned in this manual can be found at:

<http://www.exaltcom.com/support/downloads.htm>

The Quick Start Guide provides any necessary username and password information to gain access to these documents.

## **The Exalt i-Series of Digital Microwave Radios**

The Exalt i-Series of Digital Microwave Radios are the most advanced carrier-class point-to-point terrestrial radio communications devices operating in the 2400 to 2483.5 MHz, 4940 to 4990MHz and 5250 to 5850MHz frequency bands, respectively. Figure 1 shows the EX-2.4i Digital Microwave Radio.



Figure 1 EX-2.4i Digital Microwave Radio

The i-Series radios connect voice and/or digital data from one location to another, obviating the need for copper or fiber connectivity, or enhancing existing connectivity by providing a redundancy solution, a primary solution, and/or additional capacity.

The following models of radios are covered in this manual:

- **EX-2.4i, 10/100 Ethernet + 4xT1/E1**
  - Configured for 100Mbps (32MHz/Mode2)
- **EX-2.4i-16, 10/100 Ethernet + 16xT1/E1**
  - Configured for 4xT1/E1, 100Mbps (32MHz/Mode2)
  - With license-key upgrade for 8xT1/E1, 100Mbps (32MHz/Mode2)
  - With license-key upgrade for 12xT1/E1, 100Mbps (32MHz/Mode2)
  - With license-key upgrade for 16xT1/E1, 200Mbps (64MHz/Mode2)
- **EX-4.9i, 10/100 Ethernet + 4xT1/E1**
  - Configured for 2xT1/E1, 27Mbps (10MHz/Mode2, 20MHz/Mode1)
  - With license-key upgrade for 4xT1/E1, 55Mbps (20MHz/Mode2)
- **EX-5i, 10/100 Ethernet + 4xT1/E1**
  - Configured for 100Mbps (32MHz/Mode2)
  - With license-key upgrade for 200Mbps capacity (64MHz/Mode2)
- **EX-5i-16, 10/100 Ethernet + 16xT1/E1**
  - Configured for 4xT1/E1, 100Mbps (32MHz/Mode2)
  - With license-key upgrade for 8xT1/E1, 100Mbps (32MHz/Mode2)

- With license-key upgrade for 12xT1/E1, 100Mbps (32MHz/Mode2)
- With license-key upgrade for 16xT1/E1, 200Mbps (64MHz/Mode2)

 **Note:** Not all software features mentioned in this document are enabled on all radios with the current firmware releases. Please note the revision history in the front section of the manual and check the Exalt website download section to verify the most recent firmware release available for your product.

 **Note:** This manual uses terminology to distinguish the characteristics of specific radio models. The term *standard* refers to the EX-2.4i, EX-4.9i and EX-5i models. The term *-16* refers to the EX-2.4i-16 and EX-5i-16 models. When no specific mention is made or the term *i-Series* is used, this refers to all models.

Generally, the i-Series models require a clear line-of-sight and proper path clearance to achieve a high-performance, reliable connection. Perform professional path engineering and site planning BEFORE installing this equipment.

The primary focus of this document is the installation and maintenance of the digital microwave radio, and assumes that path engineering and site planning has already been performed. Please refer to the Exalt document, *Guidance for Engineering and Site Planning of Terrestrial Wireless Links*, for detailed information on these activities.

The EX-2.4i models utilize radio frequencies in the range of 2400 to 2483.5MHz. The EX-5i models utilize radio frequencies in the range of 5250 to 5850 MHz. In most countries these frequency bands are considered as ‘license-exempt’ or ‘unlicensed.’ This means that virtually any user may use these frequencies freely, without paying for access, or any type of pre-notification, post-notification or registration. As a result of this designation, users may also move or change these systems at any time, with significant flexibility to the location, orientation and configuration of the system. However, due also to this designation, there may be uncontrolled interference from other similar devices that occupy this spectrum. In these cases, it is up to engineering and maintenance personnel to design the system with existing and future interference sources in mind, recognizing that there is a chance that the interference conditions could be very dynamic, and outages may occur on the system as a result, and that, in some very rare cases, the system may cause interference into another system and may be required to be disengaged or modified/re-oriented to eliminate the interference.

If the spectrum in your country is designated as ‘license-exempt’ or similar, this does not infer that the installer may configure the system in **any** manner at **any** location. In most cases, there are regulations, or device-based conditions that limit the use of the device, such as maximum gain antenna, antenna types and maximum output power, as well as, in some cases, application limits, limited geography of use, and other unique regulations. **The link design engineer and/or professional installer must determine these limitations and engineer/install the system within the confines of all local regulations.** Also, it is required to examine any regulations that may apply to peripheral

equipment, installation and cabling of the system that may be regulated for human safety, electrical code, air-traffic control, and other safety-related categories.

In certain countries, the spectrum for this product is **NOT** considered to be license-exempt. In these cases, there may be additional regulatory requirements concerning the location, frequency, power, orientation, configuration, and other aspects of the system, including, in some cases, a need for link registration, coordination, and fees that may apply to the system usage. Please consult your local regulatory organization(s) to determine usage requirements.

The EX-4.9i utilizes frequencies in the 4940-4990MHz range, and is typically a licensed band reserved for use by Public Safety agencies and applications. This band is not generally available outside of North America.

In almost all cases, either for license-exempt or other designation, the product itself must be authorized for use in your country. Either Exalt or Exalt's agent must have applied for certification or authorization to allow the sale and deployment of the system within the country. It is also possible that only certain versions or configurations of the device are allowed within a particular country. Please contact Exalt or your authorized Exalt representative for information pertaining to your country.

**Note: It is the professional installer's responsibility to ensure that the radio system is implemented in a legal fashion. Exalt is not liable for any unsafe or illegal installations.**

## ***Basic Features***

The i-Series Digital Microwave Radios are single integrated units intended for all-indoor or enclosure-based mounting. The associated antenna is typically mounted on a tower or rooftop mast structure with RF cabling running from the antenna location, with an egress through the structure or enclosure, with proper lightning suppression and grounding, to the RF connector of the radio. In turn, the communications interfaces and power connections are directly applied to the radio, or in some cases, also with an egress through the structure or radio enclosure with proper lightning or surge-suppression devices and associated grounding.

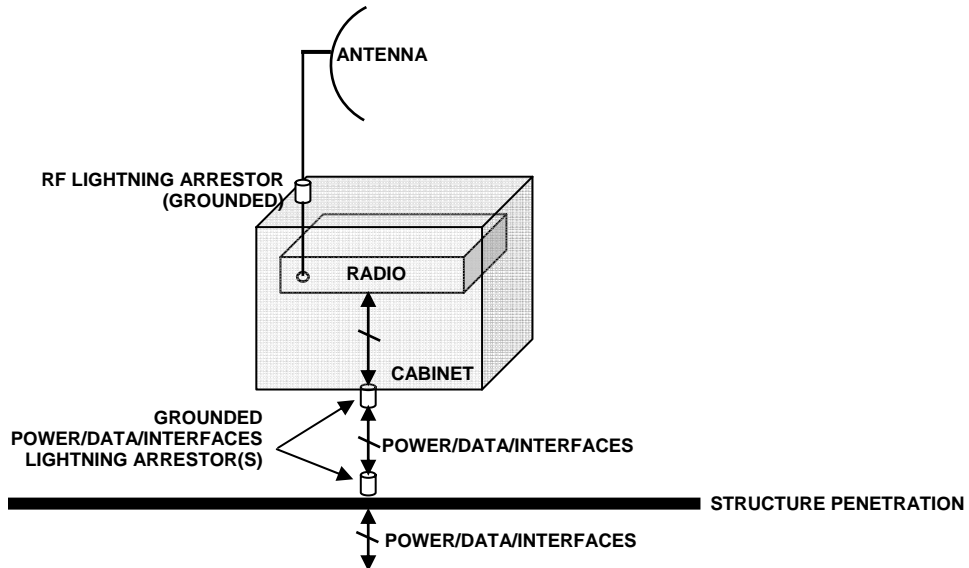
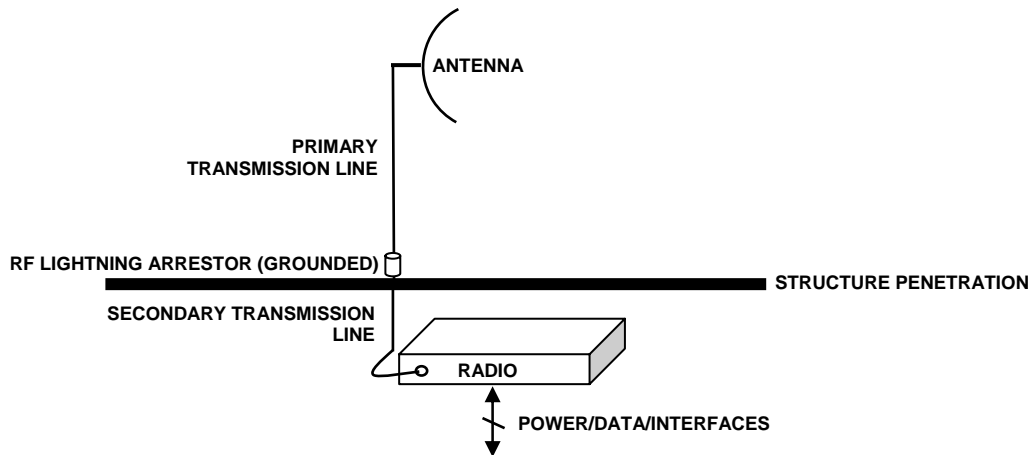

Figure 2 Indoor mount interconnection

Figure 3 Enclosure mount interconnection

For highest performance and reliability, it is advised to minimize the length of RF cable and associated transmission system losses between the antenna and the radio's antenna port.

All models provide connections for a combination of the following data communication interfaces:

- 10/100BaseT Ethernet
- Up to 16xT1/E1 interfaces for synchronous voice traffic (number of TDM interfaces is determined by specific model and license-key configuration)

The i-Series radios feature a wide-mouth direct DC connection (24V or 48V), and are also provided with an external AC adapter.

All models provide the following primary features and benefits:

- Low-latency optimization and control for voice and data connections
- Very high throughput and flexible interface configurations with voice+data combinations
- Encryption for extreme wireless security
- Easy-to-use management and configuration
- Flexible utilized channel bandwidth selection for interference avoidance and frequency coordination
- Flexible center frequency tuning for interference avoidance and frequency coordination
- Flexible capacity to meet current connection requirements and future growth needs
- Carrier-class reliability and performance
- Intuitive graphical user interface for fast and easy configuration and management
- Advanced diagnostics monitoring and analysis tools for fast and easy troubleshooting

## Pre-installation Tasks

This section describes the steps necessary to prepare a site for the installation of the Exalt Digital Microwave Radio.

### ***Link Engineering and Site Planning***

Design all terrestrial wireless links prior to purchase and installation. Generally, professional wireless engineering personnel are engaged to determine the viability and requirements for a well-engineered link to meet the users' needs for performance and reliability.

The reader is referred to the Exalt document, ***Guidance for Engineering and Site Planning of Terrestrial Wireless Links*** and the ExaltCalc path calculator. This document and calculator aid in the pre-planning and engineering required to determine following attributes:

- Antenna type/gain at each end of the link
- Antenna mounting height/location for proper path clearance
- Antenna polarization orientation
- RF cabling type, length, connectors, route, and mounting
- Antenna system grounding
- Lightning arrestor type(s), location(s), and grounding
- Radio mounting location and mechanisms
- Radio grounding
- Radio transmitter output power setting
- Anticipated received signal level (RSL) at each end
- Anticipated fade margin and availability performance at each end
- Radio settings for TDD frame length and occupied bandwidth
- Anticipated throughput performance (TDM circuit support and Ethernet)
- Anticipated system latency

With respect to radio path and site planning, these radios are generally identical to any other microwave terrestrial wireless systems. Engineering of these systems requires specific knowledge about the radios, including:

- RF specifications (transmitter output power, receiver threshold, occupied channel bandwidth, and carrier-to-interference tolerance)
- Regulatory limitations on transmitter output power setting and antenna type/gain
- Noise/interference profile for the intended location

- Impact on throughput and latency relative to link distance, occupied bandwidth, and TDD frame size setting, and the planned implementation of these parameters

## **Familiarization with i-Series Radios**

The i-Series radios utilize time division duplex (TDD) radio transmission. This means that the transmitted signal in both directions uses the same center frequency and transmits in one direction for a period of time, and then in the opposite direction for another period of time. This total period of time is referred to as the *frame length* or *TDD frame length*, and is further discussed in Time Division Duplex (TDD) Factors on page 25.

The two radio terminals are identical hardware, except for the TDD setting in software. When the radios are in their default state, both radios are configured as Radio B. **One end of the link must be configured as Radio A before the two ends of the radio system can communicate.**

It can be considered that Radio A is the primary radio in the link. Radio A provides the master clock and control to Radio B. For most applications, it is not important how the radio link is oriented, only that one end is configured for Radio A and the other for Radio B. For some applications (such as, multi-radio hub sites or repeaters), the orientation of the radio systems may be more critical. See Link Orientation and Synchronization on page 26 for details.

There are three ways to configure the radios for Radio A/B determination:

1. Use the Exalt browser-based graphical user interface (GUI) – preferred.
2. Use the temporary hardware configuration key, in case of emergency (all models except for -16 models).
3. Use the front panel DIP switch, in case of emergency (-16 models only).

Exalt recommends using the Exalt GUI for radio configuration. This interface requires a computer with an Ethernet port and web browser software, such as Microsoft Internet Explorer 5.0 or above. See Configuration and Management on page 52 for details on how to connect to and use the browser-based GUI interface.

**Standard models:** The temporary hardware configuration key can be used when no computer is available to complete Radio A/Radio B configuration and there is a need for immediate bench testing or initial link installation and/or antenna alignment. See Radio A/B Configuration on page 27 for details on the temporary hardware configuration key.

**-16 models:** The front panel DIP switch provides a fast temporary means for Radio A/Radio B configuration. See DIP Switch Settings (-16 Models Only) on page 114 for details.



## Shipping Box Contents

Unless purchased as a spare terminal, the radios are shipped as a complete *hop* (that is, a radio link pair consisting of two terminals). An outer box has labeling that indicates the contents of the box, with the part number and serial number details for both radio terminals.

Inside the outer box are two identical boxes, each of these boxes is also marked with the part number and serial number of the individual terminal contained inside the box. The terminal box contains the following items:

- Radio terminal (configured as Radio B)
- AC adapter
- Accessory kit
  - Rack mount flanges
  - Flange mounting hardware (4 x M4 screws; 4 x M4 wave washers)
  - DC power connector (1)
  - Temporary hardware configuration key (1 x 9-pin connector, labeled “A”)
  - Grounding hardware (1 x M5 screw; 1 x M5 wave washer; 2 x M5 flat washers)
  - Radio A temporary hardware configuration key (for standard models only)
- Registration card
- Quick-start guide

Inspect the outer packaging and the contents of the boxes upon receipt. If you suspect any shipping damage or issues with the contents, contact Exalt Customer Care.

 **Note: Register your system as soon as possible.** A 2-year Warranty period applies to products registered within 90 days of purchase. The Warranty period is reduced to 1-year for unregistered products and products registered after the first 90 days.

## **Back-to-Back Bench Test and Configuration**

Every Exalt digital microwave radio goes through extensive quality testing and performance evaluation over the full operating temperature range prior to shipment. However, before installation, it is strongly advised to perform several tests and tasks that are much more difficult to perform once the radio link endpoints are distant from one another. A back-to-back bench test and pre-configuration will provide confidence that the radio link is operational and properly configured *prior* to installation, so that if troubleshooting is necessary, the radio hardware and configuration settings are eliminated from the troubleshooting process. Verify the following in the back-to-back testing:

- Confirm that the radio system is generally operational
  - Radios power-up with planned power and wiring solutions
  - RF link connects in both directions
  - Traffic passes across the link
- Configure connected equipment and cabling
  - Test Ethernet (CAT5) cabling, and/or T1/E1 cabling, any auxiliary connector cabling and configure all interfaces
  - Configure IP settings for configuration and management
  - Configure passwords and security modes
  - Become familiar with the configuration and management interfaces through the Exalt GUI interface
- Configure radio parameters
  - Set transmitter output power to engineered or allowed level (see [RF Output Power Setting](#) on page 25)
  - Set operating center frequency
  - Set link distance, occupied channel bandwidth, and frame length
- Make detailed radio performance measurements
  - Measure transmitter output power
  - Measure receiver threshold performance
  - Confirm unfaded error-free performance

Some of these tasks may not be possible or practical within a bench test environment due to the nature of the remote connectivity of peripheral equipment. However, it is good practice to perform as much as possible in this environment to minimize field/installation time and troubleshooting efforts.

Detailed performance measurements are usually not required for pre-installation, but can be easily performed at this stage and may be helpful for later troubleshooting efforts or for internal records. During troubleshooting, there may often be a point at which a back-to-back bench test should be performed to verify many or all of the above items, and in the case of a suspected faulty device, to help confirm the fault and determine which end of the system is at fault and in need of repair or replacement.

 **Note:** See Back-to-back Bench Testing on page 104 for detailed instructions.

## **RF Output Power Setting**

The maximum RF output power is bounded by one of the following criteria:

- Maximum RF output power setting capability of the radio device
- Maximum RF output power allowed/authorized by the local government regulations and for this specific device
- Maximum effective isotropic radiated power (EIRP) of the transmission system allowed/authorized by the local government regulations and for this specific device
- Desired RSL to not exceed the maximum RSL allowed by the device
- Desired RSL to minimize/eliminate interference into neighboring systems

 **Note:** In many cases the radio must be pre-configured for legal maximum output power before connecting to the antenna and transmission system. Instructions for adjusting the output power can also be found in System Configuration Page on page 64.

The following information on how to set the proper power for each country is based on the ~~pertains to~~ specific regulatory requirements based on up-to-date information for countries where these radios are authorized is in Appendix A. A list of recommended antennas is listed in Antenna/Transmission System on page 45.

## **Time Division Duplex (TDD) Factors**

The i-Series radios are very dynamic, allowing the installer to optimize and control the performance of the radio system for the intended application. The following parameters must be carefully determined during the link engineering phase:

- Link distance
- Bandwidth
- TDD frame size
- Mode (modulation)

The setting of the above parameters determines the following performance factors:

- Number of supported T1/E1 channels
- Ethernet throughput
- System latency (delay)

Use the **ExaltCalc** calculator to determine optimum settings for the above parameters to meet the needs of your application.

The following generalizations can be made with regards to these factors:

- The shorter the TDD frame size, the lower the latency
- The shorter the link distance, the lower the latency, the higher the throughput
- The longer the TDD frame size, the higher the throughput
- The higher the bandwidth, the higher the capacity
- The higher the mode, the higher the capacity

 **Note:** Disable all T1/E1 ports if there are no T1/E1 interfaces connected. This shifts all available throughput to the Ethernet interface.

 **Note:** If a selected combination of the Link Distance, Frame Size, Bandwidth, and Mode parameters cannot support all the desired T1 or E1 ports, the ports that cannot be supported are automatically disabled. Priority is placed on the T1/E1 port number. That is, the first port to be disabled, if necessary, is the highest port number, such as Port 4 for the standard models, and Port 16 for '-16' models (assuming that all 16 TDM interfaces are licensed for use). See [T1/E1 Configuration Pages](#) on page 69 for more information.

## **Link Orientation and Synchronization**

Link *orientation* refers to the Radio A and Radio B placement in your network. Link *synchronization* refers to using external or internal timing to coordinate multiple links.

For every link, one end of the radio link must be configured as Radio A, while the other end is configured as Radio B. In single-link systems, it does not matter which end of the system is mounted at which end of the link, and there is typically no requirement for any link synchronization.

Link orientation and synchronization are more important for networks with site(s) where there is more than one link of the same type or for sites using the same type of radio that are very close to each another at one or both ends.

It can be advantageous to utilize link synchronization for collocated links. The radios allow the use of an optional GPS synchronization kit or internal synchronization. This synchronization controls the transmitter and receiver frame timing so that collocated radios are transmitting at the same time and receiving at the same time. This can substantially reduce the opportunity for self-interference. Without synchronization,

collocated radios may be transmitting and receiving at the same time, incurring near-end interference.

**Note:** It is not always necessary to synchronize collocated radios. If antennas are substantially separated or blocked from one another and/or frequency separation tuning is used, the opportunity for near-end interference can be eliminated.

**Note:** Internal and/or GPS sync features are not released for all models as of printing. Contact your Exalt Communications representative for details.

### Radio A/B Configuration

Use the Exalt GUI to configure the radio terminals for Radio A and Radio B orientation. Since many other parameters also need to be set, and the Exalt GUI is needed for these configurations, this is the best way to completely configure the radio terminals.

Radios arrive from manufacture in default configuration, orientated as Radio B and configured as shown in Table 1.

Table 1 Factory Default Settings

Parameter	EX-2.4i	EX-4.9i	EX-5i
Frequency	2441	4965 MHz	5788
Transmit Power	+7 dBm	+4dBm	+4dBm
Bandwidth	8MHz	10MHz	8MHz
Mode	Mode 1		
Link Distance	<10 miles		
TDD Frame Size	2ms		
Link Security Key	000000000000		
Administration Password	password		
User Password	password		
IP Address	10.0.0.1		
IP Mask	255.0.0.0		
IP Gateway	0.0.0.0		
Ethernet Interfaces	Enabled, 100/Full		
AUX port NMS Access	In-Band		
T1/E1 Settings (-16 models)	All Enabled, T1, B8ZS, AIS		
T1/E1 Settings (std. models)	Disabled		

**Standard models:** If radio configuration is unknown, and you do not have access to a computer and must install the radios immediately, the temporary hardware configuration key can help to establish a link or perform back-to-back bench testing, by helping to configure one of the radio terminals to Radio A.

 **Note:** In many cases, the system design will not be identical to the factory default configuration, and in some cases, these differences prohibit the installation of the radio. If at all possible, obtain a computer and configure the radio terminals using the browser-based GUI. See [Exalt Graphical User Interface \(GUI\)](#) on page 54 for details.

### ***Temporary Hardware Configuration Key (Standard Models Only)***

Use the following steps to enable the temporary hardware configuration key:

1. Remove power from the radio.
2. Remove anything connected to the **ALARMS** port.
3. Connect the key (found in the accessory kit) to the **ALARMS** port.
4. Hold down **RMT** button while applying power.

The LEDs toggle through the boot cycle.

Continue to hold the RMT button until the LEDs stabilize (approximately 45 seconds).

5. Release the **RMT** button.

The following configurations are reset on the radio:

- IP address = 10.0.0.1
- IP mask = 255.0.0.0
- IP gateway = 0.0.0.0
- Administration password = password
- User password = password
- Endpoint Identifier = Radio A

### ***DIP Switch Configuration (-16 Models Only)***

The -16 models have a DIP switch to allow temporary configuration for Radio A and Radio B. See [DIP Switch Settings \(-16 Models Only\)](#) on page 114 for information on DIP switch functions.

## **Radio Synchronization**

The radio synchronization feature improves the performance of Exalt radios operating in the same frequency band and that are collocated (such as in repeater and hub configurations). Radio synchronization ties radio systems together to operate off of a

common clock system, ensuring that all radios simultaneously transmit and receive, and thus eliminating near-field interference issues and related radio system coupling.

**Note:** The synchronization function is not currently available on all Exalt radio models. A firmware upgrade may be required for models without sync if sync is desired. Contact your Exalt representative for details.

### Synchronization Modes

Synchronization can be accomplished using either an *internal* or *external* source. In either case, one radio in the network must be defined as the primary sync source (A) radio.

A Global Positioning System (GPS) kit from Exalt is required to implement external source synchronization. GPS synchronization is not available on all radio models. Contact your Exalt representative for details.

Synchronization implementation only requires one synchronization source for any interconnected network. The system also implements a redundancy configuration to maintain a majority of the synchronization functions in case of primary radio failure.

For internal synchronization, the primary radio is designated SYNC SOURCE. This radio provides the master timing for all interconnected radios. SYNC SOURCE radios and collocated radios must be configured as Radio A.

Collocated radios must be in SYNC RECIPIENT mode; they receive sync signaling from the SYNC SOURCE, either directly or daisy-chained with other collocated radios. Alternatively, the radio(s) can be placed in AUTO SYNC mode. AUTO SYNC synchronizes the radios to any source provided on the SYNC IN port. However, if an appropriate synchronization signal is unavailable, the radio becomes the SYNC SOURCE for all connected radios.

### Internal Synchronization

Figure 4 illustrates the basic interconnectivity of a radio system using internal synchronization. In this scenario, there are two radios collocated at one site.

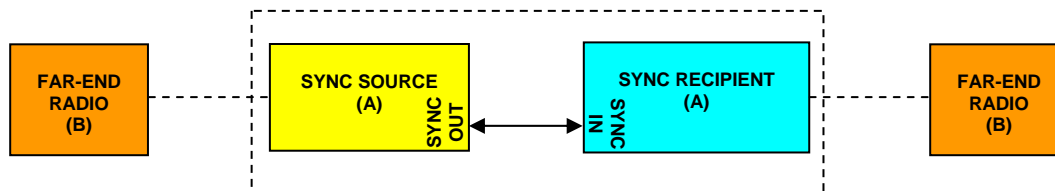

Figure 4 Basic radio interconnectivity using internal synchronization

In Figure 5, there are three collocated radios. In this configuration it may be desirable to make one radio a *secondary* sync source using AUTO SYNC. This provides redundancy if the primary sync source radio (A) loses power or experiences any other failure.

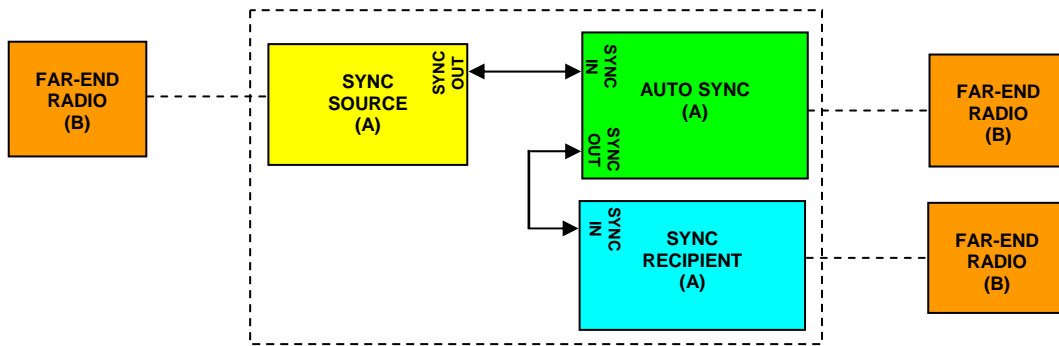

Figure 5 Collocated radios, one in AUTO SYNC mode to provide redundancy

The synchronization function can be carried across links to additional collocation sites. For example, Figure 6 illustrates a multi-link backbone with two hub sites.

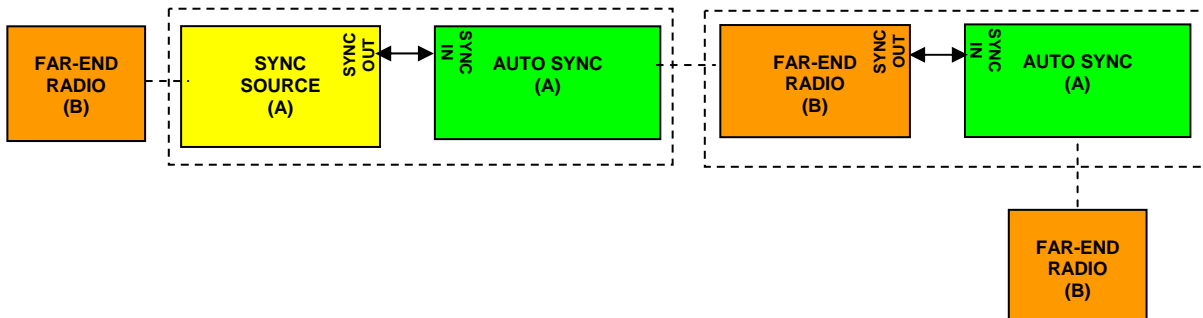

Figure 6 Multiple-link site configuration, using AUTO SYNC for redundancy

**Note:** The configuration shown in Figure 6 is not supported in all models at the time of this writing. Consult your Exalt representative for details.

Virtually any combination of hubs and repeater sites, star configurations, and/or backbones can be implemented with synchronization using these configurations. It is typically necessary or ideal in each configuration to match the following parameters on every radio in the network:

- Link Distance – Match to the longest distance link in the network.
- Frame Length – Match to the lowest frame length to optimize total system latency (for example, for TDM networks) or match to a highest frame length to optimize user throughput. Choose an intermediate value to compromise between latency and throughput.
- Mode – It is desirable, but not always necessary, to match the mode for all collocated links.
- Bandwidth – It is desirable, but not always necessary, to match the bandwidth for all collocated links.



For complex networks, an Exalt engineer should review multi-link networks before deployment as several factors can optimize the network for desired performance.

### External Synchronization

Use an external GPS source as an alternative to the internal synchronization source for system synchronization. This is ideal for links that are nearby each other, but are not directly collocated at the same site. Figure 7 illustrates using a GPS source for the primary synchronization at a typical site with collated radios.

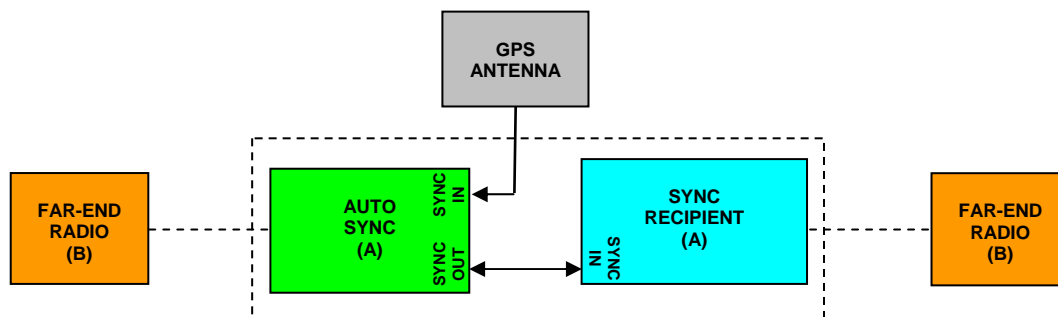

Figure 7 GPS as primary sync source using AUTO SYNC

Figure 8 illustrates two separate radio locations benefiting from synchronized GPS sources.

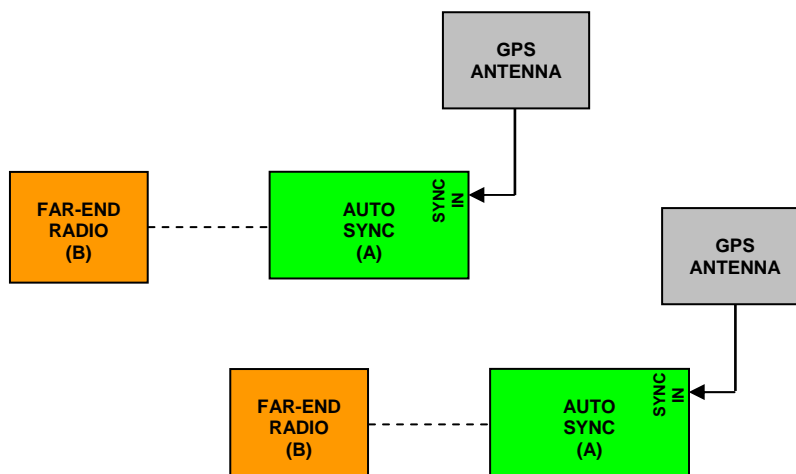

Figure 8 Synchronized GPS sources using AUTO SYNC

### Offset Timing

Manual control of offset timing is also allowed. This provides a means to delay the synchronization signal using a user-defined offset. This is helpful when Exalt radios are near other devices operating in the same frequency band that also use a timing source, such as GPS. The timing source to the Exalt radios can be adjusted to match the other radio system timing source mechanism.

Offset timing can also optimize timing intervals for repeaters and backbones. As the distance of each link results in a unique factor for speed-of-light transmission of the radio signal, a subsequent radio can be delayed in timing so that the overall synchronization of radios is precisely maintained.

Offset timing can be adjusted in 1-ms intervals, from zero to the radio's frame length setting. For example, if using a 2-ms frame length, the offset timing can be set from zero up to 1999 ms.

 **Note:** Offset timing is not supported in all models at the time of this writing. Consult your Exalt representative for details.

### When Sync is Lost

If the primary sync source (for example, the sync source radio or GPS source) signal is lost due to equipment failure, a disconnected sync cable, or other conditions, the first radio in the daisy-chain configuration set to AUTO SYNC resumes the sync function for the remaining connected radios.

If a radio is configured as SYNC RECIPIENT, transmission ceases if the sync signal does not appear at the SYNC IN connector.

A radio running in AUTO SYNC (without the sync source) is said to be *flywheeling*. That is, the clock is free-running off internal clocking and is no longer synchronized to any source.

If the original sync source is restored to the flywheeling radio configuration, the flywheeling radio attempts to synchronize to this signal without causing transmission interruption. All interconnected radios receiving sync from the flywheeling radio also continue to operate without interruption.

When the flywheeling radio runs independently for long periods of time, the synchronization signal can be too far outside of the capture range of the synchronization loop, and portions of transmission frames can be lost during the re-synchronization process. This condition is temporary and all interconnected radios re-synchronize to the sync source, as necessary.

For GPS synchronization, the wiring inside the Exalt radio carries the GPS signal to the next radio cabled in the system, even when power is removed from the SYNC SOURCE radio or during radio failures. This provides redundancy for catastrophic failure of the SYNC SOURCE and maintains GPS synchronization. If the GPS source is lost (for example, due to failure of the GPS unit, a disconnected cable, or satellite blockage), the AUTO SYNC radio resumes synchronization duties for all collocated radios.

### LEDs

There are two LEDs on both the SYNC OUT and SYNC IN ports. [Table 3](#) on page 39 describes the two SYNC IN and two SYNC OUT LEDs.

## System Installation and Initiation Process

The tasks required for radio installation and initiation are outlined in the following figure.

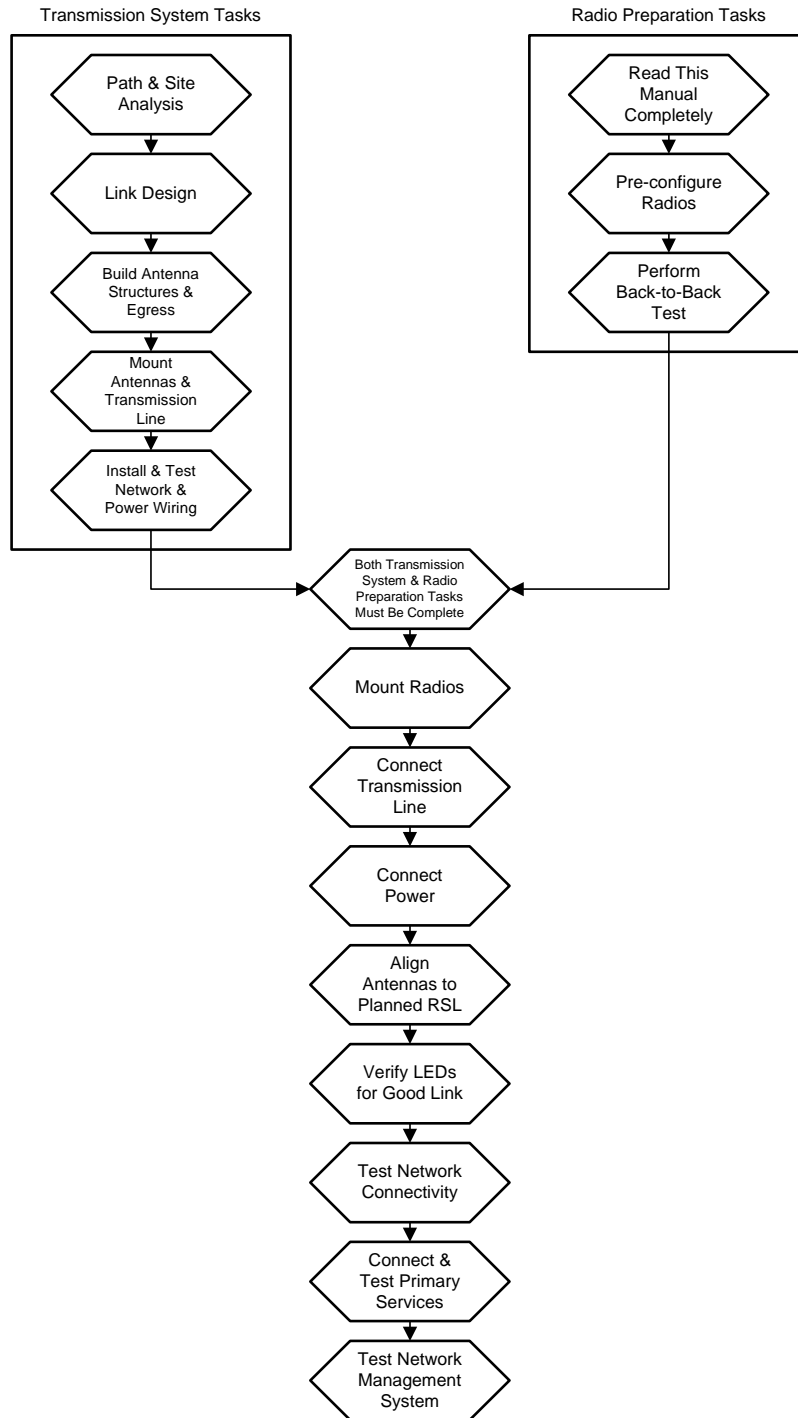

Figure 9 Radio installation tasks

## **Record Keeping**

After installation, record the following items for ongoing maintenance and future troubleshooting. Keep a record for each end of the radio link and store a copy of these records at the radio location, at the opposite end radio location, and a central record storage location.

- GPS coordinates for antenna locations at each site
- Antenna heights above ground level (AGL), as mounted
- Antenna model numbers, serial numbers, and specifications
- Antenna polarization as mounted
- Length/type of primary transmission lines at each site
- Model number and serial number of RF lightning arrestors
- Length/type of secondary transmission line(s)
- Transmitter output power setting as installed at each site
- RSL as measured after antenna alignment at each site
- Designed RSL per original design at each site
- RSL reading with far-end power off (from each end)
- Spectrum analyzer plot with far end off at each site
- Voltage standing wave ratio (VSWR)/return loss at radio's antenna connector at each site
- Radio's network management IP address at each site
- Radio's network management gateway address at each site
- Radio's operating frequency, bandwidth setting, and mode of operation
- Optionally purchased extended warranty and/or emergency service contract details

In addition, certain information may be desired for central record-keeping only:

- Security codes and login passwords (kept in a secure place)
- Photographs of complete installation
- End-user sign-off/acceptance documentation (if any)
- Photo of rear panel label (part number, serial number, MAC address information)
- Site access information phone numbers, access codes, directions

## Installation

This section presents all tasks required to install the Exalt Digital Microwave Radio.

### ***Mechanical Configuration and Mounting***

The i-Series radios are one-piece radio designs intended for deployment in a telecom equipment rack indoors or in an appropriate environmental enclosure. The device must be deployed within an ambient temperature range as specified, and properly ventilated with no obstructions to the air intake and exhaust. The standard models occupy 1 rack unit (1RU = 1.75"/4.5cm ) height in a typical telecom rack. The -16 models occupy 1.5 RU (2.625"/6.7cm).

In most cases, additional racked equipment can be placed directly above and/or below the device with no empty spaces in the rack. However, depending on power consumption and ventilation for adjoining devices, they may pass heat to the device, not allowing the radio to cool properly and increasing the risk of malfunction. Heat dissipation from the radio may also affect adjoining devices. Provide air space above and below the device, where possible. If not possible, a thermal analysis may be required by a professional engineer to determine the impact of thermal transfer between all adjoining units.

Provide proper clearance for all cables and connectors attached to the device. Notably, the RF cable connector may require significant clearance for the bend radius of the coaxial cable assembly. Use a properly specified 90° RF connector to minimize clearance requirements, which may be necessary in enclosure implementations. All RF connectors, cables, and adapters must be rated for operation within the radio's frequency range (2400–2483.5 MHz for EX-2.4i; 4940-4990 MHz for EX-4.9i; 5250–5850 MHz for EX-5i). RF connector losses must be accounted for within the link engineering design and output power settings.

### **Rack Mounting**

Rack mounting hardware for a standard 19" (48cm) rack is included in the accessory kit. Attach the rack mounting brackets to the sides of the unit with the provided screws. The radio can be mounted in one of four configurations:

- Front flush mount (front panel even with the rack mounting surface)



Figure 10 Front flush mount configuration

- Front projection mount (front panel extended forward from the rack mounting surface)



Figure 11 Front projection mount configuration

- Rear flush mount (rear panel even with the rack mounting surface)
- Rear projection mount (rear panel extended forward from the rack mounting surface)



Figure 12 Rear-mount locations

The rack mounting brackets accommodate identical mounting configurations as shown in the previous figures, and can be mounted three different ways with respect to the vertical orientation in the rack:

1. Projecting down, using one full rack space and half of the space below, and leaving a half-space gap below.
2. Projecting up, using one full rack space and half of the space above, and leaving a half-space gap above.
3. Centered within two spaces, with  $\frac{1}{4}$  rack space gap above and below.

Two radios mounted in the same rack can be mounted in adjoining spaces, utilizing a total of three rack spaces.

**Note:** Screws for attaching the radio to the telecom rack are not provided; use the appropriate screw type that matches the equipment rack.

## Table or Rack Shelf Mounting the System

Affix rubber feet or adhesive-backed non-slip pads (not included) near the corners of the unit along the bottom panel when mounting on a table or a rack shelf. These pads help keep the radio stable on a wooden or metal surface.

**⚠ Caution:** In many areas, it is necessary to strap the equipment to a table or rack shelf if mounting in this manner. In case of earthquake or other shock or vibration, or an accidental pull of a cable, the unit should be secured from falling. It may also be necessary to secure the AC adapter, if it is used.

## Radio Ports and Indicators

This section provides a brief overview of the connectors, controls, and indicators on the device. Details about each item are in other sections of this document.

The EX-2.4i front panel is shown in Figure 13. The EX-4.9i and EX-5i front panels are identical, except for the model number shown in the upper-right corner.



Figure 13 Front panel (EX-2.4i, EX-4.9i or EX-5i)

The EX-2.4i-16 front panel is shown in Figure 14. The EX-5i-16 front panel is identical, except for the model number shown in the upper-right corner.

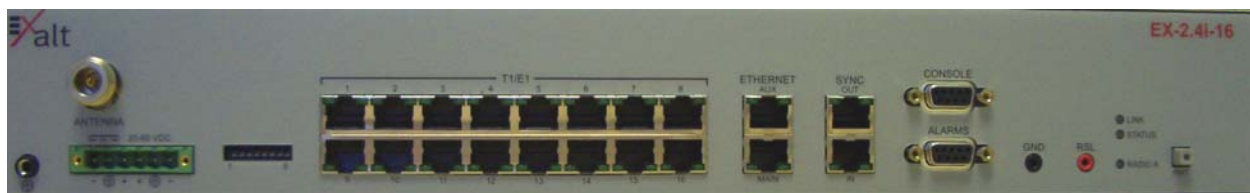

Figure 14 Front panel (EX-2.4i-16 or EX-5i-16)

## Connector Overview

The primary user interfaces are shown in Figure 15. Table provides details of the front panel connectors of all radios. Detailed pin structures for each connector are in [Interface Connections](#) on page 109.



*Figure 15 Primary front panel connectors (standard models)*

*Table 2 Connectors*

<b>Label</b>	<b>Type</b>	<b>Gender</b>	<b>Function</b>
Antenna	N	F	Transmission line connection to GPS antenna.
T1/E1 (1–4 or 1–16)	RJ-48C	F	Primary ports for User T1 or E1 circuits to traverse link.
ETHERNET (MAIN/AUX)	RJ-45	F	Primary ports for user Ethernet and/or management data (10BaseT or 100BaseT) to traverse link.
SYNC (IN/OUT)	RJ-45	F	Internal or external radio synchronizing source (for example, GPS) input and output.
CONSOLE	9-pin sub-D	F	Management port (serial) for PC/PDA for Command Line Interface (CLI) communications.
ALARMS	9-pin sub-D	F	External alarm inputs and outputs.
GND (Ground)	Bantam	F	Common (return) volt meter test point for measuring RSL.
RSL	Bantam	F	Voltmeter test point for measuring received signal level.
40–60VDC	6-pin modular	M	DC power input from DC source or AC adapter.
Ⓧ (Ground)	Threaded (M5) receptacle	F	Chassis ground connection (M5 x 0.8 threads).



**LED Indicators**

Table 3 provides details of the LED indicators on all models.

Table 3 LED indicators

Location/Label	Type	Function
LINK	3-color LED	Indicates RF link status: Green Solid = Error-free connection (BER<10e-6) Yellow Solid = Errored connection (10e-3>BER >10e-6) Red Solid = No link (BER>10e-3) Red Flash= No remote information available (when RMT is pressed and held) Off = Improperly powered or fatal system failure
STATUS	3-color LED	Indicates system status: Green Solid = No alarm conditions (normal operation) Yellow Solid = Alarm conditions, not traffic effecting Yellow Slow Flash = In loopback (from this end) Yellow Fast Flash = In loopback (at this end) Red Solid = Alarm conditions; traffic effecting Red Flash = No remote information available (when RMT is pressed and held) Off = Improperly powered or fatal system failure
RADIO A	3-color LED	Indicates radio orientation: Green Solid = Radio is configured as Radio A, based on software setting Green Flash = Radio is configured as Radio A, based on temporary hardware configuration key Off = Radio is configured as Radio B
ETHERNET MAIN/AUX Left Corner	Green LED	Solid/Flashing = Data present Off = No data present
ETHERNET MAIN/AUX Right Corner	Green LED	Solid = Negotiated @ 100Mbps Flash = Negotiated @ 10Mbps Off = No connection negotiated

Location/Label	Type	Function
T1/E1 Left Corner	Green LED	Solid = Connection present (clocking confirmed) Fast Flash = Connection present; coding/clock problem Slow Flash = Connection present, but unexpected Off = No connection/clock
T1/E1 Right Corner	Green LED	Solid = In a loopback state Fast Flash = Automatic indication signal (AIS) is active Off = No loopback; no AIS activity
RMT (LED inside button)	Amber LED	Off = Remote end LINK and STATUS LEDs are both green Solid = No remote end status available Flash = Alarm conditions at the remote end (LINK and/or STATUS LEDs are non-green)
SYNC IN Left Corner	Green LED	Solid on = GPS is normal (no alarms) Flash = GPS is in alarm Off = No GPS source detected
SYNC IN Right Corner	Green LED	Solid on = Sync locked, no alarms Flash = Sync signal detected, but not locked Off = No input sync signals detected
SYNC OUT Left Corner	Green LED	Solid on = Radio configured as SYNC SOURCE Flash = Radio configured as AUTO SYNC Off = Radio configured as SYNC RECIPIENT or sync is disabled
SYNC OUT Right Corner	Green LED	Solid on = SYNC SOURCE is external (GPS 1 pps) Off = SYNC SOURCE is internal
(Unmarked LED on rear panel)	2-color LED	Indicates overall status (from the rear panel): Green = LINK and STATUS LEDs are both green Red Flash = LINK and/or STATUS are in a yellow state; no red states exist Red Solid = LINK and/or STATUS are in a red state Off = Improperly powered or fatal system failure

## **RMT (Remote) Button**

The RMT button is the only external control on the radios. This button allows easy and quick evaluation of the status of the remote-end radio. Press and hold the button and, while held, all local-end status LEDs (LINK, STATUS, Radio A) represent the status of the LEDs on the remote-end radio. In addition, the RSL voltage represents the remote-end voltage.

When the RMT LED is amber flashes, this is an alert that the remote end has an alarm condition. Press the RMT button to determine the alarm conditions.

When the RMT button is pressed and held and local LEDs flash, this indicates that no remote-end information is available. This indicates that the remote radio is either not powered, is booting, or is not linked in the direction towards the local radio, or the local radio is receiving excessive errors in this direction. It could also indicate a serious failure of either radio.

Local-end LEDs (when this button is not pressed) in combination with remote-end information (from a technician located at the far end, and/or when the button is pressed) can substantially aid in rapid troubleshooting analysis.

## **Power**

The radio requires a DC power source within specifications. The DC can be provided from a DC battery source, central lab/rack supply, or from the supplied AC adapter.

 **Note:** Read this section completely before applying power.

## **Terminating the RF Connector**

Before applying power, the device's RF connector must be properly terminated into a 50-Ohm load. If this is not performed, the radio may be damaged by simply applying power. Also, there are human safety factors to consider regarding potentially harmful RF radiation.

There are a few simple means to accommodate proper termination:

- Connect a 50-Ohm coaxial termination device to the RF port of the radio. The termination must be rated to 1W (or more). Example(s) include:
  - Broadwave Technologies P/N 552-200-002, or similar
- Connect the complete transmission system. That is, the RF cabling including the antenna. The cabled antenna provides a proper termination for the RF output.

- Connect a fixed (or a series of fixed) 50-Ohm attenuator(s) to the RF connector, either directly or at the end of an RF transmission line. The attenuator must be at least 30dB as specified at the operating frequency (~2400 MHz for the EX-2.4i; ~4950 MHz for the EX-4.9i, ~5700 MHz for the EX-5i), and rated for a minimum of 1W input power. Examples include:
  - Broadwave Technologies P/N 352-103-xxx
  - Bird 2-A-MFN-xx
  - JFW Industries 50FP-xxx-H6-N

## **AC Power**

The AC adapter easily connects to the device. The AC rating of the adapter accepts most standard voltages and frequencies worldwide. Refer to the input voltage requirements stated on the label affixed to the adapter to ensure that the adapter can be used with the AC mains supply.

The AC plug outlet provided with the adapter may need to be replaced to match the country configuration. The adapter cable uses a standard connector for this cable for use of a pre-wired cable appropriate to the outlet configuration. If the appropriate cable is not available, the existing AC plug end can be severed and a replacement plug affixed. Consult a qualified electrician for this activity.

Do not plug the adapter into the mains power. First, verify that the RF connector is properly terminated (see [Power](#) on page 41), and then plug in the radio-side connector from the AC adapter to the radio. If the AC mains can be turned off using a switch, disable the power, plug the AC side of the adapter into the AC mains socket, and then enable power to the circuit. If the AC mains cannot be turned off, plug in to the AC main socket to apply power.

Verify that the radio is active by observing LED activity. All LEDs on the radio flash at initial power cycle.

It is strongly encouraged that the AC mains supply be fused or on a separate breaker to ensure against over-voltage and/or over-current situations and to provide some form of protection to the radio electronics and other devices connected to the same supply. In addition, if the AC power is subject to significant spikes or variation, power conditioning is a worthwhile investment, as the quality of mains power may have a direct impact on the device operation, performance and/or reliability. An Uninterruptible Power Source (UPS) or other form of battery-backed system protects against brown-out and black-out conditions, and condition the power presented to the adapter.

Evaluate the opportunity for lightning or other similar surges to be present on the powering system, including the ability for surges to couple to the power wiring system. If an evaluation indicates that there is a potential likelihood for these conditions to occur, additional surge protection is recommended for the input power wiring, especially to protect the radio electronics between the adapter and the radio's DC input connector.

The above statement is similarly true for every wired connection to the device. While the configuration for surge suppression or line conditioning is of a different type for each

kind of signal interface, the opportunity for damage to the device, loss of communications and property is significant. In some cases, there can also be a risk to human life by not protecting against lightning entering a building through wiring or improper grounding. If you do not have experience in this type of installation practice, consult a qualified electrician and/or telecoms professional during the installation and wiring of the equipment.

### **DC Power**

The device accepts DC power within the voltage specifications. The DC voltage input accepts ~~either~~ 20-60VDC. Ensure that the power source is specified for the proper amount of current delivery capacity. The DC power may be connected as a positive or negative voltage supply, and be referenced to ground or 'floating' (differential voltage). There are different system grounding considerations depending on the nature of the DC supply grounding, and consult a qualified electrician or telecoms professional on the proper wiring and grounding process.

To connect a DC source, with the power disabled on the DC supply, connect proper gauge wiring to the DC supply. For most (short) power cable runs, 18AWG or 24AWG wire can be typically used. Strip the ends just long enough for enclosure to the DC radio connector (approximately 0.25 inches/6mm). If using stranded wire, the stripped ends inserted into the DC terminal connector must be solder-tipped. If using solid wire, a solder tip is not necessary. Ensure that the power wiring is long enough to neatly traverse, when properly dressed, between the source supply and the radio mounting location. If DC wires are to be exposed to outdoor environments, use wire in the proper weatherproof wiring jacket.

For longer runs of DC wiring, use a higher gauge wire and/or higher current source supply to overcome the additional resistance of the DC wiring. However, the DC connector for the radio may not be able to accept a high diameter wire, transition to thinner gauge near the end of the wiring run or use the maximum diameter wire for the entire wiring run, as long as it meets the powering requirements considering total resistance of the wiring and the power source current load capacity.

Insert the wiring ends into the DC mating connector (supplied) and tighten the terminal screws to secure the wire into the connector. Do *not* connect the mating connector to the radio system and disable the power system.

Pay close attention to the polarization of the DC signals coming from the DC supply and the ground conductor (if any), and ensure that they are connected to the proper pins of the DC mating connector. The connector mate on the radio is clearly marked on the front panel for proper polarization and for ground connection.

Wire across the plus (+) and minus (-) terminals from the DC supply. In addition, place a separate jumper between the proper terminal and the ground terminal to reference one side of the power supply line to the radio chassis ground. In some cases, the DC system may need to be floating and this ground jumper is not necessary; however, many configurations require one side to be grounded for proper electrical safety.

 **Warning:** Consult a qualified electrician if uncertain about how to properly ground the system and connect power.

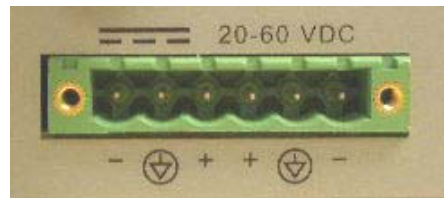

Figure 16 DC connector

Once the wires are connected to the mating connector, do not connect to the radio. First test the DC connection to the connector from the DC supply. Engage power on the DC supply, and use a volt meter to verify proper voltage level and polarity.

Verify that the RF connector is properly terminated, as described in [Terminating the RF Connector](#) on page 41. Disengage power once again on the DC source, and connect the mating connector to the radio device. Engage power on the DC source. Verify radio is active by observing LED activity. All LEDs flash during the initial power cycle to verify that they are operational. Secure the DC connector using the integral captive screws at each end. This prevents accidental disconnection.

See [Power](#) on page 41 regarding fusing, breakers, lightning protection, surge protection and power conditioning. Follow these recommendations for a DC supply.

### Reset to Critical Factory Settings

If necessary, the radio terminal may be reset to critical factory settings. This may be necessary if the IP address and/or passwords for the system are not known. All other configurations are left at their current settings. If a complete default factory configuration is desired, load the Default Configuration File into the system, as described in [System Configuration Page](#) on page 64.

The following parameters are configured after a reset to critical factory settings:

- IP Address = 10.0.0.1
- IP Mask = 255.0.0.0
- IP Gateway = 0.0.0.0
- Administration password = password
- User password = password
- Endpoint Identifier = Radio B (unless temporary hardware configuration key is installed on a standard model, or the DIP switch is used on a -16 model)

To perform a reset to critical factory settings:

1. Remove power.
2. Remove connections to the **ALARMS** port.

3. Hold the **RMT** button on the front panel while applying power.  
Continue to hold the **RMT** button through the entire boot cycle (approximately 45 seconds).  
The front-panel LEDs toggle during the boot cycle.
4. Release the **RMT** button when LED behavior stabilizes.

## **Antenna/Transmission System**

This section provides general guidance to the mounting and connecting of the RF transmission system, consisting of the antenna, RF cabling, and RF lightning arrestors. Consult the manufacturer's instructions for proper mounting, grounding, and wiring of these devices, and for definitive direction. These manufacturer's instructions supersede any information in this section.

The antennas permitted for are identified in Tables 10 and 11.

### **Initial Antenna Mounting**

The antenna must be an exact model recommended by the path and site planning engineer(s). Mount the antenna at the proper height, mast/mounting location and polarization orientation as determined by the path and site planning engineer(s). The model type, location, and orientation of the antenna is critical with respect to achieving proper path clearance, as well as to mitigate external or self-interference from nearby or collocated systems operating in or near the same frequency band.

 **Warning:** Mount the antenna in a restricted area and in a manner preventing long-term human exposure to the transmitted RF energy. To comply with FCC and Industry Canada regulations, the minimum safe distance from the antenna for continuous human exposure for the EX-2.4i models is 10 feet (3m), 39 inches (1m) for the EX-4.9i, and 10.5 feet (3.2m) for the EX-5i models.

The antenna structure must be secure and safe with respect to the mounting of the antenna, transmission system weight, and the combined weight of any personnel that may climb or attach to the structure. The combined weight of items and forces on the structure must be carefully considered in the design and construction of the structure. This must include the weight bearing on the structure in the highest wind conditions possible in the region, and with respect to all objects affixed to the structure.

If additional objects are affixed to the structure in the future, it may be important to evaluate both the mechanical impact of these planned additions (with respect to wind and weight loading), as well as the potential impact to RF interference and frequency coordination (if additional radio equipment is anticipated). This is especially important if future equipment is likely to operate within the same frequency band.

Once the antenna is mounted, cabled, and aligned, your goal is to never require modification. This prior planning is important in the path and site planning stages and in construction of the antenna structure.

Follow the antenna manufacturer’s instructions for mechanical mounting of the antenna. Ensure that there is enough room around the antenna for alignment activities (moving the antenna in vertical and horizontal arcs), and for the RF transmission line to connect to the antenna connector unobstructed and within the specified bend radius requirements of the transmission line.

At this point, the antenna mounts should be fully secure to the structure, the feed of the antenna securely mounted to the antenna (if the feed is a separate assembly), and the azimuth and elevation adjustments not completely tightened in preparation of the antenna alignment activity. It is a good practice to connect the transmission line to the antenna connector as early in the process as possible, to reduce the opportunity for debris or moisture to enter either the antenna connector or the transmission line connector. Use a connector cover or other temporary measures to ensure that the connector is kept clear. Take extra care if the antenna is installed during inclement weather to ensure that no moisture gets inside the antenna connector at any time.

Now the antenna can be aimed in the general direction required for the link. Use a compass, a reference bearing, binoculars or any other similar device to point the antenna in the direction (generally) of the far end radio, and then slightly tighten the azimuth and elevation adjustments so that the antenna maintains its general position and is safe to be left without additional securing. Refer to the Exalt white paper, *Antenna Alignment*, for more information on antenna alignment techniques.

**Transmission Line from Antenna to Egress**

Most installations use coaxial transmission line for the connection between the antenna and the radio device. Coaxial transmission line can either have a solid or braided shield. Solid-shield cables are more resistant to external signal coupling and interference, but are generally stiffer than braided cables. Consult the path or site engineer(s) to ensure that the proper materials are chosen for the installation and that all factors were considered. Refer to the Exalt white paper, *Transmission Line for Exalt Indoor Radio Systems*.

Generally, the larger the diameter of the transmission line, the lower the loss. So for longer runs of transmission line, larger diameter cables are highly advised. However, at every frequency, there is a maximum diameter cable that supports the operating frequency. Verify the specifications. This should be determined in the path and site planning process.

In some cases, the choice of transmission line is not coaxial cable, but is instead air-dielectric waveguide. This is an expensive solution and is generally not necessary, but may be required for very long transmission line runs, and/or very long link distances, and/or for systems requiring extremely high reliability.

Table 4 lists representative samples of transmission line types recommended for the Exalt Digital Microwave Radio.

Table 4 Recommended transmission line

Manufacturer	Type	Description	Loss at 2.4GHz	Loss at 4.9GHz	Loss at 5.3GHz	Loss at 5.8GHz
Andrew	LDF4-50	1/2-inch solid shield	3.3dB/100ft.	5.6dB/100ft.	5.7dB/100ft.	6.0dB/100ft.



Manufacturer	Type	Description	Loss at 2.4GHz	Loss at 4.9GHz	Loss at 5.3GHz	Loss at 5.8GHz
Andrew	LDF4.5-50	5/8-inch solid shield	2.5dB/100ft.	4.3dB/100ft.	4.4dB/100ft.	4.7dB/100ft.
Times	LMR-600	1/2-inch braided shield	4.3dB/100ft.	6.8dB/100ft.	6.9dB/100ft.	7.3dB/100ft.
Times	LMR-900	5/8-inch braided shield	2.9dB/100ft.	4.5dB/100ft.	4.6dB/100ft.	4.9dB/100ft.
RFS	LCF12-50J	1/2-inch solid shield	3.5dB/100ft.	5.5dB/100ft.	5.6dB/100ft.	5.9dB/100ft.
RFS	LCF12-58J	5/8-inch solid shield	2.8dB/100ft.	4.4dB/100ft.	4.5dB/100ft.	4.8dB/100ft.

There are several other brands and models of transmission line that are perfectly acceptable. However, for extremely long transmission lines and/or extremely long radio paths, it may be necessary to use waveguide transmission line instead of coaxial transmission line. In these cases, waveguide type EW20 is recommended for EX-2.4i models (0.45dB/100ft. loss at 2.4GHz), and type EW52 for the EX-4.9i and EX-5i models (1.2dB/100ft. loss at 5.8GHz, 1.35dB/100ft. loss at 5.3GHz).

It is critical that the transmission line and antenna be capable of supporting the same type of connector, or easily adapted. It can be important to minimize the number of connectors and adapters, and it is ideal that they match directly without adaptation. In most cases, transmission line allows for N-type male connectors and antennas have N-type female connectors. For waveguide, the waveguide flange can typically accommodate a direct adapter to an N connector, or alternatively, the antenna can be purchased with a direct waveguide connection. But often a flexible coaxial jumper is required to connect between the waveguide and antenna, as waveguide is generally inflexible and can be mechanically challenging to align to the exact antenna connector location.

If possible, connect the primary transmission line directly to the antenna. It is desired to have the fewest possible pieces of transmission line in the system, to minimize losses and points of failure from connectors. The antenna can typically accommodate a direct connection if planned in advance. Use a 90°adapter for the connection to the antenna, if necessary, but confirm that all connectors and transmission lines are properly specified for the operating frequency with minimum loss, proper impedance (50 Ohm) and proper VSWR characteristics.

Transmission line connector termination is a critical element of the installation. Many ‘factory built’ RF transmission lines do not provide the proper characteristics for proper transmission, despite their published specifications, often due to the fully or semi-automated process of factory termination, which may not have considered the frequency of your system. When buying pre-terminated transmission line, it is strongly advised to obtain the documentation of test measurements on the connected transmission line showing that the loss characteristics and VSWR are within the specified limits specifically at your operating frequency. In addition to factory-built transmission line, self-terminated transmission line can suffer the same issues.

**⚠ Caution:** Always follow the manufacturer’s termination process EXACTLY, and only use the manufacturer’s authorized tools and connectors for a given transmission line type.

The manufacturers of transmission line typically offer instruction and certification for transmission line termination, and may also provide videos illustrating the process. There is no amount of extra care, education, precision, and effort that can be overstated for this process.

Once the transmission line is connected to the antenna, traverse the exact route provided by the site planner. There is often a need for a small excess of transmission line near the antenna to accommodate both the need for extra slack as the antenna is loosened and moved for the alignment process, and to accommodate a drip loop for the transmission line and the initial transmission line securing hardware and grounding near the antenna. In addition, the transmission line is typically very stiff, and can provide undue pulling force on the antenna connector. Take care to align the cable with the connector so that it does not provide any torque or strain on the connector.

Consult your transmission line manufacturer for the proper transportation, hoisting, securing, and grounding process. Always be very mindful of the entire length of transmission line to ensure that the transmission line is never twisted, kinked, or over-bent beyond the specified bend radius. Once a transmission line is over-bent or kinked, it will likely never recover its specified characteristics, even after straightening, and will often be completely unusable.

The opposite end of this primary transmission line typically terminates at the building or enclosure egress point. This is where to locate the RF lightning arrestor. Ensure that a proper termination to the connector-type of the lightning arrestor is made at this location. A drip loop may be required and proper securing hardware and grounding must be accommodated.

As soon as practical, weatherproof the connected ends of the transmission line to the antenna and lightning arrestor. This process should be delayed as long as possible to ensure that all systems are working properly before applying the weatherproofing. Once weatherproofing is applied, it may have to be removed for testing or installation modification. With this in mind, if the installation is occurring during inclement weather, take extra care at all times to ensure that no moisture enters any connector at any time. If moisture is suspected to have compromised the antenna or transmission line, it may render those devices useless without any means for remedy except for full replacement.

### ***Indoor Mounting***

On rare occasions the antenna can be mounted indoors behind a window. In these cases, there would not be a need for drip loops or an RF lightning arrestor. Use a very short transmission line connected directly between the antenna and the radio mounted nearby. The weatherproofing process can also be omitted.

### **RF Lightning Arrestor**

RF lightning arrestors provide a direct path to ground for lightning strikes that may couple to or directly hit the outdoor transmission system or antenna structure. The RF lightning arrestor prevents any associated voltage and current from entering the building or enclosure, where it might harm the radio equipment, other equipment, or humans.

The following lightning arrestors are examples of proper devices for Exalt Digital Microwave Radios:

- Polyphaser AL-LSXM
- Andrew BB-BNFE-26

Mount and ground the RF lightning arrestor in accordance to the manufacturer's recommendations. Place it as close as possible to the egress point where the next piece of transmission line enters the building or enclosure. Minimize the distance to the egress to lessen the opportunity for lightning to couple to or strike the unprotected section of transmission line (if any). Where possible, use a bulkhead connector to eliminate any opportunity of this risk. Keep cable lengths behind the arrestor and into the egress substantially short (less than 3'/1m) as a safe practice. Consult a qualified electrician or installer in all cases of grounding and lightning arrestor implementation.

### **Transmission Line from Egress to Radio**

A single transmission line section from the egress to the radio RF connection is always desired. Minimize the number of connectors and adapters. For indoor runs, a cable ladder or tray may be needed to properly secure the cable. In some cases, a short flexible jumper allows ease of connection to the radio's RF connector. A properly specified 90° connector can often eliminate this need. An installation with space around the radio to accommodate a gentle bend radius of the transmission line is also good for a direct connection. In all cases, ensure that the transmission line is not a pulling force of the RF connector on the radio. Transmission lines can be very stiff and can damage the connector if not dressed properly. Also, follow the transmission line manufacturer's instructions for the proper use of cable securing devices.

## Antenna Alignment

Antennas must be installed at both ends of the planned link to commence precision alignment. Refer to the Exalt white paper, *Antenna Alignment*.

Antennas are typically aligned using the radio hardware for precise alignment. However, there are many very useful tools available to aid in this process, inclusive of devices specifically designed for the purpose of aligning antennas. Some examples are:

- XL Microwave Path Align-R
- Teletronics 17-402

Use of these devices may be extremely advantageous as compared to using the radio, because they employ many unique facilities to aid in this process. Using these tools also makes it possible to align the antennas before the radio equipment is delivered. However, many installers successfully use the radios as the means for antenna alignment.

There are two primary facilities when using the radio to align the antenna:

- RSL voltage test point using a volt meter (recommended)
  - The RSL test point DC voltage is inversely proportional and numerically calibrated to the received signal level. The voltage rises as the antennas are less in alignment, and falls as antennas are more in alignment. The voltage measurement corresponds to the received signal level in measurements of dBm (a negative number for RSL measurements). For example, an RSL of -60dBm yields an RSL voltage measurement of 0.60VDC; an RSL of -45dBm measures 0.45VDC.
- ExaltGUI RSL reading indicates the current RSL in dBm.

Alignment of the antennas using the RSL test point can be accomplished in the following ways:

- Radio near or at antenna location
  - Temporarily connect the radio to the antenna using a short piece of transmission line, so that the radio is very close to the antenna location
    - Run wires, as necessary, from the RSL test point to the volt meter so that the antenna installer can directly view the volt meter

 **Note:** Using this method, the final RSL voltage readings during alignment may be different (better) than the planned RSL, due to the short RF transmission line. Use the path calculation tool to determine the RSL that should result in this temporary configuration to ensure proper ideal alignment.

- Run separate wires from radio mounted location to antenna location
  - Temporarily connect a set of wires from the RSL test point to the antenna location, to allow the radio installer to use a local volt meter

 **Note:** Due to the resistance of the cable, the RSL readings might be impacted. Use the thickest wiring possible. Test the impact of the voltage reading due to the wiring by comparing a direct measurement at the RSL test point as opposed to the end of the wiring.

- RF/DC coupler

Install a temporary DC coupling device at the radio antenna port and at the antenna connector. Connect the RSL test point to the radio antenna port coupler, and the volt meter to the antenna connector coupler. See [DC Coupler for Antenna Alignment](#) on page 107 for more information

- Verbal relay/walkie-talkie/mobile radio/cell phone

- A person located at the radio front panel can use a short-range communication device or verbal relay to communicate to the antenna installer and read off RSL voltage measurements

Only use the browser-based GUI for antenna alignment if there is no other means available. If this method is required, refer to [Exalt Graphical User Interface \(GUI\)](#) on page 54. The RSL reading can be read on a PC or any handheld computing device that supports an HTML browser and Ethernet connectivity.

 **Note:** There is a slight delay in RSL readings in the GUI as the RSL levels change. In this case, fine alignment can be done in small adjustments allowing a small gap of time so that the impact of the adjustment on the GUI display catches up to real time.

## Configuration and Management

This section describes the command line interface (CLI) and Exalt graphical user interface (GUI).

### Command Line Interface (CLI)

Exalt Digital Microwave Radios provide a CLI to set key parameters on the system. Use the Console port for serial devices, or use the Ethernet MAIN or AUX ports for a Telnet session over a network connection.

#### Connect to the Radio with a Serial Connection

For serial interface to the CONSOLE port, on your PC, PDA, dumb terminal, or any other device with a serial interface and text input capabilities, use Hyperterminal or a similar application with the following settings:

Bits per second:	9600
Data bits:	8
Parity:	None
Stop bits:	1
Flow Control:	None

Use a standard straight-through serial cable to connect between most computer serial ports and the Console port on the radio. A null modem cable is not properly wired for this interface. See [Interface Connections](#) on page 109 for wiring details.

After establishing the serial connection, press ENTER to display the login prompt.

#### Connect to the Radio through a Telnet Connection

Use the following steps for a Telnet connection to the radio through the ETHERNET AUX port using Windows:

1. Open a command prompt, or MS-DOS prompt shell (Start>Run>cmd).
2. Type C:\>Telnet <IP Address> at the command line of the command prompt window.

The default IP address is **10.0.0.1**

 **Note:** You can reset the default address to a different address through serial CLI using the Console port, or back to the default address by radio reset.

 **Note:** Your computer must be on the same IP subnet as the radio to use the Telnet function.

## CLI Screens and Menus

Use CLI or Telnet when prompted, and enter the administration level login and password. The default administration login is *admin* and password is *password* (or *admin* for early firmware releases). It is recommended that the default administration password be reset by performing a radio reset (see [Reset to Critical Factory Settings](#) on page 44).

The serial port CLI and Telnet CLI are identical. Figure 17 shows the three menu choices available after log in.

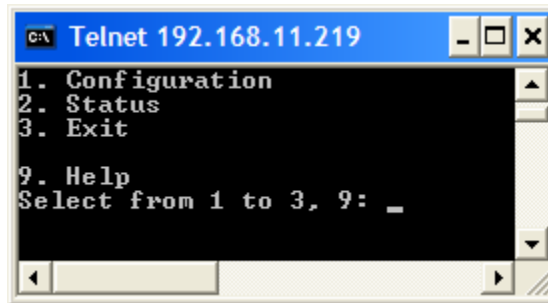

Figure 17 CLI main menu

Select 1 or 2 to display the Configuration or Status menus, respectively. Select 3 to exit the CLI/Telnet session. The following selections can be made on all screens:

- 0 = back to previous screen
- 9 = help
- Ctrl+\ (control and backslash keys) = exit session

The following depicts the complete CLI tree structure:

1. Radio information
2. Configuration
  - a. Current IP settings
  - b. Current system configuration
  - c. Set IP address and mask (admin only)
  - d. Set IP default gateway (admin only)
  - e. Administration (admin only)
    - System time and date
    - System reboot
    - Password
    - File transfer
    - File activation

3. Status
  - Alarm summary
  - Radio alarm
  - Radio status
  - Radio performance
  - Radio performance reset (admin only)
4. Exit

## **Exalt Graphical User Interface (GUI)**

The Exalt GUI is the primary user interface for configuring and troubleshooting the radio and radio system. A computer or hand-held device with a conventional HTML browser and Ethernet port is required. Microsoft Internet Explorer is the preferred browser. Netscape, Mozilla, and Firefox are also supported.

### **Preparing to Connect**

If the radios are new, both radios are preconfigured as Radio B, and have the same IP address. The initial priority is to configure one radio to Radio A and assign different IP addresses, unique to each radio.

There are two ways to change the IP address:

1. Use the CLI interface through the console port (serial), as described in Command Line Interface (CLI) on page 52
2. Connect to the GUI using the default IP address (10.0.0.1), and change the IP address through the GUI interface.

 **Note:** If the radio's current IP address is unknown, use the CLI interface through the console port to retrieve it and/or change it. Or perform a complete radio reset as described in Reset to Critical Factory Settings on page 44.

 **Note:** To connect to the radio's Ethernet port and use the GUI interface, the accessing computer must match the radio's IP address subnet. It is therefore necessary to either change the radio's IP address through the CLI to match the subnet of the computer, or change the computer's IP address to match the subnet of the radio (such as, a computer IP address of 10.0.0.10 if trying to connect to a radio set to the factory default IP address of 10.0.0.1).

There are three ways to configure a radio as Radio A:

1. Use the temporary hardware configuration key, as discussed in Temporary Hardware Configuration Key (Standard Models Only) on page 28.



2. Use the front panel DIP switch, as discussed in [DIP Switch Configuration \(-16 Models Only\)](#) on page 28.
3. Connect to the GUI and change the configuration, as discussed in this section (preferred).

### Make Connections

It is recommended that one radio at a time be configured, on a bench, before taking the radios to the field for installation:

- Terminate the RF connector with a 50-Ohm termination or a fixed attenuator of at least 20dB (see [Terminating the RF Connector](#) on page 41).
- Apply power to the radio (see [Power](#) on page 41).

**Note:** Do not connect the radios in a back-to-back configuration. If the radios are set to their factory default settings, both radios are configured as Radio B and cannot communicate. Both radios also have the same IP address, which causes IP address conflicts.

Use the CONSOLE port and CLI interface to configure the IP address to match the accessing computer or connect to the ETHERNET AUX port to the computer's Ethernet port.

**Note:** The IP address subnet of the accessing computer must match the radio's IP address subnet to connect using Ethernet (see [Preparing to Connect](#)). Either change the computer's IP address to match the radio, or use the CLI to change radio's IP address to match the computer.

Once connected to the radio using Ethernet, log in to the Exalt GUI.

### Log In

Use the following steps to log in to the Exalt GUI.

1. Open a browser window.

Microsoft Internet Explorer is the recommended browser. Netscape, Mozilla, and Firefox are also supported. If there are issues with your browser, please report it to Exalt Customer Care. You may be required to use a different browser to immediately overcome issues.

2. Type the IP address of the radio in the address bar.

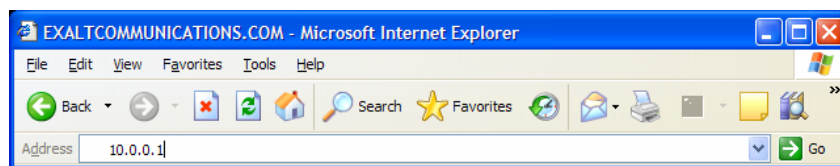

Figure 18 Initiating the browser connection

The following window displays after pressing the Enter key or clicking the Go



button in the browser window.

Figure 19 Browser Login screen

### Login Privileges

There are two levels of login privileges:

- Administrator (admin) – assigned complete permissions to view, edit, and configure
- User (user) – assigned limited, view-only permissions with no edit or configuration rights

The default login names and passwords are as follows:

Table 5 Default Login Information

Privilege level	User name	Default password
Administrator	admin	password
User	user	password

Administrator login credentials are required for configuration purposes. Type the user name and passwords for Administrator level and click OK. The following screen displays.

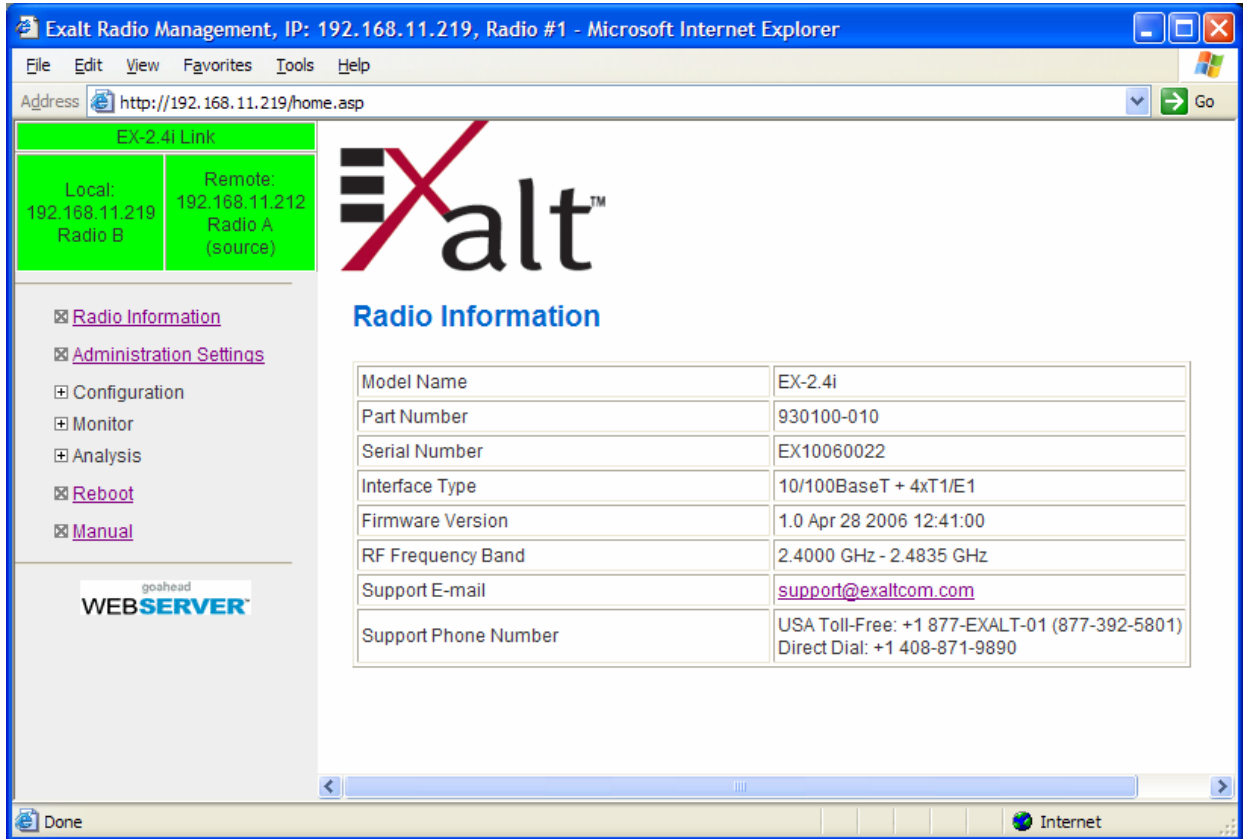

Figure 20 Radio Information page

## Quick-Start

To establish a link on the bench, apply the following basic configurations to the radio terminal. Use the steps in the *Quick Start Guide* included with the radio. A summary of the items that need to be configured are:

- Radio IP address for each end.
  - Each end must have a different IP address and cannot match the accessing computer's IP address or any address assigned if radios are part of a larger network.
  - It may be required to change the IP address of the accessing computer after changing the IP address of the radio so that the IP subnet matches.
  - The radio IP address is listed on the Administration Settings page.

- Set one radio as Radio A.
  - The radio selected as Radio A must be configured.
  - Radio A/B selection is the Endpoint Identifier parameter on the System Configuration page.
  - Even though both radios are set as Radio B by default, confirm this configuration on the radio intended to be Radio B.

If all other parameters are still configured at their factory default settings, the radios can now be connected back-to-back to verify that the link is communicating and perform any other desired tests. See [Back-to-back Bench Testing](#) on page 104 for test information.

Navigating the describes each page of the GUI. Most configuration parameter settings are intuitive. The following link parameters must match at both ends for the link to communicate:

- Link Security Key (Administration Settings page)
- Bandwidth (System Configuration page)
- RF Frequency (System Configuration page)
- Link Distance (System Configuration page)
- TDD Frame Size (System Configuration page)

 **Note:** Changing any of these parameters causes a temporary loss of link. The GUI displays a warning and provides an opportunity to cancel changes.

## ***Navigating the GUI***

The GUI provides the primary interface for all configuration and management. There are three sections of the main GUI window, as shown in Figure 21:

- Summary status information section (upper-left corner)
- Navigation panel
- Main window

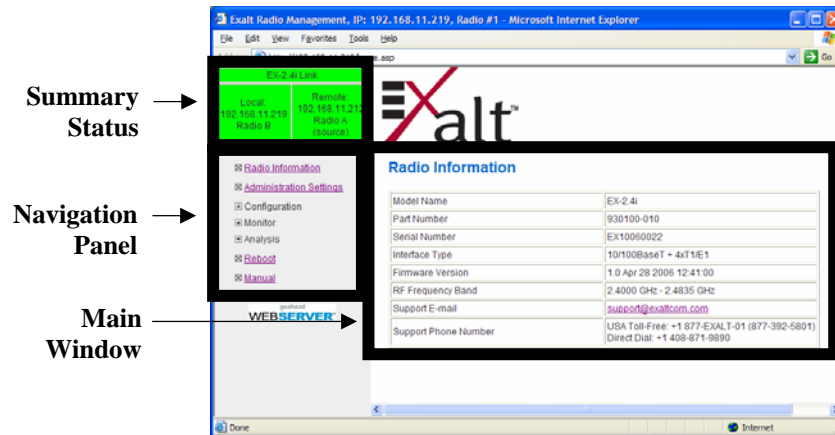

Figure 21 Exalt GUI window description

### Summary Status Section

This section of the Exalt GUI provides a review of the system status.

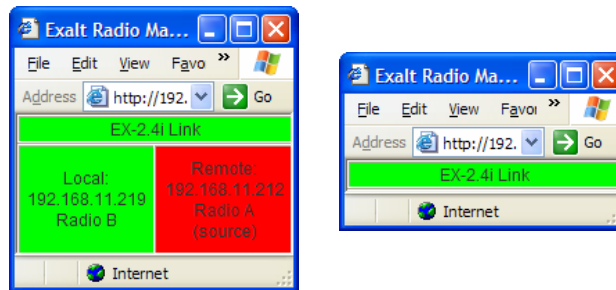



Figure 22 Minimized browser windows for summary status of multiple radios

In the screens in Figure 22, the top bar illustrates the alarm condition of the link. The background color of this bar is equivalent to the color of the LINK LED on the radio front panel(s) (see [Table 3](#) on page 39). The information inside the bar is equivalent to the entry of the Link Name, as set by the administrator in the Administration Settings page (see [Administration Settings Page](#) on page 62).

The background color of the left box illustrates the summary of alarm conditions of the local radio (the radio that matches the IP address). The color follows the same convention as the rear panel SUMMARY LED. The information inside the bar illustrates the IP address and the endpoint identifier (Radio A or Radio B).

The background color of the right box illustrates the summary alarm conditions of the remote radio (the radio linked to the local radio).

 **Note: The ‘local’ radio might be the near-end or the far-end radio,** depending on the management interface connection. The terms local and remote refer to the orientation of the radio terminals relative to the IP address you are managing. When making certain changes to a near-end radio without first making changes to the far-end radio, the link may become disconnected unless configuration changes are reverted to their original settings. When making changes that have the opportunity to disrupt the link, **always change the far-end radio first, and then the near-end radio to match.**

The Summary Status Section allows the Exalt GUI to be a rudimentary management system. Minimize the browser window to display just the top bar or the top bar and radio information, and open several browsers on the desktop. When a window status changes to yellow or red, you can quickly maximize that window to determine the issues.

### **Navigation Panel**

In the navigation panel, pages with sub-pages have a plus (+) to the left of the page link. Click the plus sign or page name title to view sub-page titles. The pages can be collapsed to hide the sub-pages when a minus (-) sign appears to the left of the page link.

Management pages are indicated with an X to the left of the page name. Click the X or page name to display the page within the main window.

## Radio Information Page

This page provides general information about the local radio terminal. This information is helpful for troubleshooting and for record keeping.

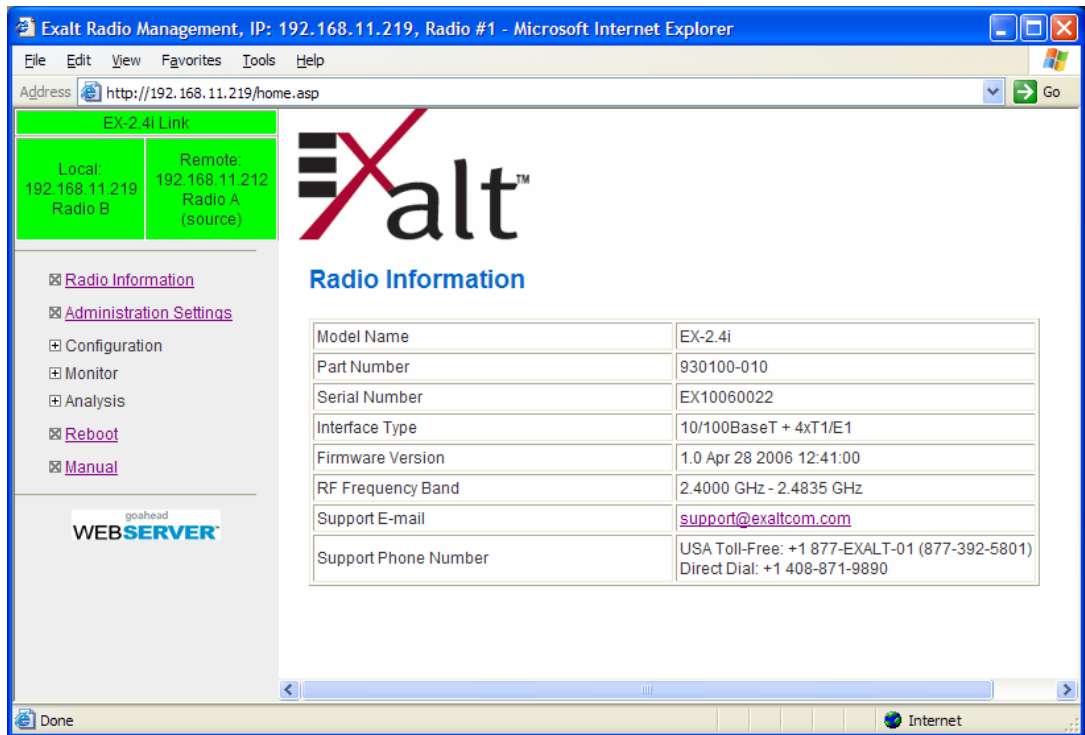

The screenshot shows a web browser window titled "Exalt Radio Management, IP: 192.168.11.219, Radio #1 - Microsoft Internet Explorer". The address bar shows "http://192.168.11.219/home.asp". The page content includes a navigation menu on the left with options like "Radio Information", "Administration Settings", "Configuration", "Monitor", "Analysis", "Reboot", and "Manual". The main content area is titled "Radio Information" and contains a table with the following data:

Model Name	EX-2.4i
Part Number	930100-010
Serial Number	EX10060022
Interface Type	10/100BaseT + 4xT1/E1
Firmware Version	1.0 Apr 28 2006 12:41:00
RF Frequency Band	2.4000 GHz - 2.4835 GHz
Support E-mail	<a href="mailto:support@exaltcom.com">support@exaltcom.com</a>
Support Phone Number	USA Toll-Free: +1 877-EXALT-01 (877-392-5801) Direct Dial: +1 408-871-9890

Figure 23 Radio Information page

## Administration Settings Page

This page allows contains general parameters for the radio system. The Current Value column lists entries actual settings. Desired changes are entered in the New Value column.

After all desired changes are entered, click the **Update** button to accept and enable changes.

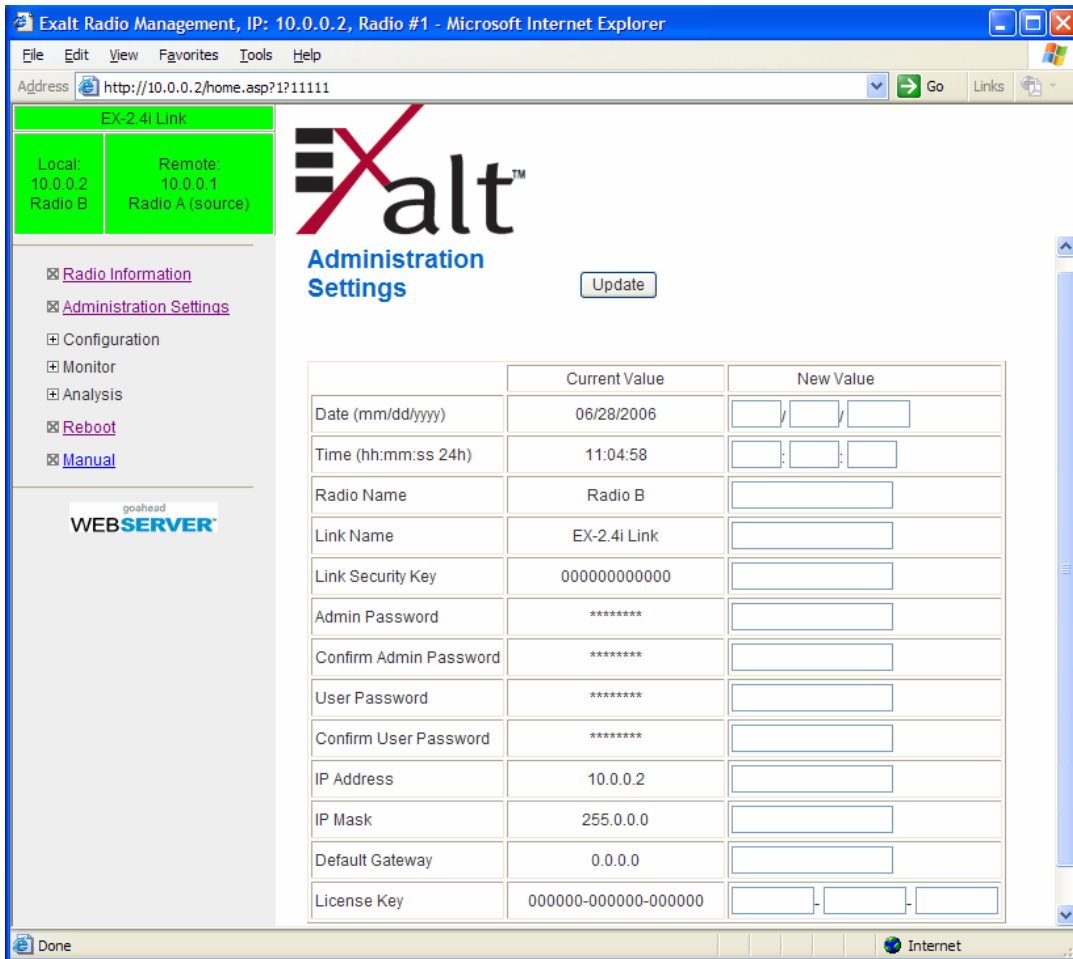

Figure 24 Administration Settings Page

Most entries on this page are self-explanatory. The following lists unique or important parameters.

- Fill in the date and time fields as soon as practical. Events are captured with time/date stamps, which is valuable information for troubleshooting.
- Set the Link Security Key to something other than the factory default setting (12 characters, all zeros) at each end. The link security key must match at both sides of the link. If the security key remains at the factory setting, the radio link is open to



sabotage by a party with the same radio model. Each link should have a unique security key. If using the same security key for every link in the network, the radio could link to any other radio with the same security key. This is problematic in multi-radio networks.

- Note that the security key must be exactly 12 characters. Any printable ASCII character can be used. The link security key is case sensitive.

 **Note:** Changing the link security key interrupts transmission until the opposite end is changed to match. **Always change the far-end radio first, and then change the near-end radio.**

- Reset the admin and user passwords. These passwords should not match. If the admin password remains at the factory default setting, it provides an opportunity for random reassignment by a network-connected user.
  - The new password must be entered twice: once in the main window and again in the confirmation window. If the passwords do not match and the UPDATE button is clicked, the password is not changed and remains set to the previous password.
- The License Key is set to all zeros. Enter the license key provided by Exalt to access extended features or diagnostic capabilities. Click **Update** to accept the changes and enable the new features. License keys are issued by radio serial number, so ensure that the license key used was issued for this particular radio.

## System Configuration Page

This page contains several critical system parameters.

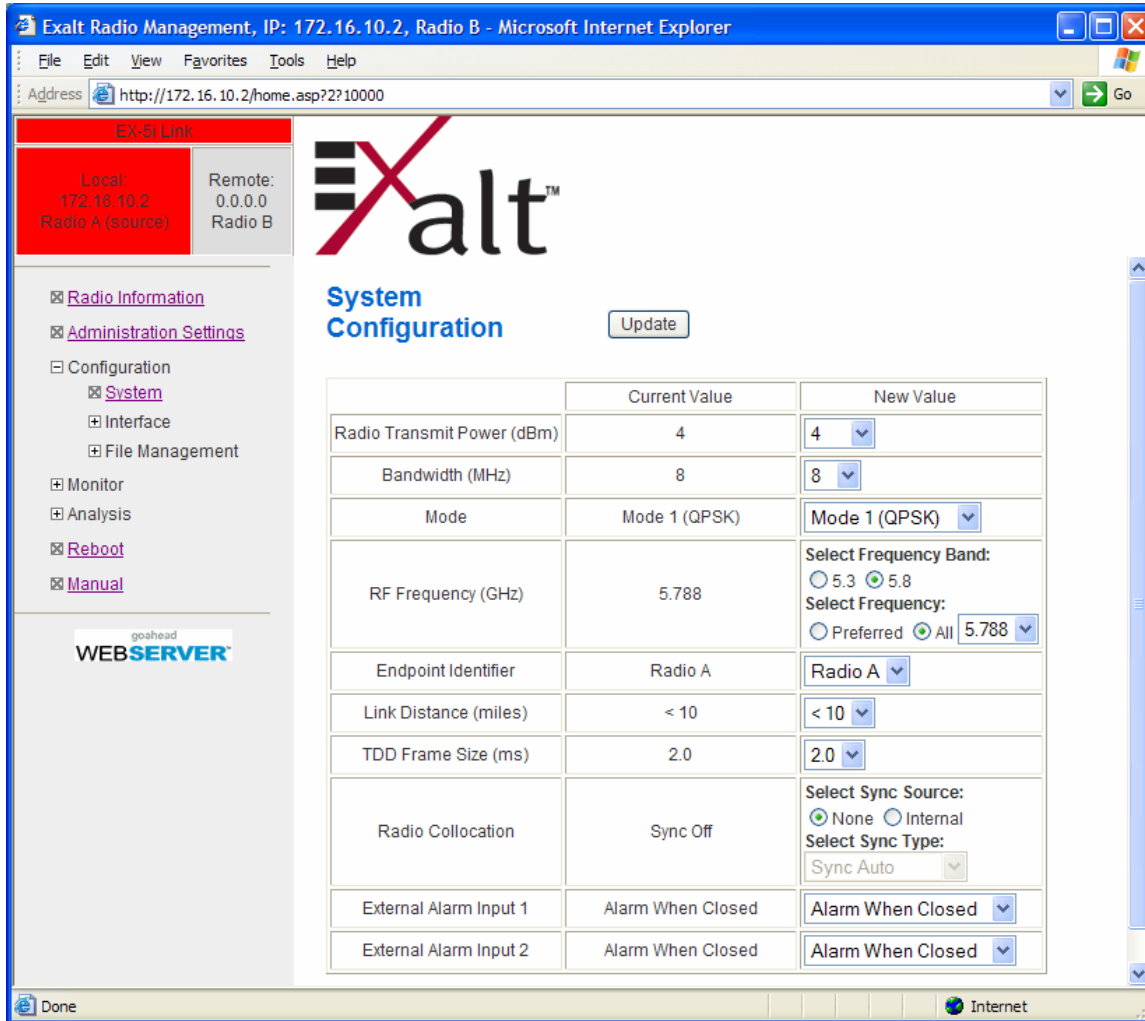

Figure 25 System Configuration Page

Most entries on this page are self-explanatory. The following lists unique or important parameters:

- Set the Radio Transmit Power parameter to the designed level. The professional installer sets this value or dictates the value of this setting to the system administrator following the system design and local regulations. In many cases, this value must be set to a proper value to comply with legal restrictions. Improper values can result in liability to the user and/or installer.

**Note:** Changing Radio Transmit Power *may* temporarily interrupt traffic. Small changes in output power do not normally interrupt traffic, but larger changes may.

- Do not adjust the Radio Transmit Power parameter to a value higher than is legally allowed.
- Do not adjust the Radio Transmit Power parameter lower than the link budget and fade margin can afford.

**The link may be lost and unrecoverable** through GUI control. If the link is lost due to reduction of Radio Transmit Power, travel to the radio location(s) may be required to reset the value.

- Set the Bandwidth parameter to the designed level. The value of this is determined in the design/engineering stage. The Bandwidth parameter must also match at both ends of the link. In conjunction with the Mode parameter, the Bandwidth parameter directly relates to the capacity, latency, and the number of TDM circuits supported. The transmitter and receiver bandwidth are modified using this parameter, making it critical that it be set with respect to the local RF noise and interference profile, and/or in relation to any multi-link network design.

 **Note: Changing Bandwidth will temporarily interrupt traffic. The Bandwidth parameter must match at each end.** Adjust the far-end radio first, and then the near-end radio. Changing Bandwidth changes the radio's threshold. A narrower bandwidth has better threshold performance and improved interference immunity, therefore if changing to a wider bandwidth, there is an opportunity that the link may be lost and unrecoverable through GUI control. Check the available fade margin and interference profile to determine if the impact to threshold and increased bandwidth is acceptable to maintain the link and the desired performance. If the link is lost due to increasing the Bandwidth parameter, travel to the radio location(s) may be required to reset the value.

- Set the Mode parameter to the designed selection. The value of this setting is determined in the design/engineering stage. The Mode parameter must match at both ends of the link. In conjunction with the Bandwidth parameter, the Mode parameter setting directly relates to the capacity of the system, as well as critical RF parameters, including receiver threshold, carrier-to-interference ratio, and in some cases, maximum radio transmit power.

**Note:** Changing Mode *will temporarily interrupt traffic*. The Mode setting must match at each end. Adjust the far-end radio first, and then the near-end radio. Changing Mode changes the radio's threshold, carrier-to-interference ratio, and also may have impact on the Radio Transmit Power. A lower mode has better threshold performance and carrier-to-interference ratio, and in some cases, higher output power, therefore if changing to a higher mode (for example, from Mode 1 to Mode 2), there is an opportunity that **the link may be lost and unrecoverable** through GUI control. Check the available fade margin and interference profile, and determine if the impact to RF performance is sufficient to maintain the link and desired performance. If the link is lost due to increasing the Mode parameter, travel to the radio location(s) may be required to reset the value.

- Set the RF Frequency parameter to the designed point. The value of this setting is determined in the design/engineering stage. RF Frequency must match at both ends of the link. It may be critical to set RF Frequency with respect to the local RF noise and interference profiles, and/or in relation to any multi-link network design.

The frequency selection section includes the ability to select from either the complete list of frequencies ("All") that can be tuned for the selected band and bandwidth, or a pre-selected list of non-overlapping center frequencies ("Preferred") that Exalt determined provides the most flexible collocation opportunities for large networks of Exalt radios

For the EX-5i families, the frequency selection section includes a band selection button that must be enabled for the frequency band of operation for which the link was engineered. In some cases, some bands may not be selectable due to regulatory constraints.

**Note:** Changing RF Frequency *will temporarily interrupt traffic*. The RF Frequency parameter setting must match at each end. Adjust the far-end radio first, and then the near-end radio. If the RF Frequency parameter is changed to a frequency with interference, the link may be lost and unrecoverable through GUI control. If the link is lost due to changing the RF Frequency parameter, travel to the radio location(s) may be required to reset the value.

- Set the Endpoint Identifier so that one end of the link is set to Radio A and the opposite end set to Radio B. In single-link networks, it is unimportant which end is designated A or B. In multi-link networks, however, it may be important to orient the links so that at any collocation site (where there are multiple radios of the same type at the same site), all radios are set to the same Endpoint Identifier (A or B). See Link Orientation and Synchronization on page 26.

**Note:** Changing Endpoint Identifier parameter requires a reboot of the radio to take effect. The reboot temporarily interrupts traffic.

- Set the Link Distance parameter to the range that is equal to or greater than the actual link distance. The value of this setting is determined in the design/engineering stage.

 **Note: Changing Link Distance parameter will temporarily interrupt traffic.** The Link Distance setting must match at each end and must not be less than the actual link distance. Adjust the far-end radio first, and then the near-end radio. If the Link Distance parameter is changed to a setting less than the actual distance, the link may be lost and unrecoverable through GUI control. If the link is lost due to this situation, travel to the radio location(s) may be required to reset the value. If the Link Distance parameter setting is set to a distance unnecessarily higher than the actual link distance, the radio may have substantially reduced performance with respect to throughput and latency.

- Set the TDD Frame Size parameter to the designed level. The value of this setting is determined in the design/engineering stage. The TDD Frame Size parameter must match at both ends of the link. The TDD Frame Size parameter setting directly relates to the capacity, latency, and number of TDM circuits that can be supported over the given link distance. In multi-link networks, especially where there are collocated links, it is also important to set all radios to the same TDD Frame Size setting to avoid self-interference. Note that the GPS or internal synch function may be necessary for these networks. See [Time Division Duplex \(TDD\) Factors](#), [Link Orientation and Synchronization](#), and [Radio Synchronization](#) for more information.

 **Note: Changing the TDD Frame Size parameter will temporarily interrupt traffic. TDD Frame Size parameters must match at each end.** Adjust the far-end radio first, and then the near-end radio. If the TDD Frame Size parameter is set to a value that cannot be supported for the link distance, **the link may be lost and unrecoverable** through GUI control. If the link is lost due to this situation, travel to the radio location(s) may be required to reset the value.

- The External Alarm Inputs parameter can be ignored unless connecting external alarm sources to the radio for monitoring the status of these external alarms through the radio management system (see [Interface Connections](#) on page 109).

## Ethernet Interface Configuration Page

This page allows the administrator to set the muting, alarm, and duplex settings of both the ETHERNET MAIN and AUX connections.

It also allows determination of the management information for in-band (carried over the air and available from both the MAIN and AUX connectors on either end of the link) or out-of-band (not carried over the air and only available from the local AUX connector).

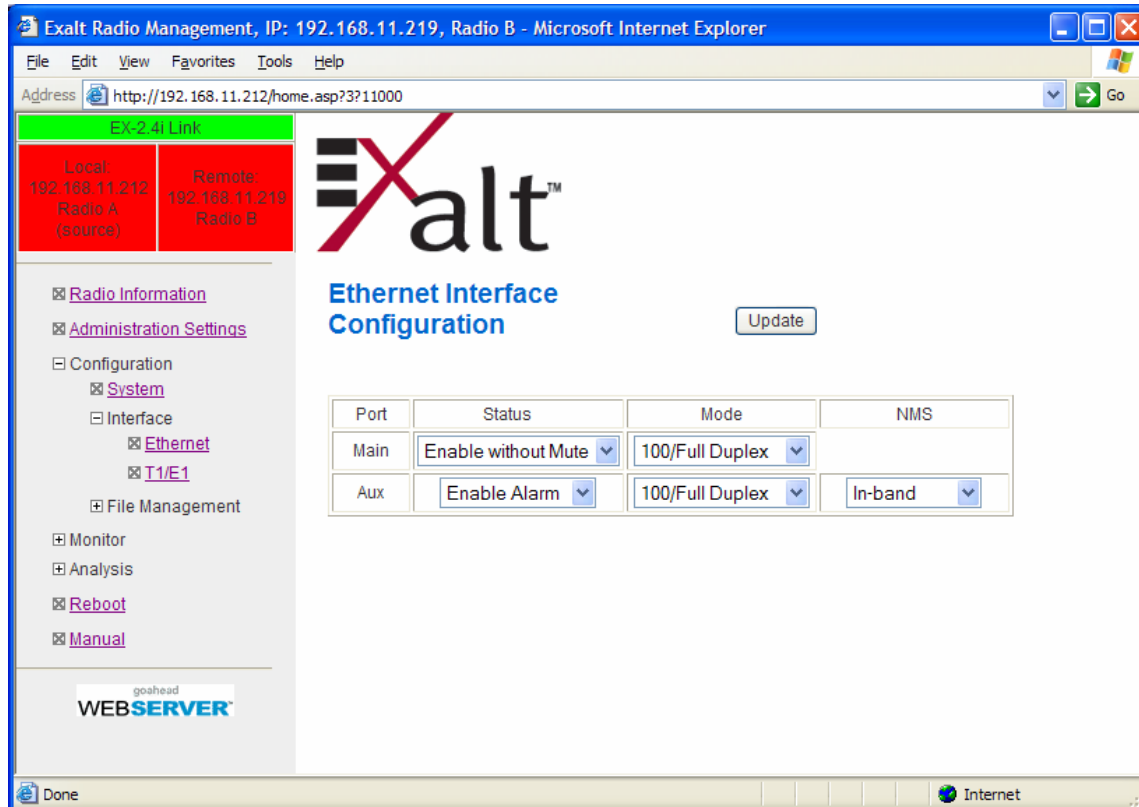

Figure 26 Ethernet Interface Configuration Page

Muting the MAIN connection is desirable when connected equipment senses Ethernet signaling and makes decisions (such, as spanning tree protocol enable) based on the presence or lack of presence of the Ethernet signal. If the MAIN connection has muting enabled, the port mutes when the link is not active.

It may be desirable to disable the alarming of the AUX connector if it is not used.

Set the Ethernet interfaces on the radio and connected equipment to 100/full-duplex for best performance. If the Ethernet ports are set to auto-negotiation, poor throughput performance may be a result, as well as intermittent disconnections of the Ethernet connection.

## T1/E1 Configuration Pages

These pages allow the administrator to selectively enable or disable the T1 or E1 circuits, one at a time. For enabled T1/E1 circuits, additional configuration, including loopback functions, are available. Disable the unused T1 or E1 so that the alarms are turned off and more throughput is allocated to the Ethernet interface. Every enabled T1 or E1 input, even if there is no T1 or E1 signal present, reduces the aggregate throughput of the Ethernet interface by roughly 3Mbps (for T1) or 4Mbps (for E1).

This page toggles between T1 and E1, as required, by clicking the Set to T1 or Set to E1 button. A warning displays that a reboot is necessary, and the radio reboots if the administrator continues. *This will interrupt traffic.* It may be necessary to re-login to the radio after the reboot completes. T1/E1 mode self-coordinates across the link if the link is active. This means that it only needs to be set while connected at one end. In addition, enabling and disabling T1/E1 circuits also self-coordinates across the link if the link is active. If a link is not active and T1/E1 enabling is a mismatch when a link is first created, the Radio A configuration for T1/E1 enabling supersedes the settings on the Radio B configuration, and changes the settings on Radio B.

 **Note:** Certain combinations of the TDD Frame Size, Link Distance, Mode, and Bandwidth parameter settings limit the number of T1/E1 circuits that can be carried by the radio. In these cases, certain fields on the T1/E1 Interface Configuration pages are not available, starting with the highest port number. For example, for a 4x T1/E1 radio version, if only three (3) circuits can be carried, port 4 is not available for configuration and is disabled. If only two circuits can be carried, both ports 3 and 4 are not available. Increasing the TDD frame size and Mode parameters, and/or increasing the Bandwidth parameter results in an increase in the supported number of T1/E1 circuits. For '-16' models, the highest number channels that are configurable (based on the currently installed license key) are disabled if they cannot be supported with the current settings.

### T1 Interface Configuration Page

This page allows the administrator to enable/disable each individual T1 channel, set the Line Build Out (LBO), Line Code (either AMI or B8ZS), and AIS enabling/disabling for each input. If enabled, the radio places an AIS code on the output of the associated interface if and when the link fails or when there is no T1 signal available from the far end to provide the user at the local end. Loopback controls are also provided (see [T1/E1 Loopback](#) on page 71).

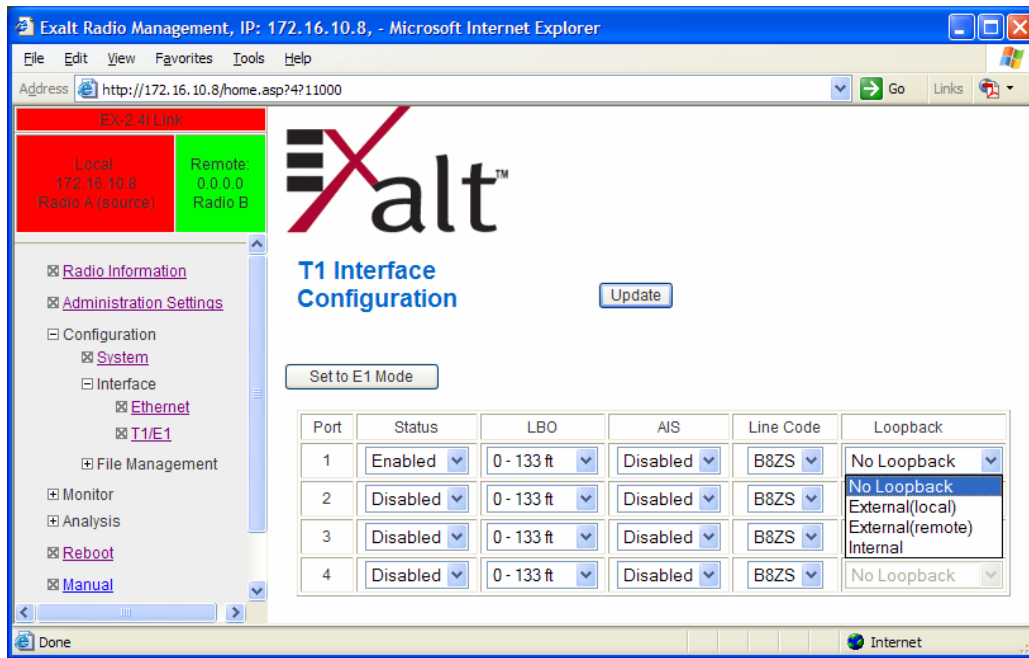

Figure 27 T1 Interface Configuration page (standard models)

### E1 Interface Configuration Page

This page allows the administrator to enable/disable each individual E1 channel. The AIS can also be enabled and disabled for each input. If enabled, the radio places an AIS code on the output of the associated interface if and when the link fails or when there is no E1 signal available from the far end to provide the user at the local end. Loopback controls are also provided (see [T1/E1 Loopback](#) on page 71).



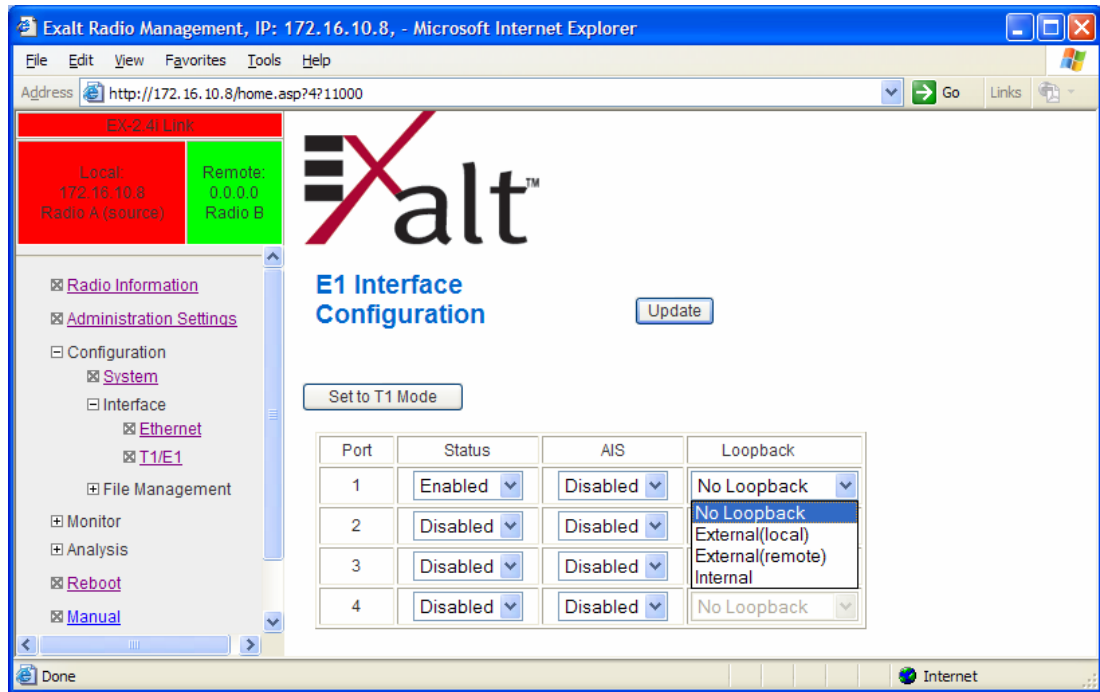

Figure 28 E1 Interface Configuration page (standard models)

### T1/E1 Loopback

Loopback is provided for any enabled T1 or E1 port. As shown in Figure 29 and Figure 30, the choices are:

- No Loopback (default)
- External (local)
- External (remote)
- Internal

**Note:** Only one Internal loopback can be enabled at any time.

All loopback configurations control the loop at the Line Interface integrated circuit, which is the device wired directly to the front panel ports.

External loopback modes are used in conjunction with an external test source. The designation of 'local' or 'remote' refers to where the loopback is occurring relative to the location where the loopback is implemented. That is, on the radio being accessed, if External (remote) is selected, this loops the signal back at the remote radio interface back towards the local radio. Likewise, if External (local) is selected, the signal loops back at the local interface towards the remote radio (Figure 29 and Figure 30).

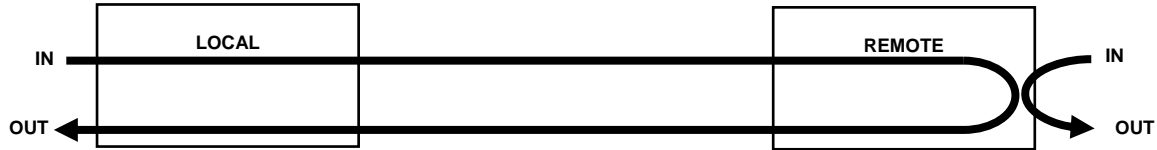

Figure 29 External (remote) loopback

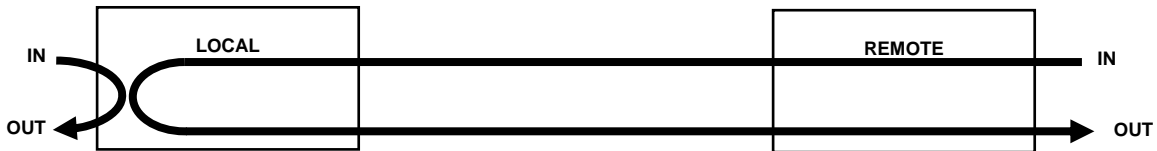

Figure 30 External (local) loopback

When a local T1/E1 port is configured for External (remote) loopback, it is the same as configuring the remote radio for External (local) loopback.

Internal loopback uses an internal test source, and sends the test source signal across the link, looped at the remote radio's interface, returned to the local radio, and looped at the local radio's interface back to the source. The inputs at both ends are looped back at the line level. Figure 31 illustrates the internal loopback function.

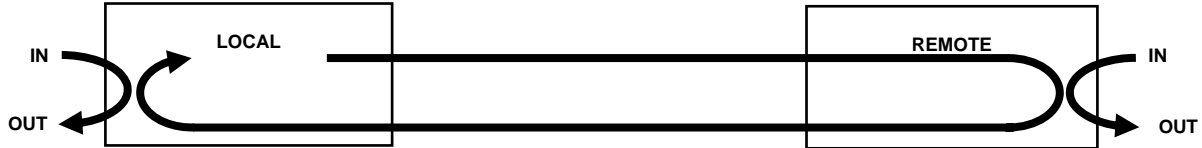

Figure 31 Internal loopback

## File Transfer Page

This page allows the administrator to upload and download files to and from the radio. Two types of files can be uploaded: configuration and radio firmware. **When uploading Configuration Files, current configuration parameters are immediately overwritten, and the unit automatically reboots.** When uploading radio firmware files, the file is placed into reserve memory space. After the new radio firmware file uploads, use the File Activation page to enable the files (see [File Activation Page](#) on page 76).

Up to three types of files can be downloaded: configuration, radio firmware, and MIB. The MIB file refers to the Management Information Base related to the Simple Network Management Protocol (SNMP) function, and is only available on models which support SNMP. See [Simple Network Management Protocol \(SNMP\)](#) on page 77 for more information.

**Note:** Check the File Activation page before uploading radio firmware files. New file uploads overwrite the secondary file location. If important files reside in the primary or secondary file location, download them before uploading the new files. Only the active radio firmware file can be downloaded. Therefore, to download the reserve file, it must first be activated (using the Swap button). See [File Activation Page](#) on page 76.

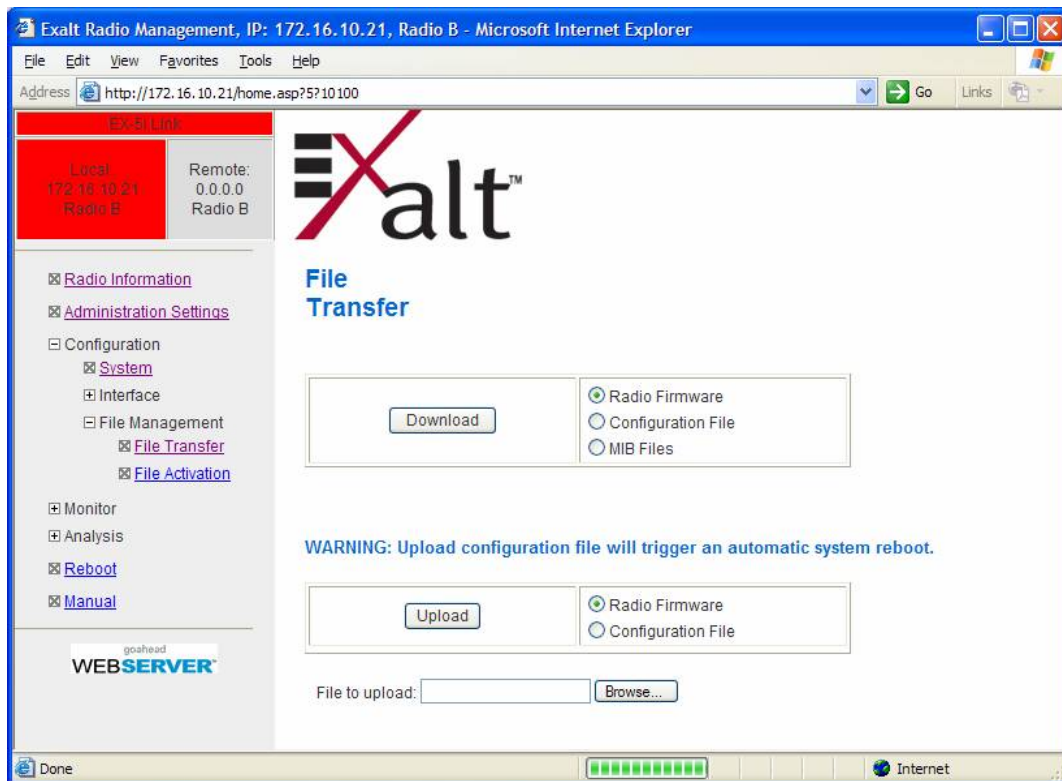

Figure 32 File Transfer Page

Use the following steps to download a file

1. Select the type of file to download (configuration or radio firmware)
2. Click the DOWNLOAD button and wait for the radio to prepare the file for download.

For the MIB file download, a second page/link appears (Figure 33).

3. Right-click the link on the page to download the file to a desired location.

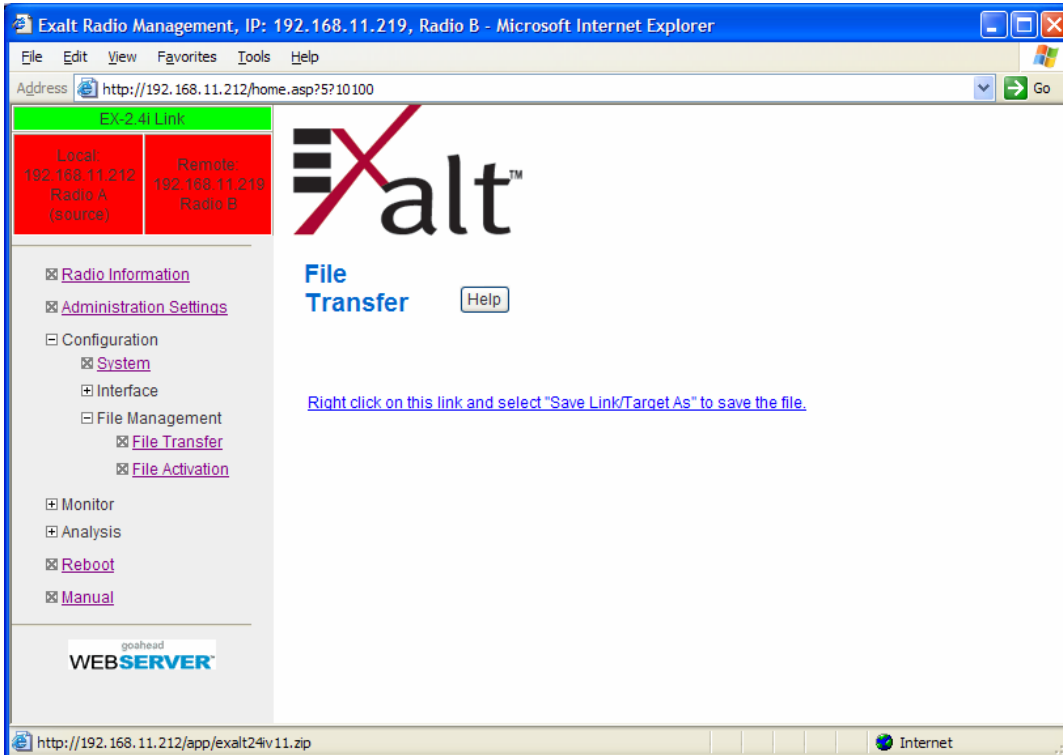

Figure 33 File Transfer page—download file link

File download and upload is useful when configuring several radios with similar settings. A copy of the configuration file can also help restore radio settings. In addition, a copy of the Exalt default configuration file is helpful to restore the radio to factory settings.

**Note:** Do not change the name of any downloaded file. The configuration file must be named config.nv. To keep track of multiple configuration files, use a folder naming system or temporarily rename the file, however, it must be named config.nv it can be uploaded to a radio. Never change radio firmware file names under any circumstances.

If copying the same configuration file into multiple radios, take as some parameters will match and that may be undesirable. However, it may be easier to change just a subset of parameters rather than every parameter.

The following parameters can cause problems or confusion if they match at each of a link:

- Radio Name
- Endpoint Identifier
- IP Address
- IP Subnet Mask
- Default Gateway

The following parameters can match at both ends of the link:

- Link Name
- Link Security Key (although each link should be different)
- Admin and User passwords
- Bandwidth
- RF Frequency
- Link Distance
- TDD Frame Size
- T1/E1 configurations
- Ethernet configurations

## File Activation Page

Use this page to move stored or uploaded files for use on the radio. The page indicates which file is currently in use, and which file is available for use. Click the Swap button to place the file in the Alternative File column into the active state and move the file in the Current File column to the Alternative File column.

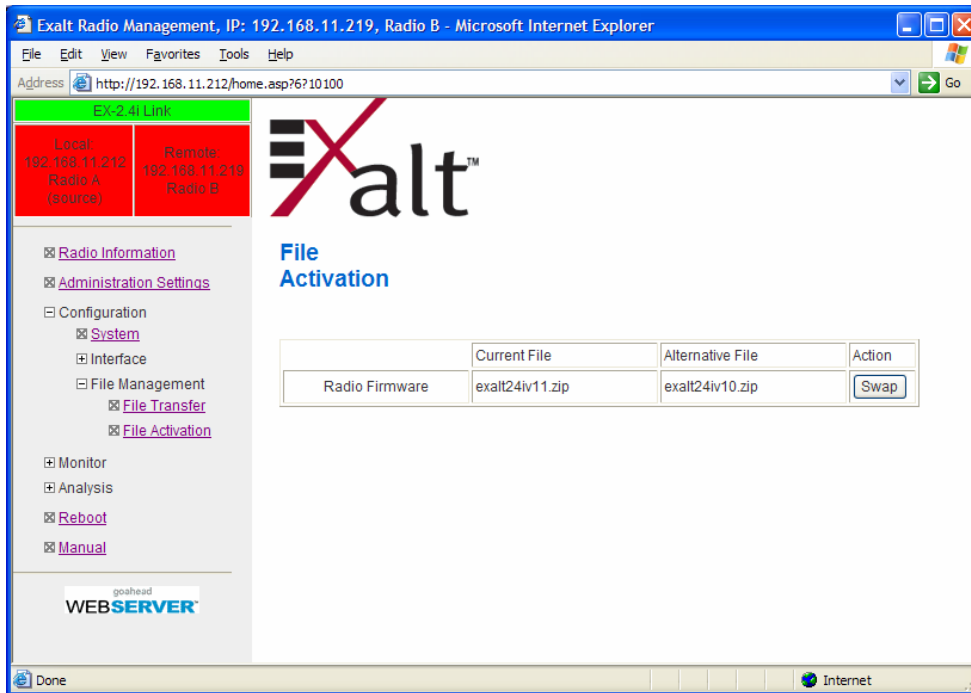



Figure 34 File Activation page

**Note:** In all cases, the radio reboots after a new file is selected using the Swap function. This places the radio out of service for a short period.

## Simple Network Management Protocol (SNMP) Configuration

Use SNMP to manage networked devices and execute the following functions:

- GET: Obtain information from the device, such as a configuration setting or parameter.
- SET: Change a configuration setting on the device.
- TRAP: The device proactively informs the management station of a change of state, usually used for critical alarms or warnings.

 **Note:** Currently the SNMP implementation does not support TRAP functions. For critical alarms, use the GET command for specific alarm conditions.

One feature of the SNMP implementation is that system configuration changes do not take effect using the SET command. Instead, groups of configuration settings can be preconfigured for global change, and a single 'Save' (Commit) command implements all changes.

When some parameters are changed, a link may drop and/or management control lost. MIB files allow many parameters to be set at once, allowing only a temporarily dropped link or management control issue. The opposite end radio can be quickly reconfigured, with little downtime for the link and management control. The save (Commit) command is similar to the Update button.

Dropped links or management control issues do not occur with every parameter change. Many configuration changes do not impact traffic or management access.

Exalt radios utilize SNMPv3, a high security version of SNMP, to ensure secure access to and storing of management data. The SNMPv3 security string matches the admin and user passwords. Passwords must be eight characters or longer.

 **Note:** Currently not all EX-series radios implement SNMP. Check the software release notes to verify that the function is available. Generally, the radio supports SNMP when MIB files are listed on the [File Activation Page](#).

The SNMP MIBs are organized similar to the GUI. Become familiar with the GUI before using the SNMP function.

## Alarms Page

This page provides an easy-to-read summary of the alarm status of both local and remote radios. The colors on this page reflect the color of the alarms displayed on the radio front panel. However, additional detail displays on this page to aid in quick assessment of issues and status.

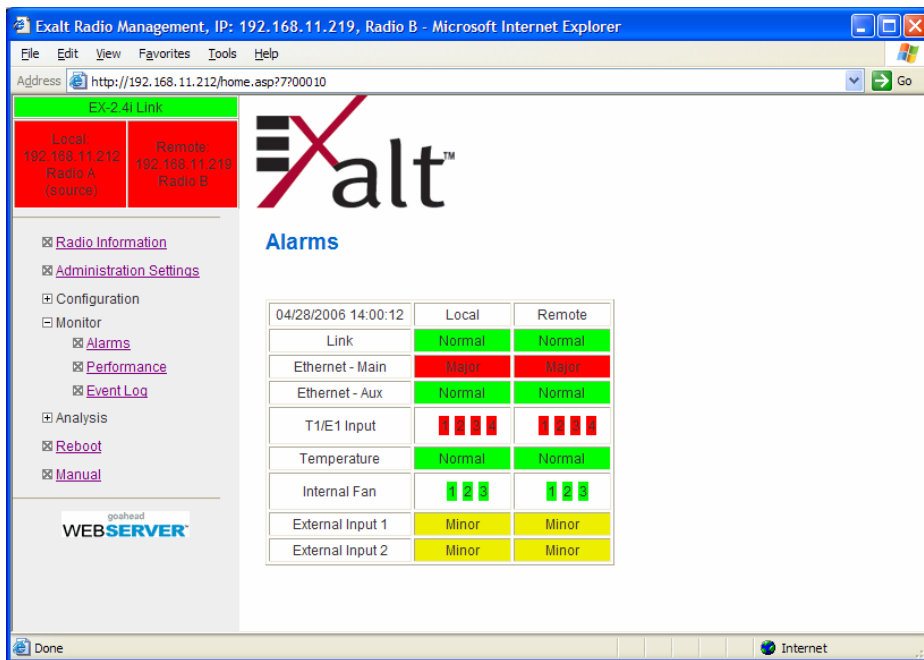

Figure 35 Alarms page (standard models)

See [Table 3](#) for more information on the front panel LEDs. This page displays additional information about the alarm status.

- The Internal Fan alarm monitors all three internal fans. The radio only requires that one fan be operational for full-specification performance. The additional fans are provided for redundancy and to increase overall reliability. If one or two fan alarms are yellow or red, it is prudent to plan to install a spare radio at the earliest opportunity and return the radio for repair (RMA authorization required). If all three fans are in alarm, the radio must be taken out of service immediately, as damage may occur to the internal electronics, especially in hotter environments or where thermal exchange from neighboring equipment exists.



- The Temperature alarm monitors the internal temperature of the unit based on specific points inside the radio chassis. It is normal for the internal temperature to be above the ambient temperature, so the temperature reading may be higher than the highest specified ambient temperature. When the internal electronics reach a point that is higher than the normal temperature rise at the highest ambient temperature, the temperature alarm turns yellow. Power down the radio as soon as possible, and investigate the cause of the temperature rise before the radio is put back into service. In almost all cases, a temperature alarm is due to an external cause, unless the fans in the unit are also in alarm, in which case, the fans are the likely cause.

## Performance Page

This page provides statistical information about the performance of the system in relation to the integrity of the user data and the RF link.

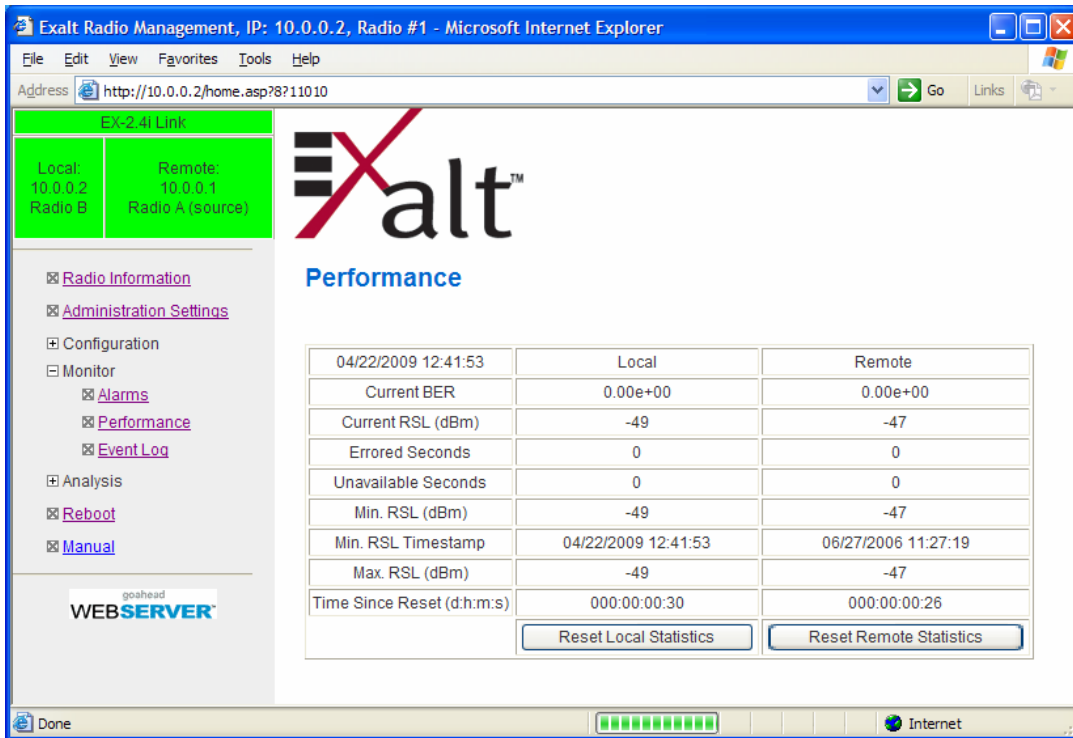



Figure 36 Performance page

- The Current BER field indicates the current bit error rate of the link. If the link is operating perfectly, this should indicate zero. Generally, the link should remain at a BER less than  $1 \times 10^{-6}$  (1 bit out of every million bits errored). This is the threshold performance specification and the standard to which the link was engineered. However, radio links can and are affected by weather, interference, and other external sources and will occasionally have a higher error rate. A link remains operational unless the BER exceeds  $1 \times 10^{-3}$  (1 bit out of every hundred bits errored). Consult the link design engineer for an understanding of the predicted error rate of the radio link as it has been designed. Many applications are unaffected by bit errors, but TDM circuits (for example, T1 or E1) are more sensitive. Also, if the link operator is providing a service guarantee, this value may need to be monitored or examined in cases of service issues. The behavior of BER in relation to other alarms or measurements and external events can be very helpful in troubleshooting activities.

- Current RSL is the measurement of the received signal level at the radio antenna port. This is the measured level of the RF signal coming from the opposite end of the radio link. The link was engineered to a specific RSL by the link design engineer, and this RSL should be obtained during installation and remain relatively stable during the operation of the link. RSL can and will vary as a result of weather changes and other external sources, such as path obstructions. Once again, this variation was part of the original design to achieve a certain level of performance over time. Bit errors occur when the RSL falls to a level within roughly 3dB of the threshold specification. When the RSL falls below the threshold specification, the link disconnects and will not reconnect until the RSL is above the threshold specification. The behavior of RSL in relation to other alarms or measurements and external events can be very helpful in troubleshooting activities.
- Errored Seconds (ES) indicates the total number of seconds that occurred where there was at least one bit error since the last time that the radio statistics counter was reset. Generally, ES are not a significant concern, so long as they are not continuous or above the anticipated performance based on the original link engineering goals. If ES are continuous or at a high rate, this is normally an indication of poor link performance due to poor RSL or interference, or severe impact by weather or other environmental factors. However, similar to the performance factors previously listed, ES can and will occur in any radio link. Once again, consult the link engineer to determine the original design goals, and compare actual performance to these expectations to determine if any improvements are necessary or if other problems may be causing excessive ES.

 **Note:** Unavailable Seconds do not register as ES. In other words, the ES counter counts all seconds that are errored NOT INCLUDING the seconds that were classified as unavailable. The total number of seconds with errors or outages is the sum of ES and Unavailable Seconds.

- Unavailable Seconds (also called UAS) are similar to ES, but this counter keeps track of every second where the bit error rate equals or exceeds  $1 \times 10^{-3}$ , as well as any seconds where there is a complete loss of radio communication, over the period since the last counter reset. If Unavailable Seconds are continuous or at a high rate, this is normally an indication of poor link performance due to poor RSL or interference, or severe impact by weather or other environmental factors. However, similar to the performance factors listed above, Unavailable Seconds can and do occur in any radio link. Consult the link engineer to determine the original design goals, and compare actual performance to these expectations to determine if any improvements are necessary or if other problems may be causing excessive Unavailable Seconds.
- Minimum RSL indicates the worst (lowest) received signal level that occurred since the last counter reset. It is helpful to know if the RSL dropped significantly from the normal level, or has reached a level near or below threshold.
- Minimum RSL Timestamp indicates the date and time when the Minimum RSL occurred. This is helpful for general troubleshooting, and especially comparing to items in the event log or diagnostic charts from the same time period.

- Maximum RSL indicates the best (highest) RSL that occurred since the last counter reset. This indicates the best performance of the radio link, which is normally equal to the installed value, and is usually the designed value.
- Time Since Reset indicates the amount of time passed since the last counter reset. This helps to quantify the seriousness of other statistics, such as ES and Unavailable Seconds, if there have been high numbers of ES and/or Unavailable Seconds over a relatively short period of time.

Each end of the link statistics on this page can be independently reset using the Reset Statistics button for the local or remote radio. It is good practice to reset the statistics at the time that the link is commissioned (after all antenna alignment is complete and stable RSL at designed levels is achieved, and no more system reboots are anticipated). Make a habit of viewing this page regularly, make records of the performance, and reset the statistics so that the counters can more precisely pinpoint issues.

 **Note:** Resetting statistics from one end also resets the statistics for the same radio at the opposite end. That is, if the Local statistics are reset, logging into the remote end shows the Remote statistics on that end (which is the local radio in the first condition) as being reset at the same time.

## Event Log Page

Use this page to review a list of the events logged by the radio. The following items are listed in the event log:

- Alarms
- Alarms clearing (Normal)
- Radio Reboots

The screenshot shows a web browser window titled "Exalt Radio Management, IP: 192.168.11.219, Radio B - Microsoft Internet Explorer". The address bar shows "http://192.168.11.212/home.asp?9700010". The page content includes a navigation menu on the left with options like "Radio Information", "Administration Settings", "Configuration", "Monitor", "Analysis", "Reboot", and "Manual". The "Event Log" section is active, displaying a table of events. The table has columns for Date/Time, Description, Severity, and Status. The events listed include RF Sync loss, BER 10^-3, and BER 10^-6 with various severity levels (Critical, Major, Minor, Info) and statuses (Normal, Alarm).

Date/Time	Description	Severity	Status
4/28/2006 14: 4:54	RF Sync loss	Critical	Normal
4/28/2006 14: 4:52	BER 10 <sup>-3</sup>	Major	Normal
4/28/2006 14: 4:51	BER 10 <sup>-6</sup>	Minor	Alarm
4/28/2006 14: 4:51	BER 10 <sup>-3</sup>	Major	Normal
4/28/2006 14: 4:50	BER 10 <sup>-6</sup>	Minor	Alarm
4/28/2006 14: 4:50	BER 10 <sup>-3</sup>	Major	Normal
4/28/2006 14: 4:49	BER 10 <sup>-6</sup>	Minor	Alarm
4/28/2006 14: 4:49	BER 10 <sup>-3</sup>	Major	Normal
4/28/2006 14: 4:48	BER 10 <sup>-6</sup>	Minor	Alarm
4/28/2006 14: 4:48	BER 10 <sup>-3</sup>	Major	Normal
4/28/2006 14: 4:48	RF Sync loss	Info	Alarm
4/28/2006 14: 4:47	BER 10 <sup>-6</sup>	Minor	Alarm
4/28/2006 14: 4:45	RF Sync loss	Critical	Normal
4/28/2006 14: 4:44	BER 10 <sup>-3</sup>	Major	Normal

Figure 37 Event Log page

Every event is tagged with the time that the event occurred, and a severity and type. The event log also allows filtering to limit the view of the log to the lowest level of desired information. For example, a filter level of Minor displays Minor, Major, and Critical severity events.

The log contains the last 200 events. Events are deleted on a FIFO basis, erasing the oldest entries to make room for the newest entries.

The event log can be cleared and be downloaded from the radio (some models may require a software upgrade to enable this feature). A screen capture of the browser window can serve as a useful record.

## ***Diagnostic Charts Page***

Use this page as an aid in troubleshooting. This page illustrates the historical (and current) performance for three parameters: RSL, Radio Temperature, and BER.

The horizontal scale illustrates 120 points of time measurement and is synchronized on all three graphs. The scale displays in minutes, hours, or days from the last two hours (120 minutes), five days (120 hours), or four months (120 days). All information is stored, so all of these periods are available for short- and long-term performance analysis. The right side of a graph represents the most recent measurement, and data ‘marches’ from the right-to-left at every interval.

The vertical scale of each chart independently scales to show the maximum resolution based on the maximum variation of the data over the selected time measurement.

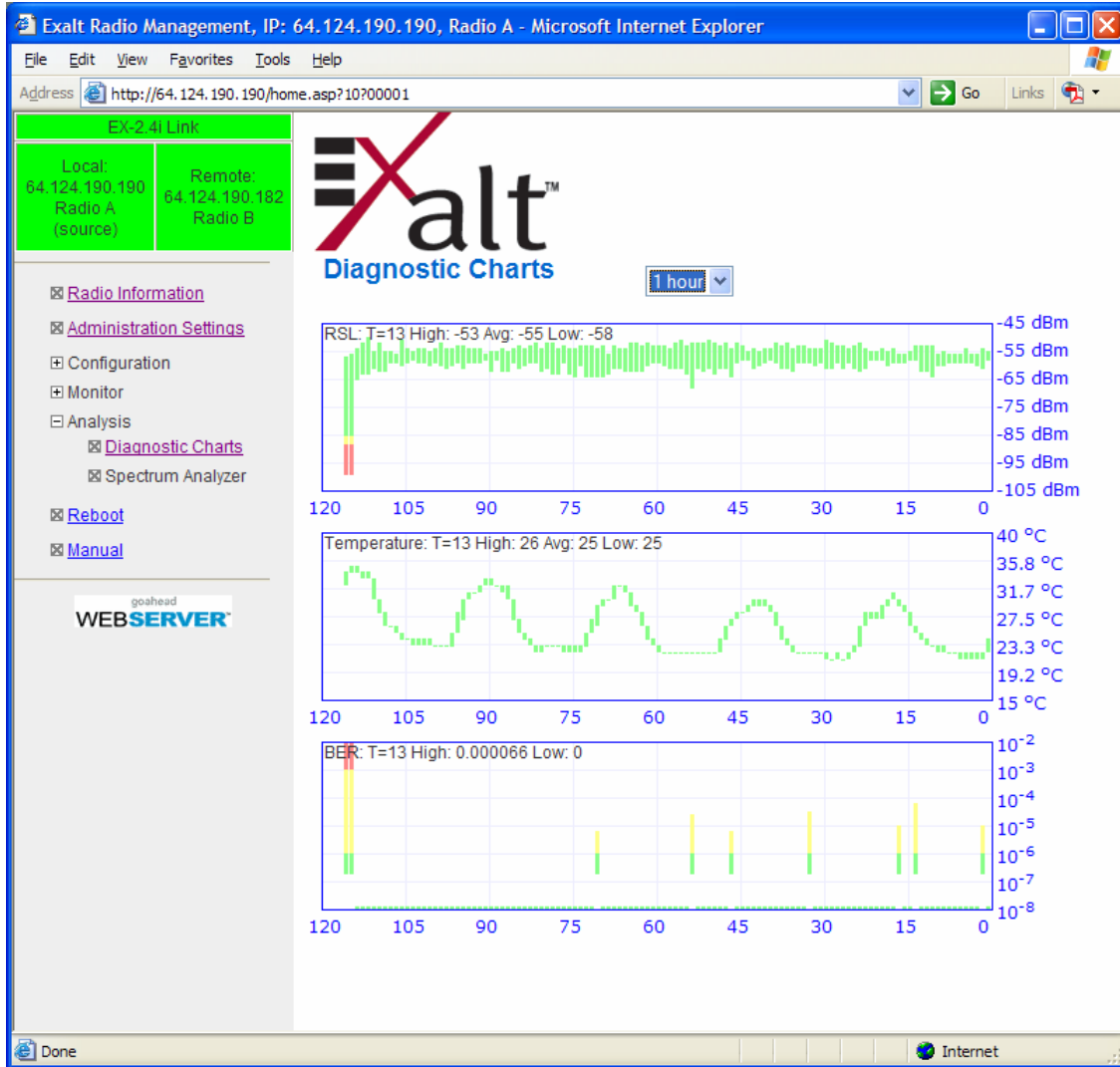

Figure 38 Diagnostic Charts page

Use the cursor to point to any spot on any of the three charts, and all three charts illustrate the measurements taken for that time interval in the upper-left corner of each chart. The time interval is indicated by T=(value). This is followed by the value of the measurement, listing the highest value, lowest value and average value measured over that time interval.

For example, in Figure 38 the displayed time interval is hours, and the cursor is held at the T=13 mark on the horizontal axis. The measurements shown indicate performance from 13 hours ago. The high/low/average values shown on each chart are measurements made across that specific one-hour interval.



Changes in RSL often have an impact on BER, and this can be confirmed by looking for synchronized events. When BER events occur without corresponding changes in RSL, this normally indicates interference, atmospheric changes, transmission system issues (such as problems with cables, connectors or antennas), or possibly radio hardware problems.

It is also useful to help determine if changes in radio temperature are occurring, and if they are having any impact on RSL or BER. If the radio is mounted in an environmentally controlled location, this has less relevance. However, temperature monitoring can be helpful to ensure that the radio is operating within specifications.

### ***Spectrum Analyzer Page***

This page is not currently available. A built-in spectrum analyzer will be available in future releases, and documented.

## Reboot Page

Use this page to reboot the radio. The function may never be required, but can be used in emergencies. All configurations that require a reboot automatically reboot on administrator confirmation.

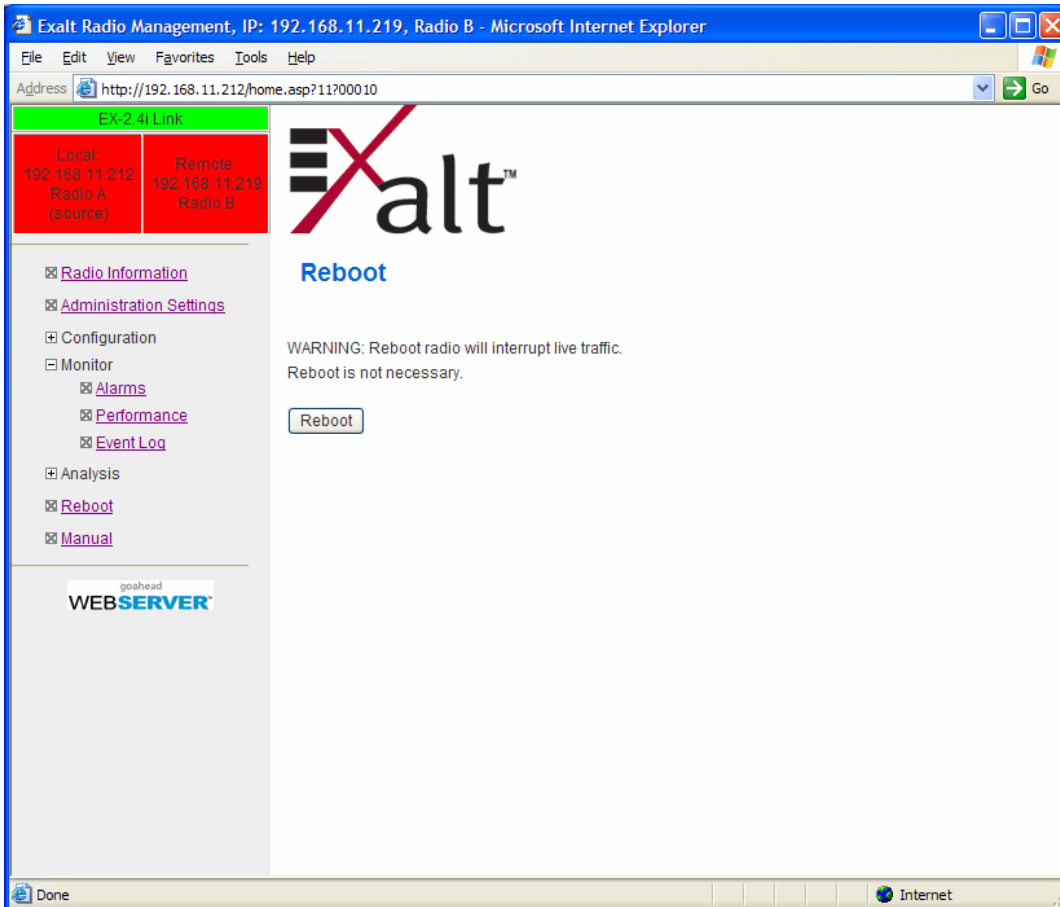

Figure 39 Reboot page

## Manual Page

The manual (this document or the version that matches the installed firmware) is available within the GUI. Adobe Acrobat Reader 5.5 or higher is required (go to [www.adobe.com](http://www.adobe.com) to download Acrobat Reader). Click the Manual link and the manual displays within the browser window. Once the manual displays, click the save button on the PDF toolbar to download the manual locally.

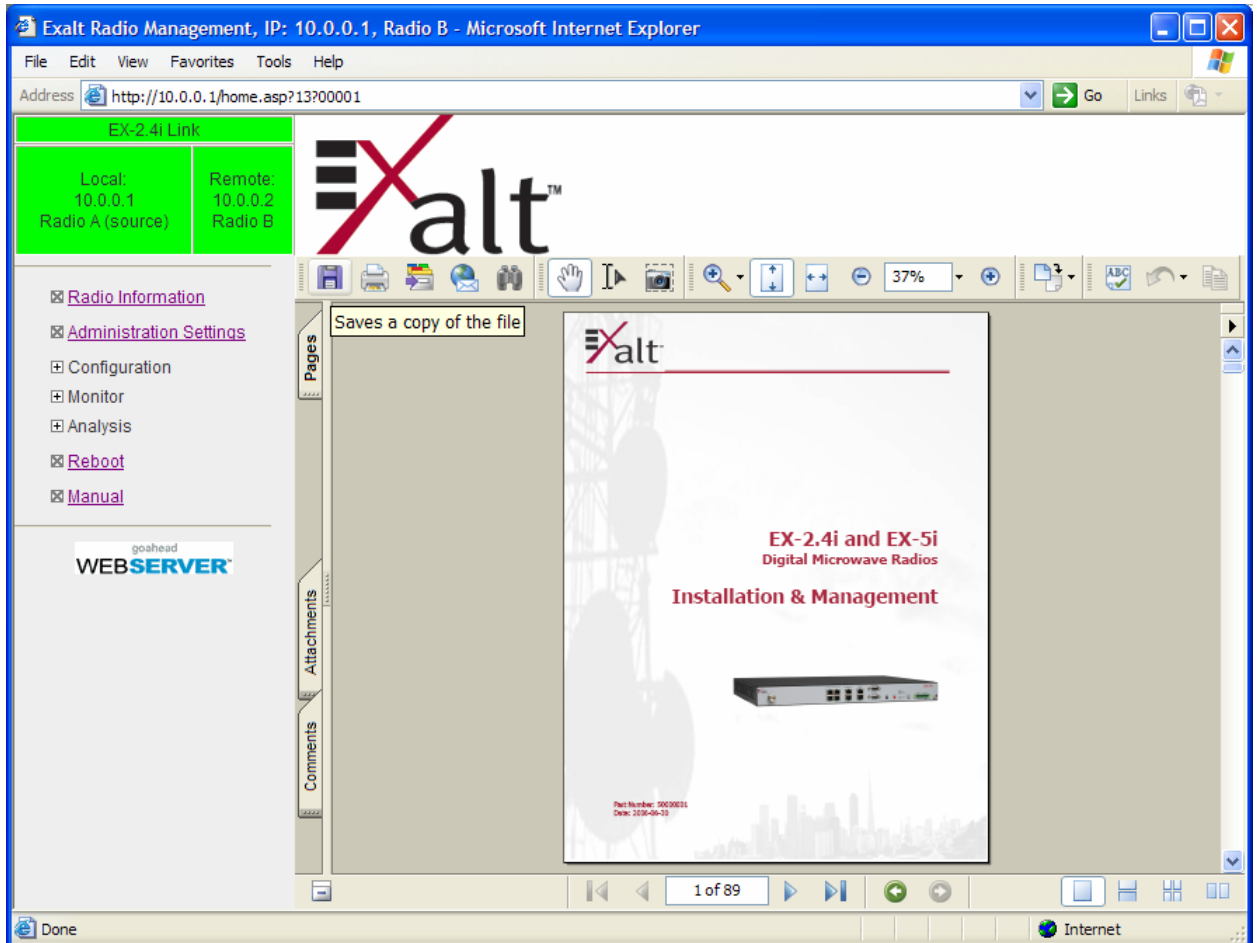

Figure 40 Manual page

## Troubleshooting

This section provides information regarding troubleshooting of common issues and alarms on these radios. Exalt Digital Microwave Radio systems are designed by Exalt's expert engineers with extensive experience through multiple generations of microwave radio design. These new-generation systems contain extensive diagnostic tools, alarm indications, and troubleshooting aids. And, as compared to other systems in their class, are easier to install, maintain, and troubleshoot. The GUI provides information to aid in troubleshooting (see [Diagnostic Charts Page](#) on page 85).

Contact Exalt Customer Care for further assistance with issues with your Exalt radio and with suggestions on how the radio and documentation can be improved.

### **General Practices**

Troubleshooting a microwave radio link can be a complex task. Approach troubleshooting as a process of elimination, and first determine which portions of the system are operating properly.

In a vast majority of cases, failures or poor performance of microwave links is attributed to something other than the microwave radio hardware. In this respect, the back-to-back bench test (see [Back-to-back Bench Testing](#) on page 104) is very important to determine if radio hardware is operating properly and eliminate many variables in the troubleshooting process.

If a back-to-back bench test fails, then the radio hardware is either broken or the radios are improperly configured. Upgrade the radio to the most current release of firmware, and/or reset the radio to its critical factory settings, following the quick start guide instructions and those in [Configuration and Management](#), helps to confirm if configuration issues cause failure. The most common issues with microwave radio links are:

- An improperly terminated RF cable
- Multipath propagation
- RF interference
- Path obstruction
- Misaligned antenna
- Faulty antenna
- Improper grounding
- Insufficient link margin in the design/implementation
- Moisture in the transmission system (antenna feed and/or RF cable)

If the radio link has been operating without issues and is exhibiting new poor performance behavior or becomes completely inoperative, the troubleshooting process should pay close attention to any conditions that may have changed between the time when the system was working without issue and the time when the issues started.

Also, it can be helpful to compare some performance parameters of the system before and after the presence of issues. Often the source of the issues can be determined by thoughtful consideration of changes, such as:

- Changes in weather, including high winds
- Changes made to the radio equipment, transmission system, or connected equipment
- New radio systems or electronic equipment the nearby radio or transmission system
- New construction nearby either end of the link, or along the path
- Tree growth, flooded fields, or changes in rivers/lakes along the path

Verify that configurations are set as follows:

- RF matches at each end of the link
- Bandwidth matches at each end of the link
- Link distance matches at each end of the link
- TDD Frame Length matches at each end of the link
- Endpoint Identifier is different at each end of the link (one end Radio A, one end Radio B)
- Ethernet interfaces are enabled, as desired
- AUX Ethernet is set for in-band or out-of-band NMS, as desired
- T1/E1 enabling matches at each end of the link
- Link security key matches at each end of the link

Also, use the **ExaltCalc** tool in the design phase to determine the optimum setting for the Bandwidth and TDD Frame Length parameters for the given link distance, and provides guidance to the expected RF link performance, as well as throughput, latency, and number of supported T1/E1 circuits.

### ***Typical Indications of Issues***

In many cases, microwave radio users do not notice changes or degradation to the radio system until the radio system fails completely or becomes highly errored or significantly intermittent. However, regular management of the radio system can help indicate changes in performance that have not yet impacted user performance, but may impact performance at a later date if left unchecked or unaddressed. The administrator can use this as an opportunity to be proactive and monitor the radio link performance regularly, watching for unexplained or unexpected changes in performance and trends in performance changes.

Most importantly, monitoring radio system RSL over time indicates the performance of the radio system. Address any long-term drop in RSL and erratic or unsteady RSL. Some RSL changes are expected and weather patterns and the related multipath can cause dramatic RSL changes resulting in system outage. However, that outage should not occur at a significantly greater rate than the designed long-term performance. Consult the path design engineer for more information about link reliability expectations and anticipated RSL deviation.

In addition, regular inspection of the transmission system (RF cables and antennas) and paying close attention to changes along the path, such as construction or tree height, or new microwave radio installations nearby, can be extremely helpful and proactive.

When link performance is very poor, alarms on the radio front panel and within the radio's management system indicates particular failures. Consult this manual for more information on the specific alarms and diagnostics, or contact Exalt Customer Care for assistance.

Exalt Customer Care is primarily motivated to determine if the radio hardware is faulty and require return for repair, and to help execute an effective and efficient repair and return process for radio terminals believed to be faulty. However, Exalt Customer Care provides advice regarding the total radio system and RF path engineering and environment, and advises on troubleshooting.

End users should first contact the installer and/or designer of the system. In many cases, an in-depth understanding of RF design is required, and on-site analysis and special test equipment, may be necessary. Compared to phone support from Exalt Customer Care, troubleshooting is much more expeditious if the professional installer and/or link designer examines the system and reviews the management information in the GUI. In turn, if the professional installer and/or link designer contacts Exalt Customer Care, the process to rectify the system is much more expedient due to the in-depth knowledge related to the implementation and the RF environment.

### ***Improper RF Cable Termination***

Improper RF cable termination is a very common problem. In many cases, this is a problem that occurs during installation and is not a problem that suddenly appears. However, if cables are moved or flexed, especially near the termination points, and radio errors, changes in RSL, or other performance issues occur, this is a certain sign of this issue.

Another relatively easy method to test for this condition is to decrease the output power of the radio system (at each end, one end at a time). A poor RF cable termination may be reflecting too much RF energy back into the radio system, and reducing output power reduces the reflected energy at a faster rate than the transmitted energy towards the far end. Be careful not to reduce the output power to the point where the radio's threshold is reached. Typically, a reduction of just 3 to 6dB is enough to determine if this is the issue. If the reduction of output power clears the error condition, this is the likely cause.

Use a reflectometer or meter that can read VSWR at the operating frequency to identify poor terminations as well as poor antenna feeds.

 **Note:** The Praxsym VSWR meter is an excellent tool for this purpose

## **Multipath Propagation**

Multipath propagation is a term that encompasses changes to the RF path, such as reflections and/or refraction, causing partial or complete destruction of the radio signal, and thus excessive bit errors and/or system outages.

Rapid changes in temperature, inversion layers, humidity, air pressure, water evaporation, as well as standing water or moisture on objects along the path are all examples of changes that can cause multipath propagation. New building construction near either end of the path or along the path can cause new reflection characteristics.

If your system has been operating without issue and is suddenly experiencing issues that are symptomatic of a certain time of day or related to change in climatic events or some of the external factors listed above, this is likely the cause. Consult a professional RF path engineer in these cases. Often, minor repositioning of the antennas at either or both ends can reduce or eliminate these problems.

## **RF Interference**

RF interference is usually indicative of another radio system nearby either end of your radio system or aimed towards one or both ends of your radio system – usually at or near the same frequency and usually a signal level similar to the level of the signal of your radio system.

Other forms of RF interference also exist, such as electronic equipment placed close to the radio chassis or transmitters that couple onto the cabling or grounding system of the radio. Microwave ovens and wireless communication devices used near the equipment or cabling are examples of electronic equipment interference.

 **Note:** The EX-2.4i and EX-5i operate in license-exempt bands. Microwave ovens, wireless Internet devices and cordless phone technology may also use this frequency band. It may be necessary to separate the radio chassis, cabling system and antenna from these devices.

RF interference, like most other causes of problems, is indicated by significant bit errors and/or system outages.

One means to determine presence of interference is the use of a spectrum analyzer that covers the same range as the radio system. A professional RF engineer can use a spectrum analyzer to locate sources of interference, measure these sources, and determine potential remedies to take to operate in the presence of interference.

If a spectrum analyzer is not available, the radio's RSL port can help determine RSL levels of interfering signals. By turning the far-end radio off, the residual RSL measured

by the radio indicates the level of interference seen by the radio. It is possible that interference levels below that which can be measured still have an impact on the radio system – especially if the radio system has low fade margin or is using a high order modulation.

The EX-2.4i and EX-5i families provide considerable flexibility to tune to different frequencies across the bands within which they operate. This is the easiest method to use to try to avoid existing interference. In addition, the occupied bandwidth of the radio can be reduced. This, along with re-tuning, can be very effective, however throughput is reduced.

Repositioning the antenna and/or changing polarization, or upgrading the antenna to a higher gain, and/or using a high-performance antenna, are all secondary means that can be used. It may be necessary to perform combinations of both radio changes (retuning, occupied bandwidth reduction) and antenna system changes (position, polarization, upgrade).

The EX-4.9i radio operates under licensed regulations. If interference is suspected, the local frequency coordination organization, or other users of the spectrum should be consulted before re-tuning the radio to a different frequency channel.

### ***Path Obstruction***

A path obstruction is defined as an object, such as a building or tree, impeding the proper path of the radio system. If the system design was proper at the time of installation and issues arise at a later date, an updated path profile and survey may be necessary to identify changes in path clearance.

### ***Misaligned Antenna***

At the time of initial installation, it is critical that the antennas at each end are properly aligned and that the designed RSL is achieved. However, antennas may become misaligned due to high winds, changes in the guy-wiring systems keeping the antenna mast stable, or loosening of the antenna mounting hardware. A reduction in the RSL of the link is symptomatic of this condition, but this condition is not the only condition that results in a reduction of RSL. However, if conditions occur where the antenna alignment may be suspected, the mechanics must be inspected and the antennas realigned.

### ***Faulty Antenna***

A faulty antenna is rare, but is still a possibility. In some cases, the mechanics of the antenna feed can get moisture inside, or a bad or weak connection in the pin and connector structure of the antenna may occur. A VSWR measurement of the antenna connection can be made to verify this condition.



## ***Improper Grounding***

In addition to being a potential human safety issue, improper system grounding is a somewhat common condition that can cause continuous bit errors or bit errors when metal objects come in contact with the radio, transmission system, or racking system. If touching the radio causes errors, grounding is the cause. It can be difficult to identify grounding problems, but a professional electrician can normally inspect a system and identify if there are deficiencies in the grounding system.

## ***Insufficient Link Margin***

Ideally, the link was designed with enough link margin (fade margin) to allow for multipath propagation and atmospheric fading and still remain reliable. In some cases, link margin is compromised by economic factors, such as using low-cost RF cabling or lower-cost antennas that have less gain or deficient performance compared to higher cost transmission system components. In some cases, there may be antenna size restrictions that forced the design to not have the desired amount of link margin.

If the link was designed with poor link margin, there are likely many cases of bit errors and outages. The antenna system and transmission line can be upgraded to help reduce this. If the link design was installed with sufficient margin, but RSL is reduced, the remaining link margin may no longer be enough to maintain a reliable link. The causes of RSL reduction were previously described, but are usually due to new path obstruction(s) or antenna misalignment due to wind or mechanical factors. The antenna height or location can be changed to overcome new obstructions. Realignment of the antenna, and/or improvement to mechanical structures can help overcome antenna misalignment.

## ***Moisture in the Transmission System***

If the connectors on cables and antennas and egress junctions are not properly weatherproofed, moisture can get into the transmission system and cause significant error conditions and erratic performance. In many cases, the transmission system must be replaced. A VSWR meter is one means to identify such issues. Physical inspection can be helpful, and if changes to the weatherproofing occur (such as cracks), the weatherproofing must be replaced before it leaks.

## Specifications

This section presents specifications for the i-Series of Digital Microwave Radios.

### **Physical Specifications**

Physical Configuration	Single-piece Indoor Unit (IDU)
Dimensions (HxWxD), (std models)	1RU: 1.75" x 17" x 14"/ 4.5 x 43.2 x 35.6 cm
Dimensions (HxWxD), (-16 models)	1.5RU: 2.63" x 17" x 14"/ 6.7 x 43.2 x 35.6 cm
Weight (std models)	11.3 lbs/5.1 kg
Weight (-16 models)	12 lbs/5.5kg
Operating Temperature	-13° +149°F /-25° to +65°C
Altitude	15,000/4.6 km
Humidity	95% non-condensing
Safety	EN 60950-1, IEC 60950-1
EMC	EN 301 489-17 (EX-5i and EX-2.4i series), FCC Part 15, IC Part 15

### **Common System Specifications**

Tuning Resolution	1MHz (5MHz for EX-4.9i)
Power Control Resolution	0.5dB
Selectable Modulation Modes	Mode 1 (QPSK); Mode 2 (16QAM)
Selectable Frame Lengths (ms)	0.5, 1, 2, 2.5, 4, 5

Maximum Aggregate User Capacity

Mbps	Mode 1	Mode 2
8 / 10 MHz	13	27
16 / 20 MHz*	27	54
64MHz*	110	216

Error Floor	$10^{-12}$
Frequency Stability	$\pm 7$ ppm
Link Security	96-bit Security Code

\*Not all Bandwidth and Mode combinations are available on all radio models, and some may require specific software license keys, which may be purchased from an authorized Exalt representative.

## EX-2.4i System Specifications

Frequency Band	2400 to 2483.5MHz
Tunable Range	2406 to 2468MHz
Output Power (at full power)	+27dBm (0.5W), Mode 1 +24dBm (0.25W), Mode 2
Output Power (at minimum power)	+7dBm
Selectable Channel Bandwidths	8MHz, 16MHz, 32MHz, 64MHz*

Receiver Threshold (BER=10<sup>-6</sup>)

dBm	Mode 1	Mode 2
8MHz	-88	-80
16MHz	-85	-77
32MHz	-82	-74
64MHz*	-79	-71

Maximum RSL	Mode 1: -25dBm error-free; 0dBm no damage
Non-overlapping channels	8MHz: 8; 16MHz: 4; 32MHz: 2; 64*: 1
Regulatory Compliance	FCC 15.247; IC RSS-210, EN 300 328
FCC ID	TTM-102P40I
IC ID	6254A-102P40I

Emission Designator(s)

dBm	Mode 1	Mode 2
8MHz	10M2W7D	9M9W7D
16MHz	17M3W7D	19M0W7D
32MHz	34M7W7D	36M0W7D
64MHz*	60M7W7D	61M3W7D

\* For the EX-2.4i, a firmware option is required to enable 64MHz BW. For the EX-2.4i-16, 64MHz BW is enabled when the 16xT1/E1 license key is enabled.

## **EX-4.9i System Specifications**

Frequency Band	4940 to 4990 MHz
Tunable Range	4945 to 4985 MHz
Output Power (at full power, Mode 1)	+24dBm (20MHz BW) +22dBm (10MHz BW)
Output Power (at minimum power)	+4dBm
Selectable Channel Bandwidths	10MHz, 20MHz

Receiver Threshold (BER=10<sup>-6</sup>)

<b>dBm</b>	<b>Mode 1</b>	<b>Mode 2</b>
10MHz	-86	-78
20MHz	-83	-75*

Maximum RSL damage Mode 1: -25dBm error-free; 0dBm no

Non-overlapping channels 10MHz: 5; 20MHz: 2

Regulatory Compliance FCC Part 90; IC RSS-111

FCC ID TTM-104P90I

IC ID 6254A-104P90I

Emission Designator(s)

10MHz	10M9W7D
20MHz	21M8W7D

\*For the EX-4.9i, firmware options are required to enable Mode 2/20MHz BW.

## EX-5i System Specifications, 5.3 GHz Band

Frequency Band	5250 to 5350 MHz
Tunable Range	5260 to 5332 MHz
Output Power (at full power)	+13dBm (0.02W)
Output Power (at minimum power)	-7dBm
Selectable Channel Bandwidths	8MHz, 16MHz, 32MHz, 64MHz*
Receiver Threshold (BER=10 <sup>-6</sup> )	

dBm	Mode 1	Mode 2
8MHz	-86	-78
16MHz	-83	-75
32MHz	-80	-72
64MHz*	-77	-69

Maximum RSL	Mode 1: -25dBm error-free; 0dBm no damage
Non-overlapping channels	8MHz: 10; 16MHz: 5; 32MHz: 2; 64MHz*: 1
Regulatory Compliance	FCC 15.407; IC RSS-210; EN 301 893
FCC ID	TTM-105P25I
IC ID	6254A-105P25I

Emission Designator(s)

8MHz	8M7W7D
16MHz	17M2W7D
32MHz	34M5W7D
64MHz*	67M9W7D

\*For the EX-5i, a firmware option is required to enable 64MHz BW. For the EX-5i-16, 64MHz BW is enabled when the 16xT1/E1 license key is enabled.

## EX-5i System Specifications, 5.4 GHz Band

 **Note:** Presently this band is not enabled. This band will be enabled through a free software upgrade on regulatory approval.

Frequency Band	5470 to 5725 MHz
Tunable Range	5488 to 5715 MHz
Output Power (at full power)	+13dBm (0.02W)
Output Power (at minimum power)	-7dBm
Selectable Channel Bandwidths	8MHz, 16MHz, 32MHz*, 64MHz*

Receiver Threshold (BER=10<sup>-6</sup>)

dBm	Mode 1	Mode 2
8MHz	-86	-78
16MHz	-83	-75
32MHz	-80	-72
64MHz*	-77	-69

Maximum RSL	Mode 1: -25dBm error-free; 0dBm no damage
Non-overlapping channels	8MHz: 29; 16MHz: 14; 32MHz: 7; 64MHz*: 3
Regulatory Compliance	FCC 15.407; IC RSS-210; EN 301 893
FCC ID	TTM-105P25I
IC ID	6254A-105P25I

Emission Designator(s)

8MHz	8M7W7D
16MHz	17M2W7D
32MHz	34M5W7D
64MHz*	67M9W7D

\* For the EX-5i, a firmware option is required to enable 64MHz BW. For the EX-5i-16, 64MHz BW is enabled when the 16xT1/E1 license key is enabled.

## EX-5i System Specifications, 5.8 GHz Band

Frequency Band	5725 to 5850 MHz
Tunable Range	5731 to 5844 MHz
Output Power (at full power)	+24dBm (0.25W), Mode 1 +21dBm (0.13W), Mode 2
Output Power (at minimum power)	+4dBm
Selectable Channel Bandwidths	8MHz, 16MHz, 32MHz*, 64MHz*

Receiver Threshold (BER=10<sup>-6</sup>)

(dBm)	Mode 1	Mode 2
8MHz	-86	-78
16MHz	-83	-75
32MHz	-80	-72
64MHz*	-77	-69

Maximum RSL	Mode 1: -25dBm error-free; 0dBm no damage
Non-overlapping channels	8MHz: 15; 16MHz: 7; 32MHz: 3; 64MHz*: 1
Regulatory Compliance	FCC 15.247; IC RSS-210; EN 302 502
FCC ID	TTM-105P25I
IC ID	6254A-105P25I

Emission Designator(s)

8MHz	9M1W7D
16MHz	16M5W7D
32MHz	31M8W7D
64MHz*	61M6W7D

\* For the EX-5i, a firmware option is required to enable 64MHz BW. For the EX-5i-16, 64MHz BW is enabled when the 16xT1/E1 license key is enabled.

## **Interfaces**

### **RF**

Connector	N-type female
Impedance	50 Ohms

### **T1/E1 (x4 or x16)**

Connector	RJ-45 (RJ48C), female
T1 Impedance	100 Ohms, balanced
T1 Line Codes	AMI, B8ZS, selectable
T1 LBO Settings (in ft.)	0-133, 133-266, 266-399, 399-533, 533-655
T1 Clocking Speed	1.544 Mbps
T1 Compliance	ANSI T1.102-1987; ITU-T; G.823; GR-49T-CORE
E1 Impedance	120 Ohms, balanced
E1 Line Codes	HDB3
E1 Clocking Speed	2.048 Mbps
E1 Compliance	CEPT-1; G.703; ITU-T-G703

### **Ethernet (x2)**

Connectors	RJ-45, female, auto-MDIX
Interface Speed	10 or 100 Mbps
Duplex	Half, full, auto, selectable
Compliance	802.3

### **Console (Serial)**

Connector	9-pin sub-D, female
Interface Speed	9600 bps
Compliance	EIA-574 DTE (RS-232)

### **Alarm**

Connector	9-pin sub-D, female
Inputs	(2) TTL/Closure
Outputs	(2) Relay (Form C)



***Sync (In and Out)***

Connector RJ45, female

Signal 1 pps (GPS)

***Power***

Connector 6-pin barrier strip

Input Voltage (standard models) 20–60VDC

Consumption (standard models) <38.5W (0.8A @ 48V; 1.6A @ 24V)

Input Voltage (-16 models) 20–60VDC

Consumption (-16 models) < 45W (0.9A @ 48V; 1.8A @ 24V)

## Back-to-back Bench Testing

Use back-to-back bench testing to test the radio before installation, pre-configure the radio and connected equipment before installation, or in the troubleshooting process to identify if the radio hardware is the source of a system issue. It is a critical process, and often required or highly desirable for any installation or troubleshooting exercise. This section describes how to properly configure the radio hardware and accessories for a proper back-to-back bench test.

For radio testing, there are two types of back-to-back configurations:

1. Basic test (test general operation)
2. Specification performance verification

### **Basic Test**

The basic test is a simple test of radio functionality. It verifies that the radios are properly configured to communicate to one another, and verifies general radio performance as operational.

For the basic test, the following items are needed:

- Radio pair
- Powering source
- RF interconnect cable(s) (any length – short is best)
- Fixed or variable attenuation, between 60 and 90dB (note: attenuation for basic test does not to be calibrated or precise)
- Computer/terminal with either serial or Ethernet port (helpful, but not necessary)
  - If no computer is available, use the temporary hardware configuration key or DIP switch, depending on radio model (see [Radio A/B Configuration](#) on page 27)

Connect the items as follows:

1. Connect attenuation and (known-good) RF cable(s) between radio pair, shown in Figure 41.
2. Configure one radio as Radio A; the other as Radio B
3. Power on radio pair

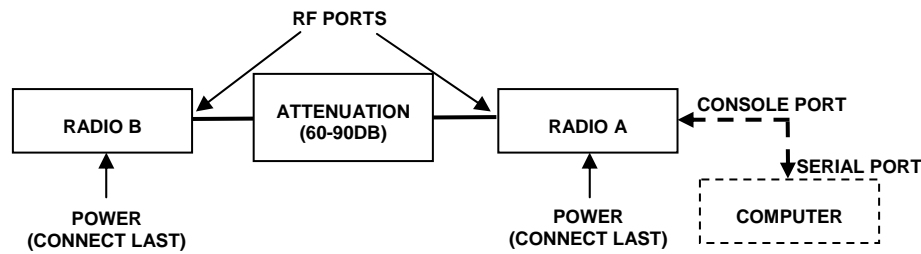

Figure 41 Basic back-to-back bench test configuration

After connecting and powering on, observe the front panel LEDs to verify that the LINK and STATUS LEDs are green. If so, the radios are communicating and all radio-related alarm conditions are normal.

It can be beneficial to have a computer to verify configuration in case of red LEDs or to pre-configure the radio as desired for operation. Follow the instructions in [Configuration and Management](#).

## Specification Performance Verification

The specification performance verification is a more detailed test that allows you to verify that the radio's output power and threshold specifications are being met. This is typically a test that would only be performed in a troubleshooting scenario, but can be performed before installation to provide a detailed record or ensure radio performance before installation.

This test is identical to the basic test, but in place of the fixed attenuation, it requires the use of calibrated variable attenuation, or a set of calibrated fixed attenuators, or a combination of both, adding to a total attenuation value of 120dB, as measured at the operating frequency of the radio. In addition, a volt meter or computer is also required.

Connect the system as shown in Figure 41, using the combination of fixed and variable attenuation between the radio's RF ports. Connect the volt meter to either radio's RSL test point and associated reference ground connection.

In this test, it is desirable to use pre-tested RF cables, known to be good, and the insertion loss is known at the operating frequency. If the cables are short (6'2m or less), you can estimate the loss, including connectors, to be less than 1dB each. The estimate of cable loss is critical to the overall confidence of the measurements made in this test.

There are two critical specifications that can be tested in this configuration:

1. RF output power
2. Radio receiver threshold

To measure transmitter output power, simply insert any value of attenuation between the radios between 60 and 90dB. Ensure that both RF output power settings are at maximum.

Use the volt meter to measure RSL in both directions. The RSL measured value should match the appropriate value according to the inserted attenuation, such as:

$$RSL = RF \text{ Output Power} - \text{cabling losses} - \text{total attenuation}$$

Verify output power by adjusting output power using the Exalt GUI (in administration mode) and evaluate the corresponding change to the RSL measurement.

For threshold testing, the key is to insert a measured amount of loss that is close to, but not exceeding the radio's specified system gain. System gain is the difference between RF output power and receiver threshold. At your selected modulation and bandwidth settings, determine the specified threshold performance, and choose a value of attenuation (including cable losses) that adds to roughly 5 to 15dB less than the system gain.

For example, for the EX-2.4i, if the threshold for your measurement is -85dBm, the output power is +27dBm, so the system gain is 112dB. Choose a value of total attenuation in the range of roughly 100–105dB. Once this attenuation is inserted, verify RSL readings as in the first step, and then, using the GUI, reduce radio output power in 1dB steps until the receiving radio (the one whose output power not being adjusted) Link LED turns from green to yellow. This indicates that threshold has been reached. At this point, verify the equation for system gain using the new output power level setting and verify that the threshold performance is meeting or exceeding the published specification.

 **Note:** Due to the variation of measurements and accuracies involved in this test, you may read a measurement that is 1dB to as much as 2dB off of the expected value. It should be of no concern unless the value is more than 3dB worse than expected.

Once threshold is verified in this direction, repeat the process in the opposite direction by adjusting RF output power of the radio at the opposite end. Return the first radio to its original power setting before adjusting the second radio.

Perform threshold measurement tests for all combinations of bandwidth and mode (modulation) being used—especially when troubleshooting. It should not be necessary to vary center frequency, as this does not have any appreciable impact on system gain performance, however, try any setting combination to gain confidence in the radio performance parameters.

## DC Coupler for Antenna Alignment

One challenge associated with an all-indoor radio construction is the alignment of the antennas. It can sometimes be challenging to place the radio near the antenna alignment personnel, and can also be challenging to run a separate set of wires for the voltmeter to be in view of the alignment personnel. If any of the conventional methods mentioned in the manual are difficult to achieve, one of the simplest methods to use is to employ the use of a DC coupling system as a temporary test configuration exclusively for the purpose of aligning the antennas.

This type of system simply couples the DC voltage associated with RSL measurement at the radio location, over the RF transmission line, up to the antenna port.



**Warning:** Remove all DC-blocked lightning arrestors in the transmission system prior to applying the DC coupler system. Failure to do so can result in electric shock and/or damage to the lightning arrestors and/or other equipment.

### Required Items

The following items are needed for the DC coupling system, per radio end (double the quantities of these items for a complete link for simultaneous use at both ends):

- 2ea DC couplers: mini-circuits ZNBT-60-1W
- 1ea BNC male-male extension cable: Pomona 2249
- 1ea BNC female-to-mini Bantam (stackable Pin-tip plugs): Pomona 3221
- 1ea BNC female-to-banana male: Pomona 5268\*
- 1ea digital volt meter

\*This type of plug is typical for most professional hand-held digital volt meters (DVMs). However, verify that your DVM can accept this type of Bantam connector. If not, a different part number or adapter may be required to connect to the DVM.

### Interconnections

Connect the items as shown in Figure 42. For the coupler installation, ensure that the DC side of the coupler is facing away from the radio and away from the antenna – towards the RF transmission line system. Using the BNC adapters and cables, attach the radio end DC coupler to the RSL port on the radio, and the antenna end DC coupler to the DVM that the antenna alignment personnel will use.

The DC voltage from the RSL port is now coupled to the transmission line system between the radio and the antenna, and is available at the antenna location. This allows the antenna alignment personnel to view the DVM output directly while adjusting the antenna.

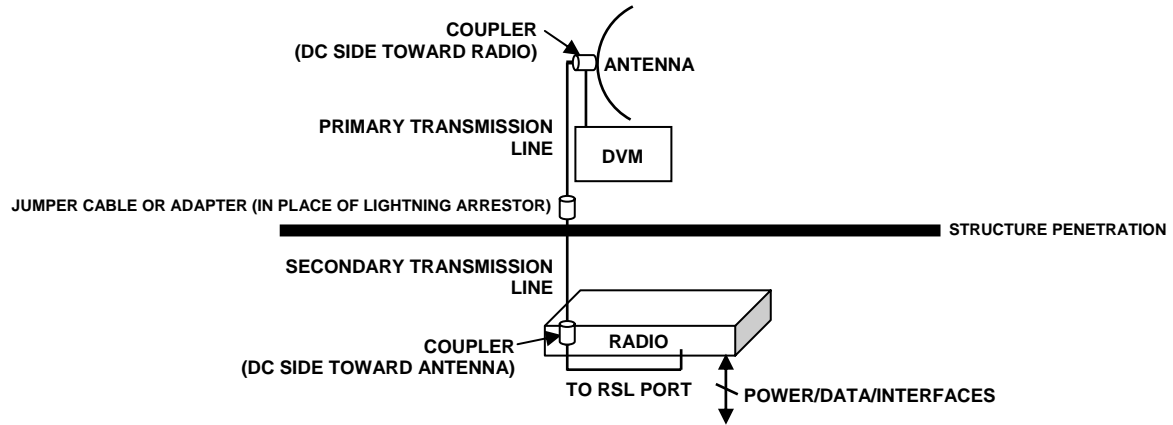

Figure 42 DC coupler interconnection

**Note:** After completing antenna alignment, remove the DC couplers and associated wiring at both radio and antenna ends.

## Interface Connections

This section provides the pin number assignment and wiring information for the connectors on the i-Series radios. All connectors are shown as viewed from the radio front panel.

### T1/E1 Connections

There are two orientations of T1/E1 connections. Depending on model, some channels have the securing tab towards the top of the connector, and others have the securing tab towards the bottom of the connector. Figure 43 illustrates the pin orientation and functionality of these connectors.

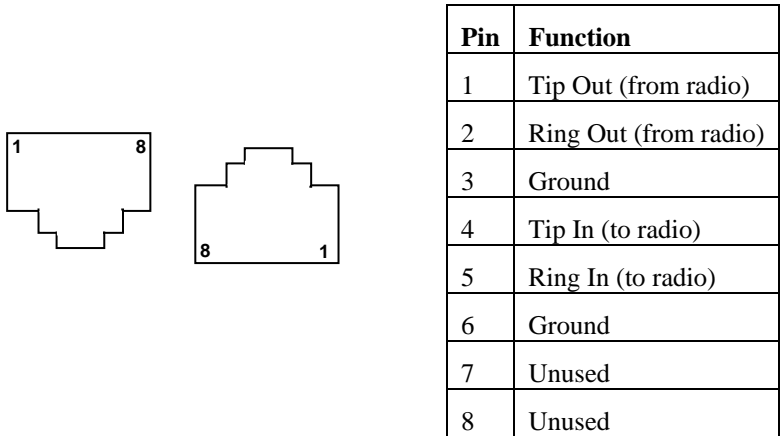

Figure 43 T1/E1 connectors

## Ethernet Connections

There are two orientations of Ethernet connections. AUX has the securing tab towards the top of the connector while MAIN has the securing tab towards the bottom of the connector. Figure 44 illustrates the pin orientation and functionality of these connectors.

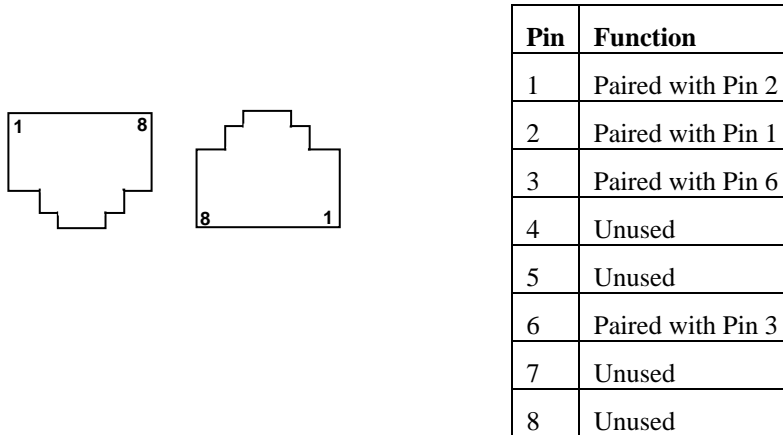

Figure 44 Ethernet connectors (MAIN and AUX)

The Ethernet connections implement Auto-MDIX, and therefore either ‘straight’ or ‘crossover’ Ethernet cables can be used, independent of the wiring of the connected device.

Depending on the settings of in-band or out-of-band NMS, both the MAIN and AUX ports can access the far-end radio (if in-band) or not (out-of-band). In the case of out-of-band setting, only the AUX port can access the GUI, while only the MAIN port carries Ethernet traffic across the link.



## Sync Connections

There are two sync connectors: Sync In and Sync Out. The Sync In connector is normally connected to a (custom) GPS antenna system, or to the Sync Out connector of a collocated radio.

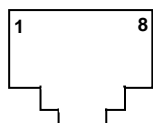

Pin	Function
1	+5V Power Out (to GPS antenna)
2	Ground
3	Tx Data (to GPS antenna)
4	Enable (to GPS antenna)
5	Rx Data (from GPS antenna)
6	1 pps Timing Signal (from GPS antenna)
7	Unused
8	Unused

Figure 45 Sync In connector



Pin	Function
1	+5V Power In (from connected radio)
2	Ground
3	Tx Data (to connected radio)
4	Unused
5	Rx Data (from connected radio)
6	1 pps Timing Signal (to connected radio)
7	Unused
8	Unused

Figure 46 Sync Out connector

For **internal sync**, pins 2 and 6 are the only required connections. Connect these pins using a straight cable. A straight cable can be used for all pin connections.

For **GPS** connections, the interconnection cable between radios must cross over pins 3 and 5, with all other pins wired straight through.

All configurations do not require connections on pins 4, 7, and 8.

## Alarm Connector

The Alarm connector provides two alarm outputs that can be connected to external alarm collection equipment. The connector also allows connection of up to two external alarm sources, where the radio will report the status of these connections through the radio network management. Output alarm connections are ‘Form C’ style connections, performing alarm logic based on either Normally Opened (NO) or Normally Closed (NC) connections compared to a Common (C) pin. Input alarm connections can be TTL logic or NO/NC style relay closures.

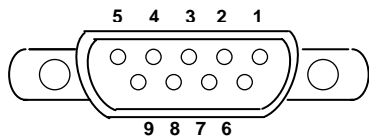

Pin	Function
1	Alarm Output 1 - NO
2	Alarm Output 1 - NC
3	Ground (for Alarm Inputs)
4	Alarm Output 2 – NO
5	Alarm Output 2 – NC
6	Alarm Output 1 – Common
7	Alarm Input 1
8	Alarm Input 2
9	Alarm Output 2 – Common

Figure 47 Alarm Connector

Alarm Output 1 is in alarm any time that there is a traffic-impacting alarm condition (Major). Alarm Output 2 is in alarm any time that there is an alarm that is not traffic-impacting (Minor).

The administrator can set the polarity of the alarm inputs.

## Console Connector

The Console connector provides a serial interface for the Command Line Interface (CLI) functions. Typically, a straight-through serial cable is used between a computer's serial port and the Console connector.

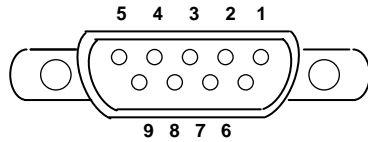

Pin	Function
1	Unused
2	Tx (from radio)
3	Rx (into radio)
4	Unused
5	Ground
6	Unused
7	Unused
8	Unused
9	Unused

Figure 48 Console Connector

## DC Power Connector

The voltage input of the DC connector is 20VDC - 60 VDC.

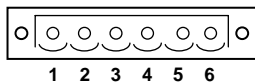

Pin	Function
1	Power Return (-)
2	Ground
3	Power (+)
4	Power (+)
5	Ground
6	Power Return (-)

Figure 49 DC Power connector

## DIP Switch Settings (-16 Models Only)

The '-16' models incorporate a front panel DIP switch. Use the DIP switch for emergency configuration or restoration for installations where there is no computer available for complete radio configuration. Only use the DIP switch for temporary purposes, for the purpose of a bench test or antenna alignment. Use the Exalt GUI for complete system configuration, as required before final system deployment.

The DIP switch is only read when the critical factory reset procedure is implemented (see [Radio A/B Configuration](#) on page 27 and [Reset to Critical Factory Settings](#) on page 44). That is, when the RMT button is pressed and held during power up, and held through the boot cycle (approximately 45 seconds, until LED behavior stabilizes). If changes are made while the radio is already powered or when power is not applied, the changes are not executed until a reset is executed.

Figure 50 depicts DIP switch positions 1 through 8, left to right, when facing the front panel. Also, the switch is considered in the 'One' position when it is toggled upward, and in the 'Zero' position when it is toggled downward (default).

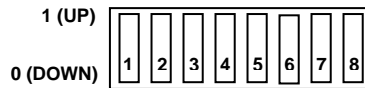

*Figure 50      DIP Switch Orientation*

Table 6 describes the function of each switch when placed in either position.

*Table 6      DIP Switch Functions*

Switch	0 (DOWN)	1 (UP)
Position 1	Ignore all DIP switch positions	If RMT button is held during boot cycle (reset to critical factory defaults procedure), reset to factory defaults, except IP address and password information, and make changes as described in this table.
Position 2	Radio B	Radio A
Position 3*	TDM circuits = T1	TDM circuits = E1
Position 4	Standard factory defaults	Standard factory defaults, except <50miles link distance and full transmit power.
Positions 5–8	Unused	Unused

Table 7 provides the standard factory defaults for the ‘-16’ models.

Table 7 Standard Factory Defaults (-16 Models)

Parameter	EX-2.4i-16	EX-5i-16
Frequency	2441 MHz	5788 MHz
Transmit Power	+7 dBm	+4dBm
Link Distance	<10 miles	
Bandwidth	8 MHz	
Mode	Mode 1	
TDD Frame Size	2ms	
Ethernet Interfaces	Enabled, 100/Full	
AUX port NMS Access	In-Band	
T1/E1 Settings	All Enabled, T1, B8ZS, AIS	

There are several scenarios for using the DIP switches. Table 8 describes common configurations and related applications.

Table 8 Common DIP Switch Applications

Application	Switch Positions	Comments
Reset all critical factory defaults	0xxxxxxx	If the IP address and/or passwords are forgotten or lost, use this setting and execute the critical reset procedure (RMT button held through boot cycle).
Reset complete factory defaults except for IP information and passwords	1x00xxxx	If the IP address and/or passwords are already reset or are known but the configuration of the radio parameters is unknown, use this setting to restore all parameters to factory defaults. Execute the critical reset procedure with these settings. If trying to establish a link, configure one radio as Radio A, the other as Radio B using position 2.
Configure the radio as Radio A while resetting.	11xxxxxx	Choose the desired reset function using position 4. Reset one radio as Radio A with position 2 up, so that a link can be established.

Change TDM interfaces to E1	1x1xxxx	Choose the desired reset function using position 4. Reset both radios with position 3 up to configure E1 at each end. One radio must be Radio B, and the other Radio A (using position 2).
Configure for ideal antenna alignment configuration	1xx1xxxx	Reset the radio with position 4 up to configure for the best setting to optimize antenna alignment. One radio must be configured as Radio A, the other as Radio B (using position 2).

## **Copyright Notices**

This section present copyright notices for third-party software licensed to Exalt Communications, Inc.

### ***Net-SNMP***

The following copyright notice applies to the open-source licensing agreement for Net-SNMP.

Copyright 1989, 1991, 1992 by Carnegie Mellon University

Derivative Work - 1996, 1998-2000

Copyright 1996, 1998-2000 The Regents of the University of California

All Rights Reserved

Permission to use, copy, modify and distribute this software and its documentation for any purpose and without fee is hereby granted, provided that the above copyright notice appears in all copies and that both that copyright notice and this permission notice appear in supporting documentation, and that the name of CMU and The Regents of the University of California not be used in advertising or publicity pertaining to distribution of the software without specific written permission.

CMU AND THE REGENTS OF THE UNIVERSITY OF CALIFORNIA DISCLAIM ALL WARRANTIES WITH REGARD TO THIS SOFTWARE, INCLUDING ALL IMPLIED WARRANTIES OF MERCHANTABILITY AND FITNESS. IN NO EVENT SHALL CMU OR THE REGENTS OF THE UNIVERSITY OF CALIFORNIA BE LIABLE FOR ANY SPECIAL, INDIRECT OR CONSEQUENTIAL DAMAGES OR ANY DAMAGES WHATSOEVER RESULTING FROM THE LOSS OF USE, DATA OR PROFITS, WHETHER IN AN ACTION OF CONTRACT, NEGLIGENCE OR OTHER TORTIOUS ACTION, ARISING OUT OF OR IN CONNECTION WITH THE USE OR PERFORMANCE OF THIS SOFTWARE.

**Network Associates Technology, Inc.**

Copyright (c) 2001-2003, Networks Associates Technology, Inc

All rights reserved.

Redistribution and use in source and binary forms, with or without modification, are permitted provided that the following conditions are met:

- \* Redistributions of source code must retain the above copyright notice, this list of conditions and the following disclaimer.
- \* Redistributions in binary form must reproduce the above copyright notice, this list of conditions and the following disclaimer in the documentation and/or other materials provided with the distribution.
- \* Neither the name of the Networks Associates Technology, Inc nor the names of its contributors may be used to endorse or promote products derived from this software without specific prior written permission.

THIS SOFTWARE IS PROVIDED BY THE COPYRIGHT HOLDERS AND CONTRIBUTORS "AS IS" AND ANY EXPRESS OR IMPLIED WARRANTIES, INCLUDING, BUT NOT LIMITED TO, THE IMPLIED WARRANTIES OF MERCHANTABILITY AND FITNESS FOR A PARTICULAR PURPOSE ARE DISCLAIMED. IN NO EVENT SHALL THE COPYRIGHT HOLDERS OR CONTRIBUTORS BE LIABLE FOR ANY DIRECT, INDIRECT, INCIDENTAL, SPECIAL, EXEMPLARY, OR CONSEQUENTIAL DAMAGES (INCLUDING, BUT NOT LIMITED TO, PROCUREMENT OF SUBSTITUTE GOODS OR SERVICES; LOSS OF USE, DATA, OR PROFITS; OR BUSINESS INTERRUPTION) HOWEVER CAUSED AND ON ANY THEORY OF LIABILITY, WHETHER IN CONTRACT, STRICT LIABILITY, OR TORT (INCLUDING NEGLIGENCE OR OTHERWISE) ARISING IN ANY WAY OUT OF THE USE OF THIS SOFTWARE, EVEN IF ADVISED OF THE POSSIBILITY OF SUCH DAMAGE.

**Cambridge Broadband, Ltd.**

Portions of this code are copyright (c) 2001-2003, Cambridge Broadband Ltd.

All rights reserved.

Redistribution and use in source and binary forms, with or without modification, are permitted provided that the following conditions are met:

- \* Redistributions of source code must retain the above copyright notice, this list of conditions and the following disclaimer.
- \* Redistributions in binary form must reproduce the above copyright notice, this list of conditions and the following disclaimer in the documentation and/or other materials provided with the distribution.
- \* The name of Cambridge Broadband Ltd. may not be used to endorse or promote products derived from this software without specific prior written permission.

THIS SOFTWARE IS PROVIDED BY THE COPYRIGHT HOLDER "AS IS" AND ANY EXPRESS OR IMPLIED WARRANTIES, INCLUDING, BUT NOT LIMITED



TO, THE IMPLIED WARRANTIES OF MERCHANTABILITY AND FITNESS FOR A PARTICULAR PURPOSE ARE DISCLAIMED. IN NO EVENT SHALL THE COPYRIGHT HOLDER BE LIABLE FOR ANY DIRECT, INDIRECT, INCIDENTAL, SPECIAL, EXEMPLARY, OR CONSEQUENTIAL DAMAGES (INCLUDING, BUT NOT LIMITED TO, PROCUREMENT OF SUBSTITUTE GOODS OR SERVICES; LOSS OF USE, DATA, OR PROFITS; OR BUSINESS INTERRUPTION) HOWEVER CAUSED AND ON ANY THEORY OF LIABILITY, WHETHER IN CONTRACT, STRICT LIABILITY, OR TORT (INCLUDING NEGLIGENCE OR OTHERWISE) ARISING IN ANY WAY OUT OF THE USE OF THIS SOFTWARE, EVEN IF ADVISED OF THE POSSIBILITY OF SUCH DAMAGE.

**Sun Microsystems, Inc.**

Copyright © 2003 Sun Microsystems, Inc., 4150 Network Circle, Santa Clara,  
California 95054, U.S.A. All rights reserved.

Use is subject to license terms below.

This distribution may include materials developed by third parties.

Sun, Sun Microsystems, the Sun logo and Solaris are trademarks or registered trademarks of Sun Microsystems, Inc. in the U.S. and other countries.

Redistribution and use in source and binary forms, with or without modification, are permitted provided that the following conditions are met:

- \* Redistributions of source code must retain the above copyright notice, this list of conditions and the following disclaimer.
- \* Redistributions in binary form must reproduce the above copyright notice, this list of conditions and the following disclaimer in the documentation and/or other materials provided with the distribution.
- \* Neither the name of the Sun Microsystems, Inc. nor the names of its contributors may be used to endorse or promote products derived from this software without specific prior written permission.

THIS SOFTWARE IS PROVIDED BY THE COPYRIGHT HOLDERS AND CONTRIBUTORS "AS IS" AND ANY EXPRESS OR IMPLIED WARRANTIES, INCLUDING, BUT NOT LIMITED TO, THE IMPLIED WARRANTIES OF MERCHANTABILITY AND FITNESS FOR A PARTICULAR PURPOSE ARE DISCLAIMED. IN NO EVENT SHALL THE COPYRIGHT HOLDERS OR CONTRIBUTORS BE LIABLE FOR ANY DIRECT, INDIRECT, INCIDENTAL, SPECIAL, EXEMPLARY, OR CONSEQUENTIAL DAMAGES (INCLUDING, BUT NOT LIMITED TO, PROCUREMENT OF SUBSTITUTE GOODS OR SERVICES; LOSS OF USE, DATA, OR PROFITS; OR BUSINESS INTERRUPTION) HOWEVER CAUSED AND ON ANY THEORY OF LIABILITY, WHETHER IN CONTRACT, STRICT LIABILITY, OR TORT (INCLUDING NEGLIGENCE OR OTHERWISE) ARISING IN ANY WAY OUT OF THE USE OF THIS SOFTWARE, EVEN IF ADVISED OF THE POSSIBILITY OF SUCH DAMAGE.

**Sparta, Inc.**

Copyright (c) 2003-2005, Sparta, Inc

All rights reserved.

Redistribution and use in source and binary forms, with or without modification, are permitted provided that the following conditions are met:

- \* Redistributions of source code must retain the above copyright notice, this list of conditions and the following disclaimer.
- \* Redistributions in binary form must reproduce the above copyright notice, this list of conditions and the following disclaimer in the documentation and/or other materials provided with the distribution.
- \* Neither the name of Sparta, Inc nor the names of its contributors may be used to endorse or promote products derived from this software without specific prior written permission.

THIS SOFTWARE IS PROVIDED BY THE COPYRIGHT HOLDERS AND CONTRIBUTORS "AS IS" AND ANY EXPRESS OR IMPLIED WARRANTIES, INCLUDING, BUT NOT LIMITED TO, THE IMPLIED WARRANTIES OF MERCHANTABILITY AND FITNESS FOR A PARTICULAR PURPOSE ARE DISCLAIMED. IN NO EVENT SHALL THE COPYRIGHT HOLDERS OR CONTRIBUTORS BE LIABLE FOR ANY DIRECT, INDIRECT, INCIDENTAL, SPECIAL, EXEMPLARY, OR CONSEQUENTIAL DAMAGES (INCLUDING, BUT NOT LIMITED TO, PROCUREMENT OF SUBSTITUTE GOODS OR SERVICES; LOSS OF USE, DATA, OR PROFITS; OR BUSINESS INTERRUPTION) HOWEVER CAUSED AND ON ANY THEORY OF LIABILITY, WHETHER IN CONTRACT, STRICT LIABILITY, OR TORT (INCLUDING NEGLIGENCE OR OTHERWISE) ARISING IN ANY WAY OUT OF THE USE OF THIS SOFTWARE, EVEN IF ADVISED OF THE POSSIBILITY OF SUCH DAMAGE.

**Cisco, Inc.**

Copyright (c) 2004, Cisco, Inc and Information Network

Center of Beijing University of Posts and Telecommunications.

All rights reserved.

Redistribution and use in source and binary forms, with or without modification, are permitted provided that the following conditions are met:

- \* Redistributions of source code must retain the above copyright notice, this list of conditions and the following disclaimer.
- \* Redistributions in binary form must reproduce the above copyright notice, this list of conditions and the following disclaimer in the documentation and/or other materials provided with the distribution.
- \* Neither the name of Cisco, Inc, Beijing University of Posts and Telecommunications, nor the names of their contributors may be used to endorse or promote products derived from this software without specific prior written permission.

THIS SOFTWARE IS PROVIDED BY THE COPYRIGHT HOLDERS AND CONTRIBUTORS "AS IS" AND ANY EXPRESS OR IMPLIED WARRANTIES, INCLUDING, BUT NOT LIMITED TO, THE IMPLIED WARRANTIES OF MERCHANTABILITY AND FITNESS FOR A PARTICULAR PURPOSE ARE DISCLAIMED. IN NO EVENT SHALL THE COPYRIGHT HOLDERS OR CONTRIBUTORS BE LIABLE FOR ANY DIRECT, INDIRECT, INCIDENTAL, SPECIAL, EXEMPLARY, OR CONSEQUENTIAL DAMAGES (INCLUDING, BUT NOT LIMITED TO, PROCUREMENT OF SUBSTITUTE GOODS OR SERVICES; LOSS OF USE, DATA, OR PROFITS; OR BUSINESS INTERRUPTION) HOWEVER CAUSED AND ON ANY THEORY OF LIABILITY, WHETHER IN CONTRACT, STRICT LIABILITY, OR TORT (INCLUDING NEGLIGENCE OR OTHERWISE) ARISING IN ANY WAY OUT OF THE USE OF THIS SOFTWARE, EVEN IF ADVISED OF THE POSSIBILITY OF SUCH DAMAGE.

**Fabasoft R&D Software GmbH & Co.**

Copyright (c) Fabasoft R&D Software GmbH & Co KG, 2003

oss@fabasoft.com

Author: Bernhard Penz

Redistribution and use in source and binary forms, with or without modification, are permitted provided that the following conditions are met:

- \* Redistributions of source code must retain the above copyright notice, this list of conditions and the following disclaimer.
- \* Redistributions in binary form must reproduce the above copyright notice, this list of conditions and the following disclaimer in the documentation and/or other materials provided with the distribution.
- \* The name of Fabasoft R&D Software GmbH & Co KG or any of its subsidiaries, brand or product names may not be used to endorse or promote products derived from this software without specific prior written permission.

THIS SOFTWARE IS PROVIDED BY THE COPYRIGHT HOLDER ``AS IS" AND ANY EXPRESS OR IMPLIED WARRANTIES, INCLUDING, BUT NOT LIMITED TO, THE IMPLIED WARRANTIES OF MERCHANTABILITY AND FITNESS FOR A PARTICULAR PURPOSE ARE DISCLAIMED. IN NO EVENT SHALL THE COPYRIGHT HOLDER BE LIABLE FOR ANY DIRECT, INDIRECT, INCIDENTAL, SPECIAL, EXEMPLARY, OR CONSEQUENTIAL DAMAGES (INCLUDING, BUT NOT LIMITED TO, PROCUREMENT OF SUBSTITUTE GOODS OR SERVICES; LOSS OF USE, DATA, OR PROFITS; OR BUSINESS INTERRUPTION) HOWEVER CAUSED AND ON ANY THEORY OF LIABILITY, WHETHER IN CONTRACT, STRICT LIABILITY, OR TORT (INCLUDING NEGLIGENCE OR OTHERWISE) ARISING IN ANY WAY OUT OF THE USE OF THIS SOFTWARE, EVEN IF ADVISED OF THE POSSIBILITY OF SUCH DAMAGE.

## Appendix A - Regulatory Compliance

As of this printing, Exalt Communications, Inc. has approvals for the products that are covered by this manual as indicated in Table 11. If your application or country is not listed, please check with your Sales Representative for the current status.

Table 9 Product Approvals

Country	EX-2.4i series	EX-4.9i series	EX-5i series, 5.3 GHz	EX-5i series, 5.4 GHz	EX-5i series, 5.8 GHz
Austria	x		x	x	x
Belgium	x			x	
Canada	x	x	x	x	x
Cyprus	x		x	x	
Czech Republic	x		x	x	x
Denmark	x		x	x	x
Estonia	x		x	x	
Finland	x		x	x	
France	x		x	x	x
Germany	x		x	x	x
Ghana	x		x	x	
Great Britain	x		x	x	x
Hungary	x		x	x	x
Iceland	x		x	x	x
Ireland	x		x	x	x
Italy	x		x	x	x
Liechtenstein	x		x	x	x
Lithuania	x		x	x	x
Luxembourg			x	x	
Malta	x				
Mexico	x		x		x
Netherlands	x		x	x	x
Norway	x		x	x	x
Poland	x		x	x	x
Portugal	x		x	x	x

Romania	x		x	x	x
Slovak Republic	x		x	x	x
Slovenia	x		x	x	
Spain			x	x	x
Sweden	x		x	x	x
Switzerland	x		x	x	x
Turkey	x		x	x	x
United States	x	x	x	x	x

## General Regulatory Notices

### ***Dynamic Frequency Selection***

Dynamic Frequency Selection (DFS) may be required by regional legislation in some frequency bands in order to avoid causing interference to radar systems. Prior to the start of any transmission, the device equipped with DFS monitors the spectrum and is not permitted to transmit on a part of the spectrum that is already in use for radar transmissions for a period of 30 minutes. During operation of the device, the spectrum is continually monitored by the DFS to detect if radar begins transmission on a frequency that is being used by the device to transmit on. If the DFS software detects radar, the device must move off channel within a specified time period so that the device transmission does not interfere with the radar transmission. The device equipped with DFS is required to stay off that part of the spectrum for a minimum of 30 minutes, after which time the device may then check the spectrum for radar transmissions and begin transmitting if no radar is detected.

### ***Antennas***

The following Tables list antennas recommended for use with the i-Series radios. The EX-4.9i may use any antenna. In some countries, antennas exceeding a certain level of gain may be unlawful. Refer to RF Output Power Setting in this Appendix for details on regulatory limits.

Table 10 EX-2.4i supported antennas

Manufacturer	Model #	Description	Mid-band Gain (dBi)	3dB (Azimuth/Elevation) Beamwidth (degrees)
Andrew	19T-2440-1	16-inch Solid Parabolic Dish	19	16/17
Andrew	21T-2441-1	24-inch Solid Parabolic Dish	21	10/11
Andrew	18T-2400-1	Semi-parabolic Grid	17	14/13
Andrew	26T-2400-1	Semi-parabolic Grid	23	7.5/10
Andrew	P2F-23	2-foot Solid Parabolic Dish	21.6	12/13.3
Andrew	P4F-23	4-foot Solid Parabolic Dish	27.3	6.9
Andrew	KP3F-23	3-foot Grid Parabolic Dish	25.1	8.1
Andrew	KP4F-23	4-foot Grid Parabolic Dish	27.5	6.9
Andrew	KPR3F-23	2-foot Grid Parabolic Dish	23.6	7.9/8.7
Andrew	KPR4F-23	4-foot Grid Parabolic Dish	27.3	6.2/6.7
Andrew	QD-2402	11-inch Panel	16	27
Gabriel	DFPS.5-23	6-inch Panel	10.3	35/53
Gabriel	DFPS1-23	1-foot Panel	16.5	36
Gabriel	P-24A36	3-foot Grid Parabolic Dish	25.7	8.4
Gabriel	P-24A48	4-foot Grid Parabolic Dish	27.7	6.5
Gabriel	SSP2-23	2-foot Solid Parabolic Dish	20.7	14.5
Gabriel	SSP4-23	4-foot Solid Parabolic Dish	26.7	7.2
Gabriel	SSP6-23	6-foot Solid Parabolic Dish	30.3	4.8
Gabriel	HSSP2-23	2-foot Solid HP Parabolic	20.5	14.5
Gabriel	HSSP4-23	4-foot Solid HP Parabolic	26.3	7.2
Gabriel	HSSP6-23	6-foot Solid HP Parabolic	30.0	4.8
RadioWaves	SP1-2.4	1-foot Solid Parabolic Dish	14	28
RadioWaves	SP2-2.4	2-foot Solid Parabolic Dish	21.3	14
RadioWaves	SP3-2.4	3-foot Solid Parabolic Dish	24.3	9.5
RadioWaves	SP4-2.4	4-foot Solid Parabolic Dish	27.2	7.3
RadioWaves	SP6-2.4	6-foot Solid Parabolic Dish	30.3	4.8
RadioWaves	G3-2.4	3-foot Grid Parabolic Dish	24.5	9.2
RadioWaves	G4-2.4	4-foot Grid Parabolic Dish	27	7.1
RadioWaves	G6-2.4	6-foot Grid Parabolic Dish	30.3	4.6
RFS	MGAR2-	2-foot Grid Parabolic Dish	20.8	13.7
RFS	MGAR3-	3-foot Grid Parabolic Dish	24.2	8.6
RFS	MGAR4-	4-foot Grid Parabolic Dish	27.2	7
RFS	SPF2-23	2-foot Solid Parabolic Dish	20.5	13.8
RFS	SPF3-23	3-foot Solid Parabolic Dish	24.2	9.2
RFS	SPF4-23	4-foot Solid Parabolic Dish	27.1	6.9

Table 11 lists antennas supported by the EX-5i family of Digital Microwave Radios.

Table 11 EX-5i supported antennas

Manufacturer	Model #	Description	Mid-band Gain dBi (mid-band)	3dB (Azimuth/Elevation) Beamwidth (degrees)
Andrew	P2F-52-N	2-foot Dish	29.4	5.4
Andrew	P3F-52-N	3-foot Dish	33.4	3.8
Andrew	P4F-52-NXA	4-foot Dish	34.9	3.0
Andrew	P6F-52-NXA	6-foot Dish	37.6	1.8
Andrew	HP2F-52-NPA	2-foot HP Dish	29.0	5.4
Andrew	HP3F-52-NPA	3-foot HP Dish	33.0	3.8
Andrew	HP4F-52-NPA	4-foot HP Dish	34.5	3.0
Andrew	HP6F-52-NPA	6-foot HP Dish	37.2	1.8
Andrew	FPA5250D06-N	6-inch Panel	18.0	19.3
Andrew	FPA5250D12-N	1-foot Panel	23.6	9.6
Gabriel	DFPS.5-52	6-inch Panel	18.0	19.0
Gabriel	DFPD1-52	1-foot Panel	23.5	9.4
Gabriel	DFPD2-52	2-foot Panel	28.0	4.6
Gabriel	QF2-52-N	2-foot Dish	28.5	5.6
Gabriel	QF2.5-52-N	2.5-foot Dish	31.2	4.4
Gabriel	QF4-52-N	4-foot Dish	34.8	2.7
Gabriel	QF6-52N	6-foot Dish	37.8	1.9
Gabriel	HQF2-52-N	2-foot HP Dish	28.2	5.7
Gabriel	HQF4-52-N	4-foot HP Dish	34.4	2.8
Gabriel	HQF6-52-N	6-foot HP Dish	37.4	1.9
MTI	MT-485001	7.5-inch Panel	19.0	18.0
MTI	MT-485002	1-foot Panel	23.0	9.0
MTI	MT-486004	18-inch Panel	26.0	6.0
MTI	MT-486001	2-foot Panel	28.0	4.5
Radio Waves	FP.5-5-18	6-inch Panel	18.0	20.0
Radio Waves	FP1-5-24	1-foot Panel	23.8	10.0
Radio Waves	FP2-5-28	2-foot Panel	28.0	4.5
Radio Waves	SP1-5.2	1-foot Dish	22.5	11.1
Radio Waves	SP2-5.2	2-foot Dish	29.0	6.1
Radio Waves	HP2-5.2	2-foot HP Dish	28.6	6.1
Radio Waves	SP3-5.2	3-foot Dish	32.0	4.0
Radio Waves	SP4-5.2	4-foot Dish	34.8	3.0
Radio Waves	SP6-5.2	6-foot Dish	37.9	2.0
RFS	SPF2-52A	2-foot Dish	27.9	6.2
RFS	SPF3-52A	3-foot Dish	31.4	4.2
RFS	SPF4-52A	4-foot Dish	33.9	3.1
RFS	SPF6-52A	6-foot Dish	37.4	2.1
RFS	SDF4-52A	4-foot HP Dish	33.9	3.1

*Exalt i-Series Installation and Management Guide*

<b>Manufacturer</b>	<b>Model #</b>	<b>Description</b>	<b>Mid-band Gain dBi (mid-band)</b>	<b>3dB (Azimuth/Elevation) Beamwidth (degrees)</b>
RFS	SDF6-52A	6-foot HP Dish	37.4	2.1
RFS	MA0528-19AN	7.5-inch Panel	19.0	18.0
RFS	MA0528-23AN	1-foot Panel	23.0	9.0
RFS	MA0528-28AN	2-foot Panel	28.0	4.5



## Region 1 Specifics

Region 1 is designated for USA and Canada installations.

**Note:** The professional installer is responsible to ensure that RF output power is properly adjusted to not exceed the regulatory limit.

### 4.9 GHz Model

The EX-4.9i is a licensed-band product operating within Part 90 of the FCC regulations and RSS-111 of Industry Canada. This band is specifically reserved for Public Safety applications and related agencies.

~~Professional installation is required, and~~ Transmitter power reduction may be required, depending on transmission system gains and losses, in accordance with instructions found in RF Output Power Setting on page 25.

The transmitter power of the device must be reduced by 1 dB for every 1 dB that the antenna gain exceeds 26 dBi (inclusive of transmission system losses).

~~In this section~~ In this Appendix you will find information about the Regulatory Compliance Regulations in your particular country.

### **Federal Communications Commission (FCC), United States**

The device is allowed to be used provided it does not cause interference to other devices. It is not guaranteed to provide protection against interference from other electronic and radio devices.

The system has been tested and found to comply with the limits of a Class B digital device, pursuant to Part 15 of the FCC Rules. These limits are designed to provide reasonable protection against harmful interference in a residential installation. This equipment generates uses and can radiate radio frequency energy and, if not installed and used in accordance with the instructions, may cause harmful interference to radio communications. However, there is no guarantee that interference will not occur in a particular installation. If this equipment does cause harmful interference to radio or television reception, which can be determined by turning the equipment off and on, the user is encouraged to try to correct the interference by one of more of the following measures:

- Reorient or relocate the receiving antenna.
- Increase the separation between the equipment and receiver.
- Connect the equipment into an outlet on a circuit different from that to which the receiver is connected.
- Consult the dealer or an experienced radio/TV technician for help.

Shielded cables and I/O cords must be used for this equipment to comply with the relevant FCC regulations.

Changes or modifications not expressly approved in writing by Exalt may void the user's authority to operate this equipment.

### **This device must be professionally installed.**

To comply with regulations, the output power of this device may need to be adjusted in accordance to the associated transmission system. See RF Output Power Setting on page 25 in this Appendix for details.

The antenna associated with EX-2.4i family shall be mounted in a location that is at least 10 feet away from humans that may be subject to long-term or continuous exposure. The antenna associated with the EX-5i family shall be mounted in a location that is at least 10'/3m away from humans that may be subject to long-term or continuous exposure.

*Important: Where required by regional regulations, DFS is enabled by the system keys and cannot be disabled.*

## **United States Compliance**

The EX-2.4i and EX-5i product families operate under FCC Rule Parts 15.247 and/or 15.407 as a license-exempt device. The EX-4.9i products operate under FCC Rule Part 90 as a licensed device. ~~All of these devices must be professionally installed.~~ They may only be used as a point-to-point transmission device for fixed or temporary-fixed (non-mobile) installations. The devices are subject to the following restrictions:

- Do not use external amplifiers to boost the power or overcome transmission system losses, unless the specific amplifier/cable/antenna combination has expressly been authorized by the FCC. The output power must never exceed +30 dBm.
- Cross-border transmissions are expressly prohibited, except with written permission from both the FCC and the governing body of the neighboring country (Cofetel for Mexico; Industry Canada for Canada).
- Use only parabolic dish antennas or directional flat-panel antennas. No other types of antennas (omni-directional, yagi, and so on) are authorized. Parabolic dishes of either grid or solid type are allowed. Maximum mid-band gain of each type of antenna certified is:
  - EX-2.4i models:
    - Parabolic dish: 30.3 dBi (6'/1.8m diameter)
    - Directional flat panel: 20.5 dBi (~2'/61cm square)
  - EX-4.9i models:
    - Parabolic dish: 26dBi (larger gains are allowed, with Tx power reduction)
    - Directional flat panel: 26 dBi (larger gains are allowed, with Tx power reduction)
  - EX-5i models:
    - Parabolic dish: 37.9 dBi (6'/1.8m diameter)

- Directional flat panel: 28 dBi (~2'/61cm square)

## **Industry Canada (IC), Canada**

This device complies with RSS-210 of Industry Canada. Operation is subject to the following two conditions:

3. this device may not cause interference, and
4. this device must accept any interference, including interference that may cause undesired operation of the device.

### **Antennas Supported in Canada**

The EX-2.4i is designed to operate with the antennas listed in Table 10, which have a maximum gain of 30.3 dBi. Antennas not included in the list or having a gain greater than 30.3dBi are prohibited for use with this device. The required antenna impedance is 50 Ohms.

The antenna associated with the EX-2.4i family shall be mounted in a location that is at least 10 feet away from humans that may be subject to long-term or continuous exposure. See Table 6 for Antenna Details.

The EX-5i family has been designed to operate with the antennas listed in Table 11 which have a maximum gain of 37.9 dBi. Antennas not included in the list or having a gain greater than 37.9 dBi are prohibited for use with this device. The required antenna impedance is 50 Ohms.

The antenna associated with the EX-5i family shall be mounted in a location that is at least 10'/3m away from humans that may be subject to long-term or continuous exposure.

*Important: Where required by regional regulations, DFS is enabled by the system keys and cannot be disabled.*

## **Canada Compliance**

The EX-2.4i and EX-5i models operate under RSS-210 of Industry Canada regulations. The EX-4.9i model operates under RSS-111 of Industry Canada regulations. Operation is subject to the following conditions, unless express permission is granted by Industry Canada to operate in a different manner:

- External amplifiers cannot be used to boost the power or to overcome transmission system losses, unless the specific amplifier/cable/antenna combination is expressly authorized by Industry Canada.
- Cross-border transmissions are expressly prohibited, except with written permission from both Industry Canada and the governing body of the neighboring country (FCC for USA)
- Only parabolic dish antennas or directional flat-panel antennas may be used. No other types of antennas (omni-directional, yagi, and so on) are authorized. Parabolic dishes of either grid or solid type are allowed. Maximum gain of each type of antenna allowed is:

- EX-2.4i models:
  - Parabolic dish: 30.3 dBi (6'/1.8m diameter)
  - Directional flat panel: 20.5 dBi (~2'/61cm square)
- EX-4.9i models:
  - Parabolic dish: 26 dBi (larger gains are allowed with Tx power reduction)
  - Directional flat panel: 26 dBi (larger gains are allowed with Tx power reduction)
- EX-5i models:
  - Parabolic dish: 37.9 dBi (6'/1.8m diameter)
  - Directional flat panel: 28 dBi (~2'/61cm square)

A complete list of allowed antennas can be found in United States Compliance

The EX-2.4i and EX-5i product families operate under FCC Rule Parts 15.247 and/or 15.407 as a license-exempt device. The EX-4.9i products operate under FCC Rule Part 90 as a licensed device. ~~All of these devices must be professionally installed.~~ They may only be used as a point-to-point transmission device for fixed or temporary-fixed (non-mobile) installations. The devices are subject to the following restrictions:

- Do not use external amplifiers to boost the power or overcome transmission system losses, unless the specific amplifier/cable/antenna combination has expressly been authorized by the FCC. The output power must never exceed +30 dBm.
- Cross-border transmissions are expressly prohibited, except with written permission from both the FCC and the governing body of the neighboring country (Cofetel for Mexico; Industry Canada for Canada).
- Use only parabolic dish antennas or directional flat-panel antennas. No other types of antennas (omni-directional, yagi, and so on) are authorized. Parabolic dishes of either grid or solid type are allowed. Maximum mid-band gain of each type of antenna certified is:
  - EX-2.4i models:
    - Parabolic dish: 30.3 dBi (6'/1.8m diameter)
    - Directional flat panel: 20.5 dBi (~2'/61cm square)
  - EX-4.9i models:
    - Parabolic dish: 26dBi (larger gains are allowed, with Tx power reduction)
    - Directional flat panel: 26 dBi (larger gains are allowed, with Tx power reduction)
  - EX-5i models:
    - Parabolic dish: 37.9 dBi (6'/1.8m diameter)
    - Directional flat panel: 28 dBi (~2'/61cm square)

Industry Canada (IC), Canada on page 128.

## EX-2.4i EIRP for the USA and Canada

For the EX-2.4i models, the maximum EIRP allowed is +52.2 dBm. The maximum conducted power of the radio is +27 dBm for Mode 1 and +24 dBm for Mode 2. The following formula is used to determine the output power:

$$P = CP - [(G-6)/3] + L$$

where:

$P$  = Maximum transmitter output Power of radio, in dBm

$CP$  = Maximum Conducted Power of transmitter power of radio, in dBm

$G$  = Specified gain of antenna, in dBi, from 2400 to 2483.5 MHz

$L$  = Total transmission system losses of all elements between the radio's RF connector and the antenna's RF connector (all cables, connectors, and lightning suppressors), in dB, as specified or measured between 2400 and 2483.5 MHz

## EX-4.9i EIRP for the USA and Canada

For the EX-4.9i model within the 4940–4990 MHz band, the maximum EIRP allowed is +50 dBm. The maximum conducted power of the radio is +24 dBm for Mode 1 and +21 dBm for Mode 2. The following formula is used to determine the output power:

$$P = CP - G + L$$

where:

$P$  = Maximum transmitter output power of radio, in dBm

$CP$  = Maximum Conducted Power of transmitter output power of radio, in dBm

$G$  = Specified gain of antenna, in dBi, from 4940 to 4990 MHz

$L$  = Total transmission system losses of all elements between the radio's RF connector and the antenna's RF connector (all cables, connectors, lightning suppressors), in dB, as specified or measured between 4940 and 4990 MHz

## EX-5i EIRP for the US and Canada

### 5250-5350 MHz Band

For the EX-5i models within the 5250–5350 MHz band, the maximum transmit power is 30 dBm. The maximum output of the radio is +13 dBm.

$$P = CP - G + L$$

where:

$P$  = Maximum transmitter output power of radio, in dBm

$CP$  = Maximum Conducted Power of transmitter output power of radio, in dBm

$G$  = Specified gain of antenna, in dBi, from 5250 to 5350 MHz

$L$  = Total transmission system losses of all elements between the radio's RF connector and the antenna's RF connector (all cables, connectors, lightning suppressors), in dB, as specified or measured between 5250 and 5350 MHz

### 5470-5725 MHz Band

For the EX-5i models within the 5470-5725 MHz band, the maximum EIRP allowed is 30 dBm. The maximum output power of the radio is +13 dBm.

$$P = CP - G + L$$

where:

$P$  = Maximum transmitter output power of radio, in dBm

$CP$  = Maximum Conducted Power of transmitter output power of radio, in dBm

$G$  = Specified gain of antenna, in dBi, from 5470 to 5725 MHz

$L$  = Total transmission system losses of all elements between the radio's RF connector and the antenna's RF connector (all cables, connectors, lightning suppressors), in dB, as specified or measured between 5470 and 5725 MHz

## **5725-5850 MHz Band**

For the EX-5i models within the 5725–5850 MHz band, the maximum EIRP allowed is 61.9 dBm. The maximum output power of the radio is +24 dBm in Mode 1 and +21 dBm in Mode 2.

$$P = CP - G + L$$

where:

$P$  = Maximum transmitter output power of radio, in dBm

$CP$  = Maximum Conducted Power of transmitter output power of radio, in dBm

$G$  = Specified gain of antenna, in dBi, from 5725 to 5850 MHz

$L$  = Total transmission system losses of all elements between the radio's RF connector and the antenna's RF connector (all cables, connectors, lightning suppressors), in dB, as specified or measured between 5725 and 5850 MHz

## Region 2 Specifics

The countries that are covered by this region are: Austria, Belgium, Cyprus, Czech Republic, Denmark, Estonia, Finland, France, Germany, Great Britain, Greece, Hungary, Iceland, Ireland, Italy, Latvia, Liechtenstein, Lithuania, Luxembourg, Malta, Norway, Poland, Portugal, Slovak Republic, Slovenia, Spain, Sweden, Netherlands, Switzerland, and Turkey.

 **Note:** The professional installer is responsible to ensure that RF output power is properly adjusted to not exceed the regulatory limit.

### **Europe/ITU (ETSI and CE Mark)**

The EX-2.4i family complies with ETS 300 328 for license-exempt use for most countries recognizing ETSI or ITU band assignments. This band is not yet harmonized for all countries recognizing ETSI or ITU band assignments. There is a +20dBm EIRP limit applied to this band. Transmitter power must be adjusted accordingly with respect to the RF cabling losses and antenna gains associated with each terminal.

The EX-5i family complies with ETS 301 893 for the 5.3 and 5.47 GHz bands for license-exempt use for most countries recognizing ETSI or ITU band assignments. This band is not yet harmonized for all countries recognizing ETSI or ITU band assignments. These bands require Dynamic Frequency Selection (DFS) and Transmitter Power Control (TPC) for radar-detection and avoidance. There is a +30dBm EIRP limit applied to this band. Transmitter power must be adjusted accordingly with respect to the RF cabling losses and antenna gains associated with each terminal.

The EX-5i family complies with ETS 302 502 for the 5.8 GHz band. This band is not yet harmonized for all countries recognizing ETSI or ITU band assignments. Consult the individual country regulations or your Exalt Communications representative for details. This band requires DFS and TPC for radar-detection and avoidance. There is a +33dBm EIRP limit for use of the 10MHz BW setting (called 8MHz on GUI), and a +36dBm EIRP limit for use of the 20MHz BW setting (called 16MHz on GUI).

All models comply with the requirements for CE Mark (EN 60950-1 and IEC 60950-1) and EMC (EN 301 489-17). No substitutions shall be made, and all wiring and grounding instructions contained in this manual must be followed to ensure safety in accordance to the standards.



### Declaration of Conformity to the R&TTE Directive 1999/5/EC

English:	This equipment is in compliance with the essential requirements and other relevant provisions of Directive 1999/5/EC.
Deutsch:	Dieses Gerät entspricht den grundlegenden Anforderungen und den weiteren entsprechenden Vorgaben der Richtlinie 1999/5/EU.
Dansk:	Dette udstyr er i overensstemmelse med de væsentlige krav og andre relevante bestemmelser i Direktiv 1999/5/EF.
Español:	Este equipo cumple con los requisitos esenciales así como con otras disposiciones de la Directiva 1999/5/EC.
ἑλληνικά:	Αόδοιο ἡ ἀπὸθεεόγιοὸ οὐκὶνὸρῖαδᾶέ ἰᾶ οὐὸ ἰὸὸεπαᾶέὸ ἀδᾶέὸρῖαέὸ εᾶέ οὐὸ εἰεὸΥὸ ᾶεᾶὸὔἰᾶέὸ ὀçὸ ἰᾶçᾶἰᾶὸ 1999/5/ΕΕ.
Français:	Cet appareil est conforme aux exigences essentielles et aux autres dispositions pertinentes de la Directive 1999/5/EC.
Íslenska:	Þessi búnaður samrýmist lögboðnum kröfum og öðrum ákvæðum tilskipunar 1999/5/ESB.
Italiano:	Questo apparato é conforme ai requisiti essenziali ed agli altri principi sanciti dalla Direttiva 1999/5/EC.
Nederlands:	Deze apparatuur voldoet aan de belangrijkste eisen en andere voorzieningen van richtlijn 1999/5/EC.
Norsk:	Dette utstyret er i samsvar med de grunnleggende krav og andre relevante bestemmelser i EU-direktiv 1999/5/EC.
Português:	Este equipamento satisfaz os requisitos essenciais e outras provisões da Directiva 1999/5/EC.
Suomalainen:	Tämä laite täyttää direktiivin 1999/5/EY oleelliset vaatimukset ja on siinä asetettujen muidenkin ehtojen mukainen.
Svenska:	Denna utrustning är i överensstämmelse med de väsentliga kraven och andra relevanta bestämmelser i Direktiv 1999/5/EC.

For 2.4 GHz radios, the following standards were applied:

- Radio: EN 300 328-1, EN 300 328-2
- EMC: EN 301 489-1, EN 301 489-17
- Safety: EN 60950, IEC 60950, IEC 60950-1

For 5 GHz radios, the following standards were applied:

- Radio: EN 301 893, EN 302 502
- EMC: EN 301 489-1, EN 301 489-17
- Safety: EN 60950, IEC 60950, IEC 60950-1

The following CE mark is affixed to the product:



## EU WEEE

Exalt is committed to meeting the requirements of the European Union's Waste Electrical and Electronic Equipment (WEEE) Directive. The Directives require producers of electrical and electronic equipment to finance the take-back for re-use or recycling of their products placed on the EU market after 13 August 2005.

Exalt products that are within the scope of the Directives are labeled with a crossed-out "wheelie-bin" symbol as required by the Directives. This indicates that the product was placed on the market after 13 August 2005 and that end-users should segregate the product from other wastes at end-of-life.

The WEEE Directives are being implemented in each of the 28 EU and European Economic Area (EAA) countries through national legislation. This has resulted in considerable variation in the detailed requirements across the EU, many of which require presence in the EU. As a result, Exalt's WEEE compliance approach is to require the distributors and/or resellers in the EU to comply with each country's national legislation by registration of the distributor or reseller as the producer and for the reseller/distributor to carry out and fulfill the legislative requirements of each national compliance scheme.

Below is the crossed out wheelie bin symbol as required by the WEEE Directive.



## EU RoHS

RoHS is the acronym used to refer to the European Union (EU) Directive 2002/95/EC on the Restriction of the use of certain hazardous substances in electrical and electronic equipment. Hazardous materials are those chemicals and substances that are legislatively, market, or customer banned or restricted for use in products and/or manufacturing. There are six (6) RoHS substances: lead (Pb), cadmium (Cd), mercury (Hg), hexavalent chromium (Cr+6), polybrominated biphenyls (PBB) and polybrominated diphenylethers (PBDE). Other countries may be introducing legislation that results in similar restrictions of hazardous substances. Many Exalt products will continue to use lead-based solder under the exemption allowed for network infrastructure equipment. Small amounts of lead, cadmium, mercury, hexavalent chromium, PBB, and PBDE can also be found in a few electrical and electrical components.

## Europe Compliance

The EX-2.4i family operates under EN 300 328 rules as a license-exempt device. The EX-4.9i devices are currently not permitted in any EU member or affiliate countries. The EX-5i family operates under EN 301 893 and EN 302 502 rules as a license-exempt device. All of these permitted devices must be professionally installed. They may only be used as a point-to-point transmission device for fixed or temporary-fixed (non-mobile) installations. The devices are subject to the following restrictions:

- Do not use external amplifiers to boost the power or overcome transmission system losses, unless the specific amplifier/cable/antenna combination has expressly been authorized by the specific country regulations. The output power must never exceed that specified in the Tables 1 and 2.

- Use only parabolic dish antennas or directional flat-panel antennas. No other types of antennas (omni-directional, yagi, and so on) are authorized. Parabolic dishes of either grid or solid type are allowed. Maximum mid-band gain of each type of antenna certified is:
  - EX-2.4i models:
    - Parabolic dish: 30.3 dBi (6'/1.8m diameter)
    - Directional flat panel: 20.5 dBi (~2'/61cm square)
  - EX-5i models:
    - Parabolic dish: 37.9 dBi (6'/1.8m diameter)
    - Directional flat panel: 28 dBi (~2'/61cm square)

## EX-2.4i EIRP by Country

For the EX-2.4i models within the 2400-2483.5 MHz band, the maximum EIRP allowed is 20 dBm and the countries are summarized in Table 12. The maximum output power of the radio is +13 dBm.

$$P = CP - G + L$$

where:

$P$  = Maximum transmitter output power of radio, in dBm

$CP$  = Maximum Conducted Power of transmitter output power of radio, in dBm

$G$  = Specified gain of antenna, in dBi, from 2400-2483.5 MHz

$L$  = Total transmission system losses of all elements between the radio's RF connector and the antenna's RF connector (all cables, connectors, lightning suppressors), in dB, as specified or measured between 2400 and 2483.5 MHz

Table 12 Region 2 Country Specific Power Levels for EX-2.4i Series

<b>Country</b>	<b>Maximum EIRP Output Power</b>
Austria	20 dBm
Belgium	20 dBm
Cyprus	20 dBm
Czech Republic	20 dBm
Denmark	20 dBm
Estonia	20 dBm
Finland	20 dBm
France	20 dBm
Germany	20 dBm
Great Britain	20 dBm
Hungary	20 dBm
Iceland	20 dBm
Ireland	20 dBm
Italy	20 dBm
Liechtenstein	20 dBm
Lithuania	20 dBm
Malta	20 dBm
Netherlands	20 dBm
Norway	20 dBm
Poland	20 dBm
Portugal	20 dBm
Romania	20 dBm
Slovak Republic	20 dBm
Slovenia	20 dBm
Sweden	20 dBm
Switzerland	20 dBm
Turkey	20 dBm

## EX-5i EIRP by Country

Table 13 summarizes the maximum power by band and country for Exalt's EX-5i series products.

### **5250–5350 MHz band**

For the EX-5i models within the 5250–5350 MHz band, the maximum transmit power is 23 dBm. The maximum output of the radio is +13 dBm.

$$P = CP - G + L$$

where:

- $P$  = Maximum transmitter output power of radio, in dBm
- $CP$  = Maximum Conducted Power of transmitter output power of radio, in dBm
- $G$  = Specified gain of antenna, in dBi, from 5250 to 5350 MHz
- $L$  = Total transmission system losses of all elements between the radio's RF connector and the antenna's RF connector (all cables, connectors, lightning suppressors), in dB, as specified or measured between 5250 and 5350 MHz

### **5470–5725 MHz band**

For the EX-5i models within the 5470-5725 MHz band, the maximum EIRP allowed is 30 dBm. The maximum output power of the radio is +13 dBm.

$$P = CP - G + L$$

where:

- $P$  = Maximum transmitter output power of radio, in dBm
- $CP$  = Maximum Conducted Power of transmitter output power of radio, in dBm
- $G$  = Specified gain of antenna, in dBi, from 5470 to 5725 MHz
- $L$  = Total transmission system losses of all elements between the radio's RF connector and the antenna's RF connector (all

cables, connectors, lightning suppressors), in dB, as specified or measured between 5470 and 5725 MHz

### **5725-5850 MHz band**

For the EX-5i models, within the 5725-5850 MHz band, the maximum transmit power with respect to specific country EIRP regulations is determined based on the channel bandwidth. The EIRP power limit is 33 dBm for 10 MHz channels and 36 dBm for 20 MHz channels. The Exalt EX-5i series maximum transmitter conducted power is +24 dBm. Use the following equation to determine the EIRP:

$$P = CP - G + L$$

where:

$P$  = Maximum transmitter output power of radio, in dBm

$CP$  = Maximum Conducted Power of transmitter output power of radio, in dBm

$G$  = Specified gain of antenna, in dBi, from 5725-5850 MHz

$L$  = Total transmission system losses of all elements between the radio's RF connector and the antenna's RF connector (all cables, connectors, lightning suppressors), in dB, as specified or measured between 5725 and 5850 MHz

Table 13 Region 2 Country Specific Power Levels for EX-5i Series

Country	Maximum EIRP Output Power, 5.3 GHz band	Maximum EIRP Output Power, 5.4 GHz band	Maximum EIRP Output Power, 5.8 GHz band
Austria	23 dBm	30 dBm	5 dBm
Belgium		30 dBm	
Cyprus	23 dBm	30 dBm	
Czech Republic	23 dBm	30 dBm	5 dBm
Denmark	23 dBm	30 dBm	33/36 dBm
Estonia	23 dBm	30 dBm	
Finland	23 dBm	30 dBm	
France	23 dBm	30 dBm	33/36 dBm
Germany	23 dBm	30 dBm	33/36 dBm
Great Britain	23 dBm	30 dBm	33/36 dBm
Hungary	23 dBm	30 dBm	33/36 dBm
Iceland	23 dBm	30 dBm	33/36 dBm
Ireland	23 dBm	30 dBm	33/36 dBm
Italy	23 dBm	30 dBm	33/36 dBm
Liechtenstein	23 dBm	30 dBm	5 dBm
Lithuania	23 dBm	30 dBm	33/36 dBm
Luxembourg	23 dBm	30 dBm	
Netherlands	23 dBm	30 dBm	33/36 dBm
Norway	23 dBm	30 dBm	33/36 dBm
Poland	23 dBm	30 dBm	33/36 dBm
Portugal	23 dBm	30 dBm	5 dBm
Romania	23 dBm	30 dBm	33/36 dBm
Slovak Republic	23 dBm	30 dBm	5 dBm
Slovenia	23 dBm	30 dBm	
Spain	23 dBm		33/36 dBm
Sweden	23 dBm	30 dBm	33/36 dBm
Switzerland	23 dBm	30 dBm	5 dBm
Turkey	23 dBm	30 dBm	33/36 dBm



# Index

## A

- AC adapter, 41, 42
- accessory kit contents, 23
- Administration Settings page, 62
- administrator privileges, 56
- AIS enabling/disabling, 69
- alarm conditions, 59
- Alarm connector, 112
- alarms, 68, 78, 83, 102
  - clearing, 83
  - Internal Fan, 78
  - Temperature, 79
- Alarms page, 78
- AMI, 69
- antennas
  - alignment, 50, 94
  - EX-2.4i
    - Canada, 129
    - US, 124
  - EX-5i
    - Canada, 129
    - US, 125
  - mounting, 18, 45
    - indoor, 48
  - mounting height, 21
  - polarization orientation, 21
  - site preparation considerations, 21
  - system grounding, 21
  - transmission line, 46
  - troubleshooting, 94
- AUTO SYNC mode, 29

## B

- B8ZS, 69
- back-to-back bench test, 24, 104
- back-to-back bench test configuration, 105
- bandwidth, 20, 21
- Bandwidth parameter, 65, 75
- battery source, 41
- BER, 85
- browsers, 54

## C

- cables
  - Ethernet (CAT5), 24
  - RF, 19, 21
  - T1/E1, 24
  - troubleshooting
    - improper RF cable termination, 92
- carrier-to-interference tolerance, 21
- center frequency, 24
- center frequency tuning, 20
- channel bandwidth, 20
- CLI, 52

- main menu, 53
- menu options, 53
- clock, 32
- configuration file, 73
- connectors
  - 40-60VDC, 38
  - Alarm, 112
  - alarms, 38
  - antenna, 38
  - console, 38
  - CONSOLE, 52, 113
  - DC, 44
  - DC Power, 113
  - Ethernet, 38, 110
  - ETHERNET MAIN/AUX, 68
  - front panel, 37
  - Ground (GND), 38
  - out-of-band, 68
  - RSL, 38
  - Sync, 38
  - Sync (In/Out), 111
  - T1/E1, 38, 109
- Console connector, 113
- console interface, 102
- CONSOLE port, 55
- contact information, 15
- Current BER field, 80
- Current RSL field, 81

## D

- data communication interface, 19
- date and time, 62
- DC connector, 44
- DC coupler, 51, 107
- DC Power connector, 113
- DC power source, 41
- Diagnostic Charts page, 85
- dimensions, 96
- DIP switch, 28
- DIP switch (-16 models only), 22, 55, 114
- documentation, related, 15
- duplex
  - 100/full-duplex, 68
- duplex settings, 68

## E

- E1 channels, 70
- E1 Interface Configuration page, 70
- effective isotropic radiated power (EIRP), 25
- encryption, 20
- Endpoint Identifier, 58, 66, 75
- Errored Seconds (ES) field, 81
- Ethernet, 21
- ETHERNET AUX port, 55
- Ethernet configuration parameters, 75
- Ethernet connectors, 110

Ethernet interface, 102  
    throughput settings, 69  
Ethernet Interface Configuration page, 68  
ETHERNET MAIN/AUX LED, 39  
Event Log page, 83  
**ExaltCalc tool**, 26, 91  
External Alarm Inputs parameter, 67  
external GPS source, 31  
external loopback modes, 71

## F

factory default settings, 44, 74  
fade margin, 21, 95  
features, 17, 20  
File Activation page, 73, 76  
File Transfer page, 73  
file transfers, 73  
files  
    activating stored, 76  
    default configuration file, 74  
frame length. *See* TDD frame  
frequency  
    center, 22

## G

gateway (default), 75  
Global Positioning System (GPS) kit, 29  
GPS sync features, 27  
grounding, 95  
GUI  
    Administration Settings page, 62  
    Alarms page, 78  
    browsers supported, 54  
    description, 54  
    Diagnostic Charts page, 85  
    E1 Interface Configuration page, 70  
    Ethernet Interface Configuration page, 68  
    Event Log page, 83  
    File Activation page, 73, 76  
    File Transfer page, 73  
    IP address (default), 54  
    log in, 55  
    login privileges, 56  
    navigation panel, 58, 60  
    Performance page, 80  
    Radio A configuration, 54  
    Radio Information page, 61  
    Reboot page, 88  
    Spectrum Analyzer page, 87  
    summary status information, 59  
    System Configuration page, 64  
    T1 Interface Configuration page, 69  
    T1/E1 Configuration page, 69

## H

hop, 23  
hub, 30

## I

interfaces  
    alarm, 102  
    Ethernet, 102  
    power, 103  
    RF, 102  
    serial console, 102  
    Sync (In/Out), 103  
    T1/E1, 102  
interference, 81  
interference profile, 21  
Internal Fan alarm, 78  
IP address, 75  
IP address conflicts, 55  
IP address subnet, 55  
IP settings, 24  
IP subnet, 52  
IP subnet mask, 75

## L

latency optimization, 20  
LED indicators  
    ETHERNET MAIN/AUX, 39  
    LINK, 39  
    RADIO A, 39  
    RMT, 40  
    STATUS, 39  
    SYNC IN, 40  
    SYNC OUT, 40  
    system status (rear panel), 40  
    T1/E1, 40  
License Key, 63  
lightning arrestor, 21  
lightning arrestors, 48  
Line Build Out (LBO), 69  
Line Code, 69  
link, 21  
    orientation, 26  
    RF link testing, 24  
    synchronization, 26  
Link Distance parameter, 67, 75  
LINK LED, 39, 59  
link margin, 95  
Link Name parameter, 75  
link parameters, 58  
Link Security Key, 62  
Link Security Key parameter, 75  
login names, 56  
login privileges, 56  
loopback, 69, 70, 71  
    external (local), 71  
    external (remote), 71  
    internal, 71

## M

master timing, 29  
Maximum RSL field, 82  
MIB files, 73

Minimum RSL field, 81  
Minimum RSL Timestamp field, 81  
Mode parameter, 65  
modes  
    AUTO SYNC, 29  
multi-link backbone, 30  
multi-link network, 31  
multipath, 92  
multipath propagation, 93  
muting, 68

## N

noise profile, 21

## O

offset timing, 31

## P

passwords, 24, 56, 75  
path obstruction, 94  
performance degradation, 91  
Performance page, 80  
ports  
    SYNC IN, 32  
    SYNC OUT, 32  
power  
    AC adapter, 42  
    DC specifications, 43  
    DC wiring, 43  
    system LEDs and, 42  
power interface, 103

## R

rack mounting  
    hardware, 35  
    temperature considerations, 35  
radio  
    default settings, 27  
    grounding, 21, 95  
    initiation tasks, 33  
    installation tasks, 33  
    maximum transmit power setting, 65  
    mounting, 21, 35  
    parameters, 24  
    rebooting, 83, 88  
    transmitter output power, 21  
Radio A, 27  
Radio A configuration, 22  
RADIO A LED, 39  
radio configuration, 22  
radio features, 20  
radio firmware files, 73  
radio frequency  
    EX-2.4i, 17  
    EX-5i, 17  
Radio Information page, 61

radio mount  
    enclosure, 18  
    connections, 19  
    indoor, 18  
    connections, 19  
Radio Name parameter, 75  
Radio Transmit Power parameter, 64  
Reboot page, 88  
received signal level (RSL). *See* RSL  
receiver threshold, 21  
receiver threshold performance, 24  
record keeping, 34  
regulatory requirements, 25  
    EX-2.4i FCC EIRP, 130, 137  
    EX-4.9i FCC EIRP, 130  
    EX-5i FCC EIRP, 132  
    USA, 128  
regulatory requirements  
    Canada, 129  
repeater, 30  
RF cable length, 19  
RF connector, 49  
RF connector termination, 41  
RF Frequency parameter, 66, 75  
RF interface, 102  
RF interference, 93  
RF lightning arrester, 48  
RF output power, 25  
RMT button, 41  
RMT LED, 40  
RSL, 25  
    current RSL readings, 81  
    diagnostics, 85  
    Maximum RSL field, 82  
    Minimum RSL Timestamp field, 81  
    monitor for performance, 92  
RSL voltage, 50

## S

security mode, 24  
serial connection settings, 52  
serial console interface, 102  
Set to E1 button, 69  
Set to T1 button, 69  
shipping box contents, 23  
site preparation, 21  
SNMP, 77  
spanning tree protocol, 68  
specifications, 96  
Spectrum Analyzer page, 87  
STATUS LED, 39  
Swap button, 73, 76  
Sync (In/Out) connectors, 111  
Sync (In/Out) interface, 103  
SYNC IN LED, 40  
SYNC OUT LED, 40  
SYNC RECIPIENT radio, 29  
SYNC SOURCE radios, 29  
synchronization, 28  
    internal, 29

- System Configuration page, 64
- system latency, 21
- system parameters
  - default settings, 44
- system performance, 80
- system reboot, 83
- system settings
  - Current BER field, 80, 81
  - Errored Seconds (ES) field, 81
  - grounding, 95
  - Maximum RSL, 82
  - Minimum RSL field, 81
  - Time Since Reset field, 82
  - Unavailable Seconds field, 81
- system specifications, 96
- system synchronization, 31

## T

- T1 Interface Configuration page, 69
- T1/E1 circuits, 69
- T1/E1 Configuration page, 69
- T1/E1 configuration parameters, 75
- T1/E1 connections, 109
- T1/E1 connectors, 109
- T1/E1 interfaces, 102
- T1/E1 LED, 40
- T1/E1 loopback, 71
- TDD factors, 25
- TDD frame length, 21, 22
- TDD frame size, 22
- TDD Frame Size parameter, 67, 75
- TDM circuit, 21
- TDM circuits, 65
- TDM interfaces, 26
- Telnet connection, 52

- temperature, 85, 96
- Temperature alarm, 79
- temporary hardware configuration key, 22, 28, 54
- testing, 104
  - back-to-back bench, 24
  - threshold, 106
  - threshold measurement, 106
- threshold measurement tests, 106
- threshold testing, 106
- time division duplex (TDD). *See* TDD frame
- Time Since Reset, 82
- timing
  - lost signal, 32
  - master timing, 29
  - offset timing, 31
  - using an external GPS source, 31
- transmission line
  - coaxial, 46
  - egress, 49
- transmitter
  - output power, 24
- transmitter output power, 21
- troubleshooting, 85, 90

## U

- Unavailable Seconds (UAS), 81
- unfaded error-free performance, 24
- Update button, 62
- user privileges, 56

## V

- voltage test, 50
- VSWR, 93

*Exalt Communications, Inc.*  
*Exalt i-Series Installation and Management Guide*



© 2007 Exalt Communications Inc.  
580 Division St. Campbell, CA 95008 USA)