

EX-i Series GigE (FDD)

Digital Microwave Radios

Installation and Management Guide



Models:

EX-5i-DS3-GigE
EX-5/ 6i-DS3-GigE
EX-6i-GigE
EX-6i-DS3-GigE
EX-6i-4DS3-GigE
EX-6i-OC3-GigE
EX-11i-GigE
EX-11i-DS3-GigE
EX-11i-4DS3-GigE
EX-11i-OC3-GigE

Legal Notice

The information contained herein is the property of Exalt Wireless, Inc. (“Exalt”) and is supplied without liability for errors or omissions. No part of this document may be reproduced, in any form, except as authorized by contract or other written permission from the owner.

Any brand names and product names included in this manual are trademarks, registered trademarks, or trade names of their respective holders.

The contents of this document are current as of the date of publication. Exalt reserves the right to change the contents without prior notice.

The publication of information in this document does not imply freedom from patent or other rights of Exalt or others.

© 2011 Exalt Wireless Inc. All rights reserved.

The Exalt logo is a trademark of Exalt Wireless, Inc.

Open-Source License Information

Per the terms of your Exalt Limited Hardware Warranty, Software License, and RMA Procedures Agreement with Exalt Wireless, Inc. and/or its subsidiaries, certain Third Party Software may be provided with and as part of the Exalt products provided to you, and any such Third Party Software files provided are governed by the terms of their separate Third Party Licenses, which licenses give you at least the license rights licensed to you in the Exalt End User Agreement and may give you additional license rights as to the Third Party Software, but only with respect to the particular Third Party Software to which the Third Party License applies.

The Exalt Products may include or be bundled with some or all of the following third party software. Copies of the copyright notices and license agreements for any or all of these may be requested by contacting Exalt support at email: support@exaltcom.com.

Open Source Code	License Agreement	Website
Embedded Linux - OS U-Boot	Boot Code. Both licensed under GPL Version 3	www.gnu.org www.sourceforge.net
Busy Box	Linux Commands. Licensed under GPL Version 2	www.gnu.org and www.busybox.net
Scew	Expat Wrapper. Licensed under LGPL Version 3	www.gnu.org
OpenSSL	SSL Web Access. Licensed under dual license	www.openssl.org
Net-SNMP	SNMP Agent. Licensed under NetSNMP (see Copyright Notices)	
Dropbear	SSH 2 Server; Expat - XML Parser; BarelyFitz – Java Script Tabifier; and Flotr – Java Script Plotting Library. All four are licensed under MIT License	www.opensource.org/licenses/mit-license.php
GoAhead Webserver	Licensed under GoAhead License Agreement	www.goahead.com

Table of Contents

Legal Notice	ii
Open-Source License Information	ii
List of Figures	vi
List of Tables	vii
About this Document	viii
Revision History	viii
Icons	viii
Introduction	1
Related Documentation and Software	1
The EX-i Series GigE (FDD) Digital Microwave Radios	1
Basic Features	4
Pre-installation Tasks	7
Link Engineering and Site Planning	7
Familiarization with the EX-i Series GigE (FDD) Radios	7
Shipping Box Contents	8
Initial Configuration and Back-to-Back Bench Test	8
RF Output Power Setting	9
Capacity Configuration	10
Radio Configuration	10
Virtual Local Area Network (VLAN)	11
Simple Network Management Protocol (SNMP)	12
System Installation and Initiation Process	13
Record Keeping	14
Installation	15
Mechanical Configuration and Mounting	15
Rack Mounting	15
Table or Rack Shelf Mounting the System	16
Radio Ports and Indicators	16
Connector Overview	16
LED Indicators	18
RMT (Remote) Button	19
Rear Panel Diplexer Orientation	20
Non-Standard Frequency Pairs	21
Antenna Connection	22
Space Diversity	22
Power	23
Terminating the RF Connector	23
DC Power	23
Reset to Critical Factory Settings	24
Antenna/Transmission System	25
Initial Antenna Mounting	25
Transmission Line from Antenna to Egress	26
RF Lightning Arrestor	27
Transmission Line from Egress to Radio	27
Antenna Alignment	28
Configuration and Management	30

Command Line Interface (CLI)	30
Telnet into the Command Line Interface (CLI)	30
Connect to the Radio in a Telnet Session	30
Telnet	30
Exalt Graphical User Interface (GUI)	31
Preparing to Connect	31
Make Connections	32
Log In	32
Login Privileges	32
Quick Start	33
Navigating the GUI	34
Summary Status Section	34
Navigation Panel	35
Radio Information Page	36
Administration Settings Page	37
NTP and Time Zone Configurations	39
Simple Network Management Protocol (SNMP) Configuration	40
SNMP v1/v2c/v3 Support Options	40
SNMP Traps	41
File Transfer Page	43
File Activation Page	46
System Configuration Page	47
Allocation Page	51
Ethernet Interface Configuration Page	52
T1/E1 Configuration Pages	54
T1 Interface Configuration Page	54
E1, DS3, and OC3 Configuration Pages	55
E1 Interface Configuration Page	55
DS3 and OC3 Interface Configuration Pages	56
Loopback	58
MHS Configuration Page	60
VLAN Configuration Page	61
Ethernet Rate Limiting Page	63
Ethernet Learning Page	64
Syslog Configuration Page	65
Ethernet Aggregation	66
Cross Connect (X Connect) Page	67
Alarms Page	68
MHS Status Page	71
Performance Page	72
ATPC Statistics Page	75
Event Log Page	76
User Throughput Page	77
Diagnostic Charts Page	79
Ethernet Utilization Page	81
PA Control Page	82
Spectrum Analyzer	83

Reboot Page	86
Manual Page	87
Specifications	88
Physical Specifications	88
Common System Specifications	88
5GHz System Specifications	89
6GHz System Specifications	90
11GHz System Specifications	91
Interfaces	92
Interface Connections	94
T1/E1 Connections	94
Ethernet Connections	95
Alarm Connector	96
Console Connector	97
DC Power Connector	98
Troubleshooting	99
General Practices	99
Typical Indications of Issues	100
Improper RF Cable Termination	101
Multipath Propagation	101
RF Interference	101
Path Obstruction	102
Misaligned Antenna	102
Faulty Antenna	102
Improper Grounding	102
Insufficient Link Margin	102
Moisture in the Transmission System	103
Back-to-back Bench Testing	104
Basic Test	104
Specification Performance Verification	105
General Compliance and Safety	107
Safety Notices	108
Regulatory Notices	109
United States Compliance	109
Federal Communications Commission (FCC), United States	109
Canada Compliance	110
Industry Canada (IC), Canada (for 5GHz models)	110
Antennas Supported in Canada	110
Regulatory Compliance	111
EIRP Limits for the United States and Canada	112
5725–5850 MHz Band	112
Licensing 6 and 11GHz Models	113
United States	113
Canada	113
Antennas 5GHz Models	114
Copyright Notices	116
END USER AGREEMENT	120

Index 125

List of Figures

Figure 1 EX-6i-DS3-GigE Digital Microwave Radio 1
Figure 2 Indoor mount interconnection 5
Figure 3 Enclosure mount interconnection 5
Figure 4 Radio installation tasks 13
Figure 5 Front flush mount configuration 15
Figure 6 Front projection mount configuration 15
Figure 7 Rear flush mount configuration 16
Figure 8 Rear projection mount configuration 16
Figure 9 Primary front panel connectors 17
Figure 10 DS3 connectors and grounding switches 18
Figure 11 Rear panel without diplexers 20
Figure 12 Diplexer labeling 20
Figure 13 Diplexer orientation for a typical 'link' of radios 21
Figure 14 Typical Space Diversity diplexer configuration 22
Figure 15 DC connectors 24
Figure 16 CLI root menu 31
Figure 17 Initiating the browser connection 32
Figure 18 Browser Login screen 32
Figure 19 Radio Information page 33
Figure 20 Exalt GUI window description 34
Figure 21 Summary status information 35
Figure 22 Radio Information page 36
Figure 23 Administration Settings page 37
Figure 24 NTP and Time Zone Configurations page 39
Figure 25 SNMP Configuration page 40
Figure 26 Trap Configuration page 41
Figure 27 File Transfer page 43
Figure 28 File Transfer page—download file link 44
Figure 29 File Activation page 46
Figure 30 System Configuration page 47
Figure 31 Allocation page 51
Figure 32 Ethernet Interface Configuration page 52
Figure 33 T1 Interface Configuration page 55
Figure 34 E1 Interface Configuration page 56
Figure 35 DS3 Interface Configuration page 57
Figure 36 OC3 Configuration page 58
Figure 37 External (remote) loopback 59
Figure 38 External (local) loopback 59
Figure 39 MHS Configuration page 60
Figure 40 VLAN Configuration page 61
Figure 41 Ethernet Rate Limiting page 63
Figure 42 Ethernet Learning page 64
Figure 43 Syslog Configuration page 65
Figure 44 Ethernet Aggregation page 66

Figure 45 Cross Connect (X Connect) page.....	67
Figure 46 Alarms page.....	68
Figure 47 MHS Status page.....	71
Figure 48 Performance page.....	72
Figure 49 Performance page with ACM statistics.....	74
Figure 50 ATPC Statistics page.....	75
Figure 51 Event Log page.....	76
Figure 52 User Throughput page.....	77
Figure 53 User Throughput Help page.....	78
Figure 54 Diagnostic Charts page.....	79
Figure 55 Ethernet Utilization page.....	81
Figure 56 PA Control page.....	82
Figure 57 Spectrum Analyzer page.....	83
Figure 58 Spectrum analyzer graph example.....	84
Figure 59 Reboot page.....	86
Figure 60 Manual page.....	87
Figure 61 T1/E1 connectors.....	94
Figure 62 Ethernet connectors (ETH1 and ETH2).....	95
Figure 63 Alarm Connector.....	96
Figure 64 Console Connector.....	97
Figure 65 DC Power connector.....	98
Figure 66 Basic back-to-back bench test configuration.....	104

List of Tables

Table 1	Factory default settings.....	11
Table 2	Front Panel Connectors.....	17
Table 3	LED indicators.....	18
Table 4	Default login information.....	33
Table 5	Alarm status indicators.....	68
Table 6	Additional alarm status indicators.....	70
Table 7	Supported 5GHz antennas.....	114

About this Document

This manual provides a complete description of the EX-i Series GigE (FDD) family of Exalt Digital Microwave Radios and related software. This manual provides planners, engineers, installers, system administrators, and technicians general and specific information related to the planning, installation, operation, management, and maintenance of these devices.

Revision History

Date	Products and Release code
2008-12-23	EX-6i-DS3-GigE initial release (firmware version 1.0.0)
2009-05-04	EX-6i-DS3-GigE release 1.1.0
2009-12-15	EX-11i-DS3-GigE, and preliminary 4xDS3 and OC3 releases (firmware version 1.2)
2011-07-22	EX-11i-DS3-GigE includes Adaptive Coded Modulation (ACM), TDM, channel allocation, cross-connect, MHS, spectrum analyzer, capacity aggregation, and other related features for firmware version 2.0.0. EX-6i-DS3-GigE includes syslog, network time protocol (NTP), and secure shell for firmware version 1.3.4.
2011-08-29	Added models EX-5i-DS3-GigE and EX-5/6i-DS3-GigE
2011-11-01	Added models EX-6i-GigE and EX-11i-GigE
2015-10-23	Updated to include current contact information.
2016-05-26	Updated to include current contact information and information on FCC Class II Permissive Changes.

Icons

The following icons denote specific types of information:



Note: This symbol means take note. Notes contain helpful suggestions or references to materials not contained in the manual.



Warning! This symbol means there is a risk of electric shock or bodily injury. Before working on any equipment, be aware of the hazards involved with electrical circuitry and be familiar with standard practices for preventing accidents.



Caution! This symbol means be careful. There is a risk of doing something that might result in equipment damage or loss of data. This is a general warning, caution, or risk of danger.

Introduction

Exalt Wireless, Inc. thanks you for your purchase. Our goal is to build the highest quality, highest reliability digital microwave radio products. This commitment to quality and reliability extends to our employees and partners alike. We appreciate any comments on how we can improve our products, as well as your sales and Customer Care experience.

Customer Care Hotline (USA):	(408) 740-3622
Toll-Free Customer Care Hotline (USA):	(844) EXALT-01 (392-5801)
Website:	www.exaltcom.com
Sales e-mail:	sales@exaltcom.com
Customer Care e-mail:	support@exaltcom.com
Mailing Address:	Exalt Wireless, Inc. 530 Division Street Campbell, CA 95008 USA

Related Documentation and Software

This manual makes reference to other documentation and software files that may be necessary. Any document or software mentioned in this manual can be found at:

<http://login.exaltcom.com>

Create an account to gain access to documents and software.

The EX-i Series GigE (FDD) Digital Microwave Radios

The Exalt EX-i Series GigE (FDD) Digital Microwave Radios are the most advanced carrier-class point-to-point terrestrial radio communications devices operating in the 5725 to 5850 MHz, 5925 to 6425 MHz, and 6525 to 6875 MHz frequency bands. Figure 1 shows the EX-6i-DS3-GigE Digital Microwave Radio.



Figure 1 EX-6i-DS3-GigE Digital Microwave Radio

The EX-i Series GigE (FDD) radios connect voice and/or digital data from one location to another, obviating the need for copper or fiber connectivity, or enhancing existing connectivity by providing a redundancy solution, a primary solution, and/or additional capacity.

The following models of radios are covered in this manual:

- **EX-5i-DS3-GigE configured with 20Mbps full-duplex Ethernet and these available options:**

- license key upgrades for 62Mbps, 166Mbps, and 187Mbps full-duplex
- license key upgrades for 4xT1, 8xT1, 12xT1, 16xT1 and/or 1xDS3
- license key upgrades for 128- or 256-bit AES encryption
- license key upgrades for enabling the diversity receiver (1.5+0 models)
- **EX-5i/6i-DS3-GigE configured with 20Mbps full-duplex Ethernet and these available options:**
 - license key upgrade for 62Mbps, 166 Mbps, and 187Mbps full-duplex
 - license key upgrades for 4xT1, 8xT1, 12xT1, 16xT1 and/or 1xDS3
 - license key upgrades for 128- or 256-bit AES encryption
 - license key upgrades for Lower-6GHz band operation
 - license key upgrades for enabling the diversity receiver (1.5+0 models)
 - license key upgrades for High-power Tx (6GHz band option only)
- **EX-6i-GigE configured with 20Mbps full-duplex Ethernet and these available options:**
 - license key upgrade for 62Mbps, 166 Mbps, and 187Mbps full-duplex
 - license key upgrade for 4xT1
 - license key upgrades for 128- or 256-bit AES encryption
 - license key upgrade for High-power Tx
 - license key upgrade for enabling the diversity receiver (1.5+0 models)
- **EX-6i-DS3-GigE configured with 20Mbps full-duplex Ethernet and these available options:**
 - license key upgrade for 62Mbps, 166 Mbps, and 187Mbps full-duplex
 - license key upgrades for 4xT1, 8xT1, 12xT1, 16xT1 and/or 1xDS3
 - license key upgrades for 128- or 256-bit AES encryption
 - license key upgrade for High-power Tx
 - license key upgrades for enabling the diversity receiver (1.5+0 models)
- **EX-6i-4DS3-GigE configured with 166Mbps, 1xDS3, and these available options:**
 - license key upgrade for 187Mbps full-duplex
 - license key upgrades for 4xT1 and/or 2xDS3, and 3xDS3 and/or 4xDS3
 - license key upgrades for 128- or 256-bit AES encryption
 - license key upgrade for High-power Tx
 - license key upgrades for enabling the diversity receiver (1.5+0 models)
- **EX-6i-OC3-GigE configured with 166Mbps, 1xOC3, and these available options:**
 - license key upgrade for 187Mbps full-duplex
 - license key upgrades for 4xT1
 - license key upgrades for 128- or 256-bit AES encryption
 - license key upgrade for High-power Tx

- license key upgrades for enabling the diversity receiver (1.5+0 models)
- **EX-11i-GigE configured with 45Mbps full-duplex Ethernet and these available options:**
 - license key upgrade for 166Mbps and 252Mbps full-duplex
 - license key upgrade for 4xT1
 - license key upgrades for 128- or 256-bit AES encryption
 - license key upgrade for enabling the diversity receiver (1.5+0 models)
- **EX-11i-DS3-GigE configured with 45Mbps full-duplex Ethernet and these available options:**
 - license key upgrades for 166Mbps and 252Mbps full-duplex
 - license key upgrades for 4xT1, 8xT1, 12xT1, 16xT1 and/or 1xDS3
 - license key upgrades for 128- or 256-bit AES encryption
 - license key upgrades for enabling the diversity receiver (1.5+0 models)
- **EX-11i-4DS3-GigE configured with 166Mbps, 1xDS3, and these available options:**
 - license key upgrades for 252Mbps full-duplex
 - license key upgrades for 4xT1 and/or 2xDS3, and 3xDS3 and/or 4xDS3
 - license key upgrades for 128- or 256-bit AES encryption
 - license key upgrades for enabling the diversity receiver (1.5+0 models)
- **EX-11i-OC3-GigE configured with 166Mbps, 1xOC3, and these available options:**
 - license key upgrades for 252Mbps full-duplex
 - license key upgrades for 4xT1
 - license key upgrades for 128- or 256-bit AES encryption
 - license key upgrades for enabling the diversity receiver (1.5+0 models)

The EX-i Series GigE (FDD) models require a clear line-of-sight and proper path clearance to achieve a high-performance, reliable connection. Perform professional path engineering and site planning *before* installing this equipment.

The primary focus of this document is the installation and maintenance of the digital microwave radio, and assumes that path engineering and site planning were already performed.

The EX-5i and EX-5/6i models utilize radio frequencies in the range of 5725 to 5850 MHz. In most countries these frequency bands are considered ‘license-exempt’ or ‘unlicensed.’ This means that any user may use these frequencies without paying for access or providing prenotification, post-notification or registration. As a result of this designation, users can move or change these systems at any time with significant flexibility to location, orientation, and system configuration. However, also due to this designation there may be uncontrolled interference from other similar devices occupying this spectrum. For these cases, it is up to engineering and maintenance personnel to design the system with consideration of existing and future interference sources, recognizing the chance that interference conditions can be very dynamic and outages may occur on the system as a result—in some very rare cases the system may cause interference to another system and may be required to be disengaged or modified/reoriented to eliminate interference.

If this spectrum is designated license-exempt or similar in your country, it does not infer that the installer can configure the system in any manner at any location. Most often there are regulations or

device-based conditions to limit the use of devices such as maximum gain antennas or other antenna types, and maximum output power. Also in some cases, there may be application limits, limited geography of use, or other unique regulations.

The link design engineer and/or professional installer must determine what limitations exist and engineer and install the system within the confines of all local regulations. It is required that you examine all regulations that may apply to peripheral equipment, installation and cabling of the system as regulated for human safety, electrical code, air-traffic control, and all safety-related categories.

In certain countries, the spectrum for these products is not considered license-exempt. There may be additional regulatory requirements concerning location, frequency, power, orientation, configuration, and other aspects of the system, including link registration requirements, coordination, and system usage fees. Consult your local regulatory organization(s) to determine usage requirements.

The EX-5/6i and EX-6i models utilize radio frequencies in the range of 5925 to 6425 and 6525 to 6875MHz. The EX-11i models utilize radio frequencies in the range of 10700 to 11700 MHz. In most countries these frequency bands are considered as *licensed*. This means that some form of frequency coordination and/or licensing/registration is necessary for the legal use of the product. There may be limitations on classifications/types/sizes of antennas, effective isotropic radiated power (EIRP), specific frequency pairs, antenna polarization, and other aspects of the link.



Note: The link design engineer and/or professional installer must determine the legal requirements and limitations and engineer/install the system within the confines of all local regulations.

Also, it is required that any regulations that may apply to peripheral equipment, installation, and cabling of the system that may be regulated for human safety, electrical code, air-traffic control, and other safety-related categories be examined and complied with.

In almost all cases, the product itself must be authorized for use in your country. Either Exalt or Exalt's agent must have applied for certification or authorization to allow the sale and deployment of the system within the country. It is also possible that only certain versions or configurations of the device are allowed within a particular country. Please contact Exalt or your authorized Exalt representative for information pertaining to your country.



Note: It is the professional installer's responsibility to ensure that the radio system is implemented in a legal fashion. Exalt is not liable for any unsafe or illegal installations.

In most cases, there are regulations, or device-based conditions that limit the use of the device, such as minimum or maximum gain antenna, antenna polarization, and maximum output power, as well as, in some cases, application limits, limited geography of use, and other unique regulations. **The link design engineer and/or professional installer must determine these limitations and engineer/install the system within the confines of all local regulations.** Also, it is required to examine any regulations that may apply to peripheral equipment, installation and cabling of the system that may be regulated for human safety, electrical code, air-traffic control, and other safety-related categories. In some cases, a need for link registration, coordination, and fees that may apply to the system usage. Please consult your local regulatory organization(s) to determine usage requirements.

Basic Features

The EX-i Series GigE (FDD) Digital Microwave Radios are single integrated units intended for all-indoor or enclosure-based mounting. The associated antenna is typically mounted on a tower or rooftop mast structure with RF cabling running from the antenna location, with an egress through the structure or enclosure, with proper lightning suppression and grounding, to the RF connector of the

radio. In turn, the communications interfaces and power connections are directly applied to the radio, or in some cases, also with an egress through the structure or radio enclosure with proper lightning or surge-suppression devices and associated grounding.

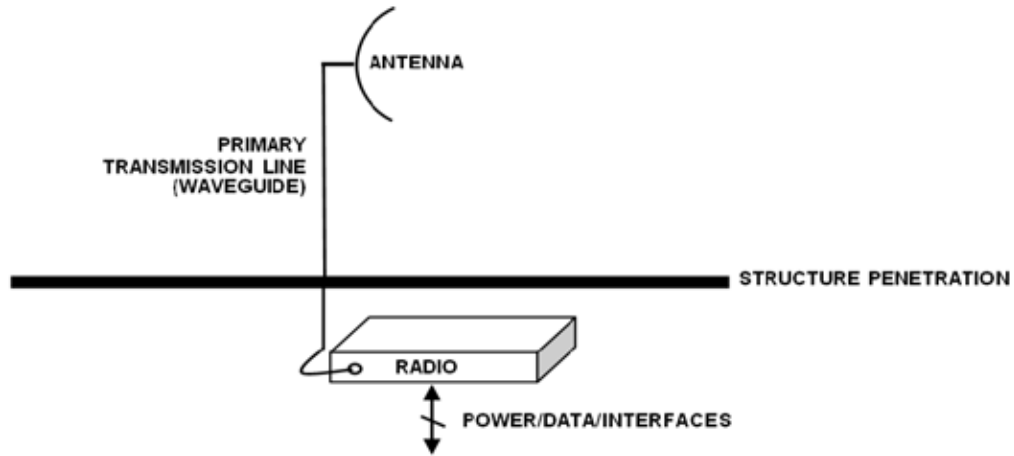

Figure 2 Indoor mount interconnection

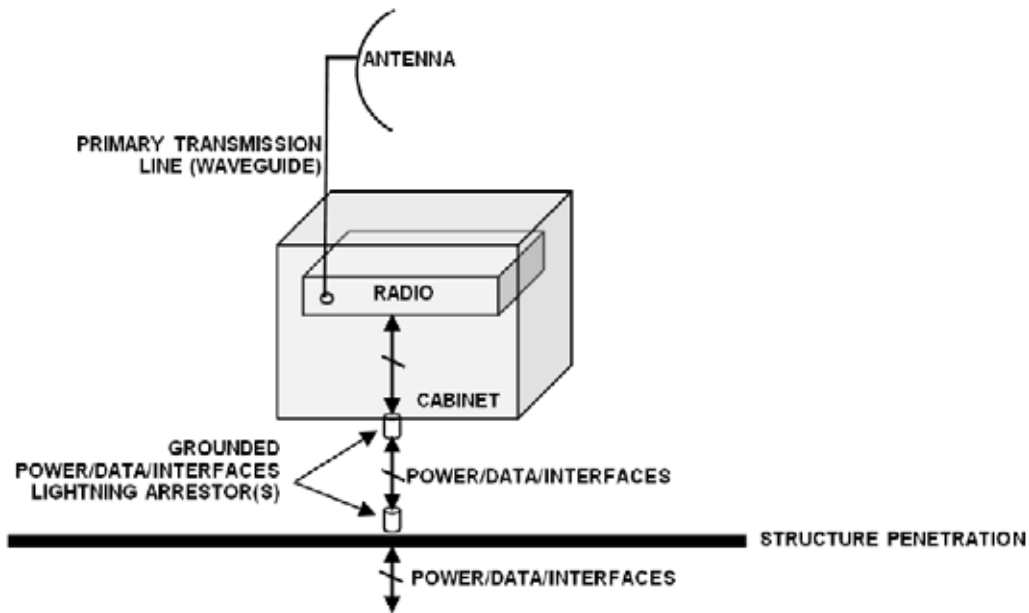

Figure 3 Enclosure mount interconnection

For highest performance and reliability, it is advised to minimize the length of RF transmission line and other associated transmission system losses between the antenna and the radio's antenna port.

Depending on model, combinations of the following data communication interfaces are provided:

- 10/100/1000Base Ethernet (Copper or Fiber)
- T1/E1/DS3/OC3 interfaces for synchronous voice traffic (number of TDM interfaces is determined by specific model and license-key configuration)

The i-Series radios feature a wide-mouth direct DC connection (24V or 48V).

All models provide the following primary features and benefits:

- Low-latency optimization and control for voice and data connections
- Very high throughput and flexible interface configurations with voice+data combinations
- Encryption for extreme wireless security
- Easy-to-use management and configuration
- Software-controlled channel bandwidth
- Software-controlled center frequency tuning for easier frequency coordination

Pre-installation Tasks

This section describes the steps necessary to prepare a site for the installation of the Exalt Digital Microwave Radio.

Link Engineering and Site Planning

The reader is referred to the Exalt document, *Guidance for Engineering and Site Planning of Terrestrial Wireless Links* and the ExaltCalc path calculator. This document and calculator aid in the pre-planning and engineering required to determine following attributes:

- Antenna type/gain at each end of the link
- Antenna mounting height/location for proper path clearance
- Antenna polarization orientation
- RF cabling type, length, connectors, route, and mounting
- Antenna system grounding
- Lightning arrestor type(s), location(s), and grounding
- Radio mounting location and mechanisms
- Radio grounding
- Radio transmitter output power setting
- Anticipated received signal level (RSL) at each end
- Anticipated fade margin and availability performance at each end
- Radio settings for modulation and occupied bandwidth
- Anticipated throughput performance (TDM circuit support and Ethernet)

With respect to radio path and site planning, these radios are generally identical to other microwave terrestrial wireless systems. Engineering of these systems requires specific knowledge about the radios, including:

- RF specifications (transmitter output power, receiver threshold, occupied channel bandwidth, and carrier-to-interference tolerance)
- Regulatory limitations on transmitter output power setting and antenna type/gain
- Noise/interference profile for the intended location (where applicable)

Familiarization with the EX-i Series GigE (FDD) Radios

The EX-i Series GigE (FDD) radios utilize frequency division duplex (FDD) radio transmission. This means that the signal transmits on one center frequency in one direction frequency, and in the opposite direction on a different center frequency. These frequencies are typically in predefined pairs, and are designated as ‘Low’ or ‘Lo’ for the radio transmitting on the lowest frequency, and ‘High’ or ‘Hi’ for the radio transmitting on the highest frequency.

The two radio terminals are identical hardware, except for the configuration of externally-mounted diplexer filters on the rear panel. Both ends of a link use the same type of diplexer filter, but the diplexer filter is inverted with respect to how it is physically installed on the radio. Once the diplexers are connected on the radio terminals, the radio must be configured (through the browser-based GUI or

through Telnet/CLI) to match the installed diplexer configuration. Additional information on this configuration can be found in [Rear Panel Diplexer Orientation](#) and [System Configuration Page](#).

Exalt recommends using the Exalt GUI for radio configuration. This interface requires a computer with an Ethernet port and web browser software, such as Microsoft Internet Explorer 5.0 or above. See [Configuration and Management](#) for details on how to connect to and use the browser-based GUI interface.

Shipping Box Contents

The radios are shipped as single terminals. Two terminals make up a *hop*, or link pair. An outer box has labeling that indicates the contents of the box, with the part number and serial number details for the radio terminals. The terminal box contains the following items:

- Radio terminal
- Accessory kit
 - Rack mount brackets
 - Bracket mounting hardware (8 x M4 screws; 8 x M4 wave washers)
 - DC power connectors (2)
 - Grounding hardware (1 x M5 screw; 1 x M5 wave washer; 2 x M5 flat washers)
- Registration card
- Quick-start guide

Each terminal requires a diplexer filter kit (sold separately) to operate. The diplexer filter kit contains the following items:

- Semi-rigid SMA cables for connecting the diplexer filter to the radio terminal
- Mounting hardware
- One 18" flexible SMA-to-N (F) cable for connection to a waveguide adapter (if applicable)

Exalt also sells the following item(s) separately:

- N-to-CPR-137 waveguide flange adapters to connect to the primary waveguide (6GHz)
- N-to-CPR-90 waveguide flange adapters to connect to the primary waveguide (11GHz)
- Additional diplexers for redundant and other applications.

Inspect the outer packaging and the contents of the boxes upon receipt. If you suspect any shipping damage or issues with the contents, contact Exalt Customer Care (see [Introduction](#)).



Note: Register your system as soon as possible. A 2-year Warranty period applies to products registered within 90 days of purchase. The Warranty period is reduced to 1-year for unregistered products and products registered after the first 90 days. See [END USER AGREEMENT](#).

Initial Configuration and Back-to-Back Bench Test

Every Exalt digital microwave radio goes through extensive quality testing and performance evaluation over the full operating temperature range prior to shipment. However, before installation, it is strongly advised to perform several tests and tasks that are much more difficult to perform once the

radio link endpoints are distant from one another. A back-to-back bench test and pre-configuration will provide confidence that the radio link is operational and properly configured *prior* to installation, so that if troubleshooting is necessary, the radio hardware and configuration settings are eliminated from the troubleshooting process. Verify the following in the back-to-back testing:

- Confirm that the radio system is generally operational
 - Radios power-up with planned power and wiring solutions
 - RF link connects in both directions
 - Traffic passes across the link
- Configure connected equipment and cabling
 - Test Ethernet (CAT5) cabling, and/or TDM cabling, any auxiliary connector cabling and configure all interfaces
 - Configure IP settings for configuration and management
 - Configure passwords and security modes
 - Become familiar with the configuration and management interfaces through the Exalt GUI interface
 - Configure radio parameters, including installing any optional software license keys and configuring features controlled by license keys
 - Set transmitter output power to engineered or allowed level (see [RF Output Power Setting](#))
 - Set operating center frequency
 - Set occupied channel bandwidth and Mode (modulation) setting
- Make detailed radio performance measurements
 - Measure transmitter output power
 - Measure receiver threshold performance
 - Confirm unfaded error-free performance

Some of these tasks may not be possible or practical within a bench test environment due to the nature of the remote connectivity of peripheral equipment. However, it is good practice to perform as much as possible in this environment to minimize field/installation time and troubleshooting efforts.

Detailed performance measurements are usually not required for pre-installation, but can be easily performed at this stage and may be helpful for later troubleshooting efforts or for internal records. During troubleshooting, there may often be a point at which a back-to-back bench test should be performed to verify many or all of the above items, and in the case of a suspected faulty device, to help confirm the fault and determine which end of the system is at fault and in need of repair or replacement.



Note: See [Back-to-back Bench Testing](#) for detailed instructions.

RF Output Power Setting

The maximum RF output power is bounded by one of the following criteria:

- Maximum RF output power setting capability of the radio device

- Maximum RF output power allowed/authorized by the local government regulations and for this specific device
- Maximum effective isotropic radiated power (EIRP) of the transmission system allowed/authorized by the local government regulations and for this specific device
- Desired RSL to not exceed the maximum RSL allowed by the device
- Desired RSL to minimize/eliminate interference into neighboring systems



Note: In many cases the radio must be pre-configured for a value not greater than the legal maximum output power before connecting to the antenna and transmission system. Instructions for adjusting the output power can also be found in [Power](#).

Capacity Configuration

The EX-i Series GigE (FDD) radios are very dynamic, allowing the installer to optimize and control the performance of the radio system for the intended application. The following parameters must be carefully determined during the link engineering phase:

- Bandwidth
- Mode (modulation)

The setting of the above parameters determines the following performance factors:

- Number of supported T1/E1/DS3/OC3 channels
- Ethernet throughput

Use a professional path-planning tool to determine optimum settings for the above parameters to meet the needs of your application.

The following generalizations can be made with regards to these factors:

- The higher the bandwidth, the higher the capacity
- The higher the mode, the higher the capacity



Note: Disable all TDM ports if there are no TDM interfaces connected. This shifts all available throughput to the Ethernet interface.



Note: If a selected combination of the Bandwidth and Mode (modulation) parameters cannot support all the desired TDM ports, the ports that cannot be supported are automatically disabled. Priority is placed on the lowest port number. That is, the first port to be disabled, if necessary, is the highest port. See [Cross Connect \(X Connect\) Page](#) for more information.

Radio Configuration

Use the Exalt GUI to configure the radio terminals for diplexer filter configuration. Since many other parameters also need to be set, and the Exalt GUI is needed for these configurations, this is the best way to completely configure the radio terminals.

Radios arrive from manufacture in default configuration configured as shown in Table 1.

Table 1 Factory default settings

Parameter	EX-i Series GigE (FDD)
Frequency	Lowest frequency pair supported by software-configured diplexer
Transmit Power	Lowest setting for the defined terminal
Bandwidth	Lowest setting for the defined terminal
Mode (modulation)	Lowest setting for the defined terminal
Link Security Key	000000000000
Administration Password	password
User Password	password
IP Address	10.0.0.1
IP Mask	255.0.0.0
IP Gateway	0.0.0.0
Ethernet Interfaces	Enabled, Auto-negotiate 10/100/1000
NMS Access	All Ethernet interfaces
T1/E1/DS3/OC3 Settings	All Disabled



Note: In many cases, the system design will not be identical to the factory default configuration, and in some cases, these differences prohibit the installation of the radio. If at all possible, obtain a computer and configure the radio terminals using the browser-based GUI. See [Exalt Graphical User Interface \(GUI\)](#).

Virtual Local Area Network (VLAN)

VLAN segments information in a single connection and creates multiple separate connections to secure information of one type or for one set of users from other information types or for other sets of users. Exalt's VLAN communications implementation adheres to the IEEE standard 802.1q.

In most cases, an Exalt radio acting as a Layer 2 bridge between two locations is only required to pass traffic with VLAN tagging. Without additional configuration, all Exalt radios support frame sizes in excess of 1900 bytes, which currently supports all defined VLAN packet sizes.



Note: If an application only requires the transparent passing of VLAN traffic, disable the VLAN function.

Some situations require Exalt radios to act upon VLAN traffic and perform any or all of the following functions:

- Connect specific traffic, using VLAN tagging, to a specific port on the radio, such as management traffic to the ETH2 port.
- Allow only traffic with specifically assigned VLANs to pass across the link, blocking all other VLANs or any non-VLAN traffic.
- Allow management access only through a VLAN connection, leaving the main traffic transparent.
- Allow management access without a VLAN connection, but flowing only specific VLAN traffic across the link.



Note: For more information see, [VLAN Configuration Page](#).

Simple Network Management Protocol (SNMP)

The Exalt radios primarily use a browser-based graphical user interface (GUI) for radio configuration and management, as described in [Exalt Graphical User Interface \(GUI\)](#). In addition, a command line interface (CLI) is provided for serial and/or Telnet access, as described in [Command Line Interface \(CLI\)](#). SNMP is often used for management of larger networks as described here. Use SNMP to manage networked devices and execute the following functions:

- GET: Obtain information from the device, such as a configuration setting or parameter.
- SET: Change a configuration setting on the device.
- TRAP: The device proactively informs the management station of a change of state, usually used for critical alarms or warnings.

One feature of the SNMP implementation is that system configuration changes do not take effect using the SET command. Instead, groups of configuration settings can be preconfigured for global change, and a single 'Save' (Commit) command implements all changes.

When some parameters are changed, a link may drop and/or management control lost. MIB files allow many parameters to be set at once, allowing only a temporarily dropped link or management control issue. The opposite end radio can be quickly reconfigured, with little downtime for the link and management control. The save (Commit) command is similar to the Update button.

Dropped links or management control issues do not occur with every parameter change. Many configuration changes do not impact traffic or management access.

Exalt radios utilize SNMPv3, a high security version of SNMP, to ensure secure access to and storing of management data. The SNMPv3 security string matches the admin and user passwords. Passwords must be eight characters or longer.

Exalt radios also allow for “legacy” SNMP support for SNMPv1 and SNMPv2. Configuration of all passwords and community strings is performed from a separate [Simple Network Management Protocol \(SNMP\) Configuration](#) page.



Note: MIB files can be downloaded directly from the radio using the [File Transfer Page](#).

System Installation and Initiation Process

The tasks required for radio installation and initiation are outlined in the following figure.

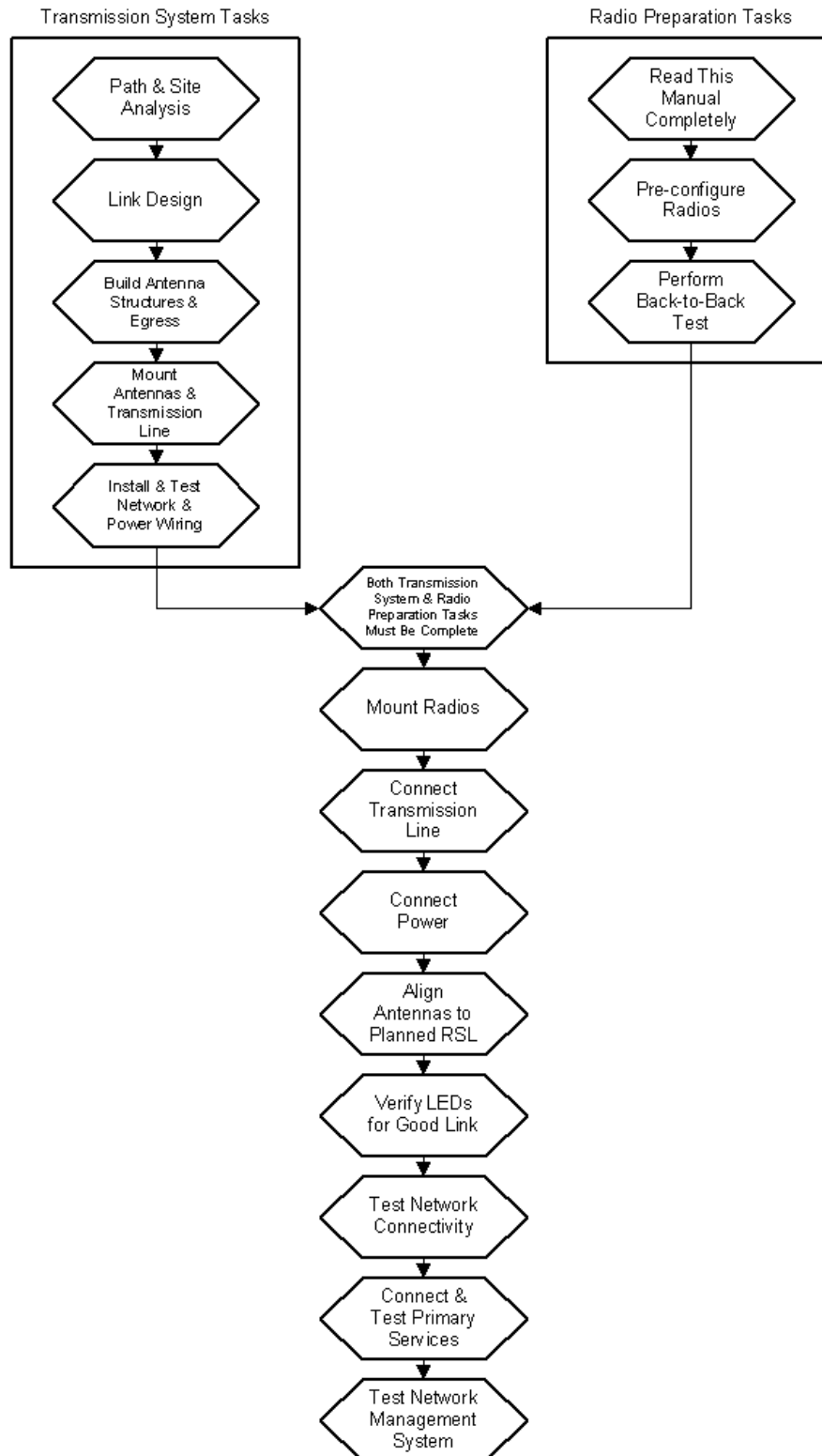

Figure 4 Radio installation tasks

Record Keeping

After installation, record the following items for ongoing maintenance and future troubleshooting. Keep a record for each end of the radio link and store a copy of these records at the radio location, at the opposite end radio location, and a central record storage location.

- GPS coordinates for antenna locations at each site
- Antenna heights above ground level (AGL), as mounted
- Antenna model numbers, serial numbers, and specifications
- Antenna polarization as mounted
- Length/type of primary transmission lines at each site
- Model number and serial number of RF lightning arrestors (for systems using coaxial transmission line only)
- Length/type of secondary transmission line(s)
- Transmitter output power setting as installed at each site
- RSL as measured after antenna alignment at each site
- Designed RSL per original design at each site
- RSL reading with far-end power off (from each end)
- [Spectrum Analyzer](#) plot with far end off at each site
- Radio's network management IP address at each site
- Radio's network management gateway address at each site
- Radio's operating frequency, bandwidth setting, and mode of operation
- Optionally purchased extended warranty and/or emergency service contract details

In addition, certain information may be desired for central record-keeping only:

- Link security codes and log in passwords (stored in a secure place)
- Photographs of complete installation
- End-user sign-off/acceptance documentation (if any)
- Photo of product identification label (part number, serial number, MAC address information)
- Electronic copy of radio's configuration file
- Electronic copy of radio's installed software

Installation

This section presents all tasks required to install the Exalt Digital Microwave Radio.

Mechanical Configuration and Mounting

The EX-i Series GigE (FDD) radios are one-piece designs intended for deployment in a telecom equipment rack indoors or in an appropriate environmental enclosure. The device must be deployed within an ambient temperature range as specified, and properly ventilated with no obstructions to the air intake and exhaust. The terminal occupies 2 rack units (2RUs = 3.5"/9cm) height in a typical telecom rack.

In most cases, additional racked equipment can be placed directly above and/or below the device with no empty spaces in the rack. However, depending on power consumption and ventilation for adjoining devices, they may pass heat to the device, not allowing the radio to cool properly and increasing the risk of malfunction. Heat dissipation from the radio may also affect adjoining devices. Provide air space above and below the device, where possible. If not possible, a thermal analysis may be required by a professional engineer to determine the impact of thermal transfer between all adjoining units.

Provide proper clearance for all cables and connectors attached to the device. All RF connectors, cables, and adapters must be rated for operation within the radio's frequency range. RF connector losses must be accounted for within the link engineering design and output power settings.

Rack Mounting

Rack mounting hardware for a standard 19" (48cm) rack is included in the accessory kit. Attach the rack mounting brackets to the sides of the unit with the provided screws. The radio can be mounted in one of four configurations:

- Front flush mount (front panel even with the rack mounting surface)



Figure 5 Front flush mount configuration

- Front projection mount (front panel extended forward from the rack mounting surface)



Figure 6 Front projection mount configuration

- Rear flush mount (rear panel even with the rack mounting surface)
- Rear projection mount (rear panel extended forward from the rack mounting surface)



Figure 7 Rear flush mount configuration



Figure 8 Rear projection mount configuration



Note: Screws for attaching the radio to the telecom rack are not provided; use the appropriate screw type that matches the equipment rack.

Table or Rack Shelf Mounting the System

Affix rubber feet or adhesive-backed non-slip pads (not included) near the corners of the unit along the bottom panel when mounting on a table or a rack shelf. These pads help keep the radio stable on a wooden or metal surface.



In many areas, it is necessary to strap the equipment to a table or rack shelf if mounting in this manner. In case of earthquake or other shock or vibration, or an accidental pull of a cable, the unit should be secured from falling. It may also be necessary to secure the AC adapter, if it is used.

Radio Ports and Indicators

This section provides a brief overview of the connectors, controls, and indicators on the device. Details about each item are in other sections of this document.

The EX-6i-DS3-GigE front panel is shown in Figure 7.

Connector Overview

The primary user interfaces are shown in Figure 9. Table 2 provides details of the front panel connectors. Detailed pin structures for each connector are in [Interface Connections](#).

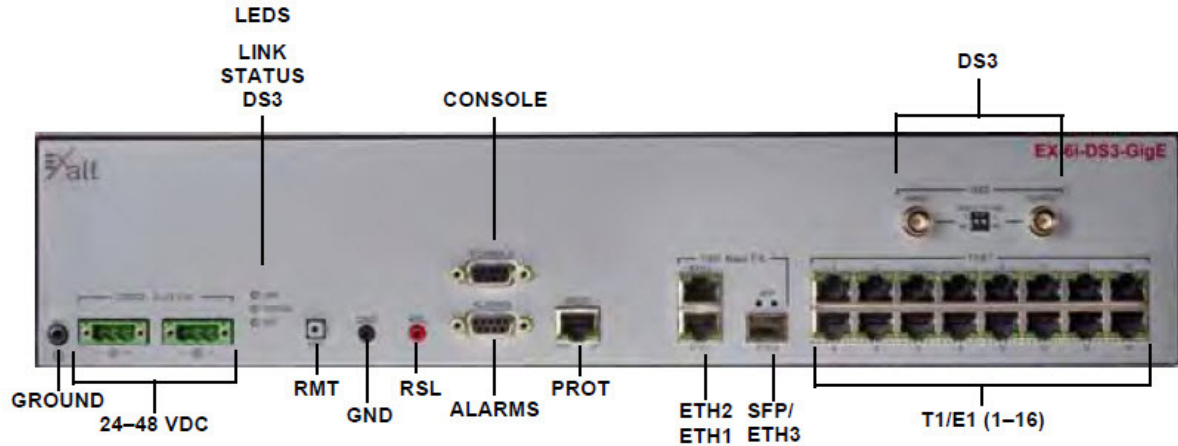

Figure 9 Primary front panel connectors

Table 2 Front Panel Connectors

Label	Type	Gender	Function
T1/E1 (1–16)	RJ-48C	F	Primary ports for User T1 or E1 circuits to traverse link.
DS3 (IN/OUT)	BNC	F	Primary ports for User DS3 circuit to traverse link.
OC3 (IN/OUT)	SFP	F	Primary port for User OC3 circuit to traverse link
ETHERNET (ETH1 and ETH2)	RJ-45	F	Primary ports for user Ethernet and/or management data (10BaseT, 100BaseT, or 1000BaseT) to traverse link.
SFP (Ethernet or ETH3)	SFP	F	Accepts either a fiber or copper GBIC inserted for Ethernet and/or management data (1000BaseF or 1000BaseT).
EXP	RJ-45	F	Expansion port, used for Space Diversity, MHS, XPIC, and Capacity Aggregation configurations. Available on select models.
ALARMS	9-pin sub-D	F	External alarm inputs and outputs.
PROT	RJ-45	F	Protection port for MHS configurations.
CONSOLE	9-pin sub-D	F	Management port (serial) for PC/PDA for Command Line Interface (CLI) communications.
GND (Ground)	Bantam	F	Common (return) volt meter test point for measuring RSL.
RSL	Bantam	F	Voltmeter test point for measuring received signal level.
24–48VDC (2)	3-pin modular	M	DC power inputs from DC source or AC adapter.
⬇ (Ground)	Threaded (M5) receptacle	F	Chassis ground connection (M5 x 0.8 threads).



Figure 10 DS3 connectors and grounding switches

For some models, DS3 IN and DS3 OUT connections (Figure 10) can be independently grounded or ungrounded to the chassis using a small DIP switch between the connectors. Ground loops to connected equipment must be avoided. Set the DIP switches accordingly.

LED Indicators

Table 3 provides details of the LED indicators on the EX-i Series GigE (FDD) radios. See [Alarms Page](#) for information on how the Exalt GUI displays LED status.

Table 3 LED indicators

Location/Label	Type	Function
LINK	3-color LED	Indicates RF link status: <ul style="list-style-type: none"> Green Solid = Error-free connection (BER<10e-6) Yellow Solid = Errored connection (10e-3>BER >10e-6) Red Solid = No link (BER>10e-3) Red Flash= No remote information available (when RMT is pressed and held) Off = Improperly powered or fatal system failure
STATUS	3-color LED	Indicates system status: <ul style="list-style-type: none"> Green Solid = No alarm conditions (normal operation) Yellow Solid = Alarm conditions, not traffic effecting Yellow Slow Flash = In loopback (from this end) Yellow Fast Flash = In loopback (at this end) Red Solid = Alarm conditions; traffic effecting Red Flash = No remote information available (when RMT is pressed and held) Off = Improperly powered or fatal system failure
DS3	3-color LED	Indicates DS3 connection status: <ul style="list-style-type: none"> Green Solid = No alarm conditions (normal operation) Yellow Solid = DS3 signal present, but DS3 is not enabled Red Solid = DS3 enabled, but not present Off = DS3 not in use
PROT Left Corner	Green LED	Indicates primary/secondary state for MHS protection: <ul style="list-style-type: none"> Solid = Configured as primary Off = Configured as secondary or MHS disabled

Table 3 LED indicators (Continued)

Location/Label	Type	Function
PROT Right Corner	Green LED	Indicates MHS protection communication status: <ul style="list-style-type: none"> • Solid = Communications OK • Off = Communications error or MHS disabled
ETHERNET ETH1/2 Left Corner	Green LED	<ul style="list-style-type: none"> • Solid = Negotiated @ 1000Mbps • Fast Flash = Negotiated @ 100Mbps • Slow Flash = Negotiated @ 10Mbps • Off = No connection negotiated
ETHERNET ETH1/2 Right Corner	Green LED	<ul style="list-style-type: none"> • Solid/Flashing = Data present • Off = No data present
SFP Left Side	Green LED	SFP link status: <ul style="list-style-type: none"> • Solid = Link engaged • Off = Link not engaged
SFP Right Side	Green LED	SFP traffic: <ul style="list-style-type: none"> • Solid/Flashing = Data present • Off = No data present
T1/E1 Left Corner	Green LED	<ul style="list-style-type: none"> • Solid = Connection present (clocking confirmed) • Fast Flash = Connection present; coding/clock problem • Slow Flash = Connection present, but unexpected • Off = No connection/clock
T1/E1 Right Corner	Green LED	<ul style="list-style-type: none"> • Solid = In a loopback state • Fast Flash = Automatic indication signal (AIS) is active • Off = No loopback; no AIS activity
RMT (LED inside button)	Amber LED	<ul style="list-style-type: none"> • Off = Remote end LINK and STATUS LEDs are both green • Solid = No remote end status available • Flash = Alarm conditions at the remote end (LINK and/or STATUS LEDs are non-green)
(Unmarked LED on rear panel)	2-color LED	Indicates overall status (from the rear panel): <ul style="list-style-type: none"> • Green = LINK and STATUS LEDs are both green • Red Flash = LINK and/or STATUS are in a yellow state; no red states exist • Red Solid = LINK and/or STATUS are in a red state • Off = Improperly powered or fatal system failure

RMT (Remote) Button

The RMT button is the only external control on the radios. This button allows easy and quick evaluation of the status of the remote-end radio. When the RMT LED is amber flashes, this is an alert that the remote end has an alarm condition. Press the RMT button to determine the alarm conditions.

When the RMT button is pressed and held and local LEDs flash, this indicates that no remote-end information is available. This indicates that the remote radio is either not powered, is booting, or is not

linked in the direction towards the local radio, or the local radio is receiving excessive errors in this direction. It could also indicate a serious failure of either radio.

Local-end LEDs (when this button is not pressed) in combination with remote-end information (from a technician located at the far end, and/or when the button is pressed) can substantially aid in rapid troubleshooting analysis.

Rear Panel Diplexer Orientation

The rear panel of the radio chassis arrives in a 'blank' condition, requiring the mounting and connecting of at least one diplexer filter. Figure 11 shows the rear panel without diplexers.



Figure 11 Rear panel without diplexers

One rear panel label indicates which diplexer type(s) are compatible with the chassis. Only mount and connect diplexers with matching type numbers.

For typical radio configurations, one diplexer is mounted and connected on the rear panel. The diplexer selection and orientation is based on the precise center frequency and transmitter-to-receiver frequency spacing that is required for the link. This is typically determined during the licensing stage and subsequently during the purchasing process of the radio so that the diplexers match the frequencies and spacing required.

Each diplexer can cover a range of center frequencies for transmit (Tx) and receive (Rx), and the ports on the diplexers are labeled to indicate that range, as shown in Figure 12. The diplexer can be oriented in one of two ways, and the right-side-up horizontal text on the diplexer indicates the configuration, as oriented. The designations on the diplexer are labeled TX-H (Transmitter High) or TX-L (Transmitter Low) to indicate if the transmitter frequency range is higher or lower than the receive frequency range. Likewise, the receive frequency ranges are labeled as RX-H and RX-L.

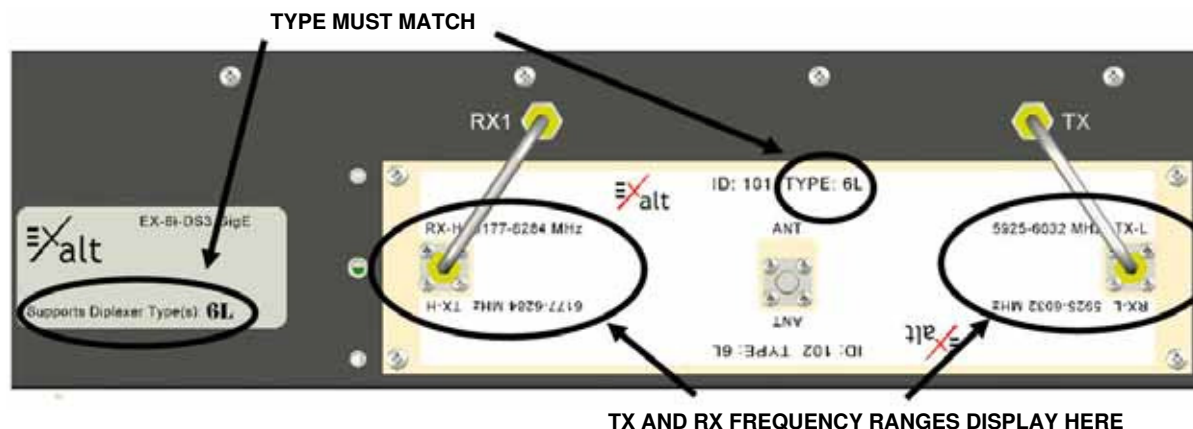

Figure 12 Diplexer labeling

In most configurations, the diplexers used for two ends of a link are the same diplexer, but mounted in opposite physical orientation (rotated 180 degrees relative to one another), as shown in Figure 13.

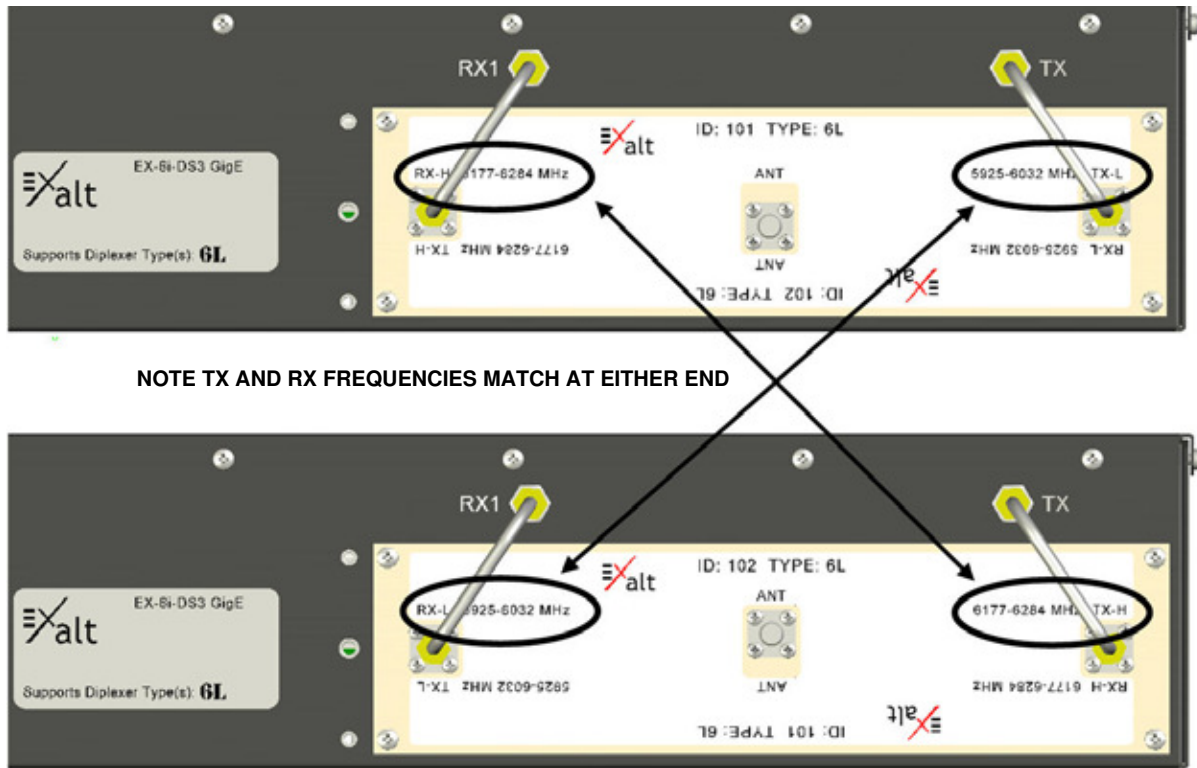

Figure 13 Diplexer orientation for a typical 'link' of radios

Note in Figure 13, that this is the same diplexer for both radios, but they are mounted upside down relative to one another. It is a logical arrangement because one radio is configured to transmit across the same range of frequency that the opposite radio is configured to receive and vice-versa.

Notes:

- 1 The radio must have the software configured to match the ID number (orientation) of the diplexer, as shown in the right-side-up text at the top center of the diplexer. See [System Configuration Page](#) for details. On the GUI page, there is a Diplexer ID selection. This must match what is printed right-side-up on the installed diplexer. Once properly configured, the radio can tune to center frequencies and bandwidths accommodated by this diplexer, as mounted.
- 2 Two semi-rigid coaxial cables are provided with each diplexer. These must be connected to the TX and RX1 rear-panel ports of the radio, as shown in Figure 12 and Figure 13.
- 3 The frequency range shown on the diplexer label indicate the EDGE frequency range of the diplexer, not the center tuning range. The center tuning range is determined by the Occupied Bandwidth setting of the radio, and is 1/2 of the Bandwidth value (in MHz) in from the edges of the diplexer.

Non-Standard Frequency Pairs

From time to time, a licensing authority may assign a radio to be used on frequency pairs not accommodated by Exalt standard diplexers. In these cases, there can be two separate filters and a

circulator to accomplish the filtering and connections normally provided by the diplexer. There also may be special mounting plates to accommodate these devices, but the concept for this arrangement is similar to the above — the Tx frequency range on one side must match the Rx frequency range on the opposite side and vice-versa. The filters must be connected to the TX and RX1 ports on the rear panel.



For non-standard pairs, use the ‘Other’ selection for diplexer type. The tuned Tx and Rx frequencies must be manually entered in to the frequency selection section in the GUI. The edge frequency range of the filters are labeled on the filters. The center frequency must be tuned to accommodate the bandwidth setting within the edge frequency range in accordance to the licensing requirements.

Antenna Connection

The connection leading to the antenna is the ANT port on the diplexer, which is typically an SMA female connection near the center of the diplexer. The diplexer kit includes a proper high-quality flexible RF cable to accommodate connection to an N-type female connector, either from the primary RF cable (if coaxial) or the coaxial jumper that feeds to that waveguide or to a waveguide adapter (sold separately).

Most transmission system implementations use a waveguide. The waveguide should be mounted so that the connection is near the ANT connector port. The end of the waveguide run will use the waveguide-to-coaxial adapter, accommodating the high-quality flexible jumper cable (included). All losses associated with the jumper(s), adapter(s), and waveguide should be planned in the link budget used for engineering the link.

Space Diversity

Another diplexer configuration of the radio is for space diversity applications. This is where two antennas are used, mounted at different heights, to improve performance relative to multipath fading, which occurs on longer paths, paths over flat terrain, and/or paths over water or in dynamic weather environments. Space diversity requires two identical diplexers mounted on each radio, and a software license key that allows enabling the space diversity function in the radio.

A typical space diversity diplexer configuration for a single terminal is shown in Figure 14. Note that both diplexers are the same type and orientation. One is connected only to the RX2 port for the diversity receive path.



Figure 14 Typical Space Diversity diplexer configuration

The opposite end of this space diversity link uses the same two diplexers, but rotated — in Figure 14, ID 102 is the orientation for both diplexers.

Connect the secondary receive antenna to the ANT port of the secondary diplexer in a similar manner to the primary transmission line connection.

Power

The radio requires a DC power source within specifications. DC can be provided from a DC battery source, central lab/rack supply to the power injector (sold separately), or from the optional AC power injector.



Note: No AC adapter is provided with these radios. Exalt recommends using a DC power plant.

Read this section completely before applying power.

Terminating the RF Connector



Caution! Before applying power, the device's RF connector must be properly terminated into a 50-Ohm load. If this is not performed, the radio may be damaged by simply applying power. Also, there are human safety factors to consider regarding potentially harmful RF radiation.

There are a few simple means to accommodate proper termination:

- Connect a 50-Ohm coaxial termination device to the RF port of the radio. The termination must be rated to 1W (or more). Example(s) include:
 - Broadwave Technologies P/N 552-200-002, or similar
- Connect the complete transmission system. That is, the RF cabling including the antenna. The cabled antenna provides a proper termination for the RF output.
- Connect a fixed (or a series of fixed) 50-Ohm attenuator(s) to the RF connector, either directly or at the end of an RF transmission line. The attenuator must be at least 30dB as specified at the operating frequency and rated for a minimum of 2W input power. Examples include:
 - Broadwave Technologies P/N 352-103-xxx
 - Bird 2-A-MFN-xx
 - JFW Industries 50FP-xxx-H6-N

DC Power

The DC voltage input accepts either 24 volts or 48 volts, nominal. Ensure that the power source is specified for the proper amount of current delivery capacity. The DC power may be connected as a positive or negative voltage supply, and be referenced to ground or 'floating' (differential voltage). There are different system grounding considerations depending on the nature of the DC supply grounding, and consult a qualified electrician or telecoms professional on the proper wiring and grounding process. Only one power source is required, but two power connectors are provided for input power redundancy.

To connect a DC source, with the power disabled on the DC supply, connect proper gauge wiring to the DC supply. For most (short) power cable runs, 18AWG or 24AWG wire can be typically used. Strip the ends just long enough for enclosure to the DC radio connector (approximately 0.25 inches/6mm). If using stranded wire, the stripped ends inserted into the DC terminal connector must be solder-tipped. If using solid wire, a solder tip is not necessary. Ensure that the power wiring is long enough to neatly traverse, when properly dressed, between the source supply and the radio mounting location. If DC wires are to be exposed to outdoor environments, use wire in the proper weatherproof wiring jacket.

For longer runs of DC wiring, use a higher gauge wire and/or higher current source supply to overcome the additional resistance of the DC wiring. However, the DC connector for the radio may not be able to accept a high diameter wire, transition to thinner gauge near the end of the wiring run or use the maximum diameter wire for the entire wiring run, as long as it meets the powering requirements considering total resistance of the wiring and the power source current load capacity.

Insert the wiring ends into the DC mating connector (supplied) and tighten the terminal screws to secure the wire into the connector. Do *not* connect the mating connector to the radio system and disable the power system.

Pay close attention to the polarization of the DC signals coming from the DC supply and the ground conductor (if any), and ensure that they are connected to the proper pins of the DC mating connector. The connector mate on the radio is clearly marked on the front panel for proper polarization and for ground connection.

Wire across the plus (+) and minus (-) terminals from the DC supply. In addition, place a separate jumper between the proper terminal and the ground terminal to reference one side of the power supply line to the radio chassis ground. In some cases, the DC system may need to be floating and this ground jumper is not necessary; however, many configurations require one side to be grounded for proper electrical safety.



Warning! Consult a qualified electrician if uncertain about how to properly ground the system and connect power. When disconnecting power, always disconnect all sources of power supply.

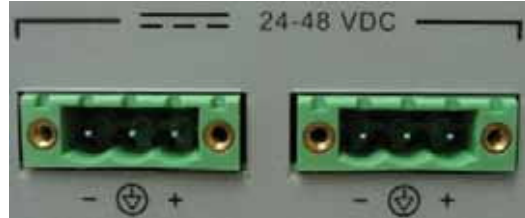

Figure 15 DC connectors

Once the wires are connected to the mating connector, do not connect to the radio. First test the DC connection to the connector from the DC supply. Engage power on the DC supply, and use a volt meter to verify proper voltage level and polarity.

Verify that the RF connector is properly terminated, as described in [Terminating the RF Connector](#). Disengage power once again on the DC source, and connect the mating connector to the radio device. Engage power on the DC source. Verify radio is active by observing LED activity. All LEDs flash during the initial power cycle to verify that they are operational. Secure the DC connector using the integral captive screws at each end. This prevents accidental disconnection.

Reset to Critical Factory Settings

If necessary, the radio terminal may be reset to critical factory settings. This may be necessary if the IP address and/or passwords for the system are not known. All other configurations are left at their current settings. If a complete default factory configuration is desired, load the Default Configuration File into the system, as described in [File Activation Page](#).

The following parameters are configured after a reset to critical factory settings:

- IP Address = 10.0.0.1

- IP Mask = 255.0.0.0
- IP Gateway = 0.0.0.0
- Administration password = password (or 'admin')
- User password = password (or 'user')
- VLAN disabled

To perform a reset to critical factory settings:

- 1 Remove power.
- 2 Hold the **RMT** button on the front panel while applying power.

Continue to hold the **RMT** button through the entire boot cycle (approximately 45 seconds).

The front-panel LEDs toggle during the boot cycle.

- 3 Release the **RMT** button when LED behavior stabilizes.

Antenna/Transmission System

This section provides guidance to mounting and connecting the RF transmission system, which consists of the antenna, RF cabling, and RF lightning arrestors. Consult the manufacturer's instructions for proper mounting, grounding, and wiring of these devices, and for definitive direction. These manufacturer's instructions supersede any information in this section.

Initial Antenna Mounting

The antenna must be an exact model recommended by the path and site planning engineer(s). Mount the antenna at the proper height, mast/mounting location and polarization orientation as determined by the path and site planning engineer(s). The model type, location, and orientation of the antenna is critical with respect to achieving proper path clearance, as well as to mitigate external or self-interference from nearby or collocated systems operating in or near the same frequency band.

The antenna structure must be secure and safe with respect to the mounting of the antenna, transmission system weight, radio housing, and the combined weight of any personnel that may climb or attach to the structure.

The combined weight of items and forces on the structure must be carefully considered in the design and construction of the structure. This must include the weight bearing on the structure in the highest wind conditions possible in the region, and with respect to all objects affixed to the structure.

If additional objects are affixed to the structure in the future, it may be important to evaluate both the mechanical impact of these planned additions (with respect to wind and weight loading), as well as the potential impact to RF interference and frequency coordination (if additional radio equipment is anticipated). This is especially important if future equipment is likely to operate within the same frequency band.

Once the antenna is mounted, cabled, and aligned, your goal is to never require modification. This prior planning is important in the path and site planning stages and in construction of the antenna structure.

Follow the antenna manufacturer's instructions for mechanical mounting of the antenna. Ensure that there is enough room around the antenna for alignment activities (moving the antenna in vertical and horizontal arcs), and for the RF transmission line to connect to the antenna connector unobstructed and within the specified bend radius requirements of the transmission line.

At this point, the antenna mounts should be fully secure to the structure, the feed of the antenna securely mounted to the antenna (if the feed is a separate assembly), and the azimuth and elevation adjustments not completely tightened in preparation of the antenna alignment activity. It is a good practice to connect the transmission line to the antenna connector as early in the process as possible, to reduce the opportunity for debris or moisture to enter either the antenna connector or the transmission line connector. Use a connector cover or other temporary measures to ensure that the connector is kept clear. Take extra care if the antenna is installed during inclement weather to ensure that no moisture gets inside the antenna connector at any time.

Now the antenna can be aimed in the general direction required for the link. Use a compass, a reference bearing, binoculars or any other similar device to point the antenna in the direction (generally) of the far end radio, and then slightly tighten the azimuth and elevation adjustments so that the antenna maintains its general position and is safe to be left without additional securing. Refer to the Exalt white paper, *Antenna Alignment*, for more information on antenna alignment techniques.

Transmission Line from Antenna to Egress

Most installations for 6GHz and higher frequencies use waveguide line for the primary connection between the antenna and the radio device. Alternatively, and especially for shorter paths or where only short runs of transmission line are needed, coaxial transmission line can be used. Coaxial transmission line can either have a solid or braided shield. Solid-shield cables are more resistant to external signal coupling and interference, but are generally stiffer than braided cables. Consult the path or site engineer(s) to ensure that the proper materials are chosen for the installation and that all factors were considered. Refer to the Exalt white paper, *Transmission Line for Exalt Indoor Radio Systems*.

Waveguide is the preferred transmission line approach for these radios, as it exhibits minimum loss to the antenna system. In some cases, coaxial transmission lines can be used.

For coaxial transmission line, the larger the diameter of the transmission line, the lower the loss. So for longer runs of transmission line, larger diameter cables are highly advised. However, at every frequency, there is a maximum diameter cable that supports the operating frequency. Verify the specifications. This should be determined in the path and site planning process.

It is critical that the transmission line and antenna be capable of supporting the same type of connector, or easily adapted. It can be important to minimize the number of connectors and adapters, and it is ideal that they match directly without adaptation. In most cases, 6GHz waveguide transmission line allows for CPR-137 flange connectors and antennas have the same connectors.



Caution! Always follow the manufacturer's termination process EXACTLY, and only use the manufacturer's authorized tools and connectors for a given transmission line type.

The manufacturers of transmission line typically offer instruction and certification for transmission line termination, and may also provide videos illustrating the process. There is no amount of extra care, education, precision, and effort that can be overstated for this process.

Once the transmission line is connected to the antenna, traverse the exact route provided by the site planner. There is often a need for a small section of flexible transmission line near the antenna to accommodate the need for extra slack as the antenna is loosened and moved for the alignment process.

Consult your transmission line manufacturer for the proper transportation, hoisting, securing, and grounding process. Always be very mindful of the entire length of transmission line to ensure that the transmission line is never twisted, kinked, or over-bent beyond the specified bend radius. Once a transmission line is over-bent or kinked, it will likely never recover its specified characteristics, even after straightening, and will often be completely unusable.

The opposite end of this primary transmission line typically terminates at the building or enclosure egress point. If coaxial transmission line is used, this is where to locate the RF lightning arrestor. Ensure that a proper termination to the connector-type of the lightning arrestor is made at this location. A drip loop may be required and proper securing hardware and grounding must be accommodated. If waveguide is used at the entry point, there is no need for lightning suppression. But install proper grounding according to the manufacturer's instructions.

As soon as practical, weatherproof the connected ends of the transmission line to the antenna and lightning arrestor. This process should be delayed as long as possible to ensure that all systems are working properly before applying the weatherproofing. Once weatherproofing is applied, it may have to be removed for testing or installation modification. With this in mind, if the installation is occurring during inclement weather, take extra care at all times to ensure that no moisture enters any connector at any time. If moisture is suspected to have compromised the antenna or transmission line, it may render those devices useless without any means for remedy except for full replacement.

Indoor Mounting

On rare occasions the antenna can be mounted indoors behind a window. In these cases, there would not be a need for drip loops or an RF lightning arrestor. Use a very short transmission line connected directly between the antenna and the radio mounted nearby. The weatherproofing process can also be omitted.

RF Lightning Arrestor

RF lightning arrestors are needed for any coaxial connection that traverses from outdoors to indoors. They provide a direct path to ground for lightning strikes that may couple to or directly hit the outdoor transmission system or antenna structure. The RF lightning arrestor prevents any associated voltage and current from entering the building or enclosure, where it might harm the radio equipment, other equipment, or humans.

The following lightning arrestor is an appropriate choice for this application:

- Polyphaser WSXM

Mount and ground the RF lightning arrestor in accordance to the manufacturer's recommendations. Place it as close as possible to the egress point where the next piece of transmission line enters the building or enclosure. Minimize the distance to the egress to lessen the opportunity for lightning to couple to or strike the unprotected section of transmission line (if any). Where possible, use a bulkhead connector to eliminate any opportunity of this risk. Keep cable lengths behind the arrestor and into the egress substantially short (less than 3'/1m) as a safe practice. Consult a qualified electrician or installer in all cases of grounding and lightning arrestor implementation.

Transmission Line from Egress to Radio

A single transmission line section from the egress to the radio RF connection is always desired. Minimize the number of connectors and adapters. For indoor runs, a cable ladder or tray may be needed to properly secure the transmission line. In some cases, a short flexible jumper allows ease of connection to the radio's RF connector. An installation with space around the radio to accommodate a gentle bend radius of the transmission line is also good for a direct connection. In all cases, ensure that the transmission line is not a pulling force of the RF connector on the radio. Transmission lines can be very stiff and can damage the connector if not dressed properly. Also, follow the transmission line manufacturer's instructions for the proper use of cable securing devices.

For waveguide installations, the waveguide typically runs horizontally from the egress across a cable ladder or tray, and then vertically down to the radio rack location. The waveguide should end as close

as possible to the rear panel of the radio. Included in the diplexer kits to accommodate the final connection to the radio are 6" (152.4mm) and 1' (304.8mm) RF cables for connection to properly specified waveguide adapters.

Antenna Alignment

Antennas must be installed at both ends of the planned link to commence precision alignment. Refer to the Exalt white paper, *Antenna Alignment*.

Antennas are typically aligned using the radio hardware for precise alignment. However, there are many very useful tools available to aid in this process, inclusive of devices specifically designed for the purpose of aligning antennas. Some examples are:

- XL Microwave Path Align-R
- Teletronics 17-402

Use of these devices may be extremely advantageous as compared to using the radio, because they employ many unique facilities to aid in this process. Using these tools also makes it possible to align the antennas before the radio equipment is delivered. However, many installers successfully use the radios as the means for antenna alignment.

There are two primary facilities when using the radio to align the antenna:

- RSL voltage test point using a volt meter (recommended)

The RSL test point DC voltage is inversely proportional and numerically calibrated to the received signal level. The voltage rises as the antennas are less in alignment, and falls as antennas are more in alignment. The voltage measurement corresponds to the received signal level in measurements of dBm (a negative number for RSL measurements). For example, an RSL of -60dBm yields an RSL voltage measurement of 0.60VDC; an RSL of -45dBm measures 0.45VDC.

- GUI RSL reading indicates the current RSL in dBm.

Alignment of the antennas using the RSL test point can be accomplished in the following ways:

- Radio near or at antenna location
 - Temporarily connect the radio to the antenna using a short piece of transmission line, so that the radio is very close to the antenna location
 - Run wires, as necessary, from the RSL test point to the volt meter so that the antenna installer can directly view the volt meter



Note: Using this method, the final RSL voltage readings during alignment may be different (better) than the planned RSL, due to the short RF transmission line. Use the path calculation tool to determine the RSL that should result in this temporary configuration to ensure proper ideal alignment.

-
- Run separate wires from radio mounted location to antenna location
 - Temporarily connect a set of wires from the RSL test point to the antenna location, to allow the radio installer to use a local volt meter



Note: Due to the resistance of the cable, the RSL readings might be impacted. Use the thickest wiring possible. Test the impact of the voltage reading due to the wiring by comparing a direct measurement at the RSL test point as opposed to the end of the wiring.

- RF/DC coupler (for coaxial transmission line interconnection applications only)
Install a temporary DC coupling device at the radio antenna port and at the antenna connector. Connect the RSL test point to the radio antenna port coupler, and the volt meter to the antenna connector coupler.
- Verbal relay/walkie-talkie/mobile radio/cell phone
 - A person located at the radio front panel can use a short-range communication device or verbal relay to communicate to the antenna installer and read off RSL voltage measurements

Only use the browser-based GUI for antenna alignment if there are no other means available. If this method is required, refer to [Exalt Graphical User Interface \(GUI\)](#). The RSL reading can be read on a PC or any handheld computing device that supports an HTML browser and Ethernet connectivity.



Note: There is a slight delay in RSL readings in the GUI as the RSL levels change. In this case, fine alignment can be done in small adjustments allowing a small gap of time so that the impact of the adjustment on the GUI display catches up to real time.

Configuration and Management

This section describes the command line interface (CLI) and Exalt graphical user interface (GUI).

Command Line Interface (CLI)

Exalt Digital Microwave Radios provide a CLI to set key parameters on the system. Use the Console port for serial devices, or use the Ethernet MAIN or AUX ports for a Telnet session over a network connection.

Bits per second:	9600
Data bits:	8
Parity:	None
Stop bits:	1
Flow Control:	None

Telnet into the Command Line Interface (CLI)

Use a Telnet connection to access the CLI in the Exalt Digital Microwave Radios. Use the CLI to set key parameters on the system.

Connect to the Radio in a Telnet Session

Make the Telnet connection to the radio through the Ethernet port. Use Windows and perform the following steps:

- 1 Open a command prompt or MS-DOS prompt (**Start>Run**).
- 2 Type `C:\>Telnet <IP Address>` at the command line:

The default IP address is **10.0.0.1** (for the Tx Lo radio, or after default reset). **10.0.0.2** is the IP address for a new (from factory) Tx Hi radio.



Note: The accessing computer must be on the same IP subnet as the radio. If the radio supports DHCP and DHCP is enabled (see [Ethernet Interface Configuration Page](#)), which is the default setting for a radio shipped from Exalt (for the models with this feature), and your computer's Ethernet port is set for DHCP addressing, the radio will configure your computer to 10.0.0.3 or 10.0.0.4, and no manual IP configuration is required.

Telnet

Use Telnet when prompted to enter the administration level login and password. The default administration login is *admin* and password is *password*. It is recommended that the default administration password be reset by performing a radio reset (see [Reset to Critical Factory Settings](#)).

Figure 16 shows the menu choices available after log in.

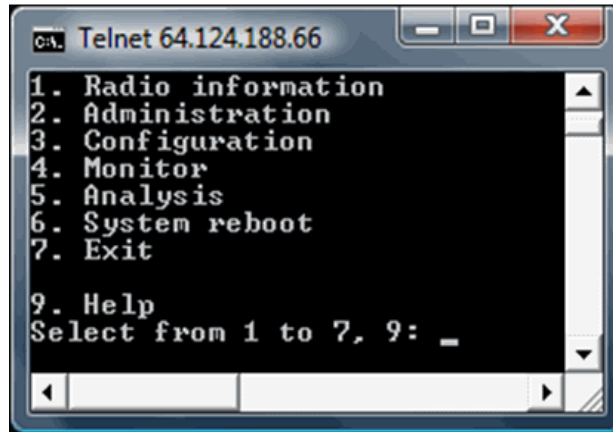

Figure 16 CLI root menu

The following selections can be made on all screens:

- 0 = back to previous screen
- 9 = help
- Ctrl+\ (control and backslash keys) = exit session

Exalt Graphical User Interface (GUI)

The Exalt GUI is the primary user interface for configuring and troubleshooting the radio and radio system. A computer or hand-held device with a conventional HTML browser and Ethernet port is required. Microsoft Internet Explorer is the preferred browser. Netscape, Mozilla, and Firefox are also supported.

Preparing to Connect

If the radios are new, both radios are preconfigured as Tx Lo and Tx Hi with default IP addresses of 10.0.0.1 and 10.0.0.2, respectively. If the radios are not new, the IP addresses and Hi/Lo and diplexer configurations may need to be changed. The initial priority is to connect to the radio's management system to completely configure the radio. Assign the radios different IP addresses, unique to each radio. There are two ways to change the IP address:

- 1 Reset the radio to the critical default factory settings (see [Reset to Critical Factory Settings](#)).
- 2 Connect to the GUI using the default IP address (10.0.0.1 or 10.0.0.2), and change the IP address through the GUI interface.



Note: To connect to the radio's Ethernet port and use the GUI interface, the accessing computer must match the radio's IP address subnet. It is therefore necessary to either change the radio's IP address through the CLI to match the subnet of the computer, or change the computer's IP address to match the subnet of the radio (such as, a computer IP address of 10.0.0.10 if trying to connect to a radio set to the factory default IP address of 10.0.0.1).

If the radio supports DHCP and DHCP is enabled (see [Ethernet Interface Configuration Page](#)), which is the default setting for a radio shipped from Exalt (for the models with this feature), and your computer's Ethernet port is set for DHCP addressing, the radio will configure your computer to 10.0.0.3 or 10.0.0.4, and no manual IP configuration is required.

Make Connections

It is recommended that one radio at a time be configured, on a bench, before taking the radios to the field for installation. Terminate the RF connector with a 50-Ohm termination or a fixed attenuator of at least 20dB (see [Power](#)).



CAUTION! Do not connect the radios in a back-to-back configuration unless the IP addresses of the two radios are verified as different from each other.



Note: The IP address subnet of the accessing computer must match the radio's IP address subnet to connect using Ethernet.

Once connected to the radio using Ethernet, log in to the Exalt GUI.

Log In

Use the following steps to log in to the Exalt GUI.

- 1 Open a browser window.

Microsoft Internet Explorer is the recommended browser. Netscape, Mozilla, and Firefox are also supported. If there are issues with your browser, please report it to Exalt Customer Care. You may be required to use a different browser to immediately overcome issues.

- 2 Type the IP address of the radio in the address bar.

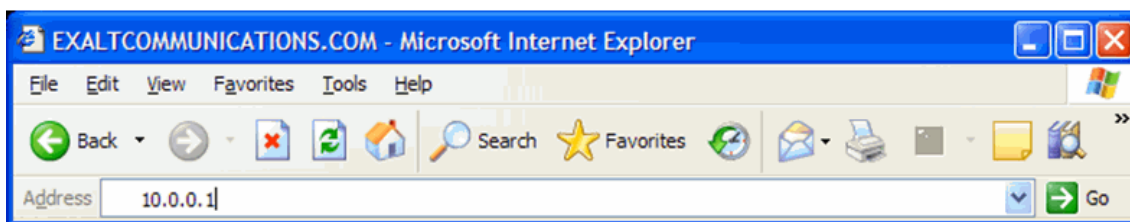

Figure 17 Initiating the browser connection

The following window displays after pressing the Enter key or clicking the Go button in the browser window.



Figure 18 Browser Login screen

Login Privileges

There are two levels of login privileges:

- Administrator (admin) – assigned complete permissions to view, edit, and configure

- User (user) – assigned limited, view-only permissions with no edit or configuration rights

The default login names and passwords are as follows:

Table 4 Default login information

Privilege level	User name	Default password
Administrator	admin	password
User	user	password

Administrator login credentials are required for configuration purposes. Type the user name and passwords for Administrator level and click OK. The following screen displays.

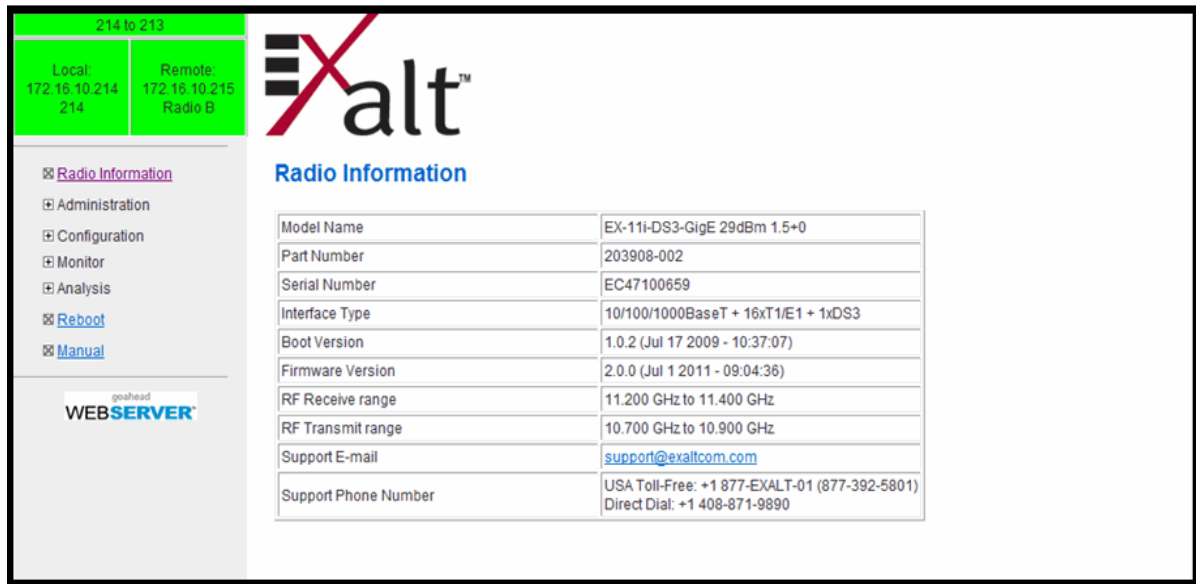

Figure 19 Radio Information page

Quick Start

To establish a link on the bench, apply the following basic configurations to the radio terminal. Use the steps in the *Quick Start Guide* included with the radio. A summary of the items that need to be configured are:

- Radio IP address for each end.
 - Each end must have a different IP address and cannot match the accessing computer’s IP address or any address assigned if radios are part of a larger network.
 - It may be required to change the IP address of the accessing computer after changing the IP address of the radio so that the IP subnet matches.
 - The radio IP address is listed on the [Administration Settings Page](#).
- Verify diplexer configuration:
 - On rear panel, ensure that one end of the link is configured for Tx Low and the other end Tx High, and matching opposite channels from one another.

- In the GUI ([System Configuration Page](#)), the diplexer selection must match the type and orientation of the diplexer installed.

If all other parameters are still configured at their factory default settings, the radios can now be connected back-to-back to verify that the link is communicating and perform any other desired tests. See [Back-to-back Bench Testing](#) for test information.

[Navigating the GUI](#) describes each page of the GUI. Most configuration parameter settings are intuitive. The following link parameters must match at both ends for the link to communicate:

- Link Security Key ([Administration Settings Page](#))
- Bandwidth ([System Configuration Page](#))
- RF Frequency ([System Configuration Page](#)), the channel plans match, but are opposite Tx and Rx frequencies for a link.



Note: Changing any of these parameters causes a temporary loss of link. The GUI displays a warning and provides an opportunity to cancel changes.

Navigating the GUI

The GUI provides the primary interface for all configuration and management. There are three sections of the main GUI window:

- Summary status information section (upper-left corner)
- Navigation panel
- Main window

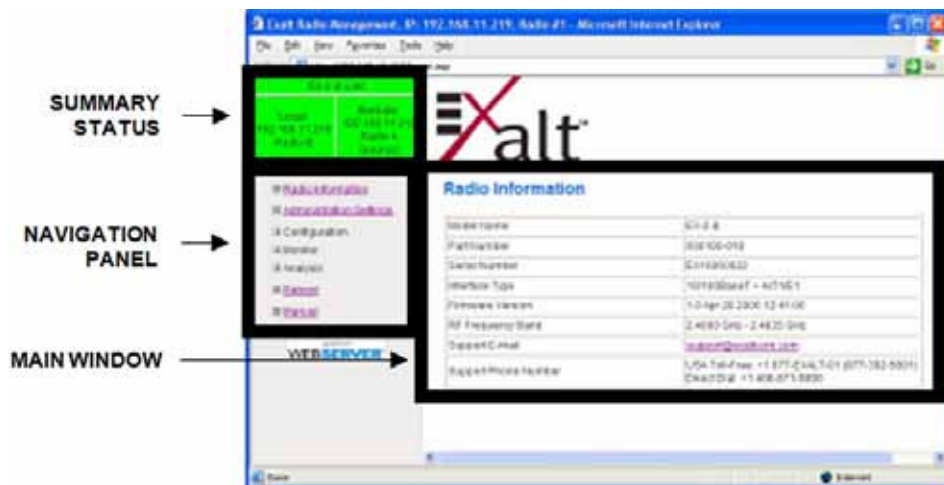

Figure 20 Exalt GUI window description

Summary Status Section

This section of the Exalt GUI provides a review of the system status.

In the screens in Figure 21, the top bar illustrates the alarm condition of the link. The information inside the bar is equivalent to the entry of the Link Name set by the administrator in the Administration Settings page.

The color of the panel indicates alarm status:

- Green indicates the system is communicating and all functions are normal
- Yellow indicates a minor non-traffic affecting alarm condition
- Red indicates a major traffic affecting alarm condition

The left panel summarizes the alarm conditions of the local radio (the radio that matches the IP address). The information displayed is the IP address and the endpoint identifier (Radio A or Radio B). The right panel summarizes the alarm conditions of the remote radio (the radio linked to the local radio).



Note: The ‘local’ radio might be the near-end or the far-end radio, depending on the management interface connection. The terms local and remote refer to the orientation of the radio terminals relative to the IP address you are managing. When making certain changes to a near-end radio without first making changes to the far-end radio, the link may become disconnected unless configuration changes are reverted to their original settings. When making changes that may disrupt the link, **always change the far-end radio first, and then the near-end radio to match.**

The Summary Status Section allows the Exalt GUI to be a rudimentary management system. Minimize the browser window to display just the top bar or the top bar and radio information, and open several browsers on the desktop. When a window status changes to yellow or red, you can quickly maximize that window to determine the issues.

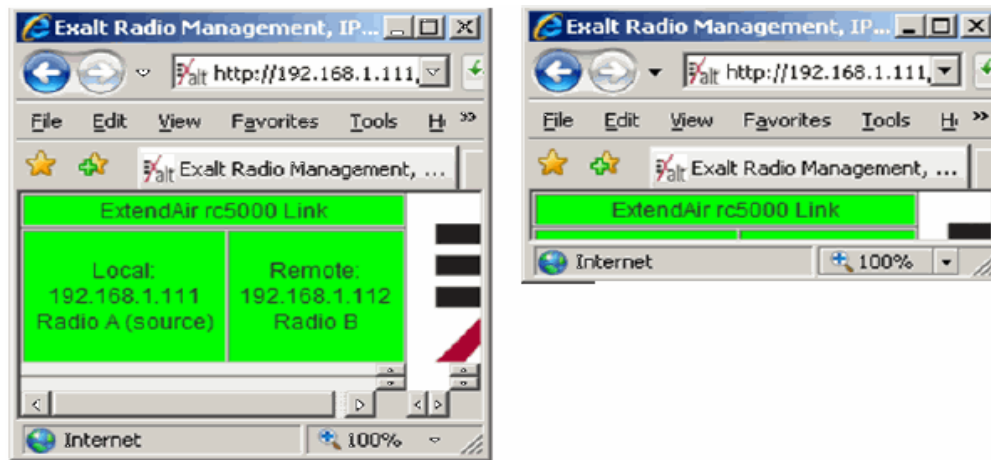

Figure 21 Summary status information

Navigation Panel

In the navigation panel, pages with sub-pages have a plus (+) to the left of the page link. Click the plus sign or page name title to view sub-page titles. The pages can be collapsed to hide the sub-pages when a minus (–) sign appears to the left of the page link.

Management pages are indicated with an X to the left of the page name. Click the X or page name to display the page within the main window.

Radio Information Page

This page provides general information about the local radio terminal. This information is helpful for troubleshooting and for record keeping.



The screenshot shows the Exalt web interface. At the top left, there are two status boxes: 'Local: 172.16.10.214 214' and 'Remote: 172.16.10.215 Radio B'. Below these is a navigation menu with the following items: [Radio Information](#) (selected), [Administration](#), [Configuration](#), [Monitor](#), [Analysis](#), [Reboot](#), and [Manual](#). The main content area features the Exalt logo and a section titled 'Radio Information' containing a table with the following data:

Model Name	EX-11i-DS3-GigE 29dBm 1.5+0
Part Number	203908-002
Serial Number	EC47100659
Interface Type	10/100/1000BaseT + 16xT1/E1 + 1xDS3
Boot Version	1.0.2 (Jul 17 2009 - 10:37:07)
Firmware Version	2.0.0 (Jul 1 2011 - 09:04:36)
RF Receive range	11.200 GHz to 11.400 GHz
RF Transmit range	10.700 GHz to 10.900 GHz
Support E-mail	support@exaltcom.com
Support Phone Number	USA Toll-Free: +1 877-EXALT-01 (877-392-5801) Direct Dial: +1 408-871-9890

Figure 22 Radio Information page

- Reset the admin and user passwords. These passwords should not match. If the admin password remains at the factory default setting, it provides an opportunity for random reassignment by a network-connected user.
 - The new password must be entered twice. If the passwords do not match and the Update button clicked, the password is not changed and remains set to the previous password.
- Enter the license key provided by Exalt to access extended features or diagnostic capabilities. Click Update to accept the changes and enable the new features. License keys are issued by radio serial number, so ensure that the license key used was issued for this particular radio.
- AES (Advance Encryption Standard) can be implemented to provide additional data security for the wireless link. This function requires an upgrade license key (purchased separately). Both radios in the link must have a valid AES upgrade license key to implement AES. Different bit-length encryption license keys (for example, 128-bit and 256-bit) are also available, depending on model type. If the required upgrade license key is present, simply insert a matching hexadecimal string on both terminals and select the Enable AES On option for AES encryption. Note that similar to the administration and user passwords, the AES string must be entered twice for each terminal.

NTP and Time Zone Configurations

 **Note:** This feature is not available on all models.

When Network Time Protocol (NTP) is enabled, the time and date is provided by the server. For NTP, set the IP address of the server where the time is to be retrieved. Up to four server IP addresses can be used. Any time zone can be selected, including Universal time. These servers must be available on the network that the radio is connected to. When NTP is disabled, the time and date is set on the Administration Settings page.

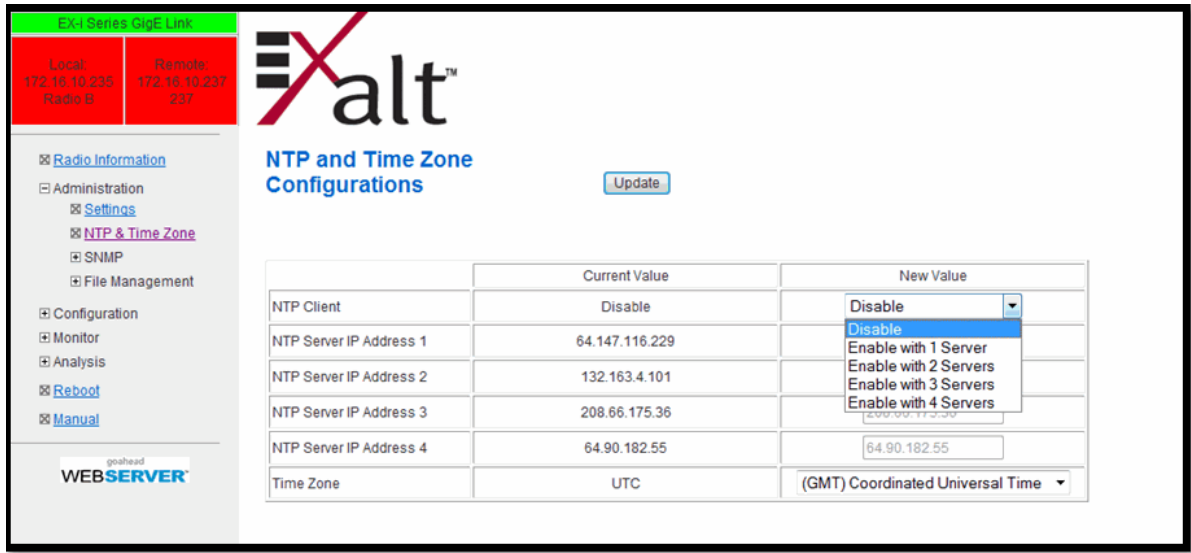

Figure 24 NTP and Time Zone Configurations page

Simple Network Management Protocol (SNMP) Configuration

This page allows the enabling and disabling of the Simple Network Management Protocol (SNMP) functions. Use SNMP to manage networked devices and execute the following functions:

- GET: Obtain information from the device, such as a configuration setting or parameter.
- SET: Change a configuration setting on the device.
- TRAP: The device proactively informs the management station of a change of state, usually used for critical alarms or warnings. See [SNMP Traps](#).

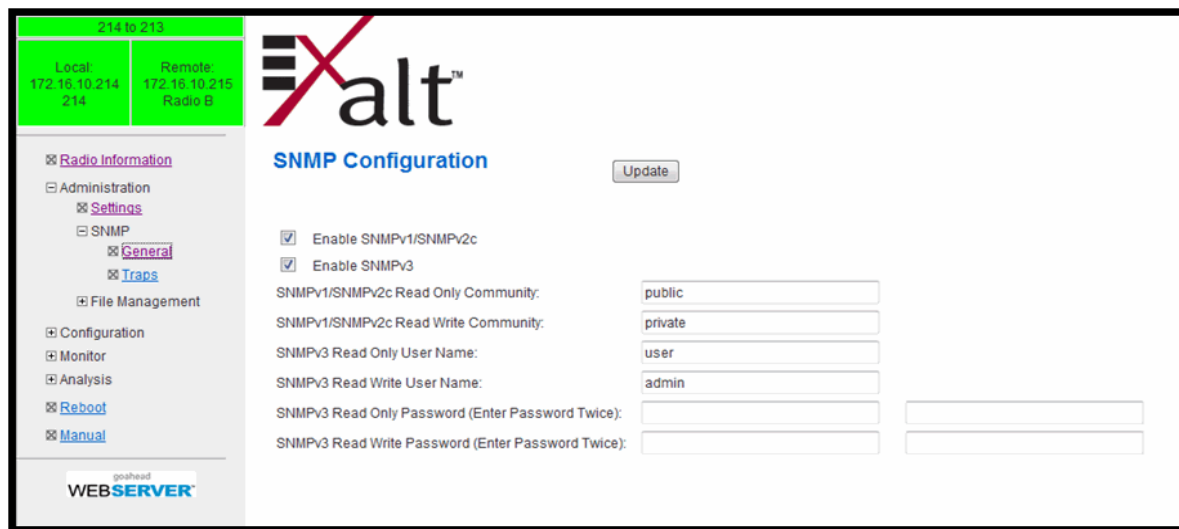

Figure 25 SNMP Configuration page

One feature of the SNMP implementation is that system configuration changes do not take effect using the SET command. Instead, groups of configuration settings can be preconfigured for global change, and a single ‘Save’ (Commit) command implements all changes.

When some parameters are changed, a link may drop and/or management control lost. MIB files allow many parameters to be set at once, allowing only a temporarily dropped link or management control issue. The opposite end radio can be quickly reconfigured, with little downtime for the link and management control. The save (Commit) command is similar to the Update button.

Dropped links or management control issues do not occur with every parameter change. Many configuration changes do not impact traffic or management access.

EX-i Series GigE (FDD) radios utilize SNMPv3, a high security version of SNMP, to ensure secure access to and storing of management data. The SNMPv3 security string matches the admin and user passwords. Passwords must be eight characters or longer.

The SNMP MIBs are organized similar to the GUI. Become familiar with the GUI before using the SNMP function.

SNMP v1/v2c/v3 Support Options

Enable the SNMPv1/v2c options to allow entering read and read/write community strings.



Note: Users are encouraged to avoid enabling SNMPv1/V2c support due to known security loopholes in these protocols.

Enable the SNMPv3 options to allow entering read and read/write user names and passwords. These entries are de-coupled from the standard radio user names and passwords. SNMPv3 provides full management security.

SNMP Traps

SNMP traps alert the central network management system with important issues about the radio system. Trap filters are set on the Traps Configuration page (Figure 26). Not all EX-i Series GigE (FDD) radios support SNMP traps. Consult the release notes for more information and enable the desired trap version by clicking the box to the left of the version of trap(s). Ethernet port(s) that are assigned to Management (per the setting on the [Ethernet Interface Configuration Page](#)) must be connected to the network to allow trap information to reach the designated IP address. In a bridged network, this may not require special network settings. In a routed network, the connected router must have a defined path for the IP address.

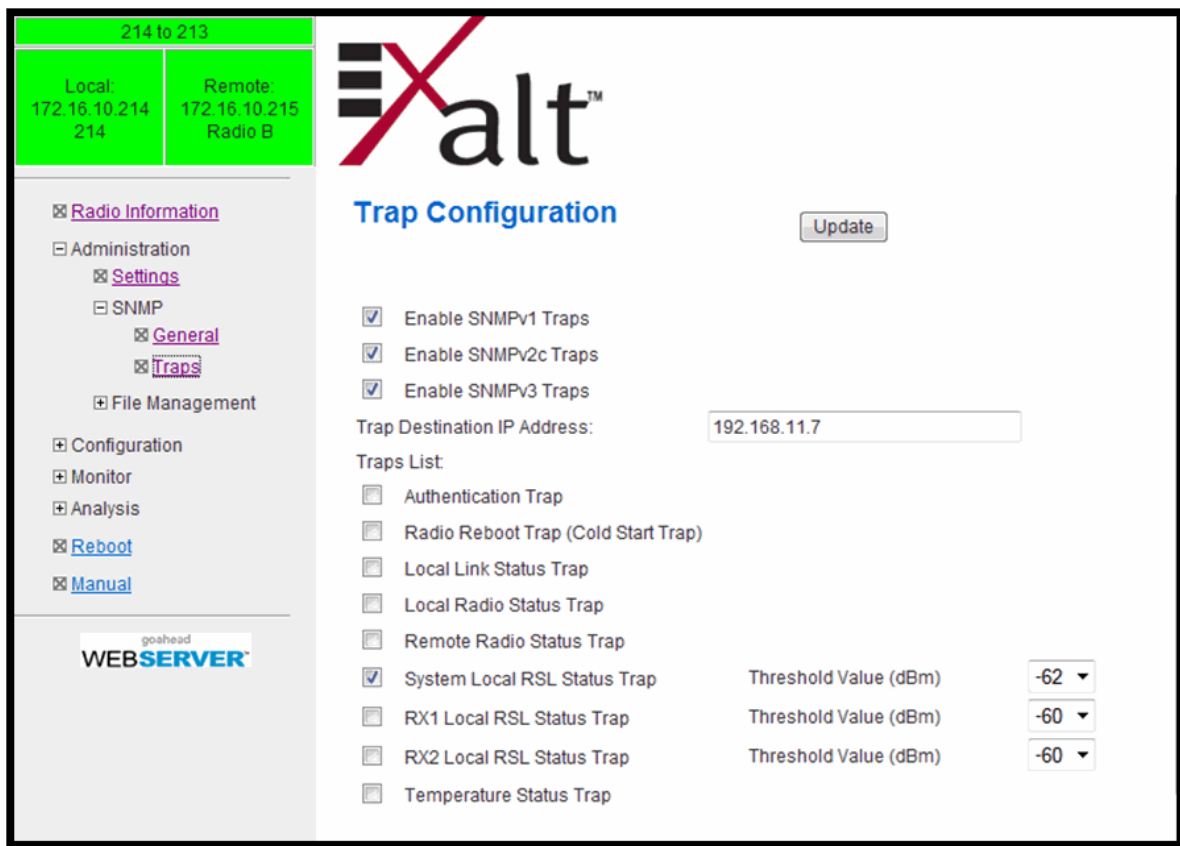

Figure 26 Trap Configuration page



Note: The **Update** button must be clicked to save any changes to this page.

The following traps are available:

- **Authentication Trap:** This is an SNMP standard trap when password information for SNMP is incorrect. This can help identify unwanted intrusions into the management system and for diagnosis of SNMP issues for valid users.

- **Radio Reboot Trap:** This trap is sent after any radio reboot to inform the manager of the reboot status.
- **Local Link Status Trap:** This trap is sent when Link is in an errored state (equivalent to the Link LED on the radio front panel or the Link status bar in the upper-left of the Exalt GUI window). Independent traps can be set for the main and diversity links (when configured for space diversity).
- **Local Radio Status Trap:** This trap is sent when Status is in an errored state (equivalent to the Status LED on the front panel or the radio status box in the upper-left of the Exalt GUI window).
- **Remote Radio Status Trap:** This trap is sent when Status for the remote radio is in an errored state (equivalent to the Status LED on the front panel or the radio status box in the upper-left of the Exalt GUI window).
- **System/RX1/RX2 Local RSL Status Trap:** These traps are sent when the local RSL drops below the value set in the Threshold Value (dBm) field. Buffers are provided so that continuous traps are not sent if the RSL is bouncing near the set threshold value. These traps are reset only if the RSL rises to 3dBm above the set threshold value and then drops below that value. Exalt recommends that these trap be set to a value 5dBm or 10dBm above the threshold as a warning that the system has faded and may be approaching an outage. Independent traps can be set for the System, RX1, and RX2 links.
- **Temperature Status Trap:** This trap is sent when the internal temperature reaches the warning point. This conveys that the external temperature control is in a fault state. Buffers are applied to this trap to avoid multiple traps when the temperature remains near the warning point.

File Transfer Page

This page allows the administrator to upload and download files to and from the radio. Two types of files can be uploaded: configuration, and radio firmware. **When uploading Configuration Files, current configuration parameters are immediately overwritten, and the unit automatically reboots.** When uploading radio firmware files, the file is placed into reserve memory space. After the new radio firmware file uploads, use the File Activation page to enable the files (see [File Activation Page](#)).

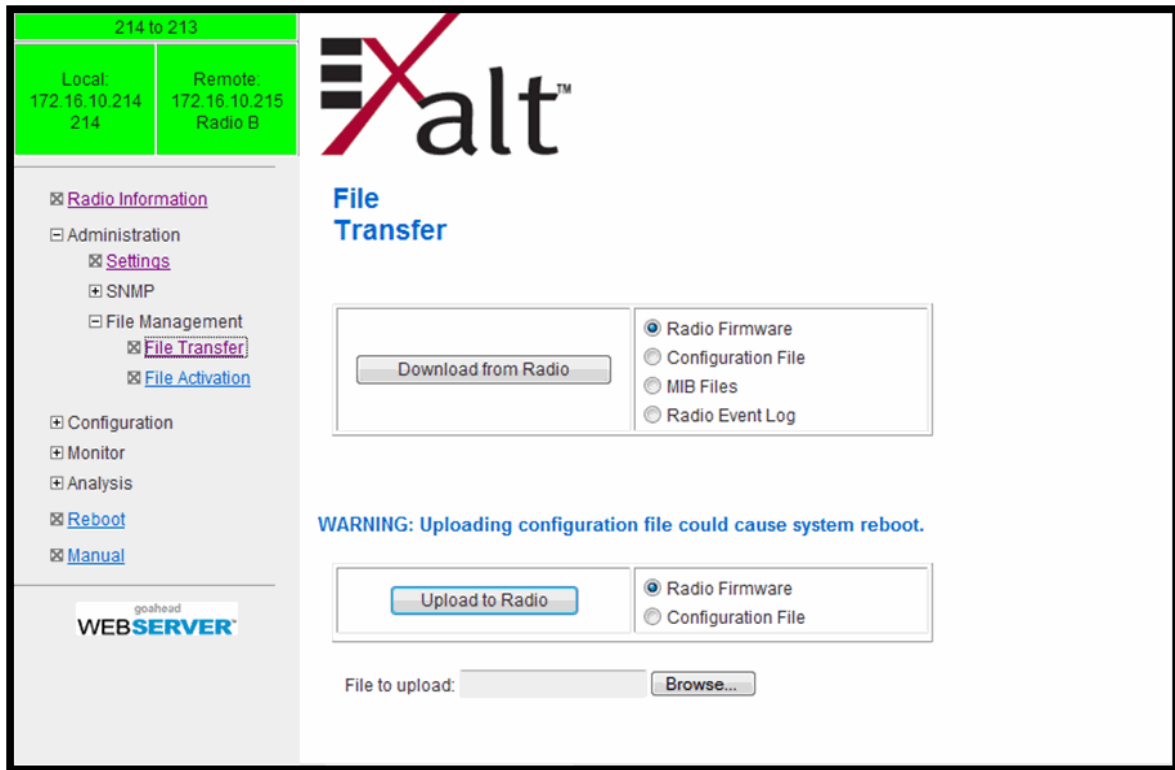

Figure 27 File Transfer page

Up to four types of files can be downloaded: radio firmware, configuration, MIB, and event log. The MIB file refers to the Management Information Base related to the Simple Network Management Protocol (SNMP) function, and is only available on models which support SNMP. See [Simple Network Management Protocol \(SNMP\) Configuration](#) for more information.



Note: Check the [File Activation Page](#) before uploading radio firmware files. New file uploads overwrite the secondary file location. If important files reside in the primary or secondary file location, download them before uploading the new files. Only the active radio firmware file can be downloaded. Therefore, to download the reserve file, it must first be activated (using the Swap button).

Use the following steps to download a file.

- 1 Select the type of file to download (configuration, radio firmware, MIB or event log).
- 2 Click the Download button and wait for the radio to prepare the file for download.
For some file downloads, a second page/link appears (Figure 28).
- 3 Left-click the link on the page to download the file to a desired location.

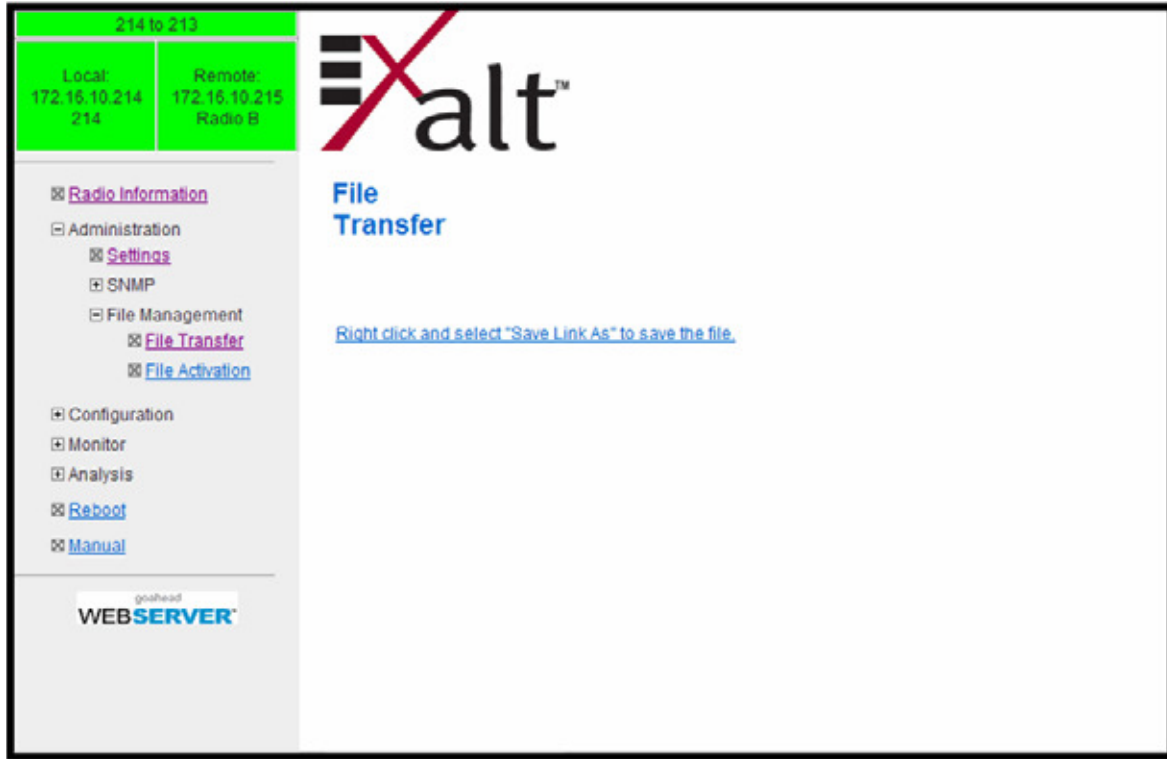

Figure 28 File Transfer page—download file link

File download and upload is useful when configuring several radios with similar settings. A copy of the configuration file can also help restore radio settings. In addition, a copy of the Exalt default configuration file is helpful to restore the radio to factory settings.



Note: Do not change the name of any download file. The configuration file must be named config.nv. To keep track of multiple configuration files, use a folder naming system or temporarily rename the file, however, it must be named config.nv before it can be uploaded to a radio. Never change radio firmware file names under any circumstances.

If copying the same configuration file into multiple radios, take as some parameters will match and that may be undesirable. However, it may be easier to change just a subset of parameters rather than every parameter. The following parameters can cause problems or confusion if they match at each of a link:

- Radio Name
- IP Address
- IP Subnet Mask
- Default Gateway

The following parameters can match at both ends of the link:

- Link Name
- Link Security Key (although each link should be different)
- Admin and User passwords
- Bandwidth
- Ethernet configurations

File Activation Page

Use this page to move stored or uploaded files for use on the radio. The page indicates which file is currently in use, and which file is available for use. Click the Swap button to place the file in the Alternative File column into the active state and move the file in the Current File column to the Alternative File column.

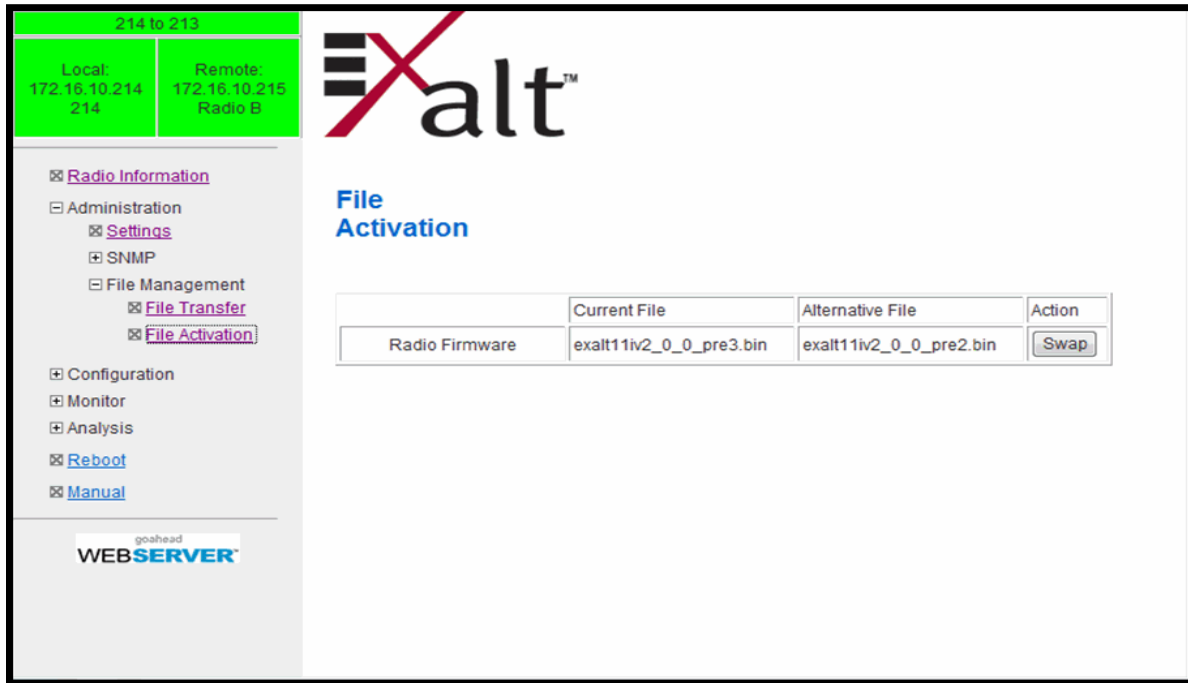

The screenshot shows the Exalt web interface. At the top left, there are two green boxes: 'Local: 172.16.10.214 214' and 'Remote: 172.16.10.215 Radio B'. The Exalt logo is prominently displayed. Below the logo, the 'File Activation' section is visible. It contains a table with the following data:

	Current File	Alternative File	Action
Radio Firmware	exalt11iv2_0_0_pre3.bin	exalt11iv2_0_0_pre2.bin	Swap

Figure 29 File Activation page



Note: In all cases, the radio reboots after a new file is selected using the Swap function. This places the radio out of service for a short time.

System Configuration Page

This page contains several critical system parameters.

	Current Value	New Value
Diplexer/Filter Configuration	125	125
Radio Transmit Power (dBm)	20	20
Bandwidth (MHz)	30	30
ACM Mode	Enable	Enable
ACM Policy	Conservative	Conservative
ACM Base Modulation	Mode 3 (64QAM)	Mode 3 (64QAM)
ACM Target Modulation	Mode 5 (256QAM)	Mode 5 (256QAM) Allocation
TX Frequency (kHz)	10800000	<input type="text"/> (10715000 - 10885000)
RX Frequency (kHz)	11300000	<input type="text"/> (11215000 - 11385000)
TR Spacing (MHz)	500.	
Receiver Configuration	Enable Errorless Switching	Enable Errorless Switching
Rx RSL Differential	5.0	Rx RSL Differential (dB): <input type="text"/>
RSL Monitor	RX1	RX1
ATPC	Disable -80.0	ATPC Options: <input checked="" type="radio"/> Disable <input type="radio"/> Enable RSL Threshold (dBm): <input type="text"/>
External Alarm Input 1	Alarm When Closed	Alarm When Closed
External Alarm Input 2	Alarm When Closed	Alarm When Closed

Figure 30 System Configuration page

Most entries on this page are self-explanatory. The following lists unique or important parameters.

- Set the Diplexer/Filter Configuration parameter by selecting the diplexer mounted on the rear panel that matches the label shown right-side-up on the diplexer. Select OTHER if using a custom diplexer assembly or a diplexer not in the list. If using OTHER, an independent Tx/Rx frequency input is required.

On some models, when OTHER is selected an additional field is provided to program the insertion loss of the diplexer. This parameter can be found with the paperwork supplied with the original diplexer packaging.

- Set the Radio Transmit Power (dBm) parameter to the desired level. The professional installer sets this value or dictates the value of this setting to the system administrator following the system

design and local regulations. In many cases, this value must be set to a proper value to comply with legal restrictions. Improper values can result in liability to the user and/or installer.



Note: Changing Radio Transmit Power may temporarily interrupt traffic. Small changes in output power do not normally interrupt traffic, but larger changes may.

- Do not adjust the Radio Transmit Power parameter to a value higher than is legally allowed.
- Do not adjust the Radio Transmit Power parameter lower than the link budget and fade margin can afford.
- Set the Bandwidth (MHz) parameter to the value assigned to the radio license. The value of this is determined in the design/engineering stage. The Bandwidth parameter must also match at both ends of the link. In conjunction with the Mode parameter, the Bandwidth parameter directly relates to the capacity and the number of TDM circuits supported. The transmitter and receiver bandwidth are modified using this parameter, making it critical that it be set with respect to the local RF noise and interference profile, and/or in relation to any multi-link network design.



Note: Changing Bandwidth will temporarily interrupt traffic. The Bandwidth parameter must match at each end. Adjust the far-end radio first, and then the near-end radio. Changing Bandwidth changes the radio's threshold. A narrower bandwidth has better threshold performance and improved interference immunity, therefore if changing to a wider bandwidth, there is an opportunity that the link may be lost and unrecoverable through GUI control. Check the available fade margin to determine if the impact to threshold and increased bandwidth is acceptable to maintain the link and the desired performance. If the link is lost due to increasing the Bandwidth parameter, travel to the radio location(s) may be required to reset the value.

- Adaptive Coded Modulation (ACM) allows the radio link to adaptively adjust the modulation used to create the link, depending on multipath or fading conditions. The link must be licensed to allow this setting, specifying the legal maximum and minimum modulation settings. When enabled, select the Base (minimum) and Target (maximum) modulation settings. ACM must be configured on both sides of the link. The Base and Target settings must match on both ends.

There are two pre-programmed ACM policies:

- Conservative switches down to the next modulation when the RSL is within 2dB of the current threshold, and switches up to the next modulation when at least a 5dB RSL margin exists above the next threshold. This slows and steadies the transition between modulations.
- Aggressive switches down to the next modulation when the RSL is within 1dB of the current threshold (which is usually exhibiting some low-level BER), and switches up to the next modulation when at least 3dB RSL margin exists above the next threshold. This increases the transition between modulations, resulting in the highest capacity at all times. However, this can increase BER and cause erratic changes to throughput.



Notes:

- Changing Mode/Modulation will temporarily interrupt traffic. The Mode/Modulation setting must match at each end. Adjust the far-end radio first, and then the near-end radio. Changing Mode/Modulation changes the radio's threshold, carrier-to-interference ratio, and also may have impact on the Radio Transmit Power. A lower mode has better threshold performance and carrier-to-interference ratio, and in some cases, higher output power, therefore if changing to a higher mode (for example, from Mode 1 (QPSK) to Mode 2 (16QAM)), there is an opportunity that the link may be lost and unrecoverable through GUI control. Check the available fade margin and interference profile, and determine if the impact to RF performance is sufficient to maintain the link and desired performance. If the link is lost due to increasing the Mode parameter, travel to the radio location(s) may be required to reset the value.
 - As modulation is reduced, the capacity of the system is also reduced. If the radio system is carrying TDM traffic (such as OC3, DS3, T1, E1), some interfaces that may be desired when the link is running at full-capacity (target modulation) may not be able to be supported. The [Allocation Page](#) allows configuration of TDM and Ethernet traffic as the radio changes modulation when ACM is enabled.
 - Changing the ACM settings can cause a temporary link outage. To minimize issues, change the far-end of the radio link first, and then adjust the near-end to match.
 - If Adaptive Modulation is disabled, both ends of the radio link require matching settings equivalent to the licensed modulation of the link.
-
- Set the TX Frequency (GHz) and RX Frequency (GHz) parameters to the licensed center frequencies. The frequencies must match the same pair at both ends of the link, but in opposite Tx/Rx orientation.
 - The Transmitter/Receiver (TR) frequency spacing is automatically determined based on the frequency settings. This is reported to verify the intended frequency settings, as a confirmation to proper input.



Note: Changing RF Frequency will temporarily interrupt traffic. The RF Frequency parameter pair must be opposite at each end. Adjust the far-end radio first, and then the near-end radio. If the link is lost due to changing the RF Frequency parameter, travel to the radio location(s) may be required to reset the value.

-
- Set the Receiver Configuration parameter to **RX1 Only** for typical (1+0) links.
 - Enable RX1 Only/Enable RX2 Only (two receiver models only) allows manual selection of the receiver to isolate the receiver which is helpful for troubleshooting.
 - Enable Errorless Switching (primarily used for space diversity configurations) provides errorless switching between the two internal receivers or when deployed in a 1 + 1 MHS configuration, between the receivers of each terminal. This selection can also be used for receiver protection configurations to errorlessly switch between the two internal receivers if issues should arise.
 - Enable Linear Combining (primarily used for receiver protection configurations) provides additional system gain, however errorless switching may not occur during receiver switching events. This selection can also be used for space diversity configurations where the added system gain is more beneficial to the application than errorless switching. When linear

combining is enabled independent receiver performance data is not available on the [Performance Page](#).

- Enable XPIC/Vertical Enable XPIC/Horizontal implement these parameters in a cross-pole interference cancellation configuration. In this configuration, one terminal at one end of the link must have Enable XPIC/Vertical enabled, while the other terminal at that end must have Enable XPIC/Horizontal enabled. XPIC provides a means to connect two parallel links across a cross-polarized antenna to achieve higher capacity than one independent link.
- RX RSL Differential parameter (for space diversity configurations) if transmission system specifications are different from one another for the two connected antennas (such as in a Space Diversity configuration with different size antennas for each receiver), enter the anticipated RSL delta in this field. The radio provides alarm conditions when RSL is not meeting anticipated levels. If this alarm is not desired, click the disable button.
- RSL Monitor parameter controls which RSL is presented at the front-panel RSL voltage port. This can be selected to either RX1 or RX2 (for two-receiver models), or COMBINED for the highest value of either (for two-receiver models). It is recommended that you select the independent port of interest if using this port for antenna alignment.
- Enable the Automatic Transmit Power Control (ATPC) parameter (if authorized) to increase transmitter power if the RSL drops below the programmed value. The maximum output power for ATPC is either 10dB or the maximum power capable from the radio (including installed license keys). Use the ATPC timers to ensure that the radio meets regulatory requirements. Timer information is provided in the [ATPC Statistics Page](#) under the Monitor section. Also, the diagnostics chart for RSL illustrates the ATPC threshold level to accomplish a proper diagnosis of the RSL relative to ATPC.
- The External Alarm Inputs parameter can be ignored unless connecting external alarm sources to the radio to monitor the status of these external alarms through the radio management system (see [Interface Connections](#)).

Allocation Page

This page allows the administrator to determine how the TDM interfaces (T1, E1, DS3, OC3, etc.) and remaining Ethernet capacity are allocated when ACM is enabled. Since ACM changes the capacity of the radio, it is critical to determine how those changes impact the traffic carried over the link.

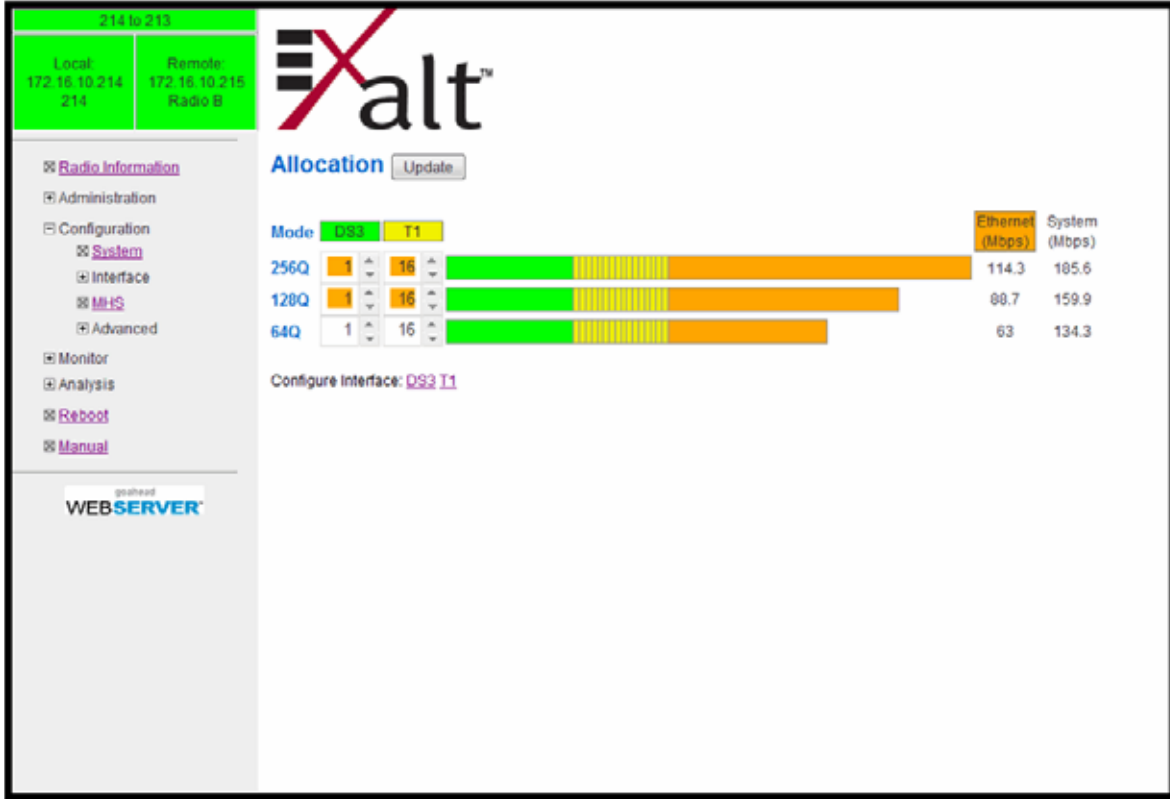

Figure 31 Allocation page

The left side of the chart shows the different modulations available for ACM. Columns display under different TDM type column headings (such as DS3 and T1 shown). Selection of how many of each interface is determined by the selections for each modulation.

The bar graph color codes allocation of the TDM interfaces, showing each interface and the relative capacity it is occupying. Orange indicates remaining Ethernet capacity for that modulation.

At the right of the graph, the full-duplex Ethernet capacity displays in Mbps. The total full-duplex capacity displays in the System column.

It may be necessary to configure the TDM interfaces. A link displays under the graph to ease configuring any TDM interface.



Note: The allocation of TDM interfaces only defines HOW MANY channels are allocated; it does not define WHICH physical ports are allocated. Priority of port assignments is controlled on the [Cross Connect \(X Connect\) Page](#). If a TDM allocation change occurs between modulations, the priority defined in Cross-Connect determines which ports are added or dropped.

Ethernet Interface Configuration Page

This page allows the administrator to set the muting, alarm, and duplex settings of the ETH1, ETH2, and ETH3 connections, and allows determination of the management information for in-band (carried over the air and available from both Ethernet connectors on either end of the link) or out-of-band (not carried over the air and only available from the local PoE connector).

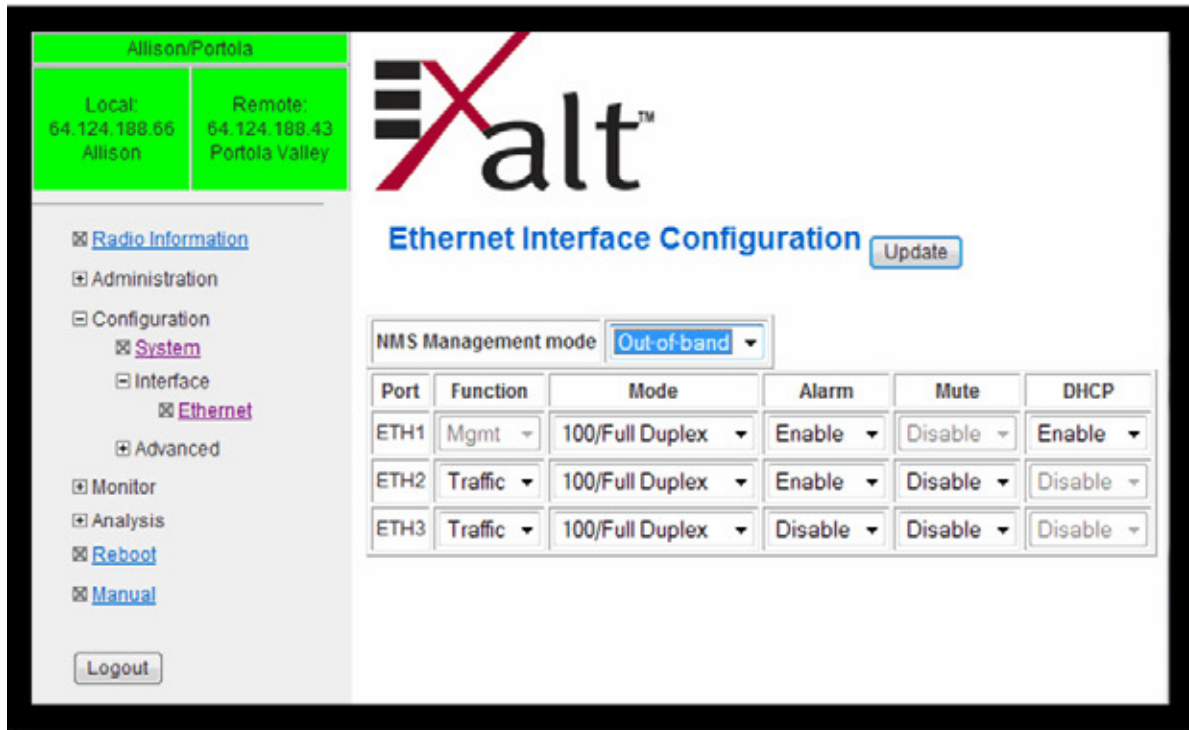

Figure 32 Ethernet Interface Configuration page

The management function of each port can be assigned as:

- In-Band Management – All ports can pass traffic over the link and also have access to management of the radio. Management traffic is carried over the link.
- Out-of-band Management – Each port can be set to either Traffic or Management. All ports set to traffic are connected together and pass traffic over the link, and all ports set to management are connected together, but separated from the traffic and do not go over the link. Management is not available over the wireless link in this configuration (unless externally switched or routed to a Traffic port).
- Legacy Management (EX-6i-DS3-GigE only) – ports can be selected as Traffic, Management, or Traffic+Management. In this configuration, all ports set to Traffic are NOT connected together, but each individual port has the ability to send and receive traffic over the link. Too, all ports set to Management are NOT connected together, but each individual port can send and receive management information to the connected radio.

Notes:



- The Legacy Management setting is not recommended; it supports users running v1.1 firmware or lower so that upgrades do not cause network loops or other issues. If your configuration has a mixture of both independent and mixed function interfaces, change these settings to either In-Band or Out-of-band Management and make the appropriate external network accommodations to support this new setting. Contact Exalt support for details.
- The radio requires that a minimum of one interface have access to management (either by setting to Mgmt or Traffic+Mgmt).
- If VLAN is enabled, VLAN IDs assigned to separate interfaces must match the topology of the Function setting on this page. For example, any port with access to Management must include the Management VLAN ID when configuring VLANs.

-
- Mode allows for specific negotiation settings on each interface. Exalt recommends setting these interfaces to Auto Negotiation. However, there may be cases where connected equipment performance can be improved by using a specific negotiation type.
 - Alarm determines if the radio goes into alarm when the interface connection is disconnected or not sensed. Enable alarms on in-use interfaces. Unused interfaces should have alarms disabled.
 - Mute when enabled mutes the interface on link outage. This accommodates connected equipment that requires loss of connection sense to enact network alarms. For example, Spanning Tree Protocol can be enabled on loss of connection.



Note: The radio prohibits setting all interfaces to Mute, as this does not allow management access to the radio. Do not mute the port with access to management.

T1/E1 Configuration Pages

These pages allow the administrator to selectively configure the T1 or E1 circuits, one at a time. For enabled T1/E1 circuits, additional configuration, including loopback functions, are available. Disable the unused T1 or E1 so that the alarms are turned off and more throughput is allocated to the Ethernet interface. Every enabled T1 or E1 input, even if there is no T1 or E1 signal present, reduces the aggregate throughput of the Ethernet interface by roughly 3Mbps (for T1) or 4Mbps (for E1).

Click the Set to T1 or Set to E1 button to toggle the page between T1 and E1. This will interrupt traffic. T1/E1 mode self-coordinates across the link if the link is active. This means that it only needs to be set while connected at one end. In addition, enabling and disabling T1/E1 circuits also self-coordinates across the link if the link is active. If a link is not active and T1/E1 enabling is a mismatch when a link is first created, the Tx-Low radio for T1/E1 enabling supersedes the settings on the Tx-High configuration, and changes the settings on Tx-High.



Note: Certain combinations of the Mode/Modulation and Bandwidth parameter settings limit the number of T1/E1 circuits that can be carried by the radio. In these cases, certain fields on the T1/E1 Interface Configuration pages are not available, starting with the highest port number. For example, for a 4x T1/E1 radio version, if only three (3) circuits can be carried, port 4 is not viable for configuration and is disabled. If only two circuits can be carried, both ports 3 and 4 are not available. Increasing the Mode/Modulation parameter and/or increasing the Bandwidth parameter results in an increase in the supported number of T1/E1 circuits. This is because the T1/E1 traffic is given priority over Ethernet traffic.

T1 Interface Configuration Page

This page allows the administrator to enable/disable the alarm for each individual T1 channel, set the Line Build Out (LBO), Line Code (either AMI or B8ZS), and AIS enabling/disabling for each input. If enabled, the radio places an AIS code on the output of the associated interface if and when the link fails or when there is no T1 signal available from the far end to provide the user at the local end. Loopback controls are also provided (see [Loopback](#)).

Carefully consider alarm enabling relative to the number of ports allocated (see [Allocation Page](#)) and their relative priority (see [Cross Connect \(X Connect\) Page](#)).

If alarms are enabled, a red alarm occurs when a port is allocated and no T1 signal is detected. A yellow alarm occurs when a port is *not* allocated and a T1 signal is detected. Disable alarms for unallocated ports or ports with traffic connected but that are not in use.

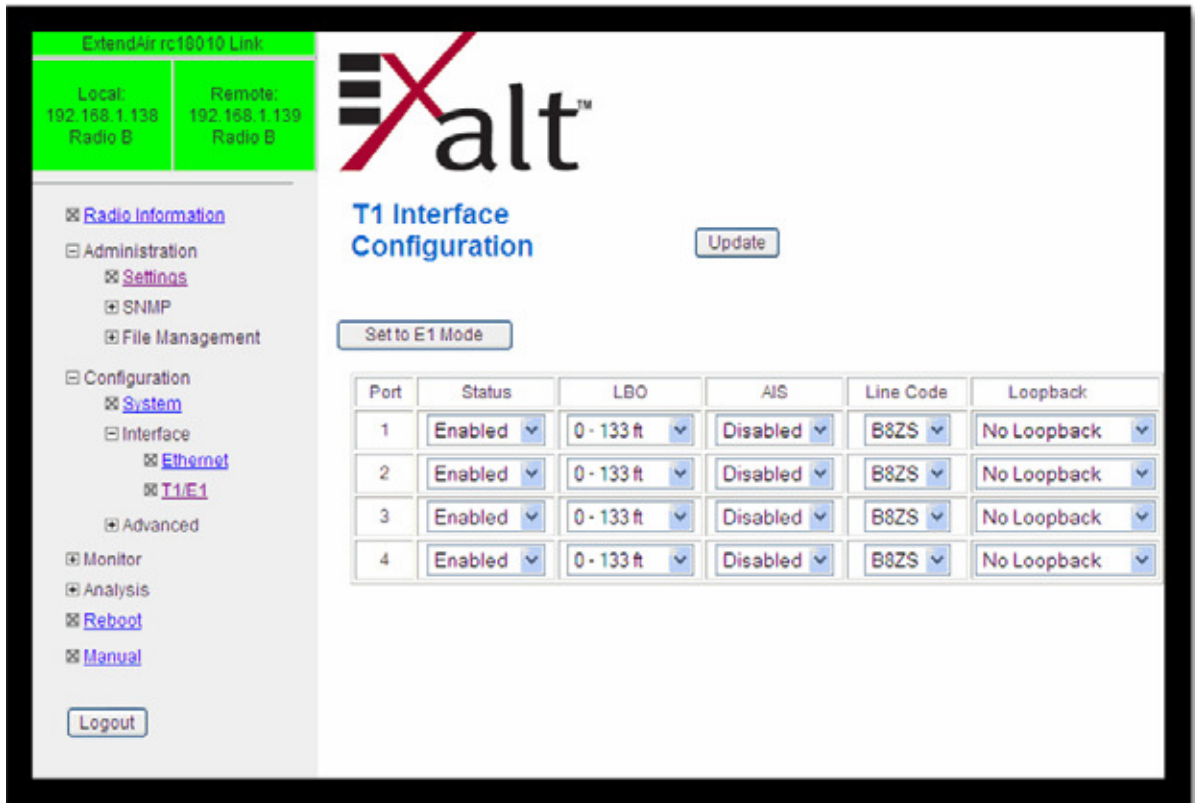

Figure 33 T1 Interface Configuration page

E1, DS3, and OC3 Configuration Pages

For all other TDM configurations (E1, DS3, and OC3), configuration is nearly identical to the T1 configuration. However, the LBO and AIS settings must match the interface standard. For some DS3 interface units, additional configuration is provided to select the ground configurations of the DS3 ports (grounded or not grounded).

When setting Alarms, review the Allocation and X-Connect settings relative to how many and which specific ports will be active for different ACM states. See the [T1 Interface Configuration Page](#) section for advice on alarm settings.

E1 Interface Configuration Page

This page (Figure 34) allows the administrator to enable/disable each individual E1 channel. The AIS can also be enabled and disabled for each input. If enabled, the radio places an AIS code on the output of the associated interface if and when the link fails or when there is no E1 signal available from the far end to provide the user at the local end. Loopback controls are also provided (see T1/E1 Loopback).

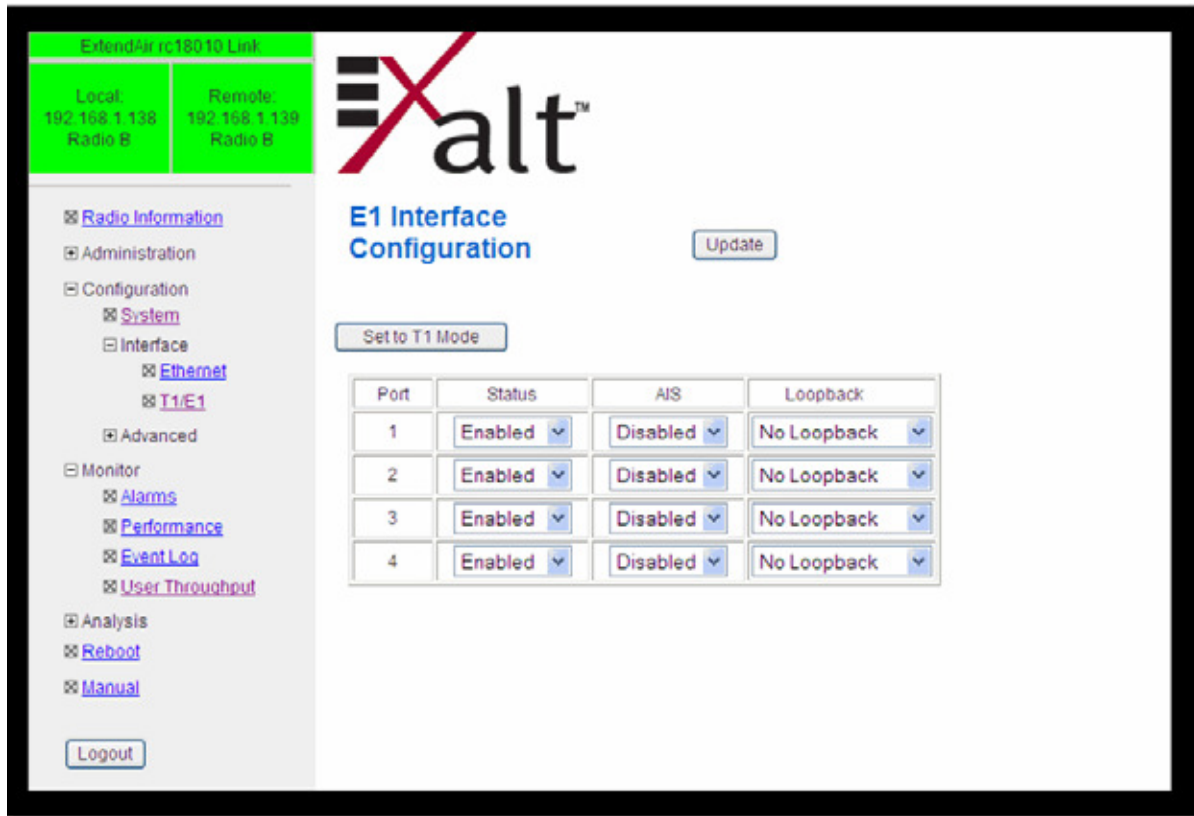

Figure 34 E1 Interface Configuration page

DS3 and OC3 Interface Configuration Pages

These page allow the administrator to configure the DS3/OC3 interface. These interfaces should be disabled if there is no DS3/OC3 connected. The associated throughput is then allocated to T1/E1 and/or Ethernet.



Figure 35 DS3 Interface Configuration page

The Line Build Out (LBO) can be set for this interface. Also, the Automatic Insertion Signal (AIS) can be disabled, or set to an All-Ones (AIS) or All-Zeros (AOS) signal type. In addition, some loopback functions are provided as described in [Loopback](#).

Figure 36 shows the OC3 Configuration page.

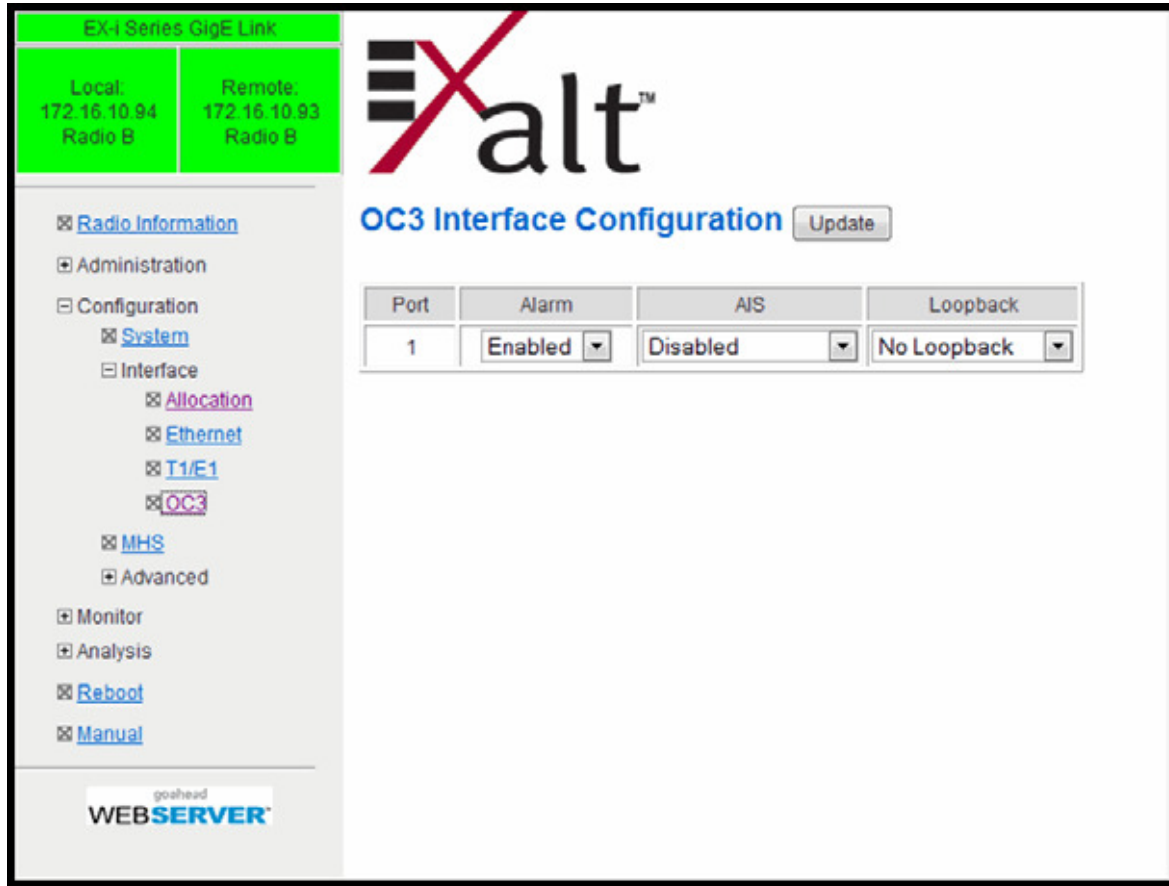

Figure 36 OC3 Configuration page

Loopback

Loopback is provided for any enabled TDM port. The choices are:

- No Loopback (default)
- External (local)
- External (remote)

All loopback configurations control the loop at the Line Interface integrated circuit, which is the device wired directly to the front panel ports.

External loopback modes are used in conjunction with an external test source. The designation of 'local' or 'remote' refers to where the loopback is occurring relative to the location where the loopback is implemented. That is, on the radio being accessed, if External (remote) is selected, this loops the signal back at the remote radio interface back towards the local radio. Likewise, if External (local) is selected, the signal loops back at the local interface towards the remote radio (Figure 37 and Figure 38).

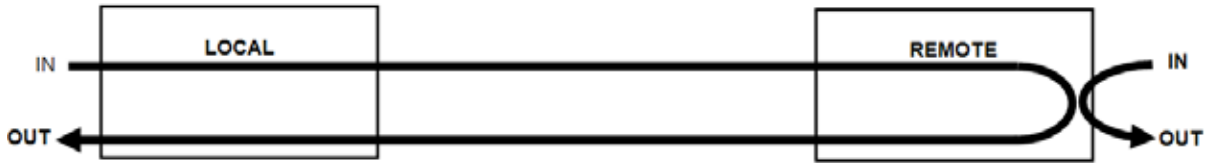

Figure 37 External (remote) loopback

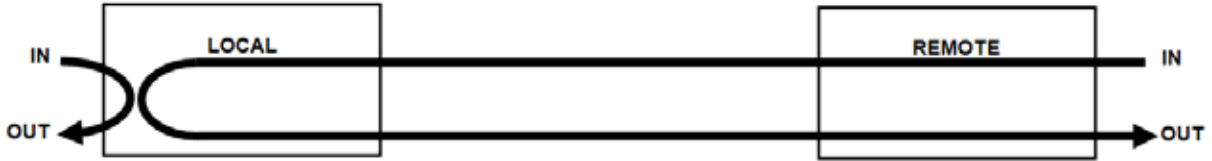

Figure 38 External (local) loopback



Note: For DS3 interfaces, the implementation is slightly different than shown in Figure 37 and Figure 38. The remote loopback will send traffic from the local In to the local Out as shown, but the far-end In-to-Out connection is not made. The local loopback will loop the local In-to-Out, but does not create the over-the-air loopback shown in the opposite direction.

When a local TDM port is configured for External (remote) loopback, it is the same as configuring the remote radio for External (local) loopback.

MHS Configuration Page

This page provides the capability to configure the system for Monitored Hot Standby (MHS). These configurations implement a second terminal at one or both ends of the link for hardware protection and/or path protection. MHS cannot be configured when Adaptive Coded Modulation (ACM) is enabled.

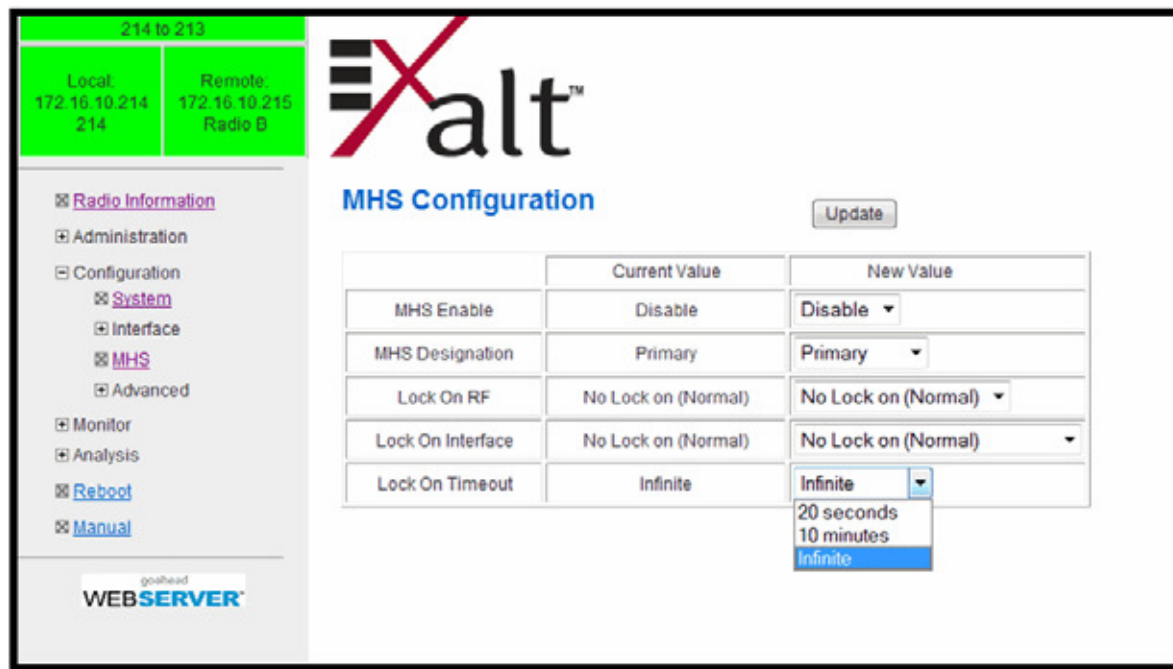

Figure 39 MHS Configuration page

For MHS, the two terminals at one end of the link are connected to the same antenna. One terminal is in a 'standby' configuration, and is automatically selected if issues are identified with the other terminal. Special MHS protection cabling (sold separately) is required to connect the PROT ports of the terminals, along with a standard straight-wired CAT5 cable for the EXP ports of the terminals.

One terminal at the endpoint is designated as primary and the other secondary. For MHS configurations, generally the primary terminal is connected to the on the lower-loss side of the MHS receiver coupler.

The Lock On features are provided for troubleshooting. The default setting is No Lock on (Normal), to enable protection. When swapping cables or hardware on one of the terminals or for troubleshooting, set the primary or secondary radio to Lock On and set the amount of time.

MHS switching can be implemented in a 'hybrid' fashion instead of selecting one complete terminal. In this configuration the interface circuitry of one terminal may be in use, while the RF circuitry of the other terminal is in use. This hybrid implementation yields faster MHS switching and requires no user intervention.

VLAN Configuration Page

VLAN is disabled as the default setting for Exalt radios. The Exalt radios still pass VLAN and non-VLAN traffic across the link, but do not examine the VLAN traffic or act upon it. Enable VLAN using the Exalt GUI for expanded VLAN support.

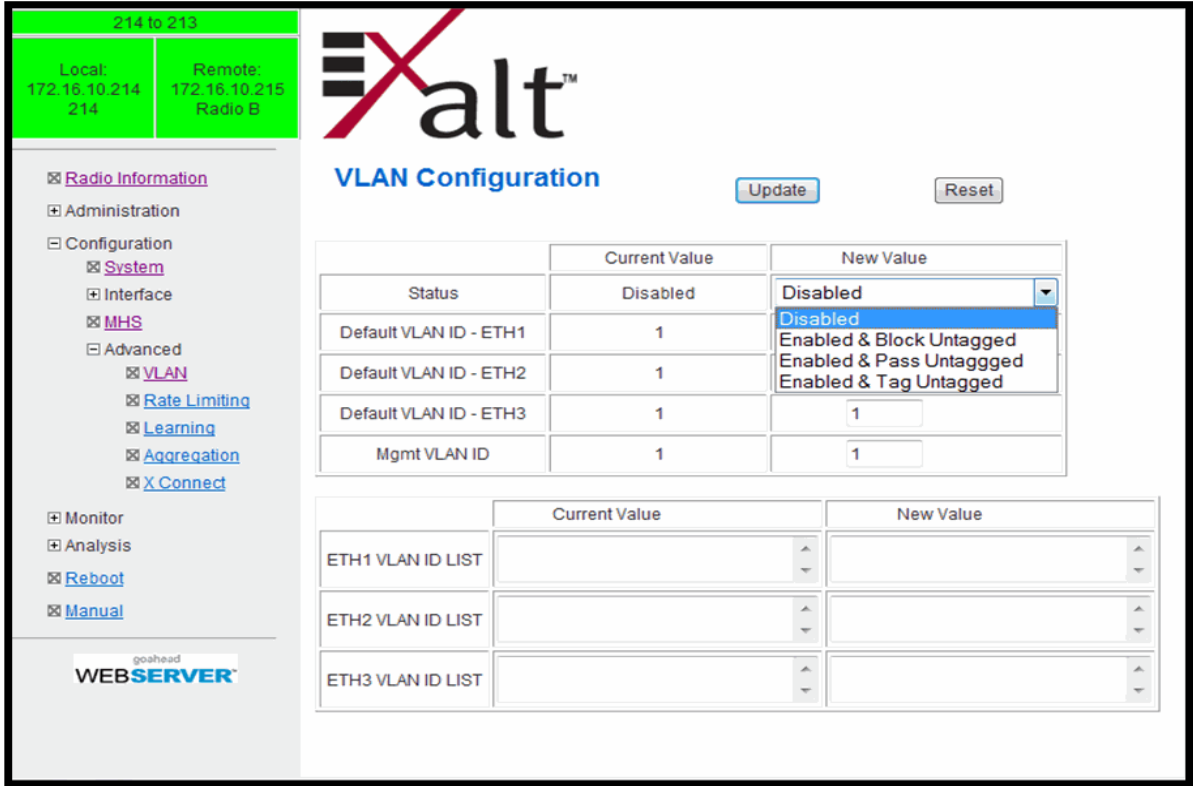

Figure 40 VLAN Configuration page

The top table allows the configuration of the default VLAN assigned to each interface and the VLAN used for radio management. VLAN may be enabled in one of three different ways:

- Where programmed VLANs from the bottom table are passed and all other traffic is blocked.
- Where programmed VLANs from the bottom table are passed, untagged traffic is passed, and VLANs not in the table are blocked.
- Where programmed VLANs from the bottom table are passed, untagged traffic is tagged with the default VLAN assigned to the interface, and VLANs not in the table are blocked.



Note: Once a management VLAN is configured or modified and the Update button clicked, the management connection will likely be lost. The management connection to the radio must follow the configuration to the assigned VLAN. After configuring and enabling the management VLAN on the radio, reconfigure your network's management access to match the settings on the radio.

In the bottom table, create a list of VLANs to pass on the selected interface. This list can be in the form of individual VLAN IDs, separated by commas, and/or ranges of VLAN IDs. (for example, 105, 109, 111–145, 156, 254–275).

The “new value” list matches the “current value” list to allow easy editing by subtracting, adding, or otherwise modifying the list before clicking Update.



Note: The VLAN IDs that are assigned to any interface should support the Function settings on each interface as defined on the [Ethernet Interface Configuration Page](#).

VLAN configurations are maintained even when VLAN is disabled. That is, the VLANs can be configured and the configuration saved, even though they are not active until VLAN is enabled. Use the following methods to restore the management connection if a mistake was made assigning the management VLAN and access cannot be restored:

- Reset the radio to the critical factory defaults (see [Reset to Critical Factory Settings](#)), or
- Connect to the Console port using a serial interface and the CLI, as described in [Command Line Interface \(CLI\)](#), and reconfigure the VLAN settings.

Ethernet Rate Limiting Page

This page enables radio Ethernet port rate limiting. Enable this to limit the output information rate to at or below downstream networking equipment capabilities. The default setting is disabled. The rate is in Mbps or kbps, as specified. Use the Update button to save changes.

Port	Current Value	New Value
ETH1	Disable 64 KBits	Rate Limit Options: Disable Select Rate Type: <input checked="" type="radio"/> KBit/s <input type="radio"/> MBit/s Select Rate: <input type="text"/>
ETH2	Disable 64 KBits	Rate Limit Options: Disable Select Rate Type: <input checked="" type="radio"/> KBit/s <input type="radio"/> MBit/s Select Rate: <input type="text"/>
ETH3	Disable 64 KBits	Rate Limit Options: Disable Select Rate Type: <input checked="" type="radio"/> KBit/s <input type="radio"/> MBit/s Select Rate: <input type="text"/>

Figure 41 Ethernet Rate Limiting page

Ethernet Learning Page

This page allows enabling or disabling Media Access Control (MAC) learning. This is a universal setting for all Ethernet interfaces.



Figure 42 Ethernet Learning page

Some network configurations may broadcast the same MAC Source address on multiple interfaces, and if learning is enabled, data transport errors can result. For these cases, disable learning to improve networking functionality. However, disabling learning can cause unnecessary traffic to occupy the interfaces and the radio link, and lead to lower throughput performance.

Syslog Configuration Page

Syslog serves as a remote means to receive event log messages (configuration and alarm state changes) for network management and/or record keeping.

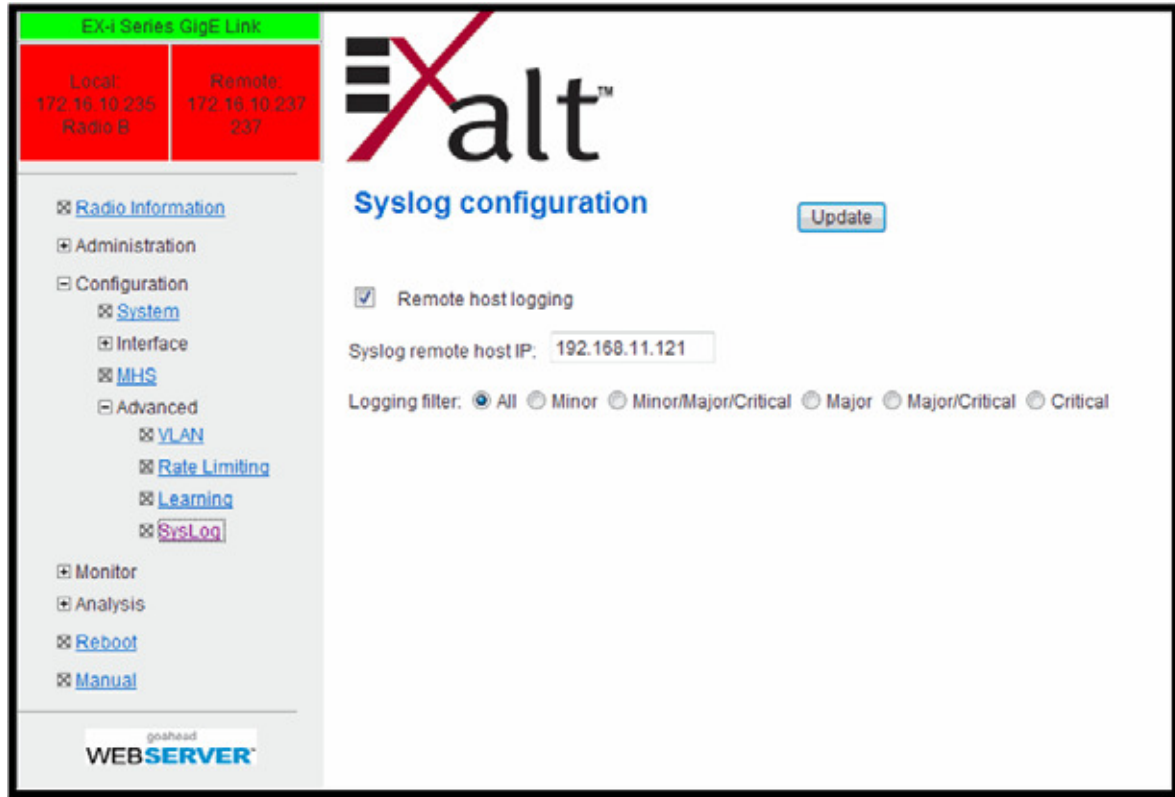

Figure 43 Syslog Configuration page

To enable the syslog, check the Remote host logging option and input the IP address for the remote host. See [Event Log Page](#) for filter descriptions.

Ethernet Aggregation

This page allows enabling or disabling the Ethernet Aggregation function. When enabled, the radio can be interconnected with other radios (typically in parallel) to aggregate the Ethernet traffic so that only one connection is needed at each end without external routers or aggregating switches.

	Current Value	New Value
Aggregation Enable	Disable	Enable
Aggregation Group	East	East
Number of Radio Links	2	4
Aggregator Id	1 (Primary)	1 (Primary)
Radio Link 1 Throughput (%)	50	25
Radio Link 2 Throughput (%)	50	25
Radio Link 3 Throughput (%)	0	25
Radio Link 4 Throughput (%)	0	25

Figure 44 Ethernet Aggregation page

The radio that has Ethernet Aggregation enabled is the ‘primary’ radio in the aggregation arrangement, and the EXP port can be connected to another radio’s EXP or GbE port or connected to a simple GbE switch connected to other radio’s EXP ports and/or GbE ports.

The net result of this feature is that a set of radios appear as ONE connection to the LAN/WAN. If a radio link fails or degrades for any reason, the capacity scales accordingly, up or down dynamically up to a maximum of 1Gbps full-duplex.

For aggregation, all radios at one side of the link must be designated ‘East’ and at the other end, designate all as ‘West.’ Each radio has an Aggregator ID that corresponds to the ‘Radio Link’ information at the bottom of the table. For the primary radio, the relative throughput percentages are entered for each radio in the aggregation set. Radio Link 1 is the radio itself. For links running ACM, use a percentage based on target modulation throughput (maximum). For example, in a two-radio link aggregation scenario, if the primary radio carries 300Mbps full-duplex capacity at target modulation and the second radio carries 200Mbps, then the percentage applied to Radio Link 1 Throughput should be 60 and Radio Link 2 40.

Cross Connect (X Connect) Page

This page has two primary purposes. One is to determine the priority of TDM interfaces when ACM is enabled and allocation for the associated TDM interfaces is different from one modulation to another. The other is to allow a cross-connect function for port assignments from one end of the link to the other.

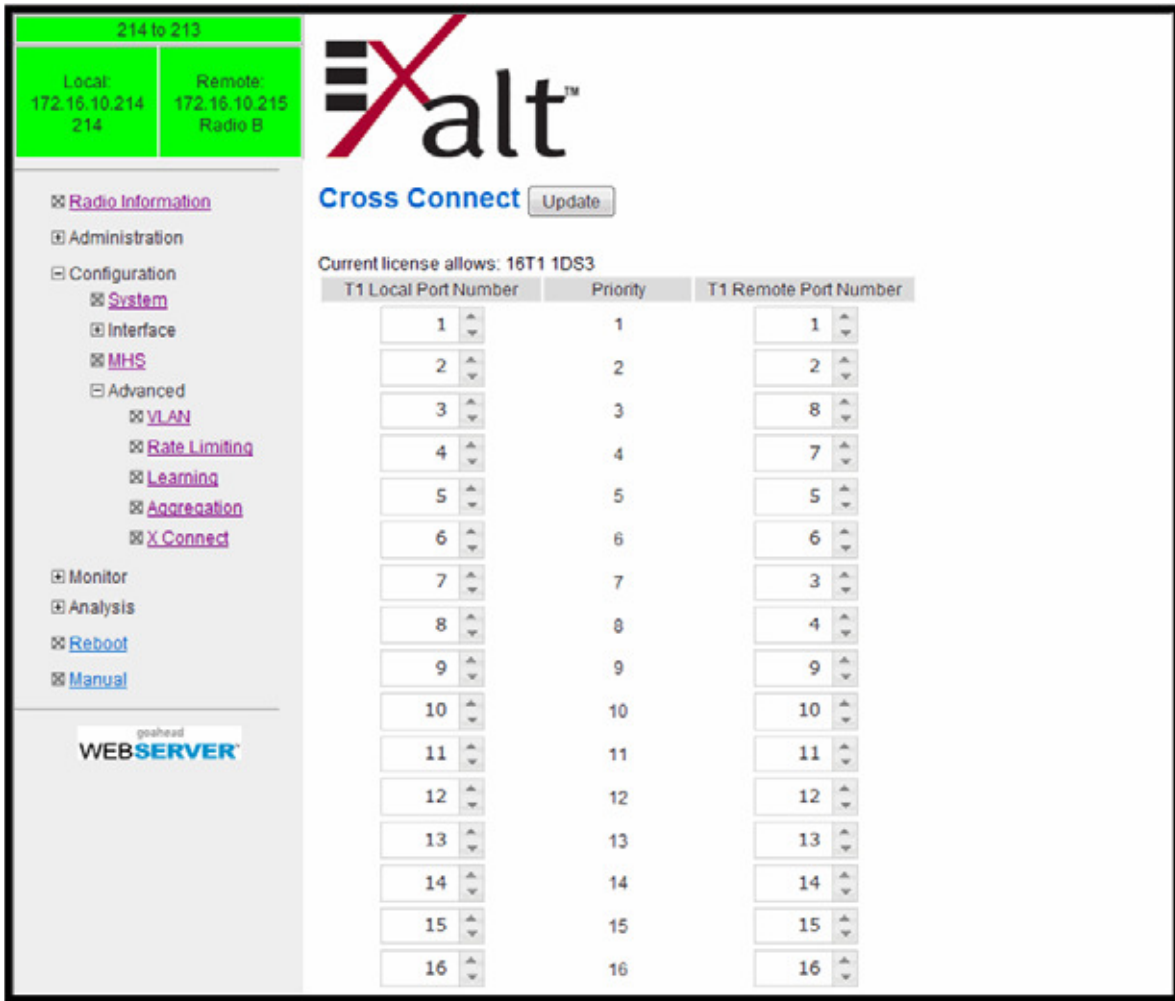

Figure 45 Cross Connect (X Connect) page

For the priority selection function, for example, if allocation has been set to carry 16xT1 interfaces under all conditions except for the lowest modulation setting, where only 4xT1 are allocated, the priority 1 through 4 ports would remain active in the lowest modulation setting.

For the cross-connect function, the port numbers at both the near-end and far-end are mapped by the administrator to determine traffic flow through the radio - for example, allowing traffic on Port 1 of one radio to be virtually connected to Port 11 on the other. This can relieve the need to commission external cross-connect or channel banks, or relieve an issue with a bad port or bad connection or cable to a port by re-prioritizing and re-connecting it.

Alarms Page

This page provides an easy-to-read summary of the alarm status of both local and remote radios. The colors on this page reflect the color of the alarms displayed on the radio front panel. However, additional detail displays on this page to aid in quick assessment of issues and status.

The screenshot shows the 'Alarms' page for an Exalt radio. It features a navigation menu on the left with options like Radio Information, Administration, Configuration, Monitor, Analysis, Reboot, and Manual. The main content area displays a table of alarm statuses for Local and Remote radios. The table includes the following data:

07/06/2011 13:50:15	Local	Remote
Link System	Normal	Normal
RX Alarm	1 2	1 2
ATPC	Disabled	Disabled
PA Protection	Normal	Normal
Ethernet - ETH1	Normal	Normal
Ethernet - ETH2	Disabled	Disabled
Ethernet - ETH3	Disabled	Disabled
DS3 Input	1	1
T1/E1 Input	1 2 3 4 5 6 7 8 9 10 11 12 13 14 15 16	1 2 3 4 5 6 7 8 9 10 11 12 13 14 15 16
Temperature	Normal	Normal
Internal Fan	1 2 3	1 2 3
External Input 1	Normal	Normal
External Input 2	Normal	Normal
Link Security	Normal	Normal

Figure 46 Alarms page

Table 5 lists alarm status conditions that appear on this page.

Table 5 Alarm status indicators

Label	Status
Link System	Indicates RF link status: <ul style="list-style-type: none"> Green Solid = Error-free connection (BER<10e-6) Yellow Solid = Errored connection (10e-3>BER >10e-6) Red Solid = No link (BER>10e-3)
RX Alarm	When Rx RSL Differential is enabled, provides alarms for Space Diversity configurations. <ul style="list-style-type: none"> Green Solid = The Rx values of the two receivers are within 5dB of the programmed differential value. Yellow Solid = The Rx values of the two receivers are further apart than 5dB of the programmed differential value.

Table 5 Alarm status indicators (Continued)

Label	Status
ATPC	Indicates Automatic Transmit Power Control status: <ul style="list-style-type: none"> • Green Solid = ATPC is enabled, but not active. • Yellow Solid = ATPC is active. • Grey = ATPC is disabled.
PA Protection	Indicates the status of power amplifier protection: <ul style="list-style-type: none"> • Green Solid = PA is OK; not in a maintenance state. • Yellow Solid = PA is in a maintenance state (force high or force low, as set on the PA Control Page). • Red Solid = PA has detected an issue.
Ethernet	<ul style="list-style-type: none"> • Green Solid = Alarm enabled and Ethernet link present • Red = Alarm enabled and Ethernet link not present • Grey = Alarm disabled
DS3 Input	<ul style="list-style-type: none"> • Green = Enabled and connection present (clocking confirmed) • Red = Enabled and no connection present • Yellow = Disabled and connection present • Grey = Disabled or unavailable due to configuration
T1/E1 Input	<ul style="list-style-type: none"> • Green = Enabled and connection present (clocking confirmed) • Yellow = Disabled and connection present • Red = Enabled and no connection present • Grey = Disabled or unavailable due to configuration
Temperature	<ul style="list-style-type: none"> • Green Solid = Normal temperature range • Yellow Solid = Exceeding normal temperature range
Internal Fan	Indicates the internal fan status. There are 3 fans for redundancy. <ul style="list-style-type: none"> • Green = Fan OK • Red = Fan in alarm
External Inputs (1 and 2)	Indicates the status of the external alarm inputs from the ALARMS connector, in accordance with the open/closed logic defined on the System Configuration Page .
Link Security	<ul style="list-style-type: none"> • Green = Security keys match • Red = Security keys do not match • Grey = Link is down

The Temperature alarm monitors the internal temperature of the unit based on specific points inside the radio chassis. It is normal for the internal temperature to be above the ambient temperature, so the temperature reading may be higher than the highest specified ambient temperature. When the internal electronics reach a point that is higher than the normal temperature rise at the highest ambient temperature, the temperature alarm turns yellow. Power down the radio as soon as possible, and investigate the cause of the temperature rise before the radio is put back into service. In almost all cases, a temperature alarm is due to an external cause.

Additional alarm entries display for certain configurations, as listed in Table 6.

Table 6 Additional alarm status indicators

Label	Status
Expansion Port Alarm	When MHS, Frequency Diversity, Errorless Switching, or Aggregation is enabled: <ul style="list-style-type: none">• Green = Expansion Port Data is valid• Yellow = Expansion Port Data is not valid or missing
Protection Port Alarm	When MHS or Errorless Switching is enabled: <ul style="list-style-type: none">• Green = Protection Port connection is valid• Yellow = Protection Port connection is not valid or missing
MHS Alarm	When MHS is enabled: <ul style="list-style-type: none">• Green = MHS configuration is correct and Protection Port data is valid• Yellow = MHS configuration is mismatched or Protection Port data is not valid or missing
Link Main Alarm	When MHS or Errorless Switching is enabled: <ul style="list-style-type: none">• Green = The local radio RF is good• Yellow = The local radio RF is BER=10e-6 or worse

MHS Status Page

This page provides information regarding the status of MHS configuration and alarms.

	Local	Partner
07/05/2011 18:32:31		
Designation	Primary	Not Defined
RF Status	Online	Not defined
Interface Status	Online	Not defined
Protection Link Status	Protection link is down	N/A
Configuration Status	Config status not determined	N/A
Expansion Link Status	High-Speed expansion port is bad	N/A

Figure 47 MHS Status page

The 'local' radio is the terminal you are logged into, and the 'partner' information is the terminal that is configured as its MHS partner. One of these must be designated as Primary, while the other is designated as Secondary (see [MHS Configuration Page](#)).

- The RF Status indicates which radio is being used for the RF circuitry of the link and which one is on standby.
- The Interface Status indicates which radio is being used for the interface circuitry of the link and which one is on standby
- The Protection Link Status refers to the communications between the PROT ports of the terminals.
- The Configuration status indicates if there are any mis-matches in required configurations between the two terminals. The following items must match between partner radios:
 - Hi/Lo orientation
 - one terminal must be primary and the other secondary
 - all TDM enabled channels and their respective alarm enabled states
 - Ethernet traffic/management, alarming and muting
- The Expansion Link status refers to the communications between the EXP ports on the terminals.

Performance Page

This page provides statistical information about the performance of the system in relation to the integrity of the user data and the RF link.

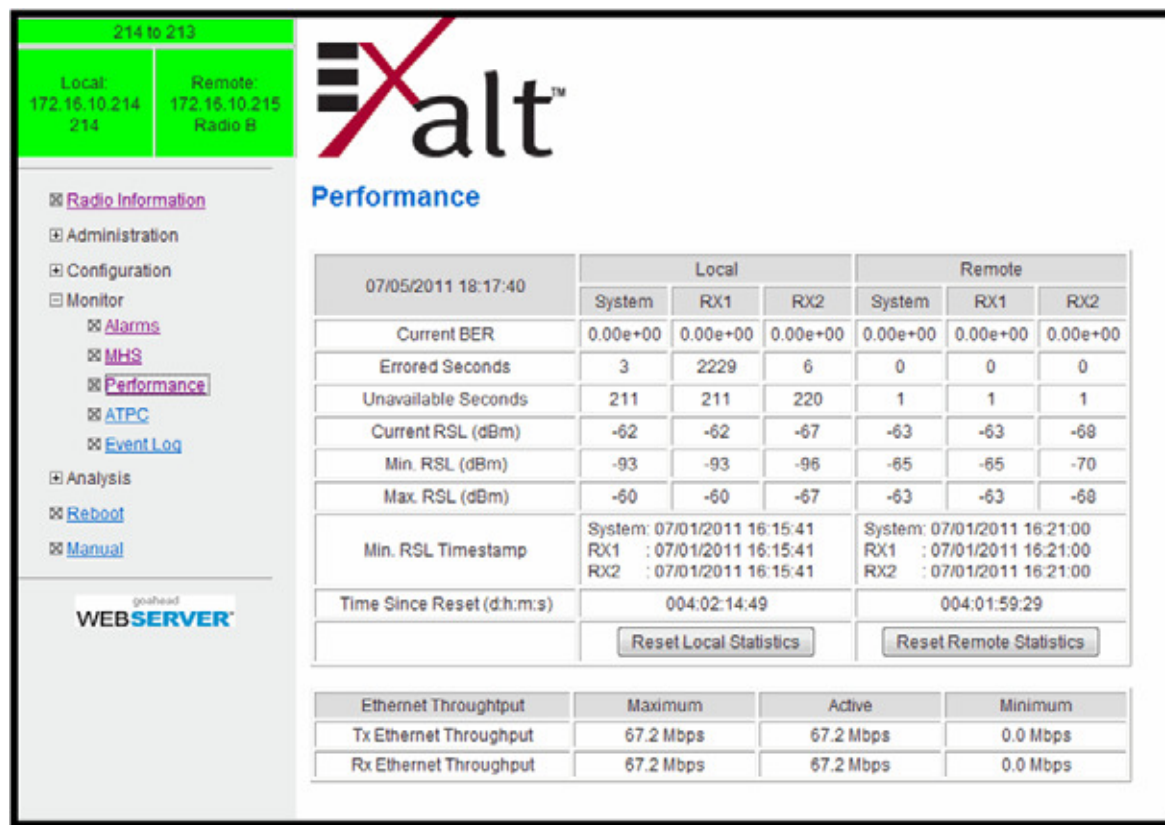

Figure 48 Performance page

- The Current BER field indicates the current bit error rate of the link. If the link is operating perfectly, this should indicate zero. Generally, the link should remain at a BER less than 1×10^{-6} (one bit out of every million bits errored). This is the threshold performance specification and the standard to which the link was engineered. However, radio links can and are affected by weather, interference, and other external sources and will occasionally have a higher error rate. A link remains operational unless the BER exceeds 1×10^{-3} (1 bit out of every hundred bits errored). Consult the link design engineer for an understanding of the predicted error rate of the radio link as it has been designed.

Many applications are unaffected by bit errors, but TDM circuits (for example, T1 or E1) are more sensitive. Also, if the link operator is providing a service guarantee, this value may need to be monitored or examined in cases of service issues. The behavior of BER in relation to other alarms or measurements and external events can be very helpful in troubleshooting activities.

- Errored Seconds (ES) indicates the total number of seconds that occurred where there was at least one bit error since the last time that the radio statistics counter was reset. Generally, ES are not a significant concern, so long as they are not continuous or above the anticipated performance based on the original link engineering goals. If ES are continuous or at a high rate, this is normally an indication of poor link performance due to poor RSL or interference, or severe impact by weather or other environmental factors. However, similar to the performance factors previously listed, ES can and will occur in any radio link. Once again, consult the link engineer to determine the original

design goals, and compare actual performance to these expectations to determine if any improvements are necessary or if other problems may be causing excessive ES.



Note: Unavailable Seconds do not register as ES. In other words, the ES counter counts all seconds that are errored NOT INCLUDING the seconds that were classified as unavailable. The total number of seconds with errors or outages is the sum of ES and Unavailable Seconds.

- Unavailable Seconds (also called UAS) are similar to ES, but this counter keeps track of every second where the bit error rate equals or exceeds 1×10^{-3} , as well as any seconds where there is a complete loss of radio communication, over the period since the last counter reset. If Unavailable Seconds are continuous or at a high rate, this is normally an indication of poor link performance due to poor RSL or interference, or severe impact by weather or other environmental factors. However, similar to the performance factors listed above, Unavailable Seconds can and do occur in any radio link. Consult the link engineer to determine the original design goals, and compare actual performance to these expectations to determine if any improvements are necessary or if other problems may be causing excessive Unavailable Seconds.
- Current RSL is the measurement of the received signal level at the radio antenna port. This is the measured level of the RF signal coming from the opposite end of the radio link. The link was engineered to a specific RSL by the link design engineer, and this RSL should be obtained during installation and remain relatively stable during the operation of the link. RSL can and will vary as a result of weather changes and other external sources, such as path obstructions. Once again, this variation was part of the original design to achieve a certain level of performance over time. Bit errors occur when the RSL falls to a level within roughly 3dB of the threshold specification. When the RSL falls below the threshold specification, the link disconnects and will not reconnect until the RSL is above the threshold specification. The behavior of RSL in relation to other alarms or measurements and external events can be very helpful in troubleshooting activities.
- Minimum RSL indicates the worst (lowest) received signal level that occurred since the last counter reset. It is helpful to know if the RSL dropped significantly from the normal level, or has reached a level near or below threshold.
- Maximum RSL indicates the best (highest) RSL that occurred since the last counter reset. This indicates the best performance of the radio link, which is normally equal to the installed value, and is usually the designed value.
- Minimum RSL Timestamp indicates the date and time when the Minimum RSL occurred. This is helpful for general troubleshooting, and especially comparing to items in the event log or diagnostic charts from the same time period.
- Time Since Reset indicates the amount of time passed since the last counter reset. This helps to quantify the seriousness of other statistics, such as ES and Unavailable Seconds, if there have been high numbers of ES and/or Unavailable Seconds over a relatively short period of time.

All end-of-link statistics can be independently reset using the respective reset statistics button. It is good practice to reset the statistics during link commissioning (after all antenna alignment is complete and stable RSL at designed levels is achieved, and no more system reboots are anticipated). Regularly review this page to record performance and reset the statistics so that the counters can more precisely pinpoint issues.



Note: Resetting statistics from one end also resets the statistics for the same radio at the opposite end. That is, if the Local statistics are reset, logging into the remote end shows the Remote statistics on that end (which is the local radio in the first condition) as being reset at the same time.

When ACM is enabled on the [System Configuration Page](#), the Performance page lists ACM statistics (Figure 49).

The screenshot shows the Exalt Performance page. At the top left, it displays '214 to 213' and 'Radio B'. The main content area is titled 'Performance' and shows a table of statistics for 'Local' and 'Remote' ends. The table includes metrics like Current BER, Errored Seconds, Unavailable Seconds, Current RSL (dBm), Min. RSL (dBm), Max. RSL (dBm), and Time Since Reset. Below this is an 'ACM Performance' table with columns for Maximum, Active, and Minimum settings for Tx modulation, Rx modulation, and Ethernet Throughput.

07/05/2011 18:39:56	Local			Remote		
	System	RX1	RX2	System	RX1	RX2
Current BER	0.00e+00	0.00e+00	0.00e+00	N/A	0.00e+00	N/A
Errored Seconds	0	0	0	N/A	2	N/A
Unavailable Seconds	154	154	154	N/A	620	N/A
Current RSL (dBm)	-63	-63	-68	N/A	-64	N/A
Min. RSL (dBm)	-66	-66	-72	N/A	-99	N/A
Max. RSL (dBm)	0	-63	-19	N/A	-19	N/A
Min. RSL Timestamp	System: 07/05/2011 18:38:22 RX1 : 07/05/2011 18:38:22 RX2 : 07/05/2011 18:38:32			RX1 : 07/05/2011 18:31:04		
Time Since Reset (d:h:m:s)	000:00:03.39			004:02:21.15		
	<input type="button" value="Reset Local Statistics"/>			<input type="button" value="Reset Remote Statistics"/>		

ACM Performance	Maximum	Active	Minimum
Tx modulation	Mode 3 (64QAM)	Mode 3 (64QAM)	Mode 3 (64QAM)
Rx modulation	Mode 3 (64QAM)	Mode 3 (64QAM)	Mode 3 (64QAM)
Tx Ethernet Throughput	134.3 Mbps	134.3 Mbps	0.0 Mbps
Rx Ethernet Throughput	134.3 Mbps	134.3 Mbps	0.0 Mbps

Figure 49 Performance page with ACM statistics

The ACM Performance table provides a reference of the maximum and minimum modulation settings that are selected on the [System Configuration Page](#) and their associated throughput. The Active column illustrates the current radio configuration.

ATPC Statistics Page

This page provides timer information for the Automatic Transmit Power Control (ATPC) function (Figure 50). Regulations require timers for ATPC and ATPC may not operate over the authorized time (up to 5 minutes at maximum allowed power without returning to target RSL). In addition to providing statistics, the timer can be reset.

The screenshot displays the Exalt web interface for ATPC Statistics. At the top left, it shows '214 to 213' and two IP address boxes: 'Local: 172.16.10.214 214' and 'Remote: 172.16.10.215 Radio B'. The Exalt logo is prominently displayed. Below the logo, the title 'ATPC Statistics' is shown. A timestamp '07/05/2011 18:18:22' is present above a table of statistics. The table has three rows, each with a label and a value of '000:00:00:00'. A 'Reset Elapse Time' button is located at the bottom right of the table. On the left side, there is a navigation menu with options like 'Radio Information', 'Administration', 'Configuration', 'Monitor', 'Analysis', 'Reboot', and 'Manual'. The 'ATPC' option under 'Monitor' is highlighted. At the bottom left, the 'goahead WEB SERVER' logo is visible.

07/05/2011 18:18:22	
Elapsed Time at Max Power (d:h:m:s)	000:00:00:00
Elapsed Time ATPC Active (d:h:m:s)	000:00:00:00
Time Since Reset (d:h:m:s)	000:00:00:00

Reset Elapse Time

Figure 50 ATPC Statistics page

Event Log Page

Use this page to review a list of the events logged by the radio. The following items are listed in the event log:

- Alarms
- Alarms clearing (normal)
- Radio reboots

Every event is tagged with the time that the event occurred, and a severity and type. The event log also allows filtering to limit the view of the log to only the level(s) of desired information.

The log contains the last 1000 events. Events are deleted on a FIFO basis.

The event log can be cleared and downloaded from the file transfer page (some models may require a software upgrade to enable this feature). A screen capture of the browser window can serve as a useful record.

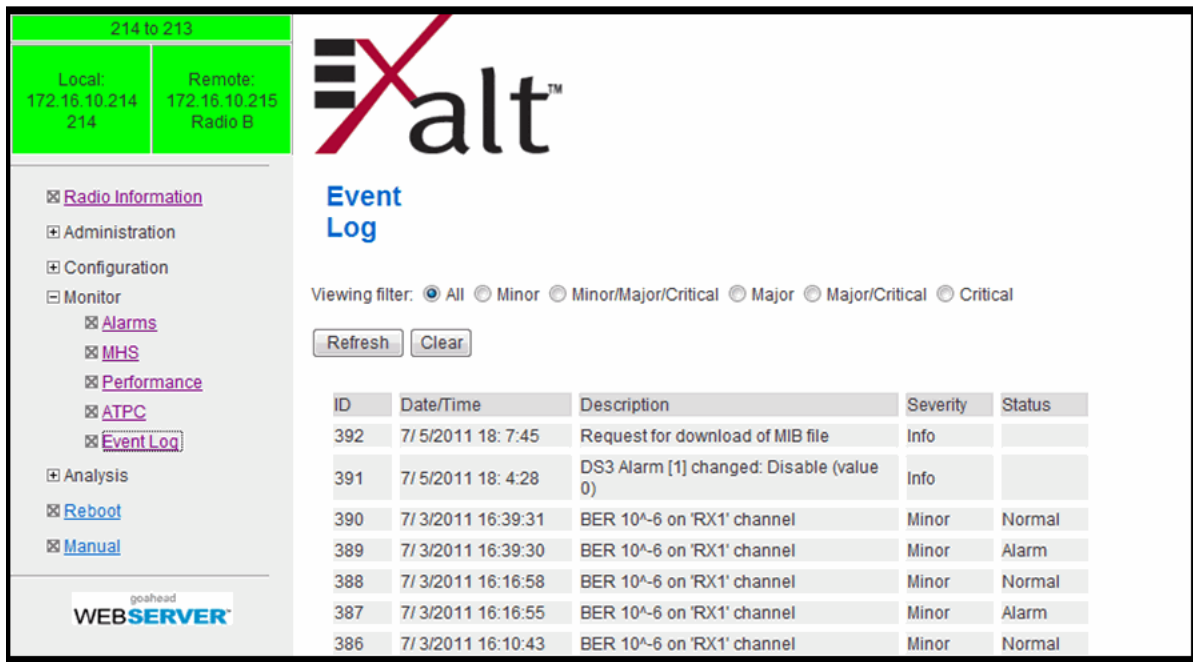

The screenshot shows the Exalt Event Log page. At the top, it displays '214 to 213' and the Exalt logo. Below the logo, there are two green boxes: 'Local: 172.16.10.214 214' and 'Remote: 172.16.10.215 Radio B'. The page has a navigation menu on the left with options like Radio Information, Administration, Configuration, Monitor, Alarms, MHS, Performance, ATPC, Event Log, Analysis, Reboot, and Manual. The main content area shows the 'Event Log' title and a viewing filter set to 'All'. Below the filter are 'Refresh' and 'Clear' buttons. A table of events is displayed with the following data:

ID	Date/Time	Description	Severity	Status
392	7/5/2011 18: 7:45	Request for download of MIB file	Info	
391	7/5/2011 18: 4:28	DS3 Alarm [1] changed: Disable (value 0)	Info	
390	7/3/2011 16:39:31	BER 10^-6 on 'RX1' channel	Minor	Normal
389	7/3/2011 16:39:30	BER 10^-6 on 'RX1' channel	Minor	Alarm
388	7/3/2011 16:16:58	BER 10^-6 on 'RX1' channel	Minor	Normal
387	7/3/2011 16:16:55	BER 10^-6 on 'RX1' channel	Minor	Alarm
386	7/3/2011 16:10:43	BER 10^-6 on 'RX1' channel	Minor	Normal

Figure 51 Event Log page

User Throughput Page

This page illustrates the user throughput of the radio, as configured.

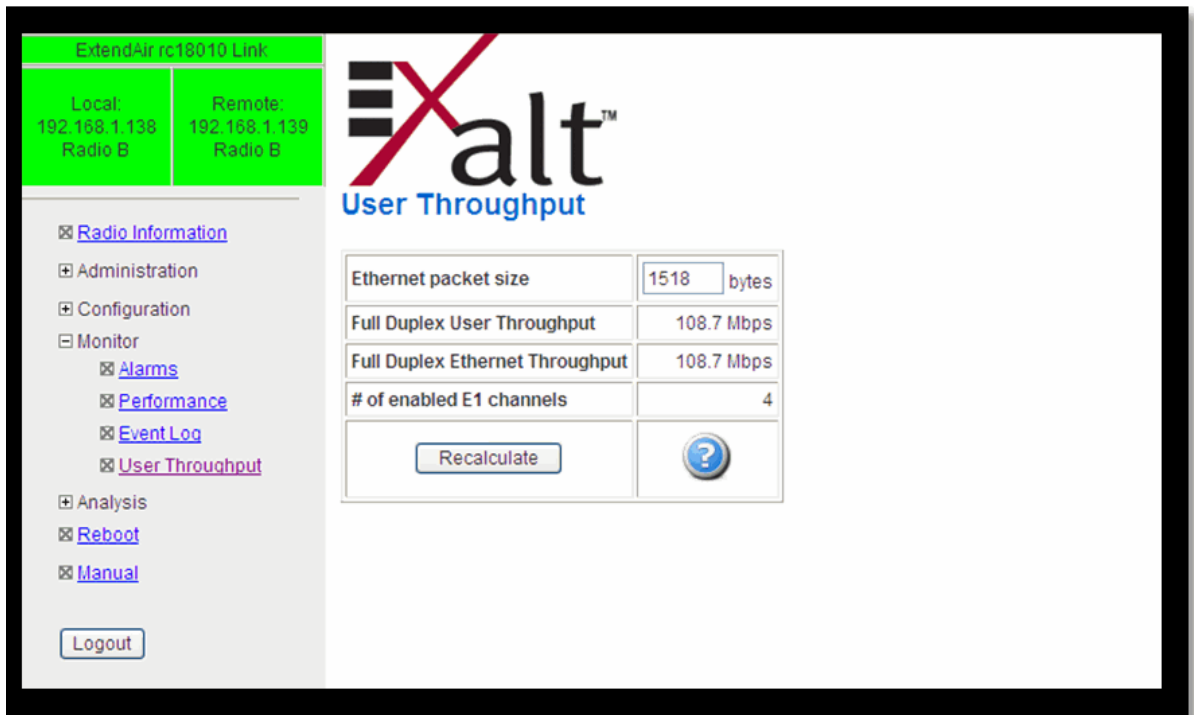

ExtendAir rc18010 Link	
Local: 192.168.1.138 Radio B	Remote: 192.168.1.139 Radio B

Exalt™
User Throughput

Ethernet packet size	1518 bytes
Full Duplex User Throughput	108.7 Mbps
Full Duplex Ethernet Throughput	108.7 Mbps
# of enabled E1 channels	4



Recalculate 

Figure 52 User Throughput page

Click the help icon () to go to the page on how this information is determined (Figure 53)

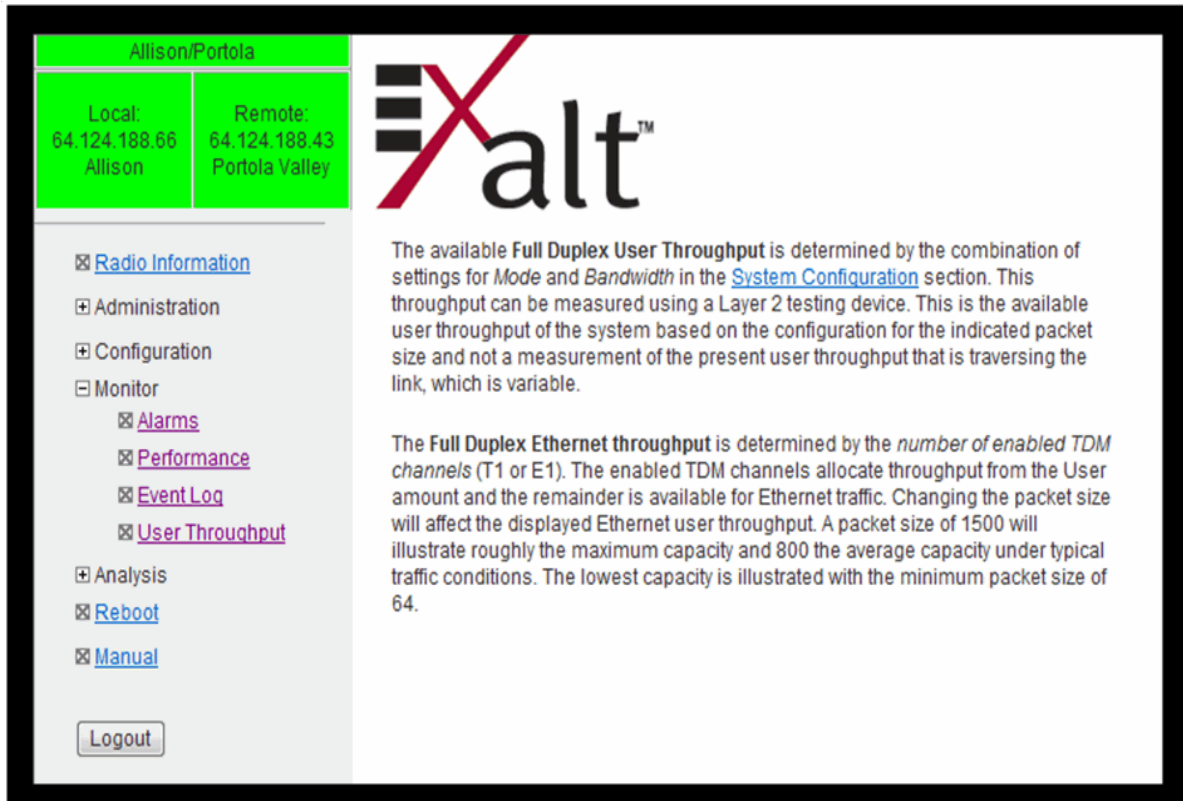

Figure 53 User Throughput Help page

Diagnostic Charts Page

Use this page as an aid in troubleshooting. This page illustrates the historical (and current) performance for three parameters: RSL, Radio Temperature, and BER.

The horizontal scale illustrates 120 points of time measurement and is synchronized on all three graphs. The scale displays in minutes, hours, or days from the last two hours (120 minutes), five days (120 hours), or four months (120 days). All information is stored, so all of these periods are available for short- and long-term performance analysis. The right side of a graph represents the most recent measurement, and data 'marches' from the right-to-left at every interval.

The vertical scale of each chart independently scales to show the maximum resolution based on the maximum variation of the data over the selected time measurement.

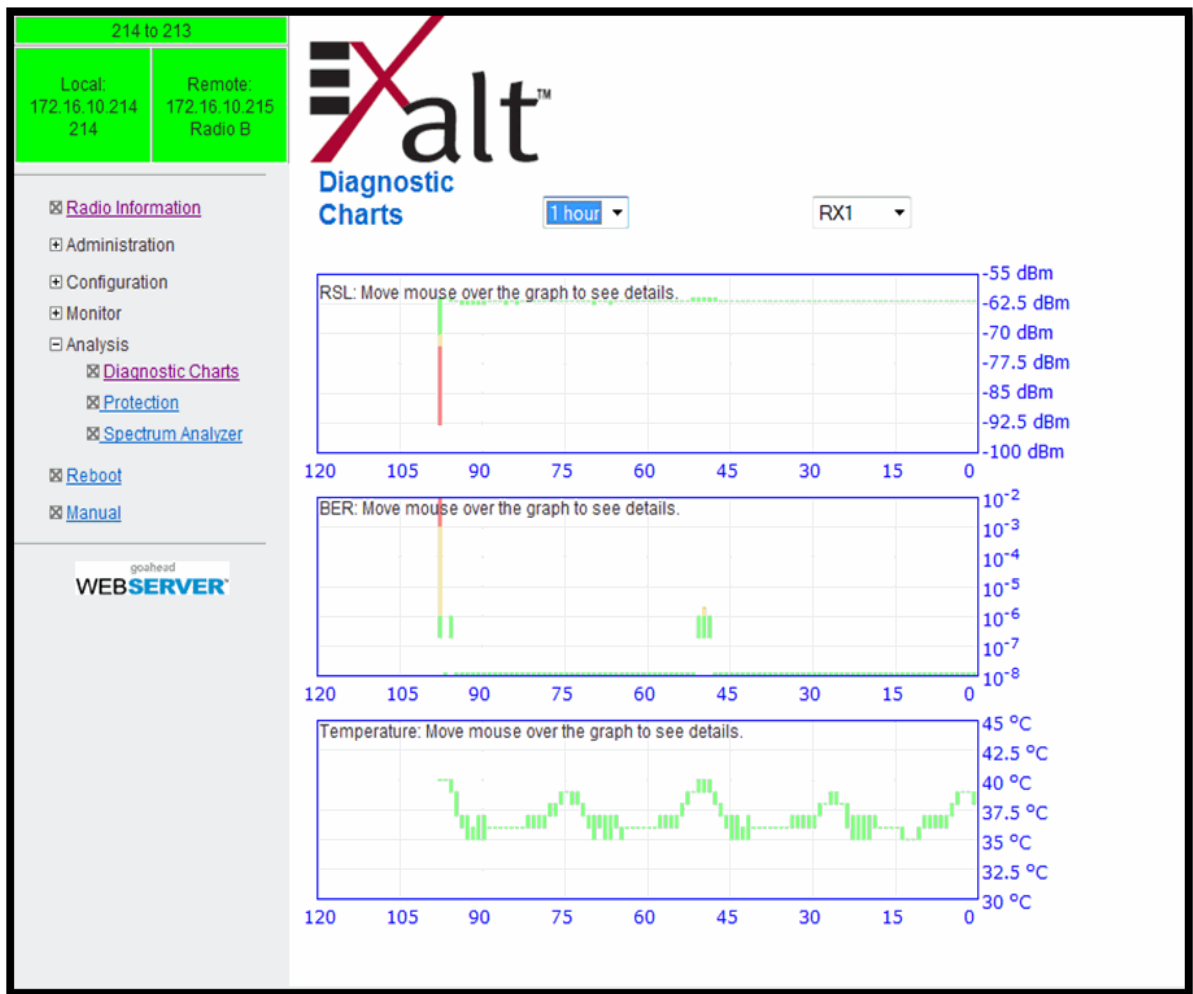

Figure 54 Diagnostic Charts page

Use the cursor to point to any spot on any of the three charts, and all three charts illustrate the measurements taken for that time interval in the upper-left corner of each chart. The time interval is indicated by T=(value). This is followed by the value of the measurement, listing the highest value, lowest value and average value measured over that time interval.

For example, if the displayed time interval is minutes, and the cursor is held at the T=17 mark on the horizontal axis, the measurements shown indicate performance from 17 minutes ago. The high/low/average values shown on each chart are measurements made across that specific one-minute interval.

Changes in RSL often have an impact on BER, and this can be confirmed by looking for synchronized events. When BER events occur without corresponding changes in RSL, this normally indicates interference, atmospheric changes, transmission system issues (such as problems with cables, connectors, or antennas), or possibly radio hardware problems.

Ethernet Utilization Page

This page shows a chart for each Ethernet interface to illustrate inbound and outbound packet utilization. This is shown as a percentage of the interface configuration (that is, if your interface is set for 100BaseT, then 100% represents 100Mbps. Compare offered load (inbound) to delivered load (outbound) to determine if radio capacity is a bottleneck for the data transfer. This chart can illustrate inbound and/or outbound utilization, and uses different colors for data entry. The legend can be hidden.

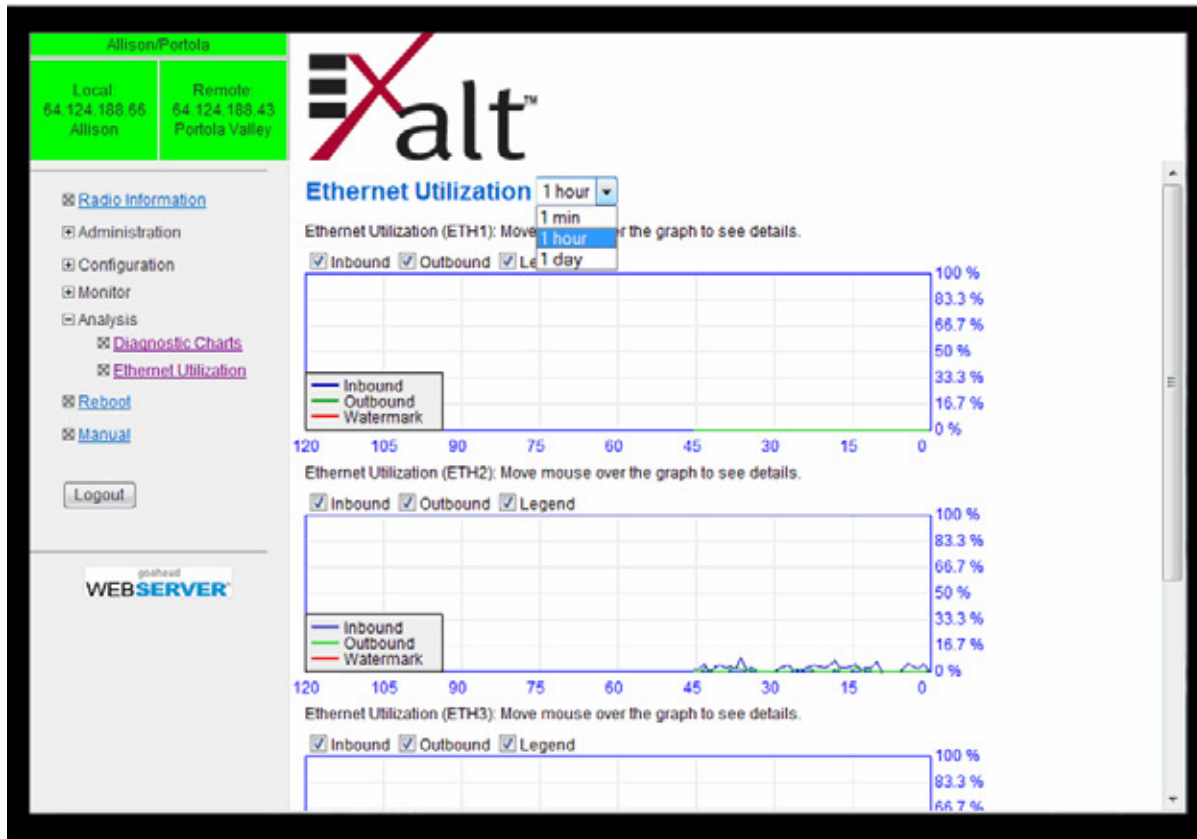

Figure 55 Ethernet Utilization page

Note that outbound utilization never exceeds the rate where a radio is configured. For example, if the radio is configured for a 55 Mbps capacity, outbound utilization will never exceed 55 Mbps at 100BaseT.

The Ethernet Utilization Watermark level function allows administrators to receive an SNMP trap when watermark conditions are exceeded. For example, if a radio is configured for 55 Mbps capacity, the administrator may wish to be warned if the radio exceeds 50 Mbps for more than 1 hour per day. In this case, set the Watermark level to 50% and the trap duration to 60 minutes. Traps must be enabled to activate this function.

When the watermark level function is enabled, a line on the chart appears for data comparison to the watermark.

PA Control Page

Radios configured with Power Amplifier (PA) protection switching automatically bypass the PA on detected PA failures. The PA Control page provides ability for extended troubleshooting related to the PA. Select from the following three options:

- Force Normal places the PA protection in its normal state where if issues are detected, the PA is bypassed, dropping the transmit power approximately 10dB. In most link conditions, the link is maintained.
- Force High forces a **no** PA bypass condition. If a PA issue is detected, this can help verify improper performance.
- Force Low forces a PA bypass. This is useful for troubleshooting and initial link commissioning. For link testing, this option ensures that the link has sufficient margin to maintain connection if PA protection switching occurs.

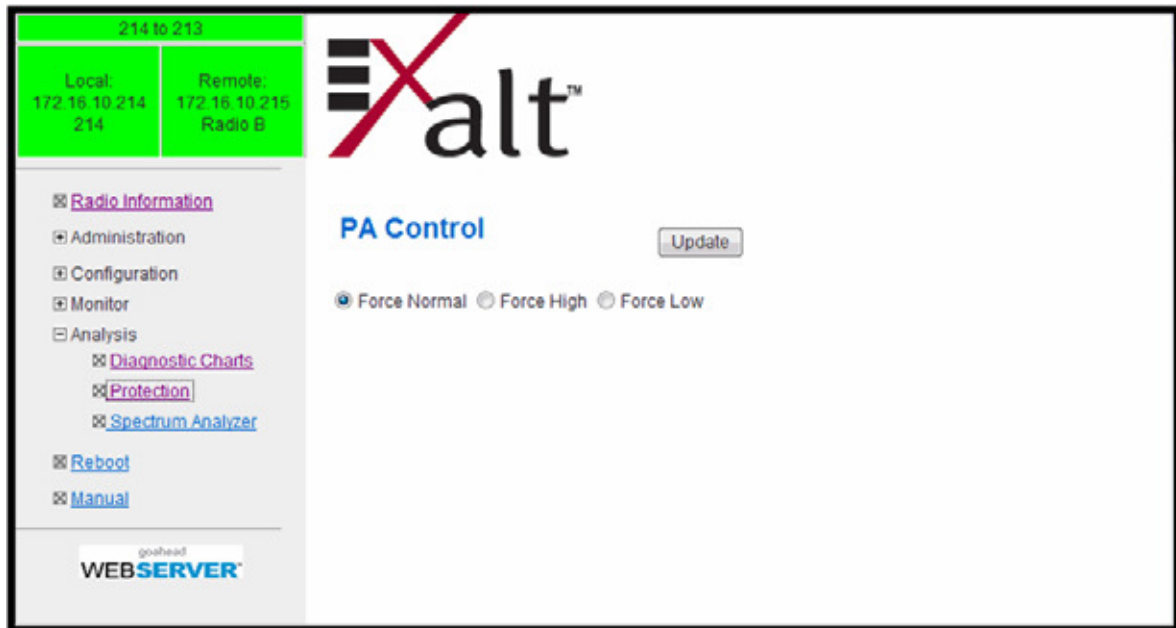

Figure 56 PA Control page

Spectrum Analyzer

The spectrum analyzer feature provides a useful pre-planning and troubleshooting tool. This feature is only available on radios with firmware supporting the spectrum analyzer. Perform a spectrum analysis after deployment and just before commissioning to maintain a record of the spectrum at the time of deployment. Figure 57 shows the Spectrum Analyzer page.



Figure 57 Spectrum Analyzer page

While a professional spectrum analyzer provides higher levels of control and precision for pre-planning, the Spectrum Analyzer page allows evaluation of the RF spectrum as seen at the radio's RF input port prior to deployment. This is useful for pre-planning the center frequency and occupied bandwidth, and to determine polarization and antenna type and mounting locations.

For troubleshooting, enable the spectrum analyzer to scan the desired segment or full band of the frequency range. Select the step size and set the remote radio transmitter ON or OFF. This allows viewing of the *clean* spectrum without the remote transmitter on and a comparison of the remote transmitter in the midst of other signals.



Note: Enabling the spectrum analyzer interrupts all radio traffic for the duration of the analysis. In addition, access to the radio's GUI may also be interrupted, depending on the location of the interfaced computer relative to the radio where the spectrum analysis is occurring. The GUI is available at the completion of the spectrum analysis.

Use the smallest step size to obtain the finest view of the spectrum. The spectrum analyzer can be set to match the start and stop frequency for a *dwell* mode. Peak and average detection modes are also available. Peak detection is helpful for capturing intermittent events such as pulsed emissions.

It is best to set the Scan Time option to a time value as opposed to using the 'infinity' setting. If your management computer is connected to the radio through the radio link, access to the GUI is interrupted during the duration of the analysis.



Note: The result of selecting infinity may be complete loss of contact to that radio and may require a physical visit to the radio location to disable the spectrum analyzer.

The spectrum analyzer graph displays received signals in red or green (Figure 58), normalized in dBm to the resolution bandwidth of the analyzer. Red indicates a peak hold function. This is the highest level detected during the entire scan. Green indicates the last value measured at that frequency.

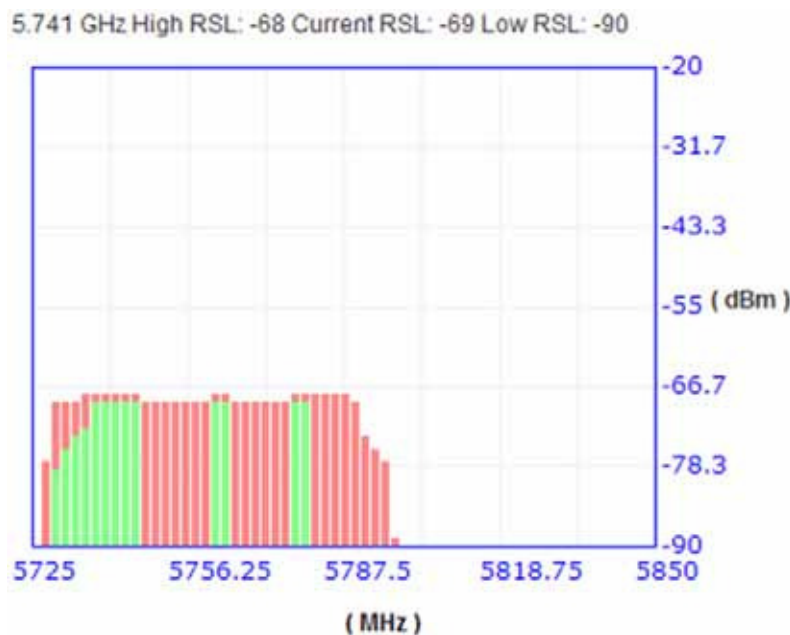

Figure 58 Spectrum analyzer graph example

A completely green vertical box indicates that the signal maintained a steady level for the entire scan or that the last scan measured at a strong or stronger level than the rest of the analysis. A completely

red vertical box indicates that there was a signal at some point during the scan, but that the signal was not detected at the last scan. A graph displaying green on the lower part and red at the upper part indicates that at some time during the scan, a signal was detected at a higher level than was detected during the last scan.

The last spectrum analyzer scan performed displays in this page until the radio is rebooted. You can do a screen capture for record keeping and for comparison to future analyses. The time and date of the analysis displays on the page, which is handy as a reference in a screen capture.

Reboot Page

Use this page to reboot the radio. The function may never be required, but can be used in emergencies. All configurations that require a reboot automatically reboot on administrator confirmation.

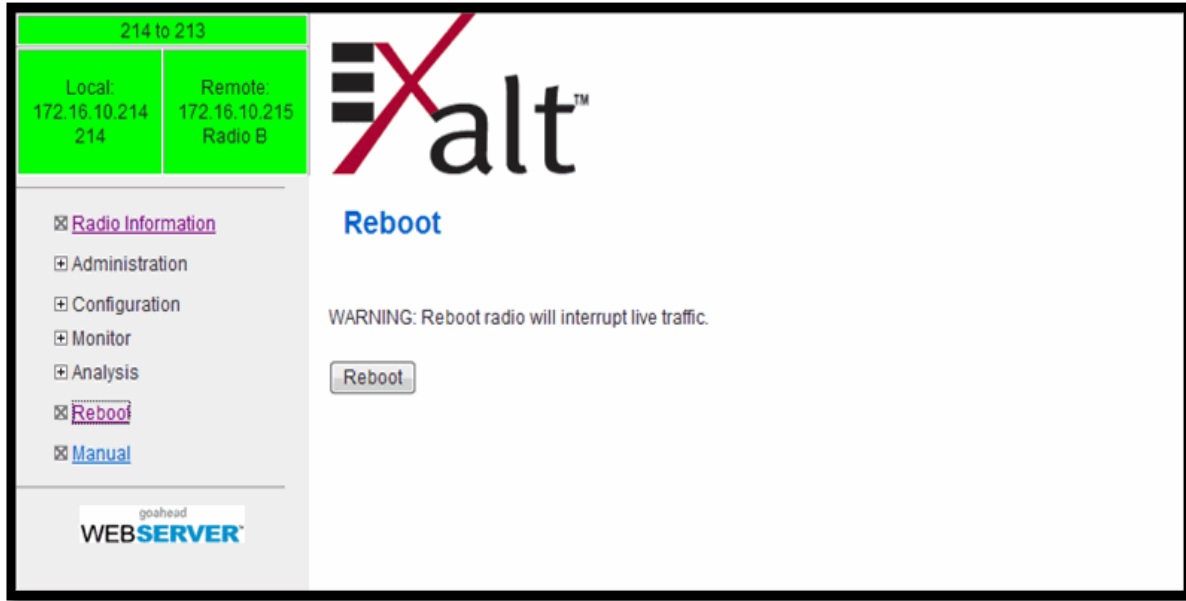

Figure 59 Reboot page

Manual Page

The manual (this document or the version that matches the installed firmware) is available within the GUI. Adobe Acrobat Reader 5.5 or higher is required (go to www.adobe.com to download Acrobat Reader). Click the Manual link to display the manual within the browser window. Once the manual displays, click the save button on the PDF toolbar to download the manual locally.



Figure 60 Manual page

Specifications

This section presents specifications for the EX-i Series GigE (FDD) digital microwave radios.

Physical Specifications

Physical Configuration	Single-piece Indoor Unit (IDU)
Dimensions (H x W x D), (includes diplexers)	2RU: 3.5" x 17" x 16.5" / 9 x 43.2 x 42cm
Weight	17 lbs/8 kg
Operating Temperature	-40° +149°F / -40° to +65°C
Altitude	15,000/4.6 km
Humidity	95% non-condensing

Common System Specifications

Tuning Resolution	5MHz																																																
Power Control Step Size	0.5dB																																																
Selectable Modulation Settings	Mode 1 (QPSK), Mode 2 (16QAM), Mode 2.5 (32QAM), Mode 3 (64QAM), Mode 4 (128QAM), Mode 5 (256QAM), Mode 5-HG (256QAM-HG)																																																
Selectable Channel Bandwidths	5MHz, 10MHz, 20MHz, 30MHz, 40MHz ^a																																																
Full-duplex Capacity (Mbps) ^a	<table border="1"> <thead> <tr> <th></th> <th>Mode 1 (QPSK)</th> <th>Mode 2 (16QAM)</th> <th>Mode 2.5 (32QAM)</th> <th>Mode 3 (64QAM)</th> <th>Mode 4 (128QAM)</th> <th>Mode 5 (256QAM)</th> <th>Mode 5-HG (256QAM-HG)</th> </tr> </thead> <tbody> <tr> <td>5 MHz</td> <td>6</td> <td>14</td> <td>19</td> <td>23</td> <td>27</td> <td>30</td> <td>N/A</td> </tr> <tr> <td>10 MHz</td> <td>14</td> <td>29</td> <td>38</td> <td>46</td> <td>54</td> <td>62</td> <td>59</td> </tr> <tr> <td>20 MHz</td> <td>30</td> <td>61</td> <td>78</td> <td>92</td> <td>107</td> <td>123</td> <td>118</td> </tr> <tr> <td>30MHz</td> <td>45</td> <td>92</td> <td>116</td> <td>138</td> <td>166</td> <td>185</td> <td>178</td> </tr> <tr> <td>40MHz</td> <td>61</td> <td>124</td> <td>155</td> <td>189</td> <td>220</td> <td>255</td> <td>N/A</td> </tr> </tbody> </table>		Mode 1 (QPSK)	Mode 2 (16QAM)	Mode 2.5 (32QAM)	Mode 3 (64QAM)	Mode 4 (128QAM)	Mode 5 (256QAM)	Mode 5-HG (256QAM-HG)	5 MHz	6	14	19	23	27	30	N/A	10 MHz	14	29	38	46	54	62	59	20 MHz	30	61	78	92	107	123	118	30MHz	45	92	116	138	166	185	178	40MHz	61	124	155	189	220	255	N/A
	Mode 1 (QPSK)	Mode 2 (16QAM)	Mode 2.5 (32QAM)	Mode 3 (64QAM)	Mode 4 (128QAM)	Mode 5 (256QAM)	Mode 5-HG (256QAM-HG)																																										
5 MHz	6	14	19	23	27	30	N/A																																										
10 MHz	14	29	38	46	54	62	59																																										
20 MHz	30	61	78	92	107	123	118																																										
30MHz	45	92	116	138	166	185	178																																										
40MHz	61	124	155	189	220	255	N/A																																										
Error Floor	10 ⁻¹²																																																
Frequency Stability	±7 ppm																																																
Link Security	96-bit Security Code																																																

a. Not all bandwidths are available on all radio models. Radios generally require certain capacity and/or interface license keys for certain combinations of bandwidths and modulations. License keys can be purchased from your authorized Exalt representative.

5GHz System Specifications

Frequency Bands 5725–5850MHz

Output Power +30dBm

Selectable Channel Bandwidths 5MHz, 10MHz, 20MHz, 30MHz

Power Control Range 20dB, 0.5dB steps

Receiver Threshold dBm (BER=10⁻⁶)

	Mode 1 (QPSK)	Mode 2 (16QAM)	Mode 2.5 (32QAM)	Mode 3 (64QAM)	Mode 4 (128QAM)	Mode 5 (256QAM)	Mode 5-HG (256QAM-HG)
5 MHz	-90	-83.5	-80.5	-77.5	-74.5	-71	N/A
10 MHz	-87	-80.5	-77.5	-74.5	-72	-68.5	-71
20 MHz	-84	-77.5	-74.5	-71.5	-68.5	-65	-68
30MHz	-82.5	-76	-73	-70	-67	-63.5	-66.5

Maximum RSL -30dBm error-free (QPSK to 64QAM); -32dBm error-free (128QAM and 256QAM)

Regulatory Compliance RF FCC Part 15.407, EMI FCC Part 15, RSS-210, EN 60 950-1, IEC 950-1, UL 60950-1, SRSP-305.9

Emission Designator(s)

5MHz	5M0W7D
10MHz	10M0W7D
20MHz	20M0W7D
30MHz	30M0W7D

6GHz System Specifications

Frequency Bands	Lower 6: 5925–6425MHz Upper 6: 6525–6875MHz																				
Output Power Options	+27dBm +30dBm +33dBm (software-keyed option on +30dBm model)																				
Selectable Channel Bandwidths	Lower 6: 5MHz, 10MHz, 20MHz, 30MHz Upper 6: 5MHz, 10MHz, 20MHz, 30MHz																				
Power Control Range	20dB, 0.5dB steps																				
Receiver Threshold dBm (BER=10 ⁻⁶) ^a	<table border="1"> <thead> <tr> <th></th> <th>64QAM</th> <th>128QAM</th> <th>256QAM</th> </tr> </thead> <tbody> <tr> <td>5MHz</td> <td>-79</td> <td>-76</td> <td>-73</td> </tr> <tr> <td>10MHz</td> <td>-76</td> <td>-73</td> <td>-70</td> </tr> <tr> <td>20MHz</td> <td>-73</td> <td>-70</td> <td>-67</td> </tr> <tr> <td>30MHz</td> <td>-71</td> <td>-68</td> <td>-65</td> </tr> </tbody> </table>		64QAM	128QAM	256QAM	5MHz	-79	-76	-73	10MHz	-76	-73	-70	20MHz	-73	-70	-67	30MHz	-71	-68	-65
	64QAM	128QAM	256QAM																		
5MHz	-79	-76	-73																		
10MHz	-76	-73	-70																		
20MHz	-73	-70	-67																		
30MHz	-71	-68	-65																		
Maximum RSL	-30dBm error-free (64QAM); -32dBm error-free (128QAM and 256QAM)																				
Regulatory Compliance	RF FCC Part 101. EMI FCC Part 15, RSS-210, EN 60 950-1, IEC 950-1, UL 60950-1, SRSP-305.9																				
Emission Designator(s)	<table border="1"> <tbody> <tr> <td>5MHz</td> <td>5M0W7D</td> </tr> <tr> <td>10MHz</td> <td>10M0W7D</td> </tr> <tr> <td>20MHz</td> <td>20M0W7D</td> </tr> <tr> <td>30MHz</td> <td>30M0W7D</td> </tr> </tbody> </table>	5MHz	5M0W7D	10MHz	10M0W7D	20MHz	20M0W7D	30MHz	30M0W7D												
5MHz	5M0W7D																				
10MHz	10M0W7D																				
20MHz	20M0W7D																				
30MHz	30M0W7D																				

a. Threshold figures are for 1+0 configurations. If linear combining is used, the threshold improves by 3dB.

11GHz System Specifications

Frequency Bands	10700–11700MHz																		
Output Power Options	+29dBm																		
Selectable Channel Bandwidths	10MHz, 30MHz, 40MHz																		
Power Control Range	20dB, 0.5dB steps																		
Receiver Threshold dBm (BER=10 ⁻⁶) ^a	<table border="1"> <thead> <tr> <th></th> <th>64QAM</th> <th>128QAM</th> <th>256QAM</th> </tr> </thead> <tbody> <tr> <td>10MHz</td> <td>-76</td> <td>-73</td> <td>-70</td> </tr> <tr> <td>30MHz</td> <td>-71</td> <td>-68</td> <td>-65</td> </tr> <tr> <td>40MHz</td> <td>-70</td> <td>-67</td> <td>-64</td> </tr> </tbody> </table>				64QAM	128QAM	256QAM	10MHz	-76	-73	-70	30MHz	-71	-68	-65	40MHz	-70	-67	-64
	64QAM	128QAM	256QAM																
10MHz	-76	-73	-70																
30MHz	-71	-68	-65																
40MHz	-70	-67	-64																
Maximum RSL	-30dBm error-free (64QAM); -32dBm error-free (128QAM and 256QAM)																		
Regulatory Compliance	RF FCC Part 101. EMI FCC Part 15, RSS-210, EN 60 950-1, IEC 950-1, UL 60950-1, SRSP-305.9																		
Emission Designator(s)	<table border="1"> <tbody> <tr> <td>10MHz</td> <td>10M0W7D</td> </tr> <tr> <td>30MHz</td> <td>30M0W7D</td> </tr> <tr> <td>40MHz</td> <td>40M0W7D</td> </tr> </tbody> </table>			10MHz	10M0W7D	30MHz	30M0W7D	40MHz	40M0W7D										
10MHz	10M0W7D																		
30MHz	30M0W7D																		
40MHz	40M0W7D																		

a. Threshold figures are for 1+0 configurations. If linear combining is used, the threshold improves by 3dB.

Interfaces

RF

Connector	SMA-type female
Impedance	50 Ohms

T1/ E1 (up to x16)

Connector	RJ-45 (RJ48C), female
T1 Impedance	100 Ohms, balanced
T1 Line Codes	AMI, B8ZS, selectable
T1 LBO Settings (in ft.)	0–133, 133–266, 266–399, 399–533, 533–655
T1 Clocking Speed	1.544 Mbps
T1 Compliance	ANSI T1.102-1987; ITU-T; G.823; GR-49T-CORE
E1 Impedance	120 Ohms, balanced
E1 Line Codes	HDB3
E1 Clocking Speed	2.048 Mbps
E1 Compliance	CEPT-1; G.703; ITU-T-G703

DS3 (In and Out – up to 4 pairs)

Connector	BNC, female (x2, In/Out)
DS3 Impedance	75 Ohms, unbalanced
DS3 Line Code	B3ZS
DS3 LBO Settings (in ft.)	0–133, 133–266, 266–399, 399–533, 533–655
DS3 Clocking Speed	44.736 Mbps
DS3 Compliance	ANSI T1.102-1993; GR-499-CORE

OC3

Connector	SFP, Single-mode LC Transceiver
Line Code	Binary Scrambled NRZ CMI
Clocking Speed	155.52MHz
Compliance	ITU-T G.957; G.703 GR-253-CORE
RxTx	1310 nm (Short Range 15km) Rx: –31 to –7dBm, Tx: –15 to 0dBm 1310 nm (Long Range 40km) Rx: –35 to 0dBm, Tx: –5 to 0dBm

Ethernet (copper)

Connectors	RJ-45, female, auto-MDIX
Interface Speed	10, 100, or 1000 Mbps
Duplex	Half, full, auto, selectable
Compliance	802.3

Ethernet (SFP)

Connectors	SFP
Interface Speed	1000 Mbps

Duplex Full
 Compliance 802.3

PROT (Protection)

Connector RJ-45, female

EXP (Expansion)

Connector RJ-45, female

Console (Serial)

Connector 9-pin sub-D, female
 Interface Speed 9600 bps
 Compliance EIA-574 DTE (RS-232)

Alarm

Connector 9-pin sub-D, female
 Inputs (2) TTL/Closure
 Outputs (2) Relay (Form C)

Power (x2)

Connector 3-pin barrier strip
 Input Voltage 20–60VDC, 8–4A
 Consumption <160W (<4A @ 48V, <8A @ 24V), 30 or 33dBm models
 <100W (2A @ 48V, 4A @ 24V), 25dBm model

Compatible SFP Connectors

The following items have been tested and certified/screened for appropriate safety and EMI/RFI standards. All other SFP vendors and devices are likely compatible and compliant, but not specifically tested with the Exalt product.

Vendor	Model Number	Type
Avago Technologies	AFBR-5710ALZ	Multi-Mode Fiber
Avago Technologies	AFCT-5710ALZ	Single-Mode Fiber
Finisar	FCLF-8521-3	Copper
Finisar	FTLF-8519P2BTL	Multi-Mode Fiber
Finisar	FTLF1318P2BTL	Single-Mode Fiber
FiberXon	FTM-8012C-SLiG	Multi-Mode Fiber
Avago Technologies	ABCU-5710RZ	Copper

Interface Connections

This section provides the pin number assignment and wiring information for the connectors on the EX-i Series GigE (FDD) radios. All connectors are shown as viewed from the radio front panel.

T1/E1 Connections

There are two orientations of T1/E1 connections. Channels 1 and 2 have the securing tab towards the top of the connector while Channels 3 and 4 have the securing tab towards the bottom of the connector. Figure 61 illustrates the pin orientation and functionality of these connectors.

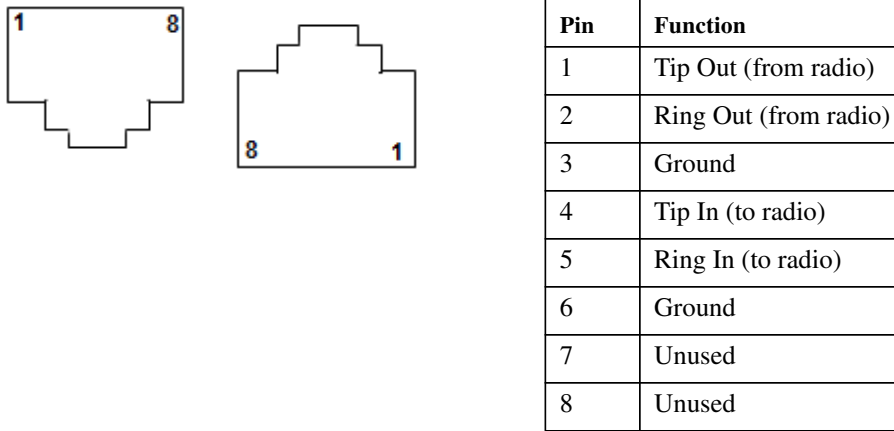
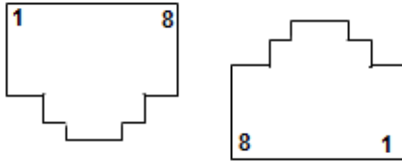

Figure 61 T1/E1 connectors

Ethernet Connections

There are two orientations of Ethernet connections. ETH1 has the securing tab towards the top of the connector while ETH2 has the securing tab towards the bottom of the connector. Figure 62 illustrates the pin orientation and functionality of these connectors.



Pin	Function
1	Paired with Pin 2
2	Paired with Pin 1
3	Paired with Pin 6
4	Paired with Pin 5
5	Paired with Pin 4
6	Paired with Pin 3
7	Paired with Pin 8
8	Paired with Pin 7

Figure 62 Ethernet connectors (ETH1 and ETH2)

The Ethernet connections implement Auto-MDIX, and therefore either 'straight' or 'crossover' Ethernet cables can be used, independent of the wiring of the connected device.

Alarm Connector

The Alarm connector provides two alarm outputs that can be connected to external alarm collection equipment. The connector also allows connection of up to two external alarm sources, where the radio will report the status of these connections through the radio network management. Output alarm connections are 'Form C' style connections, performing alarm logic based on either Normally Opened (NO) or Normally Closed (NC) connections compared to a Common (C) pin. Input alarm connections can be TTL logic or NO/NC style relay closures.

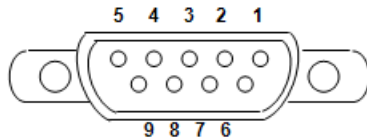

Pin	Function
1	Alarm Output 1 – NO
2	Alarm Output 1 – NC
3	Ground (for Alarm Inputs)
4	Alarm Output 2 – NO
5	Alarm Output 2 – NC
6	Alarm Output 1 – Common
7	Alarm Input 1
8	Alarm Input 2
9	Alarm Output 2 – Common

Figure 63 Alarm Connector

Alarm Output 1 is in alarm any time that there is a traffic-impacting alarm condition (Major). Alarm Output 2 is in alarm any time that there is an alarm that is not traffic-impacting (Minor).

The administrator can set the polarity of the alarm inputs.

Console Connector

The Console connector provides a serial interface for the Command Line Interface (CLI) functions. Typically, a straight-through serial cable is used between a computer's serial port and the Console connector.

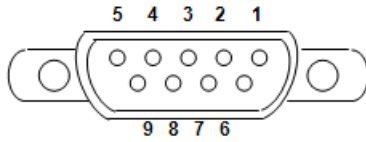

Pin	Function
1	Unused
2	Tx (from radio)
3	Rx (into radio)
4	Unused
5	Ground
6	Unused
7	Unused
8	Unused
9	Unused

Figure 64 Console Connector

DC Power Connector

Use this connector to provide power to the radio. Pins are read left to right.

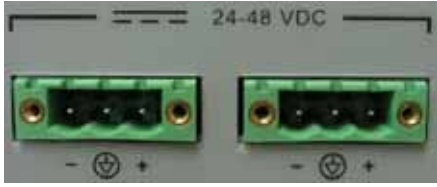

Pin	Function
1	Power Return (-)
2	Ground
3	Power (+)

Figure 65 DC Power connector

Troubleshooting

This section provides information regarding troubleshooting of common issues and alarms on these radios. Exalt Digital Microwave Radio systems are designed by Exalt's expert engineers with extensive experience through multiple generations of microwave radio design. These new-generation systems contain extensive diagnostic tools, alarm indications, and troubleshooting aids. And, as compared to other systems in their class, are easier to install, maintain, and troubleshoot. The GUI provides information to aid in troubleshooting (see [Diagnostic Charts Page](#)).

Contact Exalt Customer Care for further assistance with issues with your Exalt radio and with suggestions on how the radio and documentation can be improved.

General Practices

Troubleshooting a microwave radio link can be a complex task. Approach troubleshooting as a process of elimination, and first determine which portions of the system are operating properly.

In a vast majority of cases, failures or poor performance of microwave links is attributed to something other than the microwave radio hardware. In this respect, the back-to-back bench test (see [Back-to-back Bench Testing](#)) is very important to determine if radio hardware is operating properly and eliminate many variables in the troubleshooting process.

If a back-to-back bench test fails, then the radio hardware is either broken or the radios are improperly configured. Upgrade the radio to the most current release of firmware, and/or reset the radio to its critical factory settings, following the quick start guide instructions and those in [Configuration and Management](#), helps to confirm if configuration issues cause failure. The most common issues with microwave radio links are:

- An improperly terminated antenna or transmission system
- Multipath propagation
- RF interference
- Path obstruction
- Misaligned antenna
- Faulty antenna
- Improper grounding
- Insufficient link margin in the design/implementation
- Moisture in the transmission system (antenna feed and/or RF cable)

If the radio link has been operating without issues and is exhibiting new poor performance behavior or becomes completely inoperative, the troubleshooting process should pay close attention to any conditions that may have changed between the time when the system was working without issue and the time when the issues started.

Also, it can be helpful to compare some performance parameters of the system before and after the presence of issues. Often the source of the issues can be determined by thoughtful consideration of changes, such as:

- Changes in weather, including high winds
- Changes made to the radio equipment, transmission system, or connected equipment
- New radio systems or electronic equipment the nearby radio or transmission system

- New construction nearby either end of the link, or along the path
- Tree growth, flooded fields, or changes in rivers/lakes along the path

Verify that configurations are set as follows:

- Frequency pair matches (oppositely) at each end of the link
- Mode (Modulation) matches at each end of the link
- Bandwidth matches at each end of the link
- Ethernet interfaces are enabled, as desired
- Ethernet interfaces are selected for Traffic, Management, or Traffic plus Management, as desired
- T1/E1 enabling matches at each end of the link
- Link security key matches at each end of the link

Also, use the *ExaltCalc* tool in the design phase to determine the optimum setting for the Bandwidth and TDD Frame Length parameters for the given link distance, and provides guidance to the expected RF link performance, as well as throughput, latency, and number of supported T1/E1 circuits.

Typical Indications of Issues

In many cases, microwave radio users do not notice changes or degradation to the radio system until the radio system fails completely or becomes highly errored or significantly intermittent. However, regular management of the radio system can help indicate changes in performance that have not yet impacted user performance, but may impact performance at a later date if left unchecked or unaddressed. The administrator can use this as an opportunity to be proactive and monitor the radio link performance regularly, watching for unexplained or unexpected changes in performance and trends in performance changes.

Most importantly, monitoring radio system RSL over time indicates the performance of the radio system. Address any long-term drop in RSL and erratic or unsteady RSL. Some RSL changes are expected and weather patterns and the related multipath can cause dramatic RSL changes resulting in system outage. However, that outage should not occur at a significantly greater rate than the designed long-term performance. Consult the path design engineer for more information about link reliability expectations and anticipated RSL deviation.

In addition, regular inspection of the transmission system (RF cables and antennas) and paying close attention to changes along the path, such as construction or tree height, or new microwave radio installations nearby, can be extremely helpful and proactive.

When link performance is very poor, alarms on the radio front panel and within the radio's management system indicates particular failures. Consult this manual for more information on the specific alarms and diagnostics, or contact Exalt Customer Care for assistance.

Exalt Customer Care is primarily motivated to determine if the radio hardware is faulty and require return for repair, and to help execute an effective and efficient repair and return process for radio terminals believed to be faulty. However, Exalt Customer Care provides advice regarding the total radio system and RF path engineering and environment, and advises on troubleshooting.

End users should first contact the installer and/or designer of the system. In many cases, an in-depth understanding of RF design is required, and on-site analysis and special test equipment, may be necessary. Compared to phone support from Exalt Customer Care, troubleshooting is much more expeditious if the professional installer and/or link designer examines the system and reviews the management information in the GUI. In turn, if the professional installer and/or link designer contacts

Exalt Customer Care, the process to rectify the system is much more expedient due to the in-depth knowledge related to the implementation and the RF environment.

Improper RF Cable Termination

Improper RF Cable termination is a common problem. In many cases, this is a problem that occurs during installation and is not a problem that suddenly appears. However, if cables are moved or flexed, especially near the termination points, and radio errors, changes in RSL or other performance issues occur, this is a sign of this issue.

Another method to test for this condition is to decrease the output power of the radio system (at each end, one end at a time). Poor RF cable termination may be reflecting too much RF energy back into the radio system, and reducing output power reduces the reflected energy at a faster rate than the transmitted energy towards the far end. Be careful not to reduce the output power to the point where the radio's threshold is reached. Typically, a reduction of just 3 to 6dB is enough to determine if this is the issue. If the reduction of output power clears the error condition, this is the likely cause.

Use a reflectometer or meter that can read VSWR at the operating frequency to identify poor terminations as well as poor antenna feeds.



Note: The Praxsym VSWR meter is an excellent tool for this purpose.

Multipath Propagation

Multipath propagation is a term that encompasses changes to the RF path, such as reflections and/or refraction, causing partial or complete destruction of the radio signal, and thus excessive bit errors and/or system outages.

Rapid changes in temperature, inversion layers, humidity, air pressure, water evaporation, as well as standing water or moisture on objects along the path are all examples of changes that can cause multipath propagation. New building construction near either end of the path or along the path can cause new reflection characteristics.

If your system has been operating without issue and is suddenly experiencing issues that are symptomatic of a certain time of day or related to change in climatic events or some of the external factors listed above, this is likely the cause. Consult a professional RF path engineer in these cases. Often, minor repositioning of the antennas at either or both ends can reduce or eliminate these problems.

RF Interference

RF interference is usually indicative of another radio system nearby either end of your radio system or aimed towards one or both ends of your radio system – usually at or near the same frequency and usually with a similar signal level. This is less common for licensed systems, but still can occur.

Other forms of RF interference also exist, such as electronic equipment placed close to the radio chassis or transmitters that couple onto the cabling or grounding system of the radio. Microwave ovens and wireless communication devices used near the equipment or cabling are examples of electronic equipment interference.

RF interference, like most other causes of problems, is indicated by significant bit errors and/or system outages.

One means to determine presence of interference is the use of a [Spectrum Analyzer](#) that covers the same range as the radio system. A professional RF engineer can use a spectrum analyzer to locate

sources of interference, measure these sources, and determine potential remedies to take to operate in the presence of interference.

If a spectrum analyzer is not available, the radio's RSL port can help determine RSL levels of interfering signals. By turning the far-end radio off, the residual RSL measured by the radio indicates the level of interference seen by the radio. It is possible that interference levels below that which can be measured still have an impact on the radio system – especially if the radio system has low fade margin or is using a high order modulation.

Repositioning the antenna and/or changing polarization, or upgrading the antenna to a higher gain, and/or using a high-performance antenna, are all secondary means that can be used. It may be necessary to perform combinations of both radio changes (retuning, occupied bandwidth reduction) and antenna system changes (position, polarization, upgrade). Local regulations may not permit antenna system changes without re-licensing or other notification.

Path Obstruction

A path obstruction is defined as an object, such as a building or tree, impeding the proper path of the radio system. If the system design was proper at the time of installation and issues arise at a later date, an updated path profile and survey may be necessary to identify changes in path clearance.

Misaligned Antenna

At the time of initial installation, it is critical that the antennas at each end are properly aligned and that the designed RSL is achieved. However, antennas may become misaligned due to high winds, changes in the guy-wiring systems keeping the antenna mast stable, or loosening of the antenna mounting hardware. A reduction in the RSL of the link is symptomatic of this condition, but this condition is not the only condition that results in a reduction of RSL. However, if conditions occur where the antenna alignment may be suspected, the mechanics must be inspected and the antennas realigned.

Faulty Antenna

A faulty antenna is rare, but is still a possibility. In some cases, the mechanics of the antenna feed can get moisture inside, or a bad or weak connection in the pin and connector structure of the antenna may occur. A VSWR measurement of the antenna connection can be made to verify this condition.

Improper Grounding

In addition to being a potential human safety issue, improper system grounding is a somewhat common condition that can cause continuous bit errors or bit errors when metal objects come in contact with the radio, transmission system, or racking system. If touching the radio causes errors, grounding is the cause. It can be difficult to identify grounding problems, but a professional electrician can normally inspect a system and identify if there are deficiencies in the grounding system.

Insufficient Link Margin

Ideally, the link was designed with enough link margin (fade margin) to allow for multipath propagation and atmospheric fading and still remain reliable. In some cases, link margin is compromised by economic factors, such as using low-cost RF cabling or lower-cost antennas that have less gain or deficient performance compared to higher cost transmission system components. In some cases, there may be antenna size restrictions that forced the design to not have the desired amount of link margin.

If the link was designed with poor link margin, there are likely many cases of bit errors and outages. The antenna system and transmission line can be upgraded to help reduce this. If the link design was installed with sufficient margin, but RSL is reduced, the remaining link margin may no longer be enough to maintain a reliable link. The causes of RSL reduction were previously described, but are usually due to new path obstruction(s) or antenna misalignment due to wind or mechanical factors. The antenna height or location can be changed to overcome new obstructions. Realignment of the antenna, and/or improvement to mechanical structures can help overcome antenna misalignment.

Moisture in the Transmission System

If the connectors on cables and antennas and egress junctions are not properly weatherproofed, moisture can get into the transmission system and cause significant error conditions and erratic performance. In many cases, the transmission system must be replaced. A VSWR meter is one means to identify such issues. Conduct physical inspections often. If changes to the weatherproofing (such as cracking) are noticed, replace the weatherproofing before leakage occurs.

Back-to-back Bench Testing

Use back-to-back bench testing to test the radio before installation, pre-configure the radio and connected equipment before installation, or in the troubleshooting process to identify if the radio hardware is the source of a system issue. It is a critical process, and often required or highly desirable for any installation or troubleshooting exercise. This section describes how to properly configure the radio hardware and accessories for a proper back-to-back bench test.

For radio testing, there are two types of back-to-back configurations:

- 1 Basic test (test general operation)
- 2 Specification performance verification

Basic Test

The basic test is a simple test of radio functionality. It verifies that the radios are properly configured to communicate to one another, and verifies general radio performance as operational.

For the basic test, the following items are needed:

- Radio pair
- Powering source
- RF interconnect cable(s) (any length – short is best)
- Fixed or variable attenuation, between 60 and 90dB (note: attenuation for basic test does not to be calibrated or precise)
- Computer/terminal with either serial or Ethernet port

If no computer is available, use the temporary hardware configuration key or DIP switch, depending on radio model (see [Initial Configuration and Back-to-Back Bench Test](#))

Connect the items as follows:

- 1 Connect attenuation and (known-good) RF cable(s) between radio pair, shown in Figure 66.
- 2 Configure the frequencies of the radio to be the same pair, with opposite Tx and Rx orientation.
- 3 Power on radio pair

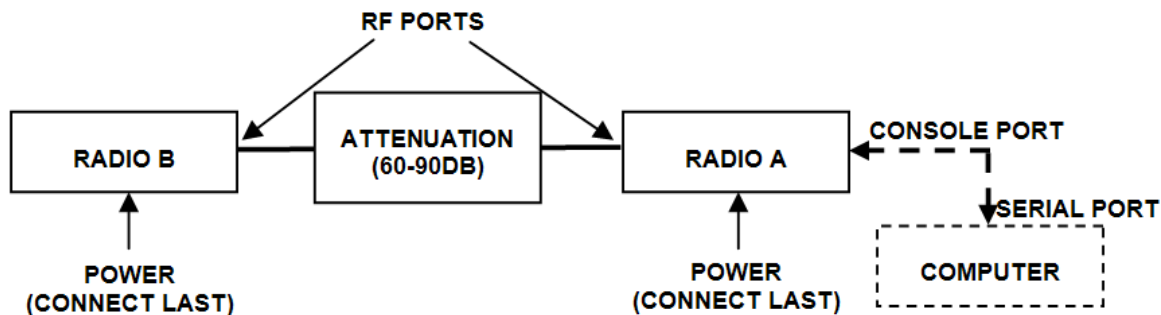

Figure 66 Basic back-to-back bench test configuration

After connecting and powering on and connecting a PC for GUI radio management, verify that the LINK and STATUS are green. If so, the radios are communicating and all radio-related alarm conditions are normal.

It can be beneficial to have a computer to verify configuration in case of red LEDs or to pre-configure the radio as desired for operation. Follow the instructions in [Configuration and Management](#).

Specification Performance Verification

The specification performance verification is a more detailed test that allows you to verify that the radio's output power and threshold specifications are being met. This is typically a test that would only be performed in a troubleshooting scenario, but can be performed before installation to provide a detailed record or ensure radio performance before installation.

This test is identical to the basic test, but in place of the fixed attenuation, it requires the use of calibrated variable attenuation, or a set of calibrated fixed attenuators, or a combination of both, adding to a total attenuation value of 120dB, as measured at the operating frequency of the radio. In addition, a volt meter or computer is also required.

Connect the system as shown in Figure 66, using the combination of fixed and variable attenuation between the radio's RF ports. Connect the volt meter to either radio's RSL test point and associated reference ground connection.

In this test, it is desirable to use pre-tested RF cables, known to be good, and the insertion loss is known at the operating frequency. If the cables are short (6'2m or less), you can estimate the loss, including connectors, to be less than 1dB each. The estimate of cable loss is critical to the overall confidence of the measurements made in this test.

There are two critical specifications that can be tested in this configuration:

- RF output power
- Radio receiver threshold

To measure transmitter output power, simply insert any value of attenuation between the radios between 60 and 90dB. Ensure that both RF output power settings are at maximum. Use the volt meter to measure RSL in both directions. The RSL measured value should match the appropriate value according to the inserted attenuation, such as:

$$RSL = RF \text{ Output Power} - \text{cabling losses} - \text{total attenuation}$$

Verify output power by adjusting output power using the Exalt GUI (in administration mode) and evaluate the corresponding change to the RSL measurement.

For threshold testing, the key is to insert a measured amount of loss that is close to, but not exceeding the radio's specified system gain. System gain is the difference between RF output power and receiver threshold. At your selected modulation and bandwidth settings, determine the specified threshold performance, and choose a value of attenuation (including cable losses) that adds to roughly 5 to 15dB less than the system gain.

Choose a value of total attenuation in the range of roughly 100–105dB. Once this attenuation is inserted, verify RSL readings as in the first step, and then, using the GUI, reduce radio output power in 1dB steps until the receiving radio (the one whose output power not being adjusted) Link LED turns from green to yellow. This indicates that threshold has been reached. At this point, verify the equation for system gain using the new output power level setting and verify that the threshold performance is meeting or exceeding the published specification.



Note: Due to the variation of measurements and accuracies involved in this test, you may read a measurement that is 1dB to as much as 2dB off of the expected value. It should be of no concern unless the value is more than 3dB worse than expected.

Once threshold is verified in this direction, repeat the process in the opposite direction by adjusting RF output power of the radio at the opposite end. Return the first radio to its original power setting before adjusting the second radio.

General Compliance and Safety

The usage of radio transmission devices is subject to specific regulatory requirements governed by regional legislation. In most cases, the specific device must be authorized for use in a given country and must be installed and adjusted in accordance with specific radio-frequency settings and in a manner that has been authorized specific to the device itself in accordance with the specific location of the device. Some users may be completely or partially restricted from use of the device. Please consult local governmental agency/agencies for regulatory requirements before use, or contact Exalt or your Exalt authorized dealer for assistance.

Do not modify this device in any way without the express written consent of Exalt. Modification voids the manufacturer warranty, and may also be illegal in accordance to government regulations. In addition, there are no user-serviceable parts or assemblies inside the product housing. There may also be voltages, signals, and mechanisms within the device that could be harmful to human safety.

The mounting of this device and associated peripherals and connections (inclusive of antenna mast, antenna, cabling, egress, lightning protection devices, grounding, power, and so on) may be subject to regional requirements for health and human safety. A qualified professional installer and an electrician are highly recommended, and may be required by law.

Safety Notices

- 1 Review this entire guide for important installation instructions BEFORE attempting to install this product.
- 2 This product is intended to be installed, used, and maintained by experienced telecommunications personnel only.
- 3 Employ a properly licensed or authorized electrician to install or evaluate/certify the installation of all power and grounding related to the use of this equipment and all connected devices.
- 4 The device(s) shall only be connected to AC power sources provided by the supplier or to DC sources within the device specifications. Use a separate breaker circuit at the power source.
- 5 When removing power, remove ALL sources of supply.
- 6 Lightning, surge protection devices, and earth grounding are required for most installations to ensure human safety. Consult a qualified electrician.
- 7 Servicing of this device should be performed by authorized personnel only. Do not disassemble this device. By opening or removing any covers you may expose yourself to hazardous energy parts. Incorrect reassembly of this product can cause a malfunction, and/or electrical shock, when the unit is subsequently used.
- 8 Do not insert any object of any shape or size inside this product at any time, whether powered or not. Objects may contact hazardous energy components that could result in a risk of fire or personal injury.
- 9 Liquids shall not come in contact with, or enter the inside of the device at any time.
- 10 Proper ventilation and/or airflow shall be provided surrounding the equipment. Items shall not come in contact with heat-sinking materials. Ensure that ambient operational and storage temperature specifications are maintained at all times.
- 11 Equipment is suitable for mounting on noncombustible surfaces only.
- 12 Do not move or alter the marking labels.
- 13 A CSU or similar isolating device is necessary between the equipment and the public telecommunications network. The equipment has not been evaluated for direct connection to the public telecommunications network.



Warning! – Class 1 Laser – Invisible laser radiation may be emitted from the aperture of the port when no cable is connected, avoid exposure to laser radiation and do not stare into apertures.

Regulatory Notices

This section presents the Regulatory Compliance Regulations for your country.

United States Compliance

The 6 and 11GHz EX-i Series GigE (FDD) product family operates under FCC Rule Parts 101 as a licensed device. The 5GHz EXi-Series GigE product family operate under FCC Rule Part 15.407 (b) (4) (ii) as license-exempt devices. They may only be used as a point-to-point transmission device for fixed or temporary-fixed (non-mobile) installations. The devices are subject to the following restrictions:

- Do not use external amplifiers to boost the power or overcome transmission system losses, unless the specific amplifier/cable/antenna combination has expressly been authorized by the FCC. The output power must never exceed +30 dBm.
- Cross-border transmissions are expressly prohibited, except with written permission from both the FCC and the governing body of the neighboring country (Cofetel for Mexico; Industry Canada for Canada).
- Use only parabolic dish antennas (see Table 7). No other types of antennas (panel, omni-directional, yagi, and so on) are authorized. For 5GHz models, maximum mid-band gain of parabolic dish antennas certified is 37.9dBi (6'/1.8m diameter).

Note: The 5GHz model is approved under FCC Rule Part 15.407(b)(4)(ii) for antenna gains greater than 10dBi.



The 5GHz model cannot be manufactured, marketed, or sold after March 2, 2018 unless it is re-certified under FCC Rule Part 15.407(b)(4)(i).

Check with Exalt Wireless for status of re-certification.

Federal Communications Commission (FCC), United States

The device is allowed to be used provided it does not cause interference to other devices. It is not guaranteed to provide protection against interference from other electronic and radio devices.

(5GHz models only) This device complies with Part 15 of the FCC Rules. Operation is subject to the following two conditions:

- 1 This device may not cause harmful interference, and
- 2 This device must accept any interference received, including interference that may cause undesired operation.

The system has been tested and found to comply with the limits of a Class B digital device, pursuant to Part 15 of the FCC Rules. These limits are designed to provide reasonable protection against harmful interference in a residential installation. This equipment generates uses and can radiate radio frequency energy and, if not installed and used in accordance with the instructions, may cause harmful interference to radio communications. However, there is no guarantee that interference will not occur in a particular installation. If this equipment does cause harmful interference to radio or television reception, which can be determined by turning the equipment off and on, the user is encouraged to try to correct the interference by one of more of the following measures:

- Reorient or relocate the receiving antenna.
- Increase the separation between the equipment and receiver.

- Connect the equipment into an outlet on a circuit different from that to which the receiver is connected.
- Consult the dealer or an experienced radio/TV technician for help.

Shielded cables and I/O cords must be used for this equipment to comply with the relevant FCC regulations.

Changes or modifications not expressly approved in writing by Exalt may void the user's authority to operate this equipment.

This device must be professionally installed.

To comply with regulations, the output power of this device may need to be adjusted in accordance to the associated transmission system. See [RF Output Power Setting](#) for details.

The antenna associated with this device shall be mounted in a location that is at least 22.21'/6.77m away from humans who may be subject to long-term or continuous exposure.

Canada Compliance

The 6 and 11GHz EX-i Series GigE (FDD) radios operate under ICES-003 of Industry Canada regulations. The 5GHz EX-i Series GigE radios operate under RSS-210 of Industry Canada regulations. Operation is subject to the following conditions, unless express permission is granted by Industry Canada to operate in a different manner:

- External amplifiers cannot be used to boost the power or to overcome transmission system losses, unless the specific amplifier/cable/antenna combination is expressly authorized by Industry Canada.
- Cross-border transmissions are expressly prohibited, except with written permission from both Industry Canada and the governing body of the neighboring country (FCC for USA)
- Only parabolic dish antennas may be used. No other types of antennas (panel, omni-directional, yagi, and so on) are authorized

Industry Canada (IC), Canada (for 5GHz models)

This Class B digital apparatus meets all the requirements for the Canadian Interference-Causing Equipment Regulations.

Cet appareil numérique de la classe B respecte les exigences du Règlement sur le matériel brouilleur du Canada.

This device complies with Industry Canada licence-exempt RSS standard(s). Operation is subject to the following two conditions: (1) this device may not cause interference, and (2) this device must accept any interference, including interference that may cause undesired operation of the device.

Le présent appareil est conforme aux CNR d'Industrie Canada applicables aux appareils radio exempts de licence. L'exploitation est autorisée aux deux conditions suivantes : (1) l'appareil ne doit pas produire de brouillage, et (2) l'utilisateur de l'appareil doit accepter tout brouillage radioélectrique subi, même si le brouillage est susceptible d'en compromettre le fonctionnement.

Antennas Supported in Canada

The 5GHz Ex-i Series GigE models are designed to operate with the antennas with a maximum mid-band gain of 37.5dBi (see Table 7). Antennas with mid-band gain higher than 37.5dBi are strictly forbidden for use with these devices. The required antenna impedance is 50 Ohms.

Regulatory Compliance

As of this printing, Exalt Wireless, Inc. has approvals for the products that are covered by this manual in the USA (FCC) and Canada (IC). If your application is for a different country, check with your Sales Representative for the current status.

EIRP Limits for the United States and Canada



Note: The professional installer is responsible to ensure that RF output power is properly adjusted to not exceed regulatory limits.

5725–5850 MHz Band

For 5GHz EX-i Series GigE models within the 5725–5850 MHz band, the maximum EIRP allowed is 67.9 dBm. The maximum output power of the radio is +30dBm in all modulations.

$$P = 67.9 - G + L$$

where:

- P = Maximum transmitter output power of radio, in dBm.
- G = Specified gain of antenna, in dBi, from 5725 to 5850 MHz.
- L = Total transmission system losses of all elements between the radio's RF connector and the antenna's RF connector (all cables, connectors, lightning suppressors), in dB, as specified or measured between 5725 and 5850 MHz.

Licensing 6 and 11GHz Models

Frequency coordination for EX-i Series GigE (FDD) radios is normally required by local regulations. To obtain and maintain licensing, consult the licensing authorities.



Note: The professional installer is responsible to ensure that RF output power, channel assignment, bandwidth, and modulation are properly adjusted in accordance with local regulatory requirements and licensing, if any. Antenna models and polarization are usually specified within the licensing requirements.

United States

In the US frequency coordination is often conducted by a Certified Frequency Coordinator (CFC), who coordinates spectrum allocation for the Federal Communications Commission (FCC). CFCs assist applicants with licensing. Applicants can also apply using the FCC's Universal Licensing System (ULS) online at:

<http://wireless.fcc.gov/uls/index.htm?job=home>

You must first register with the FCC to use the on-line system, and obtain an FCC Registration Number (FRN). The FRN identifies you in all transactions to the FCC.

Exalt provides EX-i Series GigE (FDD) radio information to the following CFCs:

- Comsearch (www.comsearch.com/)
- Micronet Communications, Inc. (www.micronetcom.com)
- Radio Dynamics (www.radyn.com)

Upon request, EX-i Series GigE (FDD) radio information can be provided to any CFC.

Canada

In Canada frequency coordination is often conducted by a National Frequency Coordinator (NFC), who coordinates spectrum allocation for Industry Canada (IC). NFCs assist applicants in licensing. Applicants can also apply using the IC's online system at:

<http://sd.ic.gc.ca/engdoc/main.jsp#LicenceApplications>

You must first register with the IC to use the online system.

Antennas 5GHz Models

Table 7 lists antennas supported by the 5GHz Exi Series GigE models for use in the USA. In some countries, antennas exceeding a certain level of gain may be unlawful. Refer to [RF Output Power Setting](#) for details on regulatory limits.

Table 7 Supported 5GHz antennas

Manufacturer	Model #	Description	Midband Gain (dBi)	3dB (Azimuth/Elevation) Beamwidth (degrees)
Andrew	P2F-52-N	2-foot Dish	29.4	5.4
Andrew	PX2F-52-N	2-foot Xpol Dish	29.4	5.4
Andrew	P3F-52-N	3-foot Dish	33.4	3.8
Andrew	PX3F-52-N	3-foot Xpol Dish	33.4	3.8
Andrew	P4F-52-N	4-foot Dish	34.9	3.0
Andrew	PX4F-52-N	4-foot Xpol Dish	34.9	3.0
Andrew	HP2F-52-NPA	2-foot HP Dish	29.0	5.4
Andrew	HPX2F-52-NPA	2-foot Xpol HP	29.0	5.4
Andrew	HP3F-52-NPA	3-foot HP Dish	33.0	3.8
Andrew	HPX3F-52-NPA	3-foot Xpol HP	33.0	3.8
Andrew	HP4F-52-NPA	4-foot HP Dish	34.5	3.0
Andrew	HPX4F-52-NPA	4-foot Xpol HP	34.5	3.0
Andrew	HP6F-52-NPA	6-foot HP Dish	37.2	1.8
Andrew	HPX6F-52-NPA	6-foot Xpol HP	37.2	1.8
Gabriel	QF2-52-N	2-foot Dish	28.5	5.6
Gabriel	QF2.5-52-N	2.5-foot Dish	31.2	4.4
Gabriel	QF4-52-N	4-foot Dish	34.8	2.7
Gabriel	QFD2-52	2-foot Xpol Dish	28.4	5.6
Gabriel	QFD2.5-52	2.5-foot Xpol Dish	31.1	4.4
Gabriel	QFD4-52	4-foot Xpol Dish	34.7	2.7
Gabriel	HQF2-52-N	2-foot HP Dish	28.2	5.7
Gabriel	HQF4-52-N	4-foot HP Dish	34.4	2.8
Gabriel	HQF6-52-N	6-foot HP Dish	37.4	1.9
Gabriel	HQFD2-52	2-foot Xpol HP	28.1	5.7
Gabriel	HQFD2.5-52	2.5-foot Xpol HP	30.7	4.5
Gabriel	HQFD4-52	4-foot Xpol HP	34.3	2.8
Gabriel	HQFD6-52	6-foot Xpol HP	37.3	1.9
Radio Waves	SP1-5.2	1-foot Dish	22.5	11.1
Radio Waves	SP2-5.2	2-foot Dish	29.0	6.1
Radio Waves	HP2-5.2	2-foot HP Dish	28.6	6.1
Radio Waves	SP3-5.2	3-foot Dish	32.0	4.0
Radio Waves	SP4-5.2	4-foot Dish	34.8	3.0
Radio Waves	SPD2-5.2	2-foot Xpol Dish	28.1	6.2
Radio Waves	SPD3-5.2	3-foot Xpol Dish	31.1	4.2
Radio Waves	SPD4-5.2	4-foot Xpol Dish	34.4	3.1
Radio Waves	SPD6-5.2	6-foot Xpol Dish	37.5	2.1

Table 7 Supported 5GHz antennas (Continued)

Manufacturer	Model #	Description	Midband Gain (dBi)	3dB (Azimuth/Elevation) Beamwidth (degrees)
RFS	SPF2-52A	2-foot Dish	27.9	6.2
RFS	SPF3-52A	3-foot Dish	31.4	4.2
RFS	SPF4-52A	4-foot Dish	33.9	3.1
RFS	SPF6-52A	6-foot Dish	37.4	2.1
RFS	SDF4-52A	4-foot HP Dish	33.9	3.1
RFS	SDF6-52A	6-foot HP Dish	37.4	2.1

Copyright Notices

This section presents copyright notices for third-party software licensed to Exalt Wireless, Inc.

Net-SNMP

The following copyright notice applies to the open-source licensing agreement for Net-SNMP.

Copyright 1989, 1991, 1992 by Carnegie Mellon University

Derivative Work - 1996, 1998-2000

Copyright 1996, 1998-2000 The Regents of the University of California

All Rights Reserved

Permission to use, copy, modify and distribute this software and its documentation for any purpose and without fee is hereby granted, provided that the above copyright notice appears in all copies and that both that copyright notice and this permission notice appear in supporting documentation, and that the name of CMU and The Regents of the University of California not be used in advertising or publicity pertaining to distribution of the software without specific written permission.

CMU AND THE REGENTS OF THE UNIVERSITY OF CALIFORNIA DISCLAIM ALL WARRANTIES WITH REGARD TO THIS SOFTWARE, INCLUDING ALL IMPLIED WARRANTIES OF MERCHANTABILITY AND FITNESS. IN NO EVENT SHALL CMU OR THE REGENTS OF THE UNIVERSITY OF CALIFORNIA BE LIABLE FOR ANY SPECIAL, INDIRECT OR CONSEQUENTIAL DAMAGES OR ANY DAMAGES WHATSOEVER RESULTING FROM THE LOSS OF USE, DATA OR PROFITS, WHETHER IN AN ACTION OF CONTRACT, NEGLIGENCE OR OTHER TORTIOUS ACTION, ARISING OUT OF OR IN CONNECTION WITH THE USE OR PERFORMANCE OF THIS SOFTWARE.

Network Associates Technology, Inc.

Copyright (c) 2001-2003, Networks Associates Technology, Inc

All rights reserved.

Redistribution and use in source and binary forms, with or without modification, are permitted provided that the following conditions are met:

- * Redistributions of source code must retain the above copyright notice, this list of conditions and the following disclaimer.
- * Redistributions in binary form must reproduce the above copyright notice, this list of conditions and the following disclaimer in the documentation and/or other materials provided with the distribution.
- * Neither the name of the Networks Associates Technology, Inc nor the names of its contributors may be used to endorse or promote products derived from this software without specific prior written permission.

THIS SOFTWARE IS PROVIDED BY THE COPYRIGHT HOLDERS AND CONTRIBUTORS "AS IS" AND ANY EXPRESS OR IMPLIED WARRANTIES, INCLUDING, BUT NOT LIMITED TO, THE IMPLIED WARRANTIES OF MERCHANTABILITY AND FITNESS FOR A PARTICULAR PURPOSE ARE DISCLAIMED. IN NO EVENT SHALL THE COPYRIGHT HOLDERS OR CONTRIBUTORS BE LIABLE FOR ANY DIRECT, INDIRECT, INCIDENTAL, SPECIAL, EXEMPLARY, OR CONSEQUENTIAL DAMAGES (INCLUDING, BUT NOT LIMITED TO, PROCUREMENT OF SUBSTITUTE GOODS OR SERVICES; LOSS OF USE, DATA, OR PROFITS; OR BUSINESS INTERRUPTION) HOWEVER CAUSED AND ON ANY THEORY OF LIABILITY, WHETHER IN CONTRACT, STRICT LIABILITY, OR TORT (INCLUDING

NEGLIGENCE OR OTHERWISE) ARISING IN ANY WAY OUT OF THE USE OF THIS SOFTWARE, EVEN IF ADVISED OF THE POSSIBILITY OF SUCH DAMAGE.

Cambridge Broadband, Ltd.

Portions of this code are copyright (c) 2001-2003, Cambridge Broadband Ltd.

All rights reserved.

Redistribution and use in source and binary forms, with or without modification, are permitted provided that the following conditions are met:

- * Redistributions of source code must retain the above copyright notice, this list of conditions and the following disclaimer.
- * Redistributions in binary form must reproduce the above copyright notice, this list of conditions and the following disclaimer in the documentation and/or other materials provided with the distribution.
- * The name of Cambridge Broadband Ltd. may not be used to endorse or promote products derived from this software without specific prior written permission.

THIS SOFTWARE IS PROVIDED BY THE COPYRIGHT HOLDER ``AS IS" AND ANY EXPRESS OR IMPLIED WARRANTIES, INCLUDING, BUT NOT LIMITED TO, THE IMPLIED WARRANTIES OF MERCHANTABILITY AND FITNESS FOR A PARTICULAR PURPOSE ARE DISCLAIMED. IN NO EVENT SHALL THE COPYRIGHT HOLDER BE LIABLE FOR ANY DIRECT, INDIRECT, INCIDENTAL, SPECIAL, EXEMPLARY, OR CONSEQUENTIAL DAMAGES (INCLUDING, BUT NOT LIMITED TO, PROCUREMENT OF SUBSTITUTE GOODS OR SERVICES; LOSS OF USE, DATA, OR PROFITS; OR BUSINESS INTERRUPTION) HOWEVER CAUSED AND ON ANY THEORY OF LIABILITY, WHETHER IN CONTRACT, STRICT LIABILITY, OR TORT (INCLUDING NEGLIGENCE OR OTHERWISE) ARISING IN ANY WAY OUT OF THE USE OF THIS SOFTWARE, EVEN IF ADVISED OF THE POSSIBILITY OF SUCH DAMAGE.

Sun Microsystems, Inc.

Copyright © 2003 Sun Microsystems, Inc., 4150 Network Circle, Santa Clara, California 95054, U.S.A. All rights reserved.

Use is subject to license terms below.

This distribution may include materials developed by third parties.

Sun, Sun Microsystems, the Sun logo and Solaris are trademarks or registered trademarks of Sun Microsystems, Inc. in the U.S. and other countries.

Redistribution and use in source and binary forms, with or without modification, are permitted provided that the following conditions are met:

- * Redistributions of source code must retain the above copyright notice, this list of conditions and the following disclaimer.
- * Redistributions in binary form must reproduce the above copyright notice, this list of conditions and the following disclaimer in the documentation and/or other materials provided with the distribution.
- * Neither the name of the Sun Microsystems, Inc. nor the names of its contributors may be used to endorse or promote products derived from this software without specific prior written permission.

THIS SOFTWARE IS PROVIDED BY THE COPYRIGHT HOLDERS AND CONTRIBUTORS "AS IS" AND ANY EXPRESS OR IMPLIED WARRANTIES, INCLUDING, BUT NOT LIMITED TO, THE IMPLIED WARRANTIES OF MERCHANTABILITY AND FITNESS FOR A PARTICULAR

PURPOSE ARE DISCLAIMED. IN NO EVENT SHALL THE COPYRIGHT HOLDERS OR CONTRIBUTORS BE LIABLE FOR ANY DIRECT, INDIRECT, INCIDENTAL, SPECIAL, EXEMPLARY, OR CONSEQUENTIAL DAMAGES (INCLUDING, BUT NOT LIMITED TO, PROCUREMENT OF SUBSTITUTE GOODS OR SERVICES; LOSS OF USE, DATA, OR PROFITS; OR BUSINESS INTERRUPTION) HOWEVER CAUSED AND ON ANY THEORY OF LIABILITY, WHETHER IN CONTRACT, STRICT LIABILITY, OR TORT (INCLUDING NEGLIGENCE OR OTHERWISE) ARISING IN ANY WAY OUT OF THE USE OF THIS SOFTWARE, EVEN IF ADVISED OF THE POSSIBILITY OF SUCH DAMAGE.

Sparta, Inc.

Copyright (c) 2003-2005, Sparta, Inc

All rights reserved.

Redistribution and use in source and binary forms, with or without modification, are permitted provided that the following conditions are met:

- * Redistributions of source code must retain the above copyright notice, this list of conditions and the following disclaimer.
- * Redistributions in binary form must reproduce the above copyright notice, this list of conditions and the following disclaimer in the documentation and/or other materials provided with the distribution.
- * Neither the name of Sparta, Inc nor the names of its contributors may be used to endorse or promote products derived from this software without specific prior written permission.

THIS SOFTWARE IS PROVIDED BY THE COPYRIGHT HOLDERS AND CONTRIBUTORS "AS IS" AND ANY EXPRESS OR IMPLIED WARRANTIES, INCLUDING, BUT NOT LIMITED TO, THE IMPLIED WARRANTIES OF MERCHANTABILITY AND FITNESS FOR A PARTICULAR PURPOSE ARE DISCLAIMED. IN NO EVENT SHALL THE COPYRIGHT HOLDERS OR CONTRIBUTORS BE LIABLE FOR ANY DIRECT, INDIRECT, INCIDENTAL, SPECIAL, EXEMPLARY, OR CONSEQUENTIAL DAMAGES (INCLUDING, BUT NOT LIMITED TO, PROCUREMENT OF SUBSTITUTE GOODS OR SERVICES; LOSS OF USE, DATA, OR PROFITS; OR BUSINESS INTERRUPTION) HOWEVER CAUSED AND ON ANY THEORY OF LIABILITY, WHETHER IN CONTRACT, STRICT LIABILITY, OR TORT (INCLUDING NEGLIGENCE OR OTHERWISE) ARISING IN ANY WAY OUT OF THE USE OF THIS SOFTWARE, EVEN IF ADVISED OF THE POSSIBILITY OF SUCH DAMAGE.

Cisco, Inc.

Copyright (c) 2004, Cisco, Inc and Information Network

Center of Beijing University of Posts and Telecommunications.

All rights reserved.

Redistribution and use in source and binary forms, with or without modification, are permitted provided that the following conditions are met:

- * Redistributions of source code must retain the above copyright notice, this list of conditions and the following disclaimer.
- * Redistributions in binary form must reproduce the above copyright notice, this list of conditions and the following disclaimer in the documentation and/or other materials provided with the distribution.
- * Neither the name of Cisco, Inc, Beijing University of Posts and Telecommunications, nor the names of their contributors may be used to endorse or promote products derived from this software without specific prior written permission.

THIS SOFTWARE IS PROVIDED BY THE COPYRIGHT HOLDERS AND CONTRIBUTORS "AS IS" AND ANY EXPRESS OR IMPLIED WARRANTIES, INCLUDING, BUT NOT LIMITED TO, THE IMPLIED WARRANTIES OF MERCHANTABILITY AND FITNESS FOR A PARTICULAR PURPOSE ARE DISCLAIMED. IN NO EVENT SHALL THE COPYRIGHT HOLDERS OR CONTRIBUTORS BE LIABLE FOR ANY DIRECT, INDIRECT, INCIDENTAL, SPECIAL, EXEMPLARY, OR CONSEQUENTIAL DAMAGES (INCLUDING, BUT NOT LIMITED TO, PROCUREMENT OF SUBSTITUTE GOODS OR SERVICES; LOSS OF USE, DATA, OR PROFITS; OR BUSINESS INTERRUPTION) HOWEVER CAUSED AND ON ANY THEORY OF LIABILITY, WHETHER IN CONTRACT, STRICT LIABILITY, OR TORT (INCLUDING NEGLIGENCE OR OTHERWISE) ARISING IN ANY WAY OUT OF THE USE OF THIS SOFTWARE, EVEN IF ADVISED OF THE POSSIBILITY OF SUCH DAMAGE.

Fabasoft R&D Software GmbH & Co.

Copyright (c) Fabasoft R&D Software GmbH & Co KG, 2003

oss@fabasoft.com

Author: Bernhard Penz

Redistribution and use in source and binary forms, with or without modification, are permitted provided that the following conditions are met:

- * Redistributions of source code must retain the above copyright notice, this list of conditions and the following disclaimer.
- * Redistributions in binary form must reproduce the above copyright notice, this list of conditions and the following disclaimer in the documentation and/or other materials provided with the distribution.

END USER AGREEMENT

(including Limited Hardware Warranty, Software License and RMA Procedure)

THIS IS AN AGREEMENT BETWEEN YOU (AS ORIGINAL END USER PURCHASER OF AN EXALT PRODUCT) AND EXALT WIRELESS, INC. ("EXALT"). THE END USER AGREEMENT APPLICABLE TO YOUR EXALT PRODUCT IS THE END USER AGREEMENT THAT IS PRE-LOADED ON THE EXALT PRODUCT, OR IF NONE IS PRE-LOADED, IT IS THE END USER AGREEMENT AVAILABLE ON THE EXALT WEBSITE @ [WWW.EXALTCOM.COM / EULA](http://WWW.EXALTCOM.COM/EULA) ON THE DATE OF YOUR PURCHASE OF THE EXALT PRODUCT OR OTHERWISE DIRECTLY AVAILABLE FROM EXALT UPON REQUEST. BY ACCEPTING THIS AGREEMENT OR BY USING THE EXALT PRODUCT WITH OR FOR WHICH THIS AGREEMENT IS PROVIDED ("PRODUCT"), YOU ARE AGREEING TO ALL OF THE BELOW TERMS AND CONDITIONS. IF YOU DO NOT AGREE WITH THESE TERMS AND CONDITIONS, YOU SHOULD NOT USE THE PRODUCT AND PROMPTLY RETURN IT TO YOUR PLACE OF PURCHASE FOR A REFUND. "YOU" MEANS THE LEGAL END USER ENTITY THAT PURCHASED THE PRODUCT FOR ITS OWN USE.

1 Exalt Limited Hardware Warranty

- a. Exalt warrants solely to the original purchaser ("Purchaser") that the Exalt hardware product that this Agreement is provided with or for (the "Hardware Product") will substantially conform in all material respects to the relevant Exalt published specifications that apply at the time of manufacture of such Hardware Product for two (2) years from the date of purchase of Hardware Product by Purchaser (the "Warranty Period"). Proof-of-purchase in the form of an invoice, payment of invoice, or delivery waybill must be supplied, if requested by Exalt, in case of any dispute of warranty start date.
- b. In the event Purchaser notifies Exalt during the Warranty Period of a defective Hardware Product (material nonconformance with the published specifications), Exalt shall within the Warranty Period, at its own option either: (A) use reasonable efforts to remedy any reproducible Hardware Product defect covered by this limited warranty within a reasonable period of time; (B) replace the defective Hardware Product with a functionally equivalent product (repair parts and products may be either reconditioned or new, but, if reconditioned, shall be of the same quality as new parts or products); or (C) if Exalt determines that it is unable to repair or replace such Hardware Product, Exalt (or its applicable reseller) will refund to Purchaser the amount actually paid by Purchaser for the applicable Hardware Product. All replaced parts and products become the property of Exalt.
- c. The Exalt warranty does not cover any defective Hardware Product that (i) is subject to the exclusions set forth below in Section 3; (ii) cannot be demonstrated to have a defect of the types of defects covered by the Exalt warranty, or (iii) Purchaser is unable to provide adequate information describing how the Hardware Product failed that would allow Exalt to determine that the defect is covered by the Exalt warranty. Any Hardware Product that is returned by the Purchaser to Exalt and Exalt determines that such product is not covered by the Exalt warranty, will be, at Purchaser's option and expense (including any applicable shipping, handling, evaluation, repair, replacement and disposal fees), either be: (a) returned to Purchaser in the state received, (b) repaired or replaced, as applicable, and returned to Purchaser, or disposed of in accordance with Purchaser's instructions. Repaired or replaced Hardware Product will be warranted for the remainder of the original Warranty Period, but not less than ninety (90) days.

2 Warranty Registration

In order to facilitate warranty service and communication with Exalt, Exalt recommends that the Purchaser registers the Hardware Product with Exalt promptly following the Hardware Product purchase by providing to Exalt the requested registration information. *Product registration may be performed by completing and submitting the product registration form on www.exaltcom.com/ProductRegistration.*

3 Limited Hardware Warranty Exclusions

This limited warranty will not apply to: (A) any Hardware Product that: (i) has been modified or altered by any party other than Exalt; (ii) has been subject to accident, misuse, neglect, or mistreatment; (iii) has been damaged during installation of the Hardware Product; (iv) has been damaged by failure of Purchaser or its agents to follow Exalt's instructions or specifications; (v) has been damaged by the equipment or system with which the Hardware Product is used; (vi) has sustained damage to the Hardware Products' interface or power connectors; (vii) is determined to be stolen; or (viii) has been damaged by water, fire, power changes, other hazards, or acts of God (including without limitation lightning); (B) any Software included in any such Hardware Product (see Software License below), or (C) any consumables. The warranty applies only to Hardware Products manufactured by or for Exalt and that can be identified by the Exalt trademark, trade name, serial number or logo affixed to them. Other products, including any third-party manufacturer products sold by Exalt on a resale basis, are subject to the applicable third-party manufacturer's warranty and end user agreement and are not warranted by Exalt. The Hardware Products covered by this warranty are not consumer products and are not intended for personal, family, or household purposes, nor are they intended for high-risk activities as described in Section 5 below.

4 Hardware Product RMA Procedure

A return material authorization (RMA) is required prior to returning Hardware Product to Exalt for in-warranty or out-of-warranty repair/evaluation. As such, Purchaser must use the then current Exalt RMA procedure. Such procedure is available on the Exalt website @ www.exaltcom.com/RMA or directly from Exalt upon request.

PRODUCTS RETURNED WITHOUT A DULY ISSUED RMA NUMBER WILL BE RETURNED TO PURCHASER BY EXALT AT PURCHASER'S EXPENSE.

5 PRODUCT WARRANTY DISCLAIMER AND LIMITATION OF LIABILITY

a. THE ABOVE EXPRESS LIMITED WARRANTY FOR THE HARDWARE PRODUCT, THE CONDITIONS AND OTHER TERMS SET FORTH IN THIS AGREEMENT ARE IN LIEU OF ALL OTHER WARRANTIES, CONDITIONS AND OTHER TERMS WHETHER EXPRESS, IMPLIED OR STATUTORY, REGARDING THE PRODUCT (HARDWARE PRODUCT AND SOFTWARE) AND ANY SERVICES PROVIDED BY EXALT, AND EXALT, ITS SUPPLIERS AND LICENSORS HEREBY EXPRESSLY DISCLAIM, TO THE EXTENT ALLOWED BY APPLICABLE LAW, ANY AND ALL SUCH EXPRESS, IMPLIED AND STATUTORY WARRANTIES, CONDITIONS AND OTHER TERMS, INCLUDING WITHOUT LIMITATION ANY AND ALL IMPLIED WARRANTIES OF FITNESS FOR A PARTICULAR PURPOSE, TITLE, INTERFERENCE WITH QUIET ENJOYMENT, NON-INFRINGEMENT OF THIRD-PARTY RIGHTS AND MERCHANTABILITY. FURTHER, EXALT DOES NOT WARRANT RESULTS OF USE OR THAT YOUR USE OF THE PRODUCT WILL BE UNINTERRUPTED OR ERROR FREE. NO WARRANTIES ARE MADE BY EXALT'S SUPPLIERS OR LICENSORS. EXCEPT FOR THE ABOVE EXPRESS LIMITED WARRANTY FOR THE HARDWARE PRODUCT, THE CONDITIONS AND OTHER TERMS STATED HEREIN, THE

PRODUCT IS PROVIDED "AS IS" AND WITH ALL FAULTS. THE ENTIRE RISK AS TO SATISFACTORY QUALITY, ACCURACY, AND EFFORT IS WITH YOU.

- b. THE PRODUCT IS NOT FAULT-TOLERANT AND IS NOT DESIGNED, MANUFACTURED OR INTENDED FOR USE OR RESALE AS ONLINE CONTROL EQUIPMENT IN HAZARDOUS ENVIRONMENTS REQUIRING FAIL-SAFE PERFORMANCE, SUCH AS IN THE OPERATION OF NUCLEAR FACILITIES, AIRCRAFT NAVIGATION OR COMMUNICATION SYSTEMS, AIR TRAFFIC CONTROL, DIRECT LIFE SUPPORT MACHINES OR WEAPONS SYSTEMS, IN WHICH THE FAILURE OF THE PRODUCT COULD LEAD DIRECTLY TO DEATH, PERSONAL INJURY, OR SEVERE PHYSICAL OR ENVIRONMENTAL DAMAGE. EXALT AND ITS SUPPLIERS AND LICENSORS SPECIFICALLY DISCLAIM ANY EXPRESS OR IMPLIED WARRANTY OF FITNESS FOR ANY HIGH-RISK USES LISTED ABOVE.
- c. REGARDLESS OF WHETHER ANY REMEDY SET FORTH HEREIN FAILS OF ITS ESSENTIAL PURPOSE OR OTHERWISE, AND TO THE EXTENT ALLOWED BY APPLICABLE LAW, IN NO EVENT WILL EXALT, ITS SUPPLIERS OR LICENSORS BE LIABLE TO YOU OR TO ANY THIRD PARTY UNDER ANY TORT, CONTRACT, NEGLIGENCE, STRICT LIABILITY OR OTHER LEGAL OR EQUITABLE THEORY FOR ANY LOST PROFITS, LOST OR CORRUPTED DATA, COMPUTER FAILURE OR MALFUNCTION, INTERRUPTION OF BUSINESS, OR OTHER SPECIAL, INDIRECT, INCIDENTAL OR CONSEQUENTIAL DAMAGES OF ANY KIND ARISING OUT OF (1) THE USE OR INABILITY TO USE THE PRODUCT OR (2) PRODUCT RELATED SERVICE OR SUPPORT, EVEN IF EXALT HAS BEEN ADVISED OF THE POSSIBILITY OF SUCH LOSS OR DAMAGES AND WHETHER OR NOT SUCH LOSS OR DAMAGES ARE FORESEEABLE.
- d. IN NO EVENT SHALL EXALT'S AND ITS SUPPLIERS'/LICENSORS' AGGREGATE LIABILITY EXCEED AN AMOUNT EQUAL TO THE PURCHASE PRICE PAID BY PURCHASER FOR THE PRODUCT OR SERVICE THAT IS THE SUBJECT OF A CLAIM. ANY CLAIM ARISING OUT OF OR RELATING TO THIS AGREEMENT MUST BE BROUGHT WITHIN ONE (1) YEAR AFTER THE OCCURRENCE OF THE EVENT GIVING RISE TO SUCH CLAIM. IN ADDITION, EXALT DISCLAIMS ALL LIABILITY OF ANY KIND OF EXALT'S SUPPLIERS/LICENSORS.

6 SOFTWARE LICENSE

- a. Subject to the terms and conditions of this Agreement, Exalt hereby grants You a non-exclusive, non-transferable, non-sublicensable license to use the Software that comes with the Product, if any is provided as part of the Product, only as part of the normal operation, use and maintenance of the Hardware Product for which the Software was provided. You may make back-up copies of such Software. You shall not otherwise copy, distribute or alter the Software. Furthermore, except to the extent allowed by applicable law if located in the European Union, and then only with prior written notice to Exalt, You shall not disassemble or reverse engineer the Software in whole or in part or authorize others to do so. No rights to distribute or sublicense the Software are granted herein.
- b. There may be certain third-party owned software provided along with, or incorporated within the Product ("Third Party Software"), and which Third Party Software has a separate license agreement and which is governed exclusively by such separate license agreement ("Third Party License") and not this Agreement. Such Third Party Software and applicable Third Party Licenses are listed in the document "EXALT WIRELESS, INC. THIRD-PARTY SOFTWARE AND THIRD-PARTY LICENSES USED WITH CERTAIN EXALT

PRODUCTS" available through the Web user interface application provided with this product or on the Exalt website. Except as Exalt may otherwise inform You in writing, the Third Party License gives You at least the license rights granted above in Section 6(a), and may provide additional license rights as to the Third-Party Software, but only with respect to the particular Third-Party Software to which the Third-Party License applies. SUCH THIRD-PARTY SOFTWARE IS PROVIDED WITHOUT ANY WARRANTY FROM EXALT AND ITS LICENSORS, INCLUDING BUT NOT LIMITED TO WARRANTIES OF MERCHANTABILITY, FITNESS FOR A PARTICULAR PURPOSE AND NON-INFRINGEMENT.

- c. Exalt and its licensors are the sole and exclusive owners of the Software, and all underlying intellectual property rights in the Software and Hardware Product. All rights not expressly granted to You relating to the Software are reserved by Exalt and its licensors. You take unencumbered title to the Hardware Product, subject to Exalt's and its licensors' ownership in the underlying intellectual property, upon payment in full to Exalt or the Exalt reseller for the Product(s).
- d. All licenses to the Software hereunder shall terminate if You fail to comply with any of the provisions of this Agreement and do not remedy such breach within thirty (30) days after receiving written notice from Exalt. You agree upon termination to immediately cease using the Software and to destroy all copies of the Software which may have been provided or created hereunder.

7 GOVERNMENT RESTRICTIONS

- a. You agree that you will not export or re-export the Products without Exalt's prior written consent, and then only in compliance with all requirements of applicable law, including but not limited to U.S. export control regulations. You have the responsibility to obtain any required licenses to export, re-export or import the Products. You shall defend, indemnify and hold Exalt and its suppliers/licensors harmless from any claims arising out of Your violation of any export control laws relating to any exporting of the Products. By accepting this Agreement and receiving the Products, You confirm that You are not listed on any governmental export exclusion lists and will not export or re-export the Products to any country embargoed by the U.S. Applicable export restrictions and exclusions are available at the official web site of the U.S. Department of Commerce Bureau of Industry and Security (www.bis.doc.gov).
- b. For purchase by or on behalf of governmental entities (including federal, state or provincial, and local), the governmental entity's rights in any technical data and software in the Products include only those rights customarily provided to the public as defined in Exalt's standard End User Agreement. In connection with any purchase by or on behalf of a U.S. governmental entity, Exalt's customary commercial license in technical data and software is provided in accordance with FAR 12.211 (Technical Data) and FAR 12.212 (Software) and, for Department of Defense transactions, DFAR 252.227-7015 (Technical Data - Commercial Items) and DFAR 227.7202-3 (Rights in Commercial Computer Software or Computer Software Documentation). If a governmental entity has a need for rights not conveyed under these terms, it must negotiate a mutually acceptable written agreement with Exalt specifying and specifically conveying such rights. Any use, modification, reproduction, release, performing, displaying or disclosing of the Exalt Software by a governmental entity shall be governed solely by the terms of this Agreement.

8 CONFIDENTIALITY

Purchaser acknowledges and agrees that information supplied by Exalt in connection with the Product or this Agreement and designated by Exalt as confidential is the confidential information of Exalt, which confidential information includes the Software. Purchaser agrees: (i) to hold the confidential information in confidence using the same degree of care that it uses to protect its own

confidential information of similar importance, but not less than a reasonable degree of care, (ii) not to make use of confidential information other than as contemplated by this Agreement, and (iii) not to reproduce confidential information except as expressly authorized by this Agreement. Purchaser's obligations with respect to confidentiality do not apply to information which: (i) becomes generally available to the public other than as a result of unauthorized disclosure by Purchaser, or (ii) was in Purchaser's possession prior to disclosure by Exalt.

9 MISCELLANEOUS

Exalt shall be excused from delay or failure in performance caused by anything beyond its reasonable control, including, without limitation, acts of God or of any third party, government action, compliance with laws or regulations, shortages, strikes, lockouts or industrial disputes, or the unavailability of deliveries, supplies, or software. Purchaser shall not sell, transfer or assign this Agreement without the prior written consent of Exalt. Any act in derogation of the foregoing shall be null and void, and Purchaser will remain obligated under this Agreement. This Agreement shall benefit and be binding upon the parties to this Agreement and their respective permitted successors and assigns. The waiver or failure of either party to exercise in any respect any right provided for in this Agreement shall not be deemed a waiver of any further right under this Agreement. If any provision of this Agreement is held by a court of competent jurisdiction to be contrary to law, the remaining provisions of this Agreement will remain in full force and effect. This Agreement and any disputes arising out of, or in any way related to or connected with, this Agreement, its termination or the relationship of the parties will be governed by and construed in accordance with the laws of the State of California, excluding its conflict of laws principles and excluding the United Nations Convention on Contracts for the International Sale of Goods. All disputes arising out of, or in any way related to or connected with, with this Agreement, the Products or Services shall be administered by the American Arbitration Association under its commercial arbitration rules by a single arbitrator appointed in accordance with the rules. Both parties consent that the arbitration shall take place in Santa Clara County, California. The award rendered by the arbitrator shall be final and binding on the parties and judgment on the award may be entered in any court having jurisdiction thereof. Any litigation relating to this Agreement or the arbitration shall take place in the state courts of Santa Clara County or in the federal courts of the Northern District of California. The foregoing notwithstanding, Exalt may obtain preliminary and/or permanent injunctive relief in any court of competent jurisdiction worldwide to enforce the terms of Sections 6, 7 and 8. Purchaser hereby consents and submits to the exclusive jurisdiction and venue of these courts and agrees that process may be served in the manner provided or allowed by California or federal law. In any action or proceeding to enforce rights under this Agreement, the prevailing party shall be entitled to recover costs and attorneys' fees. If the party who initiates the proceeding unilaterally dismisses it, the other party will be deemed the prevailing party. This Agreement represents the complete agreement and understanding of the parties with respect to the subject matter herein. This Agreement may be modified only through a written instrument signed or otherwise agreed to by both parties.

Part Number 203985
Revision 2.21, 11/6/2014
Exalt Confidential

Index

A

Adaptive Coded Modulation (ACM) parameter 48
Administration Settings page 37
administrator privileges 32
Advance Encryption Standard 38
AES 38
AIS enabling/disabling 54
alarm conditions 35
Alarm connector 96
alarms 68, 76, 93
 clearing 76
 Ethernet 69
 Link 68
 T1/E1 Input 69
 Temperature 69
Alarms page 68
AMI 54
antennas
 alignment 28, 102
 mounting 25
 indoor 27
 mounting height 7
 polarization orientation 7
 site preparation considerations 7
 system grounding 7
 transmission line 26
 troubleshooting 102

B

B8ZS 54
back-to-back bench test 9, 104
back-to-back bench test configuration 104
bandwidth 7
Bandwidth parameter 45, 48
BER 79
browsers 31

C

cables
 troubleshooting
 improper RF cable termination 101
carrier-to-interference tolerance 7
CLI 30
 menu options 31
 root menu 30
connectors
 Alarm 96

CONSOLE 97

DC 24

DC Power 98

Ethernet 95

front panel 16

T1/E1 94

Console connector 97

console interface 93

Current BER field 72

Current RSL field 73

D

date and time 37

DC connector 24

DC coupler 29

DC Power connector 98

DC power source 23

Diagnostic Charts page 79

dimensions 88

diplexer filter kit 8

diplexer orientation 20

diplexers 20

 antenna connection 22

 non-standard 21

 waveguide and 22

E

E1 channels 55

effective isotropic radiated power (EIRP) 10

Errored Seconds (ES) field 72

Ethernet 7

Ethernet configuration parameters 45

Ethernet connectors 95

Ethernet interface 92

Ethernet Interface Configuration page 52

Event Log page 76

ExaltCalc tool 100

external loopback modes 58

F

factory default settings 24, 44

fade margin 7, 102

File Activation page 46

files

 activating stored 46

 default configuration file 44

G

gateway (default) 44

grounding 102

GUI

- Administration Settings page 37
- Alarms page 68
- Allocation 51
- browsers supported 31
- Cross Connect 67
- description 31
- Diagnostic Charts page 79
- E1 Interface Configuration page 55
- Ethernet Aggregation 66
- Ethernet Interface Configuration page 52
- Ethernet Learning 64
- Ethernet Rate Limiting 63
- Event Log page 76
- File Activation page 46
- IP address (default) 31
- log in 32
- login privileges 32
- MHS/Diversity Configuration 60
- navigation panel 34, 35
- Performance page 72
- Radio Information page 36
- Reboot page 86
- Spectrum Analyzer page 83
- summary status information 34
- T1/E1 Configuration page 54
- VLAN page 61
- X Connect 67

I

interfaces

- alarm 93
- Ethernet 92
- power 93
- RF 92
- serial console 93
- T1/E1 92

interference 73

interference profile 7

IP address 44

IP subnet mask 44

L

License Key 38

lightning arrester 7

lightning arrestors 27

Line Build Out (LBO) 54

Line Code 54

link 7

link margin 102

Link Name parameter 45

link parameters 34

Link Security Key 37

Link Security Key parameter 45

login names 33

login privileges 32

loopback 54

- external (local) 58

- external (remote) 58

M

Maximum RSL field 73

Media Access Control (MAC) learning 64

Minimum RSL field 73

Minimum RSL Timestamp field 73

modulation 7

multipath 100

multipath propagation 101

muting 52

N

noise profile 7

O

OC3 Configuration 57

P

passwords 33, 45

path obstruction 102

performance degradation 100

Performance page 72

power

- DC wiring 23

power interface 93

R

radio

- grounding 7, 102

- initiation tasks 13

- installation tasks 13

- mounting 7

- rebooting 86

- transmitter output power 7

radio configuration 8

Radio Information page 36

Radio Name parameter 44

Reboot page 86

received signal level (RSL) See RSL

receiver threshold 7

record keeping 14

RF cabling type 7

- RF connector 27
- RF connector termination 23
- RF interface 92
- RF interference 101
- RF lightning arrestor 27
- RF output power 9
- RMT button 19
- RSL 10
 - current RSL readings 73
 - diagnostics 79
 - Maximum RSL field 73
 - Minimum RSL Timestamp field 73
 - monitor for performance 100
- RSL voltage 28
- S**
- safety 107
- serial console interface 93
- Set to E1 Mode button 54
- Set to T1 Mode button 54
- shipping box contents 8
- site preparation 7
- SMA cables 8
- SNMP 12, 40
- SNMP Traps 41
- space diversity 22
- specifications 88
- Spectrum Analyzer page 83
- Swap button 46
- system parameters
 - default settings 24
- system performance 72
- system settings
 - Current BER field 72, 73
 - Errored Seconds (ES) field 72
 - grounding 102
 - Maximum RSL 73
 - Minimum RSL field 73
 - Time Since Reset field 73
 - Unavailable Seconds field 73
- system specifications 88
 - 11GHz 91
 - 5GHz 89
 - 6GHz 90
- T**
- T1 Interface Configuration page 54
- T1/E1 Configuration page 54
- T1/E1 connections 94
- T1/E1 connectors 94
- T1/E1 interfaces 92
- TDM allocation 51
- TDM circuit 7
- TDM circuits 48
- Telnet session 30
- temperature 79, 88
- testing 104
 - back-to-back bench 9
 - threshold 105
 - threshold testing 105
- time division duplex (TDD) See TDD frame
- Time Since Reset 73
- transmission line
 - coaxial 26
 - egress 27
- transmitter output power 7
- Transmitter/Receiver (TR) frequency parameter 49
- traps 41
- troubleshooting 79, 99
- TX Frequency parameter 49
- U**
- Unavailable Seconds (UAS) 73
- Update button 37
- user privileges 33
- V**
- VLAN page 61
- voltage test 28
- VSWR 101
- W**
- waveguide 22
- waveguide adapter 22
- waveguide flange adapters 8



Figure 1	EX-6i-DS3-GigE Digital Microwave Radio	1
Figure 2	Indoor mount interconnection	5
Figure 3	Enclosure mount interconnection	5
Figure 4	Radio installation tasks	13
Figure 5	Front flush mount configuration	15
Figure 6	Front projection mount configuration	15
Figure 7	Rear flush mount configuration	16
Figure 8	Rear projection mount configuration	16
Figure 9	Primary front panel connectors	17
Figure 10	DS3 connectors and grounding switches	18
Figure 11	Rear panel without diplexers	20
Figure 12	Diplexer labeling	20
Figure 13	Diplexer orientation for a typical 'link' of radios	21
Figure 14	Typical Space Diversity diplexer configuration	22
Figure 15	DC connectors	24
Figure 16	CLI root menu	31
Figure 17	Initiating the browser connection	32
Figure 18	Browser Login screen	32
Figure 19	Radio Information page	33
Figure 20	Exalt GUI window description	34
Figure 21	Summary status information	35
Figure 22	Radio Information page	36
Figure 23	Administration Settings page	37
Figure 24	NTP and Time Zone Configurations page	39
Figure 25	SNMP Configuration page	40
Figure 26	Trap Configuration page	41
Figure 27	File Transfer page	43
Figure 28	File Transfer page—download file link	44
Figure 29	File Activation page	46
Figure 30	System Configuration page	47
Figure 31	Allocation page	51
Figure 32	Ethernet Interface Configuration page	52
Figure 33	T1 Interface Configuration page	55
Figure 34	E1 Interface Configuration page	56
Figure 35	DS3 Interface Configuration page	57
Figure 36	OC3 Configuration page	58
Figure 37	External (remote) loopback	59
Figure 38	External (local) loopback	59
Figure 39	MHS Configuration page	60
Figure 40	VLAN Configuration page	61
Figure 41	Ethernet Rate Limiting page	63
Figure 42	Ethernet Learning page	64
Figure 43	Syslog Configuration page	65
Figure 44	Ethernet Aggregation page	66
Figure 45	Cross Connect (X Connect) page	67
Figure 46	Alarms page	68
Figure 47	MHS Status page	71

Figure 48 Performance page	72
Figure 49 Performance page with ACM statistics	74
Figure 50 ATPC Statistics page	75
Figure 51 Event Log page	76
Figure 52 User Throughput page	77
Figure 53 User Throughput Help page	78
Figure 54 Diagnostic Charts page	79
Figure 55 Ethernet Utilization page	81
Figure 56 PA Control page	82
Figure 57 Spectrum Analyzer page	83
Figure 58 Spectrum analyzer graph example	84
Figure 59 Reboot page	86
Figure 60 Manual page	87
Figure 61 T1/E1 connectors	94
Figure 62 Ethernet connectors (ETH1 and ETH2)	95
Figure 63 Alarm Connector	96
Figure 64 Console Connector	97
Figure 65 DC Power connector	98
Figure 66 Basic back-to-back bench test configuration	104

Table 1	Factory default settings	11
Table 2	Front Panel Connectors	17
Table 3	LED indicators	18
Table 4	Default login information	33
Table 5	Alarm status indicators	68
Table 6	Additional alarm status indicators	70
Table 7	Supported 5GHz antennas	114

images/cover.gif i
images/6i-DS3-GigE-3quarters.jpg @ 300 dpi i
images/6i-DS3-GigE-3quarters.jpg @ 300 dpi 1
images/indoor_mount.gif @ 150 dpi 5
images/enclosure_mount.gif @ 150 dpi 5
images/6iFDD_Front Bracket.jpg 15
images/6iFDD_FrontBracket_Reverse.jpg 15
images/6iFDD_RearBracket.jpg 16
images/6iFDD_RearBracket_Reverse.jpg 16
images/ground_icon.gif 17
images/6i-DS3-GigE-front_panel.jpg 17
images/fig17.jpg @ 120 dpi 18
images/6iFDD_Rear_Panel_no_diplexers.jpg 20
images/6iFDD_Diplexer_labeling.jpg 20
images/6iFDD_Diplexer_orientation.jpg 21
images/6iFDD_Diplexer_space_diversity.jpg 22
images/6iFDD_Power.jpg 24
images/fig19.gif 31
images/GUI_address_bar.gif 32
images/GUI_login.gif 32
images/GUI_radio_info_page.gif 33
images/fig23.gif 34
images/fig24.gif 35
images/GUI_radio_info_page.gif 36
images/GUI_admin_settings_page.gif 37
images/GUI_NTP_Time_Zone_page.gif 39
images/GUI_snmp_config_page.gif 40
images/GUI_trap_config_page.gif 41
images/GUI_file_transfer_page.gif 43
images/GUI_file_transfer_link_page.gif @ 150 dpi 44
images/GUI_file_activation_page.gif 46
images/GUI_system_config_page.gif @ 150 dpi 47
images/GUI_allocation_page.gif 51
images/GUI_ethernet_interface_config_page.gif 52
images/GUI_T1_interface_config_page.gif 55
images/GUI_E1_interface_config_page.gif 56
images/GUI_DS3_interface_config_page.gif 57
images/GUI_OC3_interface_config_page.gif @ 300 dpi 58
images/fig35.gif 59
images/fig36.gif 59
images/GUI_MHS_config_page.gif @ 150 dpi 60
images/GUI_VLAN_config_page.gif 61
images/GUI_ethernet_rate_limiting_page.gif 63
images/GUI_ethernet_learning_page.gif @ 150 dpi 64
images/GUI_syslog_config_page.gif @ 150 dpi 65
images/GUI_ethernet_aggregation_page.gif @ 150 dpi 66
images/GUI_cross_connct_page.gif @ 150 dpi 67

images/GUI_alarms_page.gif 68
images/GUI_MHS_status_page.gif @ 150 dpi 71
images/GUI_performance_page.gif @ 150 dpi 72
images/GUI_performance_with_ACM.gif @ 150 dpi 74
images/GUI_ATPC_Statistics_page.gif @ 150 dpi 75
images/GUI_event_log_page.gif 76
images/GUI_user_throughput_page.gif 77
images/help_icon.gif 77
images/GUI_aggregate_user_throughput_page.gif 78
images/GUI_diagnostic_charts_page.gif 79
images/GUI_ethernet_utilization_page.gif @ 150 dpi 81
images/GUI_PA_Control_page.gif @ 150 dpi 82
images/GUI_spectrum_analyzer_page.gif @ 150 dpi 83
images/GUI_spectrum_analyzer_example.gif @ 150 dpi 84
images/GUI_reboot_page.gif 86
images/GUI_manual_page.gif 87
images/fig51.gif @ 300 dpi 94
images/fig51.gif @ 300 dpi 95
images/fig55.gif @ 300 dpi 96
images/fig55.gif @ 300 dpi 97
images/6iFDD_Power.jpg @ 180 dpi 98
images/fig60.gif @ 300 dpi 104
images/Exalt_logo_RGB.gif 129