



EXCERA

USER'S MANUAL

DMR Mobile Radio

EM8100 U1

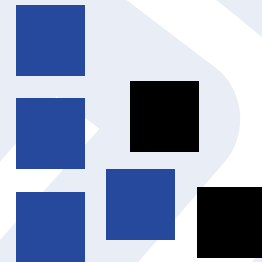

Contents

Important Information	3	GPS Positioning	14
RF Energy Exposure Information	4	DMR Trunking Functions and Operations	15
Operation Safety Recommendations	5	Private Call	15
Radio Safety Information and RF Radiation Information	8	Group Call	18
Disabled Frequency	8	All Call	20
Packing List	8	Emergency Call	20
Before Use	9	Broadcast Call	20
Ready to Use	9	Priority Call	20
Product Controls	10	Dispatch Station Call	20
LED Indicator	12	DMR Public Network Call	20
Status Icons	12	DMR-MPT Call	21
Functions and Operations	13	Contacts	21
Operation Mode	13	Message	22
Product Information Display	13	Status Message	23
Time and Date Setting	13	Call Logs	23
Alert Tone	13	Redial List and Callback List	23
Vibration	13	Vehicle Inquiry	24
Backlight	13	ID Inquiry	24
Menu Reset	13	Status Filing	25
Programmable Keypad	14	Roaming	25
High Noise Reduction	14	Scan	25
Time-out-Timer (TOT)	14		

Contents

MPT Trunking Functions and Operations	26	Analog Conventional Functions and Operations	37
Private Call	26	DMO and RMO Mode	37
Group Call	28	Squelch level	37
All Call	30	Optional Accessories	38
Emergency Call	30	Troubleshooting	39
Broadcast Call	30	Warranty and Maintains	40
Priority Call	30	Scope of Warranty	40
Dispatch Station Call	30	Warranty Contents	40
MPT Pubic Network Call	30	Non of Warranty	40
MPT-DMR Call	31	Disclaimer	41
Emergency Warranty	31	Warranty Card	42
Receiving and Responding to a Call	31		
Late Access	31		
Call Logs	32		
Redail and Callback List	32		
Manual Input to Temporary Group	33		
Scan	33		
Digital Conventional Functions and Operations	34		
Private Call, Group Call and All Call	34		
Emergency Call	34		
Message	35		
Call Logs	36		
Zone	36		

Important Information

Note:

Ic Note : Cet Appareil Est Conforme À La Partie 15 Des Règlements De La Fcc Et Aux Normes Rss De L'industrie Du Canada. Son Fonctionnement Est Soumis Aux Deux Conditions Suivantes : (1) Cet Appareil Ne Doit Pas Causer Des Interférences Nuisibles, Et (2) Cet Appareil Doit Accepter Toute Interférence Reçue, Y Compris Les Interférences Qui Peuvent Provoquer Un Fonctionnement Indésirable..

Le Fabricant N'est Pas Responsable Des Toutes Interférences Radio Ou Télévision Causées Par Des Modifications Non Autorisées Apportées À Cet Appareil. De Telles Modifications Peuvent Empêcher L'utilisateur D'utiliser L'appareil.

Ic Note:

This Device Complies With Part 15 Of The Fcc Rules And Industry Canada License-exempt Rss Standard(s). Operation Is Subject To The Following Two Conditions: (1) This Device May Not Cause Harmful Interference, And (2) This Device Must Accept Any Interference Received, Including Interference That May Cause Undesired Operation.

The Manufacturer Is Not Responsible For Any Radio Or Tv Interference Caused By Unauthorized Modifications Or Change To This Equipment. Such Modifications Or Change Could Void The User's Authority To Operate The Equipment.

The Users Manual Or Instruction Manual For An Intentional Or Unintentional Radiator Shall Caution The User That Changes Or Modifications Not Expressly Approved By The Party Responsible For Compliance Could Void The User's Authority To Operate The Equipment. In Cases Where The Manual Is Provided Only In A Form Other Than Paper, Such As On A Computer Disk Or Over The Internet, The Information Required By This Section May Be Included In The Manual In That Alternative Form, Provided The User Can Reasonably Be Expected To Have The Capability To Access Information In That Form.

Important Information

RF Energy Exposure Information

RF Energy Exposure Awareness And Control Information For FCC Occupational Use Requirements

Before using the two-way mobile radio, review the following important RF energy awareness and control information and operational instructions. Comply with this information and instructions in order to ensure compliance with RF exposure guidelines. e the capability to access information in that form.



This radio is intended for use in occupational/controlled conditions, where users have full knowledge of their exposure and can exercise control over their exposure to remain below RF exposure limits. This radio is NOT authorized for general population, consumer, or any other use.



Changes or modifications not expressly approved by Harris could void the user's authority to operate the equipment.

This two-way radio uses electromagnetic energy in the radio frequency (RF) spectrum to provide communications between two or more users over a distance. It uses RF energy or radio waves to send and receive calls. RF energy is one form of electromagnetic energy. Other forms include, but are not limited to, electric power, sunlight, and x-rays. RF energy, however, should not be confused with these other forms of electromagnetic energy, which, when used improperly, can cause biological damage. Very high levels of x-rays, for example, can damage tissues and genetic material.

Experts in science, engineering, medicine, health, and industry work with organizations to develop standards for exposure to RF energy. These standards provide recommended levels of RF exposure for both workers and the general public. These recommended RF exposure levels include substantial margins of protection. All two-way radios marketed in North America are designed, manufactured, and tested to ensure they meet government-established RF exposure levels. In addition, manufacturers also recommend specific operating instructions to users of two-way radios. These instructions are important because they inform users about RF energy exposure and provide simple procedures on how to control it. Refer to the following websites for more information on what RF energy exposure is and how to control exposure to assure compliance with established RF exposure limits:

<http://www.fcc.gov/oet/rfsafety/rf-faqs.html>

<http://www.osha.gov/SLTC/radiofrequencyradiation/index.html>

Important Information

Federal Communications Commission Regulations

Before it was marketed in the United States, the Digital mobile radio was tested to ensure compliance with FCC RF energy exposure limits for two-way mobile radios. When two-way radios are used as a consequence of employment, the FCC requires users to be fully aware of and able to control their exposure to meet occupational requirements. Exposure awareness can be facilitated by the use of a label directing users to specific user awareness information. The radio has an RF exposure product label.

Also, the Product Safety Manual and this Operator's Manual include information and operating instructions required to control RF exposure and to satisfy compliance requirements.

Operation Safety Recommendations

Occupational Safety Guidelines And Safety Training Information

To ensure bodily exposure to RF electromagnetic energy is within the FCC allowable limits for occupational use. Always adhere to the following basic guidelines:

- The push-to-talk button should only be depressed when intending to send a voice message.
- The radio should only be used for necessary work-related communications.
- The radio should only be used by authorized and trained personnel. It should never be operated by children.
- Do not attempt any unauthorized modification to the radio. Changes or modifications to the radio may cause harmful interference and/or cause it to exceed FCC RF exposure limits. Only qualified personnel should service the radio.
- Always use only authorized accessories (antennas, control heads, speakers/mics, etc.). Use of unauthorized accessories can cause the FCC RF exposure compliance requirements to be exceeded.

The information listed above provides the user with information needed to make him or her aware of a RF exposure, and what to do to assure that this radio operates within the FCC exposure limits of this radio.

Important Information

Transmitter Hazards



The operator of any mobile radio should be aware of certain hazards common to the operation of vehicular radio transmissions. Possible hazards include but are not limited to:

- Explosive Atmospheres — Just as it is dangerous to fuel a vehicle while its engine is running, be sure to turn the radio OFF while fueling the vehicle. If the radio is mounted in the trunk of the vehicle, DO NOT carry containers of fuel in the trunk. Areas with potentially explosive atmosphere are often, but not always, clearly marked. Turn the radio OFF when in any area with a potentially explosive atmosphere. It is rare, but not impossible that the radio or its accessories could generate sparks.
- Interference To Vehicular Electronic Systems — Electronic fuel injection systems, electronic antiskid braking systems, electronic cruise control systems, etc., are typical of the types of electronic devices that can malfunction due to the lack of protection from radio frequency (RF) energy present when transmitting. If the vehicle contains such equipment, consult the dealer for the make of vehicle and enlist their aid in determining if such electronic circuits perform normally when the radio is transmitting.
- Electric Blasting Caps - To prevent accidental detonation of electric blasting caps. DO NOT use two-way radios within 1000 feet (305 meters) of blasting operations. Always obey the “Turn Off Two-Way Radios” (or equivalent) signs posted where electric blasting caps are being used. (OSHA Standard: 1926. 900).
- Radio Frequency Energy - To prevent burns or related physical injury from radio frequency energy, do not operate the transmitter when anyone outside of the vehicle is within the minimum safe distance from the antenna as specified in Table 1.
- Vehicles Powered By Liquefied Petroleum (LP) Gas - Radio installation in vehicles powered by liquefied petroleum gas, where the LP gas container is located in the trunk or other sealed-off space within the interior of the vehicle, must conform to the National Fire Protection Association standard NFPA 58. This requires:
 - The space containing the radio equipment must be isolated by a seal from the space containing the LP gas container and its fittings.
 - Outside filling connections must be used for the LP gas container.
 - The LP gas container space shall be vented to the outside of the vehicle.

Important Information

- Vehicles Equipped with Airbags — For driver and passenger safety, avoid mounting the radio's control head (or any other component) above or near airbag deployment areas. In addition to driverside and passenger-side front-impact airbags, some vehicles may also be equipped with side-impact airbags. For occupant safety, verify the location of all airbags within the vehicle before installing the radio equipment.

Radio Frequency Interference

FCC Part 15

This device complies with Part 15 of the FCC Rules. Operation is subject to the following two conditions:

1. This device may not cause harmful interference; and,
2. This device must accept any interference received, including interference that may cause undesired operation.

NOTE 1: This equipment has been tested and found to comply with the limits for a Class B digital device, pursuant to part 15 of the FCC Rules. These limits are designed to provide reasonable protection against harmful interference in a residential installation. This equipment generates, uses and can radiate radio frequency energy and, if not installed and used in accordance with the instructions, installed and used in accordance with the instructions, may cause harmful interference to radio communications. However, there is no guarantee that interference will not occur in a particular installation. If this equipment does cause harmful interference to radio or television reception, which can be determined by turning the equipment off and on, the user is encouraged to try to correct the interference by one or more of the following measures:

- Reorient or relocate the receiving antenna.
- Increase the separation between the equipment and receiver.
- Connect the equipment into an outlet on a circuit different from that to which the receiver is connected.
- Consult the dealer or an experienced radio/TV technician for help.

NOTE 2: Any changes or modifications to this unit not expressly approved by the party responsible for compliance could void the user's authority to operate the equipment.

- This radio is designed for and classified as "Occupational/Controlled Use Only", meaning it must be used only during the course of employment by individuals aware of the hazards, and the ways to minimize such hazards; NOT intended for use in a General population /uncontrolled environment.
- DO NOT operate the radio without a proper antenna attached, as this may damage the radio and may also cause you to exceed RF exposure limits. A proper antenna is the antenna supplied with this radio by the manufacturer or an antenna specifically authorized by the manufacturer for use with this radio.
- DO NOT transmit for more than 50% of total radio use time, more than 50% of the time can cause RF exposure compliance requirements to be exceeded.
- This equipment should be installed and operated with a minimum distance of 70cm between the radiator and your body.

Important Information

Please read this manual carefully before use.

Alert Icons

 **Caution:** Indicates situations that could cause body injury or damage to your products.

 **Note** Indicates tips that can help you make better use of your products.

Disabled Frequency

360.670MHz

364.800MHz

384.000MHz

Caution!

Restricted to occupational use to satisfy FCC RF exposure limits.

Packing List

Please unpack carefully and check that all items listed below are received.

If any item is missing or damaged, please contact your dealer.

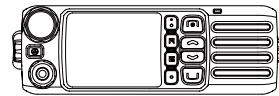

1 Radio



2 Palm Microphone



3 Fuse



4 Microphone Hanger and Screws

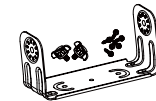

5 Mounting Bracket Kits



6 GPS Antenna

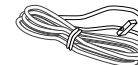

7 Power Cord



8 User Manual

Before Use

Installation Schematic Drawing:

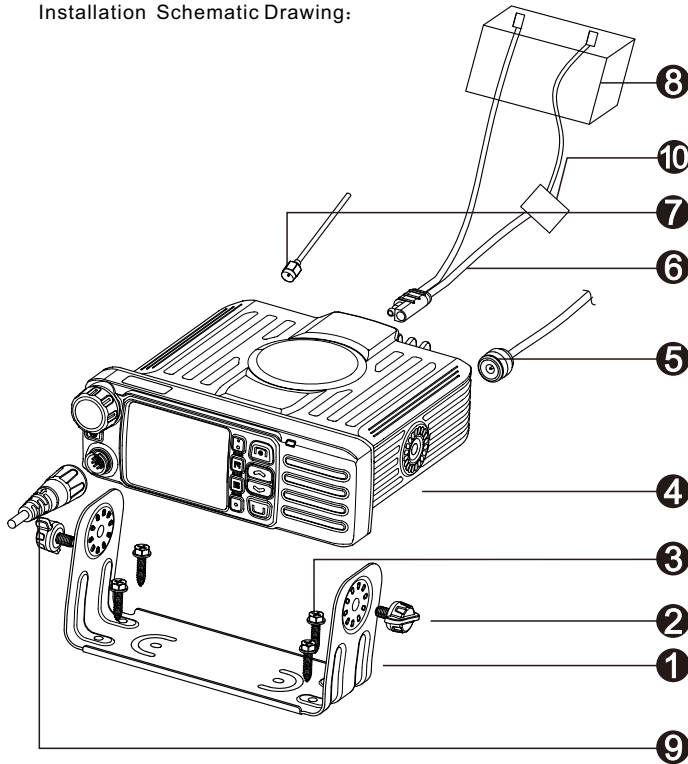

No.	Parts Name
①	Bracket
②	Locking Knob
③	Screws
④	Radio
⑤	Antenna
⑥	Power Inlet
⑦	GPS Antenna
⑧	Power Box
⑨	Palm Microphone Jack
⑩	Fuse

1. Install the bracket on both sides of Radio with screws and lock knobs.
2. Plug the palm microphone into radio assigned Palm Microphone Connector.
3. Plug the antenna into the back of radio assigned connector.
4. Plug the GPS antenna into the back of radio assigned connector.
5. Plug the power cable into the Power Inlet .

Before Use

Products Control

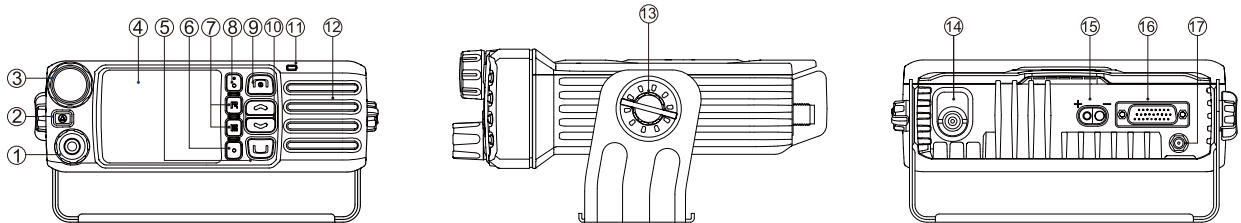

No.	Part Name	No.	Part Name	No.	Part Name
①	Microphone Connector	⑧	Setting Key	⑮	Power Inlet
②	TK Key	⑨	P4 Key/Hangup Key/Home Key	⑯	API Connector
③	Volume Control/Channel Selector Knob	⑩	Up/Down Key	⑰	GPS Antenna
④	LCD Display	⑪	LED Indicator		
⑤	P3 Key/Called Key/Calling Key	⑫	Speaker		
⑥	Menu Key	⑬	Bracket Knob		
⑦	P1,P2 Key	⑭	Antenna		

Before Use

Microphone Control

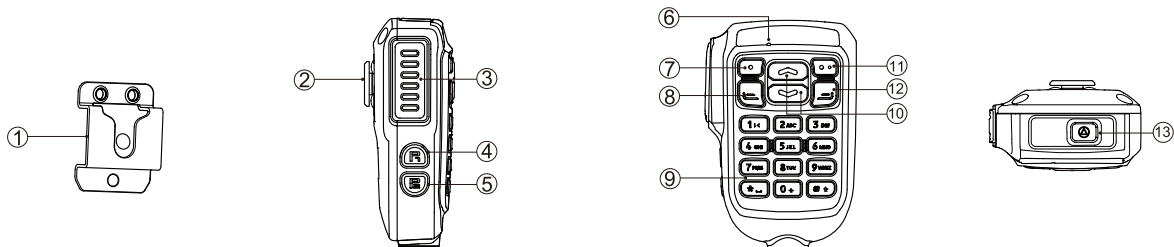











No.	Part Name	No.	Part Name	No.	Part Name
①	Microphone Fixed Bracket	⑥	Microphone	⑪	Setting Key
②	Microphone Fixed Button	⑦	Menu Key	⑫	Hangup Key/Home Key 【P4】
③	PTT Key	⑧	Called/Calling Key 【P3】	⑬	TK Key
④	P1 Key	⑨	Numeral Key		
⑤	P2 Key	⑩	Up/Down Key		

Before Use

LED Indicator

LED Indicator	Radio Status
LED flashes green slowly.	Standby(no load)
LED flashes green rapidly.	Upgrading or powering on
LED glows green.	Receiving
LED flashes red rapidly.	Reserving
LED glows red.	Transmitting
LED flashes orange slowly.	Scanning
LED flashes orange rapidly.	Reserving
LED glows orange.	After voice communication ends,you can hold down the PTT key to talk while the LED is glowing orange.

Status Icon

Icon	Icon Name
	Signal Strength Icon
	New Message Icon , Inbox Icon is full
	Scan Icon
	High Power Icon
	Middle Power Icon
	Low Power Icon
	Accessory Icon
	Roam Icon
	GPS Icon
	Missed Call Icon

Product Function and Operations

Operation Mode

This radio supports three operation Mode :DMR Trunking mode,MPT Trunking mode and Conventional mode(Digital and Analog).Switching Methods:

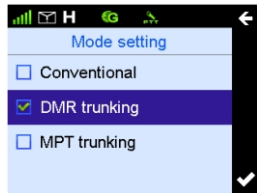

Press the Setting Key to access "Function Setting"- "Mode Setting" and select a appropriate mode.

Note: To access Digital Conventional Mode and Analog Conventional Mode to select Conventional Mode.

Product Information Display

You may achieve the following product information in this interface : Radio Alias, Radio ID, Series Number, Model Name , Model Number, Frequency Range, Radio Versions, Data Base Versions, Vocoder Versions, Latest Programming Date and ESN Code and so on.

Press Setting Key to access Product Information interface and review all the information.

Time and Date Display Setting

Use this function to modify this radio Date and Time.
Press "Setting" Key to access "Radio Setting"- "Date and Time" interface to modify the Date and Time.

Alert Tone

This function enable you set the following tones for your radio: "Keypad Tone", "Calling Tone", "Called Tone", "Function Tone", "Warning Tone", "Low Battery Tone" and "Message Tone"

Press Setting Key to access "Radio Setting"- "Tone".

Note: The function tone is the alert tone of the programmable Key function On/Off and Switching ,such as High or Low power Switching and Zone Switching.

Backlight

To set the backlight parameters of On/Off time, Off Type and Brightness Value.

Press Setting key to access "Radio Setting"- "Display Setting" .

Menu Reset

This radio supports Menu Reset function ,that is ,if you don't operate the menu for a predefined time period. This radio will automatically back to the home screen.

Hold down the Setting Key ,go to the "Product Setting" - "Menu Reset"

Product Functions and Operations

Programming Key

You are available to set the keys P1,P2,P3,P4,Up,Down and TK key as the shortcuts, such as High Power and Low Power switching and Zone Up and Zone Down, Squelch and Scan . This function only via the programming software setting.

High Noise Reduction

This function will effective reduce the noise under the high noise conduction. The noise reduction reach 25dB and makes voice will be clear. This function are available for your setting through the Programmable key and radio Menu.

 **Note:** This feature default off .If this feature is enabled , your speaking volume will be low. After this feature is enabled, you need speak near the MIC.



Time- out Timer(TOT)

The purpose of TOT is to prevent any user from occupying a channel for an extended period.You can set the longest time of single pressing PTT.If the preset time expires ,the radio will terminate transmission automatically . This feature can be enabled via the programming software Setting.

GPS Positioning

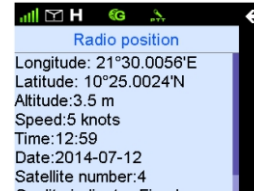
This function helps to get and upload the radio GPS positioning data(As shown).



Press Setting Key ,to go to "Radio Information"- "Positioning System"- "Positioning System On/Off"to turn On/Off GPS function. After GPS turn on,the radio status Positioning icon will display.If the GPS locate successfully ,the icon change to  from  . Review the GPS Positioning data from the "Radio information"- "Positioning System"- "Radio Positioning Information".

Product Functions and Operations



Note:

To ensure an optimal volume of the receiving radio, hold the radio approximately 2.5 to 5cm from your mouth.

Private Call

Under DMR trunking mode, to set Private Call type via trunking system. FOACSU and OACSU

- FOACSU: While setting up a call, ring warn the calling party, and the called party receive the call through manual operation.
- OACSU : While setting up a call without any ring warn for the calling party ,and the called party receive the call automatically.

Transmitting a Private Call

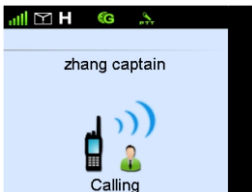

You may transmit a Private Call through any of the following methods.



Transmitting a call through Contacts List or Call Logs

- 1.Press Menu Key to go to main Menu.
- 2.Go to"Contacts List - Private Call Contacts", or go to "Call Logs" and access the outgoing /Incoming/Missed list.
- 3.Use the Up/Down Key to select the Private Call Contacts you want to call.
- 4.Use P3 Key  or PTT Key to transmitting a call.

Through microphone manual input

- 1.Input a Private Call number you want to call in home screen .
- 2.Use P3 Key , PTT Key or select Dial Key # to transmitting a Private Call.

Transmitting a call through Redail List or Recall List.

- 1.Use P3 Key  to Redail List or P4 Key  to Recall List to input a Private Call number you want to call in home screen .
- 2.Use P3 Key or  PTT Key to transmitting a Private Call.



Note:

Transmitting a Private Call Failed while products unregistered or Registration failed .

Product Functions and Operations

Receiving and Responding to a Private Call

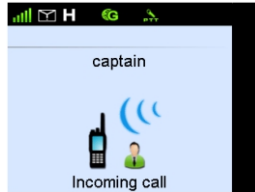

When a Private Call is received ,your radio automatic to receive a Private Call and sounds “De,De”,your radio will display the icon (As shown above) .

You may press P3 key  or PTT key, the incoming call ring and icon will disappear ,the first line display the incoming call alias or ID. (As shown above)



Note:No need press the Receiving Key while setting automatic receiving and responding to a Private Call .

Voice Communication

After setting up a private Call ,Both the calling party and called party are in PPT allowed interface ,and hold down PTT to talk.

Call Duration

After setting up a Private Call ,Both the calling party and called party LCD will display call duration in time .Unit is “Minutes :Seconds”. (As shown below)

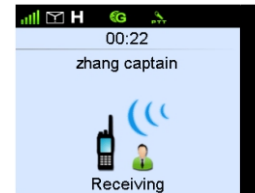

- The calling party LCD .

To count up the Call Duration by count -down,the starting time of count-down time is the total lasted talking time. This time is preset time via system configuration . When the total lasted calling time expires the preset time, this radio will return back from calling and end this call.

- The called party LCD

To count up the Call duration time by occurred time ,the start time from 0.

Ending a Call

- 1.Nobody hold down PTT Key for a long time ,and this radio will end call automatically when silence period expires.
- 2.This radio will end call when the total calling time expires the preset time.
- 3.During calling, any party of calling or called hang up.
- 4.Base station signal lost.

Product Functions and Operations

Current Channel Display

- Display radio channel

After initiating a call application ,LCD will display master control channel of radio registered base station before setting up voice communication.

- Display operation channel

After setting up a call, LCD will display the operation channel of the current base station occupied.

Ending a Call

- 1.Nobody hold down PTT Key for a long time ,and this radio will end call automatically when silence period expires.
- 2.This radio will end call when the total calling time expires the preset time.
- 3.During calling, any party of calling or called hang up.
- 4.Base station signal lost.

DMR Functions and Operations

Group Call

You may transmitting a Group Call through any of the following methods.

Transmitting a call to the preset contacts.

In the home screen,hold down PTT Key to transmitting a Group Call to the Group Call Contacts preset for the current Channel.
(By the Group Knob to select a group you want to call).





Transmitting a group call to the contacts List or Call Logs.

- 1.Press Menu Key to Main Menu
- 2.Go to “ Contracts List--Group Call Contacts ” or “ Call Logs ” to access outgoing/Incoming /Missed Call.
- 3.Use the Up/Down Key to select the Group Call contacts you want to call.
- 4.Use P3 Key or PTT Key  to transmitting a Group Call.

Transmitting a Group Call through manual input

- 1.Input a Group Call number you want to call.
- 2.Use PTT Key, P3 Key or Dial Keypad # to transmitting a Group Call.

Transmitting a call through recall List or Call Logs

- 1.Use P3 key ,to go to Call Logs List or press P4 Key  to select group call number you want to call.
- 2.Use P3 key  or PTT Key  to transmitting a Group Call.

Receiving and Responding to a Group Call



When a Group Call is received, your radio will display the icon and have a "De"alerting tone.

Press P3  or PTT Key,the incoming call icon will disappear .

Late Access

Before Group Call set up to the ended, those following type radios will join in this haven't ended Group Call such as :
Radio just powering on , Radio just roams from other base station or radio just releases from other group .

Voice Call

After setting up a call ,Hold down PTT key to initiate a call when the calling party and the called party are in the PTT Allowed interface.

DMR Functions and Operations

Call Duration

After setting up a Group Call ,Both the calling party LCD and the called party LCD will display Call Duration in time .

Unit is "Minutes :Seconds."(As shown below)



- The calling party LCD .

To count up the Call Duration by count -down,the starting time of count-down time is the total lasted talking time.

This time is preset time via system configuration .

When the total lasted calling time expires the preset time ,this radio will return back from calling and end this call.

- The called party LCD

To count up the Call duration time by occurred time ,the start time from 0.

To count up from the called party access to Group Call .

Recount up by count-down requires when the called party end a Group Call and access this group by "Late Access".

Group Call Calling Party ID or Alias Display

After initiating a Group Call ,all parties LCD will display the Group Call calling party ID or alias.

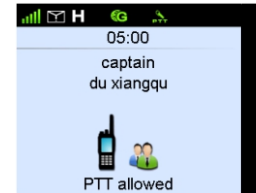

Communication Channel Display

- Display master control channel

After initiating a call application ,LCD will display master control channel of radio registered base station before setting up voice communication.

- Display main operation channel

After setting up a call,LCD will display the operation channel of the current base station occupied.

DMR Functions and Operations

Ending a Call

1. Nobody hold down PTT Key for a long time ,and this radio will end call automatically when the time expires silence period .
2. This radio will end call when the total calling time expires the preset time.
3. During calling, the calling party hang up.
4. Basestation signal lost.

All Call

Two types of All Call are Team All Call and Whole Network All Call.

Team All Call

999 is the last one Group Call number in this team , When you initiate a Team All Call, all member in this team will receive and respond to this call . Three methods are available for transmitting a Team All Call :Transmitting a call to preset contacts ,transmitting a call through group call contacts or manual input number . The specific operation is the same as the Group Call. When you initiate a Whole Network Call ,and all the member will join in this call ,1981,1982 are Whole Network Call number.

Whole Network All Call

The three methods are available for transmitting a Whole Network Call:transmitting a call to the preset contacts , transmitting a call through Group Call Contacts or through manual input (Add * key before 1981 or 1982) .

Emergency Call

Emergency Call can be Emergency Private Call or Emergency Group Call .

The following two methods are available to initiate a Emergency Call.

1. Press Emergency Call Key to initiate a Emergency Call. The called number can be set via programming software under trunking mode .
2. Through manual input number to initiate a Emergency Call. (Add *9* before number).Use P3 key  ,PTT Key or # key to initiate a call.

Broadcast Call

Broadcast Call only can be Broadcast Group Call .Only the calling party has the rights to speech. You may initiate a Broadcast Call through manual input .(Add *11* before number). Use P1 key  ,PTT Key or # key to initiate a call.

Priority Call

Via programming software configuration to set Priority Call level: Low ,Middle ,High or Preemption Call , Preemption Call is the highest level in Priority Call .

You may initiate Priority Call through manual dial (Add *8* before number).

Press Initiating Call key  ,PTT key or # key to initiate a call.