



EXCERA

USER'S MANUAL

DMR Mobile Radio

EM8100 U1

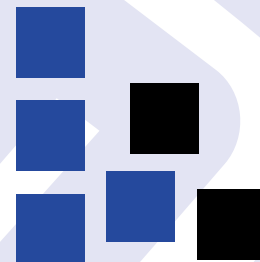

Contents

Important Information	3	GPS Positioning	14
RF Energy Exposure Information	4	DMR Trunking Functions and Operations	15
Operation Safety Recommendations	5	Private Call	15
Radio Safety Information and RF Radiation Information	8	Group Call	18
Disabled Frequency	8	All Call	20
Packing List	8	Emergency Call	20
Before Use	9	Broadcast Call	20
Ready to Use	9	Priority Call	20
Product Controls	10	Dispatch Station Call	20
LED Indicator	12	DMR Public Network Call	20
Status Icons	12	DMR-MPT Call	21
Functions and Operations	13	Contacts	21
Operation Mode	13	Message	22
Product Information Display	13	Status Message	23
Time and Date Setting	13	Call Logs	23
Alert Tone	13	Redial List and Callback List	23
Vibration	13	Vehicle Inquiry	24
Backlight	13	ID Inquiry	24
Menu Reset	13	Status Filing	25
Programmable Keypad	14	Roaming	25
High Noise Reduction	14	Scan	25
Time-out-Timer (TOT)	14		

Contents

MPT Trunking Functions and Operations	26	Analog Conventional Functions and Operations	37
Private Call	26	DMO and RMO Mode	37
Group Call	28	Squelch level	37
All Call	30	Optional Accessories	38
Emergency Call	30	Troubleshooting	39
Broadcast Call	30	Warranty and Maintains	40
Priority Call	30	Scope of Warranty	40
Dispatch Station Call	30	Warranty Contents	40
MPT Pubic Network Call	30	Non of Warranty	40
MPT-DMR Call	31	Disclaimer	41
Emergency Warranty	31	Warranty Card	42
Receiving and Responding to a Call	31		
Late Access	31		
Call Logs	32		
Redail and Callback List	32		
Manual Input to Temporary Group	33		
Scan	33		
Digital Conventional Functions and Operations	34		
Private Call, Group Call and All Call	34		
Emergency Call	34		
Message	35		
Call Logs	36		
Zone	36		

Important Information

Note:

Ic Note : Cet Appareil Est Conforme À La Partie 15 Des Règlements De La Fcc Et Aux Normes Rss De L'industrie Du Canada. Son Fonctionnement Est Soumis Aux Deux Conditions Suivantes : (1) Cet Appareil Ne Doit Pas Causer Des Interférences Nuisibles, Et (2) Cet Appareil Doit Accepter Toute Interférence Reçue, Y Compris Les Interférences Qui Peuvent Provoquer Un Fonctionnement Indésirable..

Le Fabricant N'est Pas Responsable Des Toutes Interférences Radio Ou Télévision Causées Par Des Modifications Non Autorisées Apportées À Cet Appareil. De Telles Modifications Peuvent Empêcher L'utilisateur D'utiliser L'appareil.

Ic Note:

This Device Complies With Part 15 Of The Fcc Rules And Industry Canada License-exempt Rss Standard(s). Operation Is Subject To The Following Two Conditions: (1) This Device May Not Cause Harmful Interference, And (2) This Device Must Accept Any Interference Received, Including Interference That May Cause Undesired Operation.

The Manufacturer Is Not Responsible For Any Radio Or Tv Interference Caused By Unauthorized Modifications Or Change To This Equipment. Such Modifications Or Change Could Void The User's Authority To Operate The Equipment.

The Users Manual Or Instruction Manual For An Intentional Or Unintentional Radiator Shall Caution The User That Changes Or Modifications Not Expressly Approved By The Party Responsible For Compliance Could Void The User's Authority To Operate The Equipment. In Cases Where The Manual Is Provided Only In A Form Other Than Paper, Such As On A Computer Disk Or Over The Internet, The Information Required By This Section May Be Included In The Manual In That Alternative Form, Provided The User Can Reasonably Be Expected To Have The Capability To Access Information In That Form.

Important Information

RF Energy Exposure Information

RF Energy Exposure Awareness And Control Information For FCC Occupational Use Requirements

Before using the two-way mobile radio, review the following important RF energy awareness and control information and operational instructions. Comply with this information and instructions in order to ensure compliance with RF exposure guidelines. Use the capability to access information in that form.



This radio is intended for use in occupational/controlled conditions, where users have full knowledge of their exposure and can exercise control over their exposure to remain below RF exposure limits. This radio is NOT authorized for general population, consumer, or any other use.



Changes or modifications not expressly approved by Shenzhen Excera Technology Co., Ltd. could void the user's authority to operate the equipment.

This two-way radio uses electromagnetic energy in the radio frequency (RF) spectrum to provide communications between two or more users over a distance. It uses RF energy or radio waves to send and receive calls. RF energy is one form of electromagnetic energy. Other forms include, but are not limited to, electric power, sunlight, and x-rays. RF energy, however, should not be confused with these other forms of electromagnetic energy, which, when used improperly, can cause biological damage. Very high levels of x-rays, for example, can damage tissues and genetic material.

Experts in science, engineering, medicine, health, and industry work with organizations to develop standards for exposure to RF energy. These standards provide recommended levels of RF exposure for both workers and the general public. These recommended RF exposure levels include substantial margins of protection. All two-way radios marketed in North America are designed, manufactured, and tested to ensure they meet government-established RF exposure levels. In addition, manufacturers also recommend specific operating instructions to users of two-way radios. These instructions are important because they inform users about RF energy exposure and provide simple procedures on how to control it. Refer to the following websites for more information on what RF energy exposure is and how to control exposure to assure compliance with established RF exposure limits:

<http://www.fcc.gov/oet/rfsafety/rf-faqs.html>

<http://www.osha.gov/SLTC/radiofrequencyradiation/index.html>

Important Information



Federal Communications Commission Regulations

Before it was marketed in the United States, the Digital mobile radio was tested to ensure compliance with FCC RF energy exposure limits for two-way mobile radios. When two-way radios are used as a consequence of employment, the FCC requires users to be fully aware of and able to control their exposure to meet occupational requirements. Exposure awareness can be facilitated by the use of a label directing users to specific user awareness information. The radio has an RF exposure product label.

Also, the Product Safety Manual and this Operator's Manual include information and operating instructions required to control RF exposure and to satisfy compliance requirements.

Operation Safety Recommendations

Occupational Safety Guidelines And Safety Training Information

To ensure bodily exposure to RF electromagnetic energy is within the FCC allowable limits for occupational use. Always adhere to the following basic guidelines:

- The push-to-talk button should only be depressed when intending to send a voice message.
- The radio should only be used for necessary work-related communications.
- The radio should only be used by authorized and trained personnel. It should never be operated by children.
- Do not attempt any unauthorized modification to the radio. Changes or modifications to the radio may cause harmful interference and/or cause it to exceed FCC RF exposure limits. Only qualified personnel should service the radio.
- Always use only authorized accessories (antennas, control heads, speakers/mics, etc.). Use of unauthorized accessories can cause the FCC RF exposure compliance requirements to be exceeded.

The information listed above provides the user with information needed to make him or her aware of a RF exposure, and what to do to assure that this radio operates within the FCC exposure limits of this radio.

Important Information

Transmitter Hazards



The operator of any mobile radio should be aware of certain hazards common to the operation of vehicular radio transmissions. Possible hazards include but are not limited to:

- Explosive Atmospheres — Just as it is dangerous to fuel a vehicle while its engine is running, be sure to turn the radio OFF while fueling the vehicle. If the radio is mounted in the trunk of the vehicle, DO NOT carry containers of fuel in the trunk. Areas with potentially explosive atmosphere are often, but not always, clearly marked. Turn the radio OFF when in any area with a potentially explosive atmosphere. It is rare, but not impossible that the radio or its accessories could generate sparks.
- Interference To Vehicular Electronic Systems — Electronic fuel injection systems, electronic antiskid braking systems, electronic cruise control systems, etc., are typical of the types of electronic devices that can malfunction due to the lack of protection from radio frequency (RF) energy present when transmitting. If the vehicle contains such equipment, consult the dealer for the make of vehicle and enlist their aid in determining if such electronic circuits perform normally when the radio is transmitting.
- Electric Blasting Caps - To prevent accidental detonation of electric blasting caps. DO NOT use two-way radios within 1000 feet (305 meters) of blasting operations. Always obey the “Turn Off Two-Way Radios” (or equivalent) signs posted where electric blasting caps are being used. (OSHA Standard: 1926.900).
- Radio Frequency Energy - To prevent burns or related physical injury from radio frequency energy, do not operate the transmitter when anyone outside of the vehicle is within the minimum safe distance from the antenna as specified in Table 1 and Table 2.
- Vehicles Powered By Liquefied Petroleum (LP) Gas - Radio installation in vehicles powered by liquefied petroleum gas, where the LP gas container is located in the trunk or other sealed-off space within the interior of the vehicle, must conform to the National Fire Protection Association standard NFPA 58. This requires:
 - The space containing the radio equipment must be isolated by a seal from the space containing the LP gas container and its fittings.
 - Outside filling connections must be used for the LP gas container.
 - The LP gas container space shall be vented to the outside of the vehicle.

Important Information

- Vehicles Equipped with Airbags – For driver and passenger safety, avoid mounting the radio's control head (or any other component) above or near airbag deployment areas. In addition to driverside and passenger-side front-impact airbags, some vehicles may also be equipped with side-impact airbags. For occupant safety, verify the location of all airbags within the vehicle before installing the radio equipment.

Radio Frequency Interference

FCC Part 15

This device complies with Part 15 of the FCC Rules. Operation is subject to the following two conditions:

1. This device may not cause harmful interference; and,
2. This device must accept any interference received, including interference that may cause undesired operation.

Industry Canada

This device complies with Industry Canada license-exempt RSS standard(s). Operation is subject to the following two conditions: (1) this device may not cause interference, and (2) this device must accept any interference, including interference that may cause undesired operation of the device.

Le présent appareil est conforme aux CNR d'Industrie Canada applicables aux appareils radio exempts de licence. L'exploitation est autorisée aux deux conditions suivantes : (1) l'appareil ne doit pas produire de brouillage, et (2) l'utilisateur de l'appareil doit accepter tout brouillage radioélectrique subi, même si le brouillage est susceptible d'en compromettre le fonctionnement.

Important Information

Please read this manual carefully before use.

Alert Icons



Caution: Indicates situations that could cause body injury or damage to your products.



Note: Indicates tips that can help you make better use of your products.

Disabled Frequency

360.670MHz

364.800MHz

384.000MHz



Caution!

Restricted to occupational use to satisfy FCC RF exposure limits.

Packing List

Please unpack carefully and check that all items listed below are received.

If any item is missing or damaged, please contact your dealer.

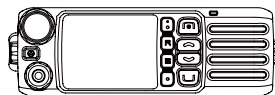

❶ Radio

❷ Palm Microphone

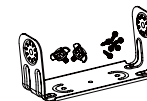

❸ Fuse

❹ Microphone Hanger and Screws

❺ Mounting Bracket Kits

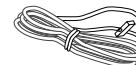

❻ GPS Antenna

❼ Power Cord

❽ User Manual

Before Use

Installation Schematic Drawing:

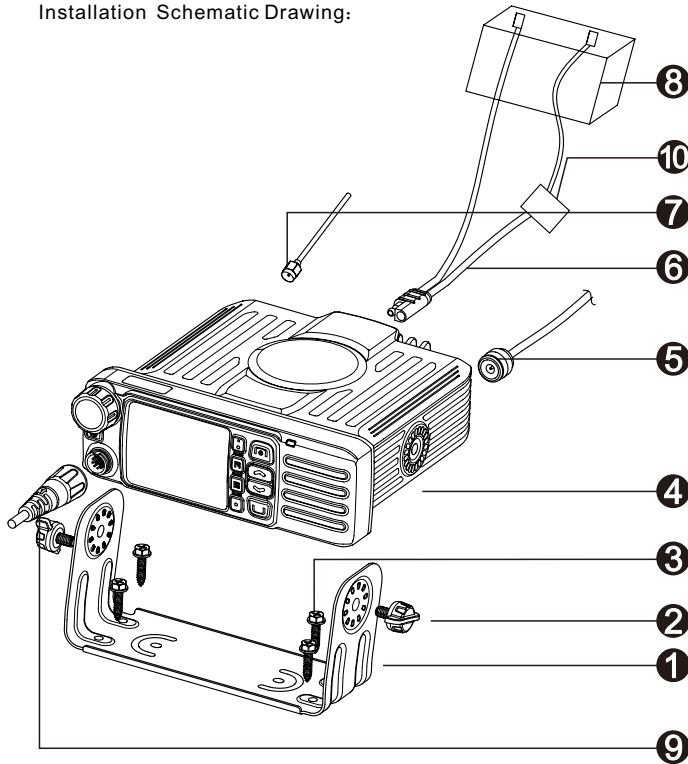

No.	Parts Name
①	Bracket
②	Locking Knob
③	Screws
④	Radio
⑤	Antenna
⑥	Power Inlet
⑦	GPS Antenna
⑧	Power Box
⑨	Palm Microphone Jack
⑩	Fuse

1. Install the bracket on both sides of Radio with screws and lock knobs.
2. Plug the palm microphone into radio assigned Palm Microphone Connector.
3. Plug the antenna into the back of radio assigned connector.
4. Plug the GPS antenna into the back of radio assigned connector.
5. Plug the power cable into the Power Inlet .

Before Use

Products Control

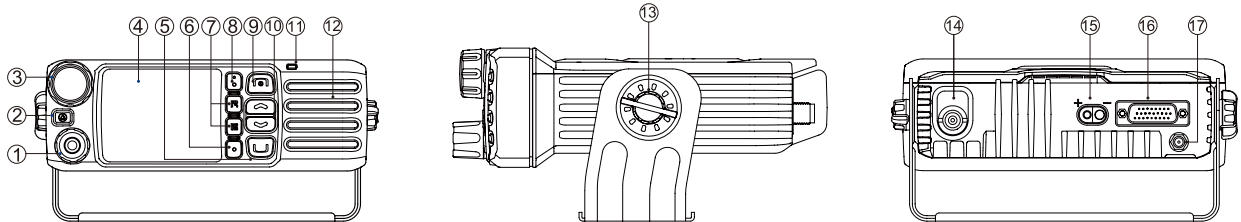

No.	Part Name	No.	Part Name	No.	Part Name
①	Microphone Connector	⑧	Setting Key	⑮	Power Inlet
②	TK Key	⑨	P4 Key/Hangup Key/Home Key	⑯	API Connector
③	Volume Control/Channel Selector Knob	⑩	Up/Down Key	⑰	GPS Antenna
④	LCD Display	⑪	LED Indicator		
⑤	P3 Key/Called Key/Calling Key	⑫	Speaker		
⑥	Menu Key	⑬	Bracket Knob		
⑦	P1,P2 Key	⑭	Antenna		

Before Use

Microphone Control

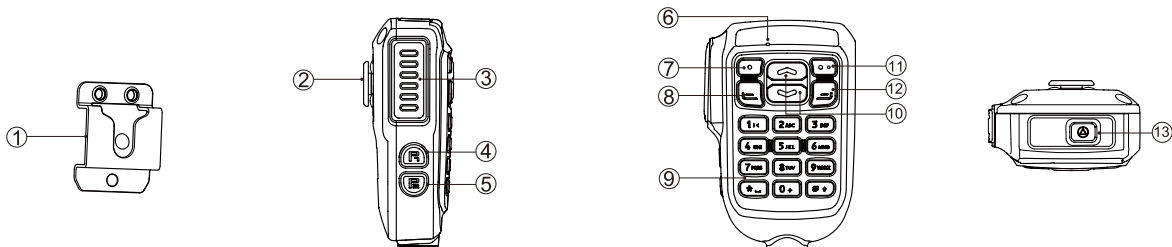











No.	Part Name	No.	Part Name	No.	Part Name
①	Microphone Fixed Bracket	⑥	Microphone	⑪	Setting Key
②	Microphone Fixed Button	⑦	Menu Key	⑫	Hangup Key/Home Key 【P4】
③	PTT Key	⑧	Called/Calling Key 【P3】	⑬	TK Key
④	P1 Key	⑨	Numeral Key		
⑤	P2 Key	⑩	Up/Down Key		

Before Use

LED Indicator

LED Indicator	Radio Status
LED flashes green slowly.	Standby(no load)
LED flashes green rapidly.	Upgrading or powering on
LED glows green.	Receiving
LED flashes red rapidly.	Reserving
LED glows red.	Transmitting
LED flashes orange slowly.	Scanning
LED flashes orange rapidly.	Reserving
LED glows orange.	After voice communication ends,you can hold down the PTT key to talk while the LED is glowing orange.

Status Icon

Icon	Icon Name
	Signal Strength Icon
	New Message Icon , Inbox Icon is full
	Scan Icon
	High Power Icon
	Middle Power Icon
	Low Power Icon
	Accessory Icon
	Roam Icon
	GPS Icon
	Missed Call Icon

Product Function and Operations

Operation Mode

This radio supports three operation Mode :DMR Trunking mode,MPT Trunking mode and Conventional mode(Digital and Analog).Switching Methods:

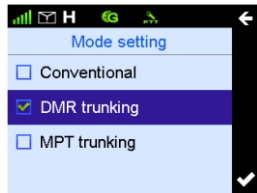

Press the Setting Key to access "Function Setting"- "Mode Setting" and select a appropriate mode.

Note: To access Digital Conventional Mode and Analog Conventional Mode to select Conventional Mode.

Product Information Display

You may achieve the following product information in this interface : Radio Alias, Radio ID, Series Number, Model Name , Model Number, Frequency Range, Radio Versions, Data Base Versions, Vocoder Versions, Latest Programming Date and ESN Code and so on.

Press Setting Key to access Product Information interface and review all the information.

Time and Date Display Setting

Use this function to modify this radio Date and Time. Press "Setting" Key to access "Radio Setting"- "Date and Time" interface to modify the Date and Time.

Alert Tone

This function enable you set the following tones for your radio: "Keypad Tone", "Calling Tone", "Called Tone", "Function Tone", "Warning Tone", "Low Battery Tone" and "Message Tone"

Press Setting Key to access "Radio Setting"- "Tone".

Note: The function tone is the alert tone of the programmable Key function On/Off and Switching ,such as High or Low power Switching and Zone Switching.

Backlight

To set the backlight parameters of On/Off time, Off Type and Brightness Value.

Press Setting key to access "Radio Setting"- "Display Setting" .

Menu Reset

This radio supports Menu Reset function ,that is ,if you don't operate the menu for a predefined time period. This radio will automatically back to the home screen.

Hold down the Setting Key ,go to the "Product Setting" - "Menu Reset"

Product Functions and Operations

Programming Key

You are available to set the keys P1,P2,P3,P4,Up,Down and TK key as the shortcuts, such as High Power and Low Power switching and Zone Up and Zone Down, Squelch and Scan . This function only via the programming software setting.

High Noise Reduction

This function will effective reduce the noise under the high noise conduction. The noise reduction reach 25dB and makes voice will be clear. This function are available for your setting through the Programmable key and radio Menu.

 **Note:** This feature default off .If this feature is enabled , your speaking volume will be low. After this feature is enabled, you need speak near the MIC.



Time- out Timer(TOT)

The purpose of TOT is to prevent any user from occupying a channel for an extended period.You can set the longest time of single pressing PTT.If the preset time expires ,the radio will terminate transmission automatically . This feature can be enabled via the programming software Setting.

GPS Positioning

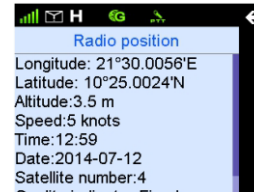
This function helps to get and upload the radio GPS positioning data(As shown).



Press Setting Key ,to go to "Radio Information"- "Positioning System"- "Positioning System On/Off"to turn On/Off GPS function. After GPS turn on,the radio status Positioning icon will display.If the GPS locate successfully ,the icon change to  from  . Review the GPS Positioning data from the "Radio information"- "Positioning System"- "Radio Positioning Information".

Product Functions and Operations



Note:

To ensure an optimal volume of the receiving radio, hold the radio approximately 2.5 to 5cm from your mouth.

Private Call

Under DMR trunking mode, to set Private Call type via trunking system. FOACSU and OACSU

- FOACSU: While setting up a call, ring warn the calling party, and the called party receive the call through manual operation.
- OACSU : While setting up a call without any ring warn for the calling party ,and the called party receive the call automatically.

Transmitting a Private Call

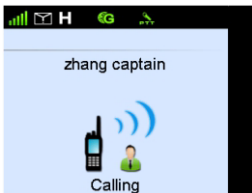

You may transmit a Private Call through any of the following methods.



Transmitting a call through Contacts List or Call Logs

- 1.Press Menu Key to go to main Menu.
- 2.Go to"Contacts List - Private Call Contacts", or go to "Call Logs" and access the outgoing /Incoming/Missed list.
- 3.Use the Up/Down Key to select the Private Call Contacts you want to call.
- 4.Use P3 Key  or PTT Key to transmitting a call.

Through microphone manual input

- 1.Input a Private Call number you want to call in home screen .
- 2.Use P3 Key , PTT Key or select Dial Key # to transmitting a Private Call.

Transmitting a call through Redail List or Recall List.

- 1.Use P3 Key  to Redail List or P4 Key  to Recall List to input a Private Call number you want to call in home screen .
- 2.Use P3 Key or  PTT Key to transmitting a Private Call.



Note:

Transmitting a Private Call Failed while products unregistered or Registration failed .

Product Functions and Operations

Receiving and Responding to a Private Call

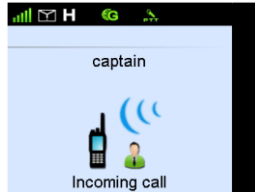

When a Private Call is received ,your radio automatic to receive a Private Call and sounds “De,De”,your radio will display the icon (As shown above) .

You may press P3 key  or PTT key, the incoming call ring and icon will disappear ,the first line display the incoming call alias or ID. (As shown above)



Note:No need press the Receiving Key while setting automatic receiving and responding to a Private Call .

Voice Communication

After setting up a private Call ,Both the calling party and called party are in PPT allowed interface ,and hold down PTT to talk.

Call Duration

After setting up a Private Call ,Both the calling party and called party LCD will display call duration in time .Unit is “Minutes :Seconds”. (As shown below)

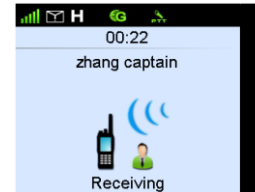

- The calling party LCD .

To count up the Call Duration by count -down,the starting time of count-down time is the total lasted talking time. This time is preset time via system configuration . When the total lasted calling time expires the preset time, this radio will return back from calling and end this call.

- The called party LCD

To count up the Call duration time by occurred time ,the start time from 0.

Ending a Call

- 1.Nobody hold down PTT Key for a long time ,and this radio will end call automatically when silence period expires.
- 2.This radio will end call when the total calling time expires the preset time.
- 3.During calling, any party of calling or called hang up.
- 4.Base station signal lost.

Product Functions and Operations



Current Channel Display

- Display radio channel

After initiating a call application ,LCD will display master control channel of radio registered base station before setting up voice communication.

- Display operation channel

After setting up a call, LCD will display the operation channel of the current base station occupied.

Ending a Call

- 1.Nobody hold down PTT Key for a long time ,and this radio will end call automatically when silence period expires.
- 2.This radio will end call when the total calling time expires the preset time.
- 3.During calling, any party of calling or called hang up.
- 4.Base station signal lost.

DMR Functions and Operations

Group Call

You may transmitting a Group Call through any of the following methods.

Transmitting a call to the preset contacts.

In the home screen,hold down PTT Key to transmitting a Group Call to the Group Call Contacts preset for the current Channel.
(By the Group Knob to select a group you want to call).





Transmitting a group call to the contacts List or Call Logs.

- 1.Press Menu Key to Main Menu
- 2.Go to “ Contracts List--Group Call Contacts ” or “ Call Logs ” to access outgoing/Incoming /Missed Call.
- 3.Use the Up/Down Key to select the Group Call contacts you want to call.
- 4.Use P3 Key or PTT Key  to transmitting a Group Call.

Transmitting a Group Call through manual input

- 1.Input a Group Call number you want to call.
- 2.Use PTT Key, P3 Key or Dial Keypad # to transmitting a Group Call.

Transmitting a call through recall List or Call Logs

- 1.Use P3 key ,to go to Call Logs List or press P4 Key  to select group call number you want to call.
- 2.Use P3 key  or PTT Key  to transmitting a Group Call.

Receiving and Responding to a Group Call



When a Group Call is received, your radio will display the icon and have a "De"alerting tone.

Press P3  or PTT Key,the incoming call icon will disappear .

Late Access

Before Group Call set up to the ended, those following type radios will join in this haven't ended Group Call such as :
Radio just powering on , Radio just roams from other base station or radio just releases from other group .

Voice Call

After setting up a call ,Hold down PTT key to initiate a call when the calling party and the called party are in the PTT Allowed interface.

DMR Functions and Operations

Call Duration

After setting up a Group Call ,Both the calling party LCD and the called party LCD will display Call Duration in time .

Unit is "Minutes :Seconds."(As shown below)

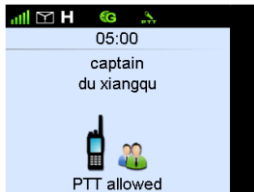

- The calling party LCD .

To count up the Call Duration by count -down,the starting time of count-down time is the total lasted talking time.

This time is preset time via system configuration .

When the total lasted calling time expires the preset time ,this radio will return back from calling and end this call.

- The called party LCD

To count up the Call duration time by occurred time ,the start time from 0.

To count up from the called party access to Group Call .

Recount up by count-down requires when the called party end a Group Call and access this group by "Late Access".

Group Call Calling Party ID or Alias Display

After initiating a Group Call ,all parties LCD will display the Group Call calling party ID or alias.

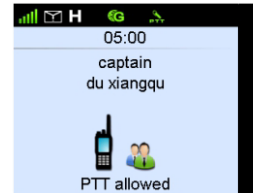

Communication Channel Display

- Display master control channel

After initiating a call application ,LCD will display master control channel of radio registered base station before setting up voice communication.

- Display main operation channel

After setting up a call,LCD will display the operation channel of the current base station occupied.

DMR Functions and Operations

Ending a Call

1. Nobody hold down PTT Key for a long time ,and this radio will end call automatically when the time expires silence period .
2. This radio will end call when the total calling time expires the preset time.
3. During calling, the calling party hang up.
4. Basestation signal lost.

All Call

Two types of All Call are Team All Call and Whole Network All Call.

Team All Call

999 is the last one Group Call number in this team , When you initiate a Team All Call, all member in this team will receive and respond to this call . Three methods are available for transmitting a Team All Call :Transmitting a call to preset contacts ,transmitting a call through group call contacts or manual input number . The specific operation is the same as the Group Call. When you initiate a Whole Network Call ,and all the member will join in this call ,1981,1982 are Whole Network Call number.

Whole Network All Call

The three methods are available for transmitting a Whole Network Call:transmitting a call to the preset contacts , transmitting a call through Group Call Contacts or through manual input (Add * key before 1981 or 1982) .

Emergency Call

Emergency Call can be Emergency Private Call or Emergency Group Call .

The following two methods are available to initiate a Emergency Call.

1. Press Emergency Call Key to initiate a Emergency Call. The called number can be set via programming software under trunking mode .
2. Through manual input number to initiate a Emergency Call. (Add *9* before number).Use P3 key  ,PTT Key or # key to initiate a call.

Broadcast Call

Broadcast Call only can be Broadcast Group Call .Only the calling party has the rights to speech. You may initiate a Broadcast Call through manual input .(Add *11* before number). Use P1 key  ,PTT Key or # key to initiate a call.

Priority Call

Via programming software configuration to set Priority Call level: Low ,Middle ,High or Preemption Call , Preemption Call is the highest level in Priority Call .

You may initiate Priority Call through manual dial (Add *8* before number).

Press Initiating Call key  ,PTT key or # key to initiate a call.

DMR Functions and Operations

Dispatch Station Call

This radio can call the Dispatch Station. The number of Dispatch Station are based on configuration.

DMR Republic Network Phone Call

The calling with Public Network Phone is called Public Network Call.

Network Phone Call have fixed phone call and mobile phone.

For your better use ,for example as follow.

House Fixed Telephone fixexed fixr	Dail fixed telephone number directly	Such as dial 8036 directly
External Fixed Telephone	Add 0 before telephone number	Such as 00755-33010296
Making Local Mobile Telephone Call	Add 0 before telephone number	Such as 013112345678
Making Nonlocal Mobile Telephone Call	Add 00 before telephone number	Such as 0013112345678

DMR-MPT Call

Base on the associated DMR-MPT Group Call number configured by base station , you can achieve DMR trunking mode radio call DMR trunking mode radio each other.

DMR trunking radio transmit a DMR-MPT call

In DMR trunking mode ,you may transmit a DMR-MPT Call through any of the following methods.

- 1,Transmitting a call to the preset contacts.
- 2,Transmitting a call through Group Contacts .
- 3,Through manual input.

(Specific operation is the same as Group Call)

Receiving and Responding to a Group Call

When a Private Call / Group Call is received under trunking mode,your radio will set up calling automatically and have one "De"alert tone.

Late Access

After setting up a Group Call , allows those members will join in this call ,which haven't joined in Group Call .

Emergency Caution

Setting a Private Call, Group Call or Dispatch Station Call number via CPS setting,press the Emergency Caution Key on the microphone or the front panel of radio for 3 seconds to initiate a Emergency Call.

Contacts List

To access to this menu,Press Menu Key to Main Menu and select "Contacts List".

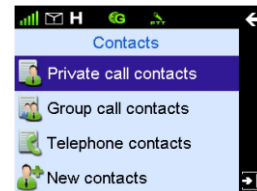

DMR Functions and Operations

Private Call Contacts

You can save up to 256 entries in the private Call Contacts list .
To access this item, select"Contacts-Private Contacts" or through Private Call List shortcut key for the contacts list via CPS configuration.

- a) To review ,modify or delete any one of contacts on list.
- b) If you want to delete all contacts ,select"Contacts List-Private Call Contacts-Contacts-Delete All"

Group Call Contacts

You can save up to 256 entries in group Call Contacts list .
To access list through"Contacts List -Group Call Contacts".
a)To review the details of any contacts on the list ,just like alias and ID information.

Public Network Contacts

You can save up to 256 entries in the Public Network Contacts.
To access this item through "Contacts List-Public Network Contacts"
a) To review ,modify or delete any one of contacts on list.
b) If you want to delete all Contacts ,select"Contacts List-Private Call Contacts-Contacts-Delete All"

New Contacts

You can add a Private Call Contacts and Public Network Contacts to Contacts List .

The New Private Call Contacts will save to Private Call Contacts List automatically .

The New Public Network Contacts will save to Public Network Contact List automatically .

- a)The New Private Contact number must be unique.
- b)The alias of each Private Call Contacts save up to 16 characters,the available number is 8 figure [NumberID must conform to the rules of dial-up].
- c)The alias of each Public Network Contacts save up to 16 characters, the available numbeic is 18 figures [NumberID must conform to the rules of dial-up].



Note: You can switch input method through # key when input contacts alias.

Message

To access this item,press Menu key to go to main menu to select"message".

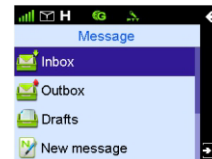

DMR Functions and Operations

Inbox

The Inbox can save up to 100 received messages. When the Inbox save up to 90 received messages, and go on receiving messages, radio will appear notes "Inbox will be full, please delete message" and the earliest message will be overwritten by the latest one automatically.

Outbox

The Outbox can save up 100 sent messages. Each message will appear appropriate icon to note message send successfully or not.

- a) When the message sent successfully, the icon "✓" will appear.
- b) When the message sent unsuccessful, the icon "!" will appear and please send again.

When the Outbox is full, the earliest message will be overwritten by the latest one automatically.

Drafts

The Drafts can save up to 10 drafts messages into Drafts. When the Drafts is full, the earliest message will be overwritten by the latest one automatically.

New Msg

You can create new text message (179 characters at most) and send it to an individual user or to a talk group.

Quick Text

Under this option there are some text messages (10 entries at most) preset by your dealer. You can choose and send any entry.

Status Msg

There are some text message (95 entries at most) preset by your dealer in this menu. You can select and send directly. The status Msg is status code.

Call Logs

Press Menu Key to access Main Menu and then select "Call Logs". This radio can save up to 200 call entries. When the entries list is full, the earliest entry will be overwritten by latest one automatically. To view, delete, or delete all after selecting one call entries.

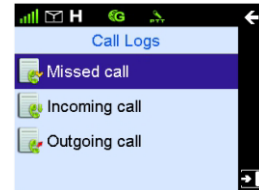

Redial List and Callback List

Use P3 Key  and P4 Key  to access "Redial List" and "Callback List".

This radio can save up to 10 call entries. When the entries list is full, the earliest entry will be overwritten by latest one.

DMR Functions and Operations

Redial List

All outgoing call list will be save in the Redial List .

To access this item,Use P3key in home screen (As shown) .

Use P3 Key or PTT Key to select the outgoing entries to initiate a call,delete it or delete all .



Callback List

The callback List will save up all the incoming entries.

To access this item ,Use P4key in the home screen(As shown).

Use P3 key or PTT key to initiate a call ,delete it or delete all.



Vehicle Inquiry

To access this item ,press Menu Key to access Main Menu to select "Applications --Information Inquiry".

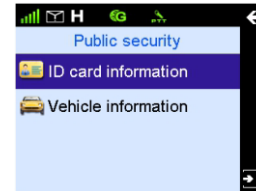

You can input the vehicle license number and sent it to dataspaces when you want to inquire it .You also can review it from the history record.

ID Inquiry

To access this item ,press Menu Key to access Main Menu to select "Applications --ID Inquiry".

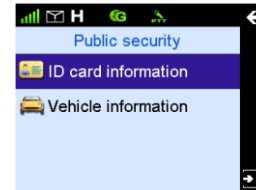

DMR Functions and Operations

You can input ID number to the ID editing interface and sent it to dataspace when you want to inquiry it .You also can review it from the history record.

Status Filing

Press Menu Key to access Main Menu to select “Applications—Status Filing”.

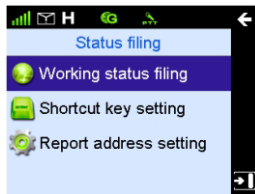

When the feature is enabled,the control center or other radio holder will master your working status etc. [Such as :on the job ,off the job or just leave the job].

You may process this function quickly through Shortcut Key Setting Menu.

Filing Address Setting: You may send your status to your assigned receiver through Filing Address Setting .

Roming

The radio signal strength are not strong enough to sure seamless communication.

To ensure no any break communication to some one base station to another base station . To enable this function, set in CPS as below :

1.In “Scan Public Setting “interface, select “Roaming switching” or “Roaming in Transmitting”.

To set “Enable Limits ” “Interval Time” “Strength Excursion “, “Switching Limits in Transmitting “,” “Switching Limits in Receiving”

Scan

In the home screen, the radio signal strength are not strong enough to achieve seamless communication.

This feature will enable radio will register from one base station to another.To enable this item, set in cps as follow: 1.To access this item, press “Scan Public Setting” interface in CPS and then select “scan”

2.To set “ Signal Strength Level” .This setting is used to enable the function while the signal strength is under a preset value. The radio will register from one station to another.

3.To set the “Time Interval”, “Signal Strength Excursion”, the radio will register to another high signal strength base station automatically.

MPT Trunking Functions and Operations

To ensure an optimal volume of the receiving radio, hold the radio approximately 2.5 to 5 centimeters away from your mouth .

Private Call

Transmitting a Private Call

You may transmit a Private Call through the following methods. When transmitting a Private Call ,this radio will set up calling automatically .



Transmitting a call through Contacts and Call Logs

1. Press Menu Key to go to Main Menu
2. Go to "Contacts List - Private Call Contacts List", Or go to "Call Logs" and access the outgoing /Incoming/Missed list.
3. Use the Up/Down Key to select the Private Call Contacts you want to call.
4. Use P3 Key  or PTT Key to transmitting a call

Through Manual Input

1. Input a Private Call number you want to call in home screen.
2. Use P3 Key , PTT Key or select Dial Key # to transmitting a Private Call.

Transmitting a Private Call through Redial List or Recall List.

1. Press P3 Key  to Redial List or P4 Key  to Recall List to Input a Private Call number you want to call in home screen.
2. Use P3 Key  or PTT Key to transmitting a Private Call.



Note:

Transmitting a Private Call failed while products unregistered or registration failed .

Receiving and Responding to a Private Call

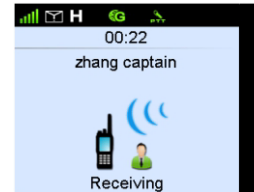

When a Private Call is received ,your radio automatic to transmitting a Private Call and a "De" alert tone sounds, your radio will display the icon. (As shown above).

You may press P3 key  or PTT key, coming call Ring and icon will disappear.

The first line display the coming call alias or ID (As shown above).

Voice Communication

After setting up a Private Call , both the calling party and called party are in PPT authorization interface , and hold down PTT Key to talk. While transmitting voice LCD will display this icon  : While receiving voice LCD will display PTT authorization interface .

MPT Trunking Function and Operations

Call Duration

After setting up a Private Call ,Both the calling party and called party LCD will display call duration in time .Unit is “Minutes :Seconds”. (As shown below)

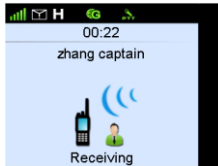

- The calling party LCD .

To count up the Call Duration by count -down,the starting time of count-down time is the total lasted talking time.

This time is preset time via system configuration .

When the total lasted calling time expires the preset time, this radio will return back from calling and end this call.

- The called party LCD

To count up the Call duration time by occurred time ,the start time from 0.

Communication Channel Display

- Display master control channel

After initiating a call application ,LCD will display master control channel of radio registered base station before setting up voice communication.

- Display main operation channel

After setting up a call, LCD will display the operation channel of the current base station occupied.

Ending Call

- 1.Nobody hold down PTT Key for a long time ,and this radio will end call automatically when silence period expires .
- 2.This radio will end call when the total calling time expires the preset time.
- 3.During calling, any party of calling or called hang up.
- 4.Basestation signal lost.

MPT Trunking Function and Operations

Group Call

You may transmit a Group Call through any of the following methods.

Transmit a call to the preset contacts.

Hold down PTT Key to transmit a Group Call to a Group Call contacts preset for the current channel in home screen. (By the Group Knob to select a group you want to call)





Transmitting a group call to “Contracts List--Contacts”

1. Press Menu Key to Main Menu
2. Go to “Contracts List--Contacts”
3. Use the Up/Down Key to select the Group Call contacts you want to call.
4. Use P3 Key or PTT Key  to transmitting a Group Call.

Transmitting a group call through manual input

1. Input a group call number you want to call in the home screen.
2. Press PTT Key, P3 Key  or Dial Keypad # to transmitting a Group Call

Transmitting a call through recall List or Call Backlist

1. Use P3 key , to go to Call Logs List or press P4 Key  to select Group Call number you want to call.
2. Use P3 key  or PTT Key  to transmit a Group Call.

Receiving and Responding to a Group Call

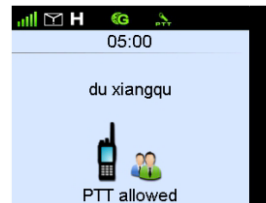

When a Group Call is received, your radio set up call automatically and sounds “De”, your radio will display the icon. (As shown above) The first line display the coming call alias or ID.

Late Access

After set up group call, this radio allows the member haven't joined in this group transmit this call during calling.

Voice Communication

After setting up a Group Call, both the calling party and called party are in PPT authorization interface, and hold down PTT Key to talk. While transmitting voice LCD will display this icon , While receiving voice LCD will display PTT Allowed interface.

MPT Trunking Function and Operations

Call Duration

After setting up a Group Call ,Both the calling party LCD and the called party LCD will display Call Duration in time . Unit is "Minutes :Seconds."(As shown)



- The calling party LCD .

To count up the Call Duration by count-down,the starting time of count-down time is the total lasted talking time . This time is preset time via system configuration .

When the total lasted calling time expires the preset time , this radio will return back from calling and end this call.

- The called party LCD

To count up the Call duration time by occurred time ,the start time from 0 .

To count up from the called party access to Group Call .

Recount up by count-down requires when the called party end Group Call and access this group through"Late Access"

Communication Channel Display

- Display master control channel

After initiating a call application ,LCD will display master control channel of radio registered base station before setting up voice communication.

- Display main operation channel

After setting up a call, LCD will display the operation channel of the current base station occupied.

Ending Call

- 1.Nobody hold down PTT Key for a long time ,and this radio will end call automatically when silence period expires .
- 2.This radio will end call when the total calling time expires the preset time.
- 3.During calling, any party of calling or called hang up.
- 4.Base station signal lost.

MPT Trunking Functions and Operations

All Call

Two types of All Call are Team All Call and Whole Network All Call.

Team All Call

999 is the last one Group Call number in this team ,When you initiate a team All Call,all member in this team will receive and respond to this call .

Three methods are available for transmitting a Team All Call :
Transmitting a call to preset contacts ,transmitting a call through group call contacts or through manual input number .
The specific operation is the same as the Group Call.

System All Call

When you transmit a System All Call ,all user in this system will join in this call.

1981 is the number of System All Call.

Three methods are available for transmitting a System All Call :
Transmitting a call to preset contacts ,transmitting a call through group call contacts or through manual input number .
(Add * Key before 1981).

Emergency Call

Emergency Call can be Emergency Private Call or Emergency Group Call .

The following two methods are available to initiate a Emergency Call.

1.Press Emergency Call Key to initiate a Emergency Call.

The called number can be set via programming software in trunking mode .

2.Through manual input number to initiate a Emergency Call.
(Add *9* before number).

Use P3 key , PTT Key or # key to initiate a call.

Broadcast Call

Broadcast Call only can be Broadcast Group Call .

Only the calling party has the rights of speech.

You may initiate Broadcast Call through manual input .
(Add *11* before number).

Use P3 key , PTT Key or # key to initiate a call.

Priority Call

Via programming software configuration to set a Priority Call level:Low ,Middle ,High or Preempted Call .

You may initiate Priority Call through manual dial
(Add *8* before number).

Use P3 Key , PTT Key or # key to initiate a call.

Dispatcher Station Call

This radio can call the Dispatcher Station. The number of Dispatcher Station are based on configuration.

MPT Public Network Calling

The calling with Public network phone is called MPT public network Call.

For your better use ,for example as follow.

House Fixed Telephone fixeded fixr	Dail fixed telephone number directly	Such as dial 8036 directly
External Fixed Telephone	Add 0 before telephone number	Such as 00755-33010296
Making Local Mobile Telephone Call	Add 0 before telephone number	Such as 013112345678
Making Nonlocal Mobile Telephone Call	Add 00 before telephone number	Such as 0013112345678

MPT Trunking Functions and Operations

MPT-DMR Call

Base on the appropriate MPT-DMR Group Call number configured by base station ,you can achieve MPT trunking radio cal DMR trunking mode radio each other.

MPT trunking radio transmit a MPT-DMR call

In MPT trunking mode ,you may transmit a MPT-DMR Call through any of the following methods.

- 1,Transmitting a call to the preset contacts.
- 2,Transmitting a call through Group Contacts .
- 3,Through manual input.(Specific operation is the same as group call)



Note: In DMR Trunking mode ,your radio must wait to the corresponding group.

(No need wait in this group when the DMR corresponding group is the responding group).

DMR trucking mode radio initiate a call to DMR-MPT is the same as the above operations.

Emergency Caution

Setting a Private Call, Group Call or Dispatch Station Call number via CPS setting ,press the Emergency Caution Key on the microphone or the front panel of radio for 3 seconds to initiate a Emergency Call.

Receiving and Responding to a Call

In DMR trunking mode ,When a group call /private call is received , your radio set up calling automatically and a alert ton“De” sounds.

The group alias or ID number will display on the first line of screen and private calling group name or private ID number will display on the last line. .



Late Access

After setting up group call,this radio allows the member haven't joined in this group transmit this call during calling .

MPT Trunking Functions and Operations

Call Logs

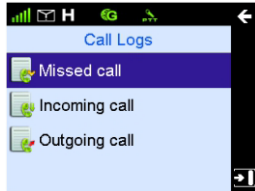

This radio can save up to 200 call entries. When the entries list is full, the earliest entry will be overwritten by the latest one automatically.

To view, delete, or delete all after selecting one call entry.

Redial List

All outgoing call list will be saved in the Redial List.

Use P3 key to access this item in the home screen.

(As shown) Use P4 Key or PTT Key to select the outgoing entries to initiate a call, delete it or delete all.



Callback List

The callback List will save up all the incoming entries.

To access this item, use P4 key in the home screen (As shown).

Use P3 key or PTT key to initiate a call, delete it or delete all.

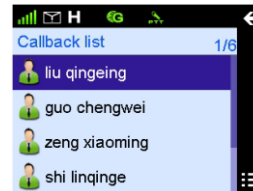

Redial List and Callback List

Use P3 key to access "Redial List" and "Callback List".

This radio can save up to 10 call entries. When the entries list is full, the earliest entry will be overwritten by the latest one.

MPT Trunking Functions and Operations

Manual Input to Temporary Group

For temporary or quicker dispatch and command one group, to call the group number by manual input. Group Call Contacts List will add the temporary group and add it to the current group automatically after ending the call. The temporary group will delete automatically after restarting.

Caution!

To enable this function, must select "Manual Dial Temporary Group" in CPS.

Scan

In home screen, the radio signal strength are not strong enough to sure seamless communication, the radio will register from one base station to another. To enable this item, set in CPS as below:

- 1.To access this item, press "Scan Public Setting" interface in CPS and then select "Scan"
- 2.To set "L1 level of MPT wireless signal strength indicator RSSI". This setting is used to enable the function while the signal strength is under a preset value. When the radio register from one station to another, the radio will register to another high signal strength base station automatically.
- 3.To set the "Sampling Amount", "Scan Sampling Period", "L0 Level of MPT Wireless Signal Strength Indicator RSSI".

Digital Conventional Functions and Operations

Private Call, Group Call and all Call

Transmitting a Private Call

You may transmitting a Private Call through any of the following methods.

Transmitting a call through Contacts List or Call Logs.

1. Go to "Contacts List-Contacts ", Or go to "Call Logs" and access to the Outgoing/Incoming/Missed list.
2. Use Up /Down Key to select a Private Call Contacts you want to call.
3. Hold down PTT Key to transmitting a Private Call through manual input

1. Go to " Contacts-Manual Dial"

2. Input a Private Call number you want to call.
3. Hold down the PTT key to transmitting a Private Call.

Transmitting a Group Call

You may transmitting a Group Call through any of the following methods.

Transmitting a Call through Contacts List or "Call Log.

1. Go to "Contacts List—Contacts "or through "CallLog"to go to Outgoing/Incoming /Missed Call.
2. Use the Up/Down Key to select a Group Call contacts you want to call.
3. Hold down PTT key to select a Group Call Contacts you want to call.

Transmitting an All Call

You may transmit a private and an All Call through any of the following methods.

Transmitting an All Call through Contacts List or "Call Log.

1. Go to "Contact List—Contacts"or through "CallLog"to go to Outgoing/Incoming /Missed Call list.
2. Use the Up/Down Key to select an All Call contacts you want to call.
3. Hold down PTT key to Transmit an All Call.



Note:All call ID is a fixed ID.

Emergency Call

Meet an emergency, you can use this function to search companion or control center for help.

If you need in a certain channel enabled on emergency call function, you must configure via programming software. This channel is relevant to one call ,only press "TK"key for long time to transmit a emergency call .

Digital Conventional Functions and Operations

Message

To access the Menu, press Menu key to go to Main Menu to select "message".

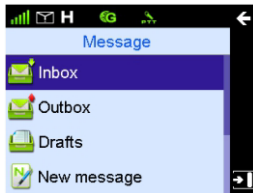

Inbox

This radio can save the received messages into Inbox. The Inbox can save up to 100 received messages. When the Inbox save up to 90 received messages, and go on receiving messages, this radio will appear notes "InBox will be full, please delete message" and the earliest message will be over written by the latest one automatically.

Outbox

This radio can save the sent messages into Outbox. Each message will appear appropriate icon to note message send successfully or not .
a, When the message sent successfully, the icon "✓" will appear.

b, When the message sent unsuccessful, the icon "!" will appear and please send again. The Outbox can save up to 100 sent messages. When the Outbox is full, the earliest message will be overwritten by the latest one automatically.

Drafts

This radio can save up the edited message into Drafts. The Drafts can save up to 10 draft message .When the Drafts is full, the earliest message will be over written by the latest one automatically.

New Msg

You can create new text message (179 characters at most) and send it to an individual user or to a talk group.

Quick Text

Under this option there are some text messages (10 entries at most) preset by your dealer. You can choose and send any entry.

Status Msg

Under this option there are some text message (95 entries at most) preset by your dealer. You can choose and send any entry .The status Msg is status code.

Digital Conventional Functions and Operations

Call Logs

To access this menu, press Menu key to Main Menu and select "Call Logs", or press the shortcut key for Call Logs directly.

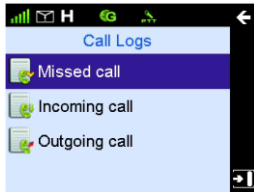

This radio can save up to 200 call entries. When the entries list is full, the earliest entry will be overwritten by the latest one automatically.

After accessing a list and selecting an entry, you can perform any of these operations: hold down the PTT key to initiate a call, add it to Contact List, or delete it.

To delete all entries in the Outgoing /Incoming/Missed list at a time, select "Call Logs-Outgoing /Incoming/Missed-Delete All".

Zone

Zone is a channel group; you can list the same channel in a zone.

This function will help you manage the current channel.

This radio supports up to 16 zones.

Each zone up to 64 channels.

You can select your desired zone as follows:

1. You can use this menu to select your desired zone.

To access "Zone", Press Up/Down key to select the Zone, then press OK Key to switch to the desired zone.

2. You can use the programming Key to select your desired zone.

If you preset Zone Up /Zone Down shortcut key, press this key to switch to desired zone.

Analog Conventional Functions and Operations

DMO and TMO

This radio supports DMO and TMO

DMO:Set all radio transmitter and receiver at same frequency via CPS configuration. Under this mode ,radios communicate with each other directly.

TMO :Set all radio transmitter and receiver at different frequency via CPS configuration. Under this mode , radios communicate with each other via a repeater.

Squelch Level

You can select the squelch Level by menu from Strengthen , Normal and Always On .

Or press Squelch level Switching programmable Key to switch the level.

This radio default at Norma generally.Strengthen requires the receipt signal high enough to turn on the speaker .

When the level set at Normal (Squelch level is 0) this radio will turn on the speaker directly automatically and sounds the background voice .

Optional Accessories

The following items are the main optional accessories for the product and please consult your local dealer for more other accessories.

				
Keypad Microphone EMKA01	Power Supply EEPS01	Antenna TCTQ370-04V60Z	GPS Antenna EAM157501	Vehicle Remote Control Head ERC01
				
Motorcycle Remote Control Head ERC02	Bluetooth Earphone EEWB021	Smart Bluetooth Earphone EEWB011	Bluetooth PTT EPTTB01	USB Programming Cable EPC02



Caution: Use the accessories specified Excera only. If not, Excera shall not be liable for any losses or damages arising out of use of unauthorized accessories.

Troubleshooting

Phenomena	Analysis	Solution
The Radio Can not be powered on.	The battery may be improperly installed	Remove the battey and attach it again.
	The battery may run out	Recharge or replace the battery
	The battery may suffer from poor contact caused by dirtied or damaged battery contacts	Clean the battery contacts. If the problem can not be solved,contact your dealer or authorized service center for inspection and repair.
The Radio can not be registered.	The radio can not detect the basestaion signal.	Make sure the radio in base station effective signal range.
	The radio is not the basestation legal user ,can not be registered.	Contact the person who are in charge of this base station,make sure the radio are the legal user of base station NMS
Repeated registration	During receiving signal is discontinuous.	Make sure the radio in base station effective signal range.
The Radio Can not transmit and respond call.	During receiving signal is weak.	Make sure the radio in base station effective signal range.
No voice when transmitting and responding call.	The radio ID may be repeated	Contact the person who are in charge of this base station, make sure no the radio ID are repeated of base station NMS.
The responding party is inactive repeately during calling.	Signalis discontinuous,get access to transmitting again after signal is totally inactive.	Make sure the radio in base staion effective signal range.
During receiving signals, the voice is weak discontinuous or totally inactive.	The battery strength may be too low.	Recharge or replace the battery.
	The volume may be set to a low level.	Increase the volume by Volume Control Knob.
	The antenna may be get loose or may be improperly installed.	Power off the radio ,and re-install the antenna.
	The speaker may be blocked or damaged	Clean surface of the speaker.If the problem can not be solved,contact your dealer or authorized service center for inspection and repair.
You can not communicate with other members	The poor quality of communication signals	Make sure all member in the effective communication range.
Irrelevant communication or noise is heard on the channel	The poor quality of communication signals	Make sure all member in the effective communication range.
The noise is too loud.	The poor quality of communication signals	Make sure all member in the effective communication range.
	You may suffer from external disturbance (such as electromagnetic interference).	Move to an open and flat area,and restart the radio.
	You may be at an unfavorable position.For example,your communication may be blocked by high buildings or frustrated in the underground areas.	Stay away from equipment that may cause interference.

If the above solutions can not fix your problems,or you may have some other queries,please contact us or your local dealer for more technical support.

Warranty and Maintains

Scope of Warranty

EM 8100 Digital Mobile Radio and Accessories.

Warranty Contents

- 1.From the date of purchase and without any artificial damage, Warranty varies based on product types .
We will provide 36 months warranty service for main radios and 12 months warranty service for battery ,charger ,adapter and other standard accessories etc.
- 2.Completes Warranty Card or provides valid original invoices or receipts for warranty judgment .This invoice or receipt shall indicate radio accessories, radio serial number ,purchase date and amount.
- 3.Products problem caused by non-artificial can return, exchange or repair within 7 days. 15 days can be a replacement or repair, more than 15 days and within the warranty can be free repair.
- 4.We provide life-long maintenance service for customer .For products beyond the warranty, we still can continue to provide repair and maintenance services and will charge for those service.

Non-Warranty Service

- 1.Defect or damage is due to improper use of the product, including but not limited to the defects and damage caused by using this product without complying with the warning or user manual.
- 2.Defect or damage due to remake, change and disassembly or make use of non-original accessory or battery without the authorization of Excera.
- 3.Defect or damage is due to force majeure (earthquake, flood disaster, fire disaster, etc.)
- 4.Cannot produce valid warranty certifications (Warranty Card, Invoice or Receipt etc.)
- 5.By the rational judgment of Excera, serial number code label, the accessory date code label or relevant Excera a sign of a product has been removed, defaced or altered.
- 6.Fair wear and tear.
- 7.Battery in the following circumstances:
 - 1)Any artificial damage or unsealed phenomenon of battery case seal.
 - 2)Defect or damage due to the charging or using at variance with the products prescribed.

Disclaimer

The company endeavors to achieve the accuracy and completeness of this manual, but no warranty of accuracy or reliability is given. All the specifications and designs are subject to change without notice due to continuous technology development. No part of this manual may be copied, modified, translated, or distributed in any manner without the express written permission of us.

Table 1

Antenna	Safe Distance, R_{safe} , (cm)
	FCC Part 2.1091
	Controlled RF Exposure
TCTQ370-04V60Z (3.5dBi)	61

Table 2

Antenna	Safe Distance, R_{safe} , (cm)
	RSS-102
	Controlled Use Devices (Controlled Environment)
TCTQ370-04V60Z (3.5dBi)	182

Warranty Card

Purchase Information: _____

Customer Name: _____

Customer Phone: _____

Customer Address: _____

Purchase Date: _____

Radio Information: _____

Radio Model Number: _____

Radio Serial Number: _____

Note:

This Warranty Card is applicable to the above serial number radio and accessories service.

Please properly keep the warranty card, please show this card and related invoice when enjoy this service.

This card shall become effective after dealer affixed their seals to it .

Any artificial damage belong to the non-warranty scope, please see the specific warranty scope as stated in "service policy".

Please tear from the Dotted line