



EXCERA

USER'S MANUAL

Digital Portable Radio EP8100 VHF



Contents

Important Information	3	High Noise Reduction	18
RF Energy Exposure Information	4	Time-out-Timer (TOT)	18
Operation Safety Recommendations	5	GPS Positioning	18
Radio Safety Information and RF Radiation Information	7	DMR Trunking Functions and Operations	19
Disabled Frequency	7	Private Call	19
Packing List	7	Group Call	21
Before Use	12	All Call	22
Ready to Use	12	Emergency Call	23
Product Controls	15	Broadcast Call	23
LED Indicator	16	Priority Call	23
Status Icons	16	Dispatch Station Call	23
Product Functions and Operations	17	DMR Public Network Call	23
Operation Mode	17	DMR-MPT Call	23
Product Information Display	17	Contacts	24
Time and Date Setting	17	Message	25
Alert Tone	17	Status Message	25
Vibration	17	Call Logs	26
Backlight	17	Redial List and Callback List	26
Menu Reset	18	Vehicle Inquiry	27
Locking/Unlocking the Keypad	18	ID Inquiry	27
Programmable Keys	18	Status Filing	27

Contents

MPT Trunking Functions and Operations	28	Optional Accessories	38
Private Call	28	Troubleshooting	39
Group Call	29	Warranty and Maintains	40
All Call	31	Scope of Warranty	40
Emergency Call	31	Warranty Contents	40
Broadcast Call	31	Non of Warranty	40
Priority Call	31	Disclaimer	41
Dispatch Station Call	31	Warranty Card	42
MPT Pubic Network Call	32		
MPT-DMR Call	32		
Call Logs	32		
Redail and Callback List	33		
Digital Conventional Functions and Operations	34		
Private Call, Group Call and All Call	34		
Emergency Call	34		
Information	35		
Call Logs	36		
Zone	36		
Analog Conventional Functions and Operations	37		
DMO and RMO Mode	37		
Squelch Level	37		

Important Information

Note:

Ic Note : Cet Appareil Est Conforme À La Partie 15 Des Règlements De La Fcc Et Aux Normes Rss De L'industrie Du Canada. Son Fonctionnement Est Soumis Aux Deux Conditions Suivantes : (1) Cet Appareil Ne Doit Pas Causer Des Interférences Nuisibles, Et (2) Cet Appareil Doit Accepter Toute Interférence Reçue, Y Compris Les Interférences Qui Peuvent Provoquer Un Fonctionnement Indésirable..

Le Fabricant N'est Pas Responsable Des Toutes Interférences Radio Ou Télévision Causées Par Des Modifications Non Autorisées Apportées À Cet Appareil. De Telles Modifications Peuvent Empêcher L'utilisateur D'utiliser L'appareil.

Ic Note:

This Device Complies With Part 15 Of The Fcc Rules And Industry Canada License-exempt Rss Standard(s). Operation Is Subject To The Following Two Conditions: (1) This Device May Not Cause Harmful Interference, And (2) This Device Must Accept Any Interference Received, Including Interference That May Cause Undesired Operation.

The Manufacturer Is Not Responsible For Any Radio Or Tv Interference Caused By Unauthorized Modifications Or Change To This Equipment. Such Modifications Or Change Could Void The User's Authority To Operate The Equipment.

The Users Manual Or Instruction Manual For An Intentional Or Unintentional Radiator Shall Caution The User That Changes Or Modifications Not Expressly Approved By The Party Responsible For Compliance Could Void The User's Authority To Operate The Equipment. In Cases Where The Manual Is Provided Only In A Form Other Than Paper, Such As On A Computer Disk Or Over The Internet, The Information Required By This Section May Be Included In The Manual In That Alternative Form, Provided The User Can Reasonably Be Expected To Have The Capability To Access Information In That Form.

Important Information

RF Energy Exposure Information

RF Energy Exposure Awareness And Control Information For Fcc Occupational Use Requirements

Before using the two-way portable radio, review the following important RF energy awareness and control information and operational instructions. Comply with this information and instructions in order to ensure compliance with RF exposure guidelines. Use the capability to access information in that form.



WARNING

This radio is intended for use in occupational/controlled conditions, where users have full knowledge of their exposure and can exercise control over their exposure to remain below RF exposure limits. This radio is NOT authorized for general population, consumer, or any other use.



CAUTION

Changes or modifications not expressly approved by Shenzhen Excera Technology Co., Ltd. could void the user's authority to operate the equipment.

This two-way radio uses electromagnetic energy in the radio frequency (RF) spectrum to provide communications between two or more users over a distance. It uses RF energy or radio waves to send and receive calls. RF energy is one form of electromagnetic energy. Other forms include, but are not limited to, electric power, sunlight, and x-rays. RF energy, however, should not be confused with these other forms of electromagnetic energy, which, when used improperly, can cause biological damage. Very high levels of x-rays, for example, can damage tissues and genetic material.

Experts in science, engineering, medicine, health, and industry work with organizations to develop standards for exposure to RF energy. These standards provide recommended levels of RF exposure for both workers and the general public. These recommended RF exposure levels include substantial margins of protection. All two-way radios marketed in North America are designed, manufactured, and tested to ensure they meet government-established RF exposure levels. In addition, manufacturers also recommend specific operating instructions to users of two-way radios. These instructions are important because they inform users about RF energy exposure and provide simple procedures on how to control it. Refer to the following websites for more information on what RF energy exposure is and how to control exposure to assure compliance with established RF exposure limits:

<http://www.fcc.gov/oet/rfsafety/rf-faqs.html>

<http://www.osha.gov/SLTC/radiofrequencyradiation/index.html>

Important Information



Federal Communications Commission Regulations

Before it was marketed in the United States, the Digital portable radio was tested to ensure compliance with FCC RF energy exposure limits for two-way portable radios. When two-way radios are used as a consequence of employment, the FCC requires users to be fully aware of and able to control their exposure to meet occupational requirements. Exposure awareness can be facilitated by the use of a label directing users to specific user awareness information. The radio has an RF exposure product label.

Also, the Product Safety Manual and this Operator's Manual include information and operating instructions required to control RF exposure and to satisfy compliance requirements.

Operation Safety Recommendations

Occupational Safety Guidelines And Safety Training Information

To ensure bodily exposure to RF electromagnetic energy is within the FCC allowable limits for occupational use. Always adhere to the following basic guidelines:

- The push-to-talk button should only be depressed when intending to send a voice message.
- The radio should only be used for necessary work-related communications.
- The radio should only be used by authorized and trained personnel. It should never be operated by children.
- Do not attempt any unauthorized modification to the radio. Changes or modifications to the radio may cause harmful interference and/or cause it to exceed FCC RF exposure limits. Only qualified personnel should service the radio.
- Always use only authorized accessories (antennas, control heads, speakers/mics, etc.). Use of unauthorized accessories can cause the FCC RF exposure compliance requirements to be exceeded.

The information listed above provides the user with information needed to make him or her aware of a RF exposure, and what to do to assure that this radio operates within the FCC exposure limits of this radio.

Important Information

FCC Caution:

Part 15.21

Any Changes or modifications not expressly approved by the party responsible for compliance could void the user's authority to operate the equipment.

Part 15.19

This device complies with part 15 of the FCC Rules. Operation is subject to the following two conditions: (1) This device may not cause harmful interference, and (2) this device must accept any interference received, including interference that may cause undesired operation.

Part 15.105

Note: This equipment has been tested and found to comply with the limits for a Class B digital device, pursuant to part 15 of the FCC Rules. These limits are designed to provide reasonable protection against harmful interference in a residential installation. This equipment generates, uses and can radiate radio frequency energy and, if not installed and used in accordance with the instructions, may cause harmful interference to radio communications. However, there is no guarantee that interference will not occur in a particular installation. If this equipment does cause harmful interference to radio or television reception, which can be determined by turning the equipment off and on, the user is encouraged to try to correct the interference by one or more of the following measures:

- Reorient or relocate the receiving antenna.
- Increase the separation between the equipment and receiver.
- Connect the equipment into an outlet on a circuit different from that to which the receiver is connected.
- Consult the dealer or an experienced radio/TV technician for help.

Important Information

FCC RF Radiation Exposure Statement:

This radio is designed for and classified as "Occupational/Controlled Use Only", meaning it must be used only during the course of employment by individuals aware of the hazards, and the ways to minimize such hazards; NOT intended for use in an General population/uncontrolled environment.

DO NOT operate the radio without a proper antenna attached, as this may damage the radio and may also cause you to exceed RF exposure limits. A proper antenna is the antenna supplied with this radio by the manufacturer or an antenna specifically authorized by the manufacturer for use with this radio.

DO NOT transmit for more than 50% of total radio use time, more than 50% of the time can cause RF exposure compliance requirements to be exceeded.

This transmitter may operate with the antenna(s) documented in this filing in Push-to-Talk and body-worn configurations. RF exposure compliance is limited to the specific belt-clip and accessory configurations as documented in this filing and the separation distance between user and the device or its antenna shall be at least 2.5 cm.

Important Information

RED Caution

1. Frequency:136-174MHz, TX Power:<4.2W
2. Operation temperature range: -30~60 .
3. RF exposure information: The device complies with RF exposure require when the device used at 25mm form your face and 0mm from the body with the belt-clips.
4. Hereby, Shenzhen Excera Technology Co., Ltd. declares that this product is in compliance with essential requirements and other relevant provisions of Directive 2014/53/EU. This product is allowed to be used in all EU member states.

5. AC adapter

The adapter shall be installed near the equipment and shall be easily accessible.

6. Lithium Battery

Risk of explosion if battery is replaced by an incorrect type, dispose of used battery according to the instructions.



Important Information

Country	Frequency Range(MHz)
Austria(AT)	156.4875 - 156.5125 160.3 - 160.300001,169.4 - 169.8125
Belgium(BE)	146 - 156,157.45 - 160.6,160.975 - 161.475,162.05 - 169.4, 169.825 - 174
Bulgaria(BG)	146 -161.9625,161.9875 -174
Croatia (HR)	138 - 144,146 -156,157.45 - 160.6,160.975 - 161.475, 162.0375 - 174
Cyprus (CY)	138 - 144,146 -156,157.45 - 160.6,160.975 - 161.475, 162.0375 - 174
Czech Republic (CZ)	148.2 - 149.05,150.05 - 150.975,152.8 - 153.65
Denmark(DK)	146 - 149.9,150.05 - 153,154 - 156.4875,156.8375 -174
Estonia(EE)	150.05 - 156.7625,157.45 - 160.6,160.625 - 160.95, 160.975 - 161.475,162.05 - 169.4
Finland(FI)	146.30625 - 149.9,151.00625 - 154.89375, 157.45 - 158.8,161.175 - 161.375,162.05 - 163.4,165.3 - 174
France (FR)	168.9 - 169.4,173.5 - 174
Germany(DE)	146 - 148,149.14 - 156,158.34 - 167.54,170.3 - 172.15
Greece(EL)	138 - 143.6,146 - 148.2,150.05 - 151.6,154.5 - 161.4875, 162.0375 -174
Hungary(HU)	156 - 156.7625,156.8375 - 167.3,169.6375 - 174
Ireland (IE)	154 - 156.7625
Italy(IT)	146 - 156.4875, 156.8375 -161.9625,162.0375 - 174
Latvia (LV)	146 - 174
Lithuania(LT)	146 - 156,157.45 - 160.6,160.975 - 161.475,162.05 - 174
Luxembourg (LU)	146 - 174
Malta(MT)	146 - 156,157.45 - 160.6,160.975 - 161.475,162.0375 - 174

Important Information

Netherlands(NL)	146 - 156.4875, 156.8375-161.9625,162.0375 - 174
Poland(PL)	147.8 - 147.975, 150.05 - 151.625, 151.775 - 156, 157.425 - 159.9, 159.9 - 160.6, 160.975 - 161.475, 162.05 - 164.475, 167.5 - 168.5, 169.825 - 174
Portugal (PT)	148 - 149.9,150.05 - 156.4875 , 156.8375 - 174
Romania(RO)	146 - 149,149.55 - 149.8,150.05 - 156,159.175 - 160.6, 160.975 - 161.125,161.275 - 161.475,164.05 - 169.4, 169.6125 - 174
Slovakia(SK)	146 - 149.9, 150.05 - 153.5625, 155.5125 - 156, 156.8375 -
Slovenia(SI)	146 -156.4875, 156.9375 - 161.9625, 162.0375 - 174
Spain(ES)	146 - 149.9, 150.05 -156.4875, 156.5625 - 156.7625, 156.8375 - 174
Sweden(SE)	146.05 - 147, 150.05 - 151,156.8375 - 162.0375,162.025 - 163,164 - 171,172 - 174
United Kingdom (UK)	137.975 - 138.2,139.51875 - 140.98125, 143 - 144,148.01875 - 148.98125,153.025 - 153.475, 154 - 155,157.205 - 165.0375,158 - 165,165.05 - 173.0875,

Important Information

Please read this manual carefully before use.

Alert Icons



Caution: Indicates situations that could cause data loss or damage to your products.



Note: Indicates tips that can help you make better use of your products.



Caution!

Restricted to occupational use to satisfy FCC RF exposure limits.

Packing List

Please unpack carefully and check that all items listed below are received.

If any item is missing or damaged, please contact your dealer.



1 Radio Unit

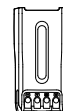

2 Battery



3 Charger

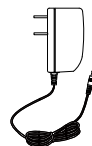

4 Power Adapter



5 Antenna



6 Belt clip



7 Manual

Before Use

Before Use radio

Charge the Battery

This radio is built in Li-ion battery .In order to prevent from damaging and comply with the warranty, use only the charger and battery specified by Excera.The following figure shows the steps for charging.



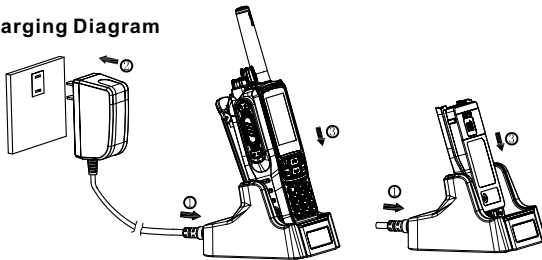

Charging Diagram



Procedures

- 1.Plug the other end of the power adapter into the rear jack of the charger.See arrow①.
- 2.Connect the power adapter to AC socket,See arrow②.
- 3.Place the radio with the battery attached,or the battery alone, into the charger.See arrow③.
- 4.The charging process initiates when LED glows red,and is completed when LED glows green.

Charging Indicator

LED Indicator	Charging Status
 Red LED flashes slowly	Standby (no load)
 Red LED glows	Charging
 Orange LED glows	90% charged
 Green LED glows	Fully charged
 Red LED flashes rapidly	Failure

Before Use

Attaching the Battery

- 1.Insert the battery into top of the radio .see arrow①.
- 2.Slightly press the bottom of the battery until a click is heard. See arrow②.

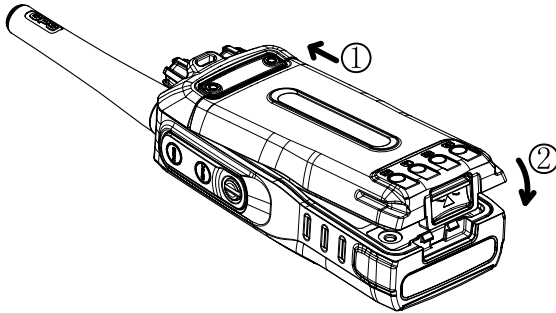

Note:



To remove the battery ,turn off the radio first.Then slide the battery latch upwards to unlock the battery.

Attaching Antenna

Plug the antenna to antenna pedestal,turn the antenna clockwise to fasten it .

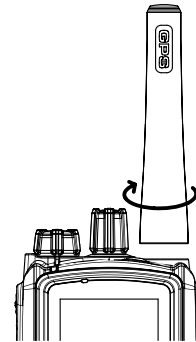

Note:



Turn off the radio before removing .To remove the antenna,rotate it counter-clockwise.

Before Use

Attaching the Belt Clip

- 1.Remove the screws from the back of radio.
- 2.Align the screw holes on the belt clip with those on the radio's body ,and then tighten the screws.

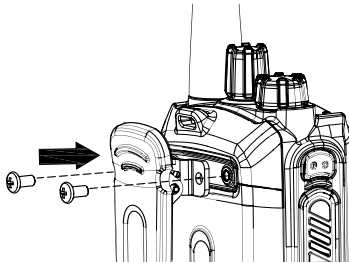

Note:
To remove the belt clip,loosen the screws.

Attaching the audio accessory/Programming Cable

- 1.Open the accessory jack cover as the arrow shown.
- 2.Align the plug with accessory jack.
- 3.Tighten the screw on the plug.

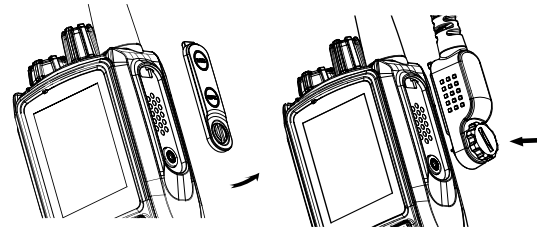

Note:
To remove the accessory ,loosen the screws.



Caution:
When you are using an external accessory ,
Waterproof performance of the radio may get affected.

Before Use

Product Controls

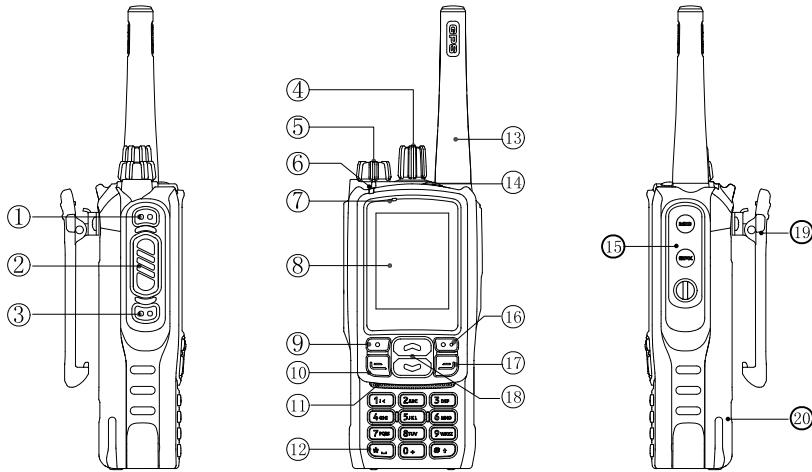











No.	Part Name	No.	Part Name	No.	Part Name
①	SK1 (Side 1 Key)	⑧	LCD Display	⑮	Accessory Jack
②	PTT Key	⑨	Menu Key	⑯	Setting Key
③	Sk2 (Side 2 Key)	⑩	Answer/ Calling Key P1	⑰	Hang Up /Home Key P2
④	Channel/Group Selector Knob	⑪	Speaker	⑱	Up and down Key
⑤	Radio On-off/ Volume Control Knob	⑫	Numeric Key	⑲	Belt Clip
⑥	LED Indicator	⑬	Antenna	⑳	Battery
⑦	Speaker	⑭	TK key		

Before Use

LED Indicator

LED Indicator	Radio Status
LED flashes green slowly.	Standby(no load)
LED flashes green rapidly.	Upgrading or powering on
LED glows green.	Receiving
LED flashes Red slowly.	Low power warning
LED flashes red rapidly.	Receiving
LED glows red.	Transmitting
LED flashes orange slowly.	Scanning
LED flashes orange rapidly.	Receiving
LED glows orange.	After voice communication ends,you can hold down the PTT key to talk while the LED is glowing orange.

Status Icons

Icon	Icon Name
	Signal Strength Icon
	New Message Icon , Inbox Icon is full
	Scan Icon
	High Power Icon
	Low Power Icon
	Battery Strength Icon
	Accessory Icon
	Roam Icon
	GPS Icon
	Missed Call Icon

Product Function and Operations

Operation Mode

This radio supports three operation Mode :DMR Trunking mode,MPT Trunking mode and Conventional mode(Digital and Analog).Switching Methods:

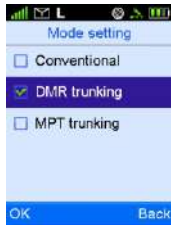

Press the Setting Key to access "Function Setting"- "Mode Setting" and select a appropriate mode.

Note: To access Digital Conventional Mode and Analog Conventional Mode to select Conventional Mode.

Product Information Display

You may achieve the following product information in this interface : Product Name,Product ID,Series Number,Frequency Range,Product Versions,Data Base Versions,Vocoder Versions, Lastest Programming Date and ESN Code and so on. Press Setting Key to access Product Information interface and review all the information.

Time and Date Display Setting

Use this function to modify this radio Date and Time. Press "Setting"Key to access "Radio Setting"- "Date and Time"interface to modify the Date and Time.

Alert Tone

This function enable you set the following tones for your radio:"Keypad Tone", "Calling Tone","Called Tone", "Function Tone";"Warning Tone";"Low Battery Tone"and Test Message Tone" Press "Setting"Key to access "Radio Setting"- "Tone".

Notes: The function tone is the alert tone of the programmable Key function On/Off and Switching ,such as High or Low power Switching and Zone Switching.

Vibration

To set whether to enable the vibration function base on user habit .To set this funcation via the CPS and Radio Menu setting.

Backlight

To set the backlight parameters of On/Off time,Off Type and Brightness Value. Press"Setting"key to access "Radio Setting"- "Display Setting" .

Product Functions and Operations

Menu Reset

This radio supports Menu Reset function ,that is ,if you don't operate the menu for a predefined time period.This radio will automatically reback to the home screen.

Hold down the Setting Key ,go to the "Product Setting" -"Menu Reset"

Locking/unlocking the Keypad

Through Key Combination ,Press Menu Key+  Key to lock and unlocking the keypad.

Programming Key

You are available to set the keys SK1、SK2 and TK key as the shortcuts, such as High Power and Low Power switching and Zone Up and Zone Down,Squelch and Scan .This function only via the CPS setting.

High Noise Reduction

This function will effective reduce the noise under the high noise conduction.

The noise reduction reach 25dB and makes voice will be clear.

This function are available for your setting through the Programmable Key and radio Menu.



Note: This feature default off .If this feature is enabled your speaking volume will be low. After this feature is enabled, you need speak near the MIC.

Time- out Timer(TOT)

The purpose of TOT is to prevent any user from occupying a channel for an extended period.You can set the longest time of single pressing PTT.



If the preset time expires ,the radio will terminate transmission automatically .

This feature can be enabled via the programming software.

GPS Positioning

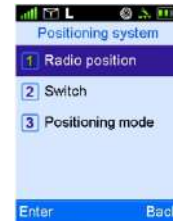
This function helps to get and upload the radio GPS location data(As shown).



Press "Setting"Key ,to go to "Radio Information"- "Positioning System"- "Positioning System On/Off"to turn On/Off GPS function. After GPS turn on,the radio status Positioning iron will display.If the GPS locate successfully ,the Iron change to  from  . Review the GPS positioning data from the "Radio information"- "Positioning System"- "Radio Positioning Information".

Product Functions and Operations



Note:

To ensure an optimal volume of the receiving radio, hold the radio approximately 2.5 to 5 cm from your mouth.

Private Call

Under DMR trunking mode, to set Private Call type via trunking system. FOACSU and OACSU

- FOACSU: While setting up a call, ring warn the calling party, and the called party receive the call through manual operation.
- OACSU : While setting up a call without any ring warn for the calling party, and the called party receive the call through manual operation.

Transmitting a Private Call



You may transmit a Private Call through any of the following methods.



Transmitting a call through Contacts List or Call Logs

- 1.Press Menu Key to go to Main Contacts.
- 2.Go to "Contacts List - Private Call Contacts", Or go to "Call Logs" and access the outgoing /Incoming/Missed list.
- 3.Use the Up/Down Key to select the Private Call contacts you want to call.
- 4.Use P1 Key  or PTT Key to Transmit a call.

Through manual input

- 1.Input a Private Call number you want to call in home screen .
- 2.Use P1 Key , PTT Key or select Dial Key # to transmit a Private Call.

Transmitting a call through Redial List or Recall List.

- 1.Use P1 Key  to Redial List or P2 Key  to Recall List to Input a Private Call number you want to call in home screen .
- 2.Use P1 Key , PTT Key or select Dial Key # to transmit a Private Call.



Note:

Transmitting a Private Call Failed while products unregistered or Registration Failed .

Product Functions and Operations

Receiving and Responding to a Private Call



When a Private Call is received ,your radio automatic to receive a private call and sounds “De,De”,your radio will display the icon (As shown above) .

You may press P1 key  or PTT key,coming call ring and icon will disappear. ,the first line display the coming call alias or ID. (As shown above)



Note:No need press the Receiving Key while setting automatic receiving and responding to a Private Call .

Voice Communication

After setting up a private Call ,both the calling party and called party are in PTT allowed interface ,and hold down PTT to talk.

Call Duration

After setting up a Private Call ,both the calling party and called party LCD will display call duration in time .Unit is “Minutes :Seconds”. (As shown)



- The calling party LCD .

To count up the Call Duration by count -down,the starting time of count-down time is the total lasted talking time. This time is preset time via system configuration . When the total lasted calling time expires the preset time, this radio will return back from calling and end this call.

- The called party LCD

To count up the Call duration time by occurred time ,the start time from 0.

Ending a Call

- 1.Nobody hold down PTT Key for a long time ,and this radio will end call automatically when silence period expires.
- 2.This radio will end call when the total calling time expires the preset time.
- 3.During calling, any party of calling or called hang up.
- 4.Base station signal lost.

DMR Functions and Operations

Group Call

You may transmitting a Group Call through any of the following methods. Transmitting a call to the preset contacts.

In the home screen,hold down PTT Key to transmitting a Group Call to the Group Call contacts preset for the current Channel.
(By the Group Knob to select a group you want to call).





Transmitting a Group Call to the Contacts List or Call Logs.

- 1.Press Menu Key to Main Menu
- 2.Go to “ Contracts List--Group Call Contacts ” or “ Call Logs ” to access to outgoing/Incoming /Missed Call.
- 3.Use the Up/Down Key to select the Group Call Contacts you want to call.
- 4.Use P1 Key or PTT Key  to transmitting a Group Call.

Transmitting a Group Call through manual input

- 1.Input a Group Call number you want to call
- 2.Use PTT Key, P1 Key or Dail Keypad # to transmitting a Group Call.

Transmitting a call through recall List or Call Logs

- 1.Use P1 key ,to go to Call Logs List or press P2 Key  to select Group Call number you want to call.
- 2.Use P1 key  or PTT Key  to transmitting a Group Call.

Receiving and Responding to a Group Call



When a Group Call is received,your radio will display the icon and have "De"alert tone.

Press P1  or PTT Key,the incoming call iron will disappear .

Late Access

After Group Call set up to the end,those following type radio haven't ended will join in this Group Call such as :
Radio just powering on , Radio just roams from other basestation or radio just releases from other group .

Voice Call

After seting up a call ,hold down PTT key to initiate a call when the calling party and the called party are in the PTT allowed interface.

DMR Functions and Operations

Call Duration

After setting up a Group Call ,Both the calling party LCD and the called party LCD will display Call Duration in time .
Unit is "Minutes :Seconds."(As shown)



- The calling party LCD .

To count up the Call Duration by count -down,the starting time of count-down time is the total lasted talking time .

This time is preset time via system configuration .

When the total lasted calling time expires the preset time ,this radio will return back from calling and end this call .

- The called party LCD

To count up the Call duration time by occurred time ,the start time from 0 .

To count up from the called party access to Group Call .

Recount up by count-down requires when the called party end a Group Call and access this group by "Late Access".

Ending a Call

- 1.Nobody hold down PTT Key for a long time ,and this radio will end call automatically when the time expires silence period .
- 2.This radio will end call when the total calling time expires the preset time .
- 3.During calling, the calling party hang up .
- 4.Base station signal lost.

All Call

Two types of All Call are Team All Call and Whole Network All Call.

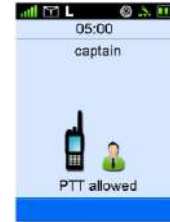

Team All Call

999 is the last one Group Call number in this team ,

When you initiate a Team All Call,all member in this team will receive and respond to this call .

Three methods are aviable for transmitting a Team All

Call :Transmitting a call to preset contacts ,transmitting a call through group call contacts or manual input number .

The specific operation is the same as the Group Call.

Whole Network All Call

When you initiate a Whole Network Call ,and all the member will join in this call ,1981,1982 are Whole Network Call number.

The three methods are available for transmitting a Whole Network Call:transmitting a call to the preset contacts , transmitting a call through Group Call Contacts or through manual input (Add * key before 1981 or 1982).

DMR Functions and Operations

Emergency Call

Emergency Call can be Emergency Private Call or Emergency Group Call .

The following two methods are available to initiate a Emergency Call.

1.Press Emergency Call Key to initiate a Emergency Call.

The called number can be set via programming software in trunking mode .

2.Through manual input number to initiate a Emergency Call.

(Add *9* before number).Use P1 key,  PPT Key or # key to initiate a call.

Broadcast Call

Broadcast Call only can be Broadcast Group Call .Only the calling party has the rights to speech. You may initiate a Broadcast Call through manual input .(Add *11* before number).

Use P1 key .PTT Key or # key to initiate a call.

Priority Call

Via programming software configuration to set Priority Call level:

Low ,Middle ,High or Preemption Call .You may initiate Priority Call through manual dail (Add *8* before number).Use P1

Key  , PTT Key or # key to initiate a call.

Dispatch Station Call

This radio can call the Dispatch Station. The number of Dispatch Station are based on configuration.

DMR Republic Network Phone Call

The calling with Public Network Phone is called Public Network Call.Network Phone Call have fixed phone call and mobile phone.

For your better use ,for example as follow.

House Fixed Telephone fixxed fixr	Dail fixed telephone number directly	Such as dial 8036 directly
External Fixed Telephone	Add 0 before telephone number	Such as00755-33010296
Making Local Mobile Telephone Call	Add 0 before telephone number	Such as013112345678
Making Nonlocal Mobile Telephone Call	Add 00 before telephone number	Such as 0013112345678

DMR-MPT Call

Base on the associated DMR-MPT group call number configured by basestation , you can achieve DMR trunking mode radio call DMR trunking mode radio each other.

DMR trunking radio transmit a DMR-MPT call

In DMR trunking mode ,you may transmit a DMR-MPT Call through any of the following methods.

- 1,Transmitting a call to the preset contacts.
- 2,Transmitting a call through Group Contacts .
- 3,Through manual input.

(Specific operation is the same as group call)

DMR Functions and Operations

Contacts List

To access to this menu, Press Menu Key to Main Menu and select "Contacts List".

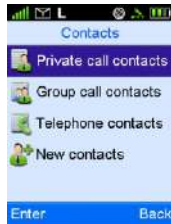

1、 Private Call Contacts

You can save up to 256 entries in the private Call Contacts list .
To access this item, select"Contacts-Private Call Contacts" or through Private Call List shortcut key for the contacts list via CPS configuration.

- a) To review ,modify or delete any one of contacts on list.
- b) If you want to delete all contacts ,select"Contacts List-Private Call Contacts-Contacts-Delete All"

2、 Group Call Contacts

You can save up to 256 entries in group Call Contacts list .
To access list through"Contacts List -Group Call Contacts".

- a)To review the details of any contacts on the list ,just like alias and ID information.

3、 Public Network Contacts

You can save up to 256 entries in the Public Network Contacts.

To access this item through "Contacts List-Public Network Contacts"

- a) To review ,modify or delete any one of contacts on list.
- b) If you want to delete all Contacts ,select"Contacts List-Private Call Contacts-Contacts-Delete All"

4、 New Contacts

You can add a Private Call Contacts and Public Network Contacts to Contacts List .

The New Private Call Contacts will save to Private Call Contacts List automatically .

The New Public Network Contacts will save to Public Network Contact List automatically .

- a)The New Private Contact number must be unique.
- b)The alias of each Private Call Contacts save up to 16 characters,the available number is 8 figure [NumberID must conform to the rules of dial-up].
- c)The alias of each Public Network Contacts save up to 16 characters, the available numbeic is 18 figures [NumberID must conform to the rules of dial-up].



Note: You can switch input method through # key when input contacts alias.

DMR Functions and Operations

Message

To access this item,press Menu key to go to main menu to select"message".



1、Inbox

The Inbox can save up to 100 received messages. When the Inbox save up to 90 received messages ,and go on receiving messages ,radio will appear notes "Inbox will be full, please delete message"and the earliest message will be overwritten by the latest one automatically.

2、Outbox

The Outbox can save up 100 sent messages.

Each message will appear appropriate Iron to note message send successfully or not .

- a) When the message sent successfully,the icon"√"will appear.
- b) When the message sent unsuccessful,the icon"!" will appear and please send again.

When the OutBox is full,the earliest message will be overwritten by the latest one automatically.

3、Drafts

The Drafts can save up to 10 drafts messages into Drafts. When the Drafts is full, the earliest message will be overwritten by the latest one automatically.

4、New Message

You can create new text message(179 characters at most) and send it to an individual user or to a talk group.

5、Preset message

Under this option there are some text messages (10 entries at most)preset by your dealer.You can choose and send any entry.

6、Status Msg

There are some text message(95 entries at most) preset by your dealer in this menu.

You can select and send directly .

The status Msg is status code.

DMR Functions and Operations

Call Logs

Press Menu Key to access Main Menu and then select "Call Logs". This radio can save up to 200 call entries. When the entries list is full, the earliest entry will be overwritten by the latest one automatically. To view, delete, or delete all after selecting one call entry.

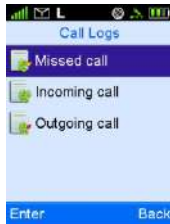

Redial List and Callback List

Use P1 Key and P2 Key to access "Redial List" and "Callback List".

This radio can save up to 10 call entries. When the entries list is full, the earliest entry will be overwritten by the latest one.

Redial List

All outgoing call list will be saved in the Redial List. To access this item, use P1 key in the home screen (As shown).

Use P1 Key or PTT Key to select the outgoing entries to initiate a call, delete it or delete all.



Callback List

The Callback List will save up all the incoming entries. To access this item, use P2 key in the home screen (As shown).

Use P2 key or PTT key to initiate a call, delete it or delete all.



DMR Functions and Operations

Vehicle Inquiry

To access this item ,press Menu Key to access Main Menu to select "Public security --Vehicle information " .



You can input the vehicle license number and sent it to dataspace when you want to inquiry it .You also can review it from the history record.

ID Inquiry



You can input ID number to the ID editing interface and send it to dataspace when you want to inquiry it .You also can review it from the history record.

Status Filing

Press Menu Key to access Main Menu to select "Applications—Status Filing".



When the feature is enabled,the control center or other radio holder will master your working status etc. [Such as : on the job ,off the job or just leave the job].

You may process this function quickly through Shortcut Key Setting Menu.

Filing Address Setting: You may send your status to your assigned receiver through Filing Address Setting .

MPT Trunking Functions and Operations

To ensure an optimal volume of the receiving radio, hold the radio approximately 2.5 to 5 centimeters away from your mouth .

Private Call

Transmitting a Private Call

You may transmit a Private Call through the following methods. When transmitting a Private Call ,this radio will set up calling automatically .



Transmitting a call through Contacts and Call Logs

1. Press Menu Key to go to Main Menu
2. Go to "Contacts List - Private Call Contacts List", Or go to "Call Logs" and access the outgoing /Incoming/Missed list.
3. Use the Up/Down Key to select the Private Call Contacts you want to call.
4. Use P1 Key  or PTT Key to transmit a call

Through Manual Input

1. Input a Private Call number you want to call in home screen.
2. Use P1 Key , PTT Key or select dial Key # to transmit a Private Call.

Transmitting a Private Call through Redial List or Recall List.

1. Press P1 Key  to Redial List or P2 Key  to Recall List to Input a Private Call number you want to call in home screen.
2. Use P1 Key  or PTT Key to transmit a Private Call.



Note:

Transmitting a Private Call failed while products unregistered or registration failed .

Receiving and Responding to a Private Call

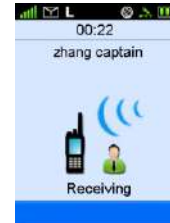

When a Private Call is received ,your radio automatic to transmit a Private Call and sounds "De,De",your radio will display the icon. (As shown above).

You may press P1 key  or PTT key,coming call Ring and icon will disappear.

The first line display the coming call alias or ID (As shown above).

Voice Communication

After setting up a Private Call , both the calling party and called party are in PTT allowed interface ,and hold down PTT Key to talk.

MPT Trunking Function and Operations

Call Duration

After setting up a private call, Both the calling party LCD and called party LCD will display Call Duration in time.

Unit is "Minutes :Seconds"(As shown).



When a Private Call is received, your radio automatic to receive a private call and sounds "De,De",your radio will display the icon (As shown above).

You may hold down P1 key or PTT key,coming call ring and icon are disappeared.The first line display the coming call alias or ID.(As shown above)

Note:No need hold down the Receiving Key while setting automatic receiving and responding to a Private Call.

Ending Call

- 1.Nobody hold down PTT Key for a long time, and this radio will end call automatically when silence period expires.
- 2.This radio will end call when the total calling time expires the preset time.
- 3.During calling, any party of calling or called hang up.
- 4.Base station signal lost.

Group Call

You may transmit a Group Call through any of the following methods.

Transmit a call to the preset contacts.

Hold down PTT Key to transmit a Group Call to a Group Call contacts preset for the current channel in home screen. (By the Group Knob to select a group you want to call)

Transmitting a Group Call to "Contracts List--Contacts"

- 1.Press Menu Key to Main Menu
- 2.Go to"Contracts List--Contacts"
- 3.Use the Up/Down Key to select the Group Call contacts you want to call.
- 4.Use P1 Key or PTT Key to transmit a group call.

Transmitting a Group Call through manual input

- 1.Input a group call number you want to call in the home screen.
- 2.Press PTT Key,P1 Key or Dial Keypad # to transmit a group call

Transmitting a call through Redial List or Call Backlist

- 1.Use P1 key to go to Call Logs List or press P2 Key to select Group Call number you want to call.
- 2.Use P1 key or PTT Key to transmit a group call.

MPT Trunking Function and Operations

Receiving and Responding to a Group Call



When a Group Call is received ,your radio set up call automatically and sounds “De”,your radio will display the icon . (As shown above) The first line display the coming call alias or ID.

Late Access

After set up group call,this radio allows the member haven't joined in this group transmit this call during calling .

Voice Communication

After set up a Group Call ,Both the calling party and the called party are in the PTT allowing interface. You can hold down PTT key to transmit a call.

Call Duration

After setting up a Group Call ,Both the calling party LCD and the called party LCD will display Call Duration in time . Unit is “Minutes :Seconds.”(As shown)



- The calling party LCD .

To count up the Call Duration by count -down,the starting time of count-down time is the total lasted talking time. This time is preset time via system configuration . When the total lasted calling time expires the preset time , this radio will return back from calling and end this call.

- The called party LCD

To count up the Call duration time by occurred time ,the start time from 0.

To count up from the called party access to Group Call . Recount up by count-down requires when the called party end Group Call and access this group through“Late Access”

MPT Trunking Functions and Operations

Ending a Call

1. Nobody hold down PTT Key for a long time ,and this radio will end call automatically when the silence period expires.
2. This radio will end call when the total calling time expires the preset time.
3. During calling, the calling party hang up.
4. Base station signal lost.

All Call

Two types of All Call are Team All Call and Whole Network All Call.

Team All Call

999 is the last one Group Call number in this team ,When you initiate a team All Call, all member in this team will receive and respond to this call .

Three methods are available for transmitting a Team All Call :
Transmitting a call to preset contacts ,transmitting a call through group call contacts or through manual input number .
The specific operation is the same as the Group Call.

System All Call

When you transmit a System All Call ,all user in this system will join in this call.

1981 is the number of System All Call.

Three methods are available for transmitting a System All Call :
Transmitting a call to preset contacts ,transmitting a call through group call contacts or through manual input number .
(Add * Key before 1981).

Emergency Call

Emergency Call can be Emergency Private Call or Emergency Group Call .

The following two methods are available to initiate a Emergency Call.

1. Press Emergency Call Key to initiate a Emergency Call.
The called number can be set via programming software in trunking mode .

2. Through manual input number to initiate a Emergency Call.
(Add *9* before number).

Use P1 key , PPT Key or # key to initiate a call.

Broadcast Call

Broadcast Call only can be Broadcast Group Call .

Only the calling party has the rights of speech.

You may initiate Broadcast Call through manual input .
(Add *11* before number).

Use P1 key , PTT Key or # key to initiate a call.

Priority Call

Via programming software configuration to set a Priority Call level: Low ,Middle ,High or Preempted Call .

You may initiate Priority Call through manual dial
(Add *8* before number).

Use P1 Key , PTT Key or # key to initiate a call.

Dispatch Station Call

This radio can call the Dispatch Station. The number of Dispatch Station are based on configuration.

MPT Trunking Functions and Operations

MPT Public Network Calling

The calling with Public network phone is called MPT public network Call.

For your better use ,for example as follow.

House Fixed Telephone fixxed fixr	Dail fixed telephone number directly	Such as dial 8036 directly
External Fixed Telephone	Add 0 before telephone number	Such as 00755-33010296
Making Local Mobile Telephone Call	Add 0 before telephone number	Such as 013112345678
Making Nonlocal Mobile Telephone Call	Add 00 before telephone number	Such as 0013112345678

MPT-DMR Call

Base on the appropriate MPT-DMR group call number figured by basestation ,you can achieve MPT trunking radio call DMR trunking mode radio each other.

MPT trunking radio transmit a MPT-DMR call

In MPT trunking mode ,you may transmit a MPT-DMR Call through any of the following methods.

- 1,Transmitting a call to the preset contacts.
- 2,Transmitting a call through Group Contacts .
- 3,Through manual input.(Specific operation is the same as group call)



Note: In DMR Trunking mode ,your radio must wait to the corresponding group.
(No need wait in this group when the DMR corresponding group is the responding group).

DMR trucking mode radio initiate a call to DMR-MPT is the same as the above operations.

Receiving and Responding to a Call

In DMR trunking mode ,When a group call /private call is received , your radio set up calling automatically and a alert ton“De” sounds.

The group alias or ID number will display on the first line of screen and private calling group name or private ID number will display on the last line. .

Late Access

After setting up group call,this radio allows the member haven't joined in this group transmit this call during calling .

Call Logs

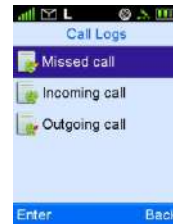



This radio can save up to 200 call entries.When the entries list is full,the earliest entry will be over written by latest one automatically.



To view, delete, or delete all after selecting one call entries .

MPT Trunking Functions and Operations

Redial List and Callback List



Use P1  P2 key  to access "Redial List "and"Callback List".
This radio can save up to 10 call entries .When the entries list is full,the earliest entry will be overwritten by latest one.

Redial List

All outgoing call list will be save in the Redial List .
Use P1 key  to access this item in home screen.
(As shown) Use P1 Key  or PTT Key to select the outgoing entries to initiate a call,delete it or delete all .



Callback List

The Callback List will save up all the incoming entries
To access this item ,Use P2 key  in the home screen
(As shown).
Use P2 key  or PTT key to initiate a call ,delete it or delete all.



Digital Conventional Functions and Operations

Private Call, Group Call and all Call

Transmitting a Private Call

You may transmit a Private Call through any of the following methods.

Transmitting a call through Contacts List or Call Logs.

1. Go to "Contacts List-Contacts ", Or go to "Call Logs" and access to the Outgoing/Incoming/Missed list.
2. Use Up /Down Key to select a Private Call Contacts you want to call.
3. Hold down PTT Key to transmit a Private Call through manual input

1. Go to " Contacts-Manual Dial"

2. Input a Private Call number you want to call.
3. Hold down the PTT key to transmit a Private Call.

Transmitting a Group Call

You may transmit a Group Call through any of the following methods.

Transmitting a Call through Contacts List or "Call Log.

1. Go to "Contacts List—Contacts " or through "CallLog" to go to Outgoing/Incoming /Missed Call.
2. Use the Up/Down Key to select a Group Call contacts you want to call.
3. Hold down PTT key to select a Group Call Contacts you want to call.

Transmitting an All Call

You may transmit a private and an All Call through any of the following methods.

Transmitting an All Call through Contacts List or "Call Log.

1. Go to "Contact List—Contacts" or through "Call Log" to go to Outgoing/Incoming /Missed Call list.
2. Use the Up/Down Key to select an All Call contacts you want to call.
3. Hold down PTT key to Transmit an All Call.



Note: All call ID is a fixed ID.

Emergency Call

Meet an emergency, you can use this function to search companion or control center for help.

If you need in a certain channel enabled on emergency call function, you must configure via programming software. This channel is relevant to one call ,only press "TK" key for long time to transmit a emergency call .

Digital Conventional Functions and Operations

Message

To access the Menu,press Menu key to go to Main Menu to select"message".



1、Inbox

This radio can save the received messages into Inbox.

The Inbox can save up to 100 received messages.

When the Inbox save up to 90 received messages ,and go on receiving messages, this radio will appear notes"Inbox will be full, please delete message"and the earliest message will be over written by the latest one automatically.

2、Outbox

This radio can save the sent messages into Outbox.

Each message will appear appropriate Iron to note message send successfully or not .

a、 When the message sent successfully, the icon"√"will appear.

b、 When the message sent unsuccessful, the icon"! " will appear and please send again.

The OutBox can save up to 100 sent messages.

When the OutBox is full,the earliest message will be overwritten by the latest one automatically.

3、Drafts

This radio can save up the edited message into Drafts.

The Drafts can save up to 10 draft message.When the Drafts is full, the earliest message will be over written by the latest one automatically.

4、New Message

You can create new text message(179 characters at most) and send it to an individual user or to a talk group.

5、Preset Message

Under this option there are some text messages(10 entries at most)preset by your dealer.You can choose and send any entry.

6、Status Msg

Under this option there are some text message(95 entries at most) preset by your dealer.You can choose and send any entry .The status Msg is status code.

Digital Conventional Functions and Operations

Call Logs

To access this menu, press Menu key to Main Menu and select "Call Logs", or press the shortcut key for Call Logs directly.

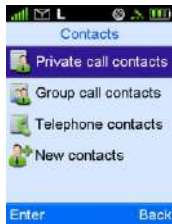

This radio can save up to 200 call entries. When the entries list is full, the earliest entry will be overwritten by latest one automatically.

After accessing a list and selecting an entry, you can perform any of these operations: hold down the PTT key to initiate a call, add it to Contact List, or delete it.

To delete all entries in the Outgoing /Incoming/Missed list at a time, select Call Logs-Outgoing /Incoming/Missed-Delete All.

Zone

Zone is a channel group, you can list the same channel in a zone.

This function will help you manage the current channel.

This radio supports up to 16 zones.

Each zone up to 32 channels.

You can select your desired zone as following methods.

1. You can use this menu to select your desired zone. To access "Zone", Press Up/Down key to select the Zone, then press OK Key to switch to the desired zone.
2. You can use the programming Key to select your desired zone.

If you preset Zone Up /Zone Down shortcut key, press this key to switch to desired zone.

Analog Conventional Functions and Operations

Squelch Level

You can select the squelch Level by menu from Strengthen , Normal and Always On .

Or press Squelch level Switching programmable Key to switch the level.

This radio default at Norma generally.Strengthen requires the receipt signal high enough to turn on the speaker .

When the level set at Normal (Squelch level is 0) this radio will turn on the speaker directly automatically and sounds the background voice .

Optional Accessories

The following items are the main optional accessories for the product. Consult your local dealer for more other accessories.



3400 mAh Battery
EB342L



Programming Cable
EPC01



Wireless PTT
EPTTB01



Bluetooth Headset
EEWB03E



Speaker Microphone
(Shoulder)
EMRN011



C-Shell Earset
EEHN011



Police Full Bone
Conduction Headset
EEBN011



Fireman Full Bone
Conduction Headset
EEBN021



1-Wire Earpiece with
Transparent Acoustic Tube
EEAN011



2-Wire Earpiece with
Transparent Acoustic Tube
EEAN021



Multi-unit Charger
EMC702L



Caution: Use the accessories specified by the Company only. Otherwise, the Company shall not be liable for losses or damages arising out of use of unauthorized accessories.

Troubleshooting

Phenomena	Analysis	Solution
The Radio Can not be powered on.	The battery may be improperly installed	Remove the battey and attach it again.
	The battery may run out	Recharge or replace the battery
	The battery may suffer from poor contact caused by dirtied or damaged battery contacts	Clean the battery contacts, if the problem can not be solved, contact your dealer or authorized service center for inspection and repair.
The Radio can not be registered.	The radio can not detect the basestaion signal.	Make sure the radio in base station effective signal range.
	The radio is not the basestation legal user ,can not be registered.	Contact person who are in charge of this base station,make sure the radio are the legal user of base station NMS
Repeated registration	During receiving signal is discontinuous.	Make sure the radio in base station effective signal range.
The Radio Can not transmit and respond call.	During receiving signal is weak.	Make sure the radio in base station effective signal range.
No voice when transmitting and responding call.	The radio ID may be repeated	Contact person who are in charge of this base station, make sure no the radio ID are repeated of base station NMS.
The responding party is inactive repeaty during calling.	Signalis discontinuous,get access to transmitting again after signal is totally inactive.	Make sure the radio in basestaion effective signalrange.
During receiving signals, the voice is weak discontinuous or totally inactive.	The battery strength may be too low.	Recharge or replace the battery.
	The volume may be set to a low level.	Increase the volume by Volume Control Knob.
	The antenna may be get loose or may be improperly installed.	Power off the radio ,and re-install the antenna.
	The speaker may be blocked or damaged	Clean surface of the speaker.If the problem can not be solved,contact your dealer or authorized service center for inspection and repair.
You can not communicate with other members	The poor quality of communication signals	Make sure all member in the effective communication range.
Irrelevant communication or noise is heard on the channel	The poor quality of communication signals	Make sure all member in the effective communication range.
The noise is too loud.	The poor quality of communication signals	Make sure all member in the effective communication range.
	You may suffer from external disturbance (such as electromagnetic interference).	Move to an open and flat area,and restart the radio.
	You may be at an unfavorable position.For example,your communication may be blocked by high buildings or frustrated in the underground areas.	Stay away from equipment that may cause interference.

If the above solutions can not fix your problems,or you may have some other queries,please contact us or your local dealer for more technical support.

Warranty and Maintains

Scope of Warranty

Ep8100 radio and accessories.

Warranty Details

1.From the date of purchase and without any artificial damage, Warranty varies based on product types .

We will provide 36 months warranty service for main radios and 12 months warranty service for battery ,charger ,adapter and other standard accessories etc.

2.Completes Warranty Card or provides valid original invoices or receipts for warranty judgment .This invoice or receipt shall indicate radio accessories, radio serial number ,purchase date and amount.

3.Products problem caused by non-artificial can return, exchange or repair within 7 days. 15 days can be a replacement or repair, more than 15 days and within the warranty can be free repair.

4.We provide life-long maintenance service for customer .For products beyond the warranty, we still can continue to provide repair and maintenance services and will charge for those service.

Non-Warranty Service

1.Defect or damage is due to improper use of the product, including but not limited to the defects and damage caused by using this product without complying with the warning or user manual.

2.Defect or damage due to remake, change and disassembly or make use of non-original accessory or battery without the authorization of Simoco.

3.Defect or damage is due to force majeure (earthquake, flood disaster, fire disaster, etc.)

4.Cannot produce valid warranty certifications (Warranty Card, Invoice or Receipt etc.)

5.By the rational judgment of Simoco, serial number code label, the accessory date code label or relevant Simoco a sign of a product has been removed, defaced or altered.

6.Fair wear and tear.

7.Battery in the following circumstances:

1)Any artificial damage or unsealed phenomenon of battery case seal.

2)Defect or damage due to the charging or using at variance with the products prescribed.

Disclaimer



The company endeavors to achieve the accuracy and completeness of this manual, but no warranty of accuracy or reliability is given. All the specifications and designs are subject to change without notice due to continuous technology development. No part of this manual may be copied, modified, translated, or distributed in any manner without the express written permission of us.

Warranty Card

Purchase Information

Customer Name: _____

Customer Phone: _____

Customer Address: _____

Purchase Date: _____

Radio Information

Model Number: _____

Serial Number: _____



Note:

- This warranty card applies to after-sale and maintenance services for the product and accessories described above.
- You must provide this warranty card and purchase invoice in order to get warranty services.
- The Company does not assume liability for damages caused by human factors. For more details, contact your local dealer.

Please tear from the Dotted line