

blue*m*

**Bluetooth Enabler for Palm m500 and m505**

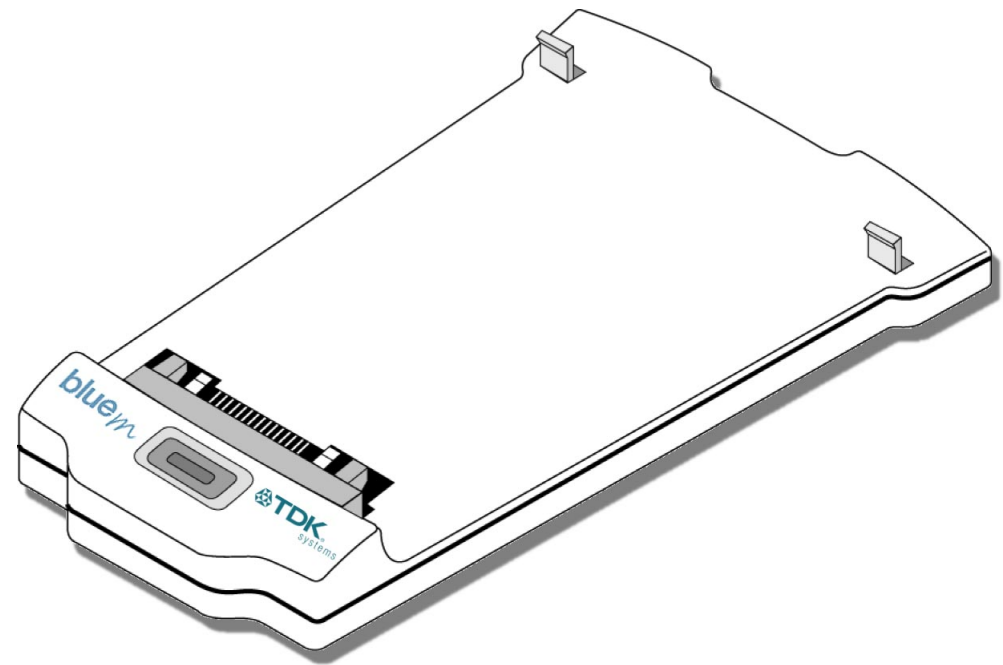

# Contents

## Introduction

Box contents .....	2
--------------------	---

## Getting Started

Attaching the blueM .....	3
Removing the blueM .....	4
Installing the blueM Software .....	5

## Using blueM

Controlling Bluetooth with Preferences .....	6
Connecting with other devices .....	7
Discovering other devices .....	7
Being discovered by other devices .....	9
Pairing two Palm/blueM devices .....	9
Viewing device properties .....	9
Removing Bluetooth devices from the list .....	9
Network (Internet) settings .....	10
HotSync over Bluetooth (BlueSync™) .....	11
Bluetooth Profiles .....	12
The blueM button .....	13
The blue indicator .....	13
Menu Items .....	14
Settings .....	14

## Troubleshooting and Information

Pairing and Guides .....	15
Troubleshooting and Technical Information .....	23
Regulatory Information and Safety Statements .....	24
Glossary .....	25
Warranty .....	26

# Introduction

When you need to share Palm files with another computer, what is required? When you want to browse the Internet from your Palm using a mobile phone, what do you do? The answer is usually to connect them together using cables. As more connections become necessary between mobile devices, so too does the number of cables required to make it all possible.

Bluetooth™ provides a way for devices to communicate without the need for cables or connectors. Using low power radio waves and a standard vocabulary, any device with Bluetooth wireless technology is able to make a connection with any other Bluetooth device to share information and resources.

The TDK blueM is a sleek device that connects to the back of your Palm m125, m500, m505 or IBM WorkPad c500 series and provides a range of Bluetooth capabilities. blueM uses small amounts of power from your Palm battery and adds only 29g to the overall weight. Once the supplied software is loaded into your Palm, you are ready to connect with an ever-increasing range of smart, wireless devices.

## Box contents

Your blueM package should contain the following items:

- blueM device
- Installation CD-ROM
- Instruction Guide

## Next steps

- [Attach the blueM](#)
- [Install the Software](#)
- [Use Palm Preferences](#)
- [Connect with other Bluetooth devices](#)
- [Make network settings for Internet access](#)
- [Reprogram the blueM button](#)

# Getting Started

## Attaching the blueM

*Note: You must remove any other peripheral devices connected to your Palm handheld before attaching the blueM.*

- 1 With the Palm switched off, line up the black connector on the blueM with the socket at the base of your Palm.

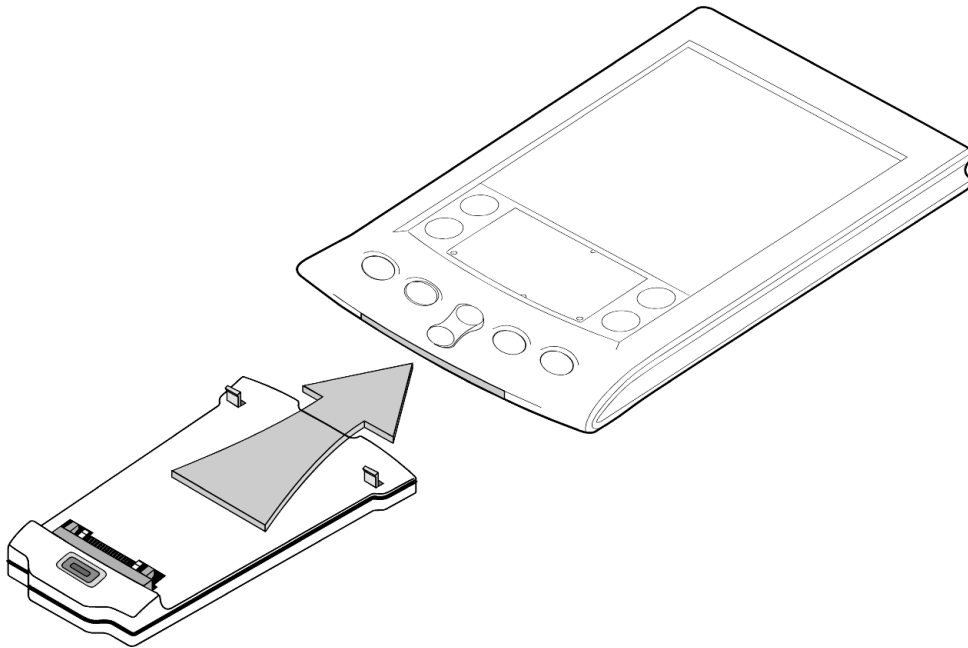

- 2 Slide the blueM onto your Palm until the connector fully mates with the socket and you feel it clipping into place.

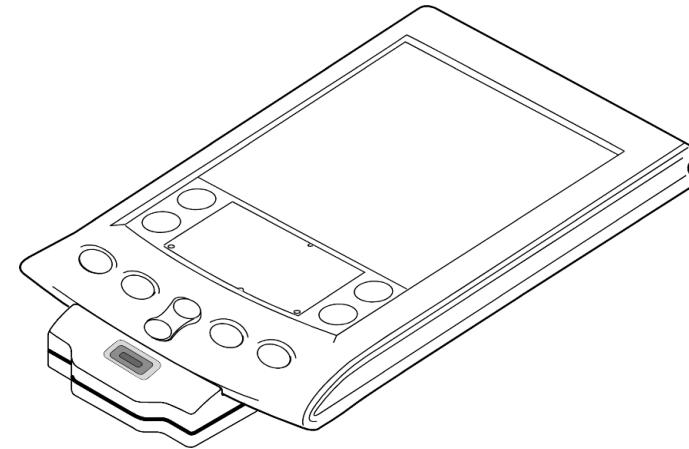

### Next steps

- [Install the Software](#)
- [Use Palm Preferences](#)

## Removing the blueM

1 With the Palm switched off, gently lift the blueM away, roughly half a centimetre, from the back of the Palm.

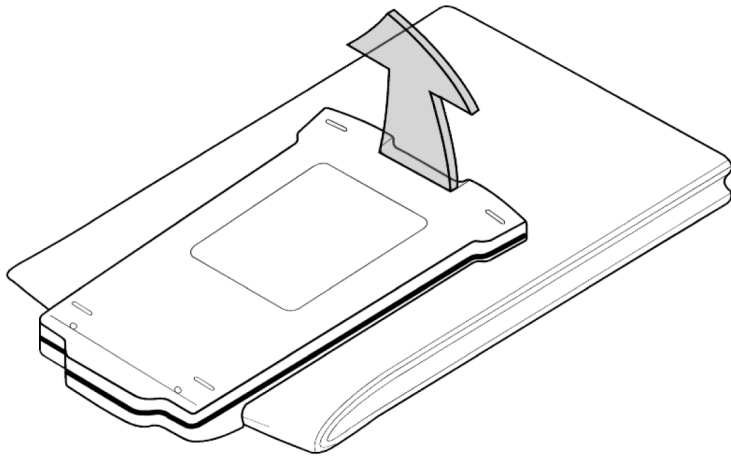

2 Slide the blueM towards the base of the Palm until it fully disengages.

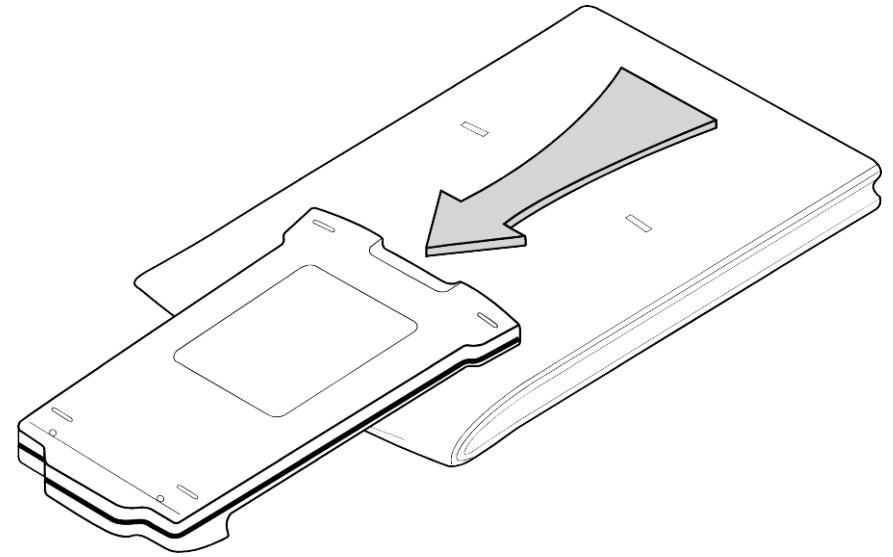

## Installing the blueM Software

- 1 Place the Palm into the HotSync cradle as usual.
- 2 Insert the installation CD-ROM into the CD drive of your PC. The CD should automatically start and (if it does not start automatically: click the Windows *Start* button, click *Run* then click *Browse*, locate the CD-ROM drive and choose the file *setup.exe*.)
- 3 Follow the on screen instructions given in order to transfer the required applications from the CD-ROM, through the PC and onto the Palm.
- 4 Once the application transfer is complete, you can remove your Palm from the cradle and (if not already done) attach the blueM device.

### Next steps

- [Use Palm Preferences](#)
- [Connect with other Bluetooth devices](#)
- [Make network settings for Internet access](#)
- [Reprogram the blueM button](#)

# Using blueM

Once the blueM software is installed on your Palm, you are ready to begin making connections to other Bluetooth equipped devices.

There are two main stages in getting Bluetooth devices to work together:

- Firstly, one device must *discover* the other, and
- Secondly, the devices then swap security passkeys in order to become *paired*.

Once paired, the two devices can request and supply information or services as required. For each set of devices, the pairing process need only be carried out once and from that moment they can call directly to each other as necessary (providing they are within range, i.e. within ten metres).

The discovery and pairing characteristics of your Palm (and blueM) are controlled from the standard Palm *Preferences* application.

## The reason for discovery and pairing

From its initial conception, the Bluetooth standard has been designed with security in mind. Obviously, when your Palm can theoretically be accessed by any other Bluetooth device, you need to be sure that you are in control of how, and by whom it is being accessed. For this reason, the process of getting most Bluetooth devices to work together is divided into two distinct stages - *Discovery* and *Pairing*.





To understand the process, imagine a group of people in a dark room. Person A wants to find someone to talk to among all the others. So person A calls out if anyone is there (*discover*). Person B does not want to be discovered so they don't reply (*non-discoverable*). However, person C does want to be known (*discoverable*) and shouts out their name, possibly along with many others. Person A then chooses person C from a number of responses and asks them directly for more details. Person C then asks for a secret password (*passkey*) before the conversation gets any deeper. Providing the right number or word is given, they form an instant trusting relationship (*pairing*) and from that moment on, whenever they need to share information, they simply call each other by name.

## Controlling Bluetooth with Preferences

On your Palm, the central point for controlling basic Bluetooth operation is within the Palm Preferences application. During the software installation a new Bluetooth page was added to Preferences and from this new page, you can:

- Begin a search to [discover](#) new devices,
- Set your Palm to [be discovered](#),
- [View or delete](#) existing paired devices, and
- Alter various [settings](#).

### To display the Bluetooth Preferences page:

- 1 Tap  to locate the  icon.
- 2 Tap the  icon.
- 3 If the Bluetooth Devices screen is not already showing, tap the  in the top right corner and select *Bluetooth* from the drop down list ⇔
- 4 Using this screen you can now control the basic Bluetooth capabilities of your Palm and blueM combination as covered

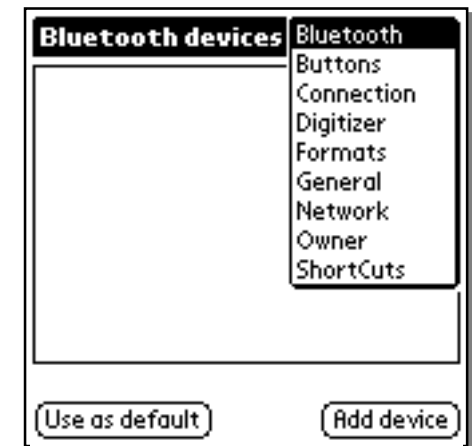

### Next steps

- [Connect with other Bluetooth devices](#)
- [Make network settings for Internet access](#)

## Connecting with other devices

The first stage of interaction between Bluetooth devices requires one of them to search for and discover other such devices. It is generally unimportant which device does the discovering and which is discovered, as once their relationship (pairing) is confirmed, they can both request or supply resources as necessary. In some cases, however, devices with limited capability may require special treatment (i.e. wireless headsets, certain mobile phones, etc.) as they have little or no user interface. Refer to the user documentation for these devices for further details.

### Next steps

- Discovering other devices ⇒
- [Being discovered by other devices](#)
- [Pairing two Palm/blueM devices](#)
- [Removing Bluetooth devices from the list](#)

### Discovering other devices

Follow this procedure to make your Palm/blueM perform a search for other Bluetooth devices in the vicinity:

- 1 Display the Bluetooth page of [Preferences](#).
- 2 Tap the *Add Device* button in the lower right corner. This screen will be displayed ⇒
- 3 You are offered two options:
  - **Require passkey** – you are strongly recommended to keep this option enabled unless you are attempting to link with a device that does not require or use passkeys. This will ensure that other Bluetooth devices that may be in the vicinity cannot gain unauthorised access to your Palm.
  - **Search for** – this option allows you to narrow down the choices in situations where many different Bluetooth devices are in the vicinity.
- 4 Ensure that the other Bluetooth device(s) is/are in discoverable



*continued* ⇒



mode ([help for specific devices](#)) and tap the Search button. Your Palm/blueM will begin searching and after a short while will either: present a list of *Found devices*, or indicate that *No devices could be found*.

*Note: Occasionally, rather than receiving a device name such as 'MY PHONE', you may receive a string of characters, such as '0001EC4ADEA8'. This is the Bluetooth address for the device and is sometimes sent at this stage if the other device didn't have time to respond with it's user-friendly name. You could either check that this is the address of the required device, or tap Cancel and then Add Device to start the search again.*

5 If the *Found devices* list contains more than one Bluetooth device, tap the required device name to select it and tap *OK*. If there is only one device listed, tap *OK* directly.

6 You will be requested to enter a passkey at this point (unless you deselected the Require passkey option). Tap the dotted line in the passkey dialog and then enter a passkey, up to sixteen characters in length, suitable for use with the selected device and tap the *OK* button. The other device should respond at this point and request for an identical passkey to be entered.

*Note: If you are connecting with a mobile phone or another such numerically-centered device then the passkey must be numeric. For alphanumeric devices such as computers, the passkey can be of a mixed nature. The important point is that it is the same on both devices otherwise the link will be refused.*



7 Your Palm/blueM will now interrogate the selected device and display a *Device Info* screen ⇨

8 If the device offers more than one service, tap the required service to select it and then tap *OK*. For more information about [services](#).

9 The two devices are now paired. The other device will be added to your Palm's Bluetooth devices list with a padlock icon to indicate that it is paired.

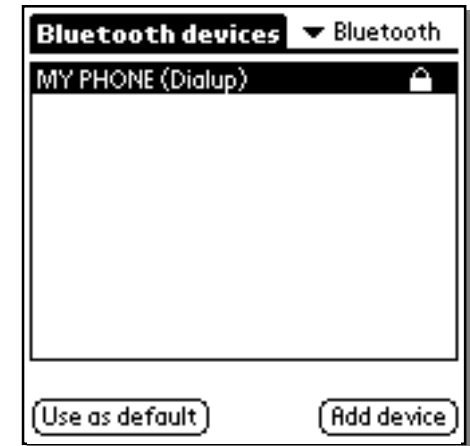

### Next steps

- [Make network settings for Internet access](#)
- [HotSync to your PC using Bluetooth](#)
- [Reprogram the blueM button](#)

## Being discovered by other devices

Follow this procedure to make your Palm/blueM discoverable by one or more Bluetooth devices in the vicinity:

- 1 Display the Bluetooth page of [Preferences](#).
- 2 Tap the  button, then tap *Incoming* and finally tap *Discoverable mode* ⇒

A dialog will be displayed with the option:

*Require passkey* – You are strongly recommended to keep this option enabled unless you are attempting to link with a device that does not require or use passkeys. Tap *OK* when you are ready to proceed. Your Palm/blueM will now wait for a limited time in discoverable mode until contacted by another Bluetooth device.

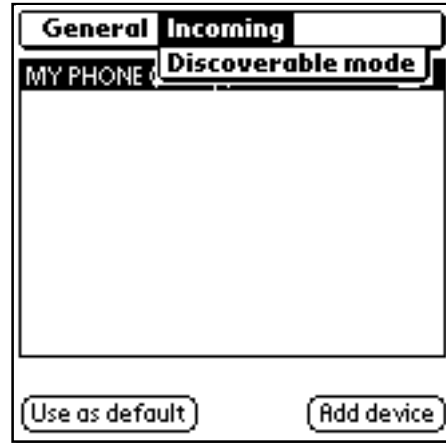

- 3 Place the other Bluetooth device into Discover mode – ([help for specific devices](#)) Typically its procedure will require you to enter a passkey and once done, that will induce your Palm to request a matching passkey.
- 4 When you are requested for a passkey, tap the dotted line in the passkey dialog and enter a passkey that exactly matches the one entered into the other device and tap the *OK* button.
- 5 The devices should now be paired and added to each other's device lists.

## Pairing two Palm/blueM devices

Decide which Palm will discover and which will be discovered. Then:

- Use the [Discovering other devices](#) procedure for one, and
- The [Being discovered by other devices](#) procedure for the other.

## Viewing device properties

To view the name and Bluetooth address of a discovered device:

- 1 Display the Bluetooth page of [Preferences](#).
- 2 Select the appropriate device from the list
- 3 Tap the  button and then tap *Properties*.

## Removing Bluetooth devices from the list

To delete a Bluetooth device:

- 1 Display the Bluetooth page of [Preferences](#).
- 2 Select the appropriate device from the list
- 3 Tap the  button and then tap *Delete*.



## Next steps

- [Make network settings for Internet access](#)
- [HotSync to your PC using Bluetooth](#)
- [Reprogram the blueM button](#)

## Network (Internet) settings

If you intend to connect to the Internet using your Bluetooth link then you need to enter some details first. This can be done either before or after you have paired with an appropriate Bluetooth device. You can get the required information from sources such as your Internet service provider or company IT department.

### To enter network details:

- 1 Display the **Preferences** application.
- 2 Select the Network page (tap the  in the top right corner and select *Network*) ⇨
- 3 Tap the  button and then tap *New* to create a fresh network details page.

- **Service:** - Enter a name to identify this set of network details – this can be anything.
- **Username:** - Enter the name by which you are known on the network.
- **Password:** - If you have been issued with a password for network access, enter it here.
- **Connection:** - Select the appropriate Bluetooth profile for your network connection:
  - For an Internet connection via a mobile phone, choose *Bluetooth (Dialup)*.
- **Phone:** - Enter the access phone number provided by your Internet Service Provider.

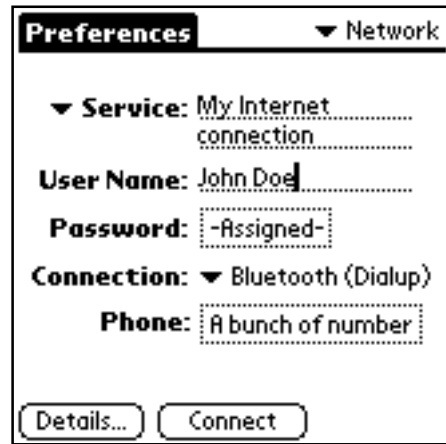

The screenshot shows the 'Preferences' application with the 'Network' section selected. The settings are as follows:

- Service:** My Internet connection
- User Name:** John Doe
- Password:** -Assigned-
- Connection:** Bluetooth (Dialup)
- Phone:** A bunch of number

At the bottom, there are two buttons: 'Details...' and 'Connect'.

In most cases this will be all you need to enter and you can tap the *Connect* button to initiate a connection (providing the other Bluetooth device is paired with your Palm and in the vicinity).

*Note: Network settings entered here are not tied to one particular Bluetooth device and could be used with various devices that support the necessary connection protocols. For example, a network configuration that you create for use with one Bluetooth mobile phone can be used with other Bluetooth mobile phones.*

### Other settings

The Details button provides further settings to accommodate a range of network connections:

- **Connection type:** PPP (default), SLIP, CSLIP. Internet connection protocols – leave as PPP unless directed to select an alternative.
- **Idle timeout:** Indicates how long to maintain the connection after a network application closes, which allows you to switch between applications without dropping the line. The Power Off setting ends the connection whenever your Palm switches off.
- **Query DNS:** Allows you to specify primary and secondary Domain Name Servers to use rather than accepting ones specified by your ISP.
- **IP Address:** Allows you to specify a fixed IP Address issued by your ISP rather than using a dynamically assigned one.
- **Script...** Allows you to create a login script that will be issued each time you make the network connection.

## HotSync over Bluetooth (BlueSync™)

To BlueSync™ your blueM to your PC, you need to follow the following setup procedure on your PC and your Palm.

*Note: This section assumes that you have successfully paired your Palm/blueM with your PC.*

### On your PC: (Using TDK USB & PC Card Bluetooth Solutions)

*Note: If you are using an alternative Bluetooth Connectivity Solution, please refer to its user manual about Pairing devices and enabling Serial Port Services for third party devices - then go straight to step 3.*

- 1 From the *Bluetooth Neighborhood*, double click *Local Device*.
- 2 Right-click Bluetooth Serial Port and select Properties. Make a note of the COM Port number (for example COM5).
- 3 Locate the *HotSync Manager* icon  on the taskbar of your Windows desktop (usually in the lower right hand corner of the screen).
- 4 Right-click on the icon and choose *Setup*.
- 5 Select *Local* and change the *Serial Port* setting to match the Bluetooth enabled COM Port number
- 6 Click *OK* to accept the change.

### On your Palm:

- 1 Launch the *HotSync* application (tap the  button and locate *HotSync*).
- 2 Ensure the *Local* option is selected.
- 3 Select the Bluetooth (Serial) option. Your Palm should now be ready to perform a BlueSync™ session – tap the HotSync logo to commence.

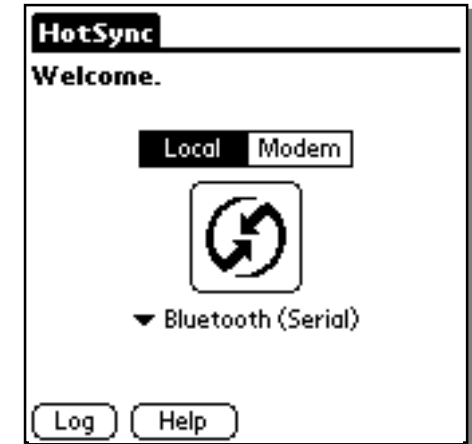

## Bluetooth Profiles

One of the key Bluetooth design goals is to offer a direct replacement for cables between electronic devices. In order to make the transition as easy as possible for existing devices and software that were never designed to use a wireless radio link (legacy devices), Bluetooth emulates various types of physical links, such as a serial cable, etc. These are called *Profiles*.

When your Palm/blueM discovers and pairs with another Bluetooth device, you will be presented with a list of profiles supported by that device. The most likely choices that will be offered are as follows:



- **Serial** – One of the most basic yet most used profiles, this mode emulates a simple RS232 serial cable link between two devices. This profile forms the basis of several other profiles.
- **Dial-Up Network (DUN)** – Recreates the conditions under which applications such as web browsers and email packages use a modem link to gain access to the Internet.

The one to choose depends upon the kind of device that you are connecting to and what you wish to do with it.

## The blueM button

The button is the only external control on your blueM, everything else is controlled via software. What the button does when it is pressed is up to you:

### To program the button

- 1 Display the [Preferences](#) application.
- 2 Select the *Buttons* page (tap the  in the top right corner and select *Buttons*).
- 3 Tap the *HotSync...* button and then tap the  next to the *Modem* item.
- 4 A list of all applications on your Palm will be displayed, select the one that you want to run whenever the button is pressed (it is normally set to *HotSync*).
- 5 Tap *OK* and then press the blueM button to test your new setting.

### The blue indicator

The button also contains a blue indicator that shows the current Bluetooth status:

- **Off** – No Bluetooth activity
- **Rapid flashing** – Connecting to other Bluetooth devices or sending/receiving data
- **One flash every 4 seconds** – Bluetooth link is active

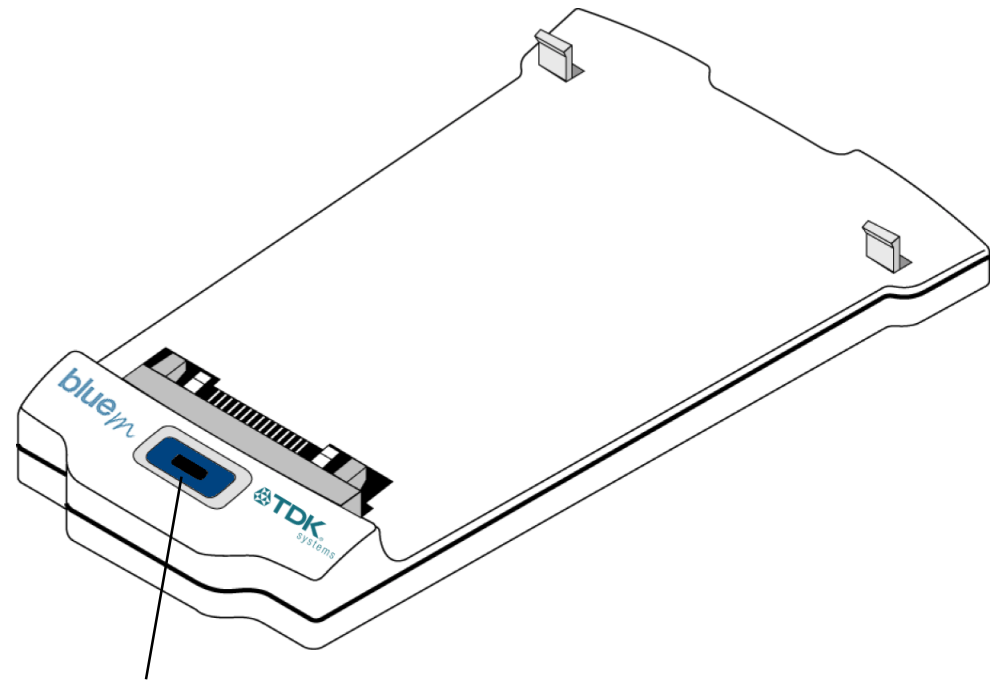

*blueM button  
and indicator*

## Menu Items

The Bluetooth preferences screen offers a limited set of menu items related to the devices listed. To access the menu:

- 1 Display the Bluetooth page of [Preferences](#).
- 2 Tap the  button to display ⇨

### General

**Refresh Name** – Initiates an enquiry to the selected device to check, and update if necessary, its name.

**Properties** – Displays the Bluetooth name and address of the selected device. This option also provides a 'Pair' button to initiate or renew a pairing with the selected device.

**Delete** – Removes the selected devices from the list.

**Settings** – Displays the Settings dialog.

**About** – Displays version information for the blueM device and also its fixed Bluetooth Device Address.

### Incoming

Discoverable mode – Sets the blueM into discoverable mode so that it can be located by searching Bluetooth devices in the vicinity.

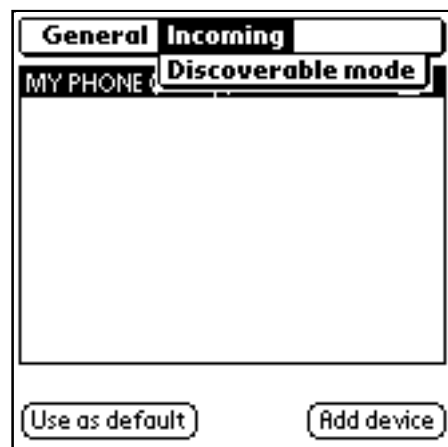

## Settings

The blueM *Settings* menu offers two options.

### To access the settings:

- 1 Select Bluetooth within [Preferences](#).
- 2 Tap the  button and tap the *Settings* option from the drop down list.

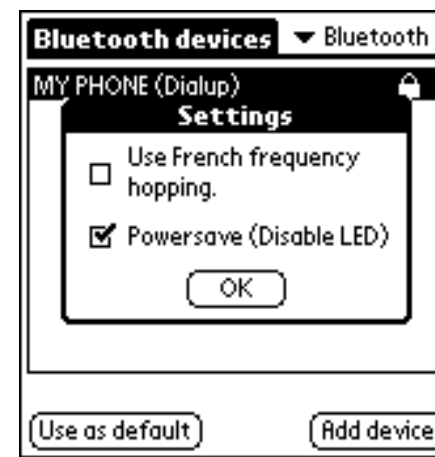

### Use French frequency hopping

This setting is no longer required and should remain disabled.

### Powersave (Disable LED)

Tick this option if you wish to minimise the power drain on your Palm battery.

*Note: When the blue LED indicator is disabled you will not receive an external indication that the blueM is communicating.*

## Pairing Guide

Although limited in its scope, this section aims to provide assistance on configuring popular Bluetooth devices for use with your Palm/blueM. Please refer to our website ([www.tdksys.com](http://www.tdksys.com)) for the latest information.

As a general rule all Bluetooth devices follow the same steps to interoperate. Firstly you need to ensure the Bluetooth devices are discoverable and secondly, that they are paired to establish a permanent relationship. Note, these steps will vary from device to device so always refer to the equipment user manual for advice.

### Please select the required device:

- [Nokia 6210](#)
- [Ericsson R520m](#)
- [Ericsson T39m](#)

## Nokia 6210

The Nokia 6210 is permanently discoverable so you merely need to configure the Palm/blue5 to perform a search.

- 1 On your Palm/blueM, within the Bluetooth page of Preferences, tap *Add device*.
- 2 Set the *Search for* option to *Phones* and tap *Search...*
- 3 Select your Nokia phone from the list of devices found and tap *OK*.
- 4 During the connection process you will be asked to type the preset passkey indicated on a label supplied with the Connectivity Battery. Enter this passkey when requested by your Palm/blueM.
- 5 The next step is to select a Service. On your Palm/blueM, select *Dial-up networking* (for Internet connections) and tap *OK*.

Your Nokia phone and Palm/blueM are now Paired and set as a default.

You may need to check that your 6210 is upgraded to the latest revision in order to use the Bluetooth Connectivity Battery. You can do this in two ways:

- Switch on the phone with the Connectivity Battery fitted. If there is an icon in the top left corner showing a dot with waves radiating from it - ((•)) - then the phone has a sufficient version of software.
- From the standby screen (when not in a call), type *\*#0000#* and note the version number displayed. If it is V 05.02 or higher then the phone has a sufficient version of software.

If your phone has an earlier software version, you can get a free upgrade from your local Nokia dealer.



### To make the R520m discoverable

- 1 From the standby screen, press < or > to enter the menu.
- 2 Press 5 to enter the *Extras* menu.
- 3 Press 4 to select *Bluetooth*.
- 4 Press 1 to select *Discoverable*. The phone will now remain in Bluetooth discoverable mode for 3 minutes.
- 5 Now use the [Discovering other devices](#) method on your Palm to locate the phone.

### To make the R520m search for other devices

- 1 From the standby screen, press < or > to enter the menu.
- 2 Press 5 to enter the *Extras* menu.
- 3 Press 4 to select *Bluetooth*.
- 4 Press 3 to select *Discover*. The phone will now perform a search for other Bluetooth devices in the vicinity. Ensure that your Palm is set to *Discoverable mode*.
- 5 When devices are located, their names will be displayed. Use the *Up* or *Down* button to highlight the required device name and press *Yes*.
- 6 Next, press *Yes* to confirm the prompt *Add to paired* and you will then be prompted to enter a *Passkey*.
- 7 Type a suitable passkey (the number can be up to 16 characters and must be entered the same on the other device) and press *Yes*. Following this your Palm/blueM should ask for an identical passkey.
- 8 Enter the same passkey in your Palm and confirm it. The R520m and your Palm/blueM should now be paired.

*Note: If the Discoverable and Discover options in the Bluetooth menu are greyed out and unselectable, the Bluetooth option may be disabled. Select 4 for Operation Mode and set the mode to On or Automatic.*

### Another method for discovering and pairing your Ericsson phone

- 1 From the standby screen, press < or > to enter the menu.
- 2 Press 5 to enter the *Extras* menu.
- 3 Press 4 to select *Bluetooth*.
- 4 Press 2 to select *Paired Devices*.
- 5 Select *Add Device* and choose *Phone Accepts*.
- 6 On your Palm/blueM, within the *Bluetooth* page of *Preferences*, tap *Add device*.
- 7 Set the *Search for* option to *Phones* and tap *Search...*
- 8 Select your Ericsson phone from the list of found devices and tap *OK*.
- 9 During the connection process you will be asked to type a suitable passkey on both devices (the number can be up to 16 characters long and must be typed exactly the same on both devices. *Note: for mobile phones, ensure that the passkey is numerical.*
- 10 Your devices are now Paired, the next step is to select a Service. On your Palm/blueM, select either *Dial-Up Networking* (for Internet connections) or *Serial port* (if required for other applications) and tap *OK*.  
  
Your Ericsson phone and Palm/blueM are now paired with a default service selected.
- 11 Lastly click *Yes* from your Ericsson phone to accept the Name Tag.

*Note: If the Discoverable and Discover options in the Bluetooth menu are greyed out and unselectable, the Bluetooth option may be disabled. Select 4 for Operation Mode and set the mode to On or Automatic.*

## Ericsson T39m

### To make the Ericsson T39m discoverable

- 1 From the standby screen, press < or > to enter the menu.
- 2 Press 5 to enter the *Extras* menu.
- 3 Press 5 to select *Bluetooth*.
- 4 Press 1 to select *Discoverable*. The phone will now remain in Bluetooth discoverable mode for 3 minutes.
- 5 Now use the [Discovering other devices](#) method on your Palm to locate the phone.

### To make the T39m search for other devices

- 1 From the standby screen, press < or > to enter the menu.
- 2 Press 5 to enter the *Extras* menu.
- 3 Press 5 to select *Bluetooth*.
- 4 Press 3 to select *Discover*. The phone will now perform a search for other Bluetooth devices in the vicinity. Ensure that your Palm is set to *Discoverable mode*.
- 5 When devices are located, their names will be displayed. Use the *Up* or *Down* button to highlight the required device name and press *Yes*.
- 6 Next, press *Yes* to confirm the prompt *Add to paired* and you will then be prompted to enter a *Passkey*.
- 7 Type a suitable passkey (the number can be up to 16 characters and must be entered the same on the other device) and press *Yes*. Following this your Palm/blueM should ask for an identical passkey.
- 8 Enter the same passkey in your Palm and confirm it. The T39m and your Palm/blueM should now be paired.

*Note: If the Discoverable and Discover options in the Bluetooth menu are greyed out and unselectable, the Bluetooth option may be disabled. Select 4 for Operation Mode and set the mode to On or Automatic.*

### Another method for discovering and pairing your Ericsson phone

- 1 From the standby screen, press < or > to enter the menu.
- 2 Press 5 to enter the *Extras* menu.
- 3 Press 5 to select *Bluetooth*.
- 4 Press 2 to select *Paired Devices*.
- 5 Select *Add Device* and choose *Phone Accepts*.
- 6 On your Palm/blueM, within the *Bluetooth* page of *Preferences*, tap *Add device*.
- 7 Set the *Search for* option to *Phones* and tap *Search...*
- 8 Select your Ericsson phone from the list of found devices and tap *OK*.
- 9 During the connection process you will be asked to type a suitable passkey on both devices (the number can be up to 16 characters long and must be typed exactly the same on both devices. *Note: for mobile phones, ensure that the passkey is numerical.*
- 10 Your devices are now Paired, the next step is to select a Service. On your Palm/blueM, select either *Dial-up Networking* (for Internet connections) or *Serial Port* (if required for other applications) and tap *OK*.  
  
Your Ericsson phone and Palm/blueM are now paired with a default service selected.
- 11 Lastly click *Yes* from your Ericsson phone to accept the Name Tag.





*Note: If the Discoverable and Discover options in the Bluetooth menu are greyed out and unselectable, the Bluetooth option may be disabled. Select 4 for Operation Mode and set the mode to On or Automatic.*

## HSCSD

High Speed Circuit Switched Data (HSCSD) is an enhancement of Circuit Switched Data (CSD) which is available on current GSM networks. It increases the speed of transmission so you can send and receive information up to three times faster than the current maximum of 9600bps. The HSCSD solution enables higher rates by using multiple channels, allowing subscribers to enjoy faster Internet access and e-mail.

*Note: Contact your service provider for details on availability, supported connection rates and to subscribe to this service.*

To set up your Palm to make HSCSD connections

- 1 Tap  to locate the  icon.
- 2 Tap the  icon.
- 3 If the Connection is not already showing, tap the  in the top right corner and select *Connection* from the drop down list.
- 4 Highlight Bluetooth (Dialup) and click on Edit.

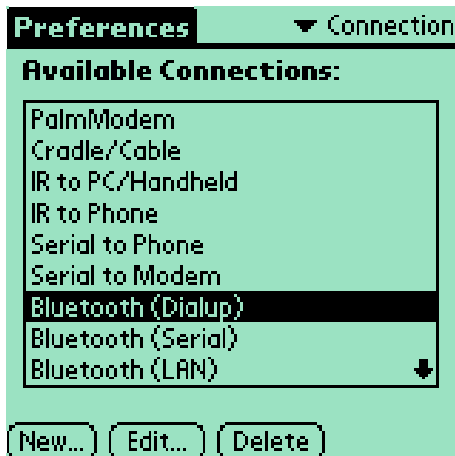

- 5 Click on Details.

- 6 Enter the Init String (initialisation string) relevant to the mobile phone you have.

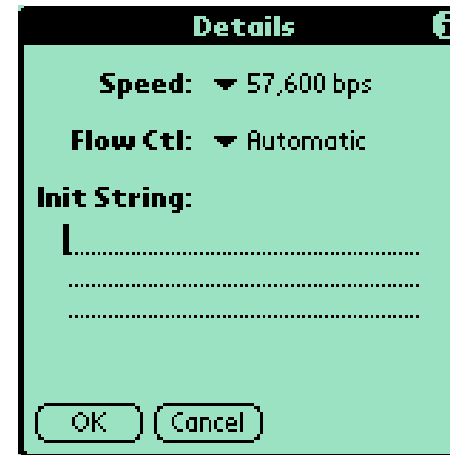

### Nokia 6210

Connection	Initialisation String
9,600bps	at+chsn=1,0,0,0
14,400bps	at+chsn=2,0,0,0
19,200bps	at+chsn=3,0,0,0
28,800bps	at+chsn=4,0,0,0
43,200bps	at+chsn=6,0,0,0

### Ericsson R520m & T39m

Connection	Initialisation String
9,600bps	at+chsn=1,1,0,4
14,400bps	at+chsn=2,1,0,12
19,200bps	at+chsn=3,2,0,12
28,800bps	at+chsn=4,2,0,12

## GPRS

General Packet Radio Service (GPRS) is a high speed packet based service that allows continuous connection. GPRS offers increased data throughput rates, so information retrieval is much faster.

*Note: Currently only a limited number of networks support GPRS . Contact your service provider for details on availability and to subscribe to this service .*

The Bluetooth enabled GPRS phones currently supported are the Ericsson R520m and T39m. In time more Bluetooth phones supporting GPRS will become available.

Both the handset and Palm need to be set up to initiate a GPRS call.

1. From the standby screen, press < or > to enter the menu.
2. Press 4 to enter the *Settings* menu and select Data comm.
3. Select Data accounts then Add account (GPRS data) and give it a name. You then need to enter the APN, which is the Access Point Name supplied by the network. This is case sensitive on most network.
4. Do not enter a User id or Password - this will be done on the Palm.
5. Save the settings.
6. Select Data accounts again, select the account you have just created and select Edit.
7. Do not enter an IP address, unless your network operator demands one. In most GPRS networks the IP address will be dynamically allocated at each connection. Select Save.
8. Set the Advanced settings as defined by your network. If you have no guidelines then set:

Authentication - Normal

Data Compression - Off

Header Compression - Off

Quality of Service - Precedence - Subscribed or Normal





Delay - Subscribed or Best Effort

Reliability - Class 3 or Best Effort

Peak Rate - Subscribed or Class 3

Mean Rate - Subscribed or Best Effort



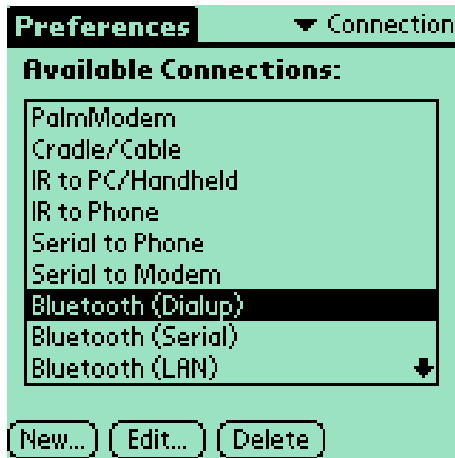

## On the Palm

- 1 Tap  to locate the  icon.
- 2 Tap the  icon.
- 3 If the Connection is not already showing, tap the  in the top right corner and select *Connection* from the drop down list.
- 4 Select Bluetooth (Dialup).



- 5 Tap Edit and check that the connection is BT(DUN) to modem.
- 6 Tap details and set Speed to 115,200bps and flow control to Automatic.

You now need to set up a Network Dial-Up Connection.

1. Tap  to locate the  icon.
2. Tap the  in the top right corner and select *Network* from the drop down list.
3. Create a new service by tapping  and tapping New.
4. Enter a name for the Service, e.g. Orange GPRS.
5. Enter the User Name assigned by your network operator. If there is no password, enter dummy.
3. Enter a password supplied by your network operator. If there is no password, enter dummy.
4. Select Bluetooth (Dialup) as the Connection
5. Enter the GPRS activation number supplied by your network operator.

*Note: This is not a real number, but a code used to instruct the handset to start a GPRS session. Most networks and handsets use the string \*99#*

6. Tap Details and ensure that Connection type is PPP, Query DNS is selected and IP address is set to Automatic.

Start your application. The Service Connection Progress Box will display the following messages:





Initializing Dialling "Orange GPRS" Signing On Established

During the end of the Dialling phase the handset may display a connection logo. Otherwise the handset may not display any details about the connection.

## V.110

The main benefit of V.110 connections compared to standard GSM data connections is that call setup is much quicker. Transmission delay and error rate is also slightly lower. V.110 data calls are routed over ISDN and therefore the call setup and data transfer is entirely digital.

To set up your Palm to make V.110 connections

- 1 Tap  to locate the  icon.
- 2 Tap the  icon.
- 3 If the Connection is not already showing, tap the  in the top right corner and select *Connection* from the drop down list.
- 4 Highlight Bluetooth (Dialup) and click on Edit.

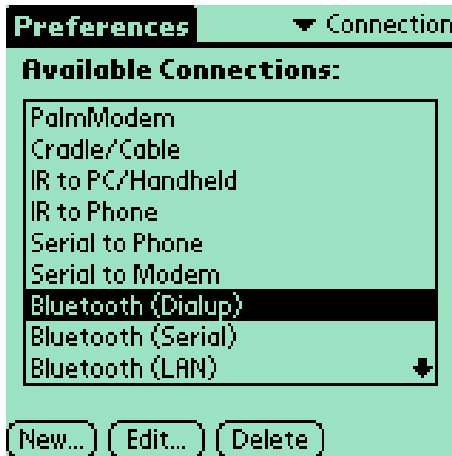

- 5 Click on Details.

- 6 Enter the Init String (initialisation string) relevant to the mobile phone you have.

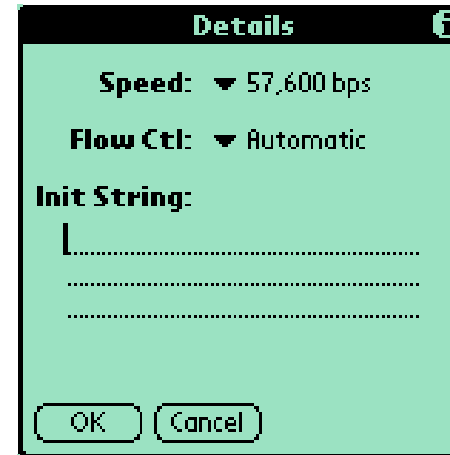

### Nokia 6210

Connection	Initialisation String
9,600bps	at+cbst=71,0,1

### Ericsson R520m & T39m





Connection	Initialisation String
9,600bps	at+cbst=71,0,1

## V.110 HSCSD

V.110 HSCSD data connections enable quick call setup and faster Internet access at speeds up to 43.2kbps.

*Note: Contact your service provider for details on HSCSD availability, supported connection rates and to subscribe to this service.*

To set up your Palm to make V.110 connections

- 1 Tap  to locate the  icon.
- 2 Tap the  icon.
- 3 If the Connection is not already showing, tap the  in the top right corner and select *Connection* from the drop down list.
- 4 Highlight Bluetooth (Dialup) and click on Edit.

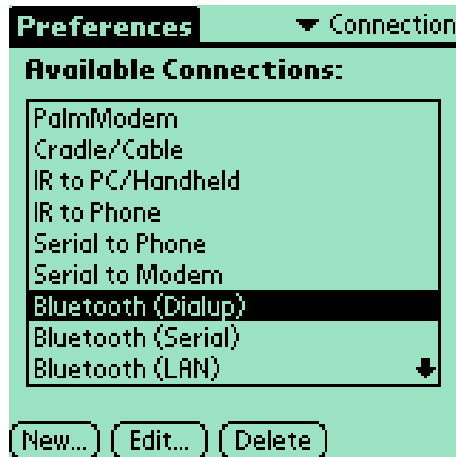

- 5 Click on Details.

- 6 Enter the Init String (initialisation string) relevant to the mobile phone you have.

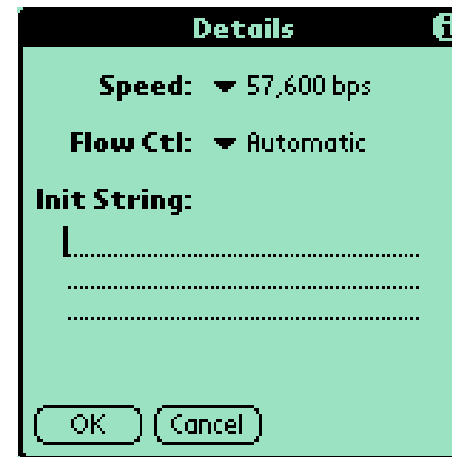

### Nokia 6210

Connection	Initialisation String
9,600bps	at+cbst=71,0,1;+chsn=1,0,0,0
14,400bps	at+cbst=81,0,1;+chsn=2,0,0,0
19,200bps	at+cbst=81,0,1;+chsn=3,0,0,0
28,800bps	at+cbst=81,0,1;+chsn=4,0,0,0
43,200bps	at+cbst=81,0,1;+chsn=6,0,0,0

### Ericsson R520m & T39m

Connection	Initialisation String
9,600bps	at+cbst=71,0,1;+chsn=1,1,0,4
14,400bps	at+cbst=75,0,1;+chsn=2,1,0,12
19,200bps	at+cbst=78,0,1;+chsn=3,2,0,12
28,800bps	at+cbst=79,0,1;+chsn=4,2,0,12

# Troubleshooting and Information

## Troubleshooting

### Pairing problems

The pairing process is an important operation. If the devices do not pair then they cannot share information or resources. Ensure that one device is discoverable and the other is in discover, or search mode. Check that the same passkey is entered identically on both devices.

### BlueSync problems

When using HotSync over a Bluetooth connection, the most common cause of problems lies with the computer's configuration. Ensure that the HotSync setup has been adjusted correctly and that the serial port specified in the Local section relates to that used by the installed Bluetooth adaptor.

## Technical Support

If, after having tried the aforementioned guidelines you are still experiencing problems please contact your place of purchase or local distributor. Alternatively, for further guidance and up to date product information try:

*Our website at*

[www.tdksys.com](http://www.tdksys.com)

*or our helpdesk at*

[support@tdksys.com](mailto:support@tdksys.com)

## Technical Information

Power consumption - standby:	0.5mA
Power consumption - established connection with data transfer:	35mA
Supply voltage:	3.2V - 4.2V
Operating Temperature:	0 - 60°C
Maximum RF output power:	2.5mW (4dBm)
Nominal RF output power:	1mW (0dBm)
Range:	up to 10 metres, free space.
Weight:	29g
Size:	54 x 90.4 x 13.3mm (W x L x H)
Compliant with open standard:	Bluetooth 1.0b (Document number 1.C.47/1.0B) + C.e. Bluetooth power class: 2



## Regulatory Information

This product complies with any mandatory product specification in any country where the product is sold. In addition, the product complies with the following:

### European Union (EU) and EFTA

This equipment complies with the R&TTE directive 1999/5/EC and the following standards:

ETS 300 328-1 V1.2.2 (2000-07)

ETS 300 826 11/1997

EN 60950:1992 + A1:1993, A2:1993, A3:1995, A4:1997, A11:1997

EU recommendation 1999/519/EC and has been provided with the CE mark accordingly.



### Bluetooth

This equipment is qualified according to Bluetooth specification Ver 1.0B (Specification of the Bluetooth System, Core Specification Volume 1 and Profiles Specification Volume 2 V1.0B, December 1st 1999 (Document number 1.C.47/1.0B)+ Critical Errata) and supports DUN and Serial port profile.



### Declaration of Conformity

To view the Declaration of Conformity for this product, please see the last page or [click here](#).

### Special notices for use in France and Italy

#### France

Dispositif à faible puissance (1 mW), pas de limitation pour son usage à l'intérieur ou à l'extérieur.

Low power device (1 mW), no limitation for in- or outdoor use.

#### Italy

E' necessaria la concessione ministeriale anche per l'uso. Verificare con i rivenditori la procedura da seguire.

Licence required for use. Check with your reseller for the procedure you need to follow.

## Safety Statements

Please note the two following Underwriters Laboratories Inc.'s notices:

"This UL Listed ITE Accessory is intended for use with a Listed Palm PDA."

"The long-term characteristics or the possible physiological effects of radio frequency (RF) electromagnetic fields associated with this equipment have not been evaluated."

### In addition:

This device complies with Part 15 of the FCC rules and with RSS-210 of Industry Canada. Operation is subject to the following two conditions:

- (1) This device may not cause harmful interference.
- (2) This device must accept any interference received, including interference that may cause undesired operation.

The radiated output power of the TDK blueM is far below the FCC Radio frequency exposure limits. Nevertheless, this device should be used in such a manner that the potential for human contact during normal operation is minimized.

Warning: Changes or modifications made to this this equipment not expressly approved by TDK Systems Europe Limited may void the FCC authorization to operate this equipment.

### Important Please note the following:

This equipment has been tested and found to comply with the limits for a Class B digital device, pursuant to part 15 of the FCC Rules. These limits are designed to provide reasonable protection against harmful interference in a residential installation. This equipment generates, uses and can radiate radio frequency energy and, if not installed and used in accordance with the instructions, may cause harmful interference to radio communications. However, there is no guarantee that interference will not occur in a particular installation. If this equipment does cause harmful interference to radio or television reception, which can be determined by turning the equipment off and on, the user is encouraged to try to correct the interference by one or more of the following measures:

- Reorient or relocate the receiving antenna.
- Increase the separation between the equipment and receiver.
- Connect the equipment into an outlet on a circuit different from that to which the receiver is connected.
- Consult the dealer or an experienced radio/TV technician for help.



## Glossary

### Authentication

Process of verifying the identity of the user at the other end of a link. Authentication is accomplished by using a link key stored in the device memory or by a user PIN (called pairing).

### Authorization

Process of deciding if a requesting device is allowed to have access to a service on another device. Authorization always includes authentication.

### Bluetooth Device Address

Every Bluetooth transceiver is issued a unique 48-bit Bluetooth Device Address which is used for quite a few algorithms when exchanging data between devices. The Bluetooth Device Address is used for hop sequence generation and many error detection code generation schemes.

### Bluetooth Unit

Any device such as a mobile handset, PDA, or PC card that is equipped with suitable Bluetooth hardware needed to establish wireless communication between devices.

### Bonding / Pairing

The creation of a semi-permanent (or permanent) relationship between two devices. The relationship is established when the user enters a passkey with the explicit purpose of creating a bond between two devices. This procedure is different from authenticating using a passkey in which the user is requested to enter a passkey during the establishment of a link.

### Inquiry / Discovery

Process by which a Bluetooth unit transmits inquiry messages in order to discover the other Bluetooth units that are active within the coverage area. Any Bluetooth unit that received the inquiry message may respond to the inquiring device with information about its Bluetooth unit and its host device.

### PIN / Passkey

Personal Identification Number. A type of password that is unique to a user.

### Piconet

A network of devices connected using Bluetooth technology. A piconet may consist of two to eight devices. In a piconet, there will always be one master while the others are slaves.

### Trusted device / Paired device

A device that has been authenticated.

### Profiles

Bluetooth software emulates various types of wired links it is designed to replace. Each of these emulations are known as profiles. Examples of profiles are serial port, LAN and dial-up networking.

## Warranty

TDK warrants that the blueM product shall conform to TDK's published specifications, which may be subject to change, and remain free from defects in materials and workmanship under normal, proper and intended use for a period of one (1) year from date of purchase, provided that proof of purchase be furnished with any returned equipment.

If, during the warranty period, any component part of the equipment becomes defective by reason of material or workmanship, and TDK is immediately notified of such defect, TDK shall at its option supply a replacement part or request return of equipment, freight prepaid, to its designated facility for repair. In the event that no fault is found on a product returned for repair, TDK reserves the right to charge the customer its standard published repair charge.

This warranty shall not apply to any product that has been subject to misuse, bending, twisting, neglect, alteration, improper installation, operation outside of the parameters of the published specification, use in any non-approved countries or unauthorised repair performed by anyone other than a TDK designated repair facility. Any non-warranty repairs or maintenance shall be at TDK's standard rates in effect at the time.

This warranty is in lieu of all other warranties, whether expressed, implied, or statutory, including but not limited to, implied warranties or merchantability and fitness for a particular purpose. In no event shall TDK be liable, whether in contract, in tort, or on any other basis, for any damage sustained by its customers or any other person arising from or related to loss of use, failure or interruption in the operation of any products, or delay in maintenance, or for incidental, consequential, indirect, or special damages or liabilities, or for loss of revenue, loss of business, or other financial loss arising out of or in connection with the sale, lease, maintenance, use, performance, failure, or interruption of these products.

## Copyright and Trademark Notices

The words HotSync, Palm and Palm OS are all registered trademarks of Palm Inc, or its subsidiaries in one or more countries. Other products and brand names may be the trademarks or registered trademarks of their respective owners.

BLUETOOTH is a trademark owned by Bluetooth SIG, Inc, U.S.A. and licensed to TDK Systems Europe Limited.