

USB Adaptor & PC Card

Bluetooth Solutions

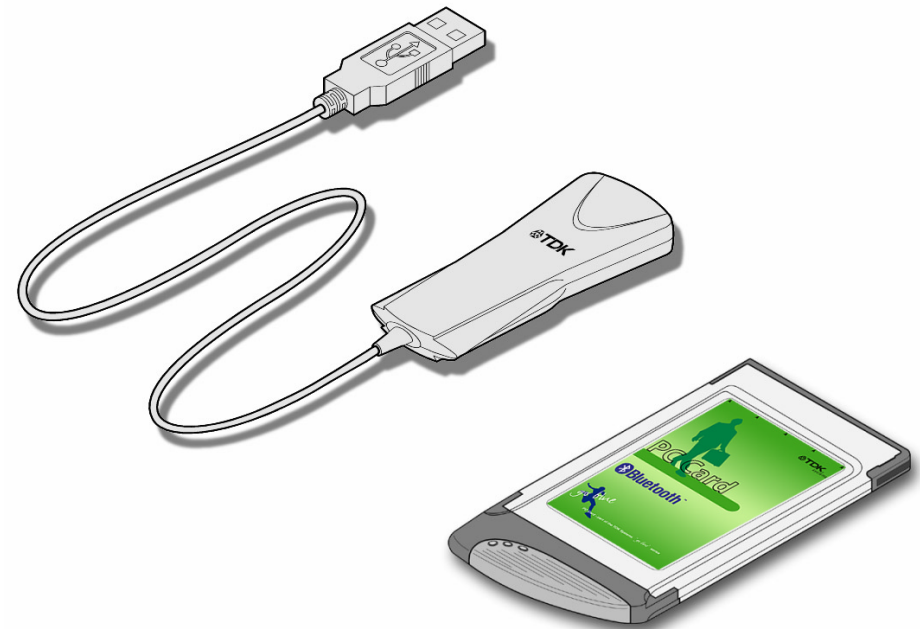

Contents

Introduction	3
Box Content	3
Getting Started	4
Installing the Software	4
Installing the Hardware	5
Bluetooth Configuration	6
My Bluetooth Places	8
Device Discovery	9
Service Discovery	10
Bluetooth Services (Profiles)	11
Pairing Guide	13
Ericsson R520m	14
Ericsson T39m	16
Ericsson T68/T68i	18
Sony Ericsson P800	20
Nokia 6210	21
Nokia 6310/6310i	22
Nokia 7650	23
Nokia 8910/8910i	24
HSCSD	25
Frequently Asked Questions	26
Technical Support	27
Regulatory Information	Error! Bookmark not defined.
Safety Statements	28
Technical Information	29
Glossary	30
Warranty	31

Introduction

Bluetooth is a short range wireless communication technology. It is designed to replace the traditional cable connections currently used to link compatible devices. These can be cable connections between computers and printers, computers and mobile phones and between mobile phones and headsets. Bluetooth is designed to operate in the internationally recognised ISM (Industrial Scientific and Medical) frequency band. Within the ISM band (2.4GHz – 2.48GHz) Bluetooth transmissions hop between 79 separate frequencies 1,600 times every second. Bluetooth is a low power radio designed for short range communication of about 10 metres and has an impressive peak data throughput of 721Kbps.

The potential applications for this new wireless technology are enormous – in time Bluetooth technology will touch all our lives in some shape or form. In the short term, Bluetooth will make mobile computing much easier and far more convenient than it's ever been. In the longer term, Bluetooth will open up a whole new world of infinitely flexible personal connectivity.

Box Content

Bluetooth USB Adaptor

- USB Adaptor
- Installation CD-ROM
- Instruction Booklet
- Green Oval Housing (2)

Bluetooth PC Card

- PC Card
- Installation CD-ROM
- Instruction Booklet

Getting Started

Installing the Software

Note: Do not connect your Bluetooth USB Adaptor or insert your Bluetooth PC Card until you have completed the install procedure detailed below.

- 1) Insert the CD into the CD/DVD drive on your PC. The CD should start automatically and present you with an installation menu.

*If the CD fails to start automatically, click on the Start button, select Run and type **D:\Setup.exe** (assuming your CD/DVD drive is D) then press Enter or click OK.*

- 2) Choose Install Bluetooth Software to start the InstallShield Wizard.
- 3) Click **Next**.
- 4) If you agree with the license terms select **I accept the terms in the license agreement** and click **Next**.
- 5) Ensure the device name and type are set correctly then click **Next**.

Note: The device name should be unique. This will be visible to other people when they discover your Bluetooth device.

- 6) Choose to accept the default folder by clicking **Next**, or change the location by using the **Change** option.
- 7) Click **Install**.
- 8) When the install has completed click **Finish**.
- 9) Click **Yes** to restart Windows.

Installing the Hardware

Bluetooth USB Adaptor

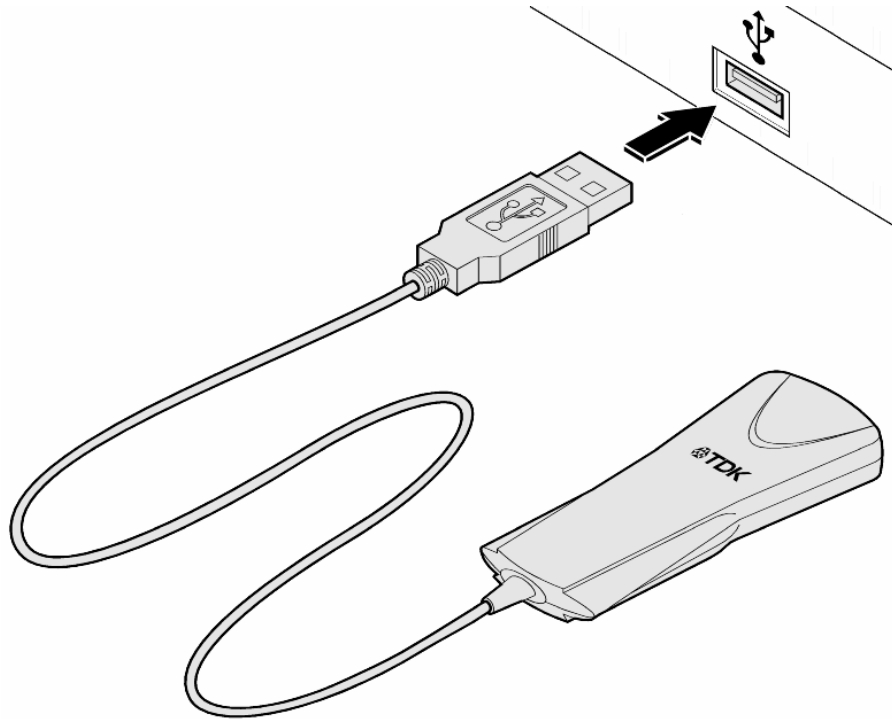

- 1) Insert the Bluetooth USB Adaptor into the USB port.
- 2) Windows will inform you that new hardware has been discovered and that it is being installed.

*Note: Windows XP users will need to click **Next, Continue Anyway** then **Finish**.*

Bluetooth PC Card

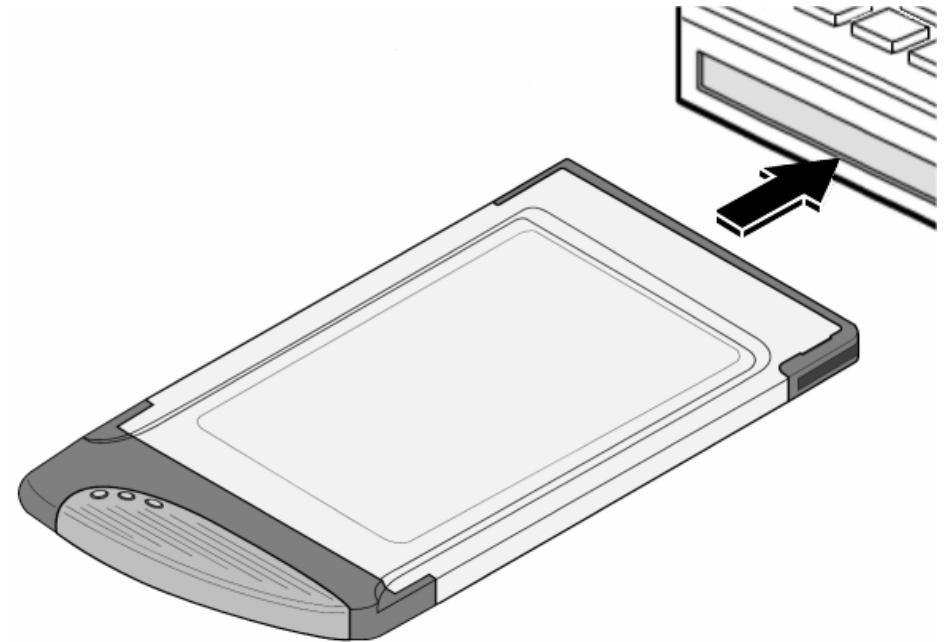

- 1) Insert the Bluetooth PC Card into a free PC Card Slot.
- 2) Windows will inform you that new hardware has been discovered and that it is being installed.

*Note: Windows XP users will need to click **Next, Continue Anyway** then **Finish**.*

Bluetooth Configuration

After successful installation of the software and hardware you should have a new item on the Windows taskbar. This is the Bluetooth tray icon.

Right-click on it, select Advanced Configuration and you will see the following screen.

Note: The computer name you see here is the same as your computer name or the name you chose during the installation process. The computer type is either "Desktop" or "Laptop". This information is shown to other Bluetooth users when they search for your computer.



Bluetooth Tray Icon
Windows 2000



Bluetooth Tray Icon
Windows XP

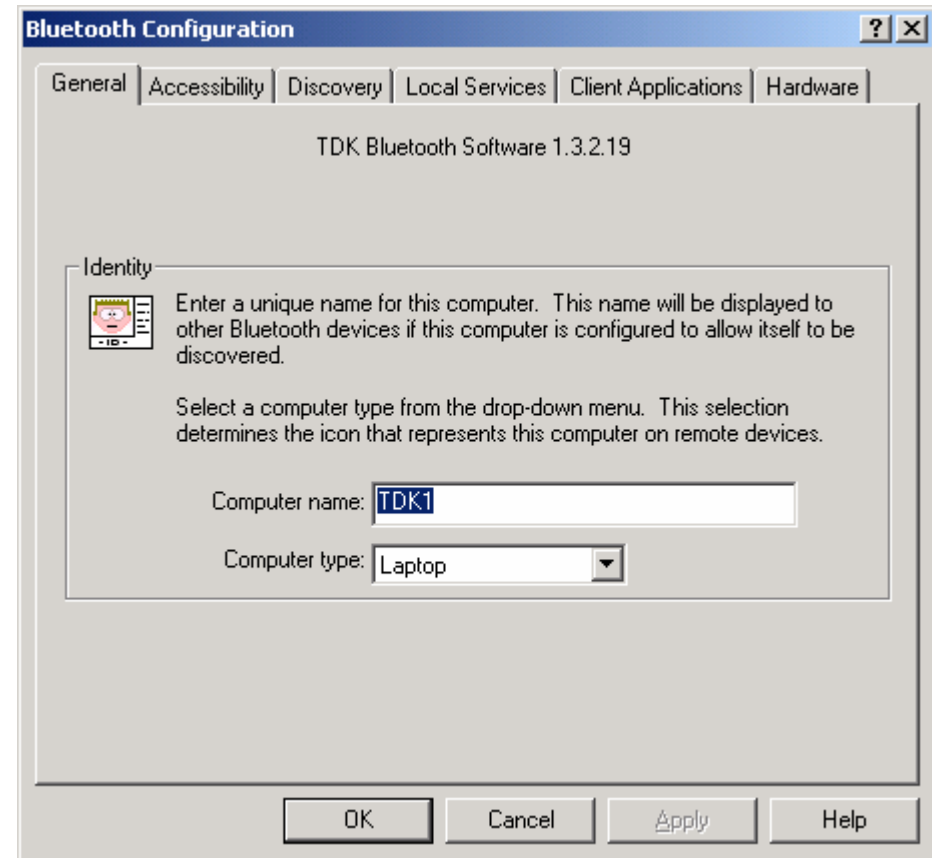

Bluetooth Configuration - General

To check your hardware is working click on the Hardware tab.

If the Device Status is showing **Device Not Found** then your USB Adaptor or PC Card has not been detected by the software. If the device is not plugged in, insert it and select this hardware option again.

Note: There are more details about the Bluetooth Configuration Panel in the Bluetooth help guide. You can view this help by clicking on the Help button, seen here in the bottom right hand corner.

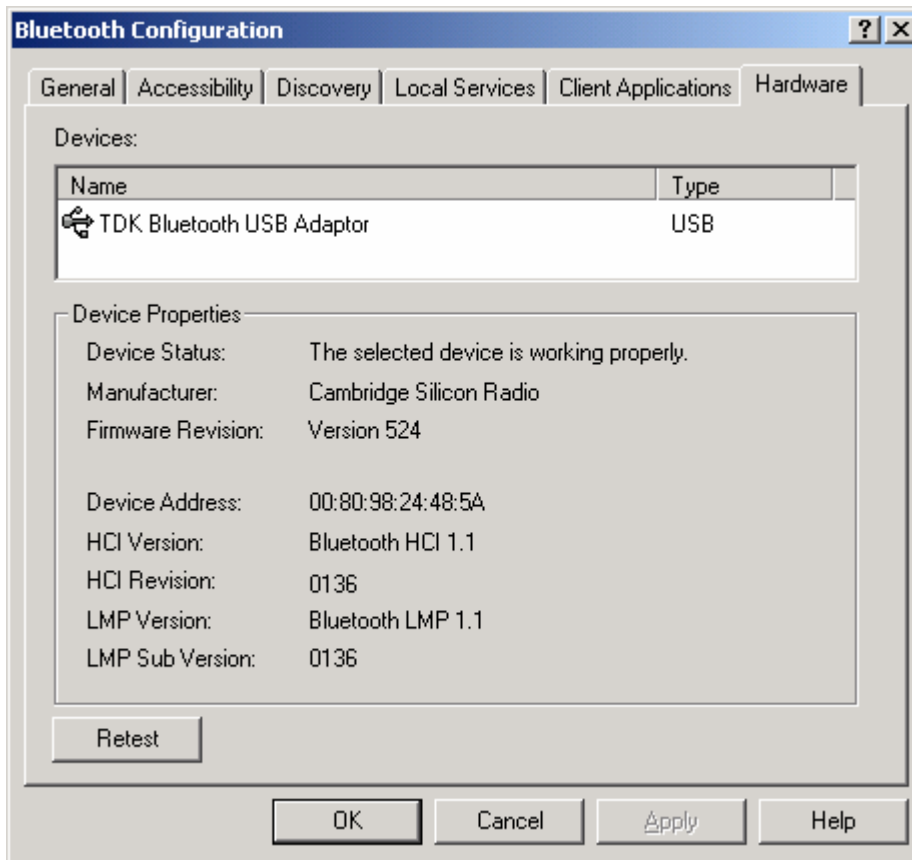

Bluetooth Configuration – Hardware
Windows 2000

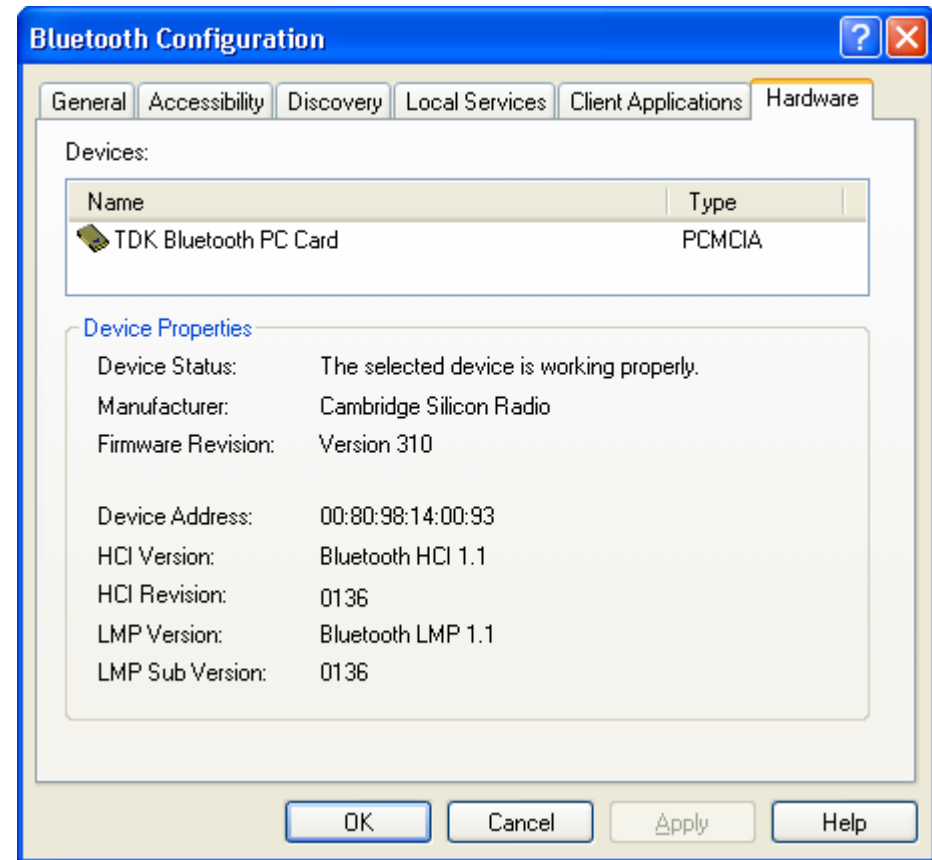

Bluetooth Configuration – Hardware
Windows XP

My Bluetooth Places

After installation of the Bluetooth software you will have a new icon on your desktop. This is the My Bluetooth Places icon.

Double-click on this icon to bring up My Bluetooth Places.



My Bluetooth Places - Desktop Icon

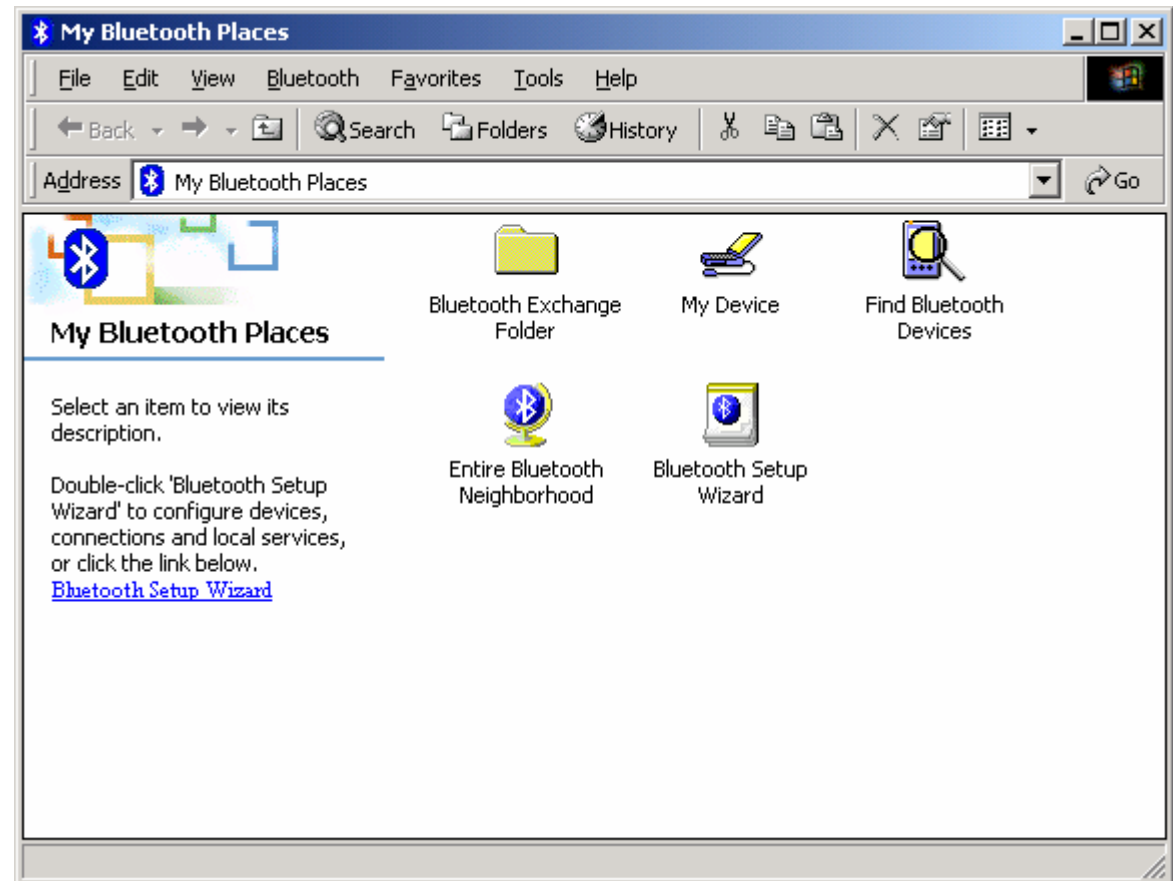

My Bluetooth Places

Device Discovery

Windows 98/Me/2000

Double-click on Find Bluetooth Devices. A search for other Bluetooth devices within radio range will start automatically. If any devices are discovered they will be displayed.

Windows XP

Click on View devices in range. A search for other Bluetooth devices within radio range will start automatically. If any devices are discovered they will be displayed.

Note: The search may take a few minutes if there are many discoverable Bluetooth devices within range.

If you have not configured other Bluetooth devices yet, set them up now then click View, Refresh to re-discover these Bluetooth devices. There is a section later in this guide to help set up Bluetooth connections with the most popular Bluetooth mobile phones.

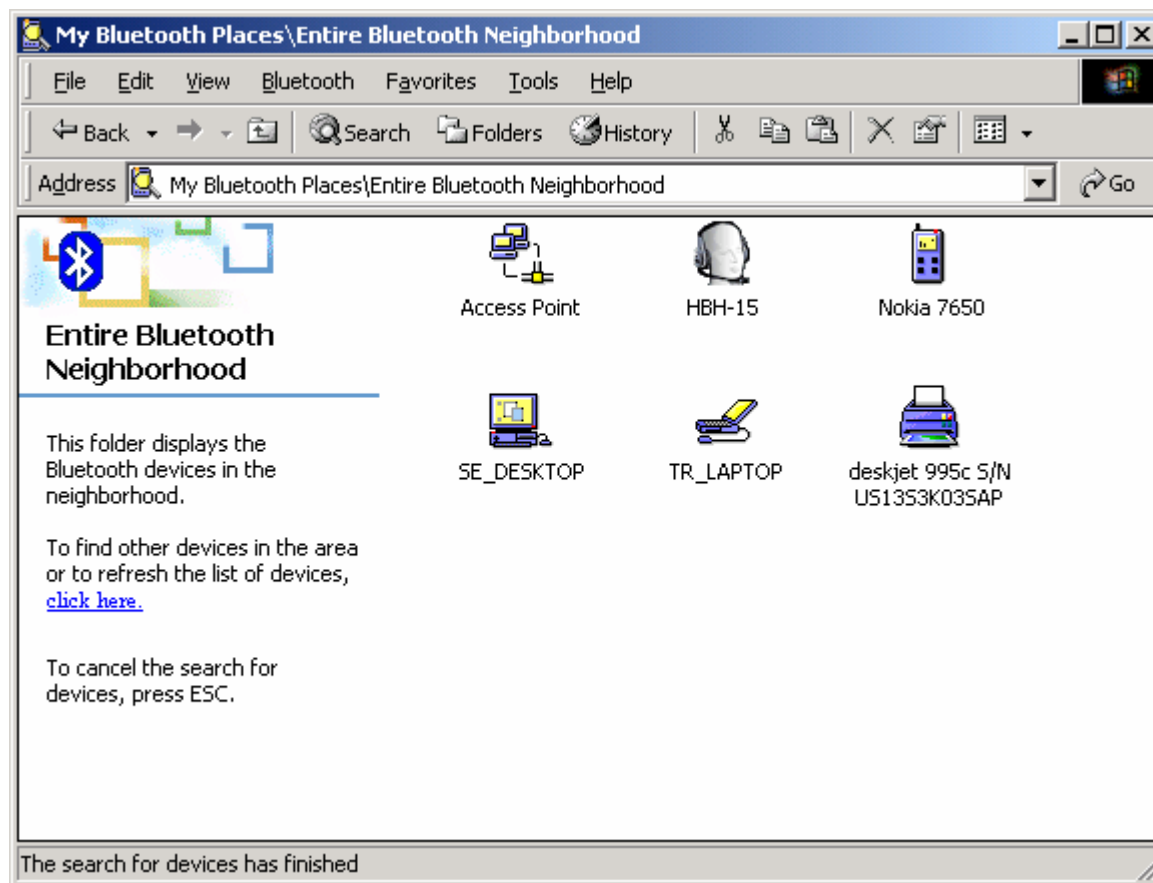

Entire Bluetooth Neighborhood – Search Complete

Service Discovery

Each device you have discovered will have services you can access. To find out which services a device supports double click on that device. You will then see all the services listed, providing the services are compatible and the device has not gone out of range or been switched off.

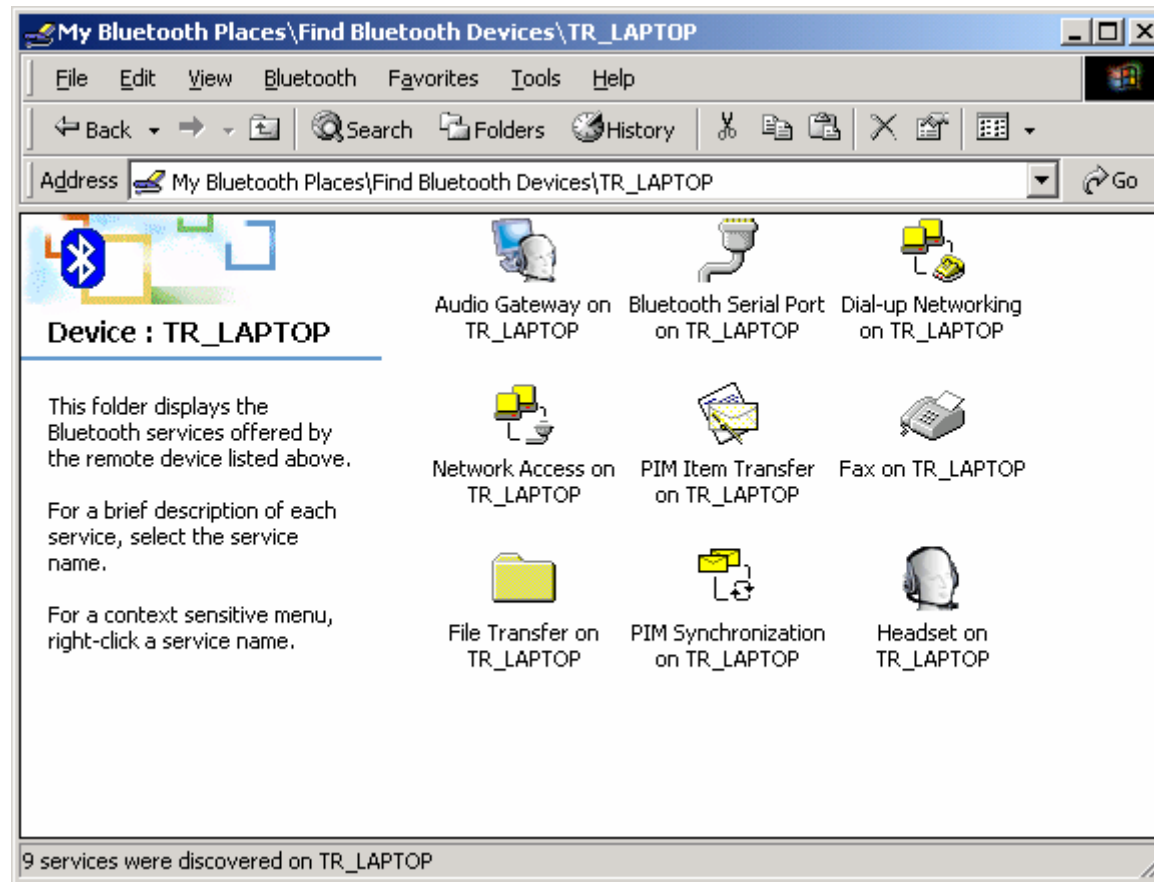

Service Discovery

Bluetooth Services (Profiles)



The **Bluetooth Serial Port** allows you to establish a serial connection to a Bluetooth serial port on another Bluetooth device. The serial connection can be used by legacy applications as it emulates a simple RS232 serial cable link between two Bluetooth devices.



The **Dial-Up Networking (DUN)** service allows you to access and use the modem on another Bluetooth device to dial out, typically to an Internet Service Provider (ISP) to browse the internet and send/receive email.



The **Audio Gateway** service allows remote devices to use the audio features of your computer.



The **Headset** service allows you to connect to Bluetooth headset devices.



Network Access allows you to connect to the Internet and LAN through another Bluetooth device's LAN connection.



PIM Item Transfer is used to exchange items between the personal information managers (PIM) via Bluetooth.



If you want to copy, move or drag and drop files you should use file transfer. In fact you can perform any usual file transfer actions with **File Transfer** such as open, cut, copy, paste and delete.



PIM Synchronization is used to synchronize the information (PIM database) between you and another Bluetooth device.



If you wish to send a **Fax** over Bluetooth you can access the fax service of another Bluetooth device to do this.

Note: You are advised to view the Help file supplied with this software for more detailed information about all of these services.

LED Status

Bluetooth USB Adaptor

The USB Adaptor is designed to meet USB specification 1.1 and incorporates an integral antenna.

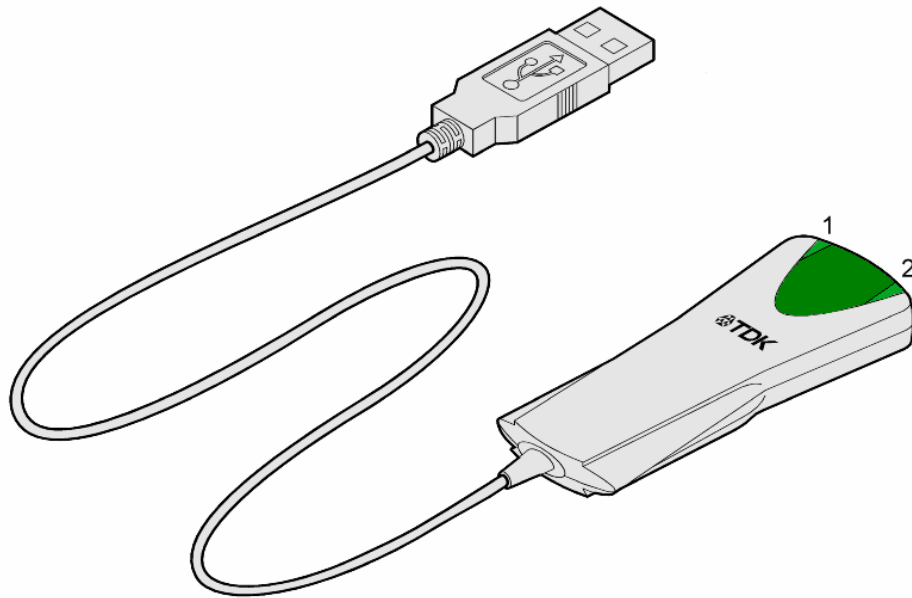

Each LED indicates the following

LED	Description	Function
1	Power/Data	Normally on. Flashes whilst data transfer is in progress
2	Status	Flashes every 2 seconds when the device is discoverable

Bluetooth PC Card

The PC Card is a type II PC Card. It incorporates an integral antenna.

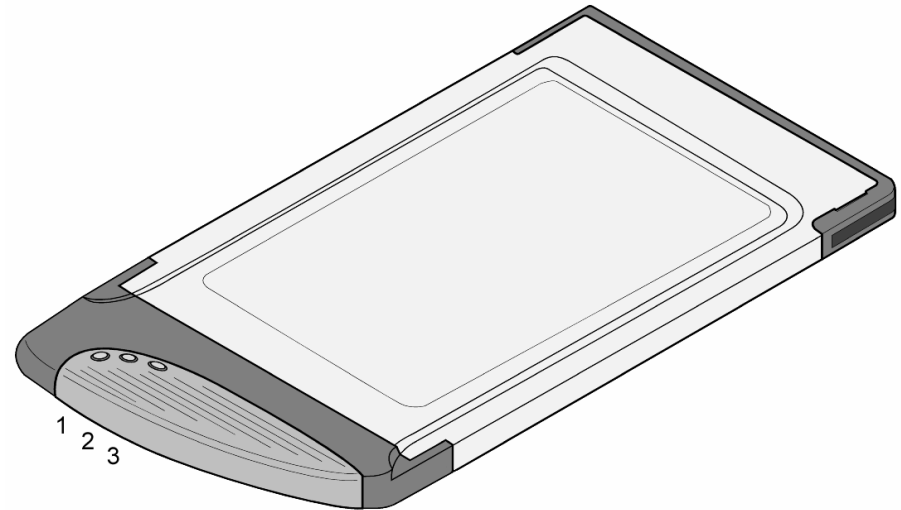

Each LED indicates the following

LED	Description	Function
1	Data	Normally on. Flashes whilst data transfer is in progress
2	Power	Permanently on when the device is powered
3	Status	Flashes every 2 seconds when the device is discoverable

Pairing Guide

Pairing (also referred to as bonding) is the process of associating Bluetooth devices with each other. It is advisable to *pair* with frequently used Bluetooth devices. This will establish a permanent security link between the devices and enable quick access to the services provided, without the need to enter passkeys.

Once a device is paired it remains paired even if the user:

- Reboots one or both devices
- Stops and starts the services on the devices



Note: A paired device will be displayed in the Entire Bluetooth Neighborhood window even if the device is not within radio range and/or powered on at the time Entire Bluetooth Neighborhood is opened and explored.

For additional information on how to pair a specific device that is not included in the following section, refer to the documentation supplied with that Bluetooth device.

Note: blue5 and blueM users should refer to the online user guide provided on the blue5/blueM software CD.

The following section shows how to pair your USB Adaptor or PC Card solution with other popular Bluetooth solutions.

Ericsson R520m

- 1 From the standby screen, press  or  to enter the menu.
- 2 Press 5 to enter the Extras menu.
- 3 Select Bluetooth.
- 4 Press 2 to select Paired devices.
- 5 Select Add device and choose Phone accepts.

Note: If the Add device option in the Paired devices menu is greyed out and unselectable, the Bluetooth option may be disabled. Return to the Bluetooth menu, press 4 for Operation Mode and set the mode to On or Automatic.

- 6 Double-click My Bluetooth Places on the desktop.
- 7 Double-click Find Bluetooth Devices.
- 8 Wait while discoverable Bluetooth devices that are in range are discovered.
- 9 Right-click your R520m phone shown in the list of devices found and select Pair Device.

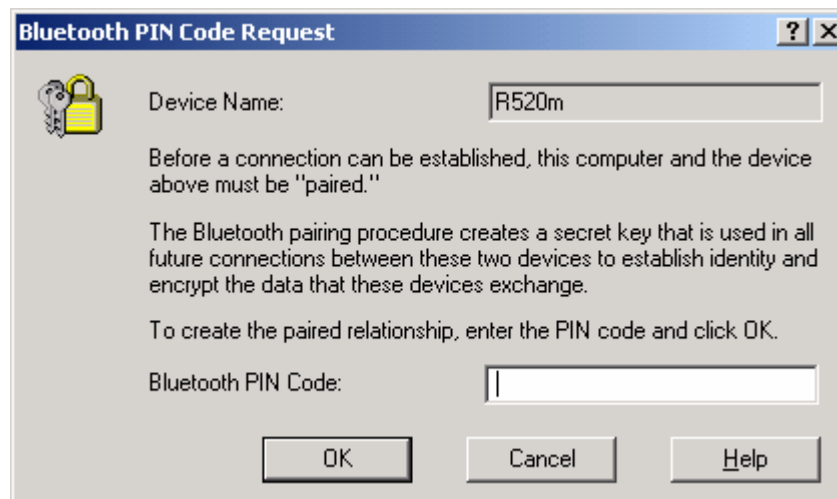

Bluetooth PIN Code Request

- 10 Enter a passkey of your choice (the passkey can be up to 16 characters long and must be numerical).
- 11 Click OK.
- 12 Your Ericsson phone will prompt you to Add to paired devices.
- 13 Press Yes.
- 14 Enter the same passkey on your phone.
- 15 Press Yes.
- 16 Your Ericsson phone will prompt you to edit the name tag. When you are satisfied with the name tag, press Yes.

Ericsson T39m

- 1 From the standby screen, press  to enter the menu.
- 2 Press 5 to enter the Extras menu.
- 3 Select Bluetooth.
- 4 Press 2 to select Paired devices.
- 5 Select Add device and choose Phone accepts.

Note: If the Add device option in the Paired devices menu is greyed out and unselectable, the Bluetooth option may be disabled. Return to the Bluetooth menu, press 4 for Operation Mode and set the mode to On or Automatic.

- 6 Double-click My Bluetooth Places on the desktop.
- 7 Double-click Find Bluetooth Devices.
- 8 Wait while discoverable Bluetooth devices that are in range are discovered.
- 9 Right-click your T39m phone shown in the list of devices found and select Pair Device.

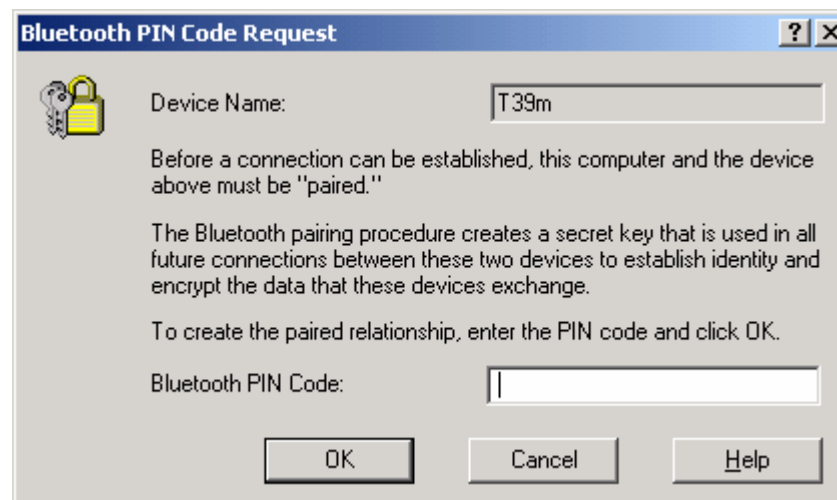

Bluetooth PIN Code Request

- 10 Enter a passkey of your choice (the passkey can be up to 16 characters long and must be numerical).
- 11 Click OK.
- 12 Your Ericsson phone will prompt you to Add to paired devices.
- 13 Press Yes.
- 14 Enter the same passkey on your phone.
- 15 Press Yes.
- 16 Your Ericsson phone will prompt you to edit the name tag. When you are satisfied with the name tag, press Yes.

Ericsson T68/T68i

- 1 From the standby screen, move the joystick to the right to enter the menu.
- 2 Press 8 to enter the Connect menu.
- 3 Select Bluetooth.
- 4 Press 2 to select Paired devices.
- 5 Select Add device and choose Phone accepts.

Note: If the Add device option in the Paired devices menu is greyed out and unselectable, the Bluetooth option may be disabled. Return to the Bluetooth menu, select Operation Mode and set the mode to On or Automatic.

- 6 Double-click My Bluetooth Places on the desktop.
- 7 Double-click Find Bluetooth Devices.
- 8 Wait while discoverable Bluetooth devices that are in range are discovered.
- 9 Right-click your T68/T68i phone shown in the list of devices found and select Pair Device.

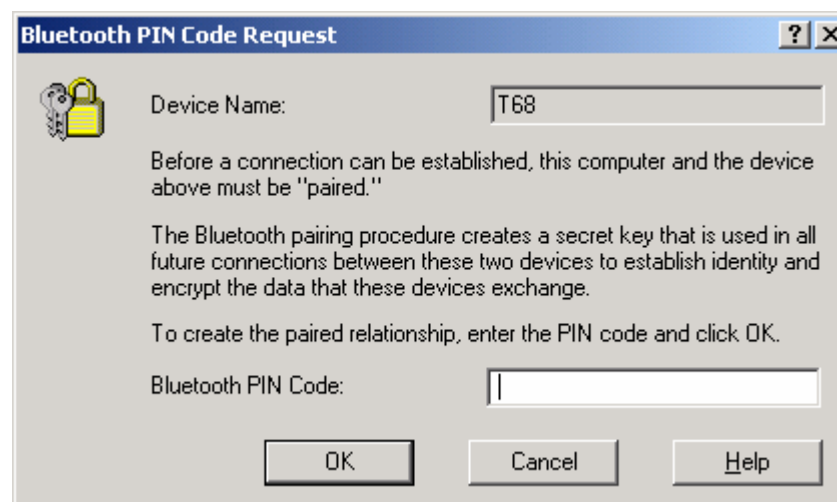

Bluetooth PIN Code Request

- 10 Enter a passkey of your choice (the passkey can be up to 16 characters long and must be numerical).
- 11 Click OK.
- 12 Your Ericsson phone will prompt you to Add to paired devices.
- 13 Press Yes.
- 14 Enter the same passkey on your phone.
- 15 Press Yes.
- 16 Your Ericsson phone will prompt you to edit the name tag. When you are satisfied with the name tag, press Yes.

Sony Ericsson P800

- 1 Tap  and go to Control panel > Connections > Bluetooth.
- 2 Tap Settings and set the Operation mode to Discoverable.
- 3 Double-click My Bluetooth Places on the desktop.
- 4 Double-click Find Bluetooth Devices.
- 5 Wait while discoverable Bluetooth devices that are in range are discovered.
- 6 Right-click your P800 phone shown in the list of devices found and select Pair Device.

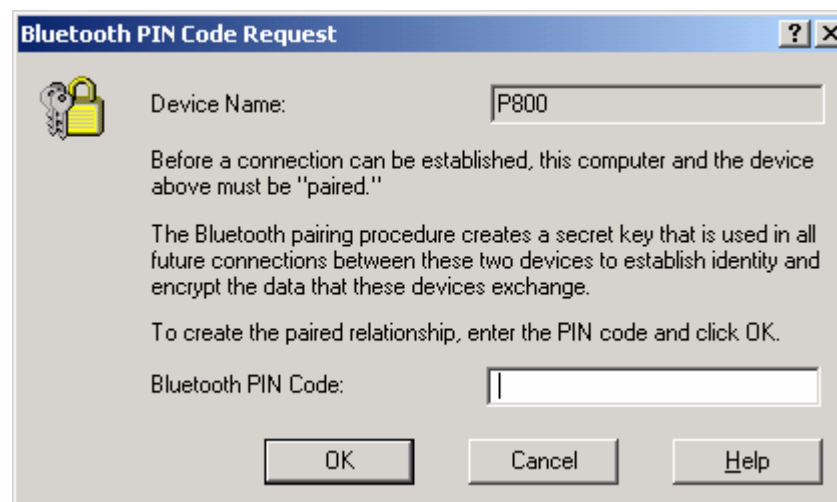

Bluetooth PIN Code Request

- 7 Enter a PIN Code of your choice (the PIN Code can be up to 16 characters long and must be numerical).
- 8 Click OK.
- 9 Enter the same PIN Code (passkey) on your phone.
- 10 Tap Done.

Nokia 6210

The Nokia Connectivity Battery (LRW-1) brings Bluetooth functionality to the Nokia 6210.

Note: You need to check that your 6210 can support the Bluetooth Connectivity Battery.

- *Switch on your Nokia phone with the Connectivity Battery attached. The  icon will be shown briefly in the top left corner of the phone display if the phone can support the Bluetooth Battery.*

- 1 Double-click My Bluetooth Places on the desktop.
- 2 Double-click Find Bluetooth Devices.
- 3 Wait while discoverable Bluetooth devices that are in range are discovered.
- 4 Right-click your Nokia 6210 phone shown in the list of devices found and select Pair Device.

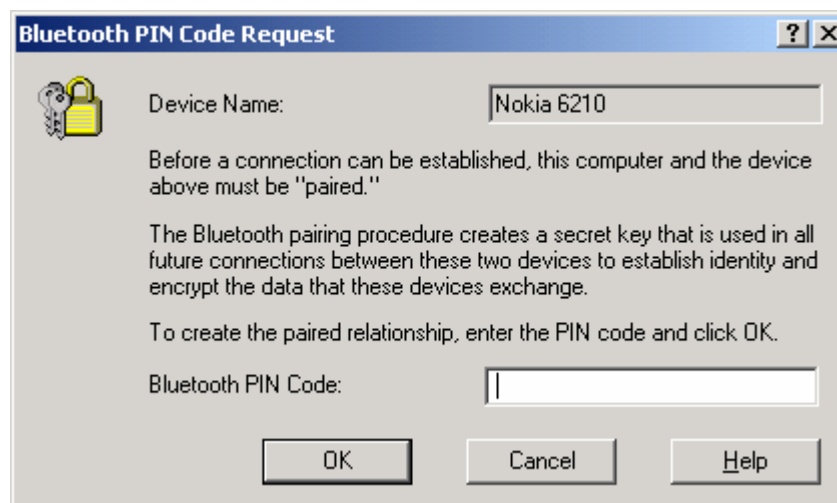

Bluetooth PIN Code Request

- 5 Enter the preset Nokia passkey/PIN Code (indicated on a label supplied with the Connectivity Battery).
- 6 Click OK.

Nokia 6310/6310i

Note: Bluetooth may not be enabled on your Nokia 6310/6310i. If you can see the  icon in the top left corner of the phone display then Bluetooth is enabled. To enable Bluetooth, press Menu and select Bluetooth. Press Select and set Bluetooth to On.

- 1 Double-click My Bluetooth Places on the desktop.
- 2 Double-click Find Bluetooth Devices.
- 3 Wait while discoverable Bluetooth devices that are in range are discovered.
- 4 Right-click your Nokia 6310/6310i phone shown in the list of devices found and select Pair Device.

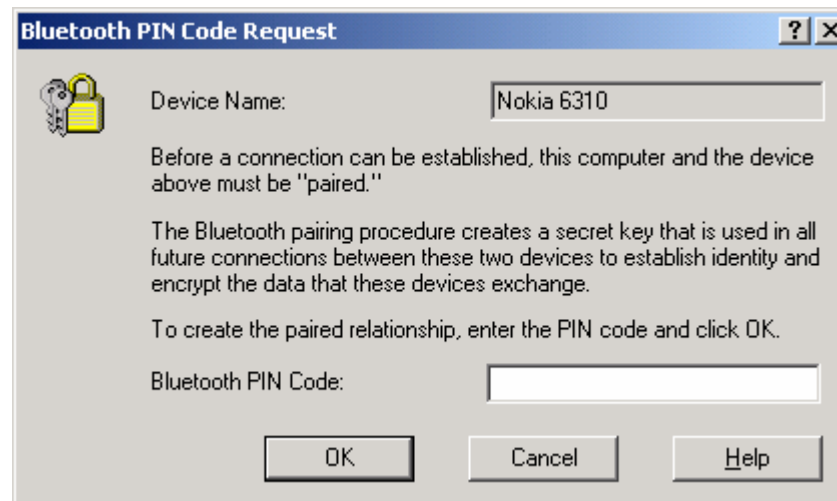

Bluetooth PIN Code Request

- 5 Enter a PIN Code of your choice (the PIN Code can be up to 16 characters long and must be numerical) and click OK.
- 6 When your Nokia phone prompts you about the connection, press Accept.
- 7 Type in the same code on your Nokia phone and press OK.

Note: Each time you attempt to connect to a service on your paired 6310/6310i it will prompt you to Accept or Reject the connection. To turn off this feature press Menu, select Bluetooth and select View paired devices. Highlight the machine you paired with earlier and press Options. Press  and set Request conn. authorisation to No.

Nokia 7650

*Note: Bluetooth may not be enabled on your Nokia 7650. If you can see the * icon near the top right corner of the phone display then Bluetooth is enabled. To enable Bluetooth, press the menu key, select Connect. then Bluetooth. Set Bluetooth to On.*

- 1 Double-click My Bluetooth Places on the desktop.
- 2 Double-click Find Bluetooth Devices.
- 3 Wait while discoverable Bluetooth devices that are in range are discovered.
- 4 Right-click your Nokia 7650 phone shown in the list of devices found and select Pair Device.

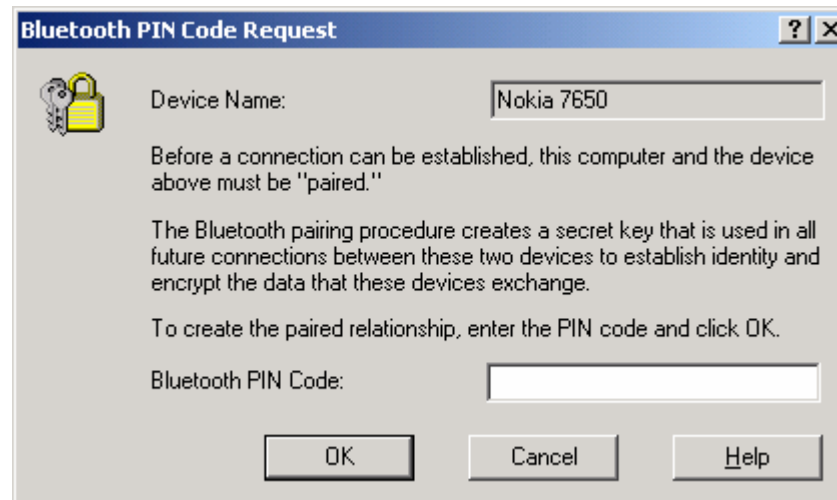

Bluetooth PIN Code Request

- 5 Enter a PIN Code of your choice (the PIN Code can be up to 16 characters long and must be numerical).
- 6 Click OK.
- 7 Type in the same code on your Nokia phone and press OK.

Note: Each time you attempt to connect to a service on your paired phone it will prompt you to Accept the connection request. To turn off this feature go to the Bluetooth menu then Paired devices (📶). Highlight the machine you paired with earlier and press Options. Select Set as authorized and press Yes.

Nokia 8910/8910i

Note: Bluetooth may not be enabled on your Nokia 8910/8910i. If you can see the  icon in the top left corner of the phone display then Bluetooth is enabled. To enable Bluetooth, press Menu and select Bluetooth. Press Select and set Bluetooth to On.

- 1 Double-click My Bluetooth Places on the desktop.
- 2 Double-click Find Bluetooth Devices.
- 3 Wait while discoverable Bluetooth devices that are in range are discovered.
- 4 Right-click your Nokia 8910/8910i phone shown in the list of devices found and select Pair Device.

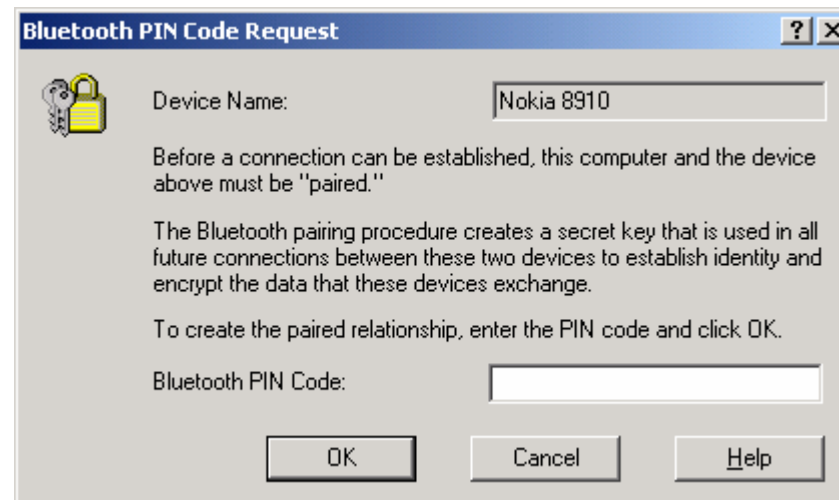

Bluetooth PIN Code Request

- 5 Enter a PIN Code of your choice (the PIN Code/passkey can be up to 16 characters long and must be numerical) and click OK.
- 6 When your Nokia phone prompts you about the connection, press Accept.
- 7 Type in the same passkey on your Nokia phone and press OK.

Note: Each time you attempt to connect to a service on your paired 8910/8910i it will prompt you to Accept or Reject the connection. To turn off this feature press Menu, select Bluetooth and select View paired devices. Highlight the machine you paired with earlier and press Options. Press  and set Request conn. authorisation to No.

HSCSD

High Speed Circuit Switched Data (HSCSD) is an enhancement of Circuit Switched Data (CSD) which is available on current GSM networks. It increases the speed of transmission so you can send and receive information up to three times faster than the current maximum of 9600bps. The HSCSD solution enables higher rates by using multiple channels, allowing subscribers to enjoy faster Internet access and e-mail.

Note: Contact your service provider for details on availability, supported connection rates and to subscribe to this service.

Windows 98/Me

Go to Start, Settings, Control Panel and double-click on Modems. Highlight Bluetooth Modem. Click Properties, Connection and Advanced.

Windows 2000

Go to Start, Settings, Control Panel and double-click on Phone and Modem Options. Click Modems and highlight Bluetooth Modem. Click Properties and then Advanced.

Windows XP

Go to Start, Control Panel and double-click on Phone and Modem Options. Click Modems and highlight Bluetooth Modem. Click Properties and then Advanced.

Add the relevant extra setting in the area provided and click OK.

Nokia 6210/6310/6310i/7650/8910

Connection	Extra Setting
9,600bps	at+chsn=1,0,0,0
14,400bps	at+chsn=2,0,0,0
19,200bps	at+chsn=3,0,0,0
28,800bps	at+chsn=4,0,0,0
43,200bps	at+chsn=6,0,0,0

Ericsson R520m/T39m/T68/T68i/P800

Connection	Extra Setting
9,600bps	at+chsn=1,1,0,4
14,400bps	at+chsn=2,1,0,12
19,200bps	at+chsn=3,2,0,12
28,800bps	at+chsn=4,2,0,12

Frequently Asked Questions

How do I find the Bluetooth Device Address (BDA) of my device?

Right-click on the taskbar Bluetooth Icon and select Advanced Configuration. Click on the Hardware tab. The Bluetooth address will be displayed next to the Device Address.

Why can't I discover a nearby Bluetooth device?

The remote device is probably in non-discoverable mode. Check the status of the device and perform another search when the remote device is in discoverable mode.

Why am I unable to exchange business cards?

Ensure that both Bluetooth devices have default business cards created and selected.

Can other Bluetooth devices access my confidential files?

The Bluetooth specification provides levels of security. By default your machine is discoverable and is sharing one empty folder. This folder can only be accessed by other Bluetooth devices that you have paired with and authorized.

Can I do a device discovery from my 2 machines simultaneously?

Simultaneous device discovery is supported but not recommended as the machines may fail to discover each other.

When I start Windows without my USB Adaptor attached, the

Can I use my Bluetooth headset with my TDK Bluetooth PC Card?

Yes. Full audio support is available in version 1.3.2.7 of the TDK Bluetooth software.

Can I use two Bluetooth profiles at the same time?

Yes, providing the remote equipment supports this feature. Both the USB adaptor and PC card provide this functionality.

Why can't I use dial-up networking and print to my Bluetooth printer at the same time?

Bluetooth currently support two types of configuration, point-to-point and point-to-multipoint.

Point-to-point acts as a cable replacement, allowing you to remove the cable between your headset and your mobile phone, or from your printer to your laptop.

Point-to-multipoint provides the ability to connect eight devices simultaneously, this forms what is referred to as a Piconet. To achieve this one device must be the controller (referred to as the Master) and the other seven devices must be controlled (referred to as the Slaves). As you can imagine this is not a simple task for the Master device and not all devices can perform this role. Also not all profiles can support multipoint connections. In practice only Network Access Profile and the Serial Port Profile support multipoint connections.

Bluetooth tray icon is missing. Where is it?

The Bluetooth tray icon is present when the hardware is attached. It is recommended that you start Windows with the USB Adaptor attached or PC Card inserted.

Technical Support

If you are still experiencing problems please contact your place of purchase or local distributor. Alternatively, for further guidance and up to date product and support information try:

Our website at

www.tdksystems.com

or our helpdesk at

support@tdksystems.com

Regulatory Information

This product complies with any mandatory product specification in any country where the product is sold. In addition, the product complies with the following:

European Union (EU) and EFTA

This equipment complies with the R&TTE directive 1999/5/EC and the following standards:

ETS 300 328-1 V1.2.2 (2000-07)
ETS 300 826 11/1997
EN 60950:1992 + A1:1993, A2:1993,
A3:1995, A4:1997, A11:1997

EU recommendation 1999/519/EC and has been provided with the CE mark accordingly.



Bluetooth

This equipment is qualified according to Bluetooth Core Specification, version 1.1



Special notice for use in France

This product is suitable for indoor use only.

ESD (Electro Static Discharge)

If your TDK Bluetooth device is affected by ESD, it is recommended that you restart any Bluetooth processes that were active at the time.

Copyright and Trademark Notices

Products and brand names may be the trademarks or registered trademarks of their respective owners.

BLUETOOTH is a trademark owned by Bluetooth SIG, Inc, U.S.A. and licensed to TDK Systems Europe Limited.

Safety Statements

Please note the two following Underwriters Laboratories Inc.'s notices:

“This UL Listed ITE Accessory is intended for use with a listed host computer.”

“The long-term characteristics or the possible physiological effects of radio frequency (RF) electromagnetic fields associated with this equipment have not been evaluated.”

In addition:

This device complies with part 15 of the FCC Rules. Operation is subject to the following two conditions:

- (1) This device may not cause harmful interference.
- (2) This device must accept any interference received, including interference that may cause undesired operation.

The radiated output power is far below the FCC Radio frequency exposure limits. Nevertheless, this device should be used in such a manner that the potential for human contact during normal operation is minimized.

Warning: Changes or modifications not expressly approved by the party responsible for compliance could void the user's authority to operate the equipment.

Important Please note the following:

This equipment has been tested and found to comply with the limits for a Class B digital device, pursuant to part 15 of the FCC Rules. These limits are designed to provide reasonable protection against harmful interference in a residential installation. This equipment generates, uses and can radiate radio frequency energy and, if not installed and used in accordance with the instructions, may cause harmful interference to radio communications. However, there is no guarantee that interference will not occur in a particular installation. If this equipment does cause harmful interference to radio or television reception, which can be determined by turning the equipment off and on, the user is encouraged to try to correct the interference by one or more of the following measures:

- Reorient or relocate the receiving antenna.
- Increase the separation between the equipment and receiver.
- Connect the equipment into an outlet on a circuit different from that to which the receiver is connected.
- Consult the dealer or an experienced radio/TV technician for help.

Technical Information

Bluetooth USB Adaptor

Supported operating systems

Windows 98 (Second Edition)
Windows Me (Millennium Edition)
Windows 2000
Windows XP

Power consumption - normal: 35mA
Power consumption - peak: 105mA
Supply voltage: 5V
Operating temperature: 0 - 35°C
Nominal RF output power: 1mW (0dBm)
Maximum RF output power: 2.5mW (4dBm)
Range: up to 10 metres, free space.
Weight: 35g

Bluetooth specification: Version 1.1
Bluetooth power class: 2

Bluetooth PC Card

Supported operating systems

Windows 98 (Second Edition)
Windows Me (Millennium Edition)
Windows 2000
Windows XP

Power consumption - normal: 113mA
Power consumption - peak: 149mA
Supply voltage: 5V
Operating temperature: 0 - 60°C
Nominal RF output power: 1mW (0dBm)
Maximum RF output power: 2.5mW (4dBm)
Range: up to 10 metres, free space.
Weight: 30g

Bluetooth specification: Version 1.1
Bluetooth power class: 2

Glossary

Authentication

Process of verifying the identity of the user at the other end of a link. Authentication is accomplished by using a link key stored in the device memory or by a user PIN (called pairing).

Authorization

Process of deciding if a requesting device is allowed to have access to a service on another device. Authorization always includes authentication.

Bluetooth Device Address

Every Bluetooth transceiver is issued a unique 48-bit Bluetooth Device Address which is used for quite a few algorithms when exchanging data between devices. The Bluetooth Device Address is used for hop sequence generation and many error detection code generation schemes.

Bluetooth Unit

Any device such as a mobile handset, PDA, or PC card that is equipped with suitable Bluetooth hardware needed to establish wireless communication between devices.

Bonding / Pairing

The creation of a semi-permanent (or permanent) relationship between two devices. The relationship is established when the user enters a passkey with the explicit purpose of creating a bond between two devices. This procedure is different from authenticating using a passkey in which the user is requested to enter a passkey during the establishment of a link.

Inquiry / Discovery

Process by which a Bluetooth unit transmits inquiry messages in order to discover the other Bluetooth units that are active within the coverage area. Any Bluetooth unit that received the inquiry message may respond to the inquiring device with information about its Bluetooth unit and its host device.

PIN Code / Passkey

Personal Identification Number. A type of password that is unique to a user.

Piconet

A network of devices connected using Bluetooth technology. A piconet may consist of two to eight devices. In a piconet, there will always be one master while the others are slaves.

Trusted device / Paired device

A device that has been authenticated.

Profiles

Bluetooth software emulates various types of wired links it is designed to replace. Each of these emulations are known as profiles. Examples of profiles are serial port, LAN and dial-up networking.

Warranty

TDK warrants that the Bluetooth USB Adaptor and Bluetooth PC Card products shall conform to TDK's published specifications, which may be subject to change, and remain free from defects in materials and workmanship under normal, proper and intended use for a period of two (2) years from date of purchase, provided that proof of purchase be furnished with any returned equipment.

If, during the warranty period, any component part of the equipment becomes defective by reason of material or workmanship, and TDK is immediately notified of such defect, TDK shall at its option supply a replacement part or request return of equipment, freight prepaid, to its designated facility for repair. In the event that no fault is found on a product returned for repair, TDK reserves the right to charge the customer its standard published repair charge.

This warranty shall not apply to any product that has been subject to misuse, bending, twisting, neglect, alteration, improper installation, operation outside of the parameters of the published specification, use in any non-approved countries or unauthorised repair performed by anyone other than a TDK designated repair facility. Any non-warranty repairs or maintenance shall be at TDK's standard rates in effect at the time.

This warranty is in lieu of all other warranties, whether expressed, implied, or statutory, including but not limited to, implied warranties or merchantability and fitness for a particular purpose. In no event shall TDK be liable, whether in contract, in tort, or on any other basis, for any damage sustained by its customers or any other person arising from or related to loss of use, failure or interruption in the operation of any products, or delay in maintenance, or for incidental, consequential, indirect, or special damages or liabilities, or for loss of revenue, loss of business, or other financial loss arising out of or in connection with the sale, lease, maintenance, use, performance, failure, or interruption of these products.



TDK Systems Europe Ltd
 126 Colindale Avenue
 Colindale, London NW9 5HD
 United Kingdom
 Tel: +44 (0) 20 8938 1000
 Fax: +44 (0) 20 8905 8608
 www.tdksys.com

DECLARATION OF CONFORMITY

We
 [Manufacturer's name and address]

TDK Systems Europe Ltd.
 126 Colindale Avenue
 Colindale
 London NW9 5HD
 United Kingdom

declare under our sole responsibility that the product:
 [Brandname, name and model]

brandname: TDK
 model name: TDK Bluetooth USB Adaptor

To which this declaration relates is in conformity with the following standard(s) or other normative document(s):

ETS 300 328-1 V1.2.2 (2000-07)
 ETS 300 826 11/1997
 EN 60950:1992 + A1:1993, A2:1993, A3:1995, A4:1997, A11:1997
 EU recommendation 1999/519/EC

following the provisions of Directive 1999/5/EC, also known as the "R&TTE Directive".

City: London Date: September 19th, 2001

Name : Peter de Wit Title: Approvals Manager

Signature:



TDK Systems Europe Ltd
 126 Colindale Avenue
 Colindale, London NW9 5HD
 United Kingdom
 Tel: +44 (0) 20 8938 1000
 Fax: +44 (0) 20 8905 8608
 www.tdksys.com

DECLARATION OF CONFORMITY

We
 [Manufacturer's name and address]

TDK Systems Europe Ltd.
 126 Colindale Avenue
 Colindale
 London NW9 5HD
 United Kingdom

declare under our sole responsibility that the product:
 [Brandname, name and model]

brandname: TDK
 model name: TDK Bluetooth PC Card

To which this declaration relates is in conformity with the following standard(s) or other normative document(s):

ETS 300 328-1 V1.2.2 (2000-07)
 ETS 300 826 11/1997
 EN 60950:1992 + A1:1993, A2:1993, A3:1995, A4:1997, A11:1997
 EU recommendation 1999/519/EC

following the provisions of Directive 1999/5/EC, also known as the "R&TTE Directive".

City: London Date: September 19th, 2001

Name : Peter de Wit Title: Approvals Manager

Signature:

