

Remote Control Engine Starter System Owner's Manual

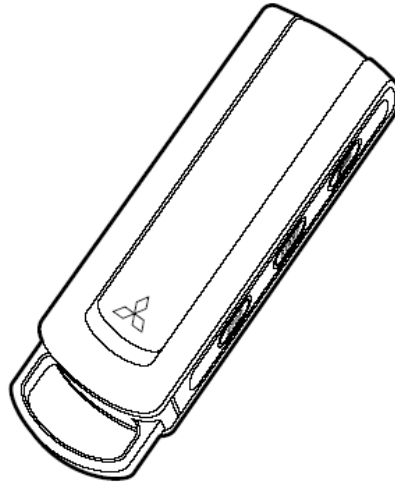

Introduction

1. Introduction	2
2. Features of the System	3
3. Safety Precaution	4
4. Name of each part	6
5. Display	7
6. Operating the Transmitter	8
7. Before Leaving Your Car	12
8. Care and handling	13
9. Replacement of the transmitter batteries	14
10. Troubleshooting	16
11. Specifications	18

Congratulations on your purchase of the MITSUBISHI MOTORS Remote Control Engine Starter System. This system will provide you with convenience and assistance, making each drive a delightful experience.

To take full advantage of your MITSUBISHI MOTORS Remote Control Engine Starter System please read this manual thoroughly.

Keep this manual handy for easy reference.

Please leave this manual in the car equipped with this remote control engine starter system at the time of resale.

Mitsubishi Motors Remote Control Engine Starter System is only for vehicles equipped with an automatic transmission or continuously variable transmission (CVT). Do NOT install Mitsubishi Motors Remote Control Engine Starter System on vehicles with a manual transmission. Ask an authorized Mitsubishi Motors dealer for detail.

1 . Introduction

Safety message

Throughout this manual the words **WARNING** and **CAUTION** appear.

These are reminders to be especially careful. Failure to follow the instructions could result in personal injury or damage to your vehicle.

WARNING

Indicates a strong possibility of severe personal injury or death if instructions are not followed.

CAUTION

Points out hazards or unsafe practices that could cause minor personal injury or damage to your vehicle.

You will see another important symbol;

NOTE Gives helpful information.

General information

- Laws in some communities may restrict the use of remote starters. For example, some laws may require a person using the remote start to have the vehicle in view when doing so. Check local regulations for any requirements on remote starting of vehicles.

- This device complies with part 15 of the FCC Rules.

Operation is subject to the following two conditions:

- (1) this device may not cause harmful interference, and
- (2) this device must accept any interference received, including interference that may cause undesired operation.

- Consult your authorized Mitsubishi Motors dealer for installation of the remote control engine starter system.

CAUTION

-FCC WARNING

Changes or modifications not expressly approved by the party responsible for compliance could void the user's authority to operate the equipment.

- Do not leave the key where it may be exposed to high temperature or high humidity.

- Do not drop the transmitter.

2 . Features of the System

(1) Starting/Stopping the engine

- The remote control engine starter system allows you to start or stop the engine by operating the transmitter from outside of the vehicle without using the vehicle key.
- However, the transmitter will not start the engine unless all of the following conditions are satisfied;
 - The selector lever is in the "P" (Parking) position.
 - All doors (including the rear gate and spare tire carrier, depending on model) are securely closed.
 - The engine hood is securely closed.
 - The vehicle key is removed from the ignition switch.
 - For vehicle equipped with the Free-hand Advanced Security transmitter (F. A. S. T. –key), the ignition switch is in the Lock position.
- The transmitter can stop engine, only when the engine has been started by operating the transmitter.
- If the engine does not start on the first try, the system will automatically try to start the engine again. After the third try, the system will halt.
- The system will not start the engine when the temperature is very low or the battery voltage is below a certain level.
- When the ignition key or switch has not been turned to the ACC, ON or Start position for two weeks or more, the system will deactivate to save the battery. To reactivate the system, turn the ignition switch to the ACC position and then to the Lock position and, if the vehicle is not equipped with the F. A. S. T. –key, remove the key. Wait for three seconds. The system will be reactivated.
- Use only one transmitter for the vehicle. Do not register an additional transmitter.

(2) Once the engine is started

- After starting the engine with the transmitter, the engine will stop if any of following things is done.
 - A door (including the rear gate and spare tire carrier, depending on model) is opened.
 - The gas pedal is applied.
 - The engine hood is opened.
 - The key is inserted into the ignition switch or the ignition switch is turned from the Lock position for a vehicle equipped with F. A. S. T. –key.
- The engine will automatically stop 10 or 30 minutes (the time is set through user's operation of the Remote transmitter in advance) after the engine has been started. Refer to page 10.

3 . Safety Precaution

⚠ WARNING

- Never start the engine by using the remote control engine starter system in a closed or poorly ventilated area. Carbon monoxide gas, which is odorless and extremely poisonous, could build up and cause serious injury or death.

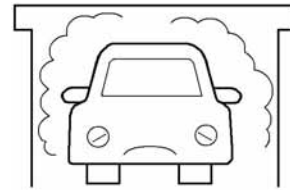

⚠ WARNING

- Do not operate the transmitter for the remote control engine starter system unless you can see your vehicle.
- To prevent accidental engine start, do not touch the transmitter unnecessarily. The transmitter signal may start the engine even from the area where you cannot see the car.



⚠ WARNING

- Do not use the remote engine starting system, when your car is parked on a steep slope.



⚠ WARNING

- To avoid an accident, a child or pet should never be unattended in, or unsupervised around your vehicle, when the engine is remotely started.



⚠ WARNING

- Do not attempt to operate the transmitter when the engine hood is open.



⚠ WARNING

- Do not park your vehicle in areas where combustible materials such as dry grass or leaves can come in contact with a hot exhaust, since a fire could occur.

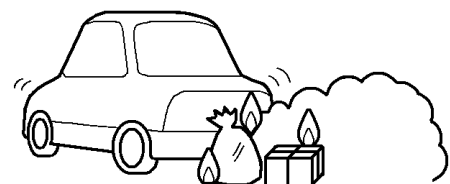

⚠ WARNING

- Do not start the engine without removing the body cover from the car.
It can cause fire.

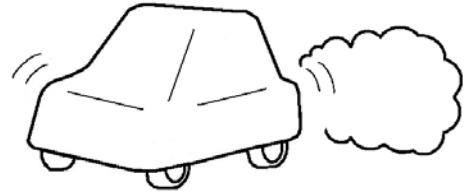

⚠ WARNING

- Store the transmitter in a safe place out of reach of children. There is danger of batteries being swallowed.



⚠ CAUTION

- When parking the vehicle, make sure that the wiper switch and all exterior light switches are turned off and all doors are locked.

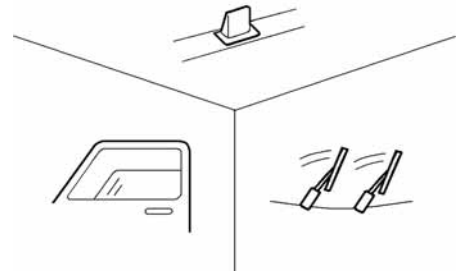

⚠ CAUTION

- Do not disassemble or modify the transmitter.

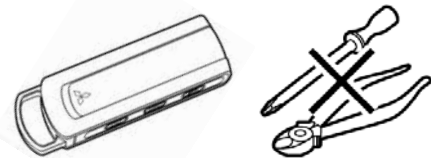

⚠ CAUTION

- Do not wet the Transmitter with water.
It can cause the transmitter to malfunction.

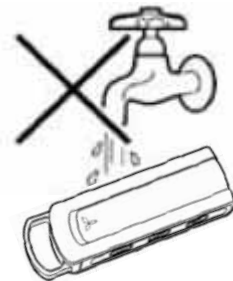

4 . Name of each part

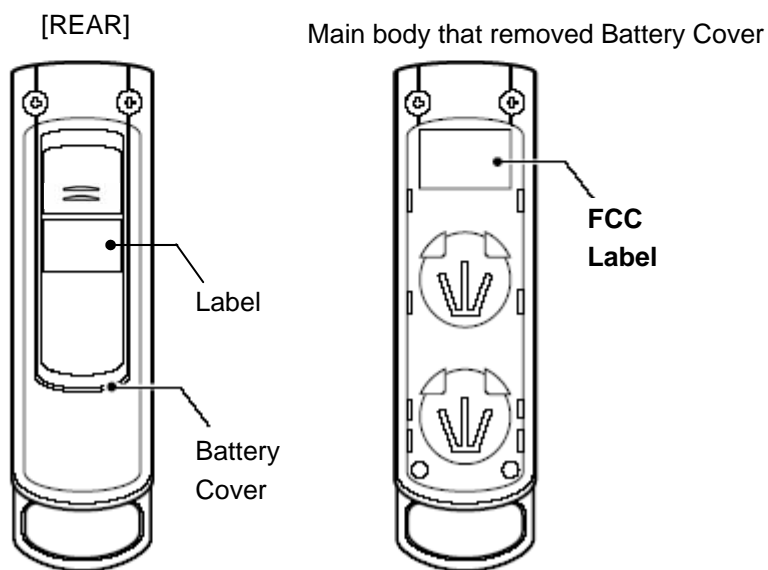
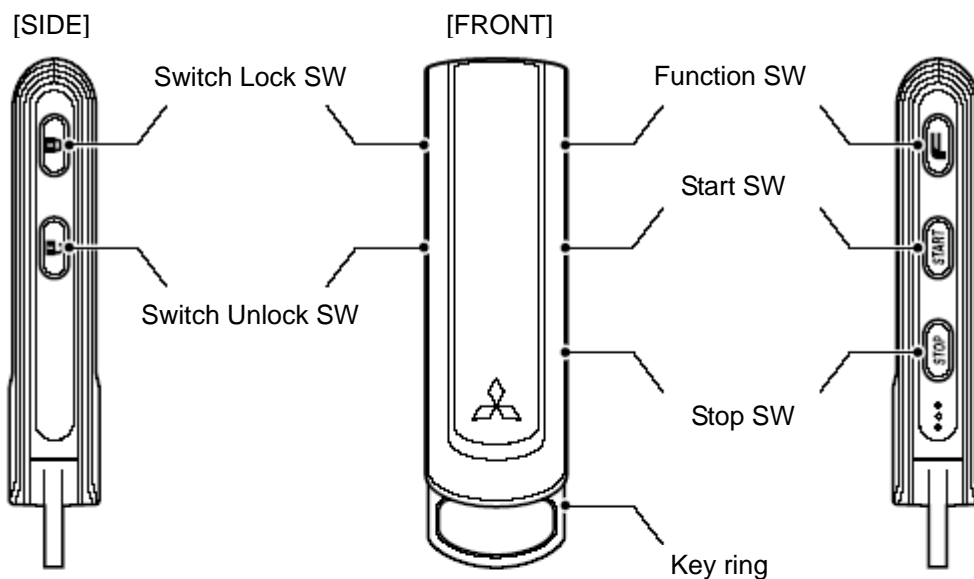







< Confirm method of FCC Label >

Please remove the Battery Cover.

The FCC Label appears when the Battery Cover is removed.

5 . Display



DISPLAY	NAME	MEANING
	Transmission Mark	Lighting when signal transmitted.
	Start Mark	Lighting when the engine start operated.
	Stop Mark	Lighting when the engine stop operated.
	10 minutes Mark	Lighting when idling time setting 10 minutes.
	30 minutes Mark	Lighting when idling time setting 30 minutes.
	Battery Mark	Lighting when battery discharged.
	Switch Lock Mark	Lighting when Switch lock is set.

Refer to each item about details of each operation.

6 . Operating the Transmitter

Before operating the transmitter

Make sure that all conditions listed on page 12 are satisfied.

Starting Engine

- 1 Push Function SW short once.

Start Mark will blink for about 3 seconds as shown in a right figure.

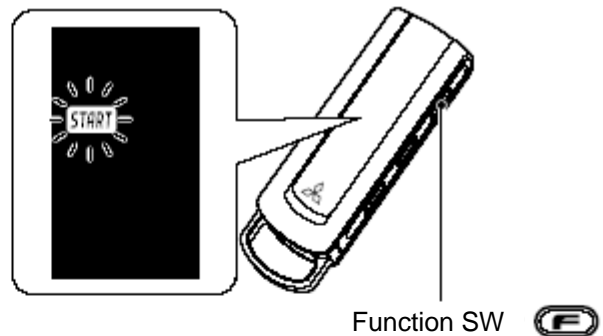

- 2 Push Start SW until buzzer sounds, while Start Mark is blinking.

Either 10minutes Mark or 30minutes Mark, Start Mark and Transmission Mark will stay on as shown in a right figure.

If Start Mark would stop blinking and turned off before pushing Start SW, retry from the pushing Function SW (above "1").

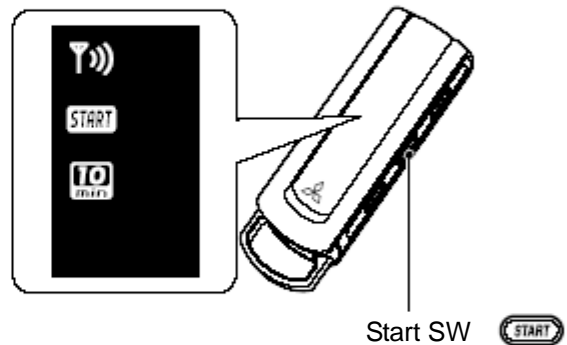

- 3 When the wireless communication between the transmitter and the receiver unit is correctly done, the engine starts.

NOTE

If the engine does not start on the first try, the system will automatically try to start the engine again. After the third try, the system will halt.

Stopping the Engine

- 1 Push Stop SW until buzzer sounds.

Transmission Mark and Stop Mark will stay on as shown in a right figure.

Other engine stop conditions

The engine also stops by any of below conditions.

The engine hood is opened.

The selector lever is not in the "P" position.

Any door is opened.

The key is inserted into the ignition switch or the ignition knob is pushed.

The setting idling time has passed.

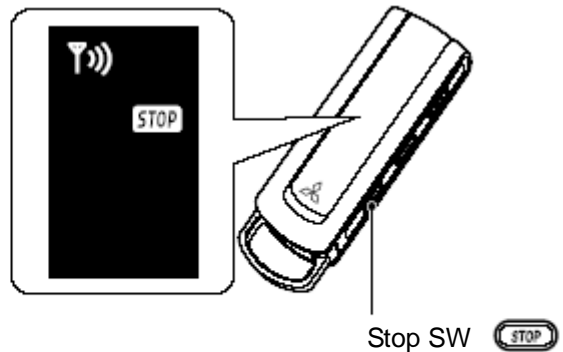

- 2 When the wireless communication between the transmitter and the receiver unit is correctly done, the engine stops.

NOTE

- The range of the transmitter signal varies depending on circumstances, such as surrounding electrical interference.
- When operating the transmitter again, wait for 2 seconds after the indicator has gone out.
- The engine cannot be stopped with the transmitter if the engine has been started with the ignition switch.

To drive the car

Open the door, and get into a car. (The engine will stop at the same time as opening the door.)
Start the engine again by the key.

Setting the idling time

- 1 Push Function SW and Start SW at the same time until buzzer sounds.

10 minutes Mark or 30 minutes Mark will blink according to the present setting .

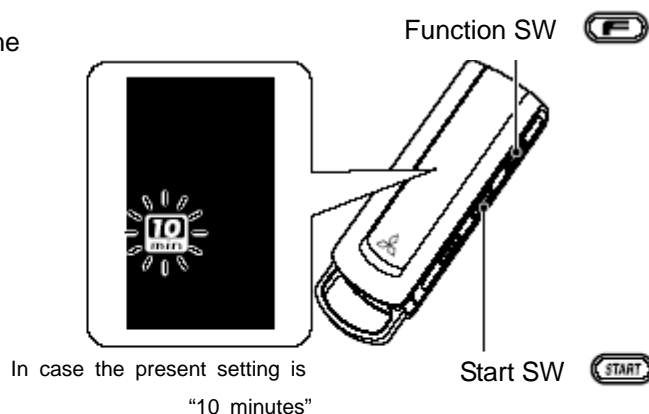

- 2 Push Start SW short, and decide the idling time.

Selected idling time's Mark blinks.

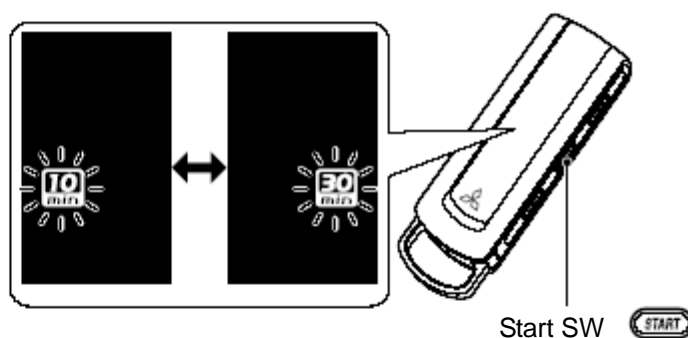

- 3 Push Function SW until buzzer sounds.

The idling time's Mark decided stays on for about 2 seconds.

If the Idling time's Mark would stop blinking and turned off before pushing Function SW, retry from the above "1".

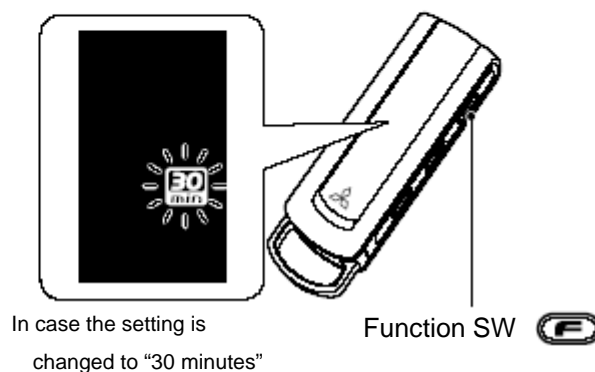

NOTE

Default setting of the Idling time is "10 minutes".

Switch Lock setting and release

This function effects for the prevention of unexpected transmission in trouser pocket, handbag, and so on. The switches of the transmitter are locked and released if the below operation is done.

- 1 Push Function SW and Switch Lock SW at the same time until buzzer sounds.

Switch Lock Mark stays on for about 2 seconds, and Switch Lock is set.

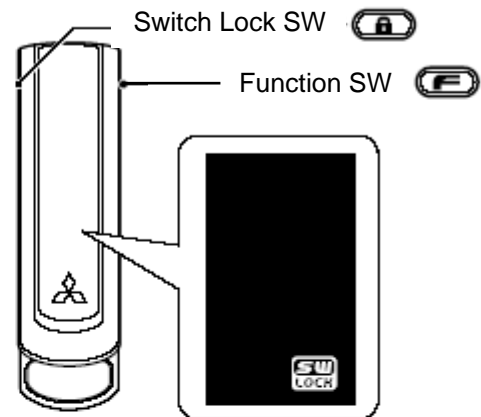

- 2 Push Function SW and Switch Unlock SW at the same time until buzzer sounds.

Switch Lock Mark turns off, and the Switch Lock is released.

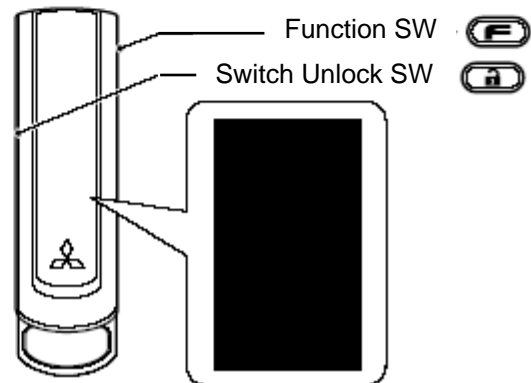

7 . Before Leaving Your Car

When leaving your vehicle, make sure the following conditions are satisfied.

- (1) The selector lever is in the "P" (Parking) position.
- (2) All doors (including the rear gate and spare tire carrier, depending on a model) are securely closed.
- (3) The engine hood is securely closed.
- (4) The vehicle key is removed from the ignition switch.
For vehicle equipped with the Free-hand Advanced Security transmitter (F. A. S. T. -key), the ignition switch is on the Lock position.

The transmitter will not start the engine unless all of the above conditions are satisfied.

CAUTION

When parking the vehicle, make sure that the wiper switch and all exterior light switches are turned off and all doors are locked.

8 . Care and handling

Obey the following notes to prevent a breakdown and an unexpected accident of this system.

⚠ CAUTION

- Store the transmitter in a safe place out of reach of children. Moreover, please contact the shop that purchases it at once when it loses and abnormality is found.
- Do not pass the transmitter for an emergency prevention of accidents when the car is lent to others or the key is entrusted.

Transmitter

- Do not leave it in the hot place (60 or more) such as on the dashboard.
- Do not drop, throw, and step.
- Do not do use or the storage method that water splashes directly. It is likely not to operate normally.
- Never do the resolution and remodeling.

Maintenance of the transmitter

Wipe the Transmitter with a soft cloth dampened with neutral detergent and water solution, then wipe it with a dry cloth to clean.(Do not use solvents such as benzene and thinner.)

Storing the transmitter

Remove the batteries from the Transmitter.

9 . Replacement of the transmitter batteries

The Battery Mark on the display stays on when any switch is operated, while the battery is discharged.

In this case, exchange it for 2 pieces new battery at the same time.

Especially, the battery performance decreases at the low temperature.

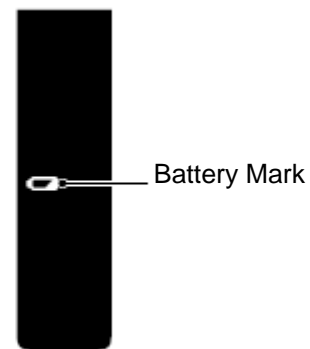

Battery Replacement

1 Slide the Battery Cover grip, and gently detach the Battery Cover from the transmitter.

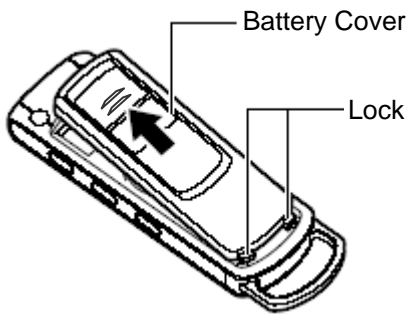

3 Attach the Battery Cover.

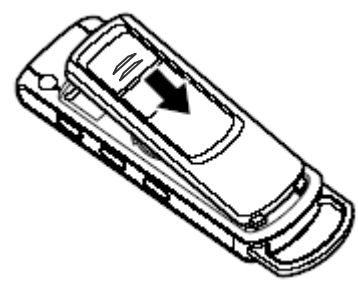

2 Remove two old batteries, and insert two new lithium coin CR2032 batteries with the + mark facing up.

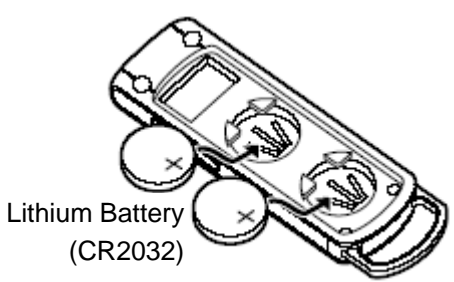

NOTE

Wipe the new batteries with a dry and clean cloth.

 *WARNING*

- Store the batteries out of reach of children especially. If a child accidentally swallows it, give him/her medical treatment immediately.
- Do not hold batteries with metallic tools, such as tweezers. It can short-circuit the batteries and may generate heat.
- Do not disassemble, heat or throw the removed batteries in fire. This may cause explosion, etc.

10 . Troubleshooting

When the transmitter does not start/stop the engine, check the following before consulting your dealer.

Engine does not start by operating the transmitter.

【Switch Lock Mark stays on.】

Check	Remedy
When the switch of the transmitter is pushed, does the Switch Lock Mark stay on?	Release Switch Lock. Refer to page 11, "Switch Lock setting and release".

【Battery Mark stays on.】

Check	Remedy
When the switch of the transmitter is pushed, does the Battery Mark stay on?	Replace them to new batteries. Refer to page 14, "Replacement of the transmitter batteries".

【The Marks on display of the transmitter do not flash or stay on.】

Check	Remedy
Do you operate the transmitter within 2 seconds after trying to start/stop the engine?	Wait for 2 seconds or more before next operation. The transmitter does not send signal in 2 seconds after trying to start/stop the engine.
Are the transmitter batteries correctly set?	Place the batteries correctly. Refer to page 14, "Replacement of the transmitter batteries".
Are the transmitter batteries discharged?	Replace them to new batteries. Refer to page 14, "Replacement of the transmitter batteries".

【The Marks on display of the transmitter flash and stay on.】

Check	Remedy
Are all four conditions to start the engine listed on page 12 satisfied?	Satisfy all four condition listed on page 12.
Is the vehicle too away to receive the transmitter signal?	Approach to the vehicle, and then use the transmitter.
Has the vehicle been parked for two weeks or more?	Turn the ignition switch to the ACC position and then to the Lock position and, if the vehicle is not equipped with the F. A. S. T. -key, remove the key. Wait for three seconds or more. The system will be reactivated.

The engine does not stop by the Transmitter.

Check	Remedy
Is the vehicle too away to receive the transmitter signal?	Approach to the vehicle, and then use the transmitter.
Has the engine started by the ignition switch?	Stop the engine by ignition switch. The transmitter can stop engine, only when the engine has been started by operating the transmitter.

The distance that can be operated is short.

Check	Remedy
Are the transmitter batteries discharged?	Replace them to new batteries. Refer to page 14, "Replacement of the transmitter batteries".

The range of the transmitter signal varies depending on circumstance, such as surrounding electrical interference.

If the above remedies cannot solve your problem, please consult your authorized Mitsubishi Motors dealer.

1 1 . Specifications

Transmitter	
Communication frequency	426.0500MHz
Communication method	uni-directional (transmission.)
Application standard	FCC conforming
Transmission time	approximately 3 seconds
Transmission rest time	Two seconds or more
Transmission antenna	Built-in antenna
batteries	Coin type lithium battery CR2032 (2 pieces)
Battery life	Transmit 2000 times or more
case sizes	97.0×30.0×18.0mm
Weight	Approximately 46g

Main Unit(Receiver)	
Communication frequency	426.0500MHz
Communication method	uni-directional (receiving)
Receiving antenna	Coaxial cable whip antenna
Operation power-supply voltage	DC10V ~ 16V
Current consumption at standby	10mA or less (3mA or less at sleep mode)
Size of case	130.0×93.0×28.0mm
Weight	Approximately 200g

Control Unit	
Communication frequency	315MHz
Communication method	uni-directional communication
Application standard	FCC conforming
Transmission time	approximately. 1.1 seconds
Transmission antenna	Built-in antenna
Operation power-supply voltage	DC10V ~ 16V
Current consumption at standby	1mA or less
Size of case	63.1×39×29mm
Weight	Approximately 35g

: may not be equipped according to the vehicle.