

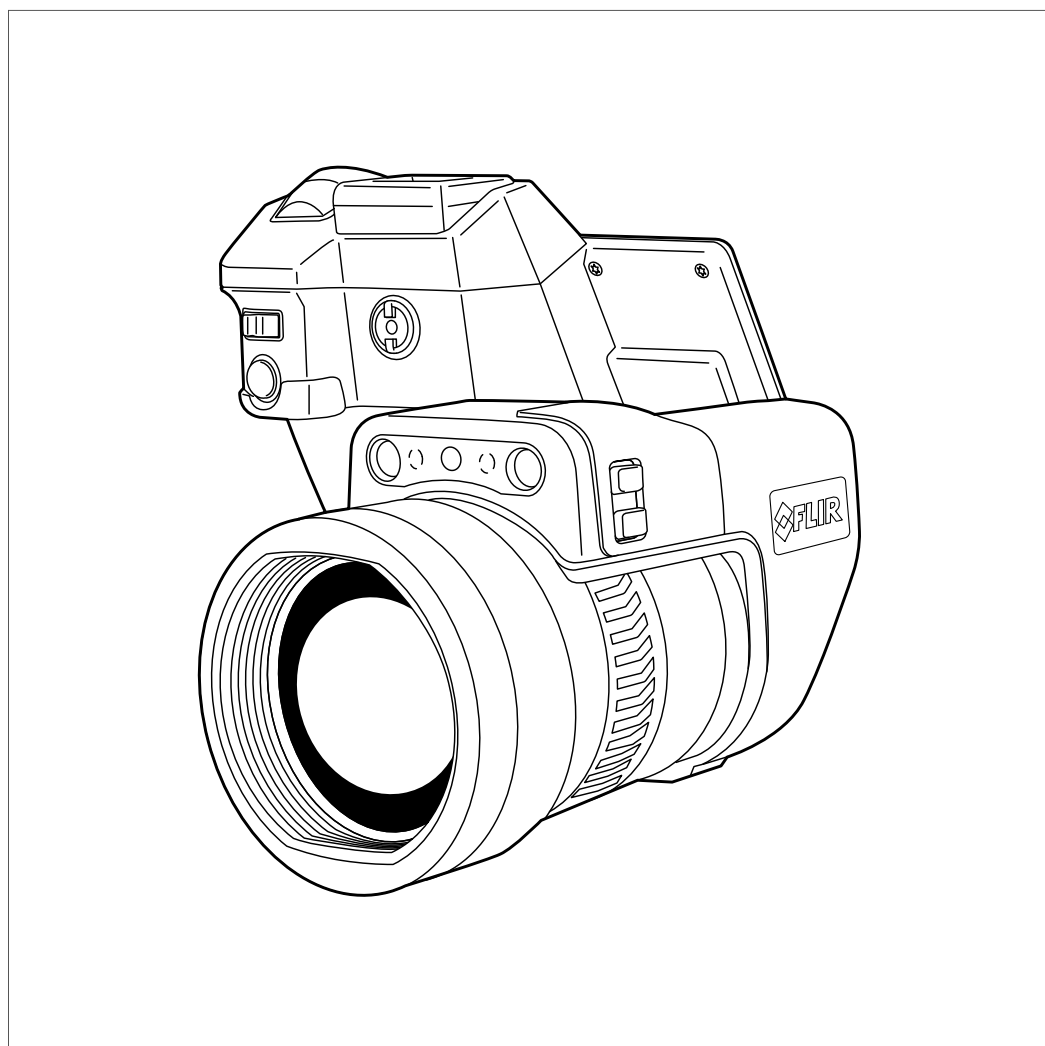

User's manual FLIR T10xx series



Important note

Before operating the device, you must read, understand, and follow all instructions, warnings, cautions, and legal disclaimers.

Důležitá poznámka

Před použitím zařízení si přečtěte veškeré pokyny, upozornění, varování a vyvázání se ze záruky, ujistěte se, že jim rozumíte, a řiďte se jimi.

Viktig meddelelse

Før du betjener enheden, skal du læse, forstå og følge alle anvisninger, advarsler, sikkerhedsforanstaltninger og ansvarsfraskrivelser.

Wichtiger Hinweis

Bevor Sie das Gerät in Betrieb nehmen, lesen, verstehen und befolgen Sie unbedingt alle Anweisungen, Warnungen, Vorsichtshinweise und Haftungsausschlüsse

Σημαντική σημείωση

Πριν από τη λειτουργία της συσκευής, πρέπει να διαβάσετε, να κατανοήσετε και να ακολουθήσετε όλες τις οδηγίες, προειδοποιήσεις, προφυλάξεις και νομικές αποποιήσεις.

Nota importante

Antes de usar el dispositivo, debe leer, comprender y seguir toda la información sobre instrucciones, advertencias, precauciones y renunciaciones de responsabilidad.

Tärkeä huomautus

Ennen laitteen käyttämistä on luettava ja ymmärrettävä kaikki ohjeet, vakavat varoitukset, varoitukset ja lakitiedotteet sekä noudatettava niitä.

Remarque importante

Avant d'utiliser l'appareil, vous devez lire, comprendre et suivre l'ensemble des instructions, avertissements, mises en garde et clauses légales de non-responsabilité.

Fontos megjegyzés

Az eszköz használatá elött figyelmesen olvassa el és tartsa be az összes utasítást, figyelmeztetést, óvintézkedést és jogi nyilatkozatot.

Nota importante

Prima di utilizzare il dispositivo, è importante leggere, capire e seguire tutte le istruzioni, avvertenze, precauzioni ed esclusioni di responsabilità legali.

重要な注意

デバイスをご使用になる前に、あらゆる指示、警告、注意事項、および免責条項をお読み頂き、その内容を理解して従ってください。

중요한 참고 사항

장치를 작동하기 전에 반드시 다음의 사용 설명서와 경고, 주의사항, 법적 책임제한을 읽고 이해하며 따라야 합니다.

Viktig

Før du bruker enheten, må du lese, forstå og følge instruksjoner, advarsler og informasjon om ansvarsfraskrivelse.

Belangrijke opmerking

Zorg ervoor dat u, voordat u het apparaat gaat gebruiken, alle instructies, waarschuwingen en juridische informatie hebt doorgelezen en begrepen, en dat u deze opvolgt en in acht neemt.

Ważna uwaga

Przed rozpoczęciem korzystania z urządzenia należy koniecznie zapoznać się z wszystkimi instrukcjami, ostrzeżeniami, przestrożami i uwagami prawnymi. Należy zawsze postępować zgodnie z zaleceniami tam zawartymi.

Nota importante

Antes de utilizar o dispositivo, deverá proceder à leitura e compreensão de todos os avisos, precauções, instruções e isenções de responsabilidade legal e assegurar-se do seu cumprimento.

Важное примечание

До того, как пользоваться устройством, вам необходимо прочитать и понять все предупреждения, предостережения и юридические ограничения ответственности и следовать им.

Viktig information

Innan du använder enheten måste du läsa, förstå och följa alla anvisningar, varningar, försiktighetsåtgärder och ansvarsfriskrivningar.

Önemli not

Cihazı çalıştırmadan önce tüm talimatları, uyarıları, ikazları ve yasal açıklamaları okumalı, anlamalı ve bunlara uymalısınız.

重要注意事項

在操作设备之前，您必须阅读、理解并遵循所有说明、警告、注意事项和法律免责声明。

重要注意事項

操作裝置之前，您務必閱讀、了解並遵循所有說明、警告、注意事項與法律免責聲明。



User's manual FLIR T10xx series



Table of contents

1	Disclaimers	1
1.1	Legal disclaimer	1
1.2	Usage statistics	1
1.3	Changes to registry	1
1.4	U.S. Government Regulations	2
1.5	Copyright	2
1.6	Quality assurance	2
1.7	Patents	2
1.8	Third-party licenses	2
1.8.1	GNU Lesser General Public License (LGPL)	2
1.8.2	Fonts (Source Han Sans)	3
1.8.3	Fonts (DejaVu)	3
2	Safety information	4
3	Notice to user	8
3.1	User-to-user forums	8
3.2	Calibration	8
3.3	Accuracy	8
3.4	Disposal of electronic waste	8
3.5	Training	8
3.6	Documentation updates	8
3.7	Important note about this manual	8
3.8	Note about authoritative versions	8
4	Customer help	9
4.1	General	9
4.2	Submitting a question	9
4.3	Downloads	10
5	Introduction	11
5.1	General description	11
5.2	Key benefits	11
6	Quick start guide	12
6.1	Procedure	12
7	A note about ergonomics	13
7.1	General	13
7.2	Figure	13
8	Camera parts	14
8.1	View from the right	14
8.1.1	Figure	14
8.1.2	Explanation	14
8.2	View from the left	14
8.2.1	Figure	14
8.2.2	Explanation	14
8.3	View from the bottom	15
8.3.1	Figure	15
8.3.2	Explanation	15
8.4	View from the rear	16
8.4.1	Figure	16
8.4.2	Explanation	16
8.5	Neck strap attachment points	17
8.5.1	Figure	17
8.6	Battery condition LED indicator	17
8.6.1	Figure	17
8.6.2	Explanation	17
8.7	Power LED indicator	18
8.7.1	Figure	18

Table of contents

	8.7.2	Explanation.....	18
8.8		Laser pointer	18
	8.8.1	Figure.....	18
	8.8.2	Laser warning label.....	19
	8.8.3	Laser rules and regulations	19
9		Screen elements	20
	9.1	Figure	20
	9.2	Explanation	20
	9.3	Status icons and indicators	20
	9.4	Image overlay information.....	21
10		Navigating the menu system.....	22
	10.1	General	22
	10.2	Navigating using the joystick	22
11		Handling the camera.....	23
	11.1	Charging the battery.....	23
		11.1.1 Using the power supply to charge the battery	23
		11.1.2 Using the stand-alone battery charger to charge the battery	23
	11.2	Turning on the camera	23
		11.2.1 Procedure	23
	11.3	Turning off the camera	23
		11.3.1 Procedure	23
	11.4	Adjusting the viewfinder's dioptic correction	24
		11.4.1 Figure.....	24
		11.4.2 Procedure	24
	11.5	Adjusting the angle of the lens	25
		11.5.1 Figure.....	25
	11.6	Adjusting the infrared camera focus manually	25
		11.6.1 Figure.....	25
		11.6.2 Procedure	25
	11.7	Autofocusing the infrared camera	26
		11.7.1 General.....	26
		11.7.2 Figure.....	26
		11.7.3 Procedure	26
	11.8	Continuous autofocus	26
		11.8.1 General.....	26
		11.8.2 Procedure	27
	11.9	Operating the laser pointer.....	27
		11.9.1 Figure.....	28
		11.9.2 Procedure	28
	11.10	Using the digital zoom function	28
		11.10.1 General.....	28
		11.10.2 Figure.....	29
		11.10.3 Procedure	29
	11.11	Assigning functions to the programmable buttons	29
		11.11.1 General.....	29
		11.11.2 Procedure	30
	11.12	Using the camera lamp as a flash	30
		11.12.1 General.....	30
		11.12.2 Procedure	30
	11.13	Changing lenses.....	30
	11.14	Using the close-up lens.....	32
		11.14.1 General.....	32
		11.14.2 Attaching the close-up lens	33
		11.14.3 Removing the close-up lens.....	34

Table of contents

11.15	Changing the viewfinder eyecup.....	36
11.16	Calibrating the compass.....	38
11.16.1	Procedure.....	38
12	Saving and working with images.....	39
12.1	About image files.....	39
12.1.1	General.....	39
12.1.2	File-naming convention.....	39
12.1.3	Image capacity.....	39
12.1.4	About UltraMax.....	39
12.2	Saving an image.....	39
12.2.1	General.....	39
12.2.2	Procedure.....	39
12.3	Previewing an image.....	40
12.3.1	General.....	40
12.3.2	Procedure.....	40
12.4	Opening a saved image.....	40
12.4.1	General.....	40
12.4.2	Procedure.....	40
12.5	Editing a saved image.....	41
12.5.1	General.....	41
12.5.2	Procedure.....	41
12.5.3	Related topics.....	41
12.6	Creating a PDF report in the camera.....	41
12.6.1	General.....	41
12.6.2	Naming convention.....	41
12.6.3	Procedure.....	41
12.7	Deleting an image.....	42
12.7.1	General.....	42
12.7.2	Procedure.....	42
12.8	Deleting multiple images.....	42
12.8.1	General.....	42
12.8.2	Procedure.....	42
12.9	Deleting all images.....	42
12.9.1	General.....	42
12.9.2	Procedure.....	43
12.10	Resetting the image counter.....	43
12.10.1	General.....	43
12.10.2	Procedure.....	43
13	Achieving a good image.....	44
13.1	General.....	44
13.2	Adjusting the infrared camera focus.....	44
13.3	Adjusting the infrared image.....	44
13.3.1	General.....	44
13.3.2	Example 1.....	45
13.3.3	Example 2.....	45
13.3.4	Manual adjustment in <i>Level, Span</i> mode.....	45
13.3.5	Manual adjustment in <i>Level, Max, Min</i> mode.....	46
13.4	Changing the temperature range.....	46
13.4.1	General.....	46
13.4.2	Procedure.....	46
13.5	Changing the color palette.....	47
13.5.1	General.....	47
13.5.2	Procedure.....	47
13.6	Changing the object parameters.....	48
13.7	Calibrating the camera.....	48

Table of contents

	13.7.1	General.....	48
	13.7.2	Manual calibration.....	48
	13.8	Hiding all overlay.....	48
	13.8.1	General.....	48
	13.8.2	Procedure.....	49
14		Working with image modes.....	50
	14.1	General.....	50
	14.2	Image examples.....	50
	14.3	Selecting the image mode.....	51
15		Working with measurement tools.....	52
	15.1	General.....	52
	15.2	Adding/removing measurement tools.....	52
	15.3	Working with user presets.....	52
	15.3.1	General.....	52
	15.3.2	Procedure.....	52
	15.4	Resizing or moving a measurement tool.....	53
	15.4.1	General.....	53
	15.4.2	Procedure.....	53
	15.5	Changing object parameters.....	54
	15.5.1	General.....	54
	15.5.2	Types of parameters.....	54
	15.5.3	Recommended values.....	54
	15.5.4	Procedure.....	54
	15.5.5	Related topics.....	56
	15.6	Displaying values in the result table and displaying a graph.....	56
	15.6.1	General.....	56
	15.6.2	Procedure.....	56
	15.7	Creating and setting up a difference calculation.....	57
	15.7.1	General.....	57
	15.7.2	Procedure.....	57
	15.8	Setting a measurement alarm.....	57
	15.8.1	General.....	57
	15.8.2	Types of alarm.....	57
	15.8.3	Alarm signals.....	58
	15.8.4	Procedure.....	58
16		Working with color alarms and isotherms.....	60
	16.1	Color alarms.....	60
	16.1.1	General.....	60
	16.1.2	Image examples.....	60
	16.2	Setting up above, below, and interval alarms.....	61
	16.3	Building isotherms.....	62
	16.3.1	About the <i>Condensation alarm</i>	62
	16.3.2	About the <i>Insulation alarm</i>	62
	16.3.3	Setting up condensation and insulation alarms.....	62
17		Annotating images.....	63
	17.1	General.....	63
	17.2	Adding a note.....	63
	17.2.1	General.....	63
	17.2.2	Procedure.....	63
	17.3	Adding a table.....	63
	17.3.1	General.....	63
	17.3.2	Procedure.....	64
	17.4	Adding a voice annotation.....	64
	17.4.1	General.....	64
	17.4.2	Procedure.....	65

Table of contents

17.5	Adding a sketch.....	65
17.5.1	General.....	65
17.5.2	Procedure	65
18	Programming the camera (time lapse)	67
18.1	General	67
18.2	Procedure	67
19	Recording video clips	68
19.1	General	68
19.2	Procedure	68
20	Screening alarm	69
20.1	General	69
20.2	Procedure	69
21	Pairing Bluetooth devices.....	70
21.1	General	70
21.2	Procedure	70
22	Configuring Wi-Fi	71
22.1	General	71
22.2	Setting up a wireless access point (most common use)	71
22.3	Connecting the camera to a wireless local area network (less common use).....	71
23	Changing settings	72
23.1	General	72
23.1.1	<i>Define user presets</i>	<i>72</i>
23.1.2	<i>Camera temperature range</i>	<i>72</i>
23.1.3	<i>Save options & storage.....</i>	<i>72</i>
23.1.4	<i>Programmable buttons</i>	<i>73</i>
23.1.5	<i>Device settings</i>	<i>74</i>
23.2	Procedure	76
24	Technical data.....	77
24.1	Online field-of-view calculator	77
24.2	Note about technical data	77
24.3	Note about authoritative versions.....	77
24.4	FLIR T1020 12°	78
24.5	FLIR T1020 28°	83
24.6	FLIR T1020 45°	88
24.7	FLIR T1030sc 12°	93
24.8	FLIR T1030sc 28°	98
24.9	FLIR T1030sc 45°	103
24.10	FLIR T1040 12°	108
24.11	FLIR T1040 28°	113
24.12	FLIR T1040 45°	118
24.13	FLIR T1050sc 12°	123
24.14	FLIR T1050sc 28°	128
24.15	FLIR T1050sc 45°	133
25	Mechanical drawings	138
26	Cleaning the camera.....	145
26.1	Camera housing, cables, and other items.....	145
26.1.1	Liquids.....	145
26.1.2	Equipment.....	145
26.1.3	Procedure	145
26.2	Infrared lens	145
26.2.1	Liquids.....	145
26.2.2	Equipment.....	145
26.2.3	Procedure	145

Table of contents

26.3	Infrared detector	145
26.3.1	General.....	145
26.3.2	Procedure	146
27	Application examples.....	147
27.1	Moisture & water damage	147
27.1.1	General.....	147
27.1.2	Figure.....	147
27.2	Faulty contact in socket.....	147
27.2.1	General.....	147
27.2.2	Figure.....	147
27.3	Oxidized socket.....	148
27.3.1	General.....	148
27.3.2	Figure.....	148
27.4	Insulation deficiencies.....	149
27.4.1	General.....	149
27.4.2	Figure.....	149
27.5	Draft	150
27.5.1	General.....	150
27.5.2	Figure.....	150
28	About FLIR Systems	151
28.1	More than just an infrared camera	152
28.2	Sharing our knowledge	152
28.3	Supporting our customers.....	152
28.4	A few images from our facilities	153
29	Glossary	154
30	Thermographic measurement techniques	157
30.1	Introduction	157
30.2	Emissivity.....	157
30.2.1	Finding the emissivity of a sample.....	157
30.3	Reflected apparent temperature.....	160
30.4	Distance	160
30.5	Relative humidity	160
30.6	Other parameters.....	160
31	History of infrared technology.....	162
32	Theory of thermography.....	165
32.1	Introduction	165
32.2	The electromagnetic spectrum.....	165
32.3	Blackbody radiation.....	165
32.3.1	Planck's law	166
32.3.2	Wien's displacement law.....	167
32.3.3	Stefan-Boltzmann's law	168
32.3.4	Non-blackbody emitters.....	169
32.4	Infrared semi-transparent materials.....	171
33	The measurement formula.....	172
34	Emissivity tables	176
34.1	References.....	176
34.2	Tables	176

Disclaimers

1.1 Legal disclaimer

All products manufactured by FLIR Systems are warranted against defective materials and workmanship for a period of one (1) year from the delivery date of the original purchase, provided such products have been under normal storage, use and service, and in accordance with FLIR Systems instruction.

Uncooled handheld infrared cameras manufactured by FLIR Systems are warranted against defective materials and workmanship for a period of two (2) years from the delivery date of the original purchase, provided such products have been under normal storage, use and service, and in accordance with FLIR Systems instruction, and provided that the camera has been registered within 60 days of original purchase.

Detectors for uncooled handheld infrared cameras manufactured by FLIR Systems are warranted against defective materials and workmanship for a period of ten (10) years from the delivery date of the original purchase, provided such products have been under normal storage, use and service, and in accordance with FLIR Systems instruction, and provided that the camera has been registered within 60 days of original purchase.

Products which are not manufactured by FLIR Systems but included in systems delivered by FLIR Systems to the original purchaser, carry the warranty, if any, of the particular supplier only. FLIR Systems has no responsibility whatsoever for such products.

The warranty extends only to the original purchaser and is not transferable. It is not applicable to any product which has been subjected to misuse, neglect, accident or abnormal conditions of operation. Expendable parts are excluded from the warranty.

In the case of a defect in a product covered by this warranty the product must not be further used in order to prevent additional damage. The purchaser shall promptly report any defect to FLIR Systems or this warranty will not apply.

FLIR Systems will, at its option, repair or replace any such defective product free of charge if, upon inspection, it proves to be defective in material or workmanship and provided that it is returned to FLIR Systems within the said one-year period.

FLIR Systems has no other obligation or liability for defects than those set forth above.

No other warranty is expressed or implied. FLIR Systems specifically disclaims the implied warranties of merchantability and fitness for a particular purpose.

FLIR Systems shall not be liable for any direct, indirect, special, incidental or consequential loss or damage, whether based on contract, tort or any other legal theory.

This warranty shall be governed by Swedish law.

Any dispute, controversy or claim arising out of or in connection with this warranty, shall be finally settled by arbitration in accordance with the Rules of the Arbitration Institute of the Stockholm Chamber of Commerce. The place of arbitration shall be Stockholm. The language to be used in the arbitral proceedings shall be English.

1.2 Usage statistics

FLIR Systems reserves the right to gather anonymous usage statistics to help maintain and improve the quality of our software and services.

1.3 Changes to registry

The registry entry HKEY_LOCAL_MACHINE\SYSTEM\CurrentControlSet\Control\Lsa\LmCompatibilityLevel will be automatically changed to level 2 if the FLIR Camera Monitor service detects a FLIR camera connected to the computer with a USB cable. The modification will only be executed if the camera device implements a remote network service that supports network logons.

1.4 U.S. Government Regulations

This product may be subject to U.S. Export Regulations. Please send any inquiries to exportquestions@flir.com.

1.5 Copyright

© 2015, FLIR Systems, Inc. All rights reserved worldwide. No parts of the software including source code may be reproduced, transmitted, transcribed or translated into any language or computer language in any form or by any means, electronic, magnetic, optical, manual or otherwise, without the prior written permission of FLIR Systems.

The documentation must not, in whole or part, be copied, photocopied, reproduced, translated or transmitted to any electronic medium or machine readable form without prior consent, in writing, from FLIR Systems.

Names and marks appearing on the products herein are either registered trademarks or trademarks of FLIR Systems and/or its subsidiaries. All other trademarks, trade names or company names referenced herein are used for identification only and are the property of their respective owners.

1.6 Quality assurance

The Quality Management System under which these products are developed and manufactured has been certified in accordance with the ISO 9001 standard.

FLIR Systems is committed to a policy of continuous development; therefore we reserve the right to make changes and improvements on any of the products without prior notice.

1.7 Patents

One or several of the following patents and/or design patents may apply to the products and/or features. Additional pending patents and/or pending design patents may also apply.

000279476-0001; 000439161; 000499579-0001; 000653423; 000726344; 000859020; 001106306-0001; 001707738; 001707746; 001707787; 001776519; 001954074; 002021543; 002058180; 002249953; 002531178; 0600574-8; 1144833; 1182246; 1182620; 1285345; 1299699; 1325808; 1336775; 1391114; 1402918; 1404291; 1411581; 1415075; 1421497; 1458284; 1678485; 1732314; 2106017; 2107799; 2381417; 3006596; 3006597; 466540; 483782; 484155; 4889913; 5177595; 60122153.2; 602004011681.5-08; 6707044; 68657; 7034300; 7110035; 7154093; 7157705; 7237946; 7312822; 7332716; 7336823; 7544944; 7667198; 7809258 B2; 7826736; 8,153,971; 8,823,803; 8,853,631; 8018649 B2; 8212210 B2; 8289372; 8354639 B2; 8384783; 8520970; 8565547; 8595689; 8599262; 8654239; 8680468; 8803093; D540838; D549758; D579475; D584755; D599,392; D615,113; D664,580; D664,581; D665,004; D665,440; D677298; D710,424 S; D718801; DI6702302-9; DI6903617-9; DI7002221-6; DI7002891-5; DI7002892-3; DI7005799-0; DM/057692; DM/061609; EP 2115696 B1; EP2315433; SE 0700240-5; US 8340414 B2; ZL 201330267619.5; ZL01823221.3; ZL01823226.4; ZL02331553.9; ZL02331554.7; ZL200480034894.0; ZL200530120994.2; ZL200610088759.5; ZL200630130114.4; ZL200730151141.4; ZL200730339504.7; ZL200820105768.8; ZL200830128581.2; ZL200880105236.4; ZL200880105769.2; ZL200930190061.9; ZL201030176127.1; ZL201030176130.3; ZL201030176157.2; ZL201030595931.3; ZL201130442354.9; ZL201230471744.3; ZL201230620731.8.

1.8 Third-party licenses

1.8.1 GNU Lesser General Public License (LGPL)

<http://www.gnu.org/licenses/lgpl-2.1.en.html>

(Retrieved May 27, 2015)

1.8.2 Fonts (Source Han Sans)







<https://github.com/adobe-fonts/source-han-sans/blob/master/LICENSE.txt>

(Retrieved May 27, 2015)











1.8.3 Fonts (DejaVu)











<http://dejavu-fonts.org/wiki/License>









(Retrieved May 27, 2015)

 WARNING
<p>Applicability: Class B digital devices.</p> <p>This equipment has been tested and found to comply with the limits for a Class B digital device, pursuant to Part 15 of the FCC Rules. These limits are designed to provide reasonable protection against harmful interference in a residential installation. This equipment generates, uses and can radiate radio frequency energy and, if not installed and used in accordance with the instructions, may cause harmful interference to radio communications. However, there is no guarantee that interference will not occur in a particular installation. If this equipment does cause harmful interference to radio or television reception, which can be determined by turning the equipment off and on, the user is encouraged to try to correct the interference by one or more of the following measures:</p> <ul style="list-style-type: none"> • Reorient or relocate the receiving antenna. • Increase the separation between the equipment and receiver. • Connect the equipment into an outlet on a circuit different from that to which the receiver is connected. • Consult the dealer or an experienced radio/TV technician for help.
 WARNING
<p>Applicability: Digital devices subject to 15.19/RSS-247 issue 1.</p> <p>NOTICE: This device complies with Part 15 of the FCC Rules and with RSS-247 issue 1 of Industry Canada. Operation is subject to the following two conditions:</p> <ol style="list-style-type: none"> 1. this device may not cause harmful interference, and 2. this device must accept any interference received, including interference that may cause undesired operation.
 WARNING
<p>Applicability: Digital devices subject to 15.21.</p> <p>NOTICE: Changes or modifications made to this equipment not expressly approved by FLIR Systems may void the FCC authorization to operate this equipment.</p>
 WARNING
<p>Applicability: Digital devices subject to 2.1091/2.1093/OET Bulletin 65.</p> <p>Radiofrequency radiation exposure Information: The radiated output power of the device is below the FCC/IC radio frequency exposure limits. Nevertheless, the device shall be used in such a manner that the potential for human contact during normal operation is minimized.</p>
 WARNING
<p>Applicability: Cameras with one or more laser pointers.</p> <p>Do not look directly into the laser beam. The laser beam can cause eye irritation.</p>
 WARNING
<p>Applicability: Cameras with one or more batteries.</p> <p>Do not disassemble or do a modification to the battery. The battery contains safety and protection devices which, if damage occurs, can cause the battery to become hot, or cause an explosion or an ignition.</p>
 WARNING
<p>Applicability: Cameras with one or more batteries.</p> <p>If there is a leak from the battery and you get the fluid in your eyes, do not rub your eyes. Flush well with water and immediately get medical care. The battery fluid can cause injury to your eyes if you do not do this.</p>

Safety information

 WARNING
<p>Applicability: Cameras with one or more batteries.</p> <p>Do not continue to charge the battery if it does not become charged in the specified charging time. If you continue to charge the battery, it can become hot and cause an explosion or ignition. Injury to persons can occur.</p>
 WARNING
<p>Applicability: Cameras with one or more batteries.</p> <p>Only use the correct equipment to remove the electrical power from the battery. If you do not use the correct equipment, you can decrease the performance or the life cycle of the battery. If you do not use the correct equipment, an incorrect flow of current to the battery can occur. This can cause the battery to become hot, or cause an explosion. Injury to persons can occur.</p>
 WARNING
<p>Make sure that you read all applicable MSDS (Material Safety Data Sheets) and warning labels on containers before you use a liquid. The liquids can be dangerous. Injury to persons can occur.</p>
 CAUTION
<p>Do not point the infrared camera (with or without the lens cover) at strong energy sources, for example, devices that cause laser radiation, or the sun. This can have an unwanted effect on the accuracy of the camera. It can also cause damage to the detector in the camera.</p>
 CAUTION
<p>Do not use the camera in temperatures more than +50°C (+122°F), unless other information is specified in the user documentation or technical data. High temperatures can cause damage to the camera.</p>
 CAUTION
<p>Applicability: Cameras with one or more laser pointers.</p> <p>To prevent damage, put the protective cap on the laser pointer when you do not operate the laser pointer. Damage to the laser pointer can occur if you do not do this.</p>
 CAUTION
<p>Applicability: Cameras with one or more batteries.</p> <p>Do not attach the batteries directly to a car's cigarette lighter socket, unless FLIR Systems supplies a specific adapter to connect the batteries to a cigarette lighter socket. Damage to the batteries can occur.</p>
 CAUTION
<p>Applicability: Cameras with one or more batteries.</p> <p>Do not connect the positive terminal and the negative terminal of the battery to each other with a metal object (such as wire). Damage to the batteries can occur.</p>
 CAUTION
<p>Applicability: Cameras with one or more batteries.</p> <p>Do not get water or salt water on the battery, or permit the battery to become wet. Damage to the batteries can occur.</p>
 CAUTION
<p>Applicability: Cameras with one or more batteries.</p> <p>Do not make holes in the battery with objects. Damage to the battery can occur.</p>

 CAUTION
Applicability: Cameras with one or more batteries. Do not hit the battery with a hammer. Damage to the battery can occur.
 CAUTION
Applicability: Cameras with one or more batteries. Do not put your foot on the battery, hit it or cause shocks to it. Damage to the battery can occur.
 CAUTION
Applicability: Cameras with one or more batteries. Do not put the batteries in or near a fire, or into direct sunlight. When the battery becomes hot, the built-in safety equipment becomes energized and can stop the battery charging procedure. If the battery becomes hot, damage can occur to the safety equipment and this can cause more heat, damage or ignition of the battery.
 CAUTION
Applicability: Cameras with one or more batteries. Do not put the battery on a fire or increase the temperature of the battery with heat. Damage to the battery and injury to persons can occur.
 CAUTION
Applicability: Cameras with one or more batteries. Do not put the battery on or near fires, stoves, or other high-temperature locations. Damage to the battery and injury to persons can occur.
 CAUTION
Applicability: Cameras with one or more batteries. Do not solder directly onto the battery. Damage to the battery can occur.
 CAUTION
Applicability: Cameras with one or more batteries. Do not use the battery if, when you use, charge, or put the battery in storage, there is an unusual smell from the battery, the battery feels hot, changes color, changes shape, or is in an unusual condition. Speak with your sales office if one or more of these problems occurs. Damage to the battery and injury to persons can occur.
 CAUTION
Applicability: Cameras with one or more batteries. Only use a specified battery charger when you charge the battery. Damage to the battery can occur if you do not do this.
 CAUTION
Applicability: Cameras with one or more batteries. Only use a specified battery for the camera. Damage to the camera and the battery can occur if you do not do this.
 CAUTION
Applicability: Cameras with one or more batteries. The temperature range through which you can charge the battery is $\pm 0^{\circ}\text{C}$ to $+45^{\circ}\text{C}$ ($+32^{\circ}\text{F}$ to $+113^{\circ}\text{F}$), unless other information is specified in the user documentation or technical data. If you charge the battery at temperatures out of this range, it can cause the battery to become hot or to break. It can also decrease the performance or the life cycle of the battery.

 CAUTION
<p>Applicability: Cameras with one or more batteries.</p> <p>The temperature range through which you can remove the electrical power from the battery is -15°C to +50°C (+5°F to +122°F), unless other information is specified in the user documentation or technical data. If you operate the battery out of this temperature range, it can decrease the performance or the life cycle of the battery.</p>
 CAUTION
<p>Applicability: Cameras with one or more batteries.</p> <p>When the battery is worn, apply insulation to the terminals with adhesive tape or equivalent materials before you discard it. Damage to the battery and injury to persons can occur if you do not do this.</p>
 CAUTION
<p>Applicability: Cameras with one or more batteries.</p> <p>Remove any water or moisture on the battery before you install it. Damage to the battery can occur if you do not do this.</p>
 CAUTION
<p>Do not apply solvents or equivalent liquids to the camera, the cables, or other items. Damage to the battery and injury to persons can occur.</p>
 CAUTION
<p>Be careful when you clean the infrared lens. The lens has an anti-reflective coating which is easily damaged. Damage to the infrared lens can occur.</p>
 CAUTION
<p>Do not use too much force to clean the infrared lens. This can cause damage to the anti-reflective coating.</p>
 NOTE
<p>The encapsulation rating is only applicable when all the openings on the camera are sealed with their correct covers, hatches, or caps. This includes the compartments for data storage, batteries, and connectors.</p>
 CAUTION
<p>Applicability: Cameras with a viewfinder.</p> <p>Make sure that the beams from the intensive energy sources do not go into the viewfinder. The beams can cause damage to the camera. This includes the devices that emit laser radiation, or the sun.</p>

3.1 User-to-user forums

Exchange ideas, problems, and infrared solutions with fellow thermographers around the world in our user-to-user forums. To go to the forums, visit:

<http://www.infraredtraining.com/community/boards/>

3.2 Calibration

We recommend that you send in the camera for calibration once a year. Contact your local sales office for instructions on where to send the camera.

3.3 Accuracy

For very accurate results, we recommend that you wait 5 minutes after you have started the camera before measuring a temperature.

3.4 Disposal of electronic waste



As with most electronic products, this equipment must be disposed of in an environmentally friendly way, and in accordance with existing regulations for electronic waste.

Please contact your FLIR Systems representative for more details.

3.5 Training

To read about infrared training, visit:

- <http://www.infraredtraining.com>
- <http://www.irtraining.com>
- <http://www.irtraining.eu>

3.6 Documentation updates

Our manuals are updated several times per year, and we also issue product-critical notifications of changes on a regular basis.

To access the latest manuals and notifications, go to the Download tab at:

<http://support.flir.com>

It only takes a few minutes to register online. In the download area you will also find the latest releases of manuals for our other products, as well as manuals for our historical and obsolete products.

3.7 Important note about this manual

FLIR Systems issues generic manuals that cover several cameras within a model line.

This means that this manual may contain descriptions and explanations that do not apply to your particular camera model.

3.8 Note about authoritative versions

The authoritative version of this publication is English. In the event of divergences due to translation errors, the English text has precedence.

Any late changes are first implemented in English.

FLIR Customer Support Center

Home
Answers
Ask a Question
Product Registration
Downloads
My Stuff
Service

FLIR Customer support

Get the most out of your FLIR products

Get Support for Your FLIR Products

Welcome to the FLIR Customer Support Center. This portal will help you as a FLIR customer to get the most out of your FLIR products. The portal gives you access to:

- The FLIR Knowledgebase
- Ask our support team (requires registration)
- Software and documentation (requires registration)
- FLIR service contacts

Find Answers

We store all resolved problems in our solution database. Search by product, category, keywords, or phrases.

Search by Keyword

[Search All Answers](#)

[See All Popular Answers](#)

To find a datasheet for a current product, click on a picture.
To find a datasheet for a legacy product, click [here](#).



FLIR Exx



FLIR Kxx



FLIR T4xx



FLIR T6xx



FLIR G3xx

ThermaCAM™
GasFindIR

FLIR GF3xx

FLIR AX



FLIR Ax5

FLIR A3xx

[More...](#)

Product catalog

Please right-click the links below and select Save Target As... to save the file.



US Letter (28 Mb)
A4 (27.4 Mb)

Important legal disclaimer, dangers, warnings, and cautions

Accessories



4.1 General

For customer help, visit:

<http://support.flir.com>

4.2 Submitting a question

To submit a question to the customer help team, you must be a registered user. It only takes a few minutes to register online. If you only want to search the knowledgebase for existing questions and answers, you do not need to be a registered user.

When you want to submit a question, make sure that you have the following information to hand:

- The camera model
- The camera serial number
- The communication protocol, or method, between the camera and your device (for example, HDMI, Ethernet, USB, or FireWire)
- Device type (PC/Mac/iPhone/iPad/Android device, etc.)
- Version of any programs from FLIR Systems
- Full name, publication number, and revision number of the manual

4.3 Downloads

On the customer help site you can also download the following:

- Firmware updates for your infrared camera.
- Program updates for your PC/Mac software.
- Freeware and evaluation versions of PC/Mac software.
- User documentation for current, obsolete, and historical products.
- Mechanical drawings (in *.dxf and *.pdf format).
- Cad data models (in *.stp format).
- Application stories.
- Technical datasheets.
- Product catalogs.



5.1 General description

The FLIR T10xx series is designed for the expert requiring the highest performance and the latest technology available. The camera series combines excellent ergonomics and feature-rich flexibility with superior image quality of 1024 × 768 pixel infrared resolution. High accuracy and sensitivity together with radiometric recording and streaming options make the FLIR T10xx series well suited for advanced research and development.

5.2 Key benefits

- Tailor made for research and development: The FLIR T10xx series has high accuracy and high sensitivity, to accurately measure the smallest temperature differences. With real-time radiometric recording by the camera, it is possible to capture fast events on the camera's SD card for further analysis by the supplied analysis software.
- Flexible and feature rich: A wide variety of measuring and analysis functions makes the camera flexible for your every need. Two programmable buttons provide easy access to favorite functions.
- Highest performance with the latest technology: The FLIR T10xx series is equipped with the innovative Multi Spectral Dynamic Imaging (MSX) feature, which produces an image richer in detail than ever before. Continuous auto-focus makes the FLIR T10xx series a fully automatic infrared camera series.

6.1 Procedure

Follow this procedure:

1. Put a battery into the battery compartment.
2. Charge the battery for 4 hours before starting the camera for the first time.
3. Insert a memory card into the card slot.
4. Push the On/off button  to turn on the camera.
5. Aim the camera toward the object of interest.
6. Adjust the focus.



NOTE

It is very important to adjust the focus correctly. Incorrect focus adjustment affects how the image modes work. It also affects the temperature measurement.

7. Push the Save button fully down to save an image.
8. Go to <http://support.flir.com/tools> and download FLIR Tools.
9. Install FLIR Tools on your computer.
10. Start FLIR Tools.
11. Connect the camera to the computer using a USB cable.
12. Import the images into FLIR Tools.
13. Select one or more images.
14. Click *Generate report*.
15. Click *Export* to export the report as a PDF file.
16. Send the PDF report to your client.

7.1 General

To prevent strain-related injuries, it is important that you hold the camera ergonomically correct. This section gives advice and examples on how to hold the camera.



NOTE

Please note the following:

- Always tilt the touch-screen LCD to suit your work position.
- When you hold the camera, make sure that you support the optics housing with your left hand too. This decreases the strain on your right hand.
- Always use the supplied neck strap. See section 8.5 *Neck strap attachment points*, page 17.

7.2 Figure



8.1 View from the right

8.1.1 Figure

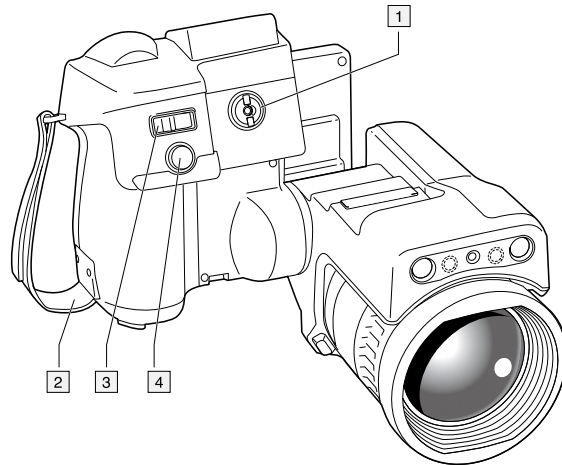

8.1.2 Explanation

1. Knob to change the dioptic correction for the viewfinder.
2. Hand strap.
3. Digital zoom button.
4. Save button (push fully down).



NOTE

By default, the camera will autofocus when you push the Save button half-way down. To disable the autofocus function of the Save button, select  (Settings) > Save options & storage > Save button half-press = None.

8.2 View from the left

8.2.1 Figure

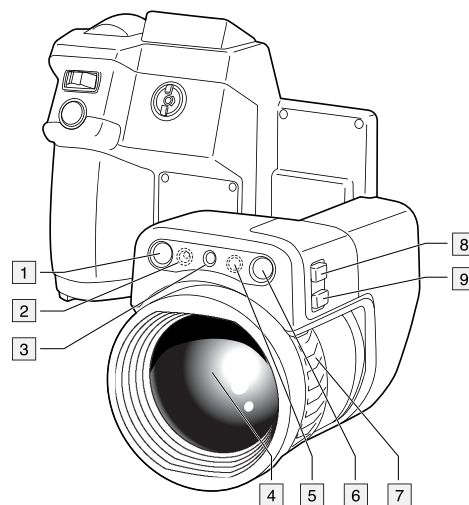

8.2.2 Explanation

1. Digital camera.

2. Camera lamp.
3. Laser pointer.

**NOTE**

The laser pointer may not be enabled in all markets.

4. Infrared lens.
5. Camera lamp.
6. Digital camera.
7. Focusing ring.
8. Programmable button **P**.
9. Button to operate the laser pointer.

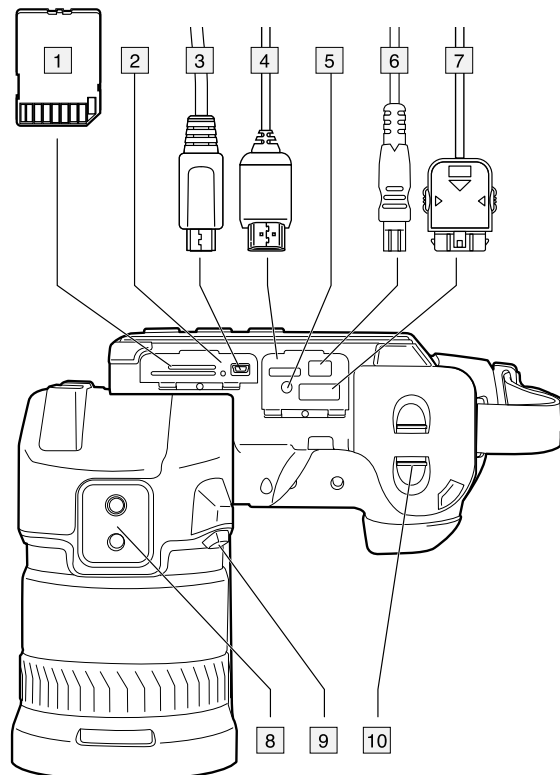
8.3 View from the bottom**8.3.1 Figure****8.3.2 Explanation**

1. Memory card.
2. LED indicator showing that the memory card is busy.

**NOTE**

- Do not eject the memory card when this LED is flashing.
- Do not connect the camera to a computer when this LED is flashing.

3. USB Micro B cable (to connect the camera to a computer).
4. HDMI cable (for digital video output).
5. Battery condition LED indicator.
6. Power supply cable (to power the camera and charge the battery).
7. High-speed interface cable.



8. Tripod mount.
9. Button to release the lens.
10. Latch to release the battery.

8.4 View from the rear

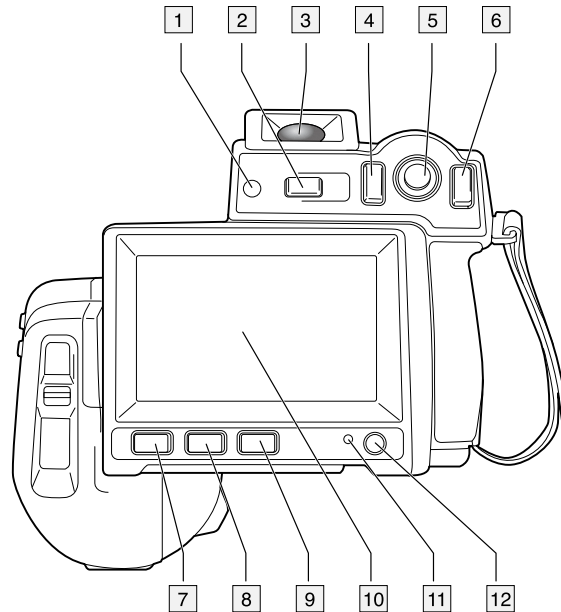
8.4.1 Figure



8.4.2 Explanation

1. Sensor that adjusts the touch-screen LCD intensity automatically.
2.  button.
Function:
 - Push to switch between touch-screen LCD mode and viewfinder mode.
3. Viewfinder.
4. Programmable button **P**.
5. Joystick with push-button functionality.
Function:
 - Move the joystick left/right or up/down to navigate in menus, submenus, and dialog boxes, and to change values in dialog boxes.
 - Push the joystick to confirm changes and settings in menus and dialog boxes.
6. Back button .
Function:
 - Push to leave dialog boxes and to go back in the menu system.
7. Camera lamp button .
Function:
 - Push to turn on or off the camera lamp.



NOTE

The camera lamp must be enabled. Select  (Settings) > Device settings > Set up camera > Lamp & laser > Enable lamp & laser.

8.  button.

Function:

- Push to switch between automatic and manual image adjustment mode.

9. Image archive button .

Function:

- Push to open the image archive.
- Push and hold for more than 2 seconds to perform a manual calibration.

10. Touch-screen LCD.

11. Power indicator.

12. On/off button .

Function:

- Push and release to turn on the camera.
- Push and hold for more than 0.2 second to turn off the camera.

8.5 Neck strap attachment points

8.5.1 Figure

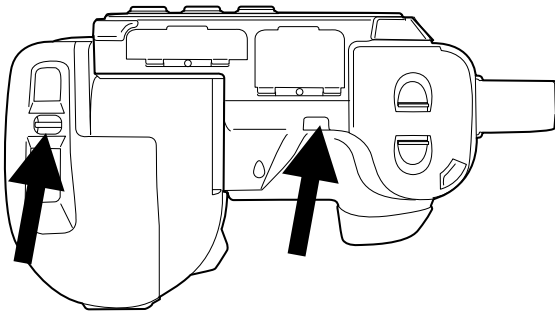

8.6 Battery condition LED indicator

8.6.1 Figure

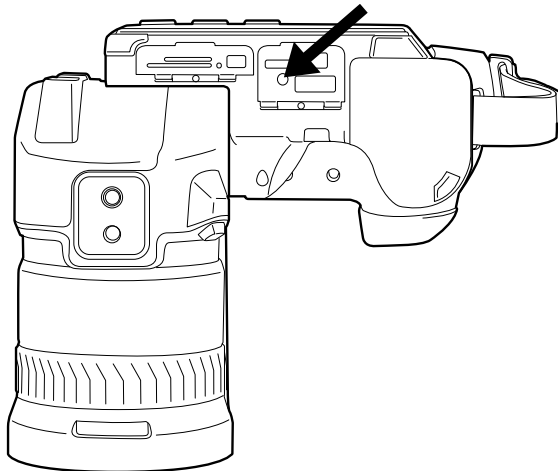

8.6.2 Explanation

Type of signal	Explanation
The green LED flashes twice per second.	The battery is being charged.
The green LED glows continuously.	The battery is fully charged.

8.7 Power LED indicator

8.7.1 Figure

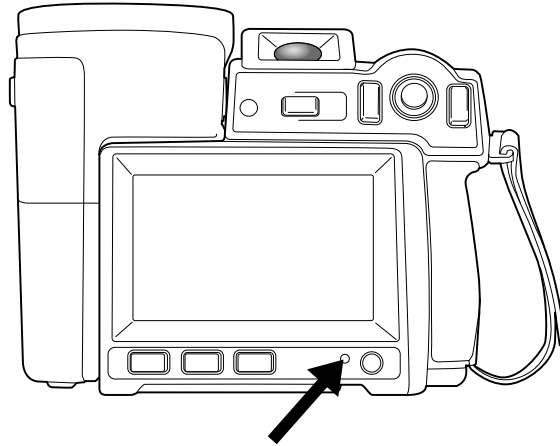

8.7.2 Explanation

Type of signal	Explanation
The LED is off.	The camera is off.
The LED is blue.	The camera is on.

8.8 Laser pointer

8.8.1 Figure

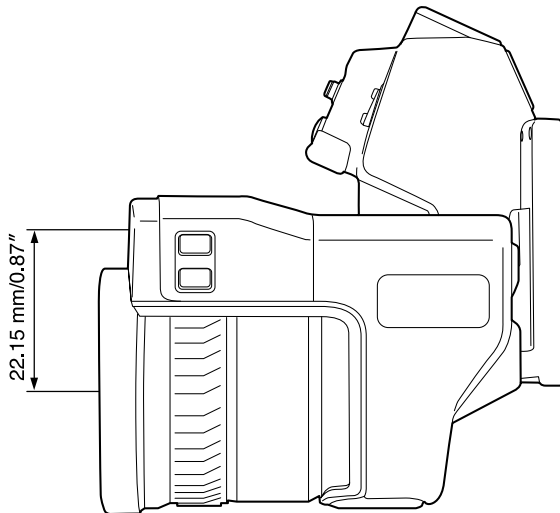



Figure 8.1 This figure shows the difference in position between the laser pointer and the optical center of the infrared lens.

	WARNING
Do not look directly into the laser beam. The laser beam can cause eye irritation.	
	NOTE
The symbol is displayed on the screen when the laser pointer is on.	

	NOTE
<p>The laser pointer is enabled by a setting. Select  (Settings) > Device settings > Set up camera > Lamp & laser > Enable lamp & laser.</p>	

	NOTE
<p>The laser pointer may not be enabled in all markets.</p>	

8.8.2 Laser warning label

A laser warning label with the following information is attached to the camera:

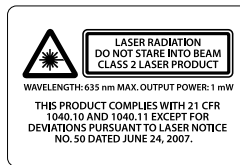

8.8.3 Laser rules and regulations

Wavelength: 635 nm. Maximum output power: 1 mW.

This product complies with 21 CFR 1040.10 and 1040.11 except for deviations pursuant to Laser Notice No. 50, dated June 24, 2007.



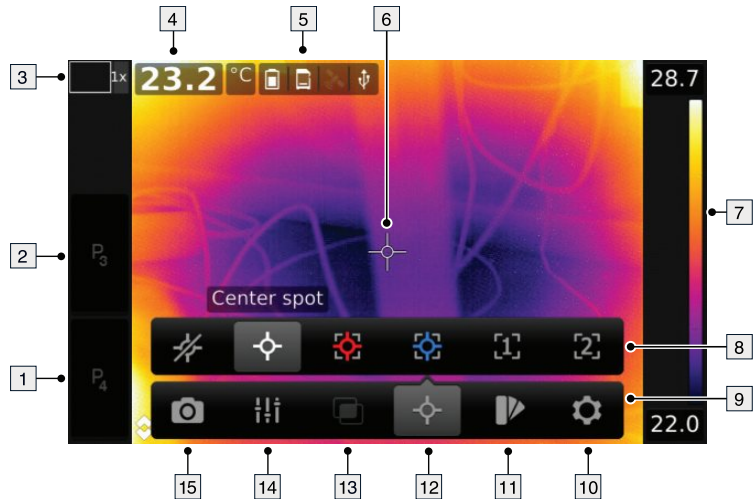





9.1 Figure





9.2 Explanation

1. Programmable button P4.
2. Programmable button P3.
3. Digital zoom factor.
4. Result table.
5. Status icons.
6. Measurement tool (e.g., spotmeter).
7. Temperature scale.
8. Submenu.
9. Main menu.
10. Settings button.
11. Color button.
12. Measurement button.
13. Image mode button.
14. Measurement parameters button.
15. Recording mode button.

9.3 Status icons and indicators

	Battery status indicator.
	Memory card storage status indicator.
	Manual adjustment mode is enabled.
	The camera lamp is turned on.
	The camera is connected to a device using USB.
	Wi-Fi connectivity indicator.
	Bluetooth connectivity indicator.
	A Bluetooth headset is connected.

	<p>The GPS indicator.</p> <ul style="list-style-type: none"> • Gray icon: The GPS is enabled, but there is no satellite contact. • White icon: The GPS is enabled, with satellite contact.
	<p>External infrared window compensation is enabled.</p>
	<p>The laser pointer is turned on.</p>

9.4 Image overlay information

The image information consists of items such as date, emissivity, and atmospheric temperature. All image information is saved in the image file and can be viewed in the image archive. You can also choose to display selected items as image overlay information. All image overlay information displayed on the live image will also be displayed on saved images. For more information, see sections 23.1.5 *Device settings*, page 74 and 13.8 *Hiding all overlay*, page 48.

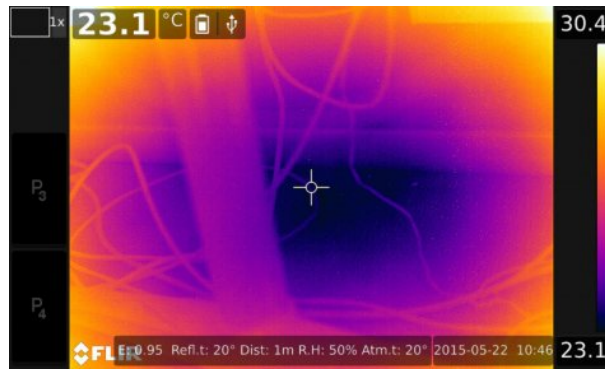

10.1 General

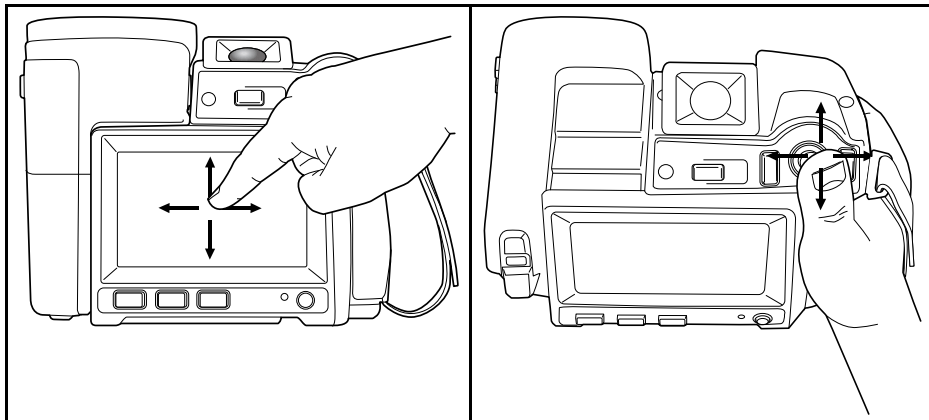

The figure above shows the two ways to navigate the menu system in the camera:

- Using the index finger or a stylus pen specially designed for capacitive touch usage to navigate the menu system (left).
- Using the joystick to navigate the menu system (right) and the Back button.

You can also use a combination of the two.

In this manual, it is assumed that the joystick is used, but most tasks can also be carried out using the index finger or a stylus pen.

10.2 Navigating using the joystick

You navigate the menu system by using the joystick and the Back button:

- To display the menu system, push the joystick.
- To navigate in menus, submenus, and dialog boxes, and to change values in dialog boxes, move the joystick up/down or left/right.
- To confirm changes and settings in menus and dialog boxes, push the joystick.
- To leave dialog boxes and to go back in the menu system, push the Back button ↶.

11.1 Charging the battery

 NOTE
You must charge the battery for 4 hours before you start using the camera for the first time.

11.1.1 Using the power supply to charge the battery

11.1.1.1 Procedure

Follow this procedure:

1. Connect the power supply cable plug to the power connector on the camera.
2. Connect the power supply mains-electricity plug to a mains socket.
3. Disconnect the power supply cable plug when the green light of the battery condition LED indicator is continuous.

11.1.2 Using the stand-alone battery charger to charge the battery

11.1.2.1 Explanation

Type of signal	Explanation
The blue LED flashes.	The battery is being charged.
The blue LED glows continuous.	The battery is fully charged.

11.1.2.2 Procedure

Follow this procedure:

1. Put the battery in the battery charger.
2. Connect the power supply cable plug to the connector on the battery charger.
3. Connect the power supply mains-electricity plug to a mains socket.
4. Disconnect the power supply cable plug when the blue LED on the battery charger is continuous.

11.2 Turning on the camera

11.2.1 Procedure

Follow this procedure:



1. To turn on the camera, push and release the On/off button .

11.3 Turning off the camera

11.3.1 Procedure

Follow this procedure:

1. To turn off the camera, push and hold the On/off button  for more than 0.2 second.

 NOTE
In the rare event of the camera not responding to commands, push and hold the On/off button  for more than 10 seconds to turn off the camera. Do not remove the battery.

11.4 Adjusting the viewfinder's dioptic correction

11.4.1 Figure

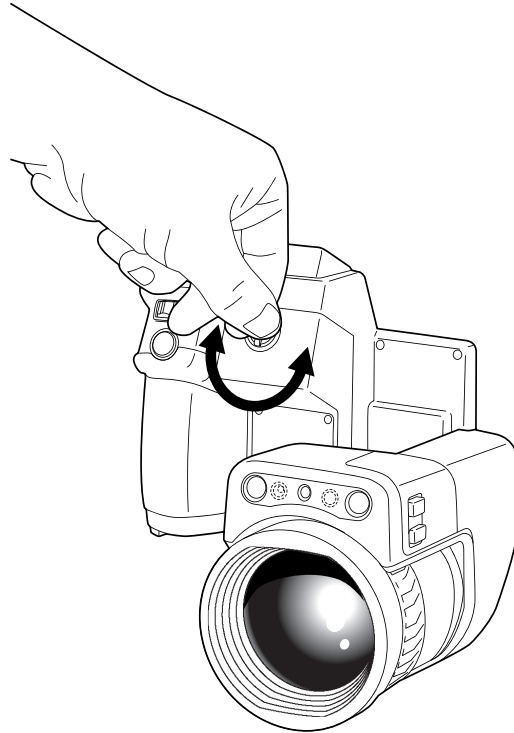

CAUTION

Applicability: Cameras with a viewfinder.

Make sure that the beams from the intensive energy sources do not go into the viewfinder. The beams can cause damage to the camera. This includes the devices that emit laser radiation, or the sun.

11.4.2 Procedure

Follow this procedure:

1. Push the  button to switch from touch-screen LCD mode to viewfinder mode.
2. To adjust the viewfinder's dioptic correction, look through the viewfinder and rotate the adjustment knob clockwise or counter-clockwise for best sharpness.



NOTE

- Maximum dioptic correction: +2.
- Minimum dioptic correction: -2.

11.5 Adjusting the angle of the lens

11.5.1 Figure

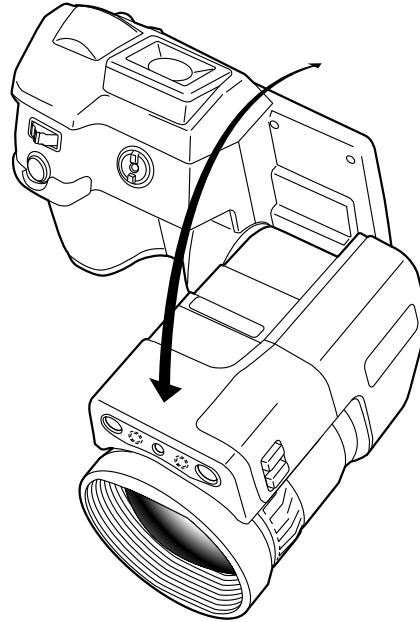

11.6 Adjusting the infrared camera focus manually

11.6.1 Figure

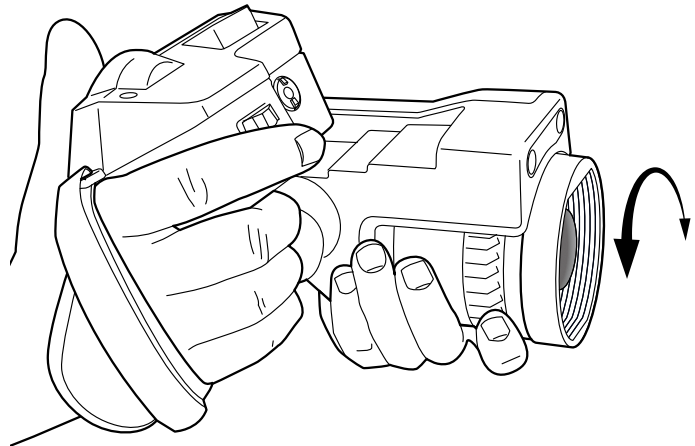

11.6.2 Procedure

Follow this procedure:

1. Do one of the following:
 - For far focus, rotate the focus ring clockwise (looking at the touch-screen LCD side).
 - For near focus, rotate the focus ring counter-clockwise (looking at the touch-screen LCD side).

**NOTE**

- Do not touch the lens surface when you adjust the infrared camera focus manually. If this happens, clean the lens according to the instructions in 26.2 *Infrared lens*, page 145.
- The focus ring can be rotated infinitely, but only a certain amount of rotation is needed when focusing.
- The response of the focus mechanism depends on the rotation speed of the focus ring, meaning that the focus will change faster if you rotate the focus ring faster.

11.7 Autofocusing the infrared camera**11.7.1 General**

The camera will autofocus when you push the Save button half-way down.

**NOTE**

- You can disable the autofocus function of the Save button. Select  (Settings) > Save options & storage > Save button half-press > None.
- You can assign the autofocus function to the programmable button **P** or **P₂**. For more information, see section 11.11 *Assigning functions to the programmable buttons*, page 29.

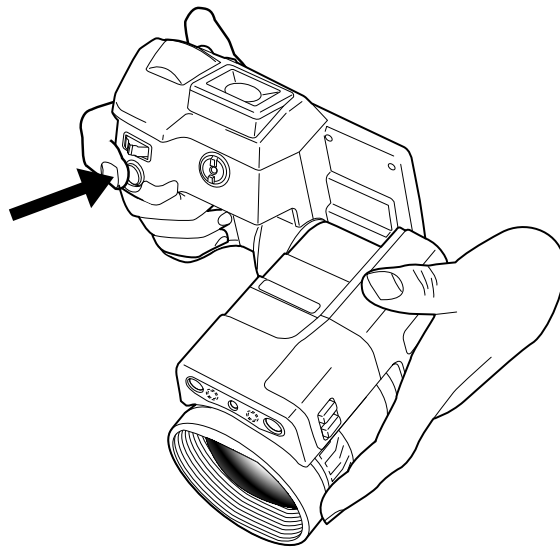
11.7.2 Figure**11.7.3 Procedure**

Follow this procedure:

1. Push the Save button half-way down.

11.8 Continuous autofocus**11.8.1 General**



The camera can be set up to perform continuous autofocusing.

 NOTE
<ul style="list-style-type: none"> • In this mode, the digital camera is used, which means that continuous autofocus will not work in darkness. • When continuous autofocus is enabled, it is not possible to manually adjust the focus by rotating the focus ring. • To stop the continuous autofocusing (e.g. to stabilize the focus before saving an image), push the Save button half-way down.

11.8.2 Procedure



Follow this procedure:

1. Push the joystick to display the menu system.
2. Use the joystick to go to  (*Settings*).
3. Push the joystick to display the *Settings* menu.
4. Select *Device settings* and push the joystick.
5. Select *Continuous autofocus* and push the joystick.
6. Select *On* and push the joystick.

 NOTE
<p>You can also assign the function <i>Continuous autofocus</i> to one of the programmable buttons. Select  (<i>Settings</i>) > <i>Programmable buttons</i>.</p>

11.9 Operating the laser pointer

 WARNING
Do not look directly into the laser beam. The laser beam can cause eye irritation.

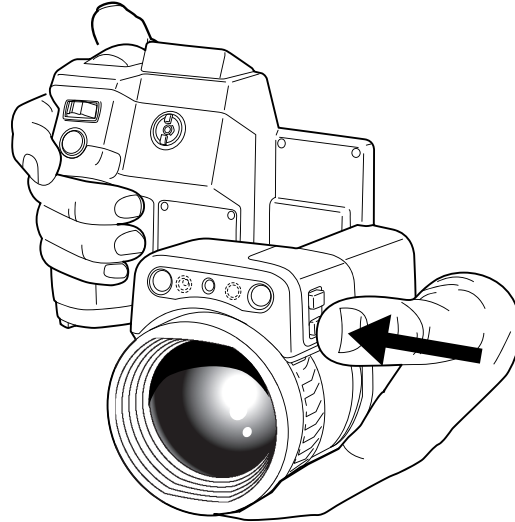

 NOTE
<p>The laser pointer is enabled by a setting. Select  (<i>Settings</i>) > <i>Device settings</i> > <i>Lamp & laser</i> > <i>Enable lamp & laser</i>.</p>

 NOTE
The laser pointer may not be enabled in all markets.

11.9.1 Figure**11.9.2 Procedure**

Follow this procedure:

1. To turn on the laser pointer, push and hold the laser button.
2. To turn off the laser pointer, release the laser button.

	NOTE
	<ul style="list-style-type: none">• The symbol  is displayed on the screen when the laser pointer is on.• The position of the laser dot is indicated on the infrared image (depending on the camera model).

11.10 Using the digital zoom function**11.10.1 General**

The high resolution of the detector allows digital zooming without deterioration of the image quality.

The current zoom factor is displayed in the upper left corner of the screen.

In preview/edit mode, it is possible to pan a zoomed image by touching the screen.

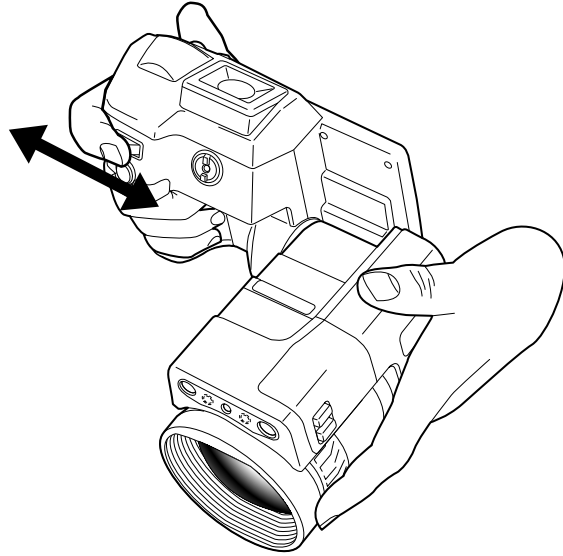
11.10.2 Figure**11.10.3 Procedure**

Follow this procedure:

1. To zoom, push the zoom button left or right.

11.11 Assigning functions to the programmable buttons**11.11.1 General**

There are four programmable buttons: two hardware buttons, and two software buttons on the screen.

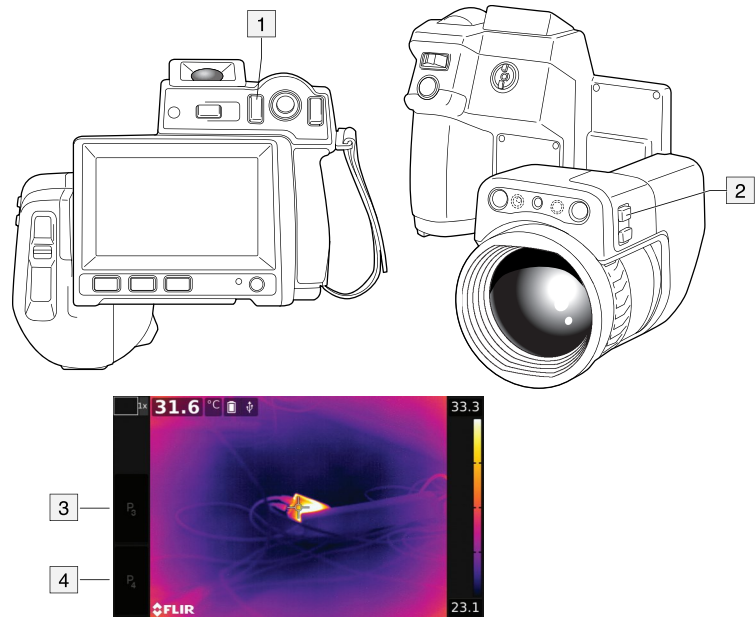

1. Programmable button **P**.
2. Programmable button **P₂**.
3. Programmable button P3.
4. Programmable button P4.

You can assign different functions to the programmable buttons. For a complete list of functions, see section 23.1.4 *Programmable buttons*, page 73.

11.11.2 Procedure

Follow this procedure:

1. Push the joystick to display the menu system.
2. Use the joystick to go to  (*Settings*).
3. Push the joystick to display the *Settings* menu.
4. Select *Programmable buttons* and push the joystick.
5. Select one of the buttons and push the joystick:
 - *P Button*: Hardware button **P**.
 - *P2 Button*: Hardware button **P2**.
 - *P3 Button (on screen)*: Software button P3 on the screen.
 - *P4 Button (on screen)*: Software button P4 on the screen.
6. Select one of the functions and push the joystick.

11.12 Using the camera lamp as a flash

11.12.1 General

The camera lamp can be used as a flash for the digital camera. When the flash function is activated, the camera lamp will flash when an image is saved by pushing the Save button fully down.

11.12.2 Procedure

Follow this procedure:

1. Push the joystick to display the menu system.
2. Use the joystick to go to  (*Settings*).
3. Push the joystick to display the *Settings* menu.
4. Select *Device settings* and push the joystick.
5. Select *Lamp & laser* and push the joystick.
6. Select *Enable lamp & laser + Use lamp as flash* and push the joystick.



NOTE

You can also assign the function *Switch camera flash On <> Off* to one of the programmable buttons.

Select  (*Settings*) > *Programmable buttons*.

11.13 Changing lenses



NOTE

Do not touch the lens surface when you change lenses. If this happens, clean the lens according to the instructions in 26.2 *Infrared lens*, page 145.

Follow this procedure:

1. Take a firm grip around the outermost part of the lens.

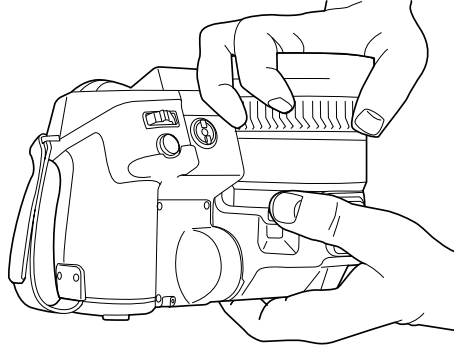

2. Push the release button and rotate the lens 45° counter-clockwise.

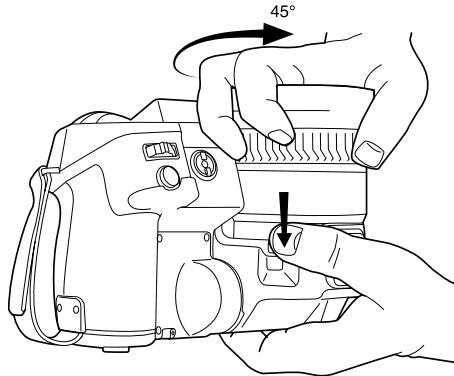

3. Carefully pull out the lens from the lens bayonet mount.

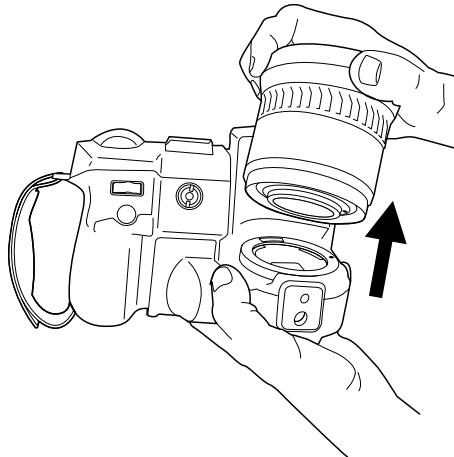

4. The infrared detector is now fully exposed. Do not touch this surface. If you see dust on the detector, follow the instructions in 26.3 *Infrared detector*, page 145.

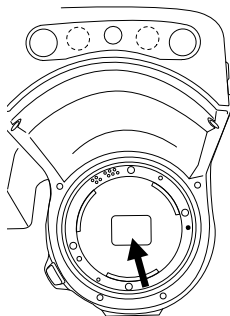

5. Note the index marks on the lens bayonet mount and on the lens.

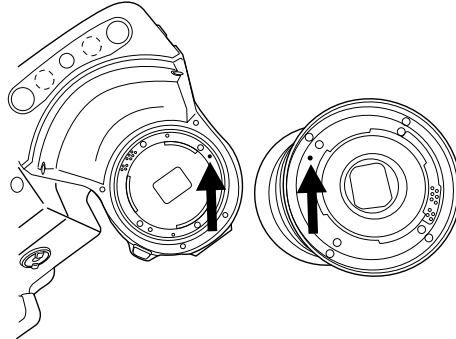

6. Align the lens correctly to the bayonet mount. Carefully push the lens into position.

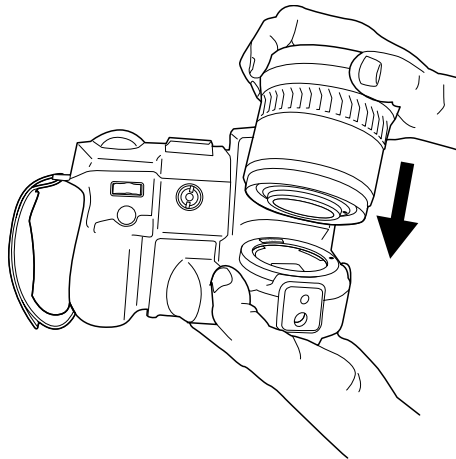

7. Rotate the lens 45° clockwise. The lens makes a click when it locks in place.

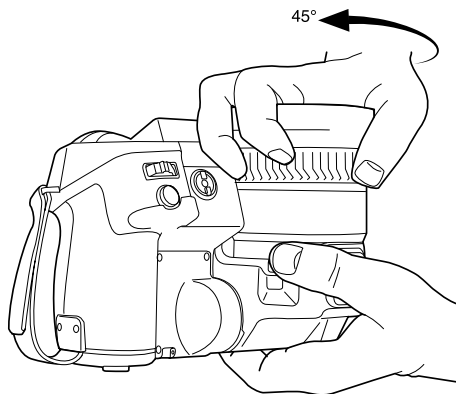

11.14 Using the close-up lens

11.14.1 General

If you need to look at small objects very close up, you can attach the close-up lens to the infrared lens.

When the close-up lens is attached, the digital camera and the infrared camera do not see the same scene. This means that functions that are based on content captured by the digital camera cannot be used, e.g., continuous autofocus and some image modes.

When using the close-up lens, keep the following in mind:

- You must activate the global parameter *External IR window compensation*.

- The working distance for the close-up lens is 97 mm. (The working distance is the distance between the front of the lens and the closest surface of the object when the object is in sharp focus.)
- For best performance, adjust the focus to infinity.
- Only use the *Thermal* image mode.
- Deactivate continuous autofocus. For more informations, see section 11.8 *Continuous autofocus*, page 26.
- Do not use the laser pointer.

**NOTE**

The close-up lens can only be used with the infrared lens $f = 36$ mm (28°).

11.14.2 Attaching the close-up lens

**NOTE**

Do not touch the lens surfaces when you attach the close-up lens. If this happens, clean the lens according to the instructions in 26.2 *Infrared lens*, page 145.

Follow this procedure:

1. Remove the outermost rubber protection from the infrared lens.

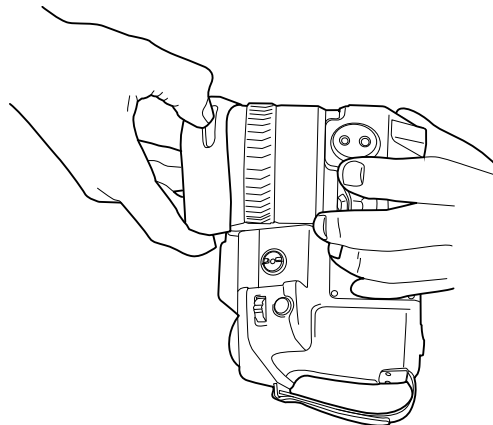

2. Align the close-up lens with the infrared lens. Carefully push the close-up lens into position.

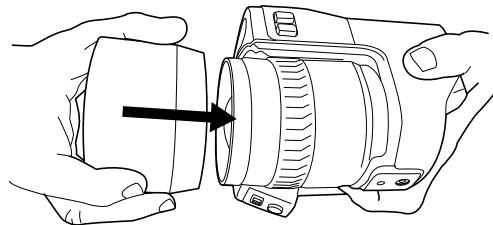



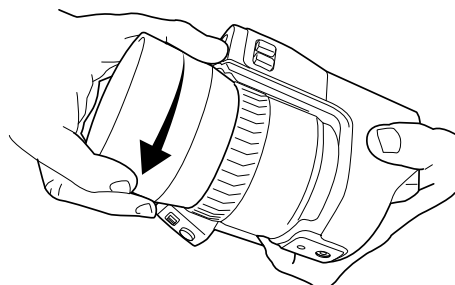

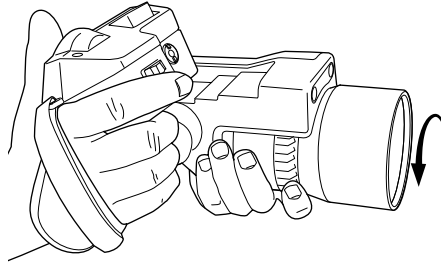

3. Turn the close-up lens clockwise until it stops.



4. Adjust the focus to infinity by turning the focus ring clockwise (looking at the touch-screen LCD side).



5. Activate the global parameter *External IR window compensation* by doing the following:
- 5.1. Push the joystick to display the menu system.
 - 5.2. Select  (*Measurement parameters*) and push the joystick. This displays a submenu.
 - 5.3. Select  (*External IR window compensation*) and push the joystick. This displays a dialog box.
 - 5.4. In the dialog box, define the settings for the infrared window compensation:
 - *Turn compensation on/off*: Select *On*.
 - *Temperature*: Select the temperature of the close-up lens.
 - *Transmission*: Select the transmission of the close-up lens. The transmission is printed on the close-up lens.
 - 5.5. Push the Back button  to go back in the menu system.
 - 5.6. The status icon  is now displayed.
6. Select the image mode *Thermal* by doing the following:
- 6.1. Push the joystick to display the menu system.
 - 6.2. Select  (*Image mode*) and push the joystick. This displays a submenu.
 - 6.3. Select  (*Thermal*) and push the joystick.
 - 6.4. Push the Back button  to go back in the menu system.

11.14.3 Removing the close-up lens



NOTE

Do not touch the lens surfaces when you remove the close-up lens. If this happens, clean the lens according to the instructions in 26.2 *Infrared lens*, page 145.

Follow this procedure:

1. Turn the close-up lens counter-clockwise until it comes off the infrared lens.

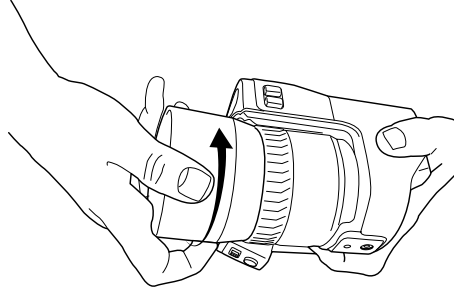

2. Carefully pull out the close-up lens from the infrared lens.

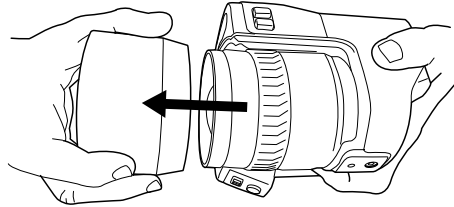

3. Note the grooves on the infrared lens and their counterparts on the inside of the rubber protection

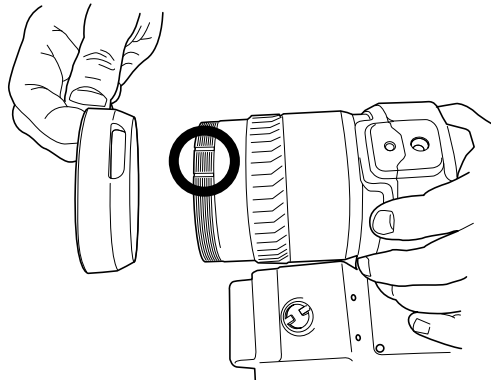

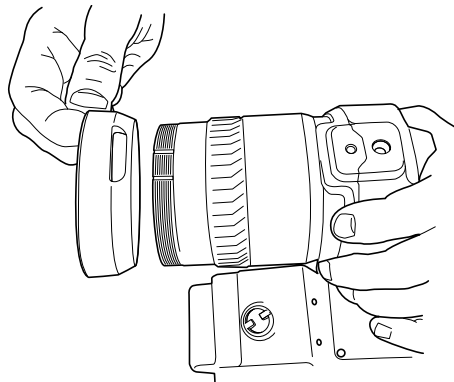

4. Align the rubber protection with the infrared lens.



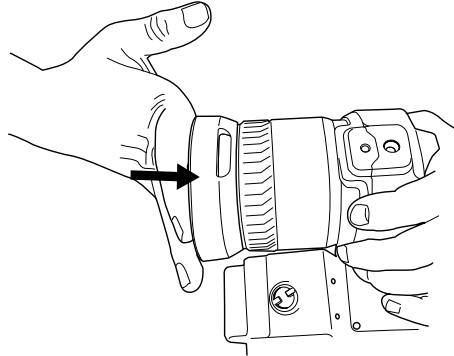

5. Push the rubber protection into position.



6. Deactivate the global parameter *External IR window compensation* by doing the following:
- 6.1. Push the joystick to display the menu system.
 - 6.2. Select  (*Measurement parameters*) and push the joystick. This displays a submenu.
 - 6.3. Select  (*External IR window compensation*) and push the joystick. This displays a dialog box.
 - 6.4. In the dialog box, select *Turn compensation on/off = Off*.
 - 6.5. Push the Back button  to go back in the menu system.

11.15 Changing the viewfinder eyecup

	CAUTION
Applicability: Cameras with a viewfinder.	
Make sure that the beams from the intensive energy sources do not go into the viewfinder. The beams can cause damage to the camera. This includes the devices that emit laser radiation, or the sun.	
	NOTE
This item is dependent on the camera model.	

Follow this procedure:

1. Put your thumbs at the lower part of the eyecup. Push the eyecup horizontally, away from the touch-screen LCD side, until the eyecup slides out from its mount.

**NOTE**

To remove the eyecup, you must slide it out from its mount. Do not pull the eyecup straight up.

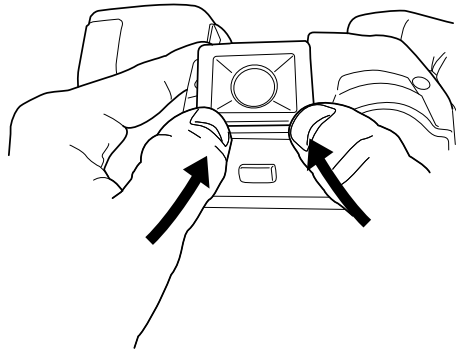

2. Note the grooves on the eyecup mount on the camera and on the new eyecup.

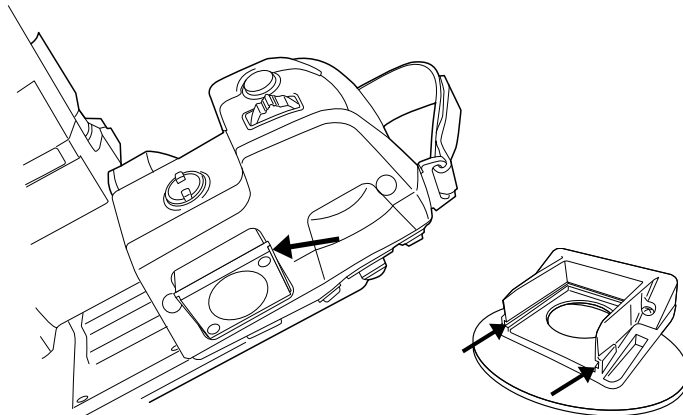

3. Align the new eyecup with the eyecup mount on the camera.

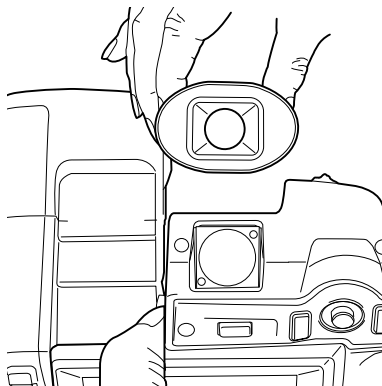

-
- Carefully slide the eyecup into position.

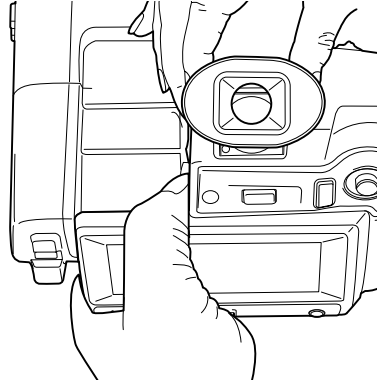

11.16 Calibrating the compass

11.16.1 Procedure

Follow this procedure:

- Push the joystick to display the menu system.
- Use the joystick to go to  (*Settings*).
- Push the joystick to display the *Settings* menu.
- Select *Device settings* and push the joystick.
- Depending on the camera configuration, select *Wireless & geolocation*, *Wireless*, or *Geolocation* and push the joystick.
- Select *Compass* and push the joystick.
- If the *Compass* check box is unchecked, push the joystick to enable the compass.
- Select *Calibrate compass* and push the joystick. Follow the on-screen instructions.



NOTE

You have to rotate the camera slowly.

12.1 About image files

12.1.1 General

You can save images to the memory card.

The camera saves an image file including all thermal and visual information. This means that you can open an image file at a later time and, for example, select another image mode, apply color alarms, and add measurement tools.

The image jpg file is fully radiometric and saved lossless, which enables full post-processing in image analysis and reporting software from FLIR Systems. There is also a regular jpg part (lossy) for convenient viewing in non-FLIR Systems software (e.g., Microsoft Explorer).

The camera can also be configured to save an extra visual image as a separate file. Select  (Settings) > Save options & storage > Photo as separate JPEG = On.

12.1.2 File-naming convention

The default naming convention for image files is FLIRxxxx.jpg, where xxxx is a unique counter.

It is also possible to save images with a date prefix added to the file name. However, these files may not automatically be detected by third-party applications. For more information, see section the setting *File naming format* in section 23.1.3 *Save options & storage*, page 72.

12.1.3 Image capacity

The capacity of a 4 GB memory card is theoretically 1000 images (with no annotations).

12.1.4 About UltraMax

UltraMax is an image enhancement feature that increases the image resolution and lowers the noise, making small objects easier to see and measure. An UltraMax image is twice as wide and high as an ordinary image.

When an UltraMax image is captured by the camera, several ordinary images are saved in the same file. Capturing all the images can take up to 1 second. To fully utilize UltraMax, the images need to be slightly different, which can be accomplished by a slight movement of the camera. You should hold the camera firmly in your hands (do not put it on a tripod), which will make these images vary just a little during the capture. Correct focus, a high-contrast scene, and a non-moving target are other conditions that help to achieve a good-quality UltraMax image.

At the moment, only FLIR Tools has the ability to process UltraMax images. Other FLIR software will treat the image as a regular image.

To configure the camera for UltraMax, select  (Settings) > Save options & storage > Image resolution = UltraMax.

12.2 Saving an image



12.2.1 General

You can save images to the memory card.

12.2.2 Procedure

Follow this procedure:



1. To save an image, push the Save button fully down.

 NOTE
<p>Depending on the settings in  (<i>Settings</i>) > <i>Save options & storage</i>, the following may happen:</p> <ul style="list-style-type: none"> • A preview image is displayed before the image is saved. • An annotation tool or the annotation menu is displayed when the image has been saved.

12.3 Previewing an image



12.3.1 General

You can preview an image before you save it. This enables you to see if the image contains the information you want before you save it. You can also adjust and edit the image.

 NOTE
<p>The camera must be configured to display a preview image before saving. Select  (<i>Settings</i>) > <i>Save options & storage</i> > <i>Preview image before saving = On</i>.</p>

12.3.2 Procedure

Follow this procedure:

1. To preview an image, push the Save button fully down. This displays the preview.
2. Manual image adjustment mode is now active, and the status icon  is displayed. For image adjustment instructions, see section 13.3 *Adjusting the infrared image*, page 44.
3. To edit the image, push the joystick. This displays a context menu. For editing instructions, see section 12.5 *Editing a saved image*, page 41.
4. Do one of the following:
 - To save the image, push the Save button fully down.
 - To exit preview mode without saving, push the Back button .



12.4 Opening a saved image

12.4.1 General

When you save an image, the image file is stored on the memory card. To display the image again, open it from the image archive.

12.4.2 Procedure

Follow this procedure:

1. Push the Image archive button .
2. Move the joystick up/down or left/right to select the image you want to view.
3. Push the joystick. This displays the image at full size.
4. Do one or more of the following:
 - To switch between an infrared image and a visual image, move the joystick up/down.
 - To view the previous/next image, move the joystick left/right.
 - To edit the image, add annotations, display information, or delete the image, push the joystick. This displays a context menu.
 - To return to the image archive overview, push the Back button .









12.5 Editing a saved image

12.5.1 General

You can edit a saved image. You can also edit an image in preview mode.

12.5.2 Procedure

Follow this procedure:

1. Open the image in the image archive.
2. Push the joystick and select  (*Edit*) from the menu.
3. Manual image adjustment mode is now active, and the status icon  is displayed. For image adjustment instructions, see section 13.3 *Adjusting the infrared image*, page 44.
4. Push the joystick. This displays a context menu.
 - Select  (*Cancel*) to exit edit mode.
 - Select  (*Measurement parameters*) to change the global parameters.
 - Select  (*Image mode*) to change the image mode.
 - Select  (*Measurement*) to add a measurement tool.
 - Select  (*Color*) to change the color palette or set a color alarm.
 - Select  (*Save*) to save and exit edit mode.

12.5.3 Related topics

- 15.5 *Changing object parameters*, page 54.
- 14 *Working with image modes*, page 50.
- 15 *Working with measurement tools*, page 52.
- 13.5 *Changing the color palette*, page 47.
- 16 *Working with color alarms and isotherms*, page 60.

12.6 Creating a PDF report in the camera

12.6.1 General



You can create a PDF report and save it to the memory card. You can then transfer the PDF report to a computer, iPhone, or iPad using FLIR Tools, and send the report to a customer.

12.6.2 Naming convention

The naming convention for report files is REPORTxxxx.jpg, where xxxx is a unique counter.

12.6.3 Procedure

Follow this procedure:

1. Push the Image archive button .
2. Move the joystick up/down or left/right to select an image.
3. Push the joystick to display the image.
4. Push the joystick to display a context menu.
5. Select  (*Information & reports*) and push the joystick. This displays information about the image.

6. Select *Create report* and push the joystick. The created report will be available in the archive.

12.7 Deleting an image

12.7.1 General

You can delete an image file from the memory card.

	NOTE
Note that both images in the image file (thermal and visual) will be deleted.	

12.7.2 Procedure

Follow this procedure:

1. Push the Image archive button .
2. Move the joystick up/down or left/right to select the image you want to delete.
3. Push the joystick to display the image.
4. Push the joystick and select  (*Delete*) from the menu. This displays a dialog box.
5. Use the joystick to select *Delete*. Push the joystick to confirm.

12.8 Deleting multiple images

12.8.1 General

You can delete multiple image files from the memory card.

12.8.2 Procedure

Follow this procedure:

1. Push the Image archive button .
2. Touch and hold one of the images you want to delete. This displays a context menu.
3. Touch all the other images you want to delete.

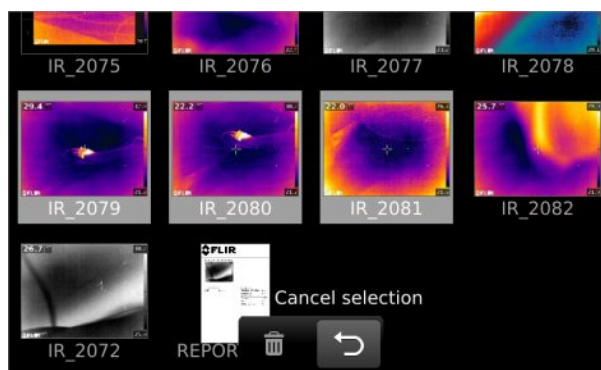

4. Use the joystick to select  (*Delete*) and push the joystick. This displays a dialog box.
5. Use the joystick to select *Delete*. Push the joystick to confirm.

12.9 Deleting all images

12.9.1 General

You can delete all image files from the memory card.

	NOTE
This will delete all files (images, videos, and reports) from the memory card.	

12.9.2 Procedure

Follow this procedure:

1. Push the joystick to display the menu system.
2. Use the joystick to go to  (*Settings*).
3. Push the joystick to display the *Settings* menu.
4. Select *Save options & storage* and push the joystick.
5. Select *Delete all saved files...* and push the joystick. This displays a dialog box where you can choose to execute the delete action or to cancel.
6. To permanently delete all saved files, select *Delete* and push the joystick.

12.10 Resetting the image counter

12.10.1 General

You can reset the numbering of the image file names.

**NOTE**

To prevent image files being overwritten, the new counter value will be based on the highest existing file name number in the image archive.

12.10.2 Procedure

Follow this procedure:

1. Push the joystick to display the menu system.
2. Use the joystick to go to  (*Settings*).
3. Push the joystick to display the *Settings* menu.
4. Select *Device settings* and push the joystick.
5. Select *Reset options* and push the joystick.
6. Select *Reset image counter...* and push the joystick. This displays a dialog box where you can choose to execute the reset action or to cancel.
7. To reset the counter, select *Reset* and push the joystick.

13.1 General

A good image depends on several different settings, although some settings affect the image more than others.

These are the settings you need to experiment with:

- Adjusting the infrared camera focus.
- Adjusting the infrared image, automatically or manually.
- Selecting a suitable temperature range.
- Selecting a suitable color palette.
- Changing object parameters.
- Calibrating the camera.

The following sections explain how to change these settings.

In some situations, you may also want to hide the overlay graphics for a better view.

13.2 Adjusting the infrared camera focus

It is very important to adjust the focus correctly. Incorrect focus adjustment affects how the image modes work. It also affects the temperature measurement.

You can adjust the focus manually by rotating the focus ring. For more information, see section 11.6 *Adjusting the infrared camera focus manually*, page 25.

You can autofocus the camera by the press of a button:

- By default, the camera will autofocus when you push the Save button half-way down.
To change the function of the Save button, select  (Settings) > Save options & storage > Save button half-press.
- You can assign the autofocus function to the programmable button **P** or **P₂**. For more information, see section 11.11 *Assigning functions to the programmable buttons*, page 29.

The infrared camera can also be set up to perform continuous autofocusing. For more information, see section 11.8 *Continuous autofocus*, page 26.

13.3 Adjusting the infrared image

13.3.1 General

An infrared image can be adjusted automatically or manually.

In automatic mode, the camera continuously adjusts the level and span for the best image presentation. The colors are distributed based on the thermal content of the image (histogram color distribution). The temperature scale to the right of the screen shows the upper and lower temperatures of the current span.

In manual mode, you can adjust the temperature scale to values close to the temperature of a certain object in the image. This will make it possible to detect anomalies and smaller temperature differences in the interesting part of the image. In manual mode, the colors are distributed evenly from the lowest to the highest temperature (linear color distribution). This is indicated by lines on the temperature scale.



There are two different settings for the manual adjustment mode:

- *Level, Span*: With this setting, you can manually adjust the level and span.
- *Level, Max, Min*: With this setting, you can manually adjust the level. You can also change the upper and lower temperatures individually.

Select the type of manual image adjustment mode under  (Settings) > Device settings > User interface options > Manual adjustment mode.

When manual image adjustment mode is active, the status icon  is displayed.

- In live mode, push the button  to switch between automatic and manual image adjustment modes. You can also switch between the modes by touching the temperature scale on the screen.
- In preview/edit mode, manual image adjustment mode is active.

	NOTE
<p>You can also assign the function <i>Auto adjust the manual temperature scale</i> to one of the programmable buttons, which allows you to perform an automatic adjustment of the image while remaining in manual image adjustment mode. Select  (<i>Settings</i>) > <i>Programmable buttons</i>.</p>	

13.3.2 Example 1

Here are two infrared images of a building. In the left image, which is auto-adjusted, the large temperature span between the clear sky and the heated building makes a correct analysis difficult. You can analyze the building in more detail if you change the temperature scale to values close to the temperature of the building.

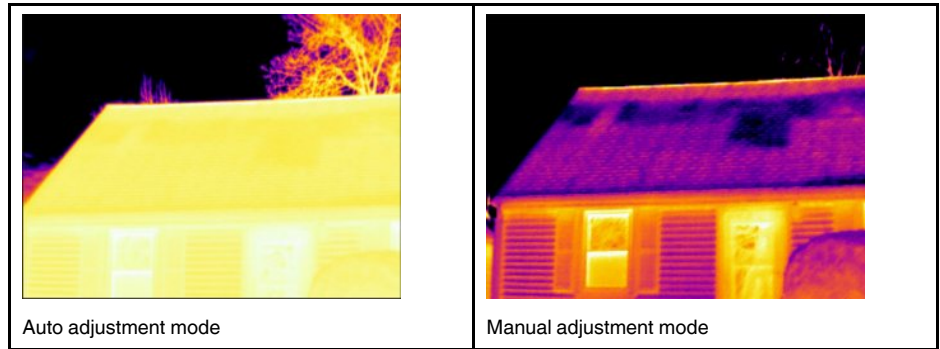

13.3.3 Example 2

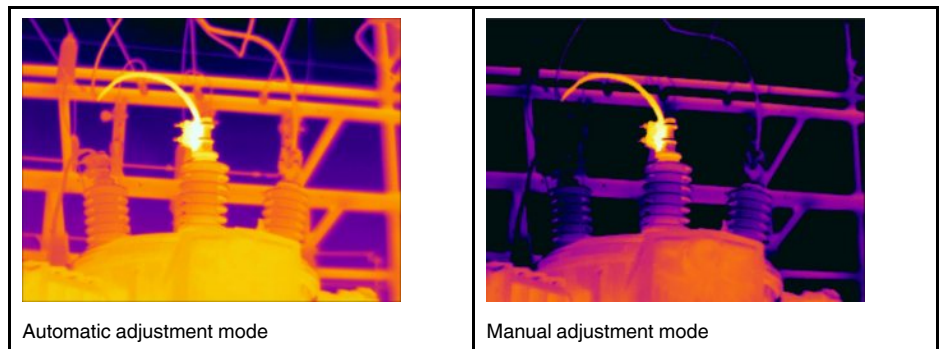

Here are two infrared images of an isolator in a power line. To make it easier to analyze the temperature variations in the isolator, the temperature in the right image has been changed to values close to the temperature of the isolator.



13.3.4 Manual adjustment in Level, Span mode

	NOTE
<p>This procedure assumes that you have configured the camera to do manual image adjustments in <i>Level, Span</i> mode. Select <i>Settings</i> > <i>Device settings</i> > <i>User interface options</i> > <i>Manual adjustment mode = Level, Span</i>.</p>	



Follow this procedure:

1. In live mode, push the button  to enter manual adjustment mode.
2. Move the joystick up/down to increase/decrease the level.
3. Move the joystick left/right to increase/decrease the span.
4. (Optional step.) In preview/edit mode, push the button  to perform a one-shot auto-adjust sequence.

13.3.5 Manual adjustment in Level, Max, Min mode

	NOTE
<p>This procedure assumes that you have configured the camera for manual image adjustments in <i>Level, Max, Min</i> mode. Select <i>Settings > Device settings > User interface options > Manual adjustment mode = Level, Max, Min</i>.</p>	

Follow this procedure:

1. In live mode, push the button  to enter manual adjustment mode.
2. To simultaneously change the temperature scale minimum and maximum limits, move the joystick up/down.
3. To change the minimum limit or the maximum limit, do the following:
 - Move the joystick left/right to select (highlight) the maximum or minimum temperature.
 - Move the joystick up/down to change the value of the highlighted temperature.
4. (Optional step.) In preview/edit mode, push the button  to perform a one-shot auto-adjust sequence.

13.4 Changing the temperature range

13.4.1 General

You must change the temperature range according to the expected temperature of the object you are inspecting.

13.4.2 Procedure

Follow this procedure:

1. Push the joystick to display the menu system.
2. Use the joystick to go to  (*Settings*).
3. Push the joystick to display the *Settings* menu.
4. Select *Camera temperature range* and push the joystick.
5. Select the appropriate temperature range and push the joystick.

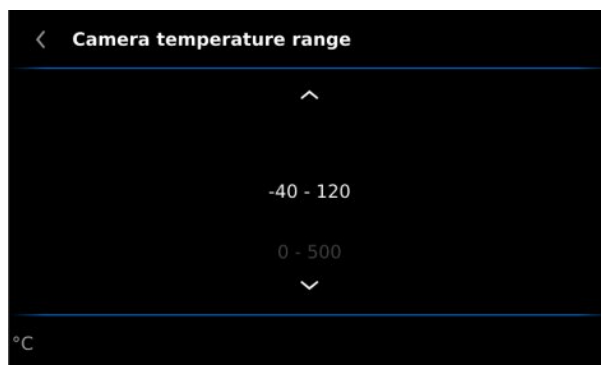

 **NOTE**

You can also assign the function *Switch temperature range* to one of the programmable buttons. Select  (*Settings*) > *Programmable buttons*.

13.5 Changing the color palette

13.5.1 General

You can change the color palette that the camera uses to display different temperatures. A different palette can make it easier to analyze an image.

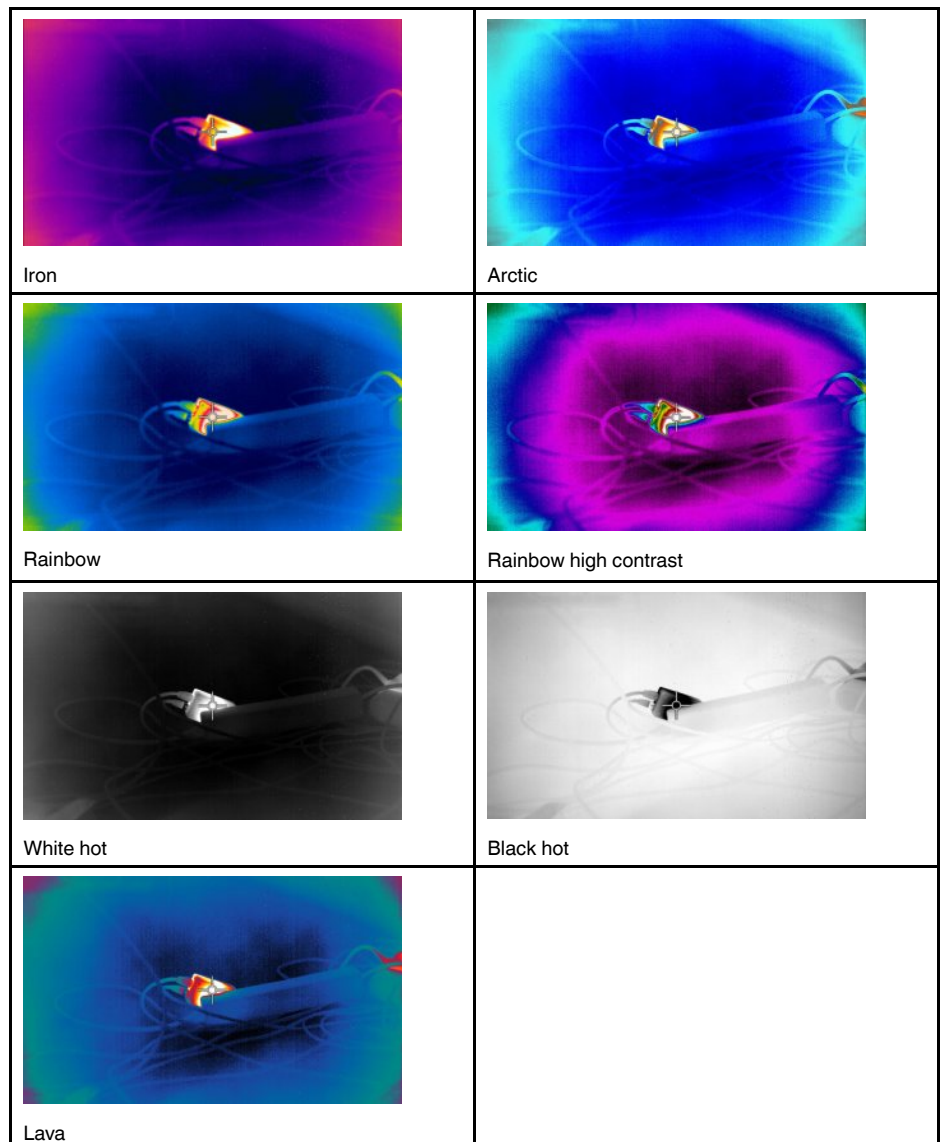

13.5.2 Procedure

Follow this procedure:

1. Push the joystick to display the menu system.
2. Use the joystick to go to  (*Color*).
3. Push the joystick to display a submenu.
4. Use the joystick to select a different palette.

5. Push the joystick.

13.6 Changing the object parameters

For accurate measurements, you must set the object parameters:

- *External IR window compensation.*
- *Object distance.*
- *Atmospheric temperature.*
- *Relative humidity.*
- *Reflected temperature.*
- *Emissivity.*

You can set the object parameters globally. You can also change the *Emissivity*, *Reflected temperature*, and *Object distance* parameters locally for a measurement tool.

For more information, see section 15.5 *Changing object parameters*, page 54.

13.7 Calibrating the camera

13.7.1 General

The calibration of the camera is performed as a non-uniformity correction (NUC). A NUC is an *image correction carried out by the camera software to compensate for different sensitivities of detector elements and other optical and geometrical disturbances*¹.

Calibration is needed whenever the output image becomes spatially noisy. The output can become spatially noisy when the ambient temperature changes (such as from day to night operation, and vice versa).

The calibration is carried out automatically when needed. It is also possible to perform a calibration manually.

While the calibration is in progress, the text *Calibrating...* is displayed.



13.7.2 Manual calibration

You may, for example, want to perform a manual calibration just before you start recording a video sequence.

13.7.2.1 Procedure

Follow this procedure:

1. To perform a manual calibration, push and hold the Image archive button  for more than 2 seconds.

	NOTE
<p>You can also assign the function <i>Calibrate</i> to one of the programmable buttons. Select  (<i>Settings</i>) > <i>Programmable buttons</i> .</p>	

13.8 Hiding all overlay

13.8.1 General

The camera overlay consists of overlay graphics and image overlay information. The overlay graphics include items such as measurement tool symbols, result tables, and status icons. The image overlay information, which you activate on the *Settings* menu, provides additional information such as the date, emissivity, and atmospheric temperature.

You can choose to hide all camera overlay by the press of a programmable button.

1. Definition from the impending international adoption of DIN 54190-3 (Non-destructive testing – Thermographic testing – Part 3: Terms and definitions).

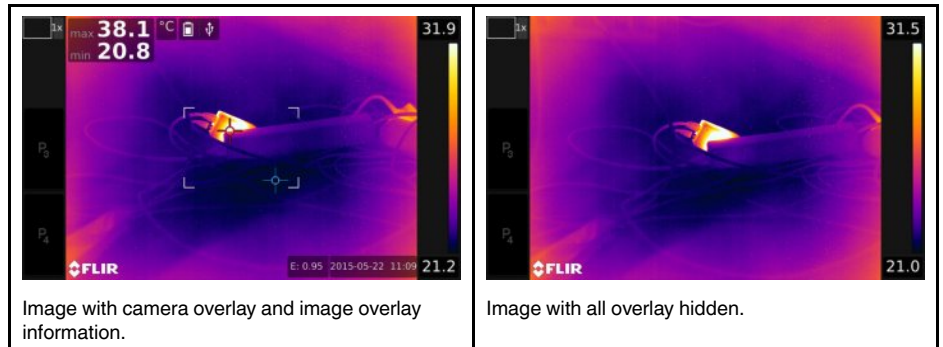

13.8.2 Procedure

Follow this procedure:

1. Push the joystick to display the menu system.
2. Use the joystick to go to  (*Settings*).
3. Push the joystick to display the *Settings* menu.
4. Select *Programmable buttons* and push the joystick.
5. Select one of the buttons and push the joystick.
6. Select *Hide image overlay graphics* and push the joystick. You have now assigned this function to the selected programmable button.

14.1 General

The camera captures both thermal and visual images at the same time. By your choice of image mode, you select which type of image to display on the screen.

The camera supports the following image modes:

- *Thermal MSX* (Multi Spectral Dynamic Imaging): The camera displays infrared images where the edges of the objects are enhanced with visual image details.
- *Thermal*: A full infrared image is displayed.
- *Picture in picture*: An infrared image frame is displayed on top of the visual image.
- *Digital camera*: The visual image captured by the digital camera is displayed.

	NOTE
<p>These image modes only work correctly for calibrated lenses. The lens that ships with the camera is factory calibrated. To have a new lens calibrated, you must send in the camera and the lens to your local service department.</p>	

	NOTE
<p>All thermal and visual information is stored when an image is saved. This means that you can edit the image later, in the image archive or in FLIR Tools, and select any of the image modes.</p>	

14.2 Image examples

This table explains the different types of image modes.

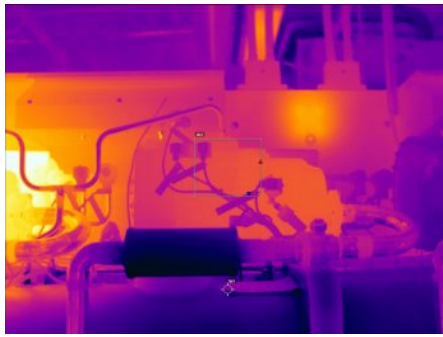

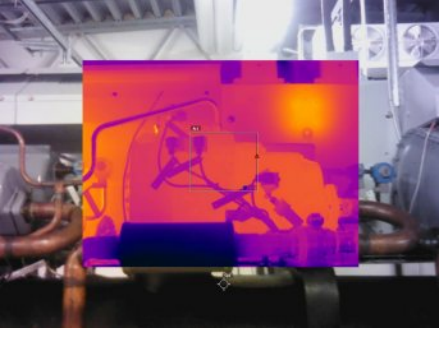





Image mode	Image
<i>Thermal</i>	
<i>Thermal MSX</i>	

Image mode	Image
<i>Picture in picture</i>	
<i>Digital camera</i>	

14.3 Selecting the image mode

Follow this procedure:

1. Push the joystick to display the menu system.
2. Use the joystick to go to  (*Image mode*).
3. Push the joystick to display a submenu.
4. Use the joystick to go to one of the image modes:
 -  (*Thermal MSX*)
 -  (*Thermal*)
 -  (*Picture in picture*)
 -  (*Digital camera*)



NOTE

If the *.csq video format is selected (*Settings > Save options & storage > Video compression*) and the recording mode *Video* is selected, it will only be possible to select the image mode *Thermal*.

5. Push the joystick confirm.
6. If *Picture in picture* mode is selected, you can at this point move and resize the image frame using the touch screen.





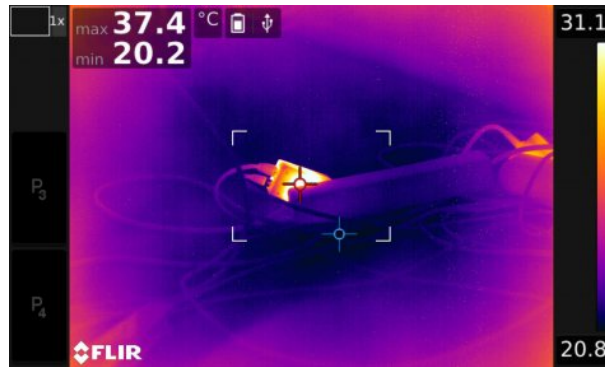

15.1 General

To measure a temperature, you can use one or more measurement tools, e.g., a spot-meter or a box.



15.2 Adding/removing measurement tools

Follow this procedure:

1. Push the joystick to display the menu system.
2. Use the joystick to go to  (*Measurement*).
3. Push the joystick to display a submenu.
 - Select  (*No measurements*) to remove all tools.
 - Select  (*Center spot*) to add a center spot.
 - Select  (*Hot spot*) to add a hot spot detection within a box area.
 - Select  (*Cold spot*) to add a cold spot detection within a box area.
 - Select  (*User preset 1*) to add user preset 1. (Not available in all camera models.)
 - Select  (*User preset 2*) to add user preset 2. (Not available in all camera models.)
4. Push the joystick. This displays the measurement tool or the group of preset tools on the screen.

15.3 Working with user presets









15.3.1 General

A user preset is a measurement tool, or a group of measurement tools, with predefined characteristics.

15.3.2 Procedure

Follow this procedure:

1. Push the joystick to display the menu system.
2. Use the joystick to go to  (*Settings*).
3. Push the joystick to display the *Settings* menu.
4. Select *Define user presets* and push the joystick.
5. Select *Define preset 1* or *Define preset 2* and push the joystick. This displays a context menu.

6. Select  (*Add measurement*).
7. Push the joystick. This displays a submenu.
 - Select  (*Add spot*) to add a spot.
 - Select  (*Add box*) to add a box.
 - Select  (*Add circle*) to add a circle.
 - Select  (*Add line*) to add a line.
 - Select  (*Add delta*) to set up a differential calculation.
8. Push the joystick. This displays the measurement tool on the screen.
9. Push the joystick. This displays a context menu, where you can select one or more of the following actions (depending on the type of tool):
 - Remove the tool.
 - Resize, move, center, rotate the tool.
 - Display maximum, minimum, average values.
 - Set alarms.
 - Set local parameters.
 - When completed, select  (*Done*).
10. When all measurement tools have been added, select  (*Save as preset*).

15.4 Resizing or moving a measurement tool

15.4.1 General

You can resize and move a measurement tool.

15.4.2 Procedure



	NOTE
<ul style="list-style-type: none"> • This procedure assumes that you have previously laid out a measurement tool or user preset on the screen. • You can also move and resize the measurement tool by touching the screen. 	

Follow this procedure:

1. To select the measurement tool, touch the tool on the screen. The tool is now displayed with one or more handles.

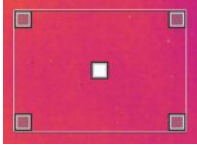
Spot measurement tool: 

Area measurement tool: 

2. Push the joystick—or touch and hold the tool. This displays a context menu.
 - Select  (*Resize*) to change the size of the tool.
 - Select  (*Move*) to move the tool.
3. Move the joystick up/down and left/right to resize or move the tool.

4. When completed, push the joystick and select  (Done).

15.5 Changing object parameters

15.5.1 General

For accurate measurements, you must set the object parameters.

15.5.2 Types of parameters

The camera can use these object parameters:

- *External IR window compensation*, i.e., the temperature of any protective windows, external lenses (e.g., close-up), etc., that are set up between the camera and the object of interest. If no protective window, protective shield, or external lens is used, this value is irrelevant and should be left inactive.
- *Object distance*, i.e., the distance between the camera and the object of interest.
- *Atmospheric temperature*, i.e., the temperature of the air between the camera and the object of interest.
- *Relative humidity*, i.e., the relative humidity of the air between the camera and the object of interest.
- *Reflected temperature*, which is used when compensating for the radiation from the surroundings reflected by the object into the camera. This property of the object is called reflectivity.
- *Emissivity*, i.e., how much radiation an object emits, compared with the radiation of a theoretical reference object at the same temperature (called a “blackbody”). The opposite of emissivity is reflectivity. The emissivity determines how much of the radiation originates from the object as opposed to being reflected by it.



NOTE

There is an *Emissivity mode* setting, which you can use to enter the emissivity by material instead of by value. Select  (Settings) > Device settings > User interface options > Emissivity mode > Select from materials table.

Of the object parameters, *Emissivity* is the most important parameter to set correctly. If the *Emissivity* is set to a low value, the *Reflected temperature* also becomes important. The parameters *Object distance*, *Atmospheric temperature*, and *Relative humidity* are relevant for longer distances. The *External IR window compensation* must be activated if a protective window or external lens is used.

15.5.3 Recommended values

If you are unsure about the values, the following are recommended:

Object distance	1.0 m (3.3')
Atmospheric temperature	+20°C (+69°F)
Relative humidity	50%
Reflected temperature	+20°C (+69°F)
Emissivity	0.95

15.5.4 Procedure







You can set the object parameters globally. You can also change the *Emissivity*, *Reflected temperature*, and *Object distance* parameters locally for a measurement tool.

Local parameters are normally only effective for a fixed setup, where each measurement tool is set to a specific object of interest. In a general handheld application, the global parameters are usually sufficient.

 NOTE
<p>Of the object parameters, <i>Emissivity</i> and <i>Reflected temperature</i> are the two most important to set correctly in the camera.</p>

15.5.4.1 Setting global parameters

Follow this procedure:

1. Push the joystick to display the menu system.
2. Use the joystick to go to  (*Measurement parameters*).
3. Push the joystick to display a submenu. Use the joystick to select one or more of the global object parameters:
 -  (*External IR window compensation*)
 -  (*Object distance*)
 -  (*Atmospheric temperature*)
 -  (*Relative humidity*)
 -  (*Reflected temperature*)
 -  (*Emissivity*)
4. Push the joystick to display a dialog box.
5. Use the joystick to change the parameter.
6. Push the joystick. This closes the dialog box.



15.5.4.2 Changing local parameters

You can change the local parameters for a measurement tool.

A *P* next to the measurement tool on the screen indicates that local parameters are activated for the tool.



Follow this procedure:

1. To select the measurement tool, touch the tool on the screen. The tool is now displayed with one or more handles.
2. Push the joystick — or touch and hold the tool. This displays a context menu.
3. Use the joystick to go to  (*Use local parameters*).
4. Push the joystick.  (icon with grey indicator) is displayed.
5. Push the joystick to activate the use of local parameters.  (icon with blue indicator) is displayed together with a submenu.

6. Use the joystick to select an object parameter.
7. Push the joystick to display a dialog box.
8. Use the joystick to change the parameter.
9. Push the joystick. This closes the dialog box.

15.5.5 Related topics

For in-depth information about parameters, and how to correctly set the emissivity and reflected apparent temperature, see section 30 *Thermographic measurement techniques*, page 157.

15.6 Displaying values in the result table and displaying a graph

15.6.1 General





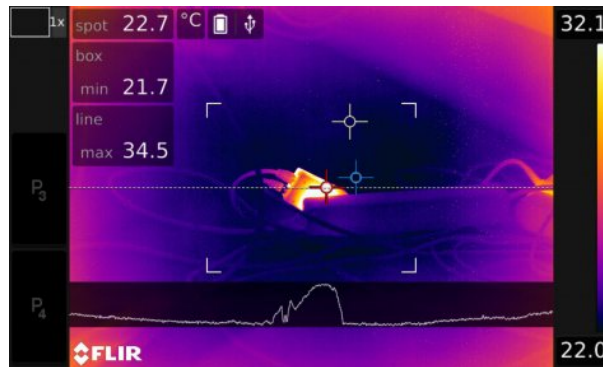





For the box, circle, and line tools, you can set the camera to display the maximum, minimum, and average values in the result table.

For the line tool, you can also display a graph.



15.6.2 Procedure

Follow this procedure:

1. To select the measurement tool, touch the tool on the screen. The tool is now displayed with one or more handles.
2. Push the joystick—or touch and hold the tool. This displays a context menu.
3. Use the joystick to go to (depending on the tool) , , or  (*Max/Min/Avg/Alarm*) or (*Graph/Max/Min/Avg/Alarm*).
4. Push the joystick. This displays a submenu.
 - (Option available for the line tool.) Select  (*Graph*) and push the joystick to display a graph.
 - Select  (*Max*) and push the joystick to display the maximum value.
 - Select  (*Min*) and push the joystick to display the minimum value.
 - Select  (*Avg*) and push the joystick to display the average value.
 - (Optional step.) You can choose to show or hide the maximum and minimum markers (the hot/cold spots). Select  (*Max & min markers*) and push the joystick to toggle:
 - When  (icon with grey indicator) is displayed, the markers are hidden.
 - When  (icon with blue indicator) is displayed, the markers are shown.

5. When completed, move the joystick down to close the submenu.
6. Select  (*Done*) and push the joystick.

15.7 Creating and setting up a difference calculation

15.7.1 General





A difference calculation gives the difference between the values of two known measurement results.

15.7.2 Procedure

	NOTE
<ul style="list-style-type: none"> • You can set up a difference calculation when defining user presets, or when editing an image in the archive. • This procedure assumes that you have previously laid out at least one measurement tool on the screen. 	

15.7.2.1 Procedure

Follow this procedure:

1. To set up a difference calculation, do the following:
 - If you are defining user presets, select  (*Add measurement*) and then select  (*Add delta*).
 - If you are editing an image in the archive, select  (*Measurement*) and then select  (*Add delta*).
2. Push the joystick. This displays a dialog box where you can select the measurement tools that you want to use in the difference calculation. You can also select a fixed-temperature reference.

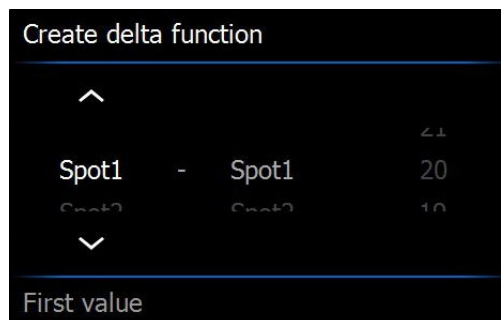

3. Push the joystick. The result of the difference calculation is now displayed on the screen.

15.8 Setting a measurement alarm

15.8.1 General

You can make the camera trigger an alarm when certain measurement conditions are met.

15.8.2 Types of alarm



You can choose between the following alarm types:

- *Above*: Triggers an alarm when the temperature is above the preset alarm temperature.

- *Below*: Triggers an alarm when the temperature is below the preset alarm temperature.

15.8.3 Alarm signals

When an alarm is set, the symbol  is displayed in the result table.

When an alarm is triggered, the value in the result table is displayed in red (above alarm) or blue (below alarm) and the symbol  (above alarm) or  (below alarm) is blinking. You can also set an audible alarm (there will be a “beep” when the alarm is triggered).

15.8.4 Procedure

There are different procedures for setting up an alarm for a spot, box, circle, or line and for a difference calculation.

15.8.4.1 Setting up an alarm for a spot





Follow this procedure:

1. To select the spot, touch the tool on the screen. The tool is now displayed with a frame.
2. Push the joystick—or touch and hold the tool. This displays a context menu.
3. Use the joystick to go to  (*Set alarm on spot*).
4. Push the joystick. This displays a dialog box where you can define the settings for the alarm.
 - *Alarm condition*: The condition that triggers the alarm. Applicable values are *Above*, *Below*, or *Off*.
 - *Alarm limit*: The temperature value that will be the critical condition when an alarm is triggered or not.
 - *Alarm sound*: Applicable values are *Beep* or *No sound*.
5. Push the joystick. This closes the dialog box.

15.8.4.2 Setting up an alarm for a box, circle, or line

	NOTE
<ul style="list-style-type: none"> • This procedure assumes that you have previously set the camera to display at least one value (maximum, minimum, or average) in the result table. 	

Follow this procedure:





1. To select the measurement tool, touch the tool on the screen. The tool is now displayed with one or more handles.
2. Push the joystick — or touch and hold the tool. This displays a context menu.
3. Use the joystick to go to (depending on tool) , , or  (*Max/Min/Avg/Alarm*) or (*Graph/Max/Min/Avg/Alarm*).
4. Push the joystick. This displays a submenu.
5. Select  (*Set alarm*).
6. Push the joystick. This displays a dialog box where you can define the settings for the alarm.
 - *Alarm condition*: The condition that triggers the alarm. Applicable values are *Above*, *Below*, or *Off*.
 - *Select measurement*: Applicable settings are the values you have previously defined (*Max*, *Min*, and/or *Avg*).
 - *Alarm limit*: The temperature value that will be the critical condition when an alarm is triggered or not.
 - *Alarm sound*: Applicable values are *Beep* or *No sound*.

7. Push the joystick. This closes the dialog box.

15.8.4.3 Setting up an alarm for a difference calculation

 NOTE
<ul style="list-style-type: none">• You can set up an alarm for a difference calculation when defining user presets, or when editing an image in the archive.• This procedure assumes that you have previously set up a difference calculation.

Follow this procedure:

1. To set up an alarm for a difference calculation, do the following:
 - If you are defining user presets, select  (*Add measurement*). This displays a submenu.
 - If you are editing an image in the archive, select  (*Measurement*). This displays a submenu.
2. Select  (*Select*). This displays a dialog box.
3. Select *Delta*. This displays a context menu.
4. Use the joystick to go to  (*Set alarm on delta*).
5. Push the joystick. This displays a dialog box where you can define the settings for the alarm.
 - *Alarm condition*: The condition that triggers the alarm. Applicable values are *Above*, *Below*, or *Off*.
 - *Alarm limit*: The temperature value that will be the critical condition when an alarm is triggered or not.
 - *Alarm sound*: Applicable values are *Beep* or *No sound*.
6. Push the joystick. This closes the dialog box.

16.1 Color alarms

16.1.1 General

By using color alarms (isotherms), anomalies can easily be discovered in an infrared image. The isotherm command applies a contrasting color to all pixels with a temperature above, below, or between the set temperature levels. The camera also features isotherm types that are specific to the building trade: condensation and insulation alarms.

You can make the camera trigger the following types of color alarms:

- *Above alarm*: This will apply a contrasting color to all pixels with a temperature above the specified temperature level.
- *Below alarm*: This will apply a contrasting color to all pixels with a temperature below the specified temperature level.
- *Interval alarm*: This will apply a contrasting color to all pixels with a temperature between two specified temperature levels.
- *Condensation alarm*: Triggers when the camera detects a surface where the relative humidity exceeds a preset value.
- *Insulation alarm*: Triggers when there is an insulation deficiency in a wall.

16.1.2 Image examples



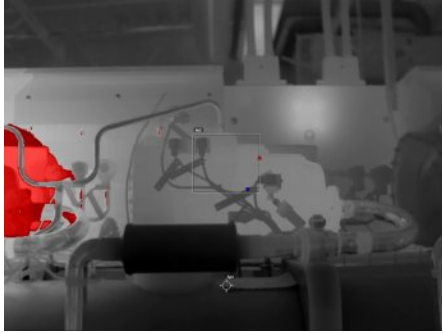
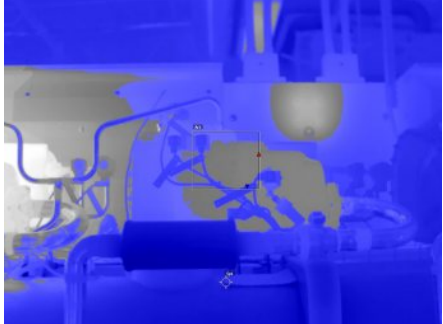

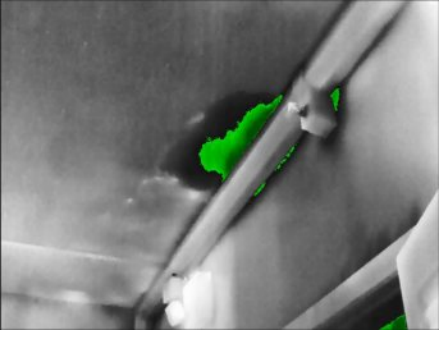
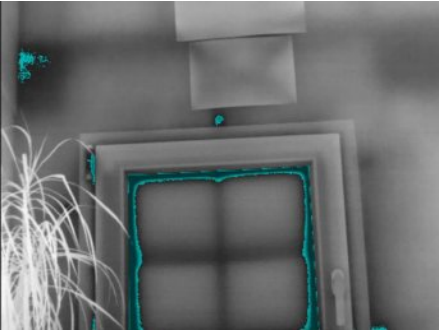
This table explains the different color alarms (isotherms).

Color alarm	Image
<i>Above alarm</i>	
<i>Below alarm</i>	

Color alarm	Image
<i>Interval alarm</i>	
<i>Condensation alarm</i>	
<i>Insulation alarm</i>	

16.2 Setting up above, below, and interval alarms

Follow this procedure:

1. Push the joystick to display the menu system.
2. Use the joystick to go to  (*Color*).
3. Push the joystick to display a submenu. Use the joystick to select the type of alarm:
 -  (*Above alarm*)
 -  (*Below alarm*)
 -  (*Interval alarm*)
4. Push the joystick. The threshold temperature is displayed at the top of the screen.
5. To change the threshold temperature, do the following:
 - For the *Interval alarm*, move the joystick left/right to select the low/high-temperature value.
 - Move the joystick up/down to change the threshold temperature.

16.3 Building isotherms



NOTE

The Condensation and Insulation alarms are not supported by all camera models.

16.3.1 About the Condensation alarm

To detect areas with potential moisture problems, you can use the *Condensation alarm*. You can set the relative humidity above which the isotherm will colorize the image.



16.3.2 About the Insulation alarm

The *Insulation alarm* can detect areas where there may be an insulation deficiency in the building. It will trigger when the insulation level (which is called the thermal index in the camera) falls below a preset value of the energy leakage through a wall.

Different building codes recommend different values for the insulation level, but typical values are 60–80% for new buildings. Refer to your national building code for recommendations.

16.3.3 Setting up condensation and insulation alarms

Follow this procedure:

1. Push the joystick to display the menu system.
2. Use the joystick to go to  (*Color*).
3. Push the joystick to display a submenu. Use the joystick to select the type of alarm:
 -  (*Condensation alarm*)
 -  (*Insulation alarm*)
4. Push the joystick. This displays a dialog box where you can define the settings for the alarm.

For the *Condensation alarm*, the following parameters can be set:

- *Atmospheric temperature*: The current atmospheric temperature.
- *Relative humidity*: The current relative humidity.
- *Relative humidity limit*: The relative humidity level at which you want the alarm to be triggered. A relative humidity of 100% means that water vapor condenses from the air as liquid water (= dewpoint). A relative humidity of about 70% or above can cause mold.

For the *Insulation alarm*, the following parameters can be set:

- *Indoor temperature*: The current indoor temperature.
- *Outdoor temperature*: The current outdoor temperature.
- *Thermal index*: The insulation level, an integer between 0 and 100.

5. Push the joystick. This closes the dialog box.

17.1 General

You can save additional information together with an infrared image by using annotations. Annotations make reporting and post-processing more efficient, by providing essential information about the image, e.g., conditions and information about where an image is taken.

Annotations are added to the image file, and can be viewed and edited in the image archive, and also when moving files from the camera to reporting software on the computer.

- You can set the camera to display annotation tools before an image is saved. Select  (Settings) > Save options & storage > Add annotation after saving.
- You can also add annotations to a saved image in the image archive.

	NOTE
This section describes the procedures for adding annotations to a saved image in the image archive. Adding annotations when saving an image works in a similar way.	

17.2 Adding a note

17.2.1 General

You can add a text note to the image file. Using this feature, you can annotate images by entering free-form text.

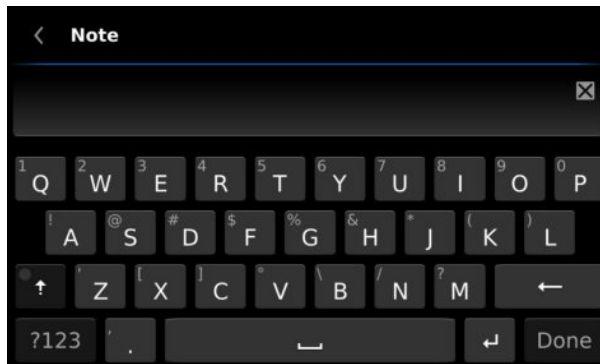

17.2.2 Procedure

Follow this procedure:

1. Open the image in the image archive.
2. Push the joystick. This displays a context menu.
3. Select  (Add note).
4. Push the joystick. This displays a soft keyboard where you can enter the text you want to save by touching the screen.

	NOTE
To select special characters, press and hold down the corresponding key on the soft keyboard.	

5. When completed, touch *Done* on the soft keyboard.

17.3 Adding a table

17.3.1 General

You can save a table with textual information to the image file. This feature is a very efficient way of recording information when you are inspecting a large number of similar



objects. The idea behind using a table with textual information is to avoid filling out forms or inspection protocols manually.

The camera has a number of default table templates. You can also import your own table templates from FLIR Tools—refer to the FLIR Tools user's manual. The templates are stored on the memory card.

Inspection - default	
Site	Company A
Location	Substation A
Object	
ObjectID	
Deviation	

17.3.2 Procedure

Follow this procedure:

1. Open the image in the image archive.
2. Push the joystick. This displays a context menu.
3. Select  (*Add table*) and push the joystick.
4. Select  (*Add table contents*) and push the joystick. This displays the default table template that ships with the camera.

 **NOTE**

You can select another template by first selecting  (*Select default template*).

5. For each row in the table, do the following:
 - Push the joystick. This displays the predefined values.
 - Move the joystick up/down to select a predefined value. Push the joystick to confirm.
 - Instead of selecting a predefined value, you can select the keyboard  and enter other text by touching the screen.
6. When completed, select *Save & Exit* at the bottom of the table. Push the joystick to confirm.

17.4 Adding a voice annotation

17.4.1 General







A voice annotation is an audio recording that is saved to the infrared image file. The recording can be played back in the camera, and in image analysis and reporting software from FLIR Systems.

The voice annotation is recorded using a Bluetooth headset. For information on how to pair a headset with the camera, see section 21 *Pairing Bluetooth devices*, page 70.



17.4.2 Procedure

Follow this procedure:

1. Open the image in the image archive.
2. Push the joystick. This displays a context menu.
3. Select  (Add voice annotation) and push the joystick.
4. To start a recording, select  (Record) and push the joystick.
5. To stop the recording, select  (Stop) and push the joystick.
6. To listen to the recording, select  (Play) and push the joystick.
7. To delete the recording, select  (Delete) and push the joystick.
8. When completed, select  (Done) and push the joystick.

17.5 Adding a sketch

17.5.1 General

You can add a freehand drawing to an image.







17.5.2 Procedure

Follow this procedure:

1. Open the image in the image archive.
2. Push the joystick. This displays a context menu.
3. Select  (Add sketch) and push the joystick.
4. You are now in sketch mode. Draw the sketch by touching the screen.

5. Push the joystick. This displays a context menu. Do one or more of the following:

- To change the color of the sketch tools, select  (*Draw*) and push the joystick. Select the color and push the joystick.
- To erase, select  (*Eraser*) and push the joystick. Erase parts of the sketch by touching the screen.
- To add an arrow, circle, or cross, select  (*Stamp sketch*) and push the joystick. Select the type of stamp and push the joystick. The stamp is displayed in the center of the screen. You can move the stamp by using the joystick or by touching the screen.
- To clear, select  (*Clear all*) and push the joystick.
- When the sketch is completed, select  (*Save*) and push the joystick.

Programming the camera (time lapse)



18.1 General

You can program the camera to save images periodically (time lapse).



18.2 Procedure

Follow this procedure:

1. Push the joystick to display the menu system.
2. Use the joystick to go to  (*Recording mode*).
3. Push the joystick. This displays a submenu.
4. Select  (*Time lapse*).
5. Push the joystick. This displays a dialog box, where you can set the save conditions:
 - *Save interval*: Use the joystick to set the time interval between each saved image.
 - *Total number of images*: The periodic saving will stop when the set number of images have been saved.
6. Push the joystick. This closes the dialog box. The time interval is displayed at the top of the screen.
7. To manually start or stop the periodic saving, briefly push and release the Save button.

19.1 General

You can record and save video clips to the memory card.

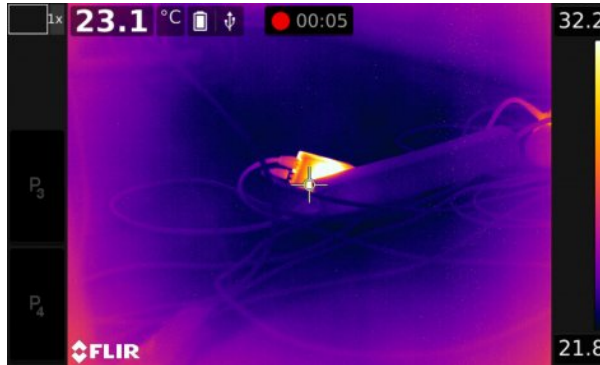



NOTE

The camera can be configured to save video in *.mpg or *.csq format. Select  (*Settings*) > *Save options & storage* > *Video compression*.

- *Mpeg (*.mpg)*: Mpeg recordings cannot be edited after the file has been saved.
- *Radiometric storage (*.csq)*: A csq file supports full radiometry but is only supported by FLIR Systems software. The file does not include any visual image information. With this setting, only the image mode *Thermal* is supported when recording video. If any other image mode is active when the recording mode *Video* is selected, the camera will auto-switch to the *Thermal* image mode.

19.2 Procedure

Follow this procedure:

1. Push the joystick to display the menu system.
2. Use the joystick to go to  (*Recording mode*).
3. Push the joystick. This displays a submenu.
4. Select  (*Video*) and push the joystick.
5. Do the following:
 - To start a recording, push and release the Save button. A counter at the top of the screen displays the duration of the recording.
 - To stop a recording, push and release the Save button.
6. The recording is automatically saved to the image archive, where you can play or delete it.

20.1 General

The screening alarm can be used, for example, at airports to detect passengers with elevated body temperatures, which may indicate the presence of a fever.

The screening alarm can also be used to detect temperature anomalies in a series of inspected objects in a similar/fixed setup.

Activating the screening alarm will turn on a measurement box and screening data in the result table.



 The sampled average temperature.

 The alarm temperature.



 The measured temperature.

The alarm will trigger when the measurement box measures a temperature higher than the alarm temperature. The alarm temperature is, in turn, the sum of a specified allowed deviation and a sampled average value.

20.2 Procedure

	NOTE
<p>The screening mode must be enabled. Select  (Settings) > Device settings > User interface options > Screening mode = On.</p>	

Follow this procedure:

1. Push the joystick to display the menu system.
2. Use the joystick to go to  (Recording mode).
3. Push the joystick. This displays a submenu.
4. Select  (Screening).
5. Push the joystick. This displays a dialog box where you can define the settings for the alarm.
 - *Allowed deviation*: The allowed deviation from the sampled average.
 - *Alarm sound*: Applicable values are *Beep* or *No sound*.
6. Push the joystick. This closes the dialog box.
7. Aim the camera toward a point of interest. The object should be within the frame of the measurement box.
8. Push and hold the programmable button **P** to reset the sampled average.
9. Push the programmable button **P** to sample.
10. Aim the camera toward more points of interest. Sample 10 times to build up a sample base by pushing the programmable button **P**.

The alarm is now set up and ready to use. Occasionally record a few samples if the alarm is used for a long time or if the conditions change.

	NOTE
<ul style="list-style-type: none"> • The algorithm has a memory of the last 10 samples. It discriminates between the highest and lowest values, and calculates an average of the remaining values. • Do not modify the measurement setup or activate another alarm because this will deactivate the screening alarm. 	

21.1 General

Before you can use a Bluetooth device with the camera, you need to pair the devices.

21.2 Procedure

Follow this procedure:

1. Push the joystick to display the menu system.
2. Use the joystick to go to  (*Settings*).
3. Push the joystick to display the *Settings* menu.
4. Select *Device settings* and push the joystick.
5. Depending on the camera configuration, select *Wireless & geolocation*, *Wireless*, or *Geolocation* and push the joystick.
6. Select *Bluetooth* and push the joystick.
7. If the *Bluetooth* check box is unchecked, push the joystick to activate Bluetooth.



NOTE

You also need to activate Bluetooth connectivity on the external device.

8. Select *Available devices* and push the joystick.
9. Wait until a list of available devices is displayed. This will take about 15 seconds.
10. When a Bluetooth device is found, select the device to add it, and begin the pairing procedure. The device is then ready to be used.



NOTE

- Only Bluetooth-enabled headsets will appear in the list of available devices.
- You can add several devices.
- You can remove a device by selecting the device and then selecting *Unpair device*.
- After adding a Bluetooth-enabled headset, it is ready to be used for adding voice annotations.

22.1 General

Depending on your camera configuration, you can connect the camera to a wireless local area network (WLAN) using Wi-Fi, or let the camera provide Wi-Fi access to other devices.

You can connect the camera in two different ways:

- *Most common use*: Setting up the camera as a wireless access point. This method is primarily used with other devices, e.g., an iPhone or iPad.
- *Less common use*: Connecting the camera to a WLAN.

22.2 Setting up a wireless access point (most common use)

Follow this procedure:

1. Push the joystick to display the menu system.
2. Use the joystick to go to  (*Settings*).
3. Push the joystick to display the *Settings* menu.
4. Select *Device settings* and push the joystick.
5. Depending on the camera configuration, select *Wireless & geolocation*, *Wireless*, or *Geolocation* and push the joystick.
6. Select *Wi-Fi* and push the joystick.
7. Select *Share* and push the joystick.
8. (Optional step.) To display and change the parameters, select *Share settings* and push the joystick.
 - To change the SSID, select *Network name (SSID)* and push the joystick.
 - To change the WEP password, select *Password* and push the joystick.



NOTE

These parameters are set for your camera's network. They will be used by the external device to connect that device to the network.

22.3 Connecting the camera to a wireless local area network (less common use)

Follow this procedure:

1. Push the joystick to display the menu system.
2. Use the joystick to go to  (*Settings*).
3. Push the joystick to display the *Settings* menu.
4. Select *Device settings* and push the joystick.
5. Depending on the camera configuration, select *Wireless & geolocation*, *Wireless*, or *Geolocation* and push the joystick.
6. Select *Wi-Fi* and push the joystick.
7. Select *Connect to network* and push the joystick.
8. To display a list of the available networks, select *Networks* and push the joystick.
9. Select one of the available networks.

Password-protected networks are indicated with a padlock icon, and for these you will need to enter a password the first time you connect to the network. After that the camera will connect automatically to the network. To disable the automatic connection, select *Forget network*.



NOTE

Some networks do not broadcast their existence. They appear in the list as *Untitled*. To connect to such a network, you will be prompted to enter additional parameters.

23.1 General

You can change a variety of settings in the camera. You do this on the *Settings* menu.

The *Settings* menu includes the following:

- *Define user presets.*
- *Camera temperature range.*
- *Save options & storage.*
- *Programmable buttons.*
- *Device settings.*

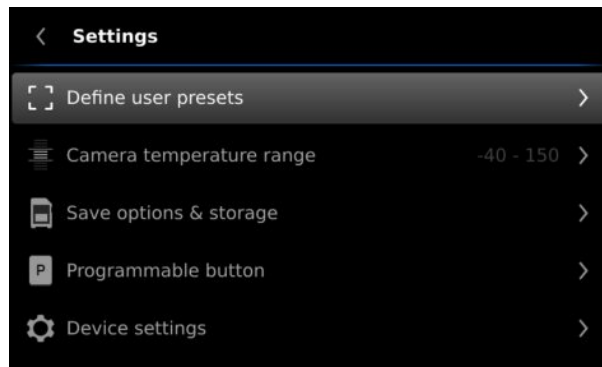

23.1.1 Define user presets

A user preset is a measurement tool, or a group of measurement tools, with predefined characteristics. For more information, see section 15.3 *Working with user presets*, page 52.

- *Define preset 1:* This setting defines user preset 1.
- *Define preset 2:* This setting defines user preset 2.

23.1.2 Camera temperature range

For accurate temperature measurements, you must change the *Camera temperature range* setting according to the expected temperature of the object you are inspecting.

Available temperature range options are dependent on the camera model. The unit (°C or °F) depends on the temperature unit setting, see section 23.1.5 *Device settings*, page 74.

23.1.3 Save options & storage

- *Save button half-press:* This setting defines the function of the Save button. Available options are:
 - *Autofocus:* Pushing the Save button half-way down will autofocus the camera. This is the default setting.
 - *None:* Pushing the Save button half-way down will have no effect. With this setting, you may want to assign the autofocus function to one of the programmable buttons.
- *Preview image before saving:* This setting defines if a preview image will be displayed before the image is saved.
- *Add annotation after saving:* This setting defines if an annotation tool will be displayed when the image has been saved. Available options are:
 - *Save:* No annotation tool will be displayed.
 - *Save & add note:* The note annotation tool will be displayed.
 - *Save & add table:* The table annotation tool will be displayed. This setting also allows you to define the type of table. Available options are the default table templates. You can also create your own table in FLIR Tools and upload it to the camera.

- *Save & add voice annotation*: The voice annotation tool will be displayed.
- *Save & add sketch*: The sketch annotation tool will be displayed.
- *Save & add any annotation*: The annotation tool menu will be displayed.
- *Image resolution*: This setting defines the resolution of the images captured by the camera. Available options are *Normal* and *Ultramax*. For more information, see section 12.1.4 *About UltraMax*, page 39.
- *Video compression*: This setting defines the storage format for video clips. Available options are:
 - *Mpeg (*.mpeg)*: Mpeg recordings cannot be edited after the file has been saved.
 - *Radiometric storage (*.csq)*: A csq file supports full radiometry but is only supported by FLIR Systems software. The file does not include any visual image information. With this setting, only the image mode *Thermal* is supported when recording video.
- *Photo as separate JPEG*: A visual image is always saved in the same JPEG file as the thermal image. Enabling this setting saves an extra visual image as a separate JPEG file.
- *File naming format*: This setting defines the naming format for new image/video files. The setting has no impact on already saved files in the archive. Available options are:
 - *DCF*: DCF (Design rule for Camera File system) is a standard that specifies the naming method of image files (and much more). With this setting, the name of a saved image/video file will be FLIRxxxx, where xxxx is a unique counter. Example: FLIR0001.
 - *Date prefix*: A prefix will be added to the file name, including the date and the text “IR_” for images and “MOV_” for videos. Examples: IR_2015-04-22_0002 and MOV_2015-04-22_0003. The date format will follow the *Date & time format* setting, see section 23.1.5 *Device settings*, page 74.

**NOTE**

With the *Date prefix* setting, the files may not automatically be detected by third-party applications.

- *Delete all saved files...*: This displays a dialog box where you can choose to permanently delete all the saved files (images, videos, and reports) from the memory card or to cancel the delete action.

23.1.4 Programmable buttons

There are four programmable buttons. For more information, see section 11.11 *Assigning functions to the programmable buttons*, page 29.

- *P Button*: This setting assigns a function to the hardware button **P**.
- *P2 Button*: This setting assigns a function to the hardware button **P₂**.
- *P3 Button (on screen)*: This setting assigns a function to the software button P3 on the screen.
- *P4 Button (on screen)*: This setting assigns a function to the software button P4 on the screen.

Available options for all programmable buttons:

- *No action*: This is the default setting. Nothing will happen when you push/press the button.
- *Hide image overlay graphics*: Hide all overlay graphics and image overlay information. For more information, see section 13.8 *Hiding all overlay*, page 48.
- *Calibrate*: Perform a manual calibration of the camera. For more information, see section 13.7 *Calibrating the camera*, page 48.
- *Auto-adjust the manual temperature scale*: Perform an automatic adjustment of the image while remaining in manual image adjustment mode.

- *Switch Thermal <> Digital camera*: Switch between the image modes *Thermal* and *Digital camera*. For more information, see section 14 *Working with image modes*, page 50.
- *Switch Thermal <> Thermal MSX*: Switch between the image modes *Thermal* and *Thermal MSX*. For more information, see section 14 *Working with image modes*, page 50.
- *Switch 1x zoom <> Max zoom*: Switch between the digital zoom factor of 1x and maximum zoom.
- *Switch camera flash On <> Off*: Switch between the activated/deactivated camera flash function. For more information, see section 11.12 *Using the camera lamp as a flash*, page 30.

**NOTE**

The flash function will not be activated if the setting *Lamp & laser* is set to the option *Disable all*. For more information, see section 23.1.5 *Device settings*, page 74.

- *Switch single shot <> Video*: Switch between the recording modes *Single shot* and *Video*.
- *Switch between two latest palettes*: Switch between the two latest-used color palettes. For more information, see section 13.5 *Changing the color palette*, page 47.
- *Switch temperature range*: Cycle through the camera temperature ranges. For more information, see section 23.1.2 *Camera temperature range*, page 72.

Additional options for the hardware buttons **P** and **P₂**:

- *Autofocus*.
- *Continuous autofocus*.
- *Switch auto orientation On <> Off*.
- *Save*.
- *Save + Prompt for note*.
- *Save + Prompt for table*.
- *Save + Prompt for voice annotation*.
- *Save + Prompt for sketch*.
- *Save + Select annotation from menu*.
- *Preview*.
- *Preview + Prompt for note*.
- *Preview + Prompt for table*.
- *Preview + Prompt for voice annotation*.
- *Preview + Prompt for sketch*.
- *Preview + Select annotation from menu*.

23.1.5 Device settings

- *Language, time & units*: This submenu includes settings for a number of regional parameters:
 - *Language*.
 - *Temperature unit*.
 - *Distance unit*.
 - *Time zone*
 - *Date & time*.
 - *Date & time format*.
- *Continuous autofocus*: This setting is used to enable/disable continuous autofocus.
- *Display settings*: This submenu includes the following settings:
 - *Auto orientation*: This setting defines if the orientation of the overlay graphics will change according to how you hold the camera.
 - *Image overlay information*: This setting specifies what image information the camera will display as overlay on the image. For more information, see section 9.4 *Image overlay information*, page 21. You can select to display the following information:

- *Compass.*
- *Date & time.*
- *Emissivity.*
- *Reflected temperature.*
- *Distance.*
- *Relative humidity.*
- *Atmospheric temperature.*

**NOTE**

This setting only specifies what information to overlay on the image. All image information is always saved to the image file and is available in the image archive.

- *Screen brightness:* This setting defines the brightness of the screen. Available options are *Low, Medium, High,* and *Auto.*
- *Viewfinder brightness:* This setting defines the brightness of the viewfinder. Available options are *Low, Medium,* and *High.*
- *HDMI:* (Applicable when an HDMI cable is connected to the camera.) This setting defines the resolution of the digital video output. The setting can be used to select display of the image only, or display of the image and the entire overlay graphics.
- *Wireless & geolocation, Wireless,* or *Geolocation* (depending on the camera configuration): This submenu includes the following settings:
 - *Wi-Fi:* This setting defines Wi-Fi networks. For more information, see section , page .
 - *Bluetooth:* This setting defines Bluetooth connectivity. For more information, see section , page .
 - *GPS:* This setting is used to enable/disable the GPS.
 - *Compass:* This setting is used to enable/disable the compass and to calibrate the compass. For more information, see section 11.16 *Calibrating the compass,* page 38.
- *Lamp & laser:* This submenu includes the following settings:
 - *Enable lamp & laser:* This setting is used to enable the camera lamp and the laser pointer.
 - *Enable lamp & laser + Use lamp as flash:* This setting is used to activate the flash function. When the flash function is activated, the camera lamp will flash when an image is saved.
 - *Disable all:* This setting is used to disable the camera lamp, laser pointer, and flash function.
- *Auto power off:* This setting defines how soon the camera is automatically turned off. Available choices are *Off, 5 min,* and *20 min.*
- *User interface options:* This submenu includes the following settings:
 - *Manual adjustment mode:* This setting specifies the type of manual image adjustment mode. Available options are *Level, Max, Min* and *Level, Span.* For more information, see section 13.3 *Adjusting the infrared image,* page 44.
 - *Emissivity mode:* This setting specifies how the object parameter emissivity will be entered. Available options are *Select values* and *Select from materials table.* For more information, see section 15.5 *Changing object parameters,* page 54.
 - *Screening mode:* This setting is used to enable/disable screening mode. For more information, see section 20 *Screening alarm,* page 69.
- *Reset options:* This setting defines a number or reset options:
 - *Reset default camera mode...:* This will affect the color palettes and measurement tools. Saved images will not be affected.
 - *Reset device settings to factory default...:* This will affect all camera settings, including regional settings. Saved images will not be affected. The camera will be restarted.

-
- *Reset image counter...*: This will reset the numbering of the image file names. To prevent image files being overwritten, the new counter value will be based on the highest existing file name number in the image archive.



**NOTE**

When a reset option is selected, a dialog box is displayed with more information. You can choose to execute the reset action or to cancel.

- *Camera information*: This dialog displays information about the camera. No changes can be made.
 - *Model*.
 - *Serial number*.
 - *Part number*.
 - *Software version*.
 - *Storage*: The used and free space on the memory card.
 - *Lens*: The field of view of the lens.
 - *Power*: The remaining battery capacity, in percent.

23.2 Procedure

Follow this procedure:

1. Push the joystick to display the menu system.
2. Use the joystick to go to  (*Settings*).
3. Push the joystick to display the *Settings* menu.
4. Use the joystick to select the setting you want to change.
5. To exit the *Settings* menu or a submenu, push the Back button .

24.1 Online field-of-view calculator

Please visit <http://support.flir.com> and click the photo of the camera series for field-of-view tables for all lens-camera combinations.

24.2 Note about technical data

FLIR Systems reserves the right to change specifications at any time without prior notice. Please check <http://support.flir.com> for latest changes.

24.3 Note about authoritative versions

The authoritative version of this publication is English. In the event of divergences due to translation errors, the English text has precedence.

Any late changes are first implemented in English.

24.4 FLIR T1020 12°

P/N: 72501-0101

Rev.: 28063

General description	
<p>The FLIR T1020 is designed for the expert requiring the highest performance and the latest technology available. The camera combines excellent ergonomics and feature-rich flexibility with superior image quality of 1024 × 768 pixel IR resolution. High accuracy and sensitivity together with radiometric recording and streaming options make the T1020 well suited for advanced research and development.</p>	
<p>Benefits:</p> <ul style="list-style-type: none"> • Tailor made for research and development: The T1020 has high accuracy and high sensitivity to accurately measure the smallest temperature differences. With real-time radiometric recording in the camera, it is possible to capture fast events on the camera's SD card for further analysis by the supplied analysis software. • Flexible and feature rich: A wide variety of measuring and analysis functions makes the camera flexible for your every need. Two programmable buttons provide easy access to favorite functions. • Highest performance with the latest technology: The T1020 camera is equipped with the innovative 'Multi Spectral Dynamic Imaging (MSX)' feature, which produces an image richer in detail than ever before. Continuous auto-focus makes the T1020 a fully automatic IR camera. 	
Imaging and optical data	
IR resolution	1024 × 768 pixels
Thermal sensitivity/NETD	<20 mK @ +30°C (+86°F)
Field of view (FOV)	12° × 9°
Minimum focus distance	0.8 m (2.63 ft.)
Field of view (FOV) / Minimum focus distance	12° × 9° / 0.8 m (2.63 ft.)
Focal length	83.4 mm (3.28 in.)
Spatial resolution (IFOV)	0.20 mrad
Lens identification	Automatic
F-number	1.2
Image frequency	30 Hz
Focus	Continuous, one shot or manual
Digital zoom	1–8× continuous
Zoom	1–8× continuous, digital zoom
Digital image enhancement	Adaptive digital noise reduction
Detector data	
Detector type	Focal Plane Array (FPA), uncooled microbolometer
Spectral range	7.5–14 μm
Detector pitch	17 μm
Image presentation	
Display	Built-in touch screen, 4.3 in. wide screen LCD, 800 × 480 pixels
Display type	Capacitive touch screen
Auto orientation	Automatic landscape or portrait
Viewfinder	Built-in 800 × 480 pixels
Automatic image adjustment	Continuous, histogram based
Automatic image adjustment, type	Standard or histogram based from image content
Manual image adjustment	Linear based; Possible to adjust level/span/max/min

Image presentation modes	
Image modes	Thermal, Thermal MSX, Picture in Picture, Digital Camera
Infrared image	Full color IR image
Visual image	Full color visual image
Multi Spectral Dynamic Imaging (MSX)	Thermal image with enhanced detail presentation
Picture in Picture	Resizable and movable IR area on visual image
Measurement analysis	
Spotmeter	10
Area	5+5 areas (boxes and circles) with max./min./average
Profile	1 line profile with max/min temp
Automatic hot/cold detection	Auto hot or cold spotmeter markers within area and profile
Measurement presets	No measurements, Center spot, Hot spot, Cold spot, User preset 1, User preset 2
User presets	The user can select and combine measurements from any number of spots/boxes/circles/profiles/delta
Difference temperature	Delta temperature between measurement functions or reference temperature
Reference temperature	Manually set using difference temperature
Atmospheric transmission correction	Automatic, based on inputs for distance, atmospheric temperature and relative humidity
Optics transmission correction	Automatic, based on signals from internal sensors
Emissivity correction	Variable from 0.01 to 1.0 or selected from materials list
Emissivity table	Emissivity table of predefined materials
Reflected apparent temperature correction	Automatic, based on input of reflected temperature
External optics/windows correction	Automatic, based on inputs of window transmission and temperature
Measurement corrections	Emissivity, reflected temperature, relative humidity, atmospheric temperature, object distance, external IR window compensation
Colors (palettes)	Iron, Rainbow, Rainbow HC, White hot, Black hot, Artic, Lava
Alarm	
Color Alarm (isotherm)	Above/below/interval
Measurement function alarm	Audible/visual alarms (above/below) on any selected measurement function
Set-up	
Set-up commands	Define user presets, Save options, Programmable button, Reset options, Set up camera, Wi-Fi, GPS & compass, Bluetooth, Language, Time & units, Camera information
Service functions	
Camera software update	Use PC software FLIR Tools

Storage of images	
Image storage	Standard JPEG, including digital photo and measurement data, on memory card
Storage media	Removable memory SD card (class 10)
Image storage mode	<ul style="list-style-type: none"> • Simultaneous storage of thermal and digital photo in same JPEG. • Optional to store digital photo as separate JPEG.
Time lapse	15 seconds to 24 hours
File formats	<ul style="list-style-type: none"> • Standard JPEG, measurement data included • CSQ, measurement data included
File formats, visual	Standard JPEG, automatically associated with corresponding thermal image
Image annotations	
Voice	60 seconds (via Bluetooth) stored with the image
Text	Add table. Select between predefined templates
Image description	Add short note (stored in JPEG exif tag)
Sketch	<ul style="list-style-type: none"> • Draw on thermal/digital photo or add predefined stamps • Separate PC software with extensive report generation
Geographic Information System	
GPS	Location data automatically added to every image from built-in GPS
Compass	Camera direction automatically added to every image
Video recording in camera	
Radiometric IR-video recording	Real-time radiometric recording (RTRR) to memory card
Non-radiometric IR-video recording	H.264 to memory card
Visual video recording	H.264 to memory card
Video streaming	
Radiometric IR-video streaming	Real-time radiometric streaming (RTRS) via USB
Non-radiometric IR-video streaming	<ul style="list-style-type: none"> • H.264 video using Wi-Fi • H.264 video using USB
Visual video streaming	<ul style="list-style-type: none"> • H.264 video using Wi-Fi • H.264 video using USB
Digital camera	
Digital camera	FOV adapts to the IR lens
Video lamp	Built-in LED light
Laser pointer	
Laser	Activated by dedicated button
Laser alignment	Position is automatic displayed on the IR image
Laser classification	Class 2
Laser type	Semiconductor AlGaInP diode laser, 1 mW, 635 nm (red)

Data communication interfaces	
Interfaces	USB-micro-AB, Bluetooth, Wi-Fi, HDMI
Bluetooth	Communication with headset
Wi-Fi	Peer to peer (ad hoc), infrastructure (network) or AP
SD Card	One card slot for removable SD memory cards
Audio	Microphone headset via Bluetooth for voice annotation of images
USB	
USB	USB Micro -AB: Data transfer to and from PC / Uncompressed colorized video
USB, standard	<ul style="list-style-type: none"> • USB 2.0 High Speed • USB Micro-AB connector
Video	
Video out	HDMI compatible
Video, connector type	HDMI type C
Radio	
Wi-Fi	<ul style="list-style-type: none"> • Standard: 802.11 b/g/n • Frequency range: 2412–2462 MHz • Max output power: 15 dBm
Bluetooth	Frequency range: 2402–2480 MHz Supports 2.1, 4.0 and 4.0BLE
Antenna	Internal
Power system	
Battery	Li Ion
Battery type	Rechargeable Li Ion battery
Battery operating time	> 2.5 hours at 25°C (+68°F) and typical use
Charging system	In camera (AC adapter or 12 V from a vehicle) or 2-bay charger
Charging time	2.5 h to 90 % capacity, charging status indicated by LED's
Charging temperature	0°C to +45°C (+32°F to +113°F)
External power operation	AC adapter 90–260 VAC, 50/60 Hz or 12 V from a vehicle (cable with standard plug, optional)
Power management	Automatic power-off functionality, user-configurable between 5 min, 20 min, or no automatic shutdown
Environmental data	
Storage temperature range	–40°C to +70°C (–40°F to +158°F)
Humidity (operating and storage)	IEC 60068-2-30/24 h 95% relative humidity +25°C to +40°C (+77°F to +104°F) / 2 cycles
EMC	<ul style="list-style-type: none"> • ETSI EN 301 489-1 (radio) • ETSI EN 301 489-17 • EN 61000-6-2 (Immunity) • EN 61000-6-3 (Emission) • FCC 47 CFR Part 15 Class B (Emission) • ICES-003
Radio spectrum	<ul style="list-style-type: none"> • ETSI EN 300 328 • FCC Part 15.247 • RSS-247 issue 1

Environmental data	
Encapsulation	IP 54 (IEC 60529)
Shock	25 g (IEC 60068-2-29)
Vibration	2 g (IEC 60068-2-6)
Safety	EN/UL/CSA/PSE 60950-1
Physical data	
Weight	2.1 kg (4.6 lb.)
Tripod mounting	UNC ¼"-20
Housing material	Magnesium
Shipping information	
List of contents	<ul style="list-style-type: none"> • Infrared camera with lens • Battery (2 ea.) • Battery charger • Bluetooth headset • Calibration certificate • FLIR Tools+ license card • User documentation CD-ROM • Printed documentation • HDMI-HDMI cable • Hard transport case • Large eyecap • Lens cap • Memory card • Neck strap • Power supply, incl. multi-plugs • USB cable, Std A to Micro-B
EAN-13	7332558010273
UPC-12	845188010911
Country of origin	Sweden

24.5 FLIR T1020 28°

P/N: 72501-0102

Rev.: 28063

General description	
<p>The FLIR T1020 is designed for the expert requiring the highest performance and the latest technology available. The camera combines excellent ergonomics and feature-rich flexibility with superior image quality of 1024 × 768 pixel IR resolution. High accuracy and sensitivity together with radiometric recording and streaming options make the T1020 well suited for advanced research and development.</p>	
<p>Benefits:</p> <ul style="list-style-type: none"> • Tailor made for research and development: The T1020 has high accuracy and high sensitivity to accurately measure the smallest temperature differences. With real-time radiometric recording in the camera, it is possible to capture fast events on the camera's SD card for further analysis by the supplied analysis software. • Flexible and feature rich: A wide variety of measuring and analysis functions makes the camera flexible for your every need. Two programmable buttons provide easy access to favorite functions. • Highest performance with the latest technology: The T1020 camera is equipped with the innovative 'Multi Spectral Dynamic Imaging (MSX)' feature, which produces an image richer in detail than ever before. Continuous auto-focus makes the T1020 a fully automatic IR camera. 	
Imaging and optical data	
IR resolution	1024 × 768 pixels
Thermal sensitivity/NETD	<20 mK @ +30°C (+86°F)
Field of view (FOV)	28° × 21°
Minimum focus distance	0.4 m (1.32 ft.)
Field of view (FOV) / Minimum focus distance	28° × 21° / 0.4 m (1.32 ft.)
Focal length	36 mm (1.42 in.)
Spatial resolution (IFOV)	0.47mrad
Lens identification	Automatic
F-number	1.15
Image frequency	30 Hz
Focus	Continuous, one shot or manual
Digital zoom	1–8× continuous
Zoom	1–8× continuous, digital zoom
Digital image enhancement	Adaptive digital noise reduction
Detector data	
Detector type	Focal Plane Array (FPA), uncooled microbolometer
Spectral range	7.5–14 μm
Detector pitch	17 μm
Image presentation	
Display	Built-in touch screen, 4.3 in. wide screen LCD, 800 × 480 pixels
Display type	Capacitive touch screen
Auto orientation	Automatic landscape or portrait
Viewfinder	Built-in 800 × 480 pixels
Automatic image adjustment	Continuous, histogram based
Automatic image adjustment, type	Standard or histogram based from image content
Manual image adjustment	Linear based; Possible to adjust level/span/max/min

Image presentation modes	
Image modes	Thermal, Thermal MSX, Picture in Picture, Digital Camera
Infrared image	Full color IR image
Visual image	Full color visual image
Multi Spectral Dynamic Imaging (MSX)	Thermal image with enhanced detail presentation
Picture in Picture	Resizable and movable IR area on visual image
Measurement analysis	
Spotmeter	10
Area	5+5 areas (boxes and circles) with max./min./average
Profile	1 line profile with max/min temp
Automatic hot/cold detection	Auto hot or cold spotmeter markers within area and profile
Measurement presets	No measurements, Center spot, Hot spot, Cold spot, User preset 1, User preset 2
User presets	The user can select and combine measurements from any number of spots/boxes/circles/profiles/delta
Difference temperature	Delta temperature between measurement functions or reference temperature
Reference temperature	Manually set using difference temperature
Atmospheric transmission correction	Automatic, based on inputs for distance, atmospheric temperature and relative humidity
Optics transmission correction	Automatic, based on signals from internal sensors
Emissivity correction	Variable from 0.01 to 1.0 or selected from materials list
Emissivity table	Emissivity table of predefined materials
Reflected apparent temperature correction	Automatic, based on input of reflected temperature
External optics/windows correction	Automatic, based on inputs of window transmission and temperature
Measurement corrections	Emissivity, reflected temperature, relative humidity, atmospheric temperature, object distance, external IR window compensation
Colors (palettes)	Iron, Rainbow, Rainbow HC, White hot, Black hot, Artic, Lava
Alarm	
Color Alarm (isotherm)	Above/below/interval
Measurement function alarm	Audible/visual alarms (above/below) on any selected measurement function
Set-up	
Set-up commands	Define user presets, Save options, Programmable button, Reset options, Set up camera, Wi-Fi, GPS & compass, Bluetooth, Language, Time & units, Camera information
Service functions	
Camera software update	Use PC software FLIR Tools

Storage of images	
Image storage	Standard JPEG, including digital photo and measurement data, on memory card
Storage media	Removable memory SD card (class 10)
Image storage mode	<ul style="list-style-type: none"> • Simultaneous storage of thermal and digital photo in same JPEG. • Optional to store digital photo as separate JPEG.
Time lapse	15 seconds to 24 hours
File formats	<ul style="list-style-type: none"> • Standard JPEG, measurement data included • CSQ, measurement data included
File formats, visual	Standard JPEG, automatically associated with corresponding thermal image
Image annotations	
Voice	60 seconds (via Bluetooth) stored with the image
Text	Add table. Select between predefined templates
Image description	Add short note (stored in JPEG exif tag)
Sketch	<ul style="list-style-type: none"> • Draw on thermal/digital photo or add predefined stamps • Separate PC software with extensive report generation
Geographic Information System	
GPS	Location data automatically added to every image from built-in GPS
Compass	Camera direction automatically added to every image
Video recording in camera	
Radiometric IR-video recording	Real-time radiometric recording (RTRR) to memory card
Non-radiometric IR-video recording	H.264 to memory card
Visual video recording	H.264 to memory card
Video streaming	
Radiometric IR-video streaming	Real-time radiometric streaming (RTRS) via USB
Non-radiometric IR-video streaming	<ul style="list-style-type: none"> • H.264 video using Wi-Fi • H.264 video using USB
Visual video streaming	<ul style="list-style-type: none"> • H.264 video using Wi-Fi • H.264 video using USB
Digital camera	
Digital camera	FOV adapts to the IR lens
Video lamp	Built-in LED light
Laser pointer	
Laser	Activated by dedicated button
Laser alignment	Position is automatic displayed on the IR image
Laser classification	Class 2
Laser type	Semiconductor AlGaInP diode laser, 1 mW, 635 nm (red)

Data communication interfaces	
Interfaces	USB-micro-AB, Bluetooth, Wi-Fi, HDMI
Bluetooth	Communication with headset
Wi-Fi	Peer to peer (ad hoc), infrastructure (network) or AP
SD Card	One card slot for removable SD memory cards
Audio	Microphone headset via Bluetooth for voice annotation of images
USB	
USB	USB Micro -AB: Data transfer to and from PC / Uncompressed colorized video
USB, standard	<ul style="list-style-type: none"> • USB 2.0 High Speed • USB Micro-AB connector
Video	
Video out	HDMI compatible
Video, connector type	HDMI type C
Radio	
Wi-Fi	<ul style="list-style-type: none"> • Standard: 802.11 b/g/n • Frequency range: 2412–2462 MHz • Max output power: 15 dBm
Bluetooth	Frequency range: 2402–2480 MHz Supports 2.1, 4.0 and 4.0BLE
Antenna	Internal
Power system	
Battery	Li Ion
Battery type	Rechargeable Li Ion battery
Battery operating time	> 2.5 hours at 25°C (+68°F) and typical use
Charging system	In camera (AC adapter or 12 V from a vehicle) or 2-bay charger
Charging time	2.5 h to 90 % capacity, charging status indicated by LED's
Charging temperature	0°C to +45°C (+32°F to +113°F)
External power operation	AC adapter 90–260 VAC, 50/60 Hz or 12 V from a vehicle (cable with standard plug, optional)
Power management	Automatic power-off functionality, user-configurable between 5 min, 20 min, or no automatic shutdown
Environmental data	
Storage temperature range	–40°C to +70°C (–40°F to +158°F)
Humidity (operating and storage)	IEC 60068-2-30/24 h 95% relative humidity +25°C to +40°C (+77°F to +104°F) / 2 cycles
EMC	<ul style="list-style-type: none"> • ETSI EN 301 489-1 (radio) • ETSI EN 301 489-17 • EN 61000-6-2 (Immunity) • EN 61000-6-3 (Emission) • FCC 47 CFR Part 15 Class B (Emission) • ICES-003
Radio spectrum	<ul style="list-style-type: none"> • ETSI EN 300 328 • FCC Part 15.247 • RSS-247 issue 1

Environmental data	
Encapsulation	IP 54 (IEC 60529)
Shock	25 g (IEC 60068-2-29)
Vibration	2 g (IEC 60068-2-6)
Safety	EN/UL/CSA/PSE 60950-1
Physical data	
Weight	1.9 kg (4.3 lb.)
Tripod mounting	UNC ¼"-20
Housing material	Magnesium
Shipping information	
List of contents	<ul style="list-style-type: none"> • Infrared camera with lens • Battery (2 ea.) • Battery charger • Bluetooth headset • Calibration certificate • FLIR Tools+ license card • User documentation CD-ROM • Printed documentation • HDMI-HDMI cable • Hard transport case • Large eyecap • Lens cap • Memory card • Neck strap • Power supply, incl. multi-plugs • USB cable, Std A to Micro-B
EAN-13	7332558010280
UPC-12	845188010928
Country of origin	Sweden

24.6 FLIR T1020 45°

P/N: 72501-0103

Rev.: 28063

General description	
The FLIR T1020 is designed for the expert requiring the highest performance and the latest technology available. The camera combines excellent ergonomics and feature-rich flexibility with superior image quality of 1024 × 768 pixel IR resolution. High accuracy and sensitivity together with radiometric recording and streaming options make the T1020 well suited for advanced research and development.	
Benefits:	
<ul style="list-style-type: none"> • Tailor made for research and development: The T1020 has high accuracy and high sensitivity to accurately measure the smallest temperature differences. With real-time radiometric recording in the camera, it is possible to capture fast events on the camera's SD card for further analysis by the supplied analysis software. • Flexible and feature rich: A wide variety of measuring and analysis functions makes the camera flexible for your every need. Two programmable buttons provide easy access to favorite functions. • Highest performance with the latest technology: The T1020 camera is equipped with the innovative 'Multi Spectral Dynamic Imaging (MSX)' feature, which produces an image richer in detail than ever before. Continuous auto-focus makes the T1020 a fully automatic IR camera. 	
Imaging and optical data	
IR resolution	1024 × 768 pixels
Thermal sensitivity/NETD	<20 mK @ +30°C (+86°F)
Field of view (FOV)	45° × 34°
Minimum focus distance	0.2 m (0.66 ft.)
Field of view (FOV) / Minimum focus distance	45° × 34° / 0.2 m (0.66 ft.)
Focal length	21.2 mm (0.83 in.)
Spatial resolution (IFOV)	0.80 mrad
Lens identification	Automatic
F-number	1.1
Image frequency	30 Hz
Focus	Continuous, one shot or manual
Digital zoom	1–8× continuous
Zoom	1–8× continuous, digital zoom
Digital image enhancement	Adaptive digital noise reduction
Detector data	
Detector type	Focal Plane Array (FPA), uncooled microbolometer
Spectral range	7.5–14 μm
Detector pitch	17 μm
Image presentation	
Display	Built-in touch screen, 4.3 in. wide screen LCD, 800 × 480 pixels
Display type	Capacitive touch screen
Auto orientation	Automatic landscape or portrait
Viewfinder	Built-in 800 × 480 pixels
Automatic image adjustment	Continuous, histogram based
Automatic image adjustment, type	Standard or histogram based from image content
Manual image adjustment	Linear based; Possible to adjust level/span/max/min

Image presentation modes	
Image modes	Thermal, Thermal MSX, Picture in Picture, Digital Camera
Infrared image	Full color IR image
Visual image	Full color visual image
Multi Spectral Dynamic Imaging (MSX)	Thermal image with enhanced detail presentation
Picture in Picture	Resizable and movable IR area on visual image
Measurement analysis	
Spotmeter	10
Area	5+5 areas (boxes and circles) with max./min./average
Profile	1 line profile with max/min temp
Automatic hot/cold detection	Auto hot or cold spotmeter markers within area and profile
Measurement presets	No measurements, Center spot, Hot spot, Cold spot, User preset 1, User preset 2
User presets	The user can select and combine measurements from any number of spots/boxes/circles/profiles/delta
Difference temperature	Delta temperature between measurement functions or reference temperature
Reference temperature	Manually set using difference temperature
Atmospheric transmission correction	Automatic, based on inputs for distance, atmospheric temperature and relative humidity
Optics transmission correction	Automatic, based on signals from internal sensors
Emissivity correction	Variable from 0.01 to 1.0 or selected from materials list
Emissivity table	Emissivity table of predefined materials
Reflected apparent temperature correction	Automatic, based on input of reflected temperature
External optics/windows correction	Automatic, based on inputs of window transmission and temperature
Measurement corrections	Emissivity, reflected temperature, relative humidity, atmospheric temperature, object distance, external IR window compensation
Colors (palettes)	Iron, Rainbow, Rainbow HC, White hot, Black hot, Artic, Lava
Alarm	
Color Alarm (isotherm)	Above/below/interval
Measurement function alarm	Audible/visual alarms (above/below) on any selected measurement function
Set-up	
Set-up commands	Define user presets, Save options, Programmable button, Reset options, Set up camera, Wi-Fi, GPS & compass, Bluetooth, Language, Time & units, Camera information
Service functions	
Camera software update	Use PC software FLIR Tools

Storage of images	
Image storage	Standard JPEG, including digital photo and measurement data, on memory card
Storage media	Removable memory SD card (class 10)
Image storage mode	<ul style="list-style-type: none"> • Simultaneous storage of thermal and digital photo in same JPEG. • Optional to store digital photo as separate JPEG.
Time lapse	15 seconds to 24 hours
File formats	<ul style="list-style-type: none"> • Standard JPEG, measurement data included • CSQ, measurement data included
File formats, visual	Standard JPEG, automatically associated with corresponding thermal image
Image annotations	
Voice	60 seconds (via Bluetooth) stored with the image
Text	Add table. Select between predefined templates
Image description	Add short note (stored in JPEG exif tag)
Sketch	<ul style="list-style-type: none"> • Draw on thermal/digital photo or add predefined stamps • Separate PC software with extensive report generation
Geographic Information System	
GPS	Location data automatically added to every image from built-in GPS
Compass	Camera direction automatically added to every image
Video recording in camera	
Radiometric IR-video recording	Real-time radiometric recording (RTRR) to memory card
Non-radiometric IR-video recording	H.264 to memory card
Visual video recording	H.264 to memory card
Video streaming	
Radiometric IR-video streaming	Real-time radiometric streaming (RTRS) via USB
Non-radiometric IR-video streaming	<ul style="list-style-type: none"> • H.264 video using Wi-Fi • H.264 video using USB
Visual video streaming	<ul style="list-style-type: none"> • H.264 video using Wi-Fi • H.264 video using USB
Digital camera	
Digital camera	FOV adapts to the IR lens
Video lamp	Built-in LED light
Laser pointer	
Laser	Activated by dedicated button
Laser alignment	Position is automatic displayed on the IR image
Laser classification	Class 2
Laser type	Semiconductor AlGaInP diode laser, 1 mW, 635 nm (red)

Data communication interfaces	
Interfaces	USB-micro-AB, Bluetooth, Wi-Fi, HDMI
Bluetooth	Communication with headset
Wi-Fi	Peer to peer (ad hoc), infrastructure (network) or AP
SD Card	One card slot for removable SD memory cards
Audio	Microphone headset via Bluetooth for voice annotation of images
USB	
USB	USB Micro -AB: Data transfer to and from PC / Uncompressed colorized video
USB, standard	<ul style="list-style-type: none"> • USB 2.0 High Speed • USB Micro-AB connector
Video	
Video out	HDMI compatible
Video, connector type	HDMI type C
Radio	
Wi-Fi	<ul style="list-style-type: none"> • Standard: 802.11 b/g/n • Frequency range: 2412–2462 MHz • Max output power: 15 dBm
Bluetooth	Frequency range: 2402–2480 MHz Supports 2.1, 4.0 and 4.0BLE
Antenna	Internal
Power system	
Battery	Li Ion
Battery type	Rechargeable Li Ion battery
Battery operating time	> 2.5 hours at 25°C (+68°F) and typical use
Charging system	In camera (AC adapter or 12 V from a vehicle) or 2-bay charger
Charging time	2.5 h to 90 % capacity, charging status indicated by LED's
Charging temperature	0°C to +45°C (+32°F to +113°F)
External power operation	AC adapter 90–260 VAC, 50/60 Hz or 12 V from a vehicle (cable with standard plug, optional)
Power management	Automatic power-off functionality, user-configurable between 5 min, 20 min, or no automatic shutdown
Environmental data	
Storage temperature range	–40°C to +70°C (–40°F to +158°F)
Humidity (operating and storage)	IEC 60068-2-30/24 h 95% relative humidity +25°C to +40°C (+77°F to +104°F) / 2 cycles
EMC	<ul style="list-style-type: none"> • ETSI EN 301 489-1 (radio) • ETSI EN 301 489-17 • EN 61000-6-2 (Immunity) • EN 61000-6-3 (Emission) • FCC 47 CFR Part 15 Class B (Emission) • ICES-003
Radio spectrum	<ul style="list-style-type: none"> • ETSI EN 300 328 • FCC Part 15.247 • RSS-247 issue 1

Environmental data	
Encapsulation	IP 54 (IEC 60529)
Shock	25 g (IEC 60068-2-29)
Vibration	2 g (IEC 60068-2-6)
Safety	EN/UL/CSA/PSE 60950-1
Physical data	
Weight	2.0 kg (4.3 lb.)
Tripod mounting	UNC ¼"-20
Housing material	Magnesium
Shipping information	
List of contents	<ul style="list-style-type: none"> • Infrared camera with lens • Battery (2 ea.) • Battery charger • Bluetooth headset • Calibration certificate • FLIR Tools+ license card • User documentation CD-ROM • Printed documentation • HDMI-HDMI cable • Hard transport case • Large eyecap • Lens cap • Memory card • Neck strap • Power supply, incl. multi-plugs • USB cable, Std A to Micro-B
EAN-13	7332558010297
UPC-12	845188010935
Country of origin	Sweden

24.7 FLIR T1030sc 12°

P/N: 72501-0201

Rev.: 28063

General description	
<p>The FLIR T1030sc is designed for the expert requiring the highest performance and the latest technology available. The camera combines excellent ergonomics and feature-rich flexibility with superior image quality of 1024 × 768 pixel IR resolution. High accuracy and sensitivity together with radiometric recording and streaming options make the T1030sc well suited for advanced research and development.</p>	
<p>Benefits:</p> <ul style="list-style-type: none"> • Tailor made for research and development: The T1030sc has high accuracy and high sensitivity to accurately measure the smallest temperature differences. With real-time radiometric recording in the camera, it is possible to capture fast events on the camera's SD card for further analysis by the supplied analysis software. • Flexible and feature rich: A wide variety of measuring and analysis functions makes the camera flexible for your every need. Two programmable buttons provide easy access to favorite functions. • Highest performance with the latest technology: The T1030sc camera is equipped with the innovative 'Multi Spectral Dynamic Imaging (MSX)' feature, which produces an image richer in detail than ever before. Continuous auto-focus makes the T1030sc a fully automatic IR camera. 	
Imaging and optical data	
IR resolution	1024 × 768 pixels
Thermal sensitivity/NETD	<20 mK @ +30°C (+86°F)
Field of view (FOV)	12° × 9°
Minimum focus distance	0.8 m (2.63 ft.)
Field of view (FOV) / Minimum focus distance	12° × 9° / 0.8 m (2.63 ft.)
Focal length	83.4 mm (3.28 in.)
Spatial resolution (IFOV)	0.20 mrad
Lens identification	Automatic
F-number	1.2
Image frequency	30 Hz
Focus	Continuous, one shot or manual
Digital zoom	1–8× continuous
Zoom	1–8× continuous, digital zoom
Digital image enhancement	Adaptive digital noise reduction
Detector data	
Detector type	Focal Plane Array (FPA), uncooled microbolometer
Spectral range	7.5–14 μm
Detector pitch	17 μm
Image presentation	
Display	Built-in touch screen, 4.3 in. wide screen LCD, 800 × 480 pixels
Display type	Capacitive touch screen
Auto orientation	Automatic landscape or portrait
Viewfinder	Built-in 800 × 480 pixels
Automatic image adjustment	Continuous, histogram based
Automatic image adjustment, type	Standard or histogram based from image content
Manual image adjustment	Linear based; Possible to adjust level/span/max/min

Image presentation modes	
Image modes	Thermal, Thermal MSX, Picture in Picture, Digital Camera
Infrared image	Full color IR image
Visual image	Full color visual image
Multi Spectral Dynamic Imaging (MSX)	Thermal image with enhanced detail presentation
Picture in Picture	Resizable and movable IR area on visual image
Measurement analysis	
Spotmeter	10
Area	5+5 areas (boxes and circles) with max./min./average
Profile	1 line profile with max/min temp
Automatic hot/cold detection	Auto hot or cold spotmeter markers within area and profile
Measurement presets	No measurements, Center spot, Hot spot, Cold spot, User preset 1, User preset 2
User presets	The user can select and combine measurements from any number of spots/boxes/circles/profiles/delta
Difference temperature	Delta temperature between measurement functions or reference temperature
Reference temperature	Manually set using difference temperature
Atmospheric transmission correction	Automatic, based on inputs for distance, atmospheric temperature and relative humidity
Optics transmission correction	Automatic, based on signals from internal sensors
Emissivity correction	Variable from 0.01 to 1.0 or selected from materials list
Emissivity table	Emissivity table of predefined materials
Reflected apparent temperature correction	Automatic, based on input of reflected temperature
External optics/windows correction	Automatic, based on inputs of window transmission and temperature
Measurement corrections	Emissivity, reflected temperature, relative humidity, atmospheric temperature, object distance, external IR window compensation
Colors (palettes)	Iron, Rainbow, Rainbow HC, White hot, Black hot, Artic, Lava
Alarm	
Color Alarm (isotherm)	Above/below/interval
Measurement function alarm	Audible/visual alarms (above/below) on any selected measurement function
Set-up	
Set-up commands	Define user presets, Save options, Programmable button, Reset options, Set up camera, Wi-Fi, GPS & compass, Bluetooth, Language, Time & units, Camera information
Service functions	
Camera software update	Use PC software FLIR Tools

Storage of images	
Image storage	Standard JPEG, including digital photo and measurement data, on memory card
Storage media	Removable memory SD card (class 10)
Image storage mode	<ul style="list-style-type: none"> • Simultaneous storage of thermal and digital photo in same JPEG. • Optional to store digital photo as separate JPEG.
Time lapse	15 seconds to 24 hours
File formats	<ul style="list-style-type: none"> • Standard JPEG, measurement data included • CSQ, measurement data included
File formats, visual	Standard JPEG, automatically associated with corresponding thermal image
Image annotations	
Voice	60 seconds (via Bluetooth) stored with the image
Text	Add table. Select between predefined templates
Image description	Add short note (stored in JPEG exif tag)
Sketch	<ul style="list-style-type: none"> • Draw on thermal/digital photo or add predefined stamps • Separate PC software with extensive report generation
Geographic Information System	
GPS	Location data automatically added to every image from built-in GPS
Compass	Camera direction automatically added to every image
Video recording in camera	
Radiometric IR-video recording	Real-time radiometric recording (RTRR) to memory card
Non-radiometric IR-video recording	H.264 to memory card
Visual video recording	H.264 to memory card
Video streaming	
Radiometric IR-video streaming	<ul style="list-style-type: none"> • Full dynamic to PC using high speed interface • Real-time radiometric streaming (RTRS) via USB
Non-radiometric IR-video streaming	<ul style="list-style-type: none"> • H.264 video using Wi-Fi • H.264 video using USB
Visual video streaming	<ul style="list-style-type: none"> • H.264 video using Wi-Fi • H.264 video using USB
Digital camera	
Digital camera	FOV adapts to the IR lens
Video lamp	Built-in LED light
Laser pointer	
Laser	Activated by dedicated button
Laser alignment	Position is automatic displayed on the IR image

Laser pointer	
Laser classification	Class 2
Laser type	Semiconductor AlGaInP diode laser, 1 mW, 635 nm (red)
Data communication interfaces	
Interfaces	USB-micro-AB, Bluetooth, Wi-Fi, HDMI
Bluetooth	Communication with headset
Wi-Fi	Peer to peer (ad-hoc), infrastructure (network) or AP
SD Card	One card slot for removable SD memory cards
Audio	Microphone headset via Bluetooth for voice annotation of images
USB	
USB	USB Micro -AB: Data transfer to and from PC / Uncompressed colorized video
USB, standard	<ul style="list-style-type: none"> • USB 2.0 High Speed • USB Micro-AB connector
Video	
Video out	HDMI compatible
Video, connector type	HDMI type C
Radio	
Wi-Fi	<ul style="list-style-type: none"> • Standard: 802.11 b/g/n • Frequency range: 2412–2462 MHz • Max output power: 15 dBm
Bluetooth	Frequency range: 2402–2480 MHz Supports 2.1, 4.0 and 4.0BLE
Antenna	Internal
Power system	
Battery	Li Ion
Battery type	Rechargeable Li Ion battery
Battery operating time	> 2.5 hours at 25°C (+68°F) and typical use
Charging system	In camera (AC adapter or 12 V from a vehicle) or 2-bay charger
Charging time	2.5 h to 90 % capacity, charging status indicated by LED's
Charging temperature	0°C to +45°C (+32°F to +113°F)
External power operation	AC adapter 90–260 VAC, 50/60 Hz or 12 V from a vehicle (cable with standard plug, optional)
Power management	Automatic power-off functionality, user-configurable between 5 min, 20 min, or no automatic shutdown
Environmental data	
Storage temperature range	–40°C to +70°C (–40°F to +158°F)
Humidity (operating and storage)	IEC 60068-2-30/24 h 95% relative humidity +25°C to +40°C (+77°F to +104°F) / 2 cycles

Environmental data	
EMC	<ul style="list-style-type: none"> • ETSI EN 301 489-1 (radio) • ETSI EN 301 489-17 • EN 61000-6-2 (Immunity) • EN 61000-6-3 (Emission) • FCC 47 CFR Part 15 Class B (Emission) • ICES-003
Radio spectrum	<ul style="list-style-type: none"> • ETSI EN 300 328 • FCC Part 15.247 • RSS-247 issue 1
Encapsulation	IP 54 (IEC 60529)
Shock	25 g (IEC 60068-2-29)
Vibration	2 g (IEC 60068-2-6)
Safety	EN/UL/CSA/PSE 60950-1
Physical data	
Weight	2.1 kg (4.6 lb.)
Tripod mounting	UNC ¼"-20
Housing material	Magnesium
Shipping information	
List of contents	<ul style="list-style-type: none"> • Infrared camera with lens • Battery (2 ea.) • Battery charger • Bluetooth headset • Calibration certificate • FLIR ResearchIR Max 4 • FLIR Tools+ license card • User documentation CD-ROM • Printed documentation • HDMI-HDMI cable • Hard transport case • Large eyecap • Lens cap • Memory card • Neck strap • Power supply, incl. multi-plugs • USB cable, Std A to Micro-B • High-speed interface
EAN-13	7332558010303
UPC-12	845188010942
Country of origin	Sweden

24.8 FLIR T1030sc 28°

P/N: 72501-0202

Rev.: 28063

General description	
<p>The FLIR T1030sc is designed for the expert requiring the highest performance and the latest technology available. The camera combines excellent ergonomics and feature-rich flexibility with superior image quality of 1024 × 768 pixel IR resolution. High accuracy and sensitivity together with radiometric recording and streaming options make the T1030sc well suited for advanced research and development.</p>	
<p>Benefits:</p> <ul style="list-style-type: none"> • Tailor made for research and development: The T1030sc has high accuracy and high sensitivity to accurately measure the smallest temperature differences. With real-time radiometric recording in the camera, it is possible to capture fast events on the camera's SD card for further analysis by the supplied analysis software. • Flexible and feature rich: A wide variety of measuring and analysis functions makes the camera flexible for your every need. Two programmable buttons provide easy access to favorite functions. • Highest performance with the latest technology: The T1030sc camera is equipped with the innovative 'Multi Spectral Dynamic Imaging (MSX)' feature, which produces an image richer in detail than ever before. Continuous auto-focus makes the T1030sc a fully automatic IR camera. 	
Imaging and optical data	
IR resolution	1024 × 768 pixels
Thermal sensitivity/NETD	<20 mK @ +30°C (+86°F)
Field of view (FOV)	28° × 21°
Minimum focus distance	0.4 m (1.32 ft.)
Field of view (FOV) / Minimum focus distance	28° × 21° / 0.4 m (1.32 ft.)
Focal length	36 mm (1.42 in.)
Spatial resolution (IFOV)	0.47mrad
Lens identification	Automatic
F-number	1.15
Image frequency	30 Hz
Focus	Continuous, one shot or manual
Digital zoom	1–8× continuous
Zoom	1–8× continuous, digital zoom
Digital image enhancement	Adaptive digital noise reduction
Detector data	
Detector type	Focal Plane Array (FPA), uncooled microbolometer
Spectral range	7.5–14 μm
Detector pitch	17 μm
Image presentation	
Display	Built-in touch screen, 4.3 in. wide screen LCD, 800 × 480 pixels
Display type	Capacitive touch screen
Auto orientation	Automatic landscape or portrait
Viewfinder	Built-in 800 × 480 pixels
Automatic image adjustment	Continuous, histogram based
Automatic image adjustment, type	Standard or histogram based from image content
Manual image adjustment	Linear based; Possible to adjust level/span/max/min

Image presentation modes	
Image modes	Thermal, Thermal MSX, Picture in Picture, Digital Camera
Infrared image	Full color IR image
Visual image	Full color visual image
Multi Spectral Dynamic Imaging (MSX)	Thermal image with enhanced detail presentation
Picture in Picture	Resizable and movable IR area on visual image
Measurement analysis	
Spotmeter	10
Area	5+5 areas (boxes and circles) with max./min./average
Profile	1 line profile with max/min temp
Automatic hot/cold detection	Auto hot or cold spotmeter markers within area and profile
Measurement presets	No measurements, Center spot, Hot spot, Cold spot, User preset 1, User preset 2
User presets	The user can select and combine measurements from any number of spots/boxes/circles/profiles/delta
Difference temperature	Delta temperature between measurement functions or reference temperature
Reference temperature	Manually set using difference temperature
Atmospheric transmission correction	Automatic, based on inputs for distance, atmospheric temperature and relative humidity
Optics transmission correction	Automatic, based on signals from internal sensors
Emissivity correction	Variable from 0.01 to 1.0 or selected from materials list
Emissivity table	Emissivity table of predefined materials
Reflected apparent temperature correction	Automatic, based on input of reflected temperature
External optics/windows correction	Automatic, based on inputs of window transmission and temperature
Measurement corrections	Emissivity, reflected temperature, relative humidity, atmospheric temperature, object distance, external IR window compensation
Colors (palettes)	Iron, Rainbow, Rainbow HC, White hot, Black hot, Artic, Lava
Alarm	
Color Alarm (isotherm)	Above/below/interval
Measurement function alarm	Audible/visual alarms (above/below) on any selected measurement function
Set-up	
Set-up commands	Define user presets, Save options, Programmable button, Reset options, Set up camera, Wi-Fi, GPS & compass, Bluetooth, Language, Time & units, Camera information
Service functions	
Camera software update	Use PC software FLIR Tools

Storage of images	
Image storage	Standard JPEG, including digital photo and measurement data, on memory card
Storage media	Removable memory SD card (class 10)
Image storage mode	<ul style="list-style-type: none"> • Simultaneous storage of thermal and digital photo in same JPEG. • Optional to store digital photo as separate JPEG.
Time lapse	15 seconds to 24 hours
File formats	<ul style="list-style-type: none"> • Standard JPEG, measurement data included • CSQ, measurement data included
File formats, visual	Standard JPEG, automatically associated with corresponding thermal image
Image annotations	
Voice	60 seconds (via Bluetooth) stored with the image
Text	Add table. Select between predefined templates
Image description	Add short note (stored in JPEG exif tag)
Sketch	<ul style="list-style-type: none"> • Draw on thermal/digital photo or add predefined stamps • Separate PC software with extensive report generation
Geographic Information System	
GPS	Location data automatically added to every image from built-in GPS
Compass	Camera direction automatically added to every image
Video recording in camera	
Radiometric IR-video recording	Real-time radiometric recording (RTRR) to memory card
Non-radiometric IR-video recording	H.264 to memory card
Visual video recording	H.264 to memory card
Video streaming	
Radiometric IR-video streaming	<ul style="list-style-type: none"> • Full dynamic to PC using high speed interface • Real-time radiometric streaming (RTRS) via USB
Non-radiometric IR-video streaming	<ul style="list-style-type: none"> • H.264 video using Wi-Fi • H.264 video using USB
Visual video streaming	<ul style="list-style-type: none"> • H.264 video using Wi-Fi • H.264 video using USB
Digital camera	
Digital camera	FOV adapts to the IR lens
Video lamp	Built-in LED light
Laser pointer	
Laser	Activated by dedicated button
Laser alignment	Position is automatic displayed on the IR image

Laser pointer	
Laser classification	Class 2
Laser type	Semiconductor AlGaInP diode laser, 1 mW, 635 nm (red)
Data communication interfaces	
Interfaces	USB-micro-AB, Bluetooth, Wi-Fi, HDMI
Bluetooth	Communication with headset
Wi-Fi	Peer to peer (ad-hoc), infrastructure (network) or AP
SD Card	One card slot for removable SD memory cards
Audio	Microphone headset via Bluetooth for voice annotation of images
USB	
USB	USB Micro -AB: Data transfer to and from PC / Uncompressed colorized video
USB, standard	<ul style="list-style-type: none"> • USB 2.0 High Speed • USB Micro-AB connector
Video	
Video out	HDMI compatible
Video, connector type	HDMI type C
Radio	
Wi-Fi	<ul style="list-style-type: none"> • Standard: 802.11 b/g/n • Frequency range: 2412–2462 MHz • Max output power: 15 dBm
Bluetooth	Frequency range: 2402–2480 MHz Supports 2.1, 4.0 and 4.0BLE
Antenna	Internal
Power system	
Battery	Li Ion
Battery type	Rechargeable Li Ion battery
Battery operating time	> 2.5 hours at 25°C (+68°F) and typical use
Charging system	In camera (AC adapter or 12 V from a vehicle) or 2-bay charger
Charging time	2.5 h to 90 % capacity, charging status indicated by LED's
Charging temperature	0°C to +45°C (+32°F to +113°F)
External power operation	AC adapter 90–260 VAC, 50/60 Hz or 12 V from a vehicle (cable with standard plug, optional)
Power management	Automatic power-off functionality, user-configurable between 5 min, 20 min, or no automatic shutdown
Environmental data	
Storage temperature range	–40°C to +70°C (–40°F to +158°F)
Humidity (operating and storage)	IEC 60068-2-30/24 h 95% relative humidity +25°C to +40°C (+77°F to +104°F) / 2 cycles

Environmental data	
EMC	<ul style="list-style-type: none"> • ETSI EN 301 489-1 (radio) • ETSI EN 301 489-17 • EN 61000-6-2 (Immunity) • EN 61000-6-3 (Emission) • FCC 47 CFR Part 15 Class B (Emission) • ICES-003
Radio spectrum	<ul style="list-style-type: none"> • ETSI EN 300 328 • FCC Part 15.247 • RSS-247 issue 1
Encapsulation	IP 54 (IEC 60529)
Shock	25 g (IEC 60068-2-29)
Vibration	2 g (IEC 60068-2-6)
Safety	EN/UL/CSA/PSE 60950-1
Physical data	
Weight	1.9 kg (4.3 lb.)
Tripod mounting	UNC ¼"-20
Housing material	Magnesium
Shipping information	
List of contents	<ul style="list-style-type: none"> • Infrared camera with lens • Battery (2 ea.) • Battery charger • Bluetooth headset • Calibration certificate • FLIR ResearchIR Max 4 • FLIR Tools+ license card • User documentation CD-ROM • Printed documentation • HDMI-HDMI cable • Hard transport case • Large eyecap • Lens cap • Memory card • Neck strap • Power supply, incl. multi-plugs • USB cable, Std A to Micro-B • High-speed interface
EAN-13	7332558010310
UPC-12	845188010959
Country of origin	Sweden

24.9 FLIR T1030sc 45°

P/N: 72501-0203

Rev.: 28063

General description	
<p>The FLIR T1030sc is designed for the expert requiring the highest performance and the latest technology available. The camera combines excellent ergonomics and feature-rich flexibility with superior image quality of 1024 × 768 pixel IR resolution. High accuracy and sensitivity together with radiometric recording and streaming options make the T1030sc well suited for advanced research and development.</p>	
<p>Benefits:</p> <ul style="list-style-type: none"> • Tailor made for research and development: The T1030sc has high accuracy and high sensitivity to accurately measure the smallest temperature differences. With real-time radiometric recording in the camera, it is possible to capture fast events on the camera's SD card for further analysis by the supplied analysis software. • Flexible and feature rich: A wide variety of measuring and analysis functions makes the camera flexible for your every need. Two programmable buttons provide easy access to favorite functions. • Highest performance with the latest technology: The T1030sc camera is equipped with the innovative 'Multi Spectral Dynamic Imaging (MSX)' feature, which produces an image richer in detail than ever before. Continuous auto-focus makes the T1030sc a fully automatic IR camera. 	
Imaging and optical data	
IR resolution	1024 × 768 pixels
Thermal sensitivity/NETD	<20 mK @ +30°C (+86°F)
Field of view (FOV)	45° × 34°
Minimum focus distance	0.2 m (0.66 ft.)
Field of view (FOV) / Minimum focus distance	45° × 34° / 0.2 m (0.66 ft.)
Focal length	21.2 mm (0.83 in.)
Spatial resolution (IFOV)	0.80 mrad
Lens identification	Automatic
F-number	1.1
Image frequency	30 Hz
Focus	Continuous, one shot or manual
Digital zoom	1–8× continuous
Zoom	1–8× continuous, digital zoom
Digital image enhancement	Adaptive digital noise reduction
Detector data	
Detector type	Focal Plane Array (FPA), uncooled microbolometer
Spectral range	7.5–14 μm
Detector pitch	17 μm
Image presentation	
Display	Built-in touch screen, 4.3 in. wide screen LCD, 800 × 480 pixels
Display type	Capacitive touch screen
Auto orientation	Automatic landscape or portrait
Viewfinder	Built-in 800 × 480 pixels
Automatic image adjustment	Continuous, histogram based
Automatic image adjustment, type	Standard or histogram based from image content
Manual image adjustment	Linear based; Possible to adjust level/span/max/min

Image presentation modes	
Image modes	Thermal, Thermal MSX, Picture in Picture, Digital Camera
Infrared image	Full color IR image
Visual image	Full color visual image
Multi Spectral Dynamic Imaging (MSX)	Thermal image with enhanced detail presentation
Picture in Picture	Resizable and movable IR area on visual image
Measurement analysis	
Spotmeter	10
Area	5+5 areas (boxes and circles) with max./min./average
Profile	1 line profile with max/min temp
Automatic hot/cold detection	Auto hot or cold spotmeter markers within area and profile
Measurement presets	No measurements, Center spot, Hot spot, Cold spot, User preset 1, User preset 2
User presets	The user can select and combine measurements from any number of spots/boxes/circles/profiles/delta
Difference temperature	Delta temperature between measurement functions or reference temperature
Reference temperature	Manually set using difference temperature
Atmospheric transmission correction	Automatic, based on inputs for distance, atmospheric temperature and relative humidity
Optics transmission correction	Automatic, based on signals from internal sensors
Emissivity correction	Variable from 0.01 to 1.0 or selected from materials list
Emissivity table	Emissivity table of predefined materials
Reflected apparent temperature correction	Automatic, based on input of reflected temperature
External optics/windows correction	Automatic, based on inputs of window transmission and temperature
Measurement corrections	Emissivity, reflected temperature, relative humidity, atmospheric temperature, object distance, external IR window compensation
Colors (palettes)	Iron, Rainbow, Rainbow HC, White hot, Black hot, Artic, Lava
Alarm	
Color Alarm (isotherm)	Above/below/interval
Measurement function alarm	Audible/visual alarms (above/below) on any selected measurement function
Set-up	
Set-up commands	Define user presets, Save options, Programmable button, Reset options, Set up camera, Wi-Fi, GPS & compass, Bluetooth, Language, Time & units, Camera information
Service functions	
Camera software update	Use PC software FLIR Tools

Storage of images	
Image storage	Standard JPEG, including digital photo and measurement data, on memory card
Storage media	Removable memory SD card (class 10)
Image storage mode	<ul style="list-style-type: none"> • Simultaneous storage of thermal and digital photo in same JPEG. • Optional to store digital photo as separate JPEG.
Time lapse	15 seconds to 24 hours
File formats	<ul style="list-style-type: none"> • Standard JPEG, measurement data included • CSQ, measurement data included
File formats, visual	Standard JPEG, automatically associated with corresponding thermal image
Image annotations	
Voice	60 seconds (via Bluetooth) stored with the image
Text	Add table. Select between predefined templates
Image description	Add short note (stored in JPEG exif tag)
Sketch	<ul style="list-style-type: none"> • Draw on thermal/digital photo or add predefined stamps • Separate PC software with extensive report generation
Geographic Information System	
GPS	Location data automatically added to every image from built-in GPS
Compass	Camera direction automatically added to every image
Video recording in camera	
Radiometric IR-video recording	Real-time radiometric recording (RTRR) to memory card
Non-radiometric IR-video recording	H.264 to memory card
Visual video recording	H.264 to memory card
Video streaming	
Radiometric IR-video streaming	<ul style="list-style-type: none"> • Full dynamic to PC using high speed interface • Real-time radiometric streaming (RTRS) via USB
Non-radiometric IR-video streaming	<ul style="list-style-type: none"> • H.264 video using Wi-Fi • H.264 video using USB
Visual video streaming	<ul style="list-style-type: none"> • H.264 video using Wi-Fi • H.264 video using USB
Digital camera	
Digital camera	FOV adapts to the IR lens
Video lamp	Built-in LED light
Laser pointer	
Laser	Activated by dedicated button
Laser alignment	Position is automatic displayed on the IR image

Laser pointer	
Laser classification	Class 2
Laser type	Semiconductor AlGaInP diode laser, 1 mW, 635 nm (red)
Data communication interfaces	
Interfaces	USB-micro-AB, Bluetooth, Wi-Fi, HDMI
Bluetooth	Communication with headset
Wi-Fi	Peer to peer (ad-hoc), infrastructure (network) or AP
SD Card	One card slot for removable SD memory cards
Audio	Microphone headset via Bluetooth for voice annotation of images
USB	
USB	USB Micro -AB: Data transfer to and from PC / Uncompressed colorized video
USB, standard	<ul style="list-style-type: none"> • USB 2.0 High Speed • USB Micro-AB connector
Video	
Video out	HDMI compatible
Video, connector type	HDMI type C
Radio	
Wi-Fi	<ul style="list-style-type: none"> • Standard: 802.11 b/g/n • Frequency range: 2412–2462 MHz • Max output power: 15 dBm
Bluetooth	Frequency range: 2402–2480 MHz Supports 2.1, 4.0 and 4.0BLE
Antenna	Internal
Power system	
Battery	Li Ion
Battery type	Rechargeable Li Ion battery
Battery operating time	> 2.5 hours at 25°C (+68°F) and typical use
Charging system	In camera (AC adapter or 12 V from a vehicle) or 2-bay charger
Charging time	2.5 h to 90 % capacity, charging status indicated by LED's
Charging temperature	0°C to +45°C (+32°F to +113°F)
External power operation	AC adapter 90–260 VAC, 50/60 Hz or 12 V from a vehicle (cable with standard plug, optional)
Power management	Automatic power-off functionality, user-configurable between 5 min, 20 min, or no automatic shutdown
Environmental data	
Storage temperature range	–40°C to +70°C (–40°F to +158°F)
Humidity (operating and storage)	IEC 60068-2-30/24 h 95% relative humidity +25°C to +40°C (+77°F to +104°F) / 2 cycles

Environmental data	
EMC	<ul style="list-style-type: none"> • ETSI EN 301 489-1 (radio) • ETSI EN 301 489-17 • EN 61000-6-2 (Immunity) • EN 61000-6-3 (Emission) • FCC 47 CFR Part 15 Class B (Emission) • ICES-003
Radio spectrum	<ul style="list-style-type: none"> • ETSI EN 300 328 • FCC Part 15.247 • RSS-247 issue 1
Encapsulation	IP 54 (IEC 60529)
Shock	25 g (IEC 60068-2-29)
Vibration	2 g (IEC 60068-2-6)
Safety	EN/UL/CSA/PSE 60950-1
Physical data	
Weight	2.0 kg (4.3 lb.)
Tripod mounting	UNC ¼"-20
Housing material	Magnesium
Shipping information	
List of contents	<ul style="list-style-type: none"> • Infrared camera with lens • Battery (2 ea.) • Battery charger • Bluetooth headset • Calibration certificate • FLIR ResearchIR Max 4 • FLIR Tools+ license card • User documentation CD-ROM • Printed documentation • HDMI-HDMI cable • Hard transport case • Large eyecap • Lens cap • Memory card • Neck strap • Power supply, incl. multi-plugs • USB cable, Std A to Micro-B • High-speed interface
EAN-13	7332558010327
UPC-12	845188010966
Country of origin	Sweden

24.10 FLIR T1040 12°

P/N: 72501-0301

Rev.: 28063

General description	
The FLIR T1040 is designed for the expert requiring the highest performance and the latest technology available. The camera combines excellent ergonomics and feature-rich flexibility with superior image quality of 1024 × 768 pixel IR resolution. High accuracy and sensitivity together with radiometric recording and streaming options make the T1040 well suited for advanced research and development.	
Benefits:	
<ul style="list-style-type: none"> • Tailor made for research and development: The T1040 has high accuracy and high sensitivity to accurately measure the smallest temperature differences. With real-time radiometric recording in the camera, it is possible to capture fast events on the camera's SD card for further analysis by the supplied analysis software. • Flexible and feature rich: A wide variety of measuring and analysis functions makes the camera flexible for your every need. Two programmable buttons provide easy access to favorite functions. • Highest performance with the latest technology: The T1040 camera is equipped with the innovative 'Multi Spectral Dynamic Imaging (MSX)' feature, which produces an image richer in detail than ever before. Continuous auto-focus makes the T1040 a fully automatic IR camera. 	
Imaging and optical data	
IR resolution	1024 × 768 pixels
Thermal sensitivity/NETD	<20 mK @ +30°C (+86°F)
Field of view (FOV)	12° × 9°
Minimum focus distance	0.8 m (2.63 ft.)
Field of view (FOV) / Minimum focus distance	12° × 9° / 0.8 m (2.63 ft.)
Focal length	83.4 mm (3.28 in.)
Spatial resolution (IFOV)	0.20 mrad
Lens identification	Automatic
F-number	1.2
Image frequency	30 Hz
Focus	Continuous, one shot or manual
Digital zoom	1–8× continuous
Zoom	1–8× continuous, digital zoom
Digital image enhancement	Adaptive digital noise reduction
Detector data	
Detector type	Focal Plane Array (FPA), uncooled microbolometer
Spectral range	7.5–14 μm
Detector pitch	17 μm
Image presentation	
Display	Built-in touch screen, 4.3 in. wide screen LCD, 800 × 480 pixels
Display type	Capacitive touch screen
Auto orientation	Automatic landscape or portrait
Viewfinder	Built-in 800 × 480 pixels
Automatic image adjustment	Continuous, histogram based
Automatic image adjustment, type	Standard or histogram based from image content
Manual image adjustment	Linear based; Possible to adjust level/span/max/min

Image presentation modes	
Image modes	Thermal, Thermal MSX, Picture in Picture, Digital Camera
Infrared image	Full color IR image
Visual image	Full color visual image
Multi Spectral Dynamic Imaging (MSX)	Thermal image with enhanced detail presentation
Picture in Picture	Resizable and movable IR area on visual image
Measurement analysis	
Spotmeter	10
Area	5+5 areas (boxes and circles) with max./min./average
Profile	1 line profile with max/min temp
Automatic hot/cold detection	Auto hot or cold spotmeter markers within area and profile
Measurement presets	No measurements, Center spot, Hot spot, Cold spot, User preset 1, User preset 2
User presets	The user can select and combine measurements from any number of spots/boxes/circles/profiles/delta
Difference temperature	Delta temperature between measurement functions or reference temperature
Reference temperature	Manually set using difference temperature
Atmospheric transmission correction	Automatic, based on inputs for distance, atmospheric temperature and relative humidity
Optics transmission correction	Automatic, based on signals from internal sensors
Emissivity correction	Variable from 0.01 to 1.0 or selected from materials list
Emissivity table	Emissivity table of predefined materials
Reflected apparent temperature correction	Automatic, based on input of reflected temperature
External optics/windows correction	Automatic, based on inputs of window transmission and temperature
Measurement corrections	Emissivity, reflected temperature, relative humidity, atmospheric temperature, object distance, external IR window compensation
Colors (palettes)	Iron, Rainbow, Rainbow HC, White hot, Black hot, Artic, Lava
Alarm	
Color Alarm (isotherm)	Above/below/interval
Measurement function alarm	Audible/visual alarms (above/below) on any selected measurement function
Set-up	
Set-up commands	Define user presets, Save options, Programmable button, Reset options, Set up camera, Wi-Fi, GPS & compass, Bluetooth, Language, Time & units, Camera information
Service functions	
Camera software update	Use PC software FLIR Tools

Storage of images	
Image storage	Standard JPEG, including digital photo and measurement data, on memory card
Storage media	Removable memory SD card (class 10)
Image storage mode	<ul style="list-style-type: none"> • Simultaneous storage of thermal and digital photo in same JPEG. • Optional to store digital photo as separate JPEG.
Time lapse	15 seconds to 24 hours
File formats	<ul style="list-style-type: none"> • Standard JPEG, measurement data included • CSQ, measurement data included
File formats, visual	Standard JPEG, automatically associated with corresponding thermal image
Image annotations	
Voice	60 seconds (via Bluetooth) stored with the image
Text	Add table. Select between predefined templates
Image description	Add short note (stored in JPEG exif tag)
Sketch	<ul style="list-style-type: none"> • Draw on thermal/digital photo or add predefined stamps • Separate PC software with extensive report generation
Geographic Information System	
GPS	Location data automatically added to every image from built-in GPS
Compass	Camera direction automatically added to every image
Video recording in camera	
Radiometric IR-video recording	Real-time radiometric recording (RTRR) to memory card
Non-radiometric IR-video recording	H.264 to memory card
Visual video recording	H.264 to memory card
Video streaming	
Radiometric IR-video streaming	Real-time radiometric streaming (RTRS) via USB
Non-radiometric IR-video streaming	<ul style="list-style-type: none"> • H.264 video using Wi-Fi • H.264 video using USB
Visual video streaming	<ul style="list-style-type: none"> • H.264 video using Wi-Fi • H.264 video using USB
Digital camera	
Digital camera	FOV adapts to the IR lens
Video lamp	Built-in LED light
Laser pointer	
Laser	Activated by dedicated button
Laser alignment	Position is automatic displayed on the IR image
Laser classification	Class 2
Laser type	Semiconductor AlGaInP diode laser, 1 mW, 635 nm (red)

Data communication interfaces	
Interfaces	USB-micro-AB, Bluetooth, Wi-Fi, HDMI
Bluetooth	Communication with headset
Wi-Fi	Peer to peer (ad hoc), infrastructure (network) or AP
SD Card	One card slot for removable SD memory cards
Audio	Microphone headset via Bluetooth for voice annotation of images
USB	
USB	USB Micro -AB: Data transfer to and from PC / Uncompressed colorized video
USB, standard	<ul style="list-style-type: none"> • USB 2.0 High Speed • USB Micro-AB connector
Video	
Video out	HDMI compatible
Video, connector type	HDMI type C
Radio	
Wi-Fi	<ul style="list-style-type: none"> • Standard: 802.11 b/g/n • Frequency range: 2412–2462 MHz • Max output power: 15 dBm
Bluetooth	Frequency range: 2402–2480 MHz Supports 2.1, 4.0 and 4.0BLE
Antenna	Internal
Power system	
Battery	Li Ion
Battery type	Rechargeable Li Ion battery
Battery operating time	> 2.5 hours at 25°C (+68°F) and typical use
Charging system	In camera (AC adapter or 12 V from a vehicle) or 2-bay charger
Charging time	2.5 h to 90 % capacity, charging status indicated by LED's
Charging temperature	0°C to +45°C (+32°F to +113°F)
External power operation	AC adapter 90–260 VAC, 50/60 Hz or 12 V from a vehicle (cable with standard plug, optional)
Power management	Automatic power-off functionality, user-configurable between 5 min, 20 min, or no automatic shutdown
Environmental data	
Storage temperature range	–40°C to +70°C (–40°F to +158°F)
Humidity (operating and storage)	IEC 60068-2-30/24 h 95% relative humidity +25°C to +40°C (+77°F to +104°F) / 2 cycles
EMC	<ul style="list-style-type: none"> • ETSI EN 301 489-1 (radio) • ETSI EN 301 489-17 • EN 61000-6-2 (Immunity) • EN 61000-6-3 (Emission) • FCC 47 CFR Part 15 Class B (Emission) • ICES-003
Radio spectrum	<ul style="list-style-type: none"> • ETSI EN 300 328 • FCC Part 15.247 • RSS-247 issue 1

Environmental data	
Encapsulation	IP 54 (IEC 60529)
Shock	25 g (IEC 60068-2-29)
Vibration	2 g (IEC 60068-2-6)
Safety	EN/UL/CSA/PSE 60950-1
Physical data	
Weight	2.1 kg (4.6 lb.)
Tripod mounting	UNC ¼"-20
Housing material	Magnesium
Shipping information	
List of contents	<ul style="list-style-type: none"> • Infrared camera with lens • Battery (2 ea.) • Battery charger • Bluetooth headset • Calibration certificate • FLIR Tools+ license card • User documentation CD-ROM • Printed documentation • HDMI-HDMI cable • Hard transport case • Large eyecap • Lens cap • Memory card • Neck strap • Power supply, incl. multi-plugs • USB cable, Std A to Micro-B
EAN-13	7332558010389
UPC-12	845188011031
Country of origin	Sweden

24.11 FLIR T1040 28°

P/N: 72501-0302

Rev.: 28063

General description	
The FLIR T1040 is designed for the expert requiring the highest performance and the latest technology available. The camera combines excellent ergonomics and feature-rich flexibility with superior image quality of 1024 × 768 pixel IR resolution. High accuracy and sensitivity together with radiometric recording and streaming options make the T1040 well suited for advanced research and development.	
Benefits:	
<ul style="list-style-type: none"> • Tailor made for research and development: The T1040 has high accuracy and high sensitivity to accurately measure the smallest temperature differences. With real-time radiometric recording in the camera, it is possible to capture fast events on the camera's SD card for further analysis by the supplied analysis software. • Flexible and feature rich: A wide variety of measuring and analysis functions makes the camera flexible for your every need. Two programmable buttons provide easy access to favorite functions. • Highest performance with the latest technology: The T1040 camera is equipped with the innovative 'Multi Spectral Dynamic Imaging (MSX)' feature, which produces an image richer in detail than ever before. Continuous auto-focus makes the T1040 a fully automatic IR camera. 	
Imaging and optical data	
IR resolution	1024 × 768 pixels
Thermal sensitivity/NETD	<20 mK @ +30°C (+86°F)
Field of view (FOV)	28° × 21°
Minimum focus distance	0.4 m (1.32 ft.)
Field of view (FOV) / Minimum focus distance	28° × 21° / 0.4 m (1.32 ft.)
Focal length	36 mm (1.42 in.)
Spatial resolution (IFOV)	0.47mrad
Lens identification	Automatic
F-number	1.15
Image frequency	30 Hz
Focus	Continuous, one shot or manual
Digital zoom	1–8× continuous
Zoom	1–8× continuous, digital zoom
Digital image enhancement	Adaptive digital noise reduction
Detector data	
Detector type	Focal Plane Array (FPA), uncooled microbolometer
Spectral range	7.5–14 μm
Detector pitch	17 μm
Image presentation	
Display	Built-in touch screen, 4.3 in. wide screen LCD, 800 × 480 pixels
Display type	Capacitive touch screen
Auto orientation	Automatic landscape or portrait
Viewfinder	Built-in 800 × 480 pixels
Automatic image adjustment	Continuous, histogram based
Automatic image adjustment, type	Standard or histogram based from image content
Manual image adjustment	Linear based; Possible to adjust level/span/max/min

Image presentation modes	
Image modes	Thermal, Thermal MSX, Picture in Picture, Digital Camera
Infrared image	Full color IR image
Visual image	Full color visual image
Multi Spectral Dynamic Imaging (MSX)	Thermal image with enhanced detail presentation
Picture in Picture	Resizable and movable IR area on visual image
Measurement analysis	
Spotmeter	10
Area	5+5 areas (boxes and circles) with max./min./average
Profile	1 line profile with max/min temp
Automatic hot/cold detection	Auto hot or cold spotmeter markers within area and profile
Measurement presets	No measurements, Center spot, Hot spot, Cold spot, User preset 1, User preset 2
User presets	The user can select and combine measurements from any number of spots/boxes/circles/profiles/delta
Difference temperature	Delta temperature between measurement functions or reference temperature
Reference temperature	Manually set using difference temperature
Atmospheric transmission correction	Automatic, based on inputs for distance, atmospheric temperature and relative humidity
Optics transmission correction	Automatic, based on signals from internal sensors
Emissivity correction	Variable from 0.01 to 1.0 or selected from materials list
Emissivity table	Emissivity table of predefined materials
Reflected apparent temperature correction	Automatic, based on input of reflected temperature
External optics/windows correction	Automatic, based on inputs of window transmission and temperature
Measurement corrections	Emissivity, reflected temperature, relative humidity, atmospheric temperature, object distance, external IR window compensation
Colors (palettes)	Iron, Rainbow, Rainbow HC, White hot, Black hot, Artic, Lava
Alarm	
Color Alarm (isotherm)	Above/below/interval
Measurement function alarm	Audible/visual alarms (above/below) on any selected measurement function
Set-up	
Set-up commands	Define user presets, Save options, Programmable button, Reset options, Set up camera, Wi-Fi, GPS & compass, Bluetooth, Language, Time & units, Camera information
Service functions	
Camera software update	Use PC software FLIR Tools

Storage of images	
Image storage	Standard JPEG, including digital photo and measurement data, on memory card
Storage media	Removable memory SD card (class 10)
Image storage mode	<ul style="list-style-type: none"> • Simultaneous storage of thermal and digital photo in same JPEG. • Optional to store digital photo as separate JPEG.
Time lapse	15 seconds to 24 hours
File formats	<ul style="list-style-type: none"> • Standard JPEG, measurement data included • CSQ, measurement data included
File formats, visual	Standard JPEG, automatically associated with corresponding thermal image
Image annotations	
Voice	60 seconds (via Bluetooth) stored with the image
Text	Add table. Select between predefined templates
Image description	Add short note (stored in JPEG exif tag)
Sketch	<ul style="list-style-type: none"> • Draw on thermal/digital photo or add predefined stamps • Separate PC software with extensive report generation
Geographic Information System	
GPS	Location data automatically added to every image from built-in GPS
Compass	Camera direction automatically added to every image
Video recording in camera	
Radiometric IR-video recording	Real-time radiometric recording (RTRR) to memory card
Non-radiometric IR-video recording	H.264 to memory card
Visual video recording	H.264 to memory card
Video streaming	
Radiometric IR-video streaming	Real-time radiometric streaming (RTRS) via USB
Non-radiometric IR-video streaming	<ul style="list-style-type: none"> • H.264 video using Wi-Fi • H.264 video using USB
Visual video streaming	<ul style="list-style-type: none"> • H.264 video using Wi-Fi • H.264 video using USB
Digital camera	
Digital camera	FOV adapts to the IR lens
Video lamp	Built-in LED light
Laser pointer	
Laser	Activated by dedicated button
Laser alignment	Position is automatic displayed on the IR image
Laser classification	Class 2
Laser type	Semiconductor AlGaInP diode laser, 1 mW, 635 nm (red)

Data communication interfaces	
Interfaces	USB-micro-AB, Bluetooth, Wi-Fi, HDMI
Bluetooth	Communication with headset
Wi-Fi	Peer to peer (ad hoc), infrastructure (network) or AP
SD Card	One card slot for removable SD memory cards
Audio	Microphone headset via Bluetooth for voice annotation of images
USB	
USB	USB Micro -AB: Data transfer to and from PC / Uncompressed colorized video
USB, standard	<ul style="list-style-type: none"> • USB 2.0 High Speed • USB Micro-AB connector
Video	
Video out	HDMI compatible
Video, connector type	HDMI type C
Radio	
Wi-Fi	<ul style="list-style-type: none"> • Standard: 802.11 b/g/n • Frequency range: 2412–2462 MHz • Max output power: 15 dBm
Bluetooth	Frequency range: 2402–2480 MHz Supports 2.1, 4.0 and 4.0BLE
Antenna	Internal
Power system	
Battery	Li Ion
Battery type	Rechargeable Li Ion battery
Battery operating time	> 2.5 hours at 25°C (+68°F) and typical use
Charging system	In camera (AC adapter or 12 V from a vehicle) or 2-bay charger
Charging time	2.5 h to 90 % capacity, charging status indicated by LED's
Charging temperature	0°C to +45°C (+32°F to +113°F)
External power operation	AC adapter 90–260 VAC, 50/60 Hz or 12 V from a vehicle (cable with standard plug, optional)
Power management	Automatic power-off functionality, user-configurable between 5 min, 20 min, or no automatic shutdown
Environmental data	
Storage temperature range	–40°C to +70°C (–40°F to +158°F)
Humidity (operating and storage)	IEC 60068-2-30/24 h 95% relative humidity +25°C to +40°C (+77°F to +104°F) / 2 cycles
EMC	<ul style="list-style-type: none"> • ETSI EN 301 489-1 (radio) • ETSI EN 301 489-17 • EN 61000-6-2 (Immunity) • EN 61000-6-3 (Emission) • FCC 47 CFR Part 15 Class B (Emission) • ICES-003
Radio spectrum	<ul style="list-style-type: none"> • ETSI EN 300 328 • FCC Part 15.247 • RSS-247 issue 1

Environmental data	
Encapsulation	IP 54 (IEC 60529)
Shock	25 g (IEC 60068-2-29)
Vibration	2 g (IEC 60068-2-6)
Safety	EN/UL/CSA/PSE 60950-1
Physical data	
Weight	1.9 kg (4.3 lb.)
Tripod mounting	UNC ¼"-20
Housing material	Magnesium
Shipping information	
List of contents	<ul style="list-style-type: none"> • Infrared camera with lens • Battery (2 ea.) • Battery charger • Bluetooth headset • Calibration certificate • FLIR Tools+ license card • User documentation CD-ROM • Printed documentation • HDMI-HDMI cable • Hard transport case • Large eyecap • Lens cap • Memory card • Neck strap • Power supply, incl. multi-plugs • USB cable, Std A to Micro-B
EAN-13	7332558010396
UPC-12	845188011048
Country of origin	Sweden

24.12 FLIR T1040 45°

P/N: 72501-0303

Rev.: 28063

General description	
The FLIR T1040 is designed for the expert requiring the highest performance and the latest technology available. The camera combines excellent ergonomics and feature-rich flexibility with superior image quality of 1024 × 768 pixel IR resolution. High accuracy and sensitivity together with radiometric recording and streaming options make the T1040 well suited for advanced research and development.	
Benefits:	
<ul style="list-style-type: none"> • Tailor made for research and development: The T1040 has high accuracy and high sensitivity to accurately measure the smallest temperature differences. With real-time radiometric recording in the camera, it is possible to capture fast events on the camera's SD card for further analysis by the supplied analysis software. • Flexible and feature rich: A wide variety of measuring and analysis functions makes the camera flexible for your every need. Two programmable buttons provide easy access to favorite functions. • Highest performance with the latest technology: The T1040 camera is equipped with the innovative 'Multi Spectral Dynamic Imaging (MSX)' feature, which produces an image richer in detail than ever before. Continuous auto-focus makes the T1040 a fully automatic IR camera. 	
Imaging and optical data	
IR resolution	1024 × 768 pixels
Thermal sensitivity/NETD	<20 mK @ +30°C (+86°F)
Field of view (FOV)	45° × 34°
Minimum focus distance	0.2 m (0.66 ft.)
Field of view (FOV) / Minimum focus distance	45° × 34° / 0.2 m (0.66 ft.)
Focal length	21.2 mm (0.83 in.)
Spatial resolution (IFOV)	0.80 mrad
Lens identification	Automatic
F-number	1.1
Image frequency	30 Hz
Focus	Continuous, one shot or manual
Digital zoom	1–8× continuous
Zoom	1–8× continuous, digital zoom
Digital image enhancement	Adaptive digital noise reduction
Detector data	
Detector type	Focal Plane Array (FPA), uncooled microbolometer
Spectral range	7.5–14 μm
Detector pitch	17 μm
Image presentation	
Display	Built-in touch screen, 4.3 in. wide screen LCD, 800 × 480 pixels
Display type	Capacitive touch screen
Auto orientation	Automatic landscape or portrait
Viewfinder	Built-in 800 × 480 pixels
Automatic image adjustment	Continuous, histogram based
Automatic image adjustment, type	Standard or histogram based from image content
Manual image adjustment	Linear based; Possible to adjust level/span/max/min

Image presentation modes	
Image modes	Thermal, Thermal MSX, Picture in Picture, Digital Camera
Infrared image	Full color IR image
Visual image	Full color visual image
Multi Spectral Dynamic Imaging (MSX)	Thermal image with enhanced detail presentation
Picture in Picture	Resizable and movable IR area on visual image
Measurement analysis	
Spotmeter	10
Area	5+5 areas (boxes and circles) with max./min./average
Profile	1 line profile with max/min temp
Automatic hot/cold detection	Auto hot or cold spotmeter markers within area and profile
Measurement presets	No measurements, Center spot, Hot spot, Cold spot, User preset 1, User preset 2
User presets	The user can select and combine measurements from any number of spots/boxes/circles/profiles/delta
Difference temperature	Delta temperature between measurement functions or reference temperature
Reference temperature	Manually set using difference temperature
Atmospheric transmission correction	Automatic, based on inputs for distance, atmospheric temperature and relative humidity
Optics transmission correction	Automatic, based on signals from internal sensors
Emissivity correction	Variable from 0.01 to 1.0 or selected from materials list
Emissivity table	Emissivity table of predefined materials
Reflected apparent temperature correction	Automatic, based on input of reflected temperature
External optics/windows correction	Automatic, based on inputs of window transmission and temperature
Measurement corrections	Emissivity, reflected temperature, relative humidity, atmospheric temperature, object distance, external IR window compensation
Colors (palettes)	Iron, Rainbow, Rainbow HC, White hot, Black hot, Artic, Lava
Alarm	
Color Alarm (isotherm)	Above/below/interval
Measurement function alarm	Audible/visual alarms (above/below) on any selected measurement function
Set-up	
Set-up commands	Define user presets, Save options, Programmable button, Reset options, Set up camera, Wi-Fi, GPS & compass, Bluetooth, Language, Time & units, Camera information
Service functions	
Camera software update	Use PC software FLIR Tools

Storage of images	
Image storage	Standard JPEG, including digital photo and measurement data, on memory card
Storage media	Removable memory SD card (class 10)
Image storage mode	<ul style="list-style-type: none"> • Simultaneous storage of thermal and digital photo in same JPEG. • Optional to store digital photo as separate JPEG.
Time lapse	15 seconds to 24 hours
File formats	<ul style="list-style-type: none"> • Standard JPEG, measurement data included • CSQ, measurement data included
File formats, visual	Standard JPEG, automatically associated with corresponding thermal image
Image annotations	
Voice	60 seconds (via Bluetooth) stored with the image
Text	Add table. Select between predefined templates
Image description	Add short note (stored in JPEG exif tag)
Sketch	<ul style="list-style-type: none"> • Draw on thermal/digital photo or add predefined stamps • Separate PC software with extensive report generation
Geographic Information System	
GPS	Location data automatically added to every image from built-in GPS
Compass	Camera direction automatically added to every image
Video recording in camera	
Radiometric IR-video recording	Real-time radiometric recording (RTRR) to memory card
Non-radiometric IR-video recording	H.264 to memory card
Visual video recording	H.264 to memory card
Video streaming	
Radiometric IR-video streaming	Real-time radiometric streaming (RTRS) via USB
Non-radiometric IR-video streaming	<ul style="list-style-type: none"> • H.264 video using Wi-Fi • H.264 video using USB
Visual video streaming	<ul style="list-style-type: none"> • H.264 video using Wi-Fi • H.264 video using USB
Digital camera	
Digital camera	FOV adapts to the IR lens
Video lamp	Built-in LED light
Laser pointer	
Laser	Activated by dedicated button
Laser alignment	Position is automatic displayed on the IR image
Laser classification	Class 2
Laser type	Semiconductor AlGaInP diode laser, 1 mW, 635 nm (red)

Data communication interfaces	
Interfaces	USB-micro-AB, Bluetooth, Wi-Fi, HDMI
Bluetooth	Communication with headset
Wi-Fi	Peer to peer (ad hoc), infrastructure (network) or AP
SD Card	One card slot for removable SD memory cards
Audio	Microphone headset via Bluetooth for voice annotation of images
USB	
USB	USB Micro -AB: Data transfer to and from PC / Uncompressed colorized video
USB, standard	<ul style="list-style-type: none"> • USB 2.0 High Speed • USB Micro-AB connector
Video	
Video out	HDMI compatible
Video, connector type	HDMI type C
Radio	
Wi-Fi	<ul style="list-style-type: none"> • Standard: 802.11 b/g/n • Frequency range: 2412–2462 MHz • Max output power: 15 dBm
Bluetooth	Frequency range: 2402–2480 MHz Supports 2.1, 4.0 and 4.0BLE
Antenna	Internal
Power system	
Battery	Li Ion
Battery type	Rechargeable Li Ion battery
Battery operating time	> 2.5 hours at 25°C (+68°F) and typical use
Charging system	In camera (AC adapter or 12 V from a vehicle) or 2-bay charger
Charging time	2.5 h to 90 % capacity, charging status indicated by LED's
Charging temperature	0°C to +45°C (+32°F to +113°F)
External power operation	AC adapter 90–260 VAC, 50/60 Hz or 12 V from a vehicle (cable with standard plug, optional)
Power management	Automatic power-off functionality, user-configurable between 5 min, 20 min, or no automatic shutdown
Environmental data	
Storage temperature range	–40°C to +70°C (–40°F to +158°F)
Humidity (operating and storage)	IEC 60068-2-30/24 h 95% relative humidity +25°C to +40°C (+77°F to +104°F) / 2 cycles
EMC	<ul style="list-style-type: none"> • ETSI EN 301 489-1 (radio) • ETSI EN 301 489-17 • EN 61000-6-2 (Immunity) • EN 61000-6-3 (Emission) • FCC 47 CFR Part 15 Class B (Emission) • ICES-003
Radio spectrum	<ul style="list-style-type: none"> • ETSI EN 300 328 • FCC Part 15.247 • RSS-247 issue 1

Environmental data	
Encapsulation	IP 54 (IEC 60529)
Shock	25 g (IEC 60068-2-29)
Vibration	2 g (IEC 60068-2-6)
Safety	EN/UL/CSA/PSE 60950-1
Physical data	
Weight	2.0 kg (4.3 lb.)
Tripod mounting	UNC ¼"-20
Housing material	Magnesium
Shipping information	
List of contents	<ul style="list-style-type: none"> • Infrared camera with lens • Battery (2 ea.) • Battery charger • Bluetooth headset • Calibration certificate • FLIR Tools+ license card • User documentation CD-ROM • Printed documentation • HDMI-HDMI cable • Hard transport case • Large eyecap • Lens cap • Memory card • Neck strap • Power supply, incl. multi-plugs • USB cable, Std A to Micro-B
EAN-13	7332558010402
UPC-12	845188011055
Country of origin	Sweden

24.13 FLIR T1050sc 12°

P/N: 72501-0401

Rev.: 28063

General description	
<p>The FLIR T1050sc is designed for the expert requiring the highest performance and the latest technology available. The camera combines excellent ergonomics and feature-rich flexibility with superior image quality of 1024 × 768 pixel IR resolution. High accuracy and sensitivity together with radiometric recording and streaming options make the T1050sc well suited for advanced research and development.</p>	
<p>Benefits:</p> <ul style="list-style-type: none"> • Tailor made for research and development: The T1050sc has high accuracy and high sensitivity to accurately measure the smallest temperature differences. With real-time radiometric recording in the camera, it is possible to capture fast events on the camera's SD card for further analysis by the supplied analysis software. • Flexible and feature rich: A wide variety of measuring and analysis functions makes the camera flexible for your every need. Two programmable buttons provide easy access to favorite functions. • Highest performance with the latest technology: The T1050sc camera is equipped with the innovative 'Multi Spectral Dynamic Imaging (MSX)' feature, which produces an image richer in detail than ever before. Continuous auto-focus makes the T1050sc a fully automatic IR camera. 	
Imaging and optical data	
IR resolution	1024 × 768 pixels
Thermal sensitivity/NETD	<20 mK @ +30°C (+86°F)
Field of view (FOV)	12° × 9°
Minimum focus distance	0.8 m (2.63 ft.)
Field of view (FOV) / Minimum focus distance	12° × 9° / 0.8 m (2.63 ft.)
Focal length	83.4 mm (3.28 in.)
Spatial resolution (IFOV)	0.20 mrad
Lens identification	Automatic
F-number	1.2
Image frequency	30 Hz
Focus	Continuous, one shot or manual
Digital zoom	1–8× continuous
Zoom	1–8× continuous, digital zoom
Digital image enhancement	Adaptive digital noise reduction
Detector data	
Detector type	Focal Plane Array (FPA), uncooled microbolometer
Spectral range	7.5–14 μm
Detector pitch	17 μm
Image presentation	
Display	Built-in touch screen, 4.3 in. wide screen LCD, 800 × 480 pixels
Display type	Capacitive touch screen
Auto orientation	Automatic landscape or portrait
Viewfinder	Built-in 800 × 480 pixels
Automatic image adjustment	Continuous, histogram based
Automatic image adjustment, type	Standard or histogram based from image content
Manual image adjustment	Linear based; Possible to adjust level/span/max/min

Image presentation modes	
Image modes	Thermal, Thermal MSX, Picture in Picture, Digital Camera
Infrared image	Full color IR image
Visual image	Full color visual image
Multi Spectral Dynamic Imaging (MSX)	Thermal image with enhanced detail presentation
Picture in Picture	Resizable and movable IR area on visual image
Measurement analysis	
Spotmeter	10
Area	5+5 areas (boxes and circles) with max./min./average
Profile	1 line profile with max/min temp
Automatic hot/cold detection	Auto hot or cold spotmeter markers within area and profile
Measurement presets	No measurements, Center spot, Hot spot, Cold spot, User preset 1, User preset 2
User presets	The user can select and combine measurements from any number of spots/boxes/circles/profiles/delta
Difference temperature	Delta temperature between measurement functions or reference temperature
Reference temperature	Manually set using difference temperature
Atmospheric transmission correction	Automatic, based on inputs for distance, atmospheric temperature and relative humidity
Optics transmission correction	Automatic, based on signals from internal sensors
Emissivity correction	Variable from 0.01 to 1.0 or selected from materials list
Emissivity table	Emissivity table of predefined materials
Reflected apparent temperature correction	Automatic, based on input of reflected temperature
External optics/windows correction	Automatic, based on inputs of window transmission and temperature
Measurement corrections	Emissivity, reflected temperature, relative humidity, atmospheric temperature, object distance, external IR window compensation
Colors (palettes)	Iron, Rainbow, Rainbow HC, White hot, Black hot, Artic, Lava
Alarm	
Color Alarm (isotherm)	Above/below/interval
Measurement function alarm	Audible/visual alarms (above/below) on any selected measurement function
Set-up	
Set-up commands	Define user presets, Save options, Programmable button, Reset options, Set up camera, Wi-Fi, GPS & compass, Bluetooth, Language, Time & units, Camera information
Service functions	
Camera software update	Use PC software FLIR Tools

Storage of images	
Image storage	Standard JPEG, including digital photo and measurement data, on memory card
Storage media	Removable memory SD card (class 10)
Image storage mode	<ul style="list-style-type: none"> • Simultaneous storage of thermal and digital photo in same JPEG. • Optional to store digital photo as separate JPEG.
Time lapse	15 seconds to 24 hours
File formats	<ul style="list-style-type: none"> • Standard JPEG, measurement data included • CSQ, measurement data included
File formats, visual	Standard JPEG, automatically associated with corresponding thermal image
Image annotations	
Voice	60 seconds (via Bluetooth) stored with the image
Text	Add table. Select between predefined templates
Image description	Add short note (stored in JPEG exif tag)
Sketch	<ul style="list-style-type: none"> • Draw on thermal/digital photo or add predefined stamps • Separate PC software with extensive report generation
Geographic Information System	
GPS	Location data automatically added to every image from built-in GPS
Compass	Camera direction automatically added to every image
Video recording in camera	
Radiometric IR-video recording	Real-time radiometric recording (RTRR) to memory card
Non-radiometric IR-video recording	H.264 to memory card
Visual video recording	H.264 to memory card
Video streaming	
Radiometric IR-video streaming	<ul style="list-style-type: none"> • Full dynamic to PC using high speed interface • Real-time radiometric streaming (RTRS) via USB
Non-radiometric IR-video streaming	<ul style="list-style-type: none"> • H.264 video using Wi-Fi • H.264 video using USB
Visual video streaming	<ul style="list-style-type: none"> • H.264 video using Wi-Fi • H.264 video using USB
Digital camera	
Digital camera	FOV adapts to the IR lens
Video lamp	Built-in LED light
Laser pointer	
Laser	Activated by dedicated button
Laser alignment	Position is automatic displayed on the IR image

Laser pointer	
Laser classification	Class 2
Laser type	Semiconductor AlGaInP diode laser, 1 mW, 635 nm (red)
Data communication interfaces	
Interfaces	USB-micro-AB, Bluetooth, Wi-Fi, HDMI
Bluetooth	Communication with headset
Wi-Fi	Peer to peer (ad-hoc), infrastructure (network) or AP
SD Card	One card slot for removable SD memory cards
Audio	Microphone headset via Bluetooth for voice annotation of images
USB	
USB	USB Micro -AB: Data transfer to and from PC / Uncompressed colorized video
USB, standard	<ul style="list-style-type: none"> • USB 2.0 High Speed • USB Micro-AB connector
Video	
Video out	HDMI compatible
Video, connector type	HDMI type C
Radio	
Wi-Fi	<ul style="list-style-type: none"> • Standard: 802.11 b/g/n • Frequency range: 2412–2462 MHz • Max output power: 15 dBm
Bluetooth	Frequency range: 2402–2480 MHz Supports 2.1, 4.0 and 4.0BLE
Antenna	Internal
Power system	
Battery	Li Ion
Battery type	Rechargeable Li Ion battery
Battery operating time	> 2.5 hours at 25°C (+68°F) and typical use
Charging system	In camera (AC adapter or 12 V from a vehicle) or 2-bay charger
Charging time	2.5 h to 90 % capacity, charging status indicated by LED's
Charging temperature	0°C to +45°C (+32°F to +113°F)
External power operation	AC adapter 90–260 VAC, 50/60 Hz or 12 V from a vehicle (cable with standard plug, optional)
Power management	Automatic power-off functionality, user-configurable between 5 min, 20 min, or no automatic shutdown
Environmental data	
Storage temperature range	–40°C to +70°C (–40°F to +158°F)
Humidity (operating and storage)	IEC 60068-2-30/24 h 95% relative humidity +25°C to +40°C (+77°F to +104°F) / 2 cycles

Environmental data	
EMC	<ul style="list-style-type: none"> • ETSI EN 301 489-1 (radio) • ETSI EN 301 489-17 • EN 61000-6-2 (Immunity) • EN 61000-6-3 (Emission) • FCC 47 CFR Part 15 Class B (Emission) • ICES-003
Radio spectrum	<ul style="list-style-type: none"> • ETSI EN 300 328 • FCC Part 15.247 • RSS-247 issue 1
Encapsulation	IP 54 (IEC 60529)
Shock	25 g (IEC 60068-2-29)
Vibration	2 g (IEC 60068-2-6)
Safety	EN/UL/CSA/PSE 60950-1
Physical data	
Weight	2.1 kg (4.6 lb.)
Tripod mounting	UNC ¼"-20
Housing material	Magnesium
Shipping information	
List of contents	<ul style="list-style-type: none"> • Infrared camera with lens • Battery (2 ea.) • Battery charger • Bluetooth headset • Calibration certificate • FLIR ResearchIR Max 4 • FLIR Tools+ license card • User documentation CD-ROM • Printed documentation • HDMI-HDMI cable • Hard transport case • Large eyecap • Lens cap • Memory card • Neck strap • Power supply, incl. multi-plugs • USB cable, Std A to Micro-B • High-speed interface
EAN-13	7332558010419
UPC-12	845188011062
Country of origin	Sweden

24.14 FLIR T1050sc 28°

P/N: 72501-0402

Rev.: 28063

General description	
<p>The FLIR T1050sc is designed for the expert requiring the highest performance and the latest technology available. The camera combines excellent ergonomics and feature-rich flexibility with superior image quality of 1024 × 768 pixel IR resolution. High accuracy and sensitivity together with radiometric recording and streaming options make the T1050sc well suited for advanced research and development.</p>	
<p>Benefits:</p> <ul style="list-style-type: none"> • Tailor made for research and development: The T1050sc has high accuracy and high sensitivity to accurately measure the smallest temperature differences. With real-time radiometric recording in the camera, it is possible to capture fast events on the camera's SD card for further analysis by the supplied analysis software. • Flexible and feature rich: A wide variety of measuring and analysis functions makes the camera flexible for your every need. Two programmable buttons provide easy access to favorite functions. • Highest performance with the latest technology: The T1050sc camera is equipped with the innovative 'Multi Spectral Dynamic Imaging (MSX)' feature, which produces an image richer in detail than ever before. Continuous auto-focus makes the T1050sc a fully automatic IR camera. 	
Imaging and optical data	
IR resolution	1024 × 768 pixels
Thermal sensitivity/NETD	<20 mK @ +30°C (+86°F)
Field of view (FOV)	28° × 21°
Minimum focus distance	0.4 m (1.32 ft.)
Field of view (FOV) / Minimum focus distance	28° × 21° / 0.4 m (1.32 ft.)
Focal length	36 mm (1.42 in.)
Spatial resolution (IFOV)	0.47mrad
Lens identification	Automatic
F-number	1.15
Image frequency	30 Hz
Focus	Continuous, one shot or manual
Digital zoom	1–8× continuous
Zoom	1–8× continuous, digital zoom
Digital image enhancement	Adaptive digital noise reduction
Detector data	
Detector type	Focal Plane Array (FPA), uncooled microbolometer
Spectral range	7.5–14 μm
Detector pitch	17 μm
Image presentation	
Display	Built-in touch screen, 4.3 in. wide screen LCD, 800 × 480 pixels
Display type	Capacitive touch screen
Auto orientation	Automatic landscape or portrait
Viewfinder	Built-in 800 × 480 pixels
Automatic image adjustment	Continuous, histogram based
Automatic image adjustment, type	Standard or histogram based from image content
Manual image adjustment	Linear based; Possible to adjust level/span/max/min

Image presentation modes	
Image modes	Thermal, Thermal MSX, Picture in Picture, Digital Camera
Infrared image	Full color IR image
Visual image	Full color visual image
Multi Spectral Dynamic Imaging (MSX)	Thermal image with enhanced detail presentation
Picture in Picture	Resizable and movable IR area on visual image
Measurement analysis	
Spotmeter	10
Area	5+5 areas (boxes and circles) with max./min./average
Profile	1 line profile with max/min temp
Automatic hot/cold detection	Auto hot or cold spotmeter markers within area and profile
Measurement presets	No measurements, Center spot, Hot spot, Cold spot, User preset 1, User preset 2
User presets	The user can select and combine measurements from any number of spots/boxes/circles/profiles/delta
Difference temperature	Delta temperature between measurement functions or reference temperature
Reference temperature	Manually set using difference temperature
Atmospheric transmission correction	Automatic, based on inputs for distance, atmospheric temperature and relative humidity
Optics transmission correction	Automatic, based on signals from internal sensors
Emissivity correction	Variable from 0.01 to 1.0 or selected from materials list
Emissivity table	Emissivity table of predefined materials
Reflected apparent temperature correction	Automatic, based on input of reflected temperature
External optics/windows correction	Automatic, based on inputs of window transmission and temperature
Measurement corrections	Emissivity, reflected temperature, relative humidity, atmospheric temperature, object distance, external IR window compensation
Colors (palettes)	Iron, Rainbow, Rainbow HC, White hot, Black hot, Artic, Lava
Alarm	
Color Alarm (isotherm)	Above/below/interval
Measurement function alarm	Audible/visual alarms (above/below) on any selected measurement function
Set-up	
Set-up commands	Define user presets, Save options, Programmable button, Reset options, Set up camera, Wi-Fi, GPS & compass, Bluetooth, Language, Time & units, Camera information
Service functions	
Camera software update	Use PC software FLIR Tools

Storage of images	
Image storage	Standard JPEG, including digital photo and measurement data, on memory card
Storage media	Removable memory SD card (class 10)
Image storage mode	<ul style="list-style-type: none"> • Simultaneous storage of thermal and digital photo in same JPEG. • Optional to store digital photo as separate JPEG.
Time lapse	15 seconds to 24 hours
File formats	<ul style="list-style-type: none"> • Standard JPEG, measurement data included • CSQ, measurement data included
File formats, visual	Standard JPEG, automatically associated with corresponding thermal image
Image annotations	
Voice	60 seconds (via Bluetooth) stored with the image
Text	Add table. Select between predefined templates
Image description	Add short note (stored in JPEG exif tag)
Sketch	<ul style="list-style-type: none"> • Draw on thermal/digital photo or add predefined stamps • Separate PC software with extensive report generation
Geographic Information System	
GPS	Location data automatically added to every image from built-in GPS
Compass	Camera direction automatically added to every image
Video recording in camera	
Radiometric IR-video recording	Real-time radiometric recording (RTRR) to memory card
Non-radiometric IR-video recording	H.264 to memory card
Visual video recording	H.264 to memory card
Video streaming	
Radiometric IR-video streaming	<ul style="list-style-type: none"> • Full dynamic to PC using high speed interface • Real-time radiometric streaming (RTRS) via USB
Non-radiometric IR-video streaming	<ul style="list-style-type: none"> • H.264 video using Wi-Fi • H.264 video using USB
Visual video streaming	<ul style="list-style-type: none"> • H.264 video using Wi-Fi • H.264 video using USB
Digital camera	
Digital camera	FOV adapts to the IR lens
Video lamp	Built-in LED light
Laser pointer	
Laser	Activated by dedicated button
Laser alignment	Position is automatic displayed on the IR image

Laser pointer	
Laser classification	Class 2
Laser type	Semiconductor AlGaInP diode laser, 1 mW, 635 nm (red)
Data communication interfaces	
Interfaces	USB-micro-AB, Bluetooth, Wi-Fi, HDMI
Bluetooth	Communication with headset
Wi-Fi	Peer to peer (ad-hoc), infrastructure (network) or AP
SD Card	One card slot for removable SD memory cards
Audio	Microphone headset via Bluetooth for voice annotation of images
USB	
USB	USB Micro -AB: Data transfer to and from PC / Uncompressed colorized video
USB, standard	<ul style="list-style-type: none"> • USB 2.0 High Speed • USB Micro-AB connector
Video	
Video out	HDMI compatible
Video, connector type	HDMI type C
Radio	
Wi-Fi	<ul style="list-style-type: none"> • Standard: 802.11 b/g/n • Frequency range: 2412–2462 MHz • Max output power: 15 dBm
Bluetooth	Frequency range: 2402–2480 MHz Supports 2.1, 4.0 and 4.0BLE
Antenna	Internal
Power system	
Battery	Li Ion
Battery type	Rechargeable Li Ion battery
Battery operating time	> 2.5 hours at 25°C (+68°F) and typical use
Charging system	In camera (AC adapter or 12 V from a vehicle) or 2-bay charger
Charging time	2.5 h to 90 % capacity, charging status indicated by LED's
Charging temperature	0°C to +45°C (+32°F to +113°F)
External power operation	AC adapter 90–260 VAC, 50/60 Hz or 12 V from a vehicle (cable with standard plug, optional)
Power management	Automatic power-off functionality, user-configurable between 5 min, 20 min, or no automatic shutdown
Environmental data	
Storage temperature range	–40°C to +70°C (–40°F to +158°F)
Humidity (operating and storage)	IEC 60068-2-30/24 h 95% relative humidity +25°C to +40°C (+77°F to +104°F) / 2 cycles

Environmental data	
EMC	<ul style="list-style-type: none"> • ETSI EN 301 489-1 (radio) • ETSI EN 301 489-17 • EN 61000-6-2 (Immunity) • EN 61000-6-3 (Emission) • FCC 47 CFR Part 15 Class B (Emission) • ICES-003
Radio spectrum	<ul style="list-style-type: none"> • ETSI EN 300 328 • FCC Part 15.247 • RSS-247 issue 1
Encapsulation	IP 54 (IEC 60529)
Shock	25 g (IEC 60068-2-29)
Vibration	2 g (IEC 60068-2-6)
Safety	EN/UL/CSA/PSE 60950-1
Physical data	
Weight	1.9 kg (4.3 lb.)
Tripod mounting	UNC ¼"-20
Housing material	Magnesium
Shipping information	
List of contents	<ul style="list-style-type: none"> • Infrared camera with lens • Battery (2 ea.) • Battery charger • Bluetooth headset • Calibration certificate • FLIR ResearchIR Max 4 • FLIR Tools+ license card • User documentation CD-ROM • Printed documentation • HDMI-HDMI cable • Hard transport case • Large eyecap • Lens cap • Memory card • Neck strap • Power supply, incl. multi-plugs • USB cable, Std A to Micro-B • High-speed interface
EAN-13	7332558010426
UPC-12	845188011079
Country of origin	Sweden

24.15 FLIR T1050sc 45°

P/N: 72501-0403

Rev.: 28063

General description	
<p>The FLIR T1050sc is designed for the expert requiring the highest performance and the latest technology available. The camera combines excellent ergonomics and feature-rich flexibility with superior image quality of 1024 × 768 pixel IR resolution. High accuracy and sensitivity together with radiometric recording and streaming options make the T1050sc well suited for advanced research and development.</p>	
<p>Benefits:</p> <ul style="list-style-type: none"> • Tailor made for research and development: The T1050sc has high accuracy and high sensitivity to accurately measure the smallest temperature differences. With real-time radiometric recording in the camera, it is possible to capture fast events on the camera's SD card for further analysis by the supplied analysis software. • Flexible and feature rich: A wide variety of measuring and analysis functions makes the camera flexible for your every need. Two programmable buttons provide easy access to favorite functions. • Highest performance with the latest technology: The T1050sc camera is equipped with the innovative 'Multi Spectral Dynamic Imaging (MSX)' feature, which produces an image richer in detail than ever before. Continuous auto-focus makes the T1050sc a fully automatic IR camera. 	
Imaging and optical data	
IR resolution	1024 × 768 pixels
Thermal sensitivity/NETD	<20 mK @ +30°C (+86°F)
Field of view (FOV)	45° × 34°
Minimum focus distance	0.2 m (0.66 ft.)
Field of view (FOV) / Minimum focus distance	45° × 34° / 0.2 m (0.66 ft.)
Focal length	21.2 mm (0.83 in.)
Spatial resolution (IFOV)	0.80 mrad
Lens identification	Automatic
F-number	1.1
Image frequency	30 Hz
Focus	Continuous, one shot or manual
Digital zoom	1–8× continuous
Zoom	1–8× continuous, digital zoom
Digital image enhancement	Adaptive digital noise reduction
Detector data	
Detector type	Focal Plane Array (FPA), uncooled microbolometer
Spectral range	7.5–14 μm
Detector pitch	17 μm
Image presentation	
Display	Built-in touch screen, 4.3 in. wide screen LCD, 800 × 480 pixels
Display type	Capacitive touch screen
Auto orientation	Automatic landscape or portrait
Viewfinder	Built-in 800 × 480 pixels
Automatic image adjustment	Continuous, histogram based
Automatic image adjustment, type	Standard or histogram based from image content
Manual image adjustment	Linear based; Possible to adjust level/span/max/min

Image presentation modes	
Image modes	Thermal, Thermal MSX, Picture in Picture, Digital Camera
Infrared image	Full color IR image
Visual image	Full color visual image
Multi Spectral Dynamic Imaging (MSX)	Thermal image with enhanced detail presentation
Picture in Picture	Resizable and movable IR area on visual image
Measurement analysis	
Spotmeter	10
Area	5+5 areas (boxes and circles) with max./min./average
Profile	1 line profile with max/min temp
Automatic hot/cold detection	Auto hot or cold spotmeter markers within area and profile
Measurement presets	No measurements, Center spot, Hot spot, Cold spot, User preset 1, User preset 2
User presets	The user can select and combine measurements from any number of spots/boxes/circles/profiles/delta
Difference temperature	Delta temperature between measurement functions or reference temperature
Reference temperature	Manually set using difference temperature
Atmospheric transmission correction	Automatic, based on inputs for distance, atmospheric temperature and relative humidity
Optics transmission correction	Automatic, based on signals from internal sensors
Emissivity correction	Variable from 0.01 to 1.0 or selected from materials list
Emissivity table	Emissivity table of predefined materials
Reflected apparent temperature correction	Automatic, based on input of reflected temperature
External optics/windows correction	Automatic, based on inputs of window transmission and temperature
Measurement corrections	Emissivity, reflected temperature, relative humidity, atmospheric temperature, object distance, external IR window compensation
Colors (palettes)	Iron, Rainbow, Rainbow HC, White hot, Black hot, Artic, Lava
Alarm	
Color Alarm (isotherm)	Above/below/interval
Measurement function alarm	Audible/visual alarms (above/below) on any selected measurement function
Set-up	
Set-up commands	Define user presets, Save options, Programmable button, Reset options, Set up camera, Wi-Fi, GPS & compass, Bluetooth, Language, Time & units, Camera information
Service functions	
Camera software update	Use PC software FLIR Tools

Storage of images	
Image storage	Standard JPEG, including digital photo and measurement data, on memory card
Storage media	Removable memory SD card (class 10)
Image storage mode	<ul style="list-style-type: none"> • Simultaneous storage of thermal and digital photo in same JPEG. • Optional to store digital photo as separate JPEG.
Time lapse	15 seconds to 24 hours
File formats	<ul style="list-style-type: none"> • Standard JPEG, measurement data included • CSQ, measurement data included
File formats, visual	Standard JPEG, automatically associated with corresponding thermal image
Image annotations	
Voice	60 seconds (via Bluetooth) stored with the image
Text	Add table. Select between predefined templates
Image description	Add short note (stored in JPEG exif tag)
Sketch	<ul style="list-style-type: none"> • Draw on thermal/digital photo or add predefined stamps • Separate PC software with extensive report generation
Geographic Information System	
GPS	Location data automatically added to every image from built-in GPS
Compass	Camera direction automatically added to every image
Video recording in camera	
Radiometric IR-video recording	Real-time radiometric recording (RTRR) to memory card
Non-radiometric IR-video recording	H.264 to memory card
Visual video recording	H.264 to memory card
Video streaming	
Radiometric IR-video streaming	<ul style="list-style-type: none"> • Full dynamic to PC using high speed interface • Real-time radiometric streaming (RTRS) via USB
Non-radiometric IR-video streaming	<ul style="list-style-type: none"> • H.264 video using Wi-Fi • H.264 video using USB
Visual video streaming	<ul style="list-style-type: none"> • H.264 video using Wi-Fi • H.264 video using USB
Digital camera	
Digital camera	FOV adapts to the IR lens
Video lamp	Built-in LED light
Laser pointer	
Laser	Activated by dedicated button
Laser alignment	Position is automatic displayed on the IR image

Laser pointer	
Laser classification	Class 2
Laser type	Semiconductor AlGaInP diode laser, 1 mW, 635 nm (red)
Data communication interfaces	
Interfaces	USB-micro-AB, Bluetooth, Wi-Fi, HDMI
Bluetooth	Communication with headset
Wi-Fi	Peer to peer (ad-hoc), infrastructure (network) or AP
SD Card	One card slot for removable SD memory cards
Audio	Microphone headset via Bluetooth for voice annotation of images
USB	
USB	USB Micro -AB: Data transfer to and from PC / Uncompressed colorized video
USB, standard	<ul style="list-style-type: none"> • USB 2.0 High Speed • USB Micro-AB connector
Video	
Video out	HDMI compatible
Video, connector type	HDMI type C
Radio	
Wi-Fi	<ul style="list-style-type: none"> • Standard: 802.11 b/g/n • Frequency range: 2412–2462 MHz • Max output power: 15 dBm
Bluetooth	Frequency range: 2402–2480 MHz Supports 2.1, 4.0 and 4.0BLE
Antenna	Internal
Power system	
Battery	Li Ion
Battery type	Rechargeable Li Ion battery
Battery operating time	> 2.5 hours at 25°C (+68°F) and typical use
Charging system	In camera (AC adapter or 12 V from a vehicle) or 2-bay charger
Charging time	2.5 h to 90 % capacity, charging status indicated by LED's
Charging temperature	0°C to +45°C (+32°F to +113°F)
External power operation	AC adapter 90–260 VAC, 50/60 Hz or 12 V from a vehicle (cable with standard plug, optional)
Power management	Automatic power-off functionality, user-configurable between 5 min, 20 min, or no automatic shutdown
Environmental data	
Storage temperature range	–40°C to +70°C (–40°F to +158°F)
Humidity (operating and storage)	IEC 60068-2-30/24 h 95% relative humidity +25°C to +40°C (+77°F to +104°F) / 2 cycles

Environmental data	
EMC	<ul style="list-style-type: none"> • ETSI EN 301 489-1 (radio) • ETSI EN 301 489-17 • EN 61000-6-2 (Immunity) • EN 61000-6-3 (Emission) • FCC 47 CFR Part 15 Class B (Emission) • ICES-003
Radio spectrum	<ul style="list-style-type: none"> • ETSI EN 300 328 • FCC Part 15.247 • RSS-247 issue 1
Encapsulation	IP 54 (IEC 60529)
Shock	25 g (IEC 60068-2-29)
Vibration	2 g (IEC 60068-2-6)
Safety	EN/UL/CSA/PSE 60950-1
Physical data	
Weight	2.0 kg (4.3 lb.)
Tripod mounting	UNC ¼"-20
Housing material	Magnesium
Shipping information	
List of contents	<ul style="list-style-type: none"> • Infrared camera with lens • Battery (2 ea.) • Battery charger • Bluetooth headset • Calibration certificate • FLIR ResearchIR Max 4 • FLIR Tools+ license card • User documentation CD-ROM • Printed documentation • HDMI-HDMI cable • Hard transport case • Large eyecap • Lens cap • Memory card • Neck strap • Power supply, incl. multi-plugs • USB cable, Std A to Micro-B • High-speed interface
EAN-13	7332558010433
UPC-12	845188011086
Country of origin	Sweden

Camera housing

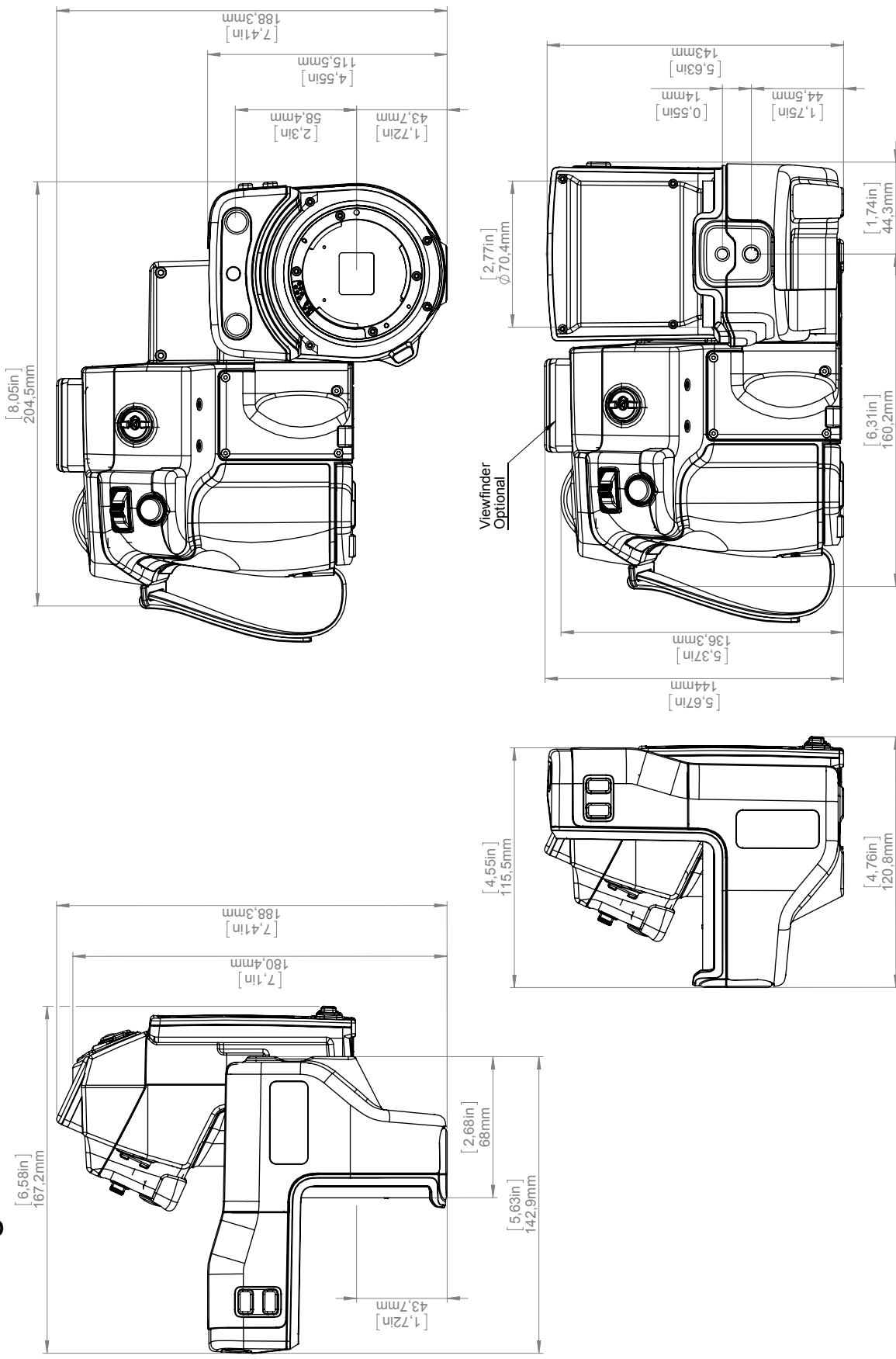

©2012, FLIR Systems, Inc. All rights reserved worldwide. No part of this drawing may be reproduced, stored in a retrieval system, or transmitted in any form, or by any means, electronic, mechanical, photocopying, recording, or otherwise, without written permission from FLIR Systems, Inc. Specifications subject to change without further notice. Dimensional data is based on nominal values. Products may be subject to regional market considerations. License procedures may apply. Product may be subject to US Export Regulations. Please refer to exportquestions@flir.com with any questions. Diversion contrary to US law is prohibited.

Modified 2015-05-19	Check AKZE	Drawn by R&D Thermography	FLIR
Denomination Basic dimensions FLIR T10xx			Sheet 1(6)
Size A3			Scale 1:2
Drawing No. T128849			Size B

IR-LENS 12° (f=83,4mm)

[8,63in]
219,2mm

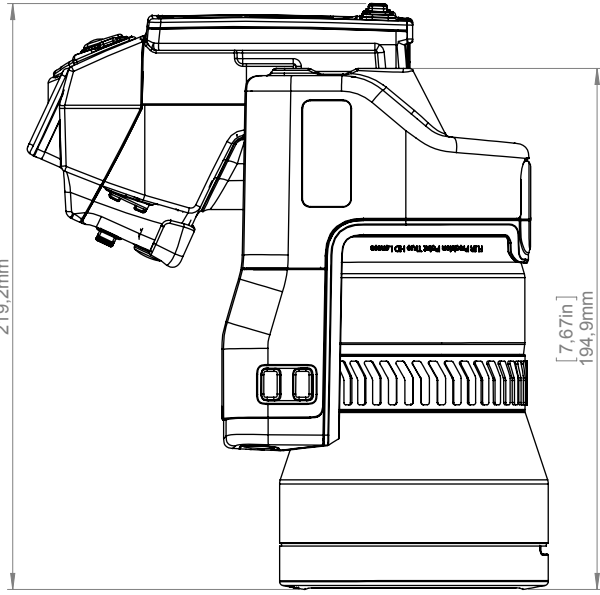

[7,67in]
194,9mm

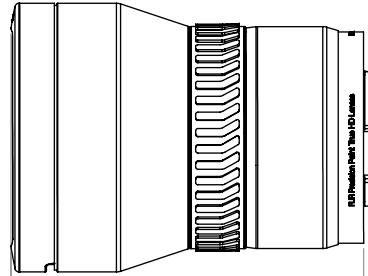

[5,19in]
131,9mm

[5,28in]
134,1mm

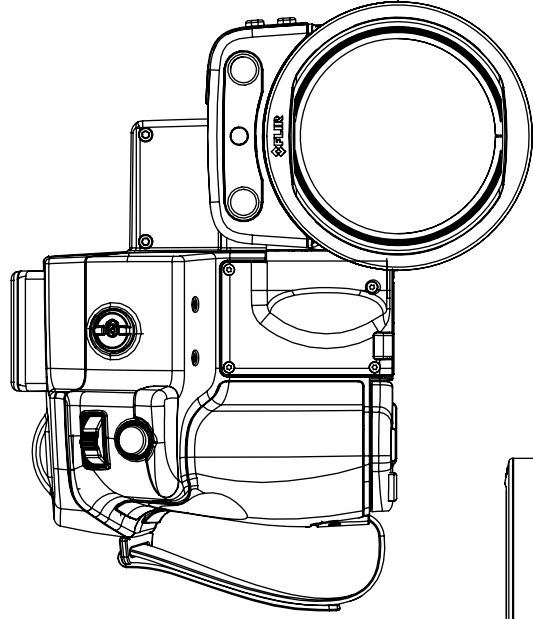

[3,96in]
100,5mm

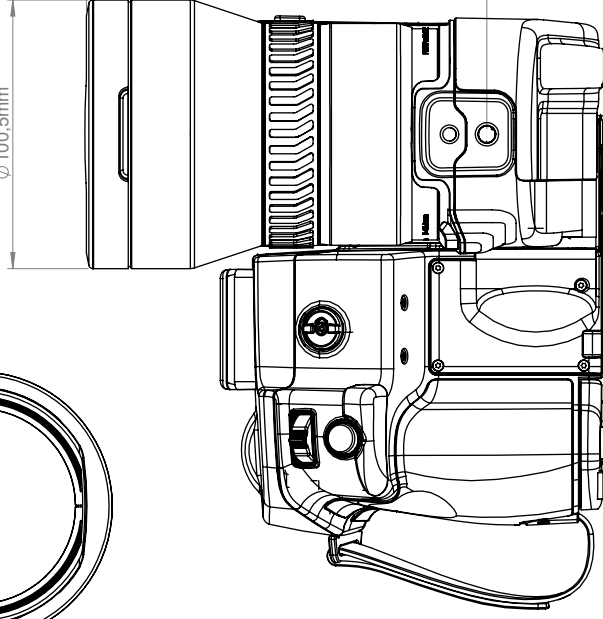
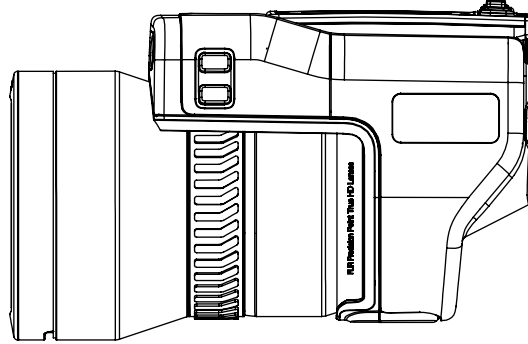

[5,9in]
149,8mm

10

9

8

7

6

5

4

3

2

1

A

B

C

D

E

F

G

H

B

6

5

4

3

2

1

FLIR		Size A3	Drawn by R&D Thermography
Modified 2015-05-19	Check AKZE	Scale 1:2	Sheet 2(6)
Denomination Basic dimensions FLIR T10xx		Drawing No. T128849	Size B

© 2012, FLIR Systems, Inc. All rights reserved worldwide. No part of this drawing may be reproduced, stored in a retrieval system, or transmitted in any form, or by any means, electronic, mechanical, photocopying, recording, or otherwise, without written permission from FLIR Systems, Inc. Specifications subject to change without further notice. Dimensional data is based on nominal values. Products may be subject to regional market considerations. License procedures may apply. Product may be subject to US Export Regulations. Please refer to exportquestions@flir.com with any questions. Diversion contrary to US law is prohibited.

IR-LENS 28° (f=36mm)

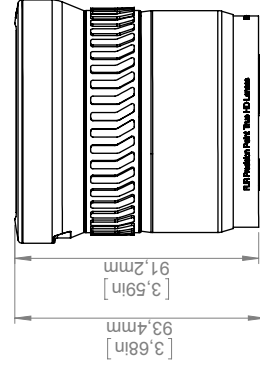
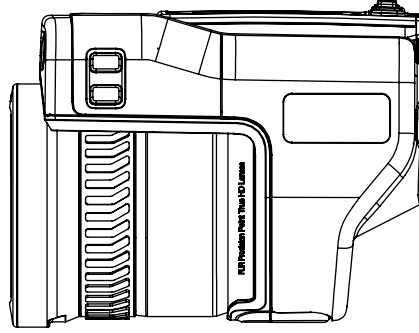
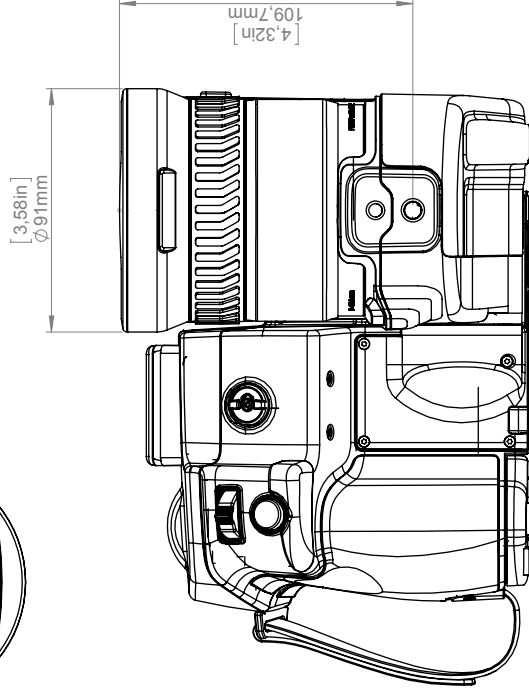
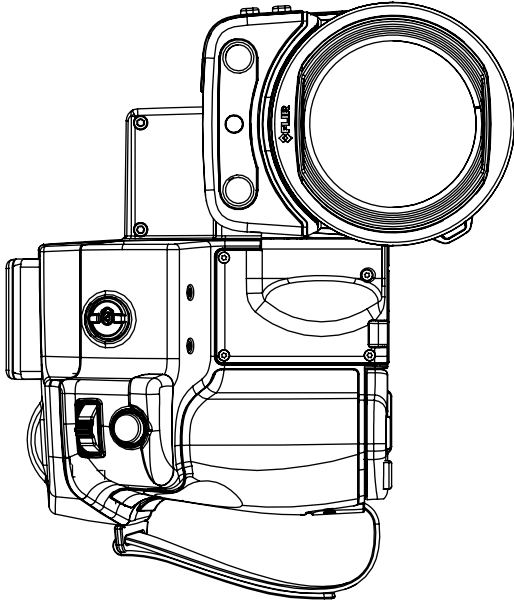
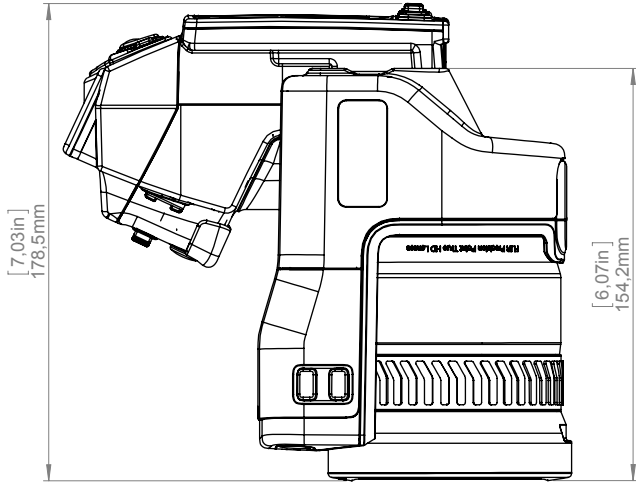

Modified
2015-05-19
Denomination

Check
AKZE

Drawn by
R&D Thermography

Size
A3

Scale
1:2

Drawing No.
T128849

Basic dimensions FLIR T10xx



Sheet
3(6)

Size
B

IR-LENS 45° (f=21,2mm)

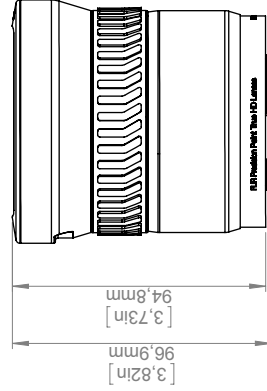
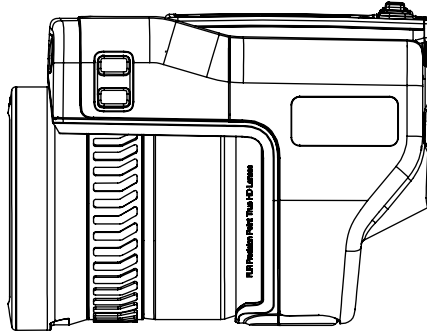
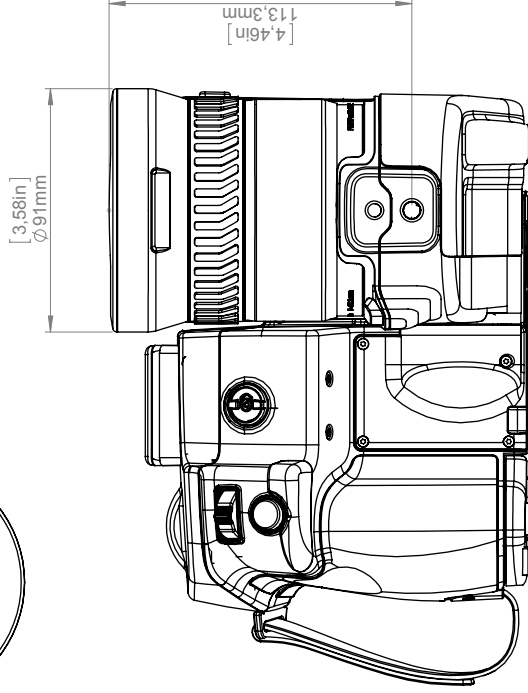
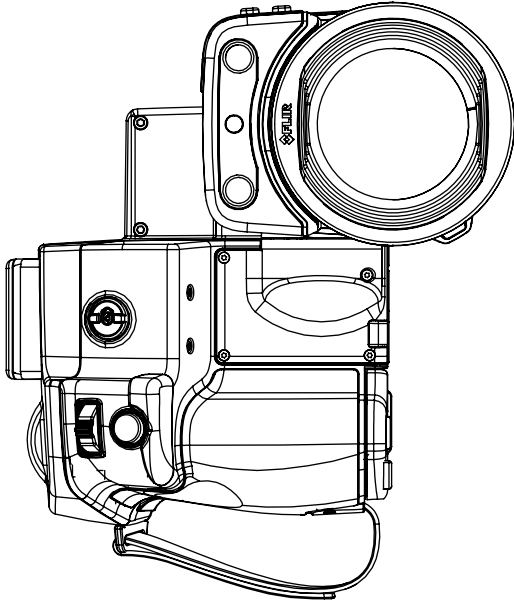
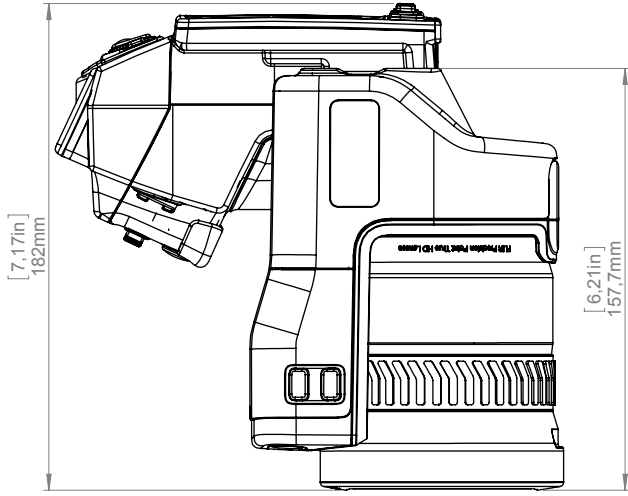

Modified
2015-05-19
Denomination

Check
AKZE

Drawn by
R&D Thermography



Size
A3

Scale
1:2

Sheet
4(6)

Drawing No.
T128849

Basic dimensions FLIR T10xx

IR-LENS CLOSE-UP (3X)

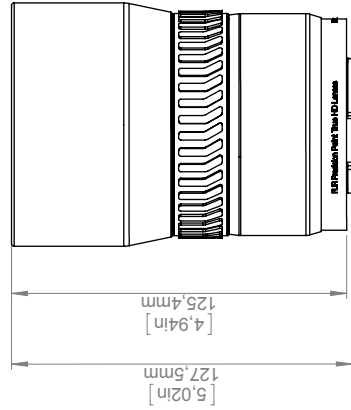
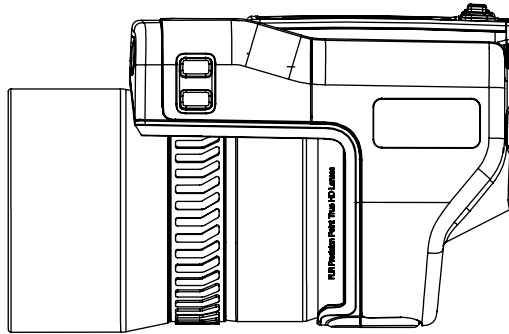
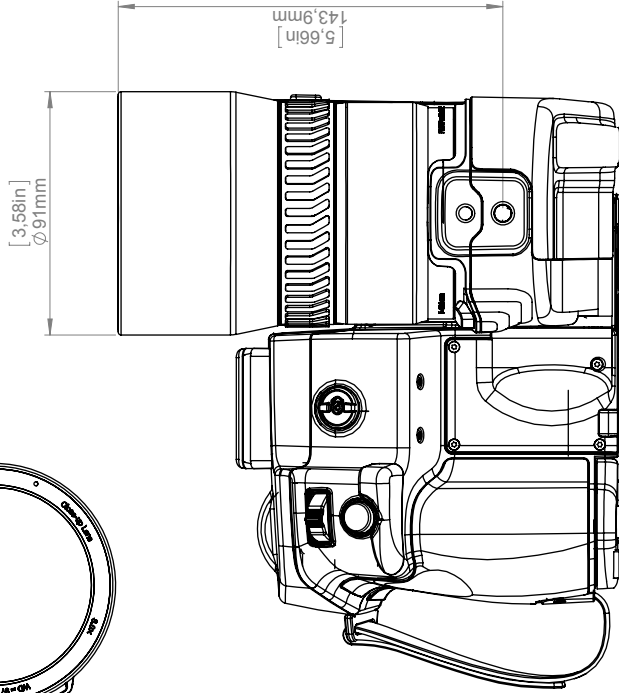
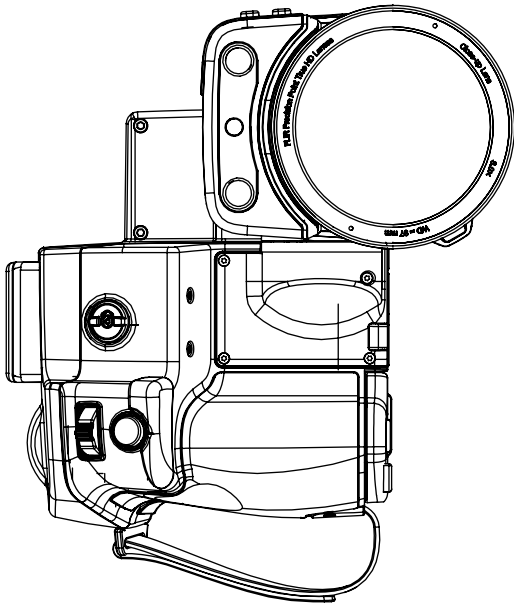
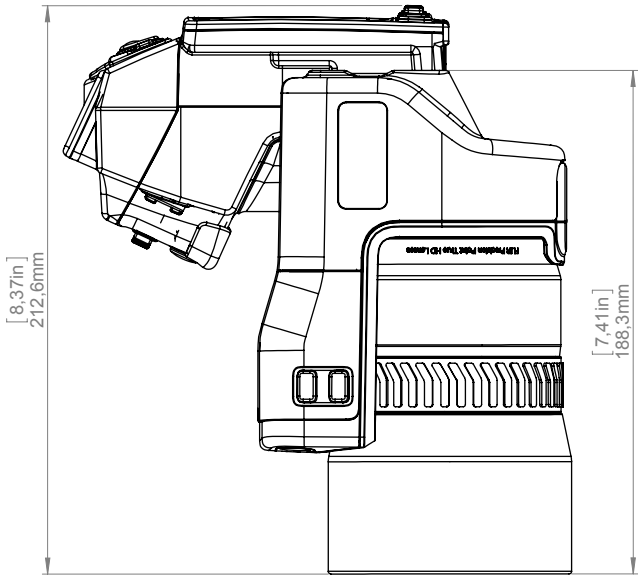

FLIR		Sheet 5(6)	Size B
Modified 2015-05-19	Check AKZE	Drawn by R&D Thermography	Drawing No. T128849
Denomination Basic dimensions FLIR T10xx		Size A3	Scale 1:2

BATTERY / CHARGER

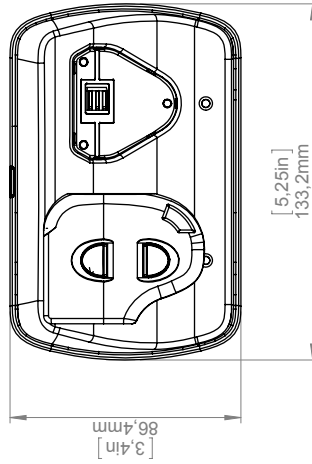
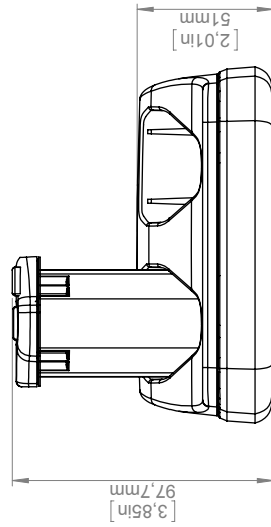
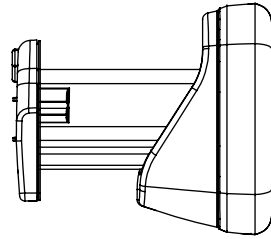
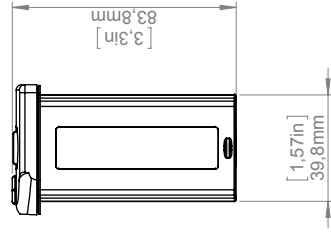
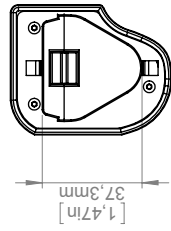

		Size: A3 Scale: 1:2 Drawing No: T128849
Modified: 2015-05-19 Denomination:	Check: AKZE	Drawn by: R&D Thermography
Basic dimensions FLIR T10xx		

© 2012, FLIR Systems, Inc. All rights reserved worldwide. No part of this drawing may be reproduced, stored in a retrieval system, or transmitted in any form, or by any means, electronic, mechanical, photocopying, recording, or otherwise, without written permission from FLIR Systems, Inc. Specifications subject to change without further notice. Dimensional data is based on nominal values. Products may be subject to regional market considerations. License procedures may apply. Product may be subject to US Export Regulations. Please refer to exportquestions@flir.com with any questions. Diversion contrary to US law is prohibited.

26.1 Camera housing, cables, and other items

26.1.1 Liquids

Use one of these liquids:

- Warm water
- A weak detergent solution

26.1.2 Equipment

A soft cloth

26.1.3 Procedure

Follow this procedure:

1. Soak the cloth in the liquid.
2. Twist the cloth to remove excess liquid.
3. Clean the part with the cloth.



CAUTION

Do not apply solvents or similar liquids to the camera, the cables, or other items. This can cause damage.

26.2 Infrared lens

26.2.1 Liquids

Use one of these liquids:

- A commercial lens cleaning liquid with more than 30% isopropyl alcohol.
- 96% ethyl alcohol (C₂H₅OH).

26.2.2 Equipment

Cotton wool

26.2.3 Procedure

Follow this procedure:

1. Soak the cotton wool in the liquid.
2. Twist the cotton wool to remove excess liquid.
3. Clean the lens one time only and discard the cotton wool.



WARNING

Make sure that you read all applicable MSDS (Material Safety Data Sheets) and warning labels on containers before you use a liquid: the liquids can be dangerous.



CAUTION

- Be careful when you clean the infrared lens. The lens has a delicate anti-reflective coating.
- Do not clean the infrared lens too vigorously. This can damage the anti-reflective coating.

26.3 Infrared detector

26.3.1 General

Even small amounts of dust on the infrared detector can result in major blemishes in the image. To remove any dust from the detector, follow the procedure below.

**NOTE**

- This section only applies to cameras where removing the lens exposes the infrared detector.
- In some cases the dust cannot be removed by following this procedure: the infrared detector must be cleaned mechanically. This mechanical cleaning must be carried out by an authorized service partner.

**CAUTION**

In Step 2 below, do not use pressurized air from pneumatic air circuits in a workshop, etc., as this air usually contains oil mist to lubricate pneumatic tools.

26.3.2 Procedure

Follow this procedure:

1. Remove the lens from the camera.
2. Use pressurized air from a compressed air canister to blow off the dust.

27.1 Moisture & water damage

27.1.1 General

It is often possible to detect moisture and water damage in a house by using an infrared camera. This is partly because the damaged area has a different heat conduction property and partly because it has a different thermal capacity to store heat than the surrounding material.



NOTE

Many factors can come into play as to how moisture or water damage will appear in an infrared image. For example, heating and cooling of these parts takes place at different rates depending on the material and the time of day. For this reason, it is important that other methods are used as well to check for moisture or water damage.

27.1.2 Figure

The image below shows extensive water damage on an external wall where the water has penetrated the outer facing because of an incorrectly installed window ledge.

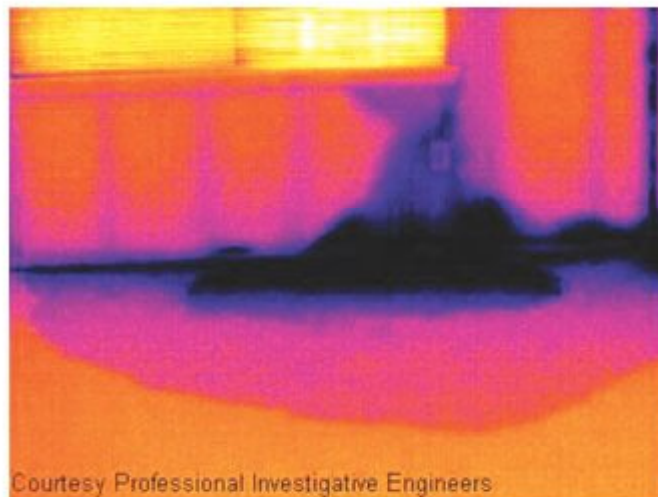

27.2 Faulty contact in socket

27.2.1 General

Depending on the type of connection a socket has, an improperly connected wire can result in local temperature increase. This temperature increase is caused by the reduced contact area between the connection point of the incoming wire and the socket, and can result in an electrical fire.



NOTE

A socket's construction may differ dramatically from one manufacturer to another. For this reason, different faults in a socket can lead to the same typical appearance in an infrared image.

Local temperature increase can also result from improper contact between wire and socket, or from difference in load.

27.2.2 Figure

The image below shows a connection of a cable to a socket where improper contact in the connection has resulted in local temperature increase.

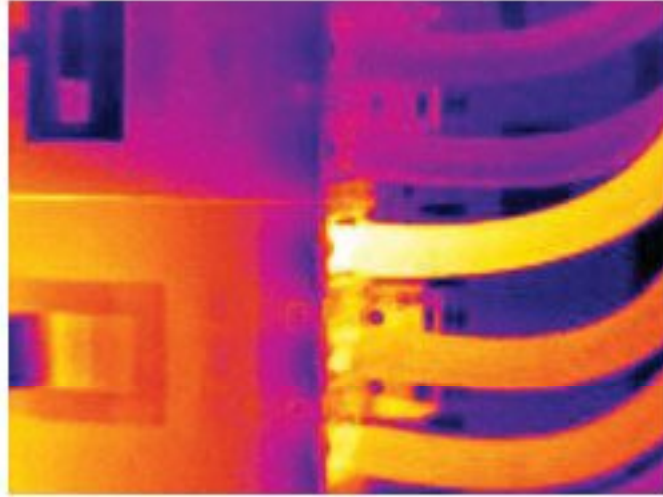

27.3 Oxidized socket

27.3.1 General

Depending on the type of socket and the environment in which the socket is installed, oxides may occur on the socket's contact surfaces. These oxides can lead to locally increased resistance when the socket is loaded, which can be seen in an infrared image as local temperature increase.



NOTE

A socket's construction may differ dramatically from one manufacturer to another. For this reason, different faults in a socket can lead to the same typical appearance in an infrared image.

Local temperature increase can also result from improper contact between a wire and socket, or from difference in load.

27.3.2 Figure

The image below shows a series of fuses where one fuse has a raised temperature on the contact surfaces against the fuse holder. Because of the fuse holder's blank metal, the temperature increase is not visible there, while it is visible on the fuse's ceramic material.

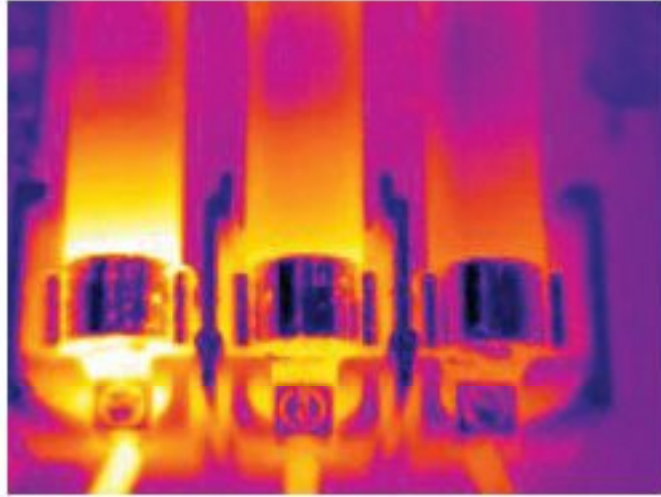

27.4 Insulation deficiencies

27.4.1 General

Insulation deficiencies may result from insulation losing volume over the course of time and thereby not entirely filling the cavity in a frame wall.

An infrared camera allows you to see these insulation deficiencies because they either have a different heat conduction property than sections with correctly installed insulation, and/or show the area where air is penetrating the frame of the building.



NOTE

When you are inspecting a building, the temperature difference between the inside and outside should be at least 10°C (18°F). Studs, water pipes, concrete columns, and similar components may resemble an insulation deficiency in an infrared image. Minor differences may also occur naturally.

27.4.2 Figure

In the image below, insulation in the roof framing is lacking. Due to the absence of insulation, air has forced its way into the roof structure, which thus takes on a different characteristic appearance in the infrared image.

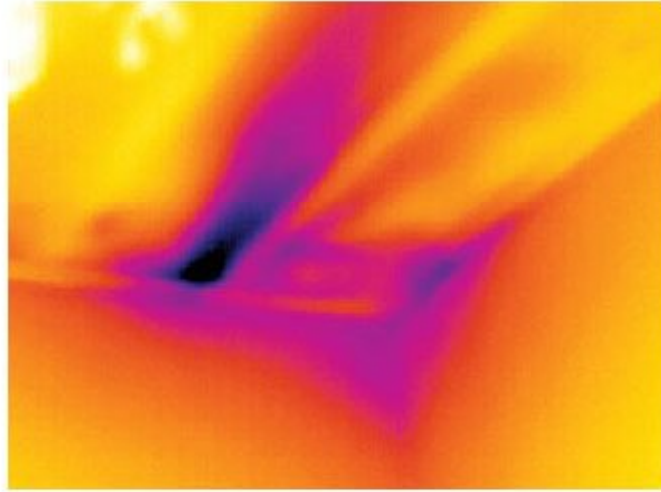

27.5 Draft

27.5.1 General

Draft can be found under baseboards, around door and window casings, and above ceiling trim. This type of draft is often possible to see with an infrared camera, as a cooler airstream cools down the surrounding surface.



NOTE

When you are investigating draft in a house, there should be sub-atmospheric pressure in the house. Close all doors, windows, and ventilation ducts, and allow the kitchen fan to run for a while before you take the infrared images.

An infrared image of draft often shows a typical stream pattern. You can see this stream pattern clearly in the picture below.

Also keep in mind that drafts can be concealed by heat from floor heating circuits.

27.5.2 Figure

The image below shows a ceiling hatch where faulty installation has resulted in a strong draft.

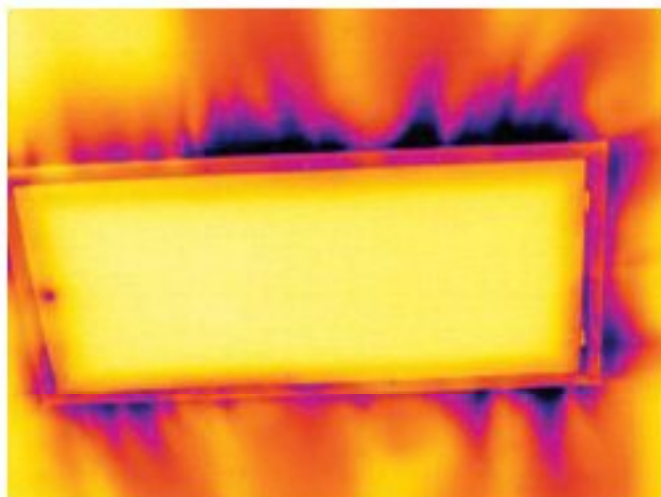

FLIR Systems was established in 1978 to pioneer the development of high-performance infrared imaging systems, and is the world leader in the design, manufacture, and marketing of thermal imaging systems for a wide variety of commercial, industrial, and government applications. Today, FLIR Systems embraces five major companies with outstanding achievements in infrared technology since 1958—the Swedish AGEMA Infrared Systems (formerly AGA Infrared Systems), the three United States companies Indigo Systems, FSI, and Inframetrics, and the French company Cedic.

Since 2007, FLIR Systems has acquired several companies with world-leading expertise in sensor technologies:

- Exttech Instruments (2007)
- Ifara Tecnologías (2008)
- Salvador Imaging (2009)
- OmniTech Partners (2009)
- Directed Perception (2009)
- Raymarine (2010)
- ICx Technologies (2010)
- TackTick Marine Digital Instruments (2011)
- Aerius Photonics (2011)
- Lorex Technology (2012)
- Traficon (2012)
- MARSS (2013)
- DigitalOptics micro-optics business (2013)

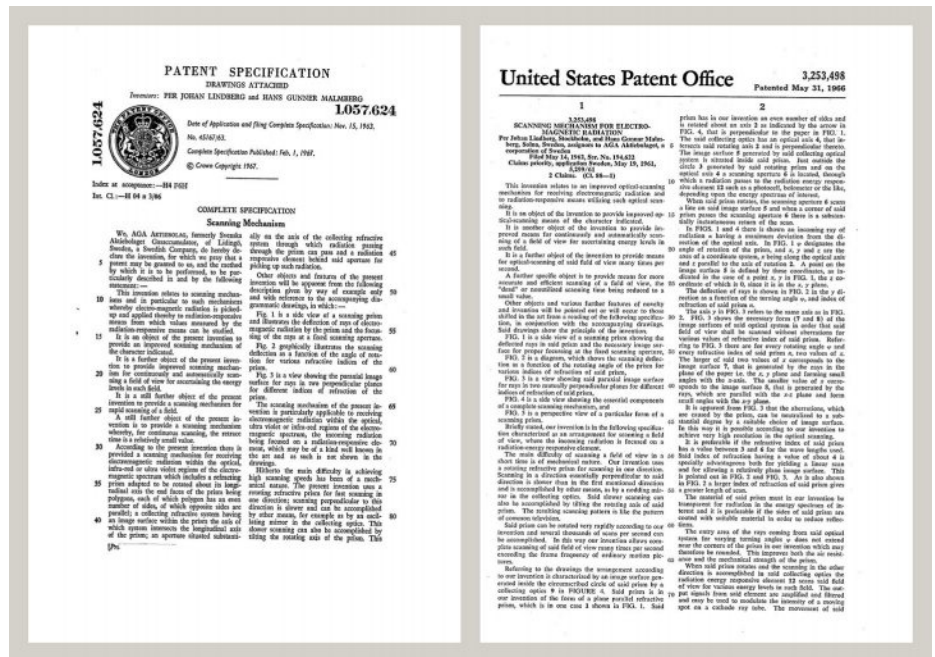

Figure 28.1 Patent documents from the early 1960s

The company has sold more than 350,000 infrared cameras worldwide for applications such as predictive maintenance, R & D, non-destructive testing, process control and automation, and machine vision, among many others.

FLIR Systems has three manufacturing plants in the United States (Portland, OR, Boston, MA, Santa Barbara, CA) and one in Sweden (Stockholm). Since 2007 there is also a manufacturing plant in Tallinn, Estonia. Direct sales offices in Belgium, Brazil, China, France, Germany, Great Britain, Hong Kong, Italy, Japan, Korea, Sweden, and the USA—together with a worldwide network of agents and distributors—support our international customer base.

FLIR Systems is at the forefront of innovation in the infrared camera industry. We anticipate market demand by constantly improving our existing cameras and developing new ones. The company has set milestones in product design and development such as the introduction of the first battery-operated portable camera for industrial inspections, and the first uncooled infrared camera, to mention just two innovations.



Figure 28.2 1969: Thermovision Model 661. The camera weighed approximately 25 kg (55 lb.), the oscilloscope 20 kg (44 lb.), and the tripod 15 kg (33 lb.). The operator also needed a 220 VAC generator set, and a 10 L (2.6 US gallon) jar with liquid nitrogen. To the left of the oscilloscope the Polaroid attachment (6 kg/13 lb.) can be seen.



Figure 28.3 2015: FLIR One, an accessory to iPhone and Android mobile phones. Weight: 90 g (3.2 oz.).

FLIR Systems manufactures all vital mechanical and electronic components of the camera systems itself. From detector design and manufacturing, to lenses and system electronics, to final testing and calibration, all production steps are carried out and supervised by our own engineers. The in-depth expertise of these infrared specialists ensures the accuracy and reliability of all vital components that are assembled into your infrared camera.

28.1 More than just an infrared camera

At FLIR Systems we recognize that our job is to go beyond just producing the best infrared camera systems. We are committed to enabling all users of our infrared camera systems to work more productively by providing them with the most powerful camera–software combination. Especially tailored software for predictive maintenance, R & D, and process monitoring is developed in-house. Most software is available in a wide variety of languages.

We support all our infrared cameras with a wide variety of accessories to adapt your equipment to the most demanding infrared applications.

28.2 Sharing our knowledge

Although our cameras are designed to be very user-friendly, there is a lot more to thermography than just knowing how to handle a camera. Therefore, FLIR Systems has founded the Infrared Training Center (ITC), a separate business unit, that provides certified training courses. Attending one of the ITC courses will give you a truly hands-on learning experience.

The staff of the ITC are also there to provide you with any application support you may need in putting infrared theory into practice.

28.3 Supporting our customers

FLIR Systems operates a worldwide service network to keep your camera running at all times. If you discover a problem with your camera, local service centers have all the

equipment and expertise to solve it within the shortest possible time. Therefore, there is no need to send your camera to the other side of the world or to talk to someone who does not speak your language.

28.4 A few images from our facilities

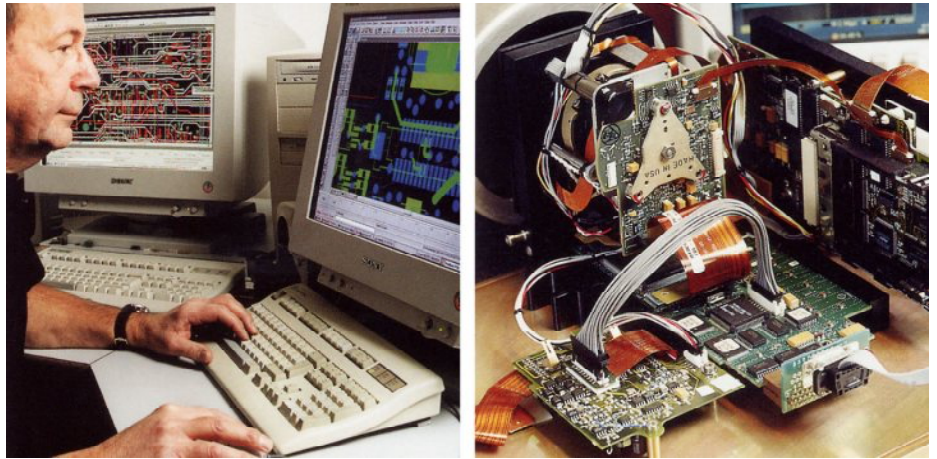

Figure 28.4 LEFT: Development of system electronics; RIGHT: Testing of an FPA detector



Figure 28.5 LEFT: Diamond turning machine; RIGHT: Lens polishing

absorption (absorption factor)	The amount of radiation absorbed by an object relative to the received radiation. A number between 0 and 1.
atmosphere	The gases between the object being measured and the camera, normally air.
autoadjust	A function making a camera perform an internal image correction.
autopalette	The IR image is shown with an uneven spread of colors, displaying cold objects as well as hot ones at the same time.
blackbody	Totally non-reflective object. All its radiation is due to its own temperature.
blackbody radiator	An IR radiating equipment with blackbody properties used to calibrate IR cameras.
calculated atmospheric transmission	A transmission value computed from the temperature, the relative humidity of air and the distance to the object.
cavity radiator	A bottle shaped radiator with an absorbing inside, viewed through the bottleneck.
color temperature	The temperature for which the color of a blackbody matches a specific color.
conduction	The process that makes heat diffuse into a material.
continuous adjust	A function that adjusts the image. The function works all the time, continuously adjusting brightness and contrast according to the image content.
convection	Convection is a heat transfer mode where a fluid is brought into motion, either by gravity or another force, thereby transferring heat from one place to another.
dual isotherm	An isotherm with two color bands, instead of one.
emissivity (emissivity factor)	The amount of radiation coming from an object, compared to that of a blackbody. A number between 0 and 1.
emittance	Amount of energy emitted from an object per unit of time and area (W/m^2)
environment	Objects and gases that emit radiation towards the object being measured.
estimated atmospheric transmission	A transmission value, supplied by a user, replacing a calculated one
external optics	Extra lenses, filters, heat shields etc. that can be put between the camera and the object being measured.
filter	A material transparent only to some of the infrared wavelengths.
FOV	Field of view: The horizontal angle that can be viewed through an IR lens.
FPA	Focal plane array: A type of IR detector.
graybody	An object that emits a fixed fraction of the amount of energy of a blackbody for each wavelength.
IFOV	Instantaneous field of view: A measure of the geometrical resolution of an IR camera.

image correction (internal or external)	A way of compensating for sensitivity differences in various parts of live images and also of stabilizing the camera.
infrared	Non-visible radiation, having a wavelength from about 2–13 μm .
IR	infrared
isotherm	A function highlighting those parts of an image that fall above, below or between one or more temperature intervals.
isothermal cavity	A bottle-shaped radiator with a uniform temperature viewed through the bottleneck.
Laser LocatIR	An electrically powered light source on the camera that emits laser radiation in a thin, concentrated beam to point at certain parts of the object in front of the camera.
laser pointer	An electrically powered light source on the camera that emits laser radiation in a thin, concentrated beam to point at certain parts of the object in front of the camera.
level	The center value of the temperature scale, usually expressed as a signal value.
manual adjust	A way to adjust the image by manually changing certain parameters.
NETD	Noise equivalent temperature difference. A measure of the image noise level of an IR camera.
noise	Undesired small disturbance in the infrared image
object parameters	A set of values describing the circumstances under which the measurement of an object was made, and the object itself (such as emissivity, reflected apparent temperature, distance etc.)
object signal	A non-calibrated value related to the amount of radiation received by the camera from the object.
palette	The set of colors used to display an IR image.
pixel	Stands for <i>picture element</i> . One single spot in an image.
radiance	Amount of energy emitted from an object per unit of time, area and angle ($\text{W}/\text{m}^2/\text{sr}$)
radiant power	Amount of energy emitted from an object per unit of time (W)
radiation	The process by which electromagnetic energy, is emitted by an object or a gas.
radiator	A piece of IR radiating equipment.
range	The current overall temperature measurement limitation of an IR camera. Cameras can have several ranges. Expressed as two blackbody temperatures that limit the current calibration.
reference temperature	A temperature which the ordinary measured values can be compared with.
reflection	The amount of radiation reflected by an object relative to the received radiation. A number between 0 and 1.
relative humidity	Relative humidity represents the ratio between the current water vapour mass in the air and the maximum it may contain in saturation conditions.
saturation color	The areas that contain temperatures outside the present level/span settings are colored with the saturation colors. The saturation colors contain an 'overflow' color and an 'underflow' color. There is also a third red saturation color that marks everything saturated by the detector indicating that the range should probably be changed.

span	The interval of the temperature scale, usually expressed as a signal value.
spectral (radiant) emittance	Amount of energy emitted from an object per unit of time, area and wavelength ($W/m^2/\mu m$)
temperature difference, or difference of temperature.	A value which is the result of a subtraction between two temperature values.
temperature range	The current overall temperature measurement limitation of an IR camera. Cameras can have several ranges. Expressed as two blackbody temperatures that limit the current calibration.
temperature scale	The way in which an IR image currently is displayed. Expressed as two temperature values limiting the colors.
thermogram	infrared image
transmission (or transmittance) factor	Gases and materials can be more or less transparent. Transmission is the amount of IR radiation passing through them. A number between 0 and 1.
transparent isotherm	An isotherm showing a linear spread of colors, instead of covering the highlighted parts of the image.
visual	Refers to the video mode of a IR camera, as opposed to the normal, thermographic mode. When a camera is in video mode it captures ordinary video images, while thermographic images are captured when the camera is in IR mode.

30.1 Introduction

An infrared camera measures and images the emitted infrared radiation from an object. The fact that radiation is a function of object surface temperature makes it possible for the camera to calculate and display this temperature.

However, the radiation measured by the camera does not only depend on the temperature of the object but is also a function of the emissivity. Radiation also originates from the surroundings and is reflected in the object. The radiation from the object and the reflected radiation will also be influenced by the absorption of the atmosphere.

To measure temperature accurately, it is therefore necessary to compensate for the effects of a number of different radiation sources. This is done on-line automatically by the camera. The following object parameters must, however, be supplied for the camera:

- The emissivity of the object
- The reflected apparent temperature
- The distance between the object and the camera
- The relative humidity
- Temperature of the atmosphere

30.2 Emissivity

The most important object parameter to set correctly is the emissivity which, in short, is a measure of how much radiation is emitted from the object, compared to that from a perfect blackbody of the same temperature.

Normally, object materials and surface treatments exhibit emissivity ranging from approximately 0.1 to 0.95. A highly polished (mirror) surface falls below 0.1, while an oxidized or painted surface has a higher emissivity. Oil-based paint, regardless of color in the visible spectrum, has an emissivity over 0.9 in the infrared. Human skin exhibits an emissivity 0.97 to 0.98.

Non-oxidized metals represent an extreme case of perfect opacity and high reflexivity, which does not vary greatly with wavelength. Consequently, the emissivity of metals is low – only increasing with temperature. For non-metals, emissivity tends to be high, and decreases with temperature.

30.2.1 Finding the emissivity of a sample

30.2.1.1 Step 1: Determining reflected apparent temperature

Use one of the following two methods to determine reflected apparent temperature:

30.2.1.1.1 Method 1: Direct method

Follow this procedure:

1. Look for possible reflection sources, considering that the incident angle = reflection angle ($a = b$).

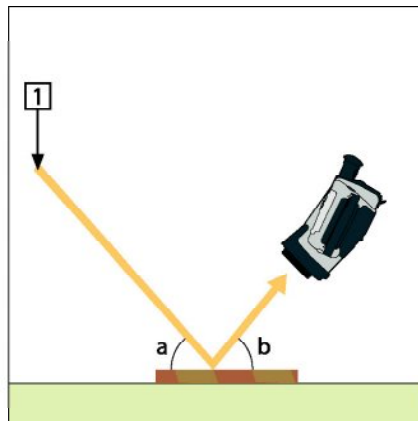

Figure 30.1 1 = Reflection source

2. If the reflection source is a spot source, modify the source by obstructing it using a piece of cardboard.

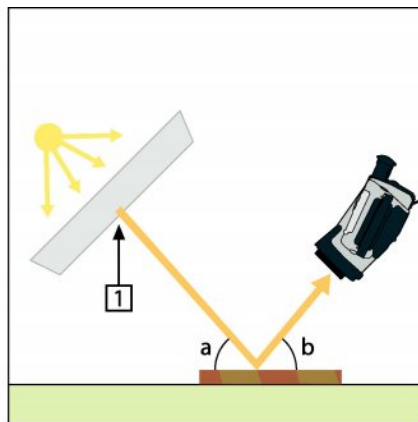

Figure 30.2 1 = Reflection source

3. Measure the radiation intensity (= apparent temperature) from the reflecting source using the following settings:

- Emissivity: 1.0
- D_{obj} : 0

You can measure the radiation intensity using one of the following two methods:

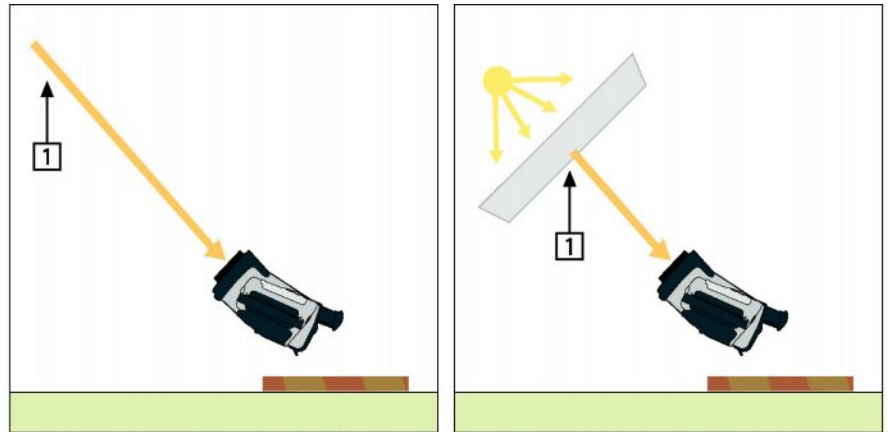

Figure 30.3 1 = Reflection source



NOTE

Using a thermocouple to measure reflected apparent temperature is not recommended for two important reasons:

- A thermocouple does not measure radiation intensity
- A thermocouple requires a very good thermal contact to the surface, usually by gluing and covering the sensor by a thermal isolator.

30.2.1.1.2 Method 2: Reflector method

Follow this procedure:

1. Crumble up a large piece of aluminum foil.
2. Uncrumble the aluminum foil and attach it to a piece of cardboard of the same size.
3. Put the piece of cardboard in front of the object you want to measure. Make sure that the side with aluminum foil points to the camera.
4. Set the emissivity to 1.0.
5. Measure the apparent temperature of the aluminum foil and write it down.

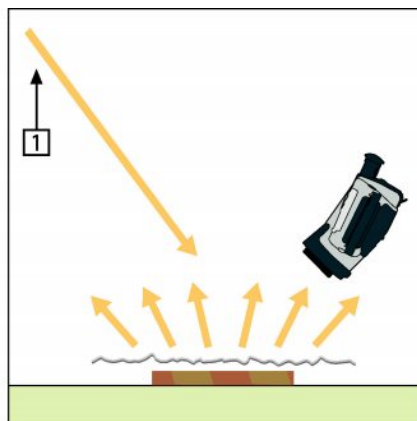

Figure 30.4 Measuring the apparent temperature of the aluminum foil.

30.2.1.2 Step 2: Determining the emissivity

Follow this procedure:

1. Select a place to put the sample.
2. Determine and set reflected apparent temperature according to the previous procedure.
3. Put a piece of electrical tape with known high emissivity on the sample.
4. Heat the sample at least 20 K above room temperature. Heating must be reasonably even.
5. Focus and auto-adjust the camera, and freeze the image.
6. Adjust *Level* and *Span* for best image brightness and contrast.
7. Set emissivity to that of the tape (usually 0.97).
8. Measure the temperature of the tape using one of the following measurement functions:
 - *Isotherm* (helps you to determine both the temperature and how evenly you have heated the sample)
 - *Spot* (simpler)
 - *Box Avg* (good for surfaces with varying emissivity).
9. Write down the temperature.
10. Move your measurement function to the sample surface.
11. Change the emissivity setting until you read the same temperature as your previous measurement.
12. Write down the emissivity.



NOTE

- Avoid forced convection
- Look for a thermally stable surrounding that will not generate spot reflections
- Use high quality tape that you know is not transparent, and has a high emissivity you are certain of
- This method assumes that the temperature of your tape and the sample surface are the same. If they are not, your emissivity measurement will be wrong.

30.3 Reflected apparent temperature

This parameter is used to compensate for the radiation reflected in the object. If the emissivity is low and the object temperature relatively far from that of the reflected it will be important to set and compensate for the reflected apparent temperature correctly.

30.4 Distance

The distance is the distance between the object and the front lens of the camera. This parameter is used to compensate for the following two facts:

- That radiation from the target is absorbed by the atmosphere between the object and the camera.
- That radiation from the atmosphere itself is detected by the camera.

30.5 Relative humidity

The camera can also compensate for the fact that the transmittance is also dependent on the relative humidity of the atmosphere. To do this set the relative humidity to the correct value. For short distances and normal humidity the relative humidity can normally be left at a default value of 50%.

30.6 Other parameters

In addition, some cameras and analysis programs from FLIR Systems allow you to compensate for the following parameters:

- Atmospheric temperature – *i.e.* the temperature of the atmosphere between the camera and the target
- External optics temperature – *i.e.* the temperature of any external lenses or windows used in front of the camera

- External optics transmittance – *i.e.* the transmission of any external lenses or windows used in front of the camera

Before the year 1800, the existence of the infrared portion of the electromagnetic spectrum wasn't even suspected. The original significance of the infrared spectrum, or simply 'the infrared' as it is often called, as a form of heat radiation is perhaps less obvious today than it was at the time of its discovery by Herschel in 1800.



Figure 31.1 Sir William Herschel (1738–1822)

The discovery was made accidentally during the search for a new optical material. Sir William Herschel – Royal Astronomer to King George III of England, and already famous for his discovery of the planet Uranus – was searching for an optical filter material to reduce the brightness of the sun's image in telescopes during solar observations. While testing different samples of colored glass which gave similar reductions in brightness he was intrigued to find that some of the samples passed very little of the sun's heat, while others passed so much heat that he risked eye damage after only a few seconds' observation.

Herschel was soon convinced of the necessity of setting up a systematic experiment, with the objective of finding a single material that would give the desired reduction in brightness as well as the maximum reduction in heat. He began the experiment by actually repeating Newton's prism experiment, but looking for the heating effect rather than the visual distribution of intensity in the spectrum. He first blackened the bulb of a sensitive mercury-in-glass thermometer with ink, and with this as his radiation detector he proceeded to test the heating effect of the various colors of the spectrum formed on the top of a table by passing sunlight through a glass prism. Other thermometers, placed outside the sun's rays, served as controls.

As the blackened thermometer was moved slowly along the colors of the spectrum, the temperature readings showed a steady increase from the violet end to the red end. This was not entirely unexpected, since the Italian researcher, Landriani, in a similar experiment in 1777 had observed much the same effect. It was Herschel, however, who was the first to recognize that there must be a point where the heating effect reaches a maximum, and that measurements confined to the visible portion of the spectrum failed to locate this point.



Figure 31.2 Marsilio Landriani (1746–1815)

Moving the thermometer into the dark region beyond the red end of the spectrum, Herschel confirmed that the heating continued to increase. The maximum point, when he found it, lay well beyond the red end – in what is known today as the 'infrared wavelengths'.

When Herschel revealed his discovery, he referred to this new portion of the electromagnetic spectrum as the 'thermometrical spectrum'. The radiation itself he sometimes referred to as 'dark heat', or simply 'the invisible rays'. Ironically, and contrary to popular opinion, it wasn't Herschel who originated the term 'infrared'. The word only began to appear in print around 75 years later, and it is still unclear who should receive credit as the originator.

Herschel's use of glass in the prism of his original experiment led to some early controversies with his contemporaries about the actual existence of the infrared wavelengths. Different investigators, in attempting to confirm his work, used various types of glass indiscriminately, having different transparencies in the infrared. Through his later experiments, Herschel was aware of the limited transparency of glass to the newly-discovered thermal radiation, and he was forced to conclude that optics for the infrared would probably be doomed to the use of reflective elements exclusively (i.e. plane and curved mirrors). Fortunately, this proved to be true only until 1830, when the Italian investigator, Melloni, made his great discovery that naturally occurring rock salt (NaCl) – which was available in large enough natural crystals to be made into lenses and prisms – is remarkably transparent to the infrared. The result was that rock salt became the principal infrared optical material, and remained so for the next hundred years, until the art of synthetic crystal growing was mastered in the 1930's.



Figure 31.3 Macedonio Melloni (1798–1854)

Thermometers, as radiation detectors, remained unchallenged until 1829, the year Nobili invented the thermocouple. (Herschel's own thermometer could be read to 0.2 °C (0.036 °F), and later models were able to be read to 0.05 °C (0.09 °F)). Then a breakthrough occurred; Melloni connected a number of thermocouples in series to form the first thermopile. The new device was at least 40 times as sensitive as the best thermometer of the day for detecting heat radiation – capable of detecting the heat from a person standing three meters away.

The first so-called 'heat-picture' became possible in 1840, the result of work by Sir John Herschel, son of the discoverer of the infrared and a famous astronomer in his own right. Based upon the differential evaporation of a thin film of oil when exposed to a heat pattern focused upon it, the thermal image could be seen by reflected light where the interference effects of the oil film made the image visible to the eye. Sir John also managed to obtain a primitive record of the thermal image on paper, which he called a 'thermograph'.



Figure 31.4 Samuel P. Langley (1834–1906)

The improvement of infrared-detector sensitivity progressed slowly. Another major breakthrough, made by Langley in 1880, was the invention of the bolometer. This consisted of a thin blackened strip of platinum connected in one arm of a Wheatstone bridge circuit upon which the infrared radiation was focused and to which a sensitive galvanometer responded. This instrument is said to have been able to detect the heat from a cow at a distance of 400 meters.

An English scientist, Sir James Dewar, first introduced the use of liquefied gases as cooling agents (such as liquid nitrogen with a temperature of $-196\text{ }^{\circ}\text{C}$ ($-320.8\text{ }^{\circ}\text{F}$)) in low temperature research. In 1892 he invented a unique vacuum insulating container in which it is possible to store liquefied gases for entire days. The common 'thermos bottle', used for storing hot and cold drinks, is based upon his invention.

Between the years 1900 and 1920, the inventors of the world 'discovered' the infrared. Many patents were issued for devices to detect personnel, artillery, aircraft, ships – and even icebergs. The first operating systems, in the modern sense, began to be developed during the 1914–18 war, when both sides had research programs devoted to the military exploitation of the infrared. These programs included experimental systems for enemy intrusion/detection, remote temperature sensing, secure communications, and 'flying torpedo' guidance. An infrared search system tested during this period was able to detect an approaching airplane at a distance of 1.5 km (0.94 miles), or a person more than 300 meters (984 ft.) away.

The most sensitive systems up to this time were all based upon variations of the bolometer idea, but the period between the two wars saw the development of two revolutionary new infrared detectors: the image converter and the photon detector. At first, the image converter received the greatest attention by the military, because it enabled an observer for the first time in history to literally 'see in the dark'. However, the sensitivity of the image converter was limited to the near infrared wavelengths, and the most interesting military targets (i.e. enemy soldiers) had to be illuminated by infrared search beams. Since this involved the risk of giving away the observer's position to a similarly-equipped enemy observer, it is understandable that military interest in the image converter eventually faded.

The tactical military disadvantages of so-called 'active' (i.e. search beam-equipped) thermal imaging systems provided impetus following the 1939–45 war for extensive secret military infrared-research programs into the possibilities of developing 'passive' (no search beam) systems around the extremely sensitive photon detector. During this period, military secrecy regulations completely prevented disclosure of the status of infrared-imaging technology. This secrecy only began to be lifted in the middle of the 1950's, and from that time adequate thermal-imaging devices finally began to be available to civilian science and industry.

32.1 Introduction

The subjects of infrared radiation and the related technique of thermography are still new to many who will use an infrared camera. In this section the theory behind thermography will be given.

32.2 The electromagnetic spectrum

The electromagnetic spectrum is divided arbitrarily into a number of wavelength regions, called *bands*, distinguished by the methods used to produce and detect the radiation. There is no fundamental difference between radiation in the different bands of the electromagnetic spectrum. They are all governed by the same laws and the only differences are those due to differences in wavelength.

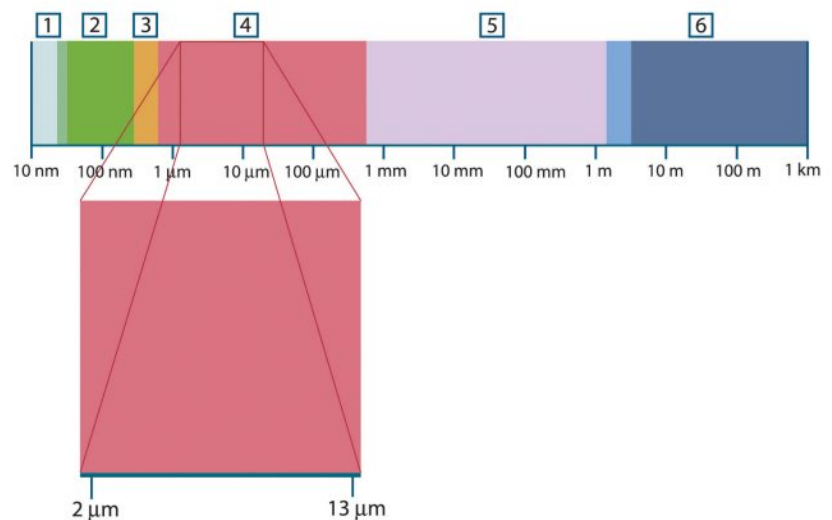

Figure 32.1 The electromagnetic spectrum. 1: X-ray; 2: UV; 3: Visible; 4: IR; 5: Microwaves; 6: Radiowaves.

Thermography makes use of the infrared spectral band. At the short-wavelength end the boundary lies at the limit of visual perception, in the deep red. At the long-wavelength end it merges with the microwave radio wavelengths, in the millimeter range.

The infrared band is often further subdivided into four smaller bands, the boundaries of which are also arbitrarily chosen. They include: the *near infrared* (0.75–3 μm), the *middle infrared* (3–6 μm), the *far infrared* (6–15 μm) and the *extreme infrared* (15–100 μm). Although the wavelengths are given in μm (micrometers), other units are often still used to measure wavelength in this spectral region, e.g. nanometer (nm) and Ångström (Å).

The relationships between the different wavelength measurements is:

$$10\,000 \text{ \AA} = 1\,000 \text{ nm} = 1 \mu = 1 \mu\text{m}$$

32.3 Blackbody radiation

A blackbody is defined as an object which absorbs all radiation that impinges on it at any wavelength. The apparent misnomer *black* relating to an object emitting radiation is explained by Kirchhoff's Law (after *Gustav Robert Kirchhoff*, 1824–1887), which states that a body capable of absorbing all radiation at any wavelength is equally capable in the emission of radiation.



Figure 32.2 Gustav Robert Kirchhoff (1824–1887)

The construction of a blackbody source is, in principle, very simple. The radiation characteristics of an aperture in an isotherm cavity made of an opaque absorbing material represents almost exactly the properties of a blackbody. A practical application of the principle to the construction of a perfect absorber of radiation consists of a box that is light tight except for an aperture in one of the sides. Any radiation which then enters the hole is scattered and absorbed by repeated reflections so only an infinitesimal fraction can possibly escape. The blackness which is obtained at the aperture is nearly equal to a blackbody and almost perfect for all wavelengths.

By providing such an isothermal cavity with a suitable heater it becomes what is termed a *cavity radiator*. An isothermal cavity heated to a uniform temperature generates blackbody radiation, the characteristics of which are determined solely by the temperature of the cavity. Such cavity radiators are commonly used as sources of radiation in temperature reference standards in the laboratory for calibrating thermographic instruments, such as a FLIR Systems camera for example.

If the temperature of blackbody radiation increases to more than 525°C (977°F), the source begins to be visible so that it appears to the eye no longer black. This is the incipient red heat temperature of the radiator, which then becomes orange or yellow as the temperature increases further. In fact, the definition of the so-called *color temperature* of an object is the temperature to which a blackbody would have to be heated to have the same appearance.

Now consider three expressions that describe the radiation emitted from a blackbody.

32.3.1 Planck's law



Figure 32.3 Max Planck (1858–1947)

Max Planck (1858–1947) was able to describe the spectral distribution of the radiation from a blackbody by means of the following formula:

$$W_{\lambda b} = \frac{2\pi hc^2}{\lambda^5 \left(e^{\frac{hc}{\lambda kT}} - 1 \right)} \times 10^{-6} [\text{Watt} / \text{m}^2, \mu\text{m}]$$

where:

$W_{\lambda b}$	Blackbody spectral radiant emittance at wavelength λ .
c	Velocity of light = 3×10^8 m/s
h	Planck's constant = 6.6×10^{-34} Joule sec.
k	Boltzmann's constant = 1.4×10^{-23} Joule/K.
T	Absolute temperature (K) of a blackbody.
λ	Wavelength (μm).

 NOTE
The factor 10^{-6} is used since spectral emittance in the curves is expressed in Watt/m ² , μm .

Planck's formula, when plotted graphically for various temperatures, produces a family of curves. Following any particular Planck curve, the spectral emittance is zero at $\lambda = 0$, then increases rapidly to a maximum at a wavelength λ_{max} and after passing it approaches zero again at very long wavelengths. The higher the temperature, the shorter the wavelength at which maximum occurs.

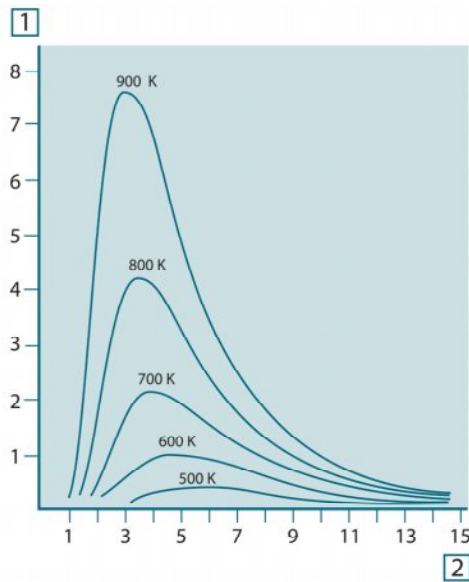

Figure 32.4 Blackbody spectral radiant emittance according to Planck's law, plotted for various absolute temperatures. 1: Spectral radiant emittance ($\text{W}/\text{cm}^2 \times 10^3(\mu\text{m})$); 2: Wavelength (μm)

32.3.2 Wien's displacement law

By differentiating Planck's formula with respect to λ , and finding the maximum, we have:

$$\lambda_{\text{max}} = \frac{2898}{T} [\mu\text{m}]$$

This is Wien's formula (after *Wilhelm Wien*, 1864–1928), which expresses mathematically the common observation that colors vary from red to orange or yellow as the temperature of a thermal radiator increases. The wavelength of the color is the same as the wavelength calculated for λ_{max} . A good approximation of the value of λ_{max} for a given blackbody temperature is obtained by applying the rule-of-thumb $3\,000/T \mu\text{m}$. Thus, a very hot star such as Sirius (11 000 K), emitting bluish-white light, radiates with the peak of spectral radiant emittance occurring within the invisible ultraviolet spectrum, at wavelength $0.27 \mu\text{m}$.

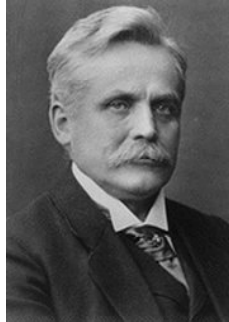

Figure 32.5 Wilhelm Wien (1864–1928)

The sun (approx. 6 000 K) emits yellow light, peaking at about 0.5 μm in the middle of the visible light spectrum.

At room temperature (300 K) the peak of radiant emittance lies at 9.7 μm , in the far infrared, while at the temperature of liquid nitrogen (77 K) the maximum of the almost insignificant amount of radiant emittance occurs at 38 μm , in the extreme infrared wavelengths.

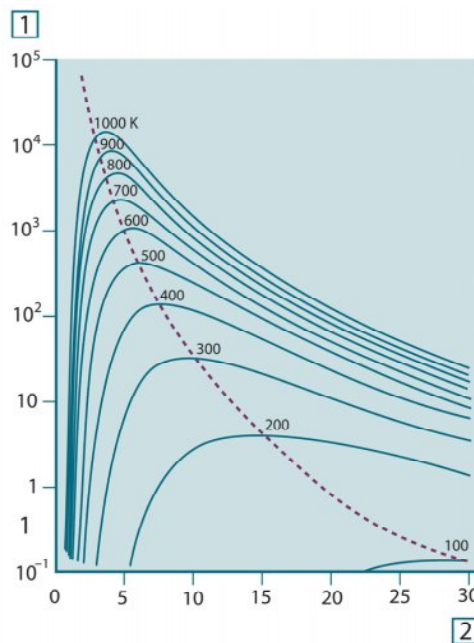

Figure 32.6 Planckian curves plotted on semi-log scales from 100 K to 1000 K. The dotted line represents the locus of maximum radiant emittance at each temperature as described by Wien's displacement law. 1: Spectral radiant emittance (W/cm^2 (μm)); 2: Wavelength (μm).

32.3.3 Stefan-Boltzmann's law

By integrating Planck's formula from $\lambda = 0$ to $\lambda = \infty$, we obtain the total radiant emittance (W_b) of a blackbody:

$$W_b = \sigma T^4 \quad [\text{Watt}/\text{m}^2]$$

This is the Stefan-Boltzmann formula (after *Josef Stefan*, 1835–1893, and *Ludwig Boltzmann*, 1844–1906), which states that the total emissive power of a blackbody is proportional to the fourth power of its absolute temperature. Graphically, W_b represents the area below the Planck curve for a particular temperature. It can be shown that the radiant emittance in the interval $\lambda = 0$ to λ_{max} is only 25% of the total, which represents about the amount of the sun's radiation which lies inside the visible light spectrum.



Figure 32.7 Josef Stefan (1835–1893), and Ludwig Boltzmann (1844–1906)

Using the Stefan-Boltzmann formula to calculate the power radiated by the human body, at a temperature of 300 K and an external surface area of approx. 2 m², we obtain 1 kW. This power loss could not be sustained if it were not for the compensating absorption of radiation from surrounding surfaces, at room temperatures which do not vary too drastically from the temperature of the body – or, of course, the addition of clothing.

32.3.4 Non-blackbody emitters

So far, only blackbody radiators and blackbody radiation have been discussed. However, real objects almost never comply with these laws over an extended wavelength region – although they may approach the blackbody behavior in certain spectral intervals. For example, a certain type of white paint may appear perfectly *white* in the visible light spectrum, but becomes distinctly *gray* at about 2 μm, and beyond 3 μm it is almost *black*.

There are three processes which can occur that prevent a real object from acting like a blackbody: a fraction of the incident radiation α may be absorbed, a fraction ρ may be reflected, and a fraction τ may be transmitted. Since all of these factors are more or less wavelength dependent, the subscript λ is used to imply the spectral dependence of their definitions. Thus:

- The spectral absorptance α_λ = the ratio of the spectral radiant power absorbed by an object to that incident upon it.
- The spectral reflectance ρ_λ = the ratio of the spectral radiant power reflected by an object to that incident upon it.
- The spectral transmittance τ_λ = the ratio of the spectral radiant power transmitted through an object to that incident upon it.

The sum of these three factors must always add up to the whole at any wavelength, so we have the relation:

$$\alpha_\lambda + \rho_\lambda + \tau_\lambda = 1$$

For opaque materials $\tau_\lambda = 0$ and the relation simplifies to:

$$\varepsilon_\lambda + \rho_\lambda = 1$$

Another factor, called the emissivity, is required to describe the fraction ε of the radiant emittance of a blackbody produced by an object at a specific temperature. Thus, we have the definition:

The spectral emissivity ε_λ = the ratio of the spectral radiant power from an object to that from a blackbody at the same temperature and wavelength.

Expressed mathematically, this can be written as the ratio of the spectral emittance of the object to that of a blackbody as follows:

$$\varepsilon_\lambda = \frac{W_{\lambda o}}{W_{\lambda b}}$$

Generally speaking, there are three types of radiation source, distinguished by the ways in which the spectral emittance of each varies with wavelength.

- A blackbody, for which $\varepsilon_\lambda = \varepsilon = 1$
- A graybody, for which $\varepsilon_\lambda = \varepsilon = \text{constant less than 1}$

- A selective radiator, for which ε varies with wavelength

According to Kirchhoff's law, for any material the spectral emissivity and spectral absorptance of a body are equal at any specified temperature and wavelength. That is:

$$\varepsilon_{\lambda} = \alpha_{\lambda}$$

From this we obtain, for an opaque material (since $\alpha_{\lambda} + \rho_{\lambda} = 1$):

$$\varepsilon_{\lambda} + \rho_{\lambda} = 1$$

For highly polished materials ε_{λ} approaches zero, so that for a perfectly reflecting material (*i.e.* a perfect mirror) we have:

$$\rho_{\lambda} = 1$$

For a graybody radiator, the Stefan-Boltzmann formula becomes:

$$W = \varepsilon \sigma T^4 \text{ [Watt/m}^2\text{]}$$

This states that the total emissive power of a graybody is the same as a blackbody at the same temperature reduced in proportion to the value of ε from the graybody.

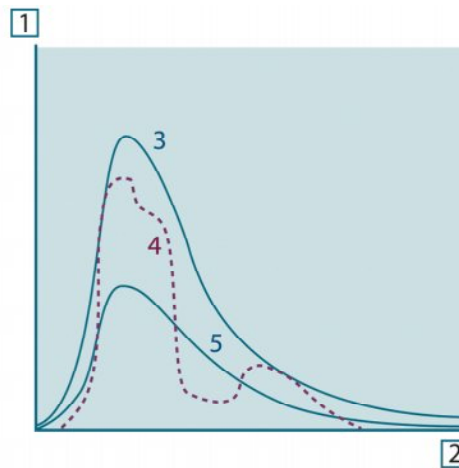

Figure 32.8 Spectral radiant emittance of three types of radiators. 1: Spectral radiant emittance; 2: Wavelength; 3: Blackbody; 4: Selective radiator; 5: Graybody.

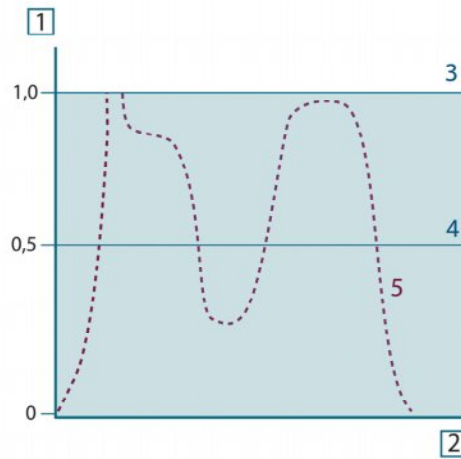

Figure 32.9 Spectral emissivity of three types of radiators. 1: Spectral emissivity; 2: Wavelength; 3: Black-body; 4: Graybody; 5: Selective radiator.

32.4 Infrared semi-transparent materials

Consider now a non-metallic, semi-transparent body – let us say, in the form of a thick flat plate of plastic material. When the plate is heated, radiation generated within its volume must work its way toward the surfaces through the material in which it is partially absorbed. Moreover, when it arrives at the surface, some of it is reflected back into the interior. The back-reflected radiation is again partially absorbed, but some of it arrives at the other surface, through which most of it escapes; part of it is reflected back again. Although the progressive reflections become weaker and weaker they must all be added up when the total emittance of the plate is sought. When the resulting geometrical series is summed, the effective emissivity of a semi-transparent plate is obtained as:

$$\varepsilon_{\lambda} = \frac{(1 - \rho_{\lambda})(1 - \tau_{\lambda})}{1 - \rho_{\lambda}\tau_{\lambda}}$$

When the plate becomes opaque this formula is reduced to the single formula:

$$\varepsilon_{\lambda} = 1 - \rho_{\lambda}$$

This last relation is a particularly convenient one, because it is often easier to measure reflectance than to measure emissivity directly.

As already mentioned, when viewing an object, the camera receives radiation not only from the object itself. It also collects radiation from the surroundings reflected via the object surface. Both these radiation contributions become attenuated to some extent by the atmosphere in the measurement path. To this comes a third radiation contribution from the atmosphere itself.

This description of the measurement situation, as illustrated in the figure below, is so far a fairly true description of the real conditions. What has been neglected could for instance be sun light scattering in the atmosphere or stray radiation from intense radiation sources outside the field of view. Such disturbances are difficult to quantify, however, in most cases they are fortunately small enough to be neglected. In case they are not negligible, the measurement configuration is likely to be such that the risk for disturbance is obvious, at least to a trained operator. It is then his responsibility to modify the measurement situation to avoid the disturbance e.g. by changing the viewing direction, shielding off intense radiation sources etc.

Accepting the description above, we can use the figure below to derive a formula for the calculation of the object temperature from the calibrated camera output.

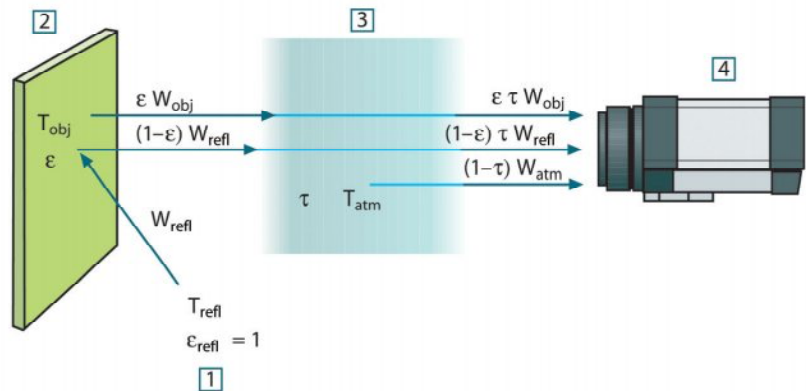

Figure 33.1 A schematic representation of the general thermographic measurement situation. 1: Surroundings; 2: Object; 3: Atmosphere; 4: Camera

Assume that the received radiation power W from a blackbody source of temperature T_{source} on short distance generates a camera output signal U_{source} that is proportional to the power input (power linear camera). We can then write (Equation 1):

$$U_{\text{source}} = CW(T_{\text{source}})$$

or, with simplified notation:

$$U_{\text{source}} = CW_{\text{source}}$$

where C is a constant.

Should the source be a graybody with emittance ϵ , the received radiation would consequently be $\epsilon W_{\text{source}}$.

We are now ready to write the three collected radiation power terms:

1. *Emission from the object* = $\epsilon \tau W_{\text{obj}}$, where ϵ is the emittance of the object and τ is the transmittance of the atmosphere. The object temperature is T_{obj} .

2. *Reflected emission from ambient sources* = $(1 - \varepsilon)\tau W_{refl}$, where $(1 - \varepsilon)$ is the reflectance of the object. The ambient sources have the temperature T_{refl} .

It has here been assumed that the temperature T_{refl} is the same for all emitting surfaces within the halfsphere seen from a point on the object surface. This is of course sometimes a simplification of the true situation. It is, however, a necessary simplification in order to derive a workable formula, and T_{refl} can – at least theoretically – be given a value that represents an efficient temperature of a complex surrounding.

Note also that we have assumed that the emittance for the surroundings = 1. This is correct in accordance with Kirchhoff's law: All radiation impinging on the surrounding surfaces will eventually be absorbed by the same surfaces. Thus the emittance = 1. (Note though that the latest discussion requires the complete sphere around the object to be considered.)

3. *Emission from the atmosphere* = $(1 - \tau)\tau W_{atm}$, where $(1 - \tau)$ is the emittance of the atmosphere. The temperature of the atmosphere is T_{atm} .

The total received radiation power can now be written (Equation 2):

$$W_{tot} = \varepsilon\tau W_{obj} + (1 - \varepsilon)\tau W_{refl} + (1 - \tau)W_{atm}$$

We multiply each term by the constant C of Equation 1 and replace the CW products by the corresponding U according to the same equation, and get (Equation 3):

$$U_{tot} = \varepsilon\tau U_{obj} + (1 - \varepsilon)\tau U_{refl} + (1 - \tau)U_{atm}$$

Solve Equation 3 for U_{obj} (Equation 4):

$$U_{obj} = \frac{1}{\varepsilon\tau} U_{tot} - \frac{1 - \varepsilon}{\varepsilon} U_{refl} - \frac{1 - \tau}{\varepsilon\tau} U_{atm}$$

This is the general measurement formula used in all the FLIR Systems thermographic equipment. The voltagages of the formula are:

Table 33.1 Voltages

U_{obj}	Calculated camera output voltage for a blackbody of temperature T_{obj} i.e. a voltage that can be directly converted into true requested object temperature.
U_{tot}	Measured camera output voltage for the actual case.
U_{refl}	Theoretical camera output voltage for a blackbody of temperature T_{refl} according to the calibration.
U_{atm}	Theoretical camera output voltage for a blackbody of temperature T_{atm} according to the calibration.

The operator has to supply a number of parameter values for the calculation:

- the object emittance ε ,
- the relative humidity,
- T_{atm}
- object distance (D_{obj})
- the (effective) temperature of the object surroundings, or the reflected ambient temperature T_{refl} , and
- the temperature of the atmosphere T_{atm}

This task could sometimes be a heavy burden for the operator since there are normally no easy ways to find accurate values of emittance and atmospheric transmittance for the actual case. The two temperatures are normally less of a problem provided the surroundings do not contain large and intense radiation sources.

A natural question in this connection is: How important is it to know the right values of these parameters? It could though be of interest to get a feeling for this problem already here by looking into some different measurement cases and compare the relative

magnitudes of the three radiation terms. This will give indications about when it is important to use correct values of which parameters.

The figures below illustrates the relative magnitudes of the three radiation contributions for three different object temperatures, two emittances, and two spectral ranges: SW and LW. Remaining parameters have the following fixed values:

- $\tau = 0.88$
- $T_{\text{refl}} = +20^{\circ}\text{C}$ ($+68^{\circ}\text{F}$)
- $T_{\text{atm}} = +20^{\circ}\text{C}$ ($+68^{\circ}\text{F}$)

It is obvious that measurement of low object temperatures are more critical than measuring high temperatures since the 'disturbing' radiation sources are relatively much stronger in the first case. Should also the object emittance be low, the situation would be still more difficult.

We have finally to answer a question about the importance of being allowed to use the calibration curve above the highest calibration point, what we call extrapolation. Imagine that we in a certain case measure $U_{\text{tot}} = 4.5$ volts. The highest calibration point for the camera was in the order of 4.1 volts, a value unknown to the operator. Thus, even if the object happened to be a blackbody, i.e. $U_{\text{obj}} = U_{\text{tot}}$, we are actually performing extrapolation of the calibration curve when converting 4.5 volts into temperature.

Let us now assume that the object is not black, it has an emittance of 0.75, and the transmittance is 0.92. We also assume that the two second terms of Equation 4 amount to 0.5 volts together. Computation of U_{obj} by means of Equation 4 then results in $U_{\text{obj}} = 4.5 / 0.75 / 0.92 - 0.5 = 6.0$. This is a rather extreme extrapolation, particularly when considering that the video amplifier might limit the output to 5 volts! Note, though, that the application of the calibration curve is a theoretical procedure where no electronic or other limitations exist. We trust that if there had been no signal limitations in the camera, and if it had been calibrated far beyond 5 volts, the resulting curve would have been very much the same as our real curve extrapolated beyond 4.1 volts, provided the calibration algorithm is based on radiation physics, like the FLIR Systems algorithm. Of course there must be a limit to such extrapolations.

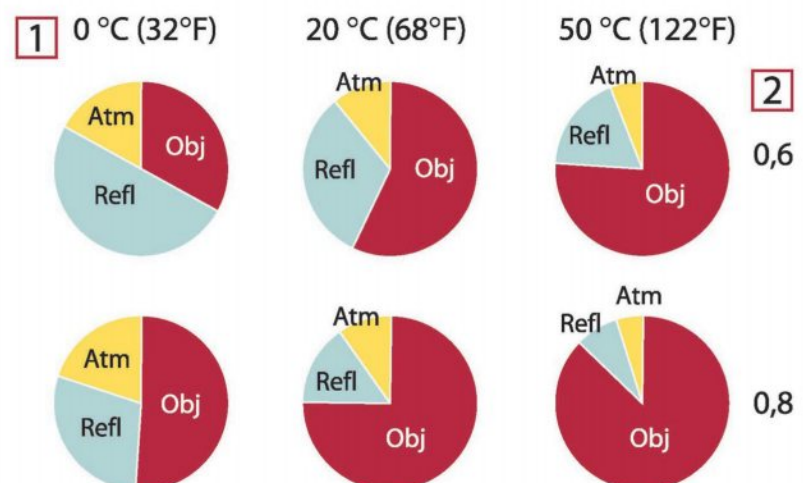

Figure 33.2 Relative magnitudes of radiation sources under varying measurement conditions (SW camera). 1: Object temperature; 2: Emittance; Obj: Object radiation; Refl: Reflected radiation; Atm: atmosphere radiation. Fixed parameters: $\tau = 0.88$; $T_{\text{refl}} = 20^{\circ}\text{C}$ ($+68^{\circ}\text{F}$); $T_{\text{atm}} = 20^{\circ}\text{C}$ ($+68^{\circ}\text{F}$).

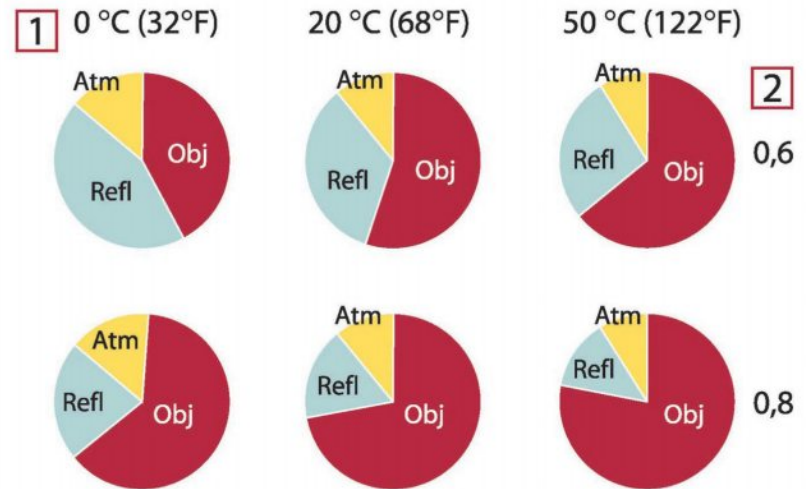



Figure 33.3 Relative magnitudes of radiation sources under varying measurement conditions (LW camera). 1: Object temperature; 2: Emittance; Obj: Object radiation; Refl: Reflected radiation; Atm: atmosphere radiation. Fixed parameters: $\tau = 0.88$; $T_{\text{refl}} = 20^\circ\text{C}$ (+68°F); $T_{\text{atm}} = 20^\circ\text{C}$ (+68°F).

This section presents a compilation of emissivity data from the infrared literature and measurements made by FLIR Systems.

34.1 References

1. Mikaél A. Bramson: *Infrared Radiation, A Handbook for Applications*, Plenum press, N.Y.
2. William L. Wolfe, George J. Zissis: *The Infrared Handbook*, Office of Naval Research, Department of Navy, Washington, D.C.
3. Madding, R. P.: *Thermographic Instruments and systems*. Madison, Wisconsin: University of Wisconsin – Extension, Department of Engineering and Applied Science.
4. William L. Wolfe: *Handbook of Military Infrared Technology*, Office of Naval Research, Department of Navy, Washington, D.C.
5. Jones, Smith, Probert: *External thermography of buildings...*, Proc. of the Society of Photo-Optical Instrumentation Engineers, vol.110, Industrial and Civil Applications of Infrared Technology, June 1977 London.
6. Paljak, Pettersson: *Thermography of Buildings*, Swedish Building Research Institute, Stockholm 1972.
7. Vlcek, J: *Determination of emissivity with imaging radiometers and some emissivities at $\lambda = 5 \mu\text{m}$* . Photogrammetric Engineering and Remote Sensing.
8. Kern: *Evaluation of infrared emission of clouds and ground as measured by weather satellites*, Defence Documentation Center, AD 617 417.
9. Öhman, Claes: *Emittansmätningar med AGEMA E-Box*. Teknisk rapport, AGEMA 1999. (Emittance measurements using AGEMA E-Box. Technical report, AGEMA 1999.)
10. Mattei, S., Tang-Kwor, E: *Emissivity measurements for Nextel Velvet coating 811-21 between -36°C AND 82°C* .
11. Lohrengel & Todtenhaupt (1996)
12. ITC Technical publication 32.
13. ITC Technical publication 29.

 NOTE
The emissivity values in the table below are recorded using a shortwave (SW) camera. The values should be regarded as recommendations only and used with caution.

34.2 Tables

Table 34.1 T: Total spectrum; SW: 2–5 μm ; LW: 8–14 μm , LLW: 6.5–20 μm ; 1: Material; 2: Specification; 3: Temperature in $^{\circ}\text{C}$; 4: Spectrum; 5: Emissivity; 6: Reference

1	2	3	4	5	6
3M type 35	Vinyl electrical tape (several colors)	< 80	LW	≈ 0.96	13
3M type 88	Black vinyl electrical tape	< 105	LW	≈ 0.96	13
3M type 88	Black vinyl electrical tape	< 105	MW	< 0.96	13
3M type Super 33+	Black vinyl electrical tape	< 80	LW	≈ 0.96	13
Aluminum	anodized sheet	100	T	0.55	2
Aluminum	anodized, black, dull	70	SW	0.67	9
Aluminum	anodized, black, dull	70	LW	0.95	9
Aluminum	anodized, light gray, dull	70	SW	0.61	9

Emissivity tables

Table 34.1 T: Total spectrum; SW: 2–5 μm ; LW: 8–14 μm , LLW: 6.5–20 μm ; 1: Material; 2: Specification; 3: Temperature in $^{\circ}\text{C}$; 4: Spectrum; 5: Emissivity; 6: Reference (continued)

1	2	3	4	5	6
Aluminum	anodized, light gray, dull	70	LW	0.97	9
Aluminum	as received, plate	100	T	0.09	4
Aluminum	as received, sheet	100	T	0.09	2
Aluminum	cast, blast cleaned	70	SW	0.47	9
Aluminum	cast, blast cleaned	70	LW	0.46	9
Aluminum	dipped in HNO_3 , plate	100	T	0.05	4
Aluminum	foil	27	10 μm	0.04	3
Aluminum	foil	27	3 μm	0.09	3
Aluminum	oxidized, strongly	50–500	T	0.2–0.3	1
Aluminum	polished	50–100	T	0.04–0.06	1
Aluminum	polished plate	100	T	0.05	4
Aluminum	polished, sheet	100	T	0.05	2
Aluminum	rough surface	20–50	T	0.06–0.07	1
Aluminum	roughened	27	10 μm	0.18	3
Aluminum	roughened	27	3 μm	0.28	3
Aluminum	sheet, 4 samples differently scratched	70	SW	0.05–0.08	9
Aluminum	sheet, 4 samples differently scratched	70	LW	0.03–0.06	9
Aluminum	vacuum deposited	20	T	0.04	2
Aluminum	weathered, heavily	17	SW	0.83–0.94	5
Aluminum bronze		20	T	0.60	1
Aluminum hydroxide	powder		T	0.28	1
Aluminum oxide	activated, powder		T	0.46	1
Aluminum oxide	pure, powder (alumina)		T	0.16	1
Asbestos	board	20	T	0.96	1
Asbestos	fabric		T	0.78	1
Asbestos	floor tile	35	SW	0.94	7
Asbestos	paper	40–400	T	0.93–0.95	1
Asbestos	powder		T	0.40–0.60	1
Asbestos	slate	20	T	0.96	1
Asphalt paving		4	LLW	0.967	8
Brass	dull, tarnished	20–350	T	0.22	1
Brass	oxidized	100	T	0.61	2
Brass	oxidized	70	SW	0.04–0.09	9
Brass	oxidized	70	LW	0.03–0.07	9
Brass	oxidized at 600 $^{\circ}\text{C}$	200–600	T	0.59–0.61	1

Table 34.1 T: Total spectrum; SW: 2–5 μm ; LW: 8–14 μm , LLW: 6.5–20 μm ; 1: Material; 2: Specification; 3: Temperature in $^{\circ}\text{C}$; 4: Spectrum; 5: Emissivity; 6: Reference (continued)

1	2	3	4	5	6
Brass	polished	200	T	0.03	1
Brass	polished, highly	100	T	0.03	2
Brass	rubbed with 80-grit emery	20	T	0.20	2
Brass	sheet, rolled	20	T	0.06	1
Brass	sheet, worked with emery	20	T	0.2	1
Brick	alumina	17	SW	0.68	5
Brick	common	17	SW	0.86–0.81	5
Brick	Dinas silica, glazed, rough	1100	T	0.85	1
Brick	Dinas silica, refractory	1000	T	0.66	1
Brick	Dinas silica, unglazed, rough	1000	T	0.80	1
Brick	firebrick	17	SW	0.68	5
Brick	fireclay	1000	T	0.75	1
Brick	fireclay	1200	T	0.59	1
Brick	fireclay	20	T	0.85	1
Brick	masonry	35	SW	0.94	7
Brick	masonry, plastered	20	T	0.94	1
Brick	red, common	20	T	0.93	2
Brick	red, rough	20	T	0.88–0.93	1
Brick	refractory, corundum	1000	T	0.46	1
Brick	refractory, magnesite	1000–1300	T	0.38	1
Brick	refractory, strongly radiating	500–1000	T	0.8–0.9	1
Brick	refractory, weakly radiating	500–1000	T	0.65–0.75	1
Brick	silica, 95% SiO_2	1230	T	0.66	1
Brick	sillimanite, 33% SiO_2 , 64% Al_2O_3	1500	T	0.29	1
Brick	waterproof	17	SW	0.87	5
Bronze	phosphor bronze	70	SW	0.08	9
Bronze	phosphor bronze	70	LW	0.06	9
Bronze	polished	50	T	0.1	1
Bronze	porous, rough	50–150	T	0.55	1
Bronze	powder		T	0.76–0.80	1
Carbon	candle soot	20	T	0.95	2
Carbon	charcoal powder		T	0.96	1
Carbon	graphite powder		T	0.97	1
Carbon	graphite, filed surface	20	T	0.98	2
Carbon	lampblack	20–400	T	0.95–0.97	1

Table 34.1 T: Total spectrum; SW: 2–5 μm ; LW: 8–14 μm , LLW: 6.5–20 μm ; 1: Material; 2: Specification; 3: Temperature in $^{\circ}\text{C}$; 4: Spectrum; 5: Emissivity; 6: Reference (continued)

1	2	3	4	5	6
Chipboard	untreated	20	SW	0.90	6
Chromium	polished	50	T	0.10	1
Chromium	polished	500–1000	T	0.28–0.38	1
Clay	fired	70	T	0.91	1
Cloth	black	20	T	0.98	1
Concrete		20	T	0.92	2
Concrete	dry	36	SW	0.95	7
Concrete	rough	17	SW	0.97	5
Concrete	walkway	5	LLW	0.974	8
Copper	commercial, burnished	20	T	0.07	1
Copper	electrolytic, carefully polished	80	T	0.018	1
Copper	electrolytic, polished	–34	T	0.006	4
Copper	molten	1100–1300	T	0.13–0.15	1
Copper	oxidized	50	T	0.6–0.7	1
Copper	oxidized to blackness		T	0.88	1
Copper	oxidized, black	27	T	0.78	4
Copper	oxidized, heavily	20	T	0.78	2
Copper	polished	50–100	T	0.02	1
Copper	polished	100	T	0.03	2
Copper	polished, commercial	27	T	0.03	4
Copper	polished, mechanical	22	T	0.015	4
Copper	pure, carefully prepared surface	22	T	0.008	4
Copper	scraped	27	T	0.07	4
Copper dioxide	powder		T	0.84	1
Copper oxide	red, powder		T	0.70	1
Ebonite			T	0.89	1
Emery	coarse	80	T	0.85	1
Enamel		20	T	0.9	1
Enamel	lacquer	20	T	0.85–0.95	1
Fiber board	hard, untreated	20	SW	0.85	6
Fiber board	masonite	70	SW	0.75	9
Fiber board	masonite	70	LW	0.88	9
Fiber board	particle board	70	SW	0.77	9
Fiber board	particle board	70	LW	0.89	9
Fiber board	porous, untreated	20	SW	0.85	6
Gold	polished	130	T	0.018	1
Gold	polished, carefully	200–600	T	0.02–0.03	1
Gold	polished, highly	100	T	0.02	2

Table 34.1 T: Total spectrum; SW: 2–5 μm ; LW: 8–14 μm , LLW: 6.5–20 μm ; 1: Material; 2: Specification; 3: Temperature in $^{\circ}\text{C}$; 4: Spectrum; 5: Emissivity; 6: Reference (continued)

1	2	3	4	5	6
Granite	polished	20	LLW	0.849	8
Granite	rough	21	LLW	0.879	8
Granite	rough, 4 different samples	70	SW	0.95–0.97	9
Granite	rough, 4 different samples	70	LW	0.77–0.87	9
Gypsum		20	T	0.8–0.9	1
Ice: See Water					
Iron and steel	cold rolled	70	SW	0.20	9
Iron and steel	cold rolled	70	LW	0.09	9
Iron and steel	covered with red rust	20	T	0.61–0.85	1
Iron and steel	electrolytic	100	T	0.05	4
Iron and steel	electrolytic	22	T	0.05	4
Iron and steel	electrolytic	260	T	0.07	4
Iron and steel	electrolytic, carefully polished	175–225	T	0.05–0.06	1
Iron and steel	freshly worked with emery	20	T	0.24	1
Iron and steel	ground sheet	950–1100	T	0.55–0.61	1
Iron and steel	heavily rusted sheet	20	T	0.69	2
Iron and steel	hot rolled	130	T	0.60	1
Iron and steel	hot rolled	20	T	0.77	1
Iron and steel	oxidized	100	T	0.74	4
Iron and steel	oxidized	100	T	0.74	1
Iron and steel	oxidized	1227	T	0.89	4
Iron and steel	oxidized	125–525	T	0.78–0.82	1
Iron and steel	oxidized	200	T	0.79	2
Iron and steel	oxidized	200–600	T	0.80	1
Iron and steel	oxidized strongly	50	T	0.88	1
Iron and steel	oxidized strongly	500	T	0.98	1
Iron and steel	polished	100	T	0.07	2
Iron and steel	polished	400–1000	T	0.14–0.38	1
Iron and steel	polished sheet	750–1050	T	0.52–0.56	1
Iron and steel	rolled sheet	50	T	0.56	1
Iron and steel	rolled, freshly	20	T	0.24	1
Iron and steel	rough, plane surface	50	T	0.95–0.98	1
Iron and steel	rusted red, sheet	22	T	0.69	4
Iron and steel	rusted, heavily	17	SW	0.96	5
Iron and steel	rusty, red	20	T	0.69	1
Iron and steel	shiny oxide layer, sheet,	20	T	0.82	1
Iron and steel	shiny, etched	150	T	0.16	1

Table 34.1 T: Total spectrum; SW: 2–5 μm ; LW: 8–14 μm , LLW: 6.5–20 μm ; 1: Material; 2: Specification; 3: Temperature in $^{\circ}\text{C}$; 4: Spectrum; 5: Emissivity; 6: Reference (continued)

1	2	3	4	5	6
Iron and steel	wrought, carefully polished	40–250	T	0.28	1
Iron galvanized	heavily oxidized	70	SW	0.64	9
Iron galvanized	heavily oxidized	70	LW	0.85	9
Iron galvanized	sheet	92	T	0.07	4
Iron galvanized	sheet, burnished	30	T	0.23	1
Iron galvanized	sheet, oxidized	20	T	0.28	1
Iron tinned	sheet	24	T	0.064	4
Iron, cast	casting	50	T	0.81	1
Iron, cast	ingots	1000	T	0.95	1
Iron, cast	liquid	1300	T	0.28	1
Iron, cast	machined	800–1000	T	0.60–0.70	1
Iron, cast	oxidized	100	T	0.64	2
Iron, cast	oxidized	260	T	0.66	4
Iron, cast	oxidized	38	T	0.63	4
Iron, cast	oxidized	538	T	0.76	4
Iron, cast	oxidized at 600 $^{\circ}\text{C}$	200–600	T	0.64–0.78	1
Iron, cast	polished	200	T	0.21	1
Iron, cast	polished	38	T	0.21	4
Iron, cast	polished	40	T	0.21	2
Iron, cast	unworked	900–1100	T	0.87–0.95	1
Krylon Ultra-flat black 1602	Flat black	Room temperature up to 175	LW	≈ 0.96	12
Krylon Ultra-flat black 1602	Flat black	Room temperature up to 175	MW	≈ 0.97	12
Lacquer	3 colors sprayed on Aluminum	70	SW	0.50–0.53	9
Lacquer	3 colors sprayed on Aluminum	70	LW	0.92–0.94	9
Lacquer	Aluminum on rough surface	20	T	0.4	1
Lacquer	bakelite	80	T	0.83	1
Lacquer	black, dull	40–100	T	0.96–0.98	1
Lacquer	black, matte	100	T	0.97	2
Lacquer	black, shiny, sprayed on iron	20	T	0.87	1
Lacquer	heat-resistant	100	T	0.92	1
Lacquer	white	100	T	0.92	2
Lacquer	white	40–100	T	0.8–0.95	1
Lead	oxidized at 200 $^{\circ}\text{C}$	200	T	0.63	1
Lead	oxidized, gray	20	T	0.28	1
Lead	oxidized, gray	22	T	0.28	4
Lead	shiny	250	T	0.08	1
Lead	unoxidized, polished	100	T	0.05	4

Table 34.1 T: Total spectrum; SW: 2–5 µm; LW: 8–14 µm, LLW: 6.5–20 µm; 1: Material; 2: Specification; 3: Temperature in °C; 4: Spectrum; 5: Emissivity; 6: Reference (continued)

1	2	3	4	5	6
Lead red		100	T	0.93	4
Lead red, powder		100	T	0.93	1
Leather	tanned		T	0.75–0.80	1
Lime			T	0.3–0.4	1
Magnesium		22	T	0.07	4
Magnesium		260	T	0.13	4
Magnesium		538	T	0.18	4
Magnesium	polished	20	T	0.07	2
Magnesium powder			T	0.86	1
Molybdenum		1500–2200	T	0.19–0.26	1
Molybdenum		600–1000	T	0.08–0.13	1
Molybdenum	filament	700–2500	T	0.1–0.3	1
Mortar		17	SW	0.87	5
Mortar	dry	36	SW	0.94	7
Nextel Velvet 811-21 Black	Flat black	–60–150	LW	> 0.97	10 and 11
Nichrome	rolled	700	T	0.25	1
Nichrome	sandblasted	700	T	0.70	1
Nichrome	wire, clean	50	T	0.65	1
Nichrome	wire, clean	500–1000	T	0.71–0.79	1
Nichrome	wire, oxidized	50–500	T	0.95–0.98	1
Nickel	bright matte	122	T	0.041	4
Nickel	commercially pure, polished	100	T	0.045	1
Nickel	commercially pure, polished	200–400	T	0.07–0.09	1
Nickel	electrolytic	22	T	0.04	4
Nickel	electrolytic	260	T	0.07	4
Nickel	electrolytic	38	T	0.06	4
Nickel	electrolytic	538	T	0.10	4
Nickel	electroplated on iron, polished	22	T	0.045	4
Nickel	electroplated on iron, unpolished	20	T	0.11–0.40	1
Nickel	electroplated on iron, unpolished	22	T	0.11	4
Nickel	electroplated, polished	20	T	0.05	2
Nickel	oxidized	1227	T	0.85	4
Nickel	oxidized	200	T	0.37	2
Nickel	oxidized	227	T	0.37	4
Nickel	oxidized at 600°C	200–600	T	0.37–0.48	1
Nickel	polished	122	T	0.045	4
Nickel	wire	200–1000	T	0.1–0.2	1
Nickel oxide		1000–1250	T	0.75–0.86	1

Table 34.1 T: Total spectrum; SW: 2–5 μm ; LW: 8–14 μm , LLW: 6.5–20 μm ; 1: Material; 2: Specification; 3: Temperature in $^{\circ}\text{C}$; 4: Spectrum; 5: Emissivity; 6: Reference (continued)

1	2	3	4	5	6
Nickel oxide		500–650	T	0.52–0.59	1
Oil, lubricating	0.025 mm film	20	T	0.27	2
Oil, lubricating	0.050 mm film	20	T	0.46	2
Oil, lubricating	0.125 mm film	20	T	0.72	2
Oil, lubricating	film on Ni base: Ni base only	20	T	0.05	2
Oil, lubricating	thick coating	20	T	0.82	2
Paint	8 different colors and qualities	70	SW	0.88–0.96	9
Paint	8 different colors and qualities	70	LW	0.92–0.94	9
Paint	Aluminum, vari- ous ages	50–100	T	0.27–0.67	1
Paint	cadmium yellow		T	0.28–0.33	1
Paint	chrome green		T	0.65–0.70	1
Paint	cobalt blue		T	0.7–0.8	1
Paint	oil	17	SW	0.87	5
Paint	oil based, aver- age of 16 colors	100	T	0.94	2
Paint	oil, black flat	20	SW	0.94	6
Paint	oil, black gloss	20	SW	0.92	6
Paint	oil, gray flat	20	SW	0.97	6
Paint	oil, gray gloss	20	SW	0.96	6
Paint	oil, various colors	100	T	0.92–0.96	1
Paint	plastic, black	20	SW	0.95	6
Paint	plastic, white	20	SW	0.84	6
Paper	4 different colors	70	SW	0.68–0.74	9
Paper	4 different colors	70	LW	0.92–0.94	9
Paper	black		T	0.90	1
Paper	black, dull		T	0.94	1
Paper	black, dull	70	SW	0.86	9
Paper	black, dull	70	LW	0.89	9
Paper	blue, dark		T	0.84	1
Paper	coated with black lacquer		T	0.93	1
Paper	green		T	0.85	1
Paper	red		T	0.76	1
Paper	white	20	T	0.7–0.9	1
Paper	white bond	20	T	0.93	2
Paper	white, 3 different glosses	70	SW	0.76–0.78	9
Paper	white, 3 different glosses	70	LW	0.88–0.90	9
Paper	yellow		T	0.72	1
Plaster		17	SW	0.86	5

Table 34.1 T: Total spectrum; SW: 2–5 μm ; LW: 8–14 μm , LLW: 6.5–20 μm ; 1: Material; 2: Specification; 3: Temperature in $^{\circ}\text{C}$; 4: Spectrum; 5: Emissivity; 6: Reference (continued)

1	2	3	4	5	6
Plaster	plasterboard, untreated	20	SW	0.90	6
Plaster	rough coat	20	T	0.91	2
Plastic	glass fibre laminate (printed circ. board)	70	SW	0.94	9
Plastic	glass fibre laminate (printed circ. board)	70	LW	0.91	9
Plastic	polyurethane isolation board	70	LW	0.55	9
Plastic	polyurethane isolation board	70	SW	0.29	9
Plastic	PVC, plastic floor, dull, structured	70	SW	0.94	9
Plastic	PVC, plastic floor, dull, structured	70	LW	0.93	9
Platinum		100	T	0.05	4
Platinum		1000–1500	T	0.14–0.18	1
Platinum		1094	T	0.18	4
Platinum		17	T	0.016	4
Platinum		22	T	0.03	4
Platinum		260	T	0.06	4
Platinum		538	T	0.10	4
Platinum	pure, polished	200–600	T	0.05–0.10	1
Platinum	ribbon	900–1100	T	0.12–0.17	1
Platinum	wire	1400	T	0.18	1
Platinum	wire	500–1000	T	0.10–0.16	1
Platinum	wire	50–200	T	0.06–0.07	1
Porcelain	glazed	20	T	0.92	1
Porcelain	white, shiny		T	0.70–0.75	1
Rubber	hard	20	T	0.95	1
Rubber	soft, gray, rough	20	T	0.95	1
Sand			T	0.60	1
Sand		20	T	0.90	2
Sandstone	polished	19	LLW	0.909	8
Sandstone	rough	19	LLW	0.935	8
Silver	polished	100	T	0.03	2
Silver	pure, polished	200–600	T	0.02–0.03	1
Skin	human	32	T	0.98	2
Slag	boiler	0–100	T	0.97–0.93	1
Slag	boiler	1400–1800	T	0.69–0.67	1
Slag	boiler	200–500	T	0.89–0.78	1
Slag	boiler	600–1200	T	0.76–0.70	1
Snow: See Water					
Soil	dry	20	T	0.92	2

Table 34.1 T: Total spectrum; SW: 2–5 µm; LW: 8–14 µm, LLW: 6.5–20 µm; 1: Material; 2: Specification; 3: Temperature in °C; 4: Spectrum; 5: Emissivity; 6: Reference (continued)

1	2	3	4	5	6
Soil	saturated with water	20	T	0.95	2
Stainless steel	alloy, 8% Ni, 18% Cr	500	T	0.35	1
Stainless steel	rolled	700	T	0.45	1
Stainless steel	sandblasted	700	T	0.70	1
Stainless steel	sheet, polished	70	SW	0.18	9
Stainless steel	sheet, polished	70	LW	0.14	9
Stainless steel	sheet, untreated, somewhat scratched	70	SW	0.30	9
Stainless steel	sheet, untreated, somewhat scratched	70	LW	0.28	9
Stainless steel	type 18-8, buffed	20	T	0.16	2
Stainless steel	type 18-8, oxidized at 800°C	60	T	0.85	2
Stucco	rough, lime	10–90	T	0.91	1
Styrofoam	insulation	37	SW	0.60	7
Tar			T	0.79–0.84	1
Tar	paper	20	T	0.91–0.93	1
Tile	glazed	17	SW	0.94	5
Tin	burnished	20–50	T	0.04–0.06	1
Tin	tin-plated sheet iron	100	T	0.07	2
Titanium	oxidized at 540°C	1000	T	0.60	1
Titanium	oxidized at 540°C	200	T	0.40	1
Titanium	oxidized at 540°C	500	T	0.50	1
Titanium	polished	1000	T	0.36	1
Titanium	polished	200	T	0.15	1
Titanium	polished	500	T	0.20	1
Tungsten		1500–2200	T	0.24–0.31	1
Tungsten		200	T	0.05	1
Tungsten		600–1000	T	0.1–0.16	1
Tungsten	filament	3300	T	0.39	1
Varnish	flat	20	SW	0.93	6
Varnish	on oak parquet floor	70	SW	0.90	9
Varnish	on oak parquet floor	70	LW	0.90–0.93	9
Wallpaper	slight pattern, light gray	20	SW	0.85	6
Wallpaper	slight pattern, red	20	SW	0.90	6
Water	distilled	20	T	0.96	2
Water	frost crystals	–10	T	0.98	2
Water	ice, covered with heavy frost	0	T	0.98	1
Water	ice, smooth	0	T	0.97	1

Table 34.1 T: Total spectrum; SW: 2–5 μm ; LW: 8–14 μm , LLW: 6.5–20 μm ; 1: Material; 2: Specification; 3: Temperature in $^{\circ}\text{C}$; 4: Spectrum; 5: Emissivity; 6: Reference (continued)

1	2	3	4	5	6
Water	ice, smooth	-10	T	0.96	2
Water	layer >0.1 mm thick	0–100	T	0.95–0.98	1
Water	snow		T	0.8	1
Water	snow	-10	T	0.85	2
Wood		17	SW	0.98	5
Wood		19	LLW	0.962	8
Wood	ground		T	0.5–0.7	1
Wood	pine, 4 different samples	70	SW	0.67–0.75	9
Wood	pine, 4 different samples	70	LW	0.81–0.89	9
Wood	planed	20	T	0.8–0.9	1
Wood	planed oak	20	T	0.90	2
Wood	planed oak	70	SW	0.77	9
Wood	planed oak	70	LW	0.88	9
Wood	plywood, smooth, dry	36	SW	0.82	7
Wood	plywood, untreated	20	SW	0.83	6
Wood	white, damp	20	T	0.7–0.8	1
Zinc	oxidized at 400 $^{\circ}\text{C}$	400	T	0.11	1
Zinc	oxidized surface	1000–1200	T	0.50–0.60	1
Zinc	polished	200–300	T	0.04–0.05	1
Zinc	sheet	50	T	0.20	1

A note on the technical production of this publication

This publication was produced using XML — the eXtensible Markup Language. For more information about XML, please visit <http://www.w3.org/XML/>

A note on the typeface used in this publication

This publication was typeset using Linotype Helvetica™ World. Helvetica™ was designed by Max Miedinger (1910–1980)

LOEF (List Of Effective Files)

T501131.xml; en-US; 28105; 2015-08-26
T505864.xml; en-US; 26038; 2015-05-27
T505469.xml; en-US; 23215; 2015-02-19
T505013.xml; en-US; 9229; 2013-10-03
T505819.xml; en-US; 26749; 2015-06-14
T505821.xml; en-US; 26749; 2015-06-14
T505822.xml; en-US; 26749; 2015-06-14
T505823.xml; en-US; 26749; 2015-06-14
T505824.xml; en-US; 26749; 2015-06-14
T505825.xml; en-US; 27862; 2015-08-12
T505826.xml; en-US; 27862; 2015-08-12
T505827.xml; en-US; 27862; 2015-08-12
T505657.xml; en-US; 26749; 2015-06-14
T505658.xml; en-US; 27862; 2015-08-12
T505659.xml; en-US; 26749; 2015-06-14
T505829.xml; en-US; 27862; 2015-08-12
T505661.xml; en-US; 26749; 2015-06-14
T505662.xml; en-US; 26749; 2015-06-14
T505765.xml; en-US; 27862; 2015-08-12
T505880.xml; en-US; 27861; 2015-08-12
T505881.xml; en-US; 27860; 2015-08-12
T505831.xml; en-US; 27862; 2015-08-12
T505853.xml; en-US; 28063; 2015-08-24
T505476.xml; en-US; 11926; 2014-02-20
T505012.xml; en-US; 12154; 2014-03-06
T505007.xml; en-US; 24845; 2015-04-20
T505004.xml; en-US; 12154; 2014-03-06
T505000.xml; en-US; 12154; 2014-03-06
T505005.xml; en-US; 12154; 2014-03-06
T505001.xml; en-US; 12154; 2014-03-06
T505006.xml; en-US; 12154; 2014-03-06
T505002.xml; en-US; 24902; 2015-04-22



Corporate Headquarters

FLIR Systems, Inc.
27700 SW Parkway Ave.
Wilsonville, OR 97070
USA
Telephone: +1-503-498-3547

Website

<http://www.flir.com>

Customer support

<http://support.flir.com>

Copyright

© 2015, FLIR Systems, Inc. All rights reserved worldwide.

Disclaimer

Specifications subject to change without further notice. Models and accessories subject to regional market considerations. License procedures may apply. Products described herein may be subject to US Export Regulations. Please refer to exportquestions@flir.com with any questions.

Publ. No.: T559954
Commit: 28105
Head: 28105
Language: en-US
Modified: 2015-08-26
Formatted: 2015-08-26