

**INSTRUCTION  
MANUAL**

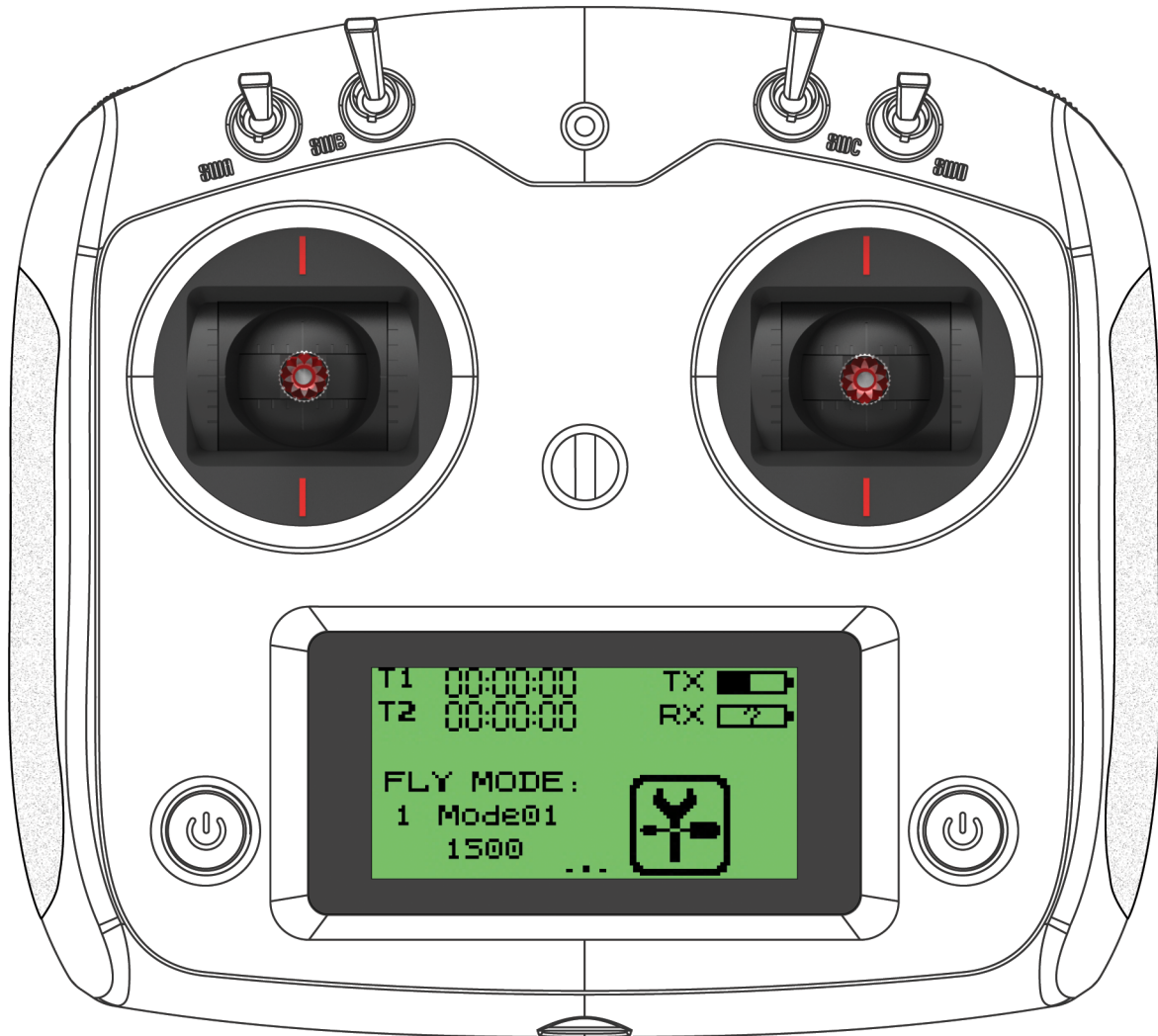

**2.4GHz  
AFHDS 2A**

**Digital proportional radio control system**

**WARNING:**

This product is only for 15 years  
old or above





Thank you for purchasing our product, an ideal radio system for beginners or experienced users alike.

Read this manual carefully before operation in order to ensure your safety, and the safety of others or the safe operation of your system.

If you encounter any problem during use, refer to this manual first. If the problem persists, contact your local dealer or visit our service and support website for help:

[www.flysky-cn.com/service.asp](http://www.flysky-cn.com/service.asp)

**Table of contents**

**1. Safety ..... 4**

    1.1 Safety Symbols ..... 4

    1.2 Safety Guide..... 4

**2. Introduction ..... 6**

    2.1 System Features..... 6

    2.2 Transmitter Overview ..... 7

        2.2.1 Transmitter Antenna ..... 8

        2.2.3 Status Indicator..... 8

    2.3 Receiver Overview ..... 8

        2.3.1 Receiver Antenna ..... 8

        2.3.2 Status Indicator ..... 8

        2.3.3 Connectors ..... 8

    2.4 USB Simulator Mode ..... 9

    2.5 PS/2 Port ..... 9

**3. Getting Started ..... 10**

    3.1 Transmitter Battery Installation..... 10

    3.2 Connecting the Receiver and Servos ..... 10

**4. Operation Instructions ..... 11**

    4.1 Power On ..... 11

    4.2 Binding..... 11

    4.3 Pre-use Check ..... 11

    4.4 Power Off ..... 12

**5. Home Screen ..... 13**

    5.1 Fly Mode ..... 14

    5.2 Timers..... 15

**6. Function Settings..... 16**

    6.1 Reverse Function ..... 16

    6.2 End Points Function ..... 16

    6.3 Subtrim Function..... 16

    6.4 Aux. Channels ..... 17

    6.5 Mix..... 17

    6.6 Failsafe Function..... 18

    6.7 Bri./Sound..... 18

    6.8 Output Mode..... 19

    6.9 Stick Mode..... 19

    6.10 Factory Reset..... 19

    6.11 Firmware Update ..... 20

    6.12 About FS-i6S..... 20

**7. Product Specifications..... 21**

    7.1 Transmitter Specifications..... 21

    7.2 Receiver Specifications..... 21

**8. Package Contents..... 22**

**9. FCC..... 23**

**This page is intentionally left blank.**

## 1. Safety

### 1.1 Safety Symbols

Pay close attention to the following symbols and their meanings. Failure to follow these warnings could cause damage, injury or death.

 **Danger** • Not following these instructions may lead to serious injuries or death.

 **Warning** • Not following these instructions may lead to major injuries.

 **Attention** • Not following these instructions may lead to minor injuries.

### 1.2 Safety Guide



**Prohibited**



**Mandatory**



- Do not use the product at night or in bad weather like rain or thunderstorm. It can cause erratic operation or loss of control.
- Do not use the product when visibility is limited.
- Do not use the product on rain or snow days. Any exposure to moisture (water or snow) may cause erratic operation or loss of control.
- Interference may cause loss of control. To ensure the safety of you and others, do not operate in the following places:
  - Near any site where other radio control activity may occur
  - Near power lines or communication broadcasting antennas
  - Near people or roads
  - On any pond when passenger boats are present
- Do not use this product when you are tired, uncomfortable, or under the influence of alcohol or drugs. Doing so may cause serious injury to yourself or others.
- The 2.4GHz radio band is limited to line of sight. Always keep your model in sight as a large object can block the RF signal and lead to loss of control.
- Never grip the transmitter antenna during operation. It significantly degrades signal quality and strength and may cause loss of control.
- Do not touch any part of the model that may generate heat during operation, or immediately after use. The engine, motor or speed control, may be very hot and can cause serious burns.



- **Misuse of this product may lead to serious injury or death. To ensure the safety of you and your equipment, read this manual and follow the instructions.**
- **Make sure the product is properly installed in your model. Failure to do so may result in serious injury.**
- **Make sure to disconnect the receiver battery before turning off the transmitter. Failure to do so may lead to unintended operation and cause an accident.**
- **Ensure that all motors operate in the correct direction. If not, adjust the direction first.**
- **Make sure the model flies within a certain distance. Otherwise, it would cause loss of control.**

## 2. Introduction

The FS-i6S transmitter and FS-iA6B receiver constitute a 10 channel 2.4GHz AFHDS 2A digital proportional computerized R/C system. This system supports quadcopters.

### 2.1 System Features

The AFHDS 2A (Automatic Frequency Hopping Digital System Second Generation) developed and patented by FLYSKY is specially developed for all radio control models. Offering superior protection against interference while maintaining lower power consumption and high reliable receiver sensitivity, FLYSKY's AFHDS technology is considered to be one of the leaders in the RC market today.



#### **Bidirectional Communication**

Capable of sending and receiving data, each transmitter is capable of receiving data from temperature, altitude and many other types of sensors, servo calibration and i-BUS Support.



#### **Multi-channel Hopping Frequency**

This systems bandwidth ranges from 2.4055GHz to 2.475GHz. This band is divided in 140 channels. Each transmitter hops between 16 channels (32 for Japanese and Korean versions) in order to reduce interference from other transmitters.



#### **Omnidirectional Gain Antenna**

The high efficiency Omnidirectional high gain antenna cuts down on interference, while using less power and maintaining a strong reliable connection.

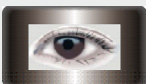

#### **Unique ID Recognition System**

Each transmitter and receiver has it's own unique ID. Once the transmitter and receiver have been paired, they will only communicate with each other, preventing other systems accidentally connecting to or interfering with the systems operation.



#### **Low Power Consumption**

The system is built using highly sensitive low power consumption components, maintaining high receiver sensitivity, while consuming as little as one tenth the power of a standard FM system, dramatically extending battery life.

## 2.2 Transmitter Overview

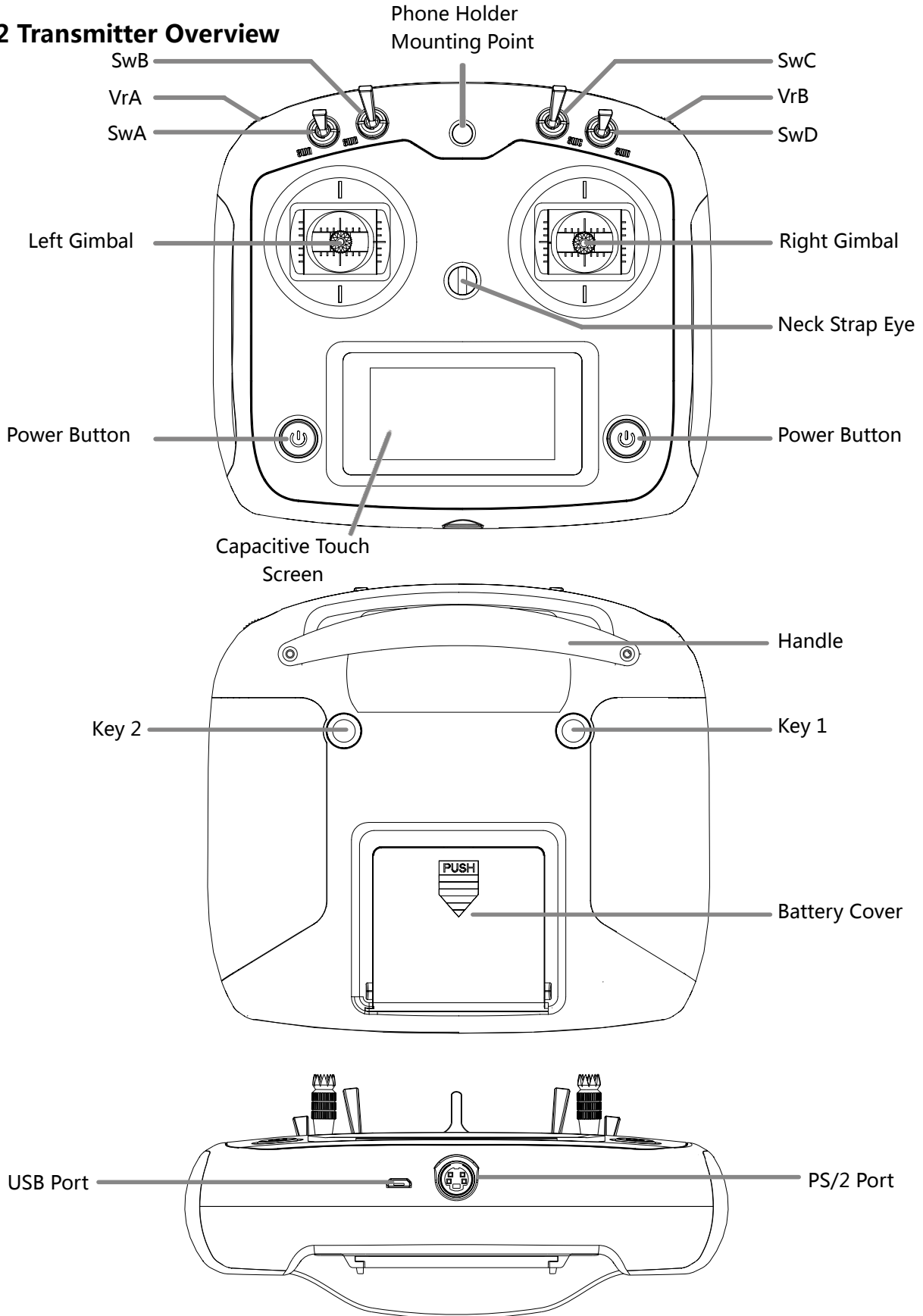



## 2.2.1 Transmitter Antenna

Precautions:

- For best signal quality, make sure that the antenna is at about a 90 degree angle to the model. Do not point the antenna directly at the receiver.
- Never grip the transmitter antenna during operation. It significantly degrades the RF signal quality and strength and may cause loss of control.

## 2.2.2 Status Indicator

The status indicator is used to indicate the power and working status of the transmitter.

- Off: the transmitter is powered off.
- Blue light: the transmitter is on and working.
- Flashing: low battery or low signal alarm.

## 2.3 Receiver Overview

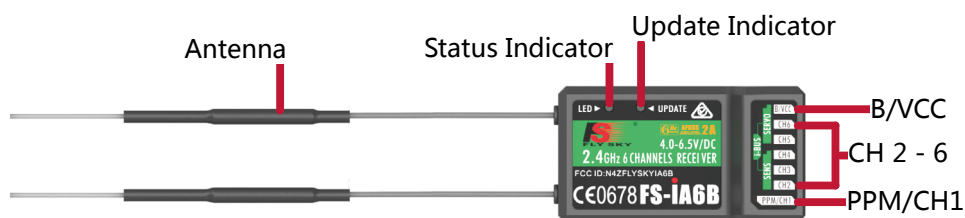

### 2.3.1 Receiver Antenna



**Attention**

- For best signal quality, ensure that the receiver is mounted away from motors or metal parts.

### 2.3.2 Status Indicator

The status indicator is used to indicate the power and working status of the receiver.

- Off: the power is not connected.
- Lit in red: the receiver is on and working.
- Flashing quickly: the receiver is binding.
- Flashing slowly: the bound transmitter is off or signal is lost.

### 2.3.3 Connectors

The connectors are used to connect the parts of model and the receiver.

- PPM/CH1: doubles as CH1 and a PPM output.
- CH2 to CH6: used to connect the servos, power or other parts.
- B/VCC: used to connect the bind cable for binding, and the power cable during normal operation.
- SERVO: used to connect i-Bus module and extend channels.
- SENS: used to connect all kinds of sensors.

## 2.4 USB Simulator Mode

The system may be used as a HID controller when connected to a computer via USB. When connected to a computer the function is activated automatically and will be recognized by windows as a game controller.

To calibrate or test the system in windows:

- 1. Type "RUN" into the search bar and select the program.
  - 2. Type "joy.exe" into the "Open:" box and press enter.
  - 3. Select the system and open properties within the game controller menu.
- Note: any changes made to trims within the system will take effect in the USB mode. If the system is not responding as expected, reset to factory settings in the system menu.

## 2.5 PS/2 Port

The PS/2 Port can be used to interface with UART devices such as GPS, WIFI or Bluetooth.

## 3. Getting Started

Before operation, install the battery and connect the system as instructed below.

### 3.1 Transmitter Battery Installation



**Danger** • Only use specified battery.



**Danger** • Do not open, disassemble, or attempt to repair the battery.



**Danger** • Do not crush/puncture the battery, or short the external contacts.



**Danger** • Do not expose to excessive heat or liquids.



**Danger** • Do not drop the battery or expose to strong shocks or vibrations.



**Danger** • Always store the battery in a cool, dry place.



**Danger** • Do not use the battery if damaged.

Follow the steps to install the transmitter battery:

1. Open the battery compartment.
2. Insert 4 fully-charged AA batteries into the compartment. Make sure that the batteries are inserted in the correct polarity and make good contact with the battery compartment's contacts.
3. Replace the battery compartment cover.

### 3.2 Connecting the Receiver and Servos

Connect the receiver and the servos as indicated below:

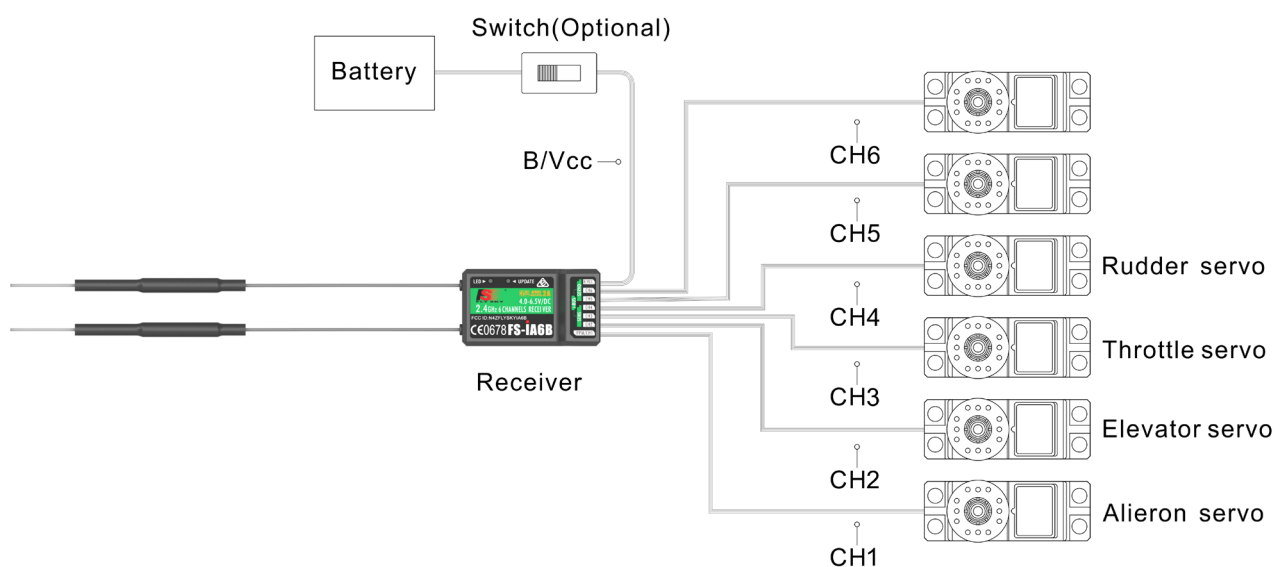

## 4. Operation Instructions

After setting up, follow the instructions below to operate the system.

### 4.1 Power On

Follow the steps below to turn on the system:

1. Check the system and make sure that:
  - The batteries are fully charged and installed properly.
  - The receiver is off and correctly installed.
2. Hold the power buttons until screen lights up.
3. Connect the receiver power supply to the **B/VCC** port on the receiver.

The system is now powered on. Operate with caution, or serious injury could result.

### 4.2 Binding

The transmitter and receiver have been pre-bound before delivery. If you are using another transmitter or receiver, follow the steps below to bind the transmitter and receiver:

1. Turn the transmitter on, press , and scroll down and then select [**RX bind**].
2. Connect the bind cable to the **B/VCC** port of the receiver.
3. Connect the power to any other port. The indicator will start to flash, indicating that the receiver is in bind mode.
4. Remove the bind and power cable from the receiver. Then connect the power cable to the **B/VCC** port.
5. Check the servos' operation. If anything does not work as expected, restart this procedure from the beginning.

### 4.3 Pre-use Check

Before operation, perform the following steps to check the system:

1. Check to make sure that all servos and motors are working as expected.
2. Check operating distance: one operator holds the transmitter, and another one moves the model away from the transmitter. Check the model and mark the distance from where the model starts to lose control.

---

 **Danger** • Stop operation if any abnormal activity is observed.

---

 **Danger** • Make sure the model does not go out of range.

---

 **Attention** • Sources of interference may affect signal quality.

---

## 4.4 Power Off

Follow the steps below to turn off the system:

1. Disconnect the receiver power.
2. Hold the transmitter's power buttons to turn off the transmitter.



**Danger**

- **Make sure to disconnect the receiver power before turning off the transmitter. Failure to do so may lead to damage or serious injury.**
-

## 5. Home Screen

The home screen displays useful information about your model, including timers, fly mode and TX/RX status.

**Start Page**

Timers + Timer Menu

T1 00:00:00 TX 

T2 00:00:00 RX 

FLY MODE :

1 Mode01

1500 ... 

TX/RX Battery Status +  
Battery Setup Menu

Main Menu

Fly Mode Status + Fly Mode Setup Menu

Press and hold the screen to preform a servo test.

Note: Make sure that the the engines are turned off/disconnected during this test. Failure to do so could lead to harm to yourself or others.



### Display Servos

Ch1				
Ch2				
Ch3				
Ch4				
Ch5				
Ch6				
...				

### Display Sensors

Name	ID	Value
...		

The system's navigation is designed to be easy and quick.

- To change home screen page, use your finger to swipe from left to right to view the the channels screen or right to left to view the sensors screen.
- To enter the main menu, press the  icon. Then use your finger to swipe up or down on the screen to scroll.
- To enter a function, touch its name.
- To navigate function menu, swipe up or down to scroll and press an item on the list to enter it.
- To go back to a previous menu, press the  icon.

## 5.1 Fly Mode

This mode can store settings that can be recalled by toggling a switch.

There are several options available:

- A: Stores the channel used by the flight controller.
  - 1. Touch the box to the right of the desired channel.
  - 2. Select the correct decimal and use the up and down arrow keys.
  - 3. Press the ✓ or ✗ to confirm or cancel changes.
- B: Stores the first selected activation switch.
- C: Stores the second selected activation switch.
- D: This number represents the currently selected mode. The name beside the mode number can be changed.
  - 1. Touch the box.
  - 2. Use the onscreen keyboard to enter a new name.
  - 3. Select the ← icon to save and return to the previous menu.
- E: Changes the sensitivity or range of throttle available for each motor.
  - 1. Touch the box to the right of the desired channel.
  - 2. Select the correct decimal and use the up and down arrow keys.
  - 3. Press the ✓ or ✗ to confirm or cancel changes.

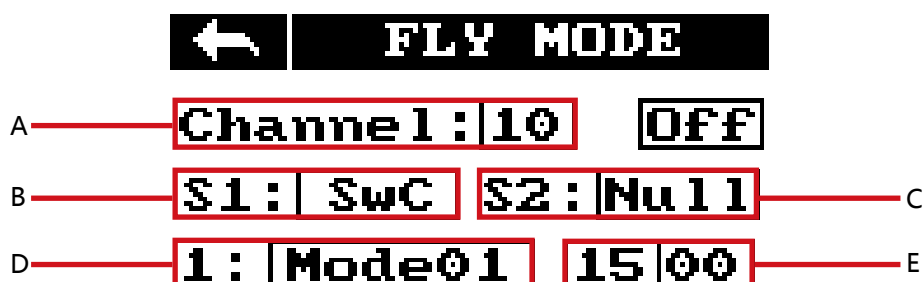

Assigning modes to switches.

Which modes are available are determined by which switches are assigned. If assigned to a single 2 position switch you will have access to modes 1 and 2 but if assigned to two 2 position switches you will have access to 4 modes. To have access to all 9 modes use the two 3 position switches together.

To cycles through all 9 modes sequentially see the table below:

SwB Postion	SwC Position	Mode
Up	Up	1
Up	Middle	2
Up	Down	3
Middle	Down	4
Middle	Middle	5
Middle	Up	6
Down	Up	7
Down	Middle	8
Down	Down	9

## 5.2 Timers

To enter the timer function touch T1/T2 on the main screen. The system has 2 timers available, both can be assigned to a switch and have 3 different settings.

Setup:

1. Select a mode.

Modes:

- Up: The up timer starts from zero and counts up.
  - Down: The down timer starts from a pre selected time and counts down.
  - D/U(Down then up): The D/U timer starts from the set time, and counts down to 0, then counts back up.
2. If necessary set up the pre defined time by selecting the "Setup" option. Select the correct decimal and use the onscreen arrow keys to change the value.



## 6. Function Settings

### 6.1 Reverse Function

The reverse function changes a channels direction of movement in relation to its input. For example, if the blades are spinning in the wrong direction, pushing the model into the ground instead of taking off, this function can be used to correct this.

←	REVERSE			
Ch1	Nor	Ch2	Nor	
Ch3	Nor	Ch4	Nor	
Ch5	Rev	Ch6	Nor	
Ch7	Rev	Ch8	Nor	
Ch9	Nor	Ch10	Nor	

Setup:

To change between normal and reverse touch the box to the right side of the desired channel.

Nor = Normal, Rev = Reverse.

Select the  icon to save and return to the previous menu.

### 6.2 Endpoints Function

The endpoint function changes the range of movement available to a channel. This can be used to limit the tilt of the model, so that it is easier to control.



The left box is the low endpoint, the right box is the high endpoint, marked below as low being blue and red being high.

Ch1 100% 100%

To change an endpoint:

1. Touch the low or high endpoint box.
2. Touch the desired decimal to change then use the onscreen up and down arrows to change the value.



3. Press the  or  to confirm or cancel changes.
4. Select the  icon to save and return to the previous menu.

←	ENDPOINTS	
Ch1	100%	100%
Ch2	100%	100%
Ch3	100%	100%
Ch4	100%	100%
Ch5	100%	100%

### 6.3 Subtrim Function

Subtrim changes the center point of the channel. For example, if a model is always drifting to one side, the sub trim can be used to fix this.

To set the subtrim function:



To change the subtrim:

1. Touch the box to the right of the desired channel.

Ch1 0%

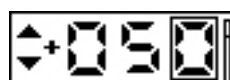
2. Select the correct decimal and use the up and down arrow keys.



3. Press the  or  to confirm or cancel changes.
4. Select the  icon to save and return to the previous menu.

## 6.4 Aux. Channels

The auxiliary channels can be used to control additional part of a model such as landing gear or lights.

1. Select channels using the left or right arrow keys on the screen on either side of the channel name.



2. The left box below the channel name allows the user to pick the type of control for that channel, Nul, VRx, Stx, KEY and SWx.

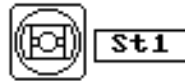

3. Select the  icon to save and return to the previous menu.

### Note:

- If the channel is in use for a fly mode, the system will inform the user and prevent any changes to that channel.

## 6.5 Mix

The mix function creates a mix between 2 different channels. For example, it is possible to make a mix between rudder and ailerons, so whenever the model rolls, the rudder will move automatically to perform a turn.

Note: In order to make changes to the mix it must first be disabled.

**Mix**  OFF

- Master: This channel will control the slave.

**Master**

- Slave: This channel is controlled by the master.

**Slave**

- offset: Offset works like trim or sub trim allowing for the centre position of the slave channel to be changed.

**Offset**

- Pos: Changes how much the slave will move in relation to the master in a positive movement. At 50% when the master moves to 100% of its positive motion, the slave will move to positive 50%.

**Pos**

- Neg: Changes how much the slave will move in relation to the master in a negative movement. At 50% when the master moves to 100% of its negative motion, the slave will move to negative 50%.

**Neg**

Setup:

1. If the mix is not already disabled turn it off by touching the box labeled "on".
2. Select a master by touching the box to the right of the master channel and choose a channel from the list.
3. Select a slave by touching the box to the right of the slave channel, then choose a channel from the list.
4. If needed, set an offset on the slave channel. Select the box to the right of the offset function, select the correct decimal and use the up and down arrow keys to change the value. Press the ✓ or ✗ to confirm or cancel changes.
5. Set the positive ratio using the box to the right of "pos", select the correct decimal and use the up and down arrow keys to change the value. Press the ✓ or ✗ to confirm or cancel changes.
6. Set the negative ratio using the box to the right of "neg", select the correct decimal and use the up and down arrow keys to change the value. Press the ✓ or ✗ to confirm or cancel changes.
7. Once all changes have been made toggle the function to on by touching the box to the right of "Mix".
8. Select the  icon to save and return to the previous menu.

## 6.6 Failsafe Function

The failsafe function enables you to pre-set channel positions for the receiver in case of signal loss.

Setup:

1. To setup a failsafe position on a channel, select the channel from the list, to select the channel touch the box to the right of the channel name.
2. The box next to the channel name should display "On", to activate the failsafe touch the box. The box should now display "Off"
3. Move and hold the channel at the desired position, then while keeping the channel at the desired value touch the setup box.

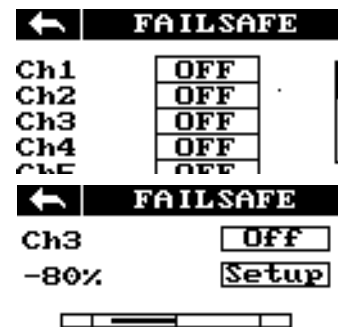

Set all:

It is possible to set all the channels at the same time, to do so first turn all the channels on as stated above, hold all the channels in the desired position and select "Set all" at the bottom of the list. The system will prompt for a confirmation, select "Y" for yes.

To Reset all channels, select the "Reset all" option.

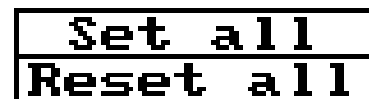

Select the  icon to save and return to the previous menu.

## 6.7 Bri./Sound

This function controls screen brightness and volume for the system.

To make changes to brightness or volume touch and drag the black box located within the relevant slider. Then select the  icon to save and return to the previous menu.

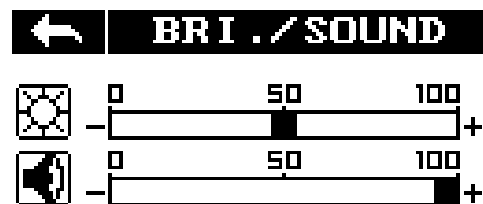

## 6.8 Output Mode

The system has two output modes, PWM and PPM.

To change between the modes touch the desired mode, the currently selected mode will have a black dot within the circle beside it.

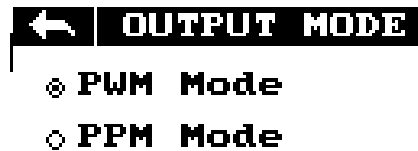

Select the  icon to save and return to the previous menu.

## 6.9 Stick Mode

The system has 4 stick modes to change from, to change the mode touch M1, 2, 3 or 4 on the right hand side of the screen. The currently selected mode is highlighted in black.

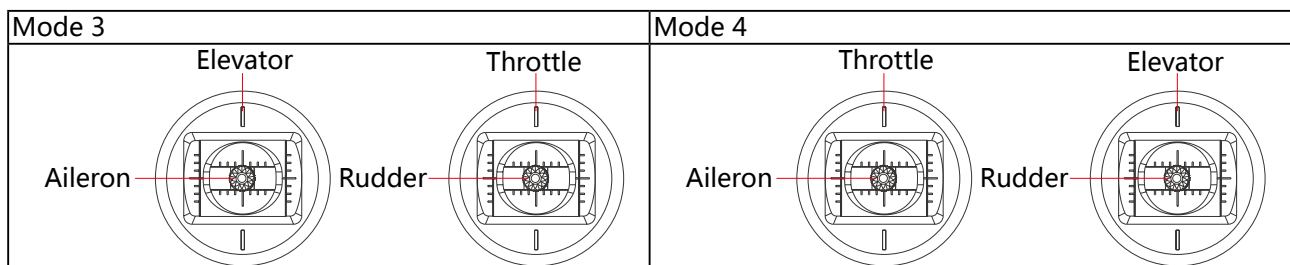
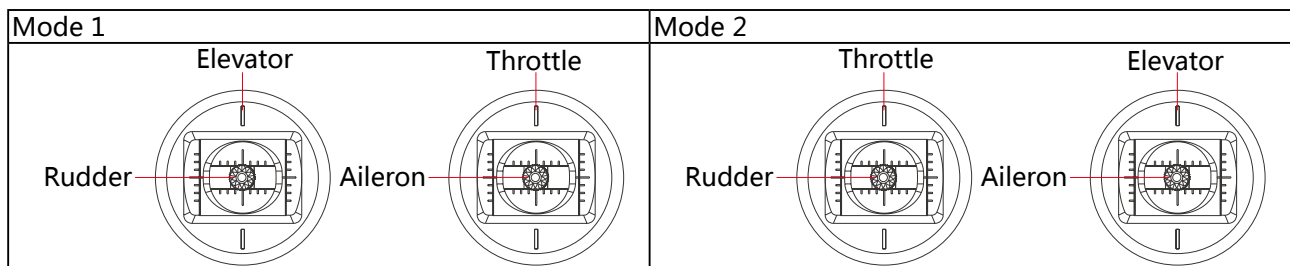

## 6.10 Factory Reset

This function resets all settings back to default. To reset the system touch "Factory Reset" in the main menu then when prompted touch "Y" for yes.

Note: Once reset all user settings will be lost.

## 6.11 Firmware Update

To update the systems firmware:

1. Download the latest firmware from [www.flysky-cn.com](http://www.flysky-cn.com).
2. Open the firmware update on a computer and connect the system via usb cable.
3. Select "Firmware Update" from the systems function menu. The system will show a prompt, "This will enter firmware update mode and halt other functions" with an option to continue, select "Y". When in update mode the screen will turn off.
4. Once the system has been recognised by the computer select the update button at the bottom of the firmware update software.

Once the system has been updated it will restart. Once the system has restarted it is safe to remove the USB cable.

## 6.12 About FS-i6S

This menu shows the product name, firmware version, firmware release date.

## 7. Product Specification





### 7.1 Transmitter Specification (FS-i6S)

Channels	10
Model type	Quadcopter
RF range	2.4055 ~ 2.475 GHz
Bandwidth	500 KHz
Band	140
RF power	Less then 20 dBm
2.4G system	AFHDS 2A
Code type	GFSK
Sensitivity	4096
Low voltage alarm	Yes (lower than 4.2V)
PS2/USB Port	Yes
Power input	4.2V - 6.0V
Antenna length	26 mm*2
Weight	410g
Dimension (Length x Width x Height)	179mm x 81mm x 161mm
Color	White/Black
Certificate	CE0678, FCC

### 7.2 Receiver Specification (FS-iA6B)

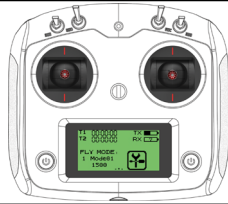
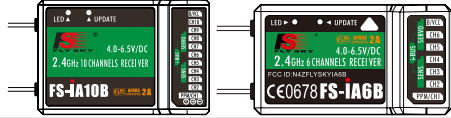
Channels	6
Model type	Quadcopter/Fixed-wing/Helicopter
RF range	2.4055 ~ 2.475 GHz
Band	140
RX sensitivity	-105dBm
2.4G system	AFHDS 2A
Code type	GFSK
Power input	4.0V - 6.5 V DC
Weight	14.9 g
Antenna length	26 mm*2
Dimension (Length x Width x Height)	47mm x 26.2mm x 15 mm
Color	Black
Certificate	CE0678, FCC
i-Bus port	Yes
Data acquisition port	Yes

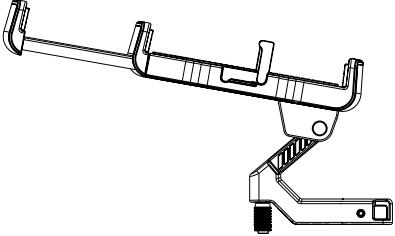
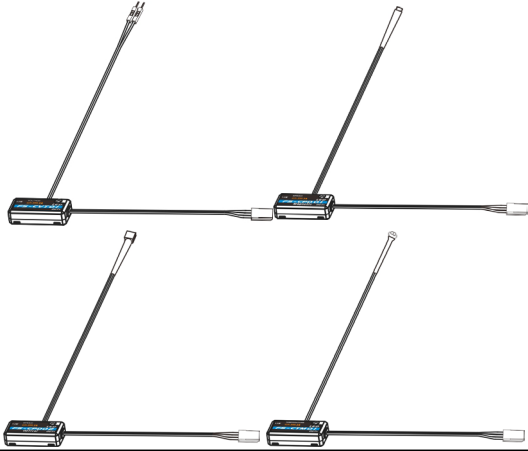
## 8. Package Contents

Product	Quantity	
FS-i6S	1	
FS-iA6B or FS-iA10B	1	
Micro USB Cable	1	
Mobile Phone Holder	(Optional)	
Sensors: <ul style="list-style-type: none"> <li>• FS-CPD01</li> <li>• FS-CPD02</li> <li>• FS-CTM01</li> <li>• FS-CVT01</li> </ul>	(Optional)	
User Manual	1	

## 9. Appendix 1 FCC Statement

This equipment has been tested and found to comply with the limits for a Class B digital device pursuant to part 15 of the FCC rules. These limits are designed to provide reasonable protection against harmful interference in a residential installation. This equipment generates, uses and can radiate radio frequency energy and, if not installed and used in accordance with the instructions, may cause harmful interference to radio communications. However, there is no guarantee that interference will not occur in a particular installation. If this equipment does cause harmful interference to radio or television reception, which can be determined by turning the equipment off and on, the user is encouraged to try to correct the interference by one or more of the following measures:

- Reorient or relocate the receiving antenna.
- Increase the separation between the equipment and receiver.
- Connect the equipment into an outlet on a circuit different from that to which the receiver is connected.
- Consult the dealer or an experienced radio/TV technician for help.

To assure continued compliance, any changes or modifications not expressly approved by the party responsible for compliance could void the user's authority to operate this equipment. (Example use only shielded interface cables when connecting to computer or peripheral devices).

This equipment complies with Part 15 of the FCC Rules. Operation is subject to the following two conditions:

- (1) This device may not cause harmful interference, and
- (2) This device must accept any interference received, including interference that may cause undesired operation.

### Caution!

The manufacturer is not responsible for any radio or TV interference caused by unauthorized modifications to this equipment. Such modifications could void the user authority to operate the equipment.

The antenna(s) used for this transmitter must be installed to provide a separation distance of at least 20 cm from all persons and must not be co-located or operating in conjunction with any other antenna or transmitter.





**Digital proportional radio control system**

**CE 0678 FC**

<http://www.flysky-cn.com>

Copyright ©2013-2017 Flysky RC model technology co., ltd

Edition: 2015-9-1