

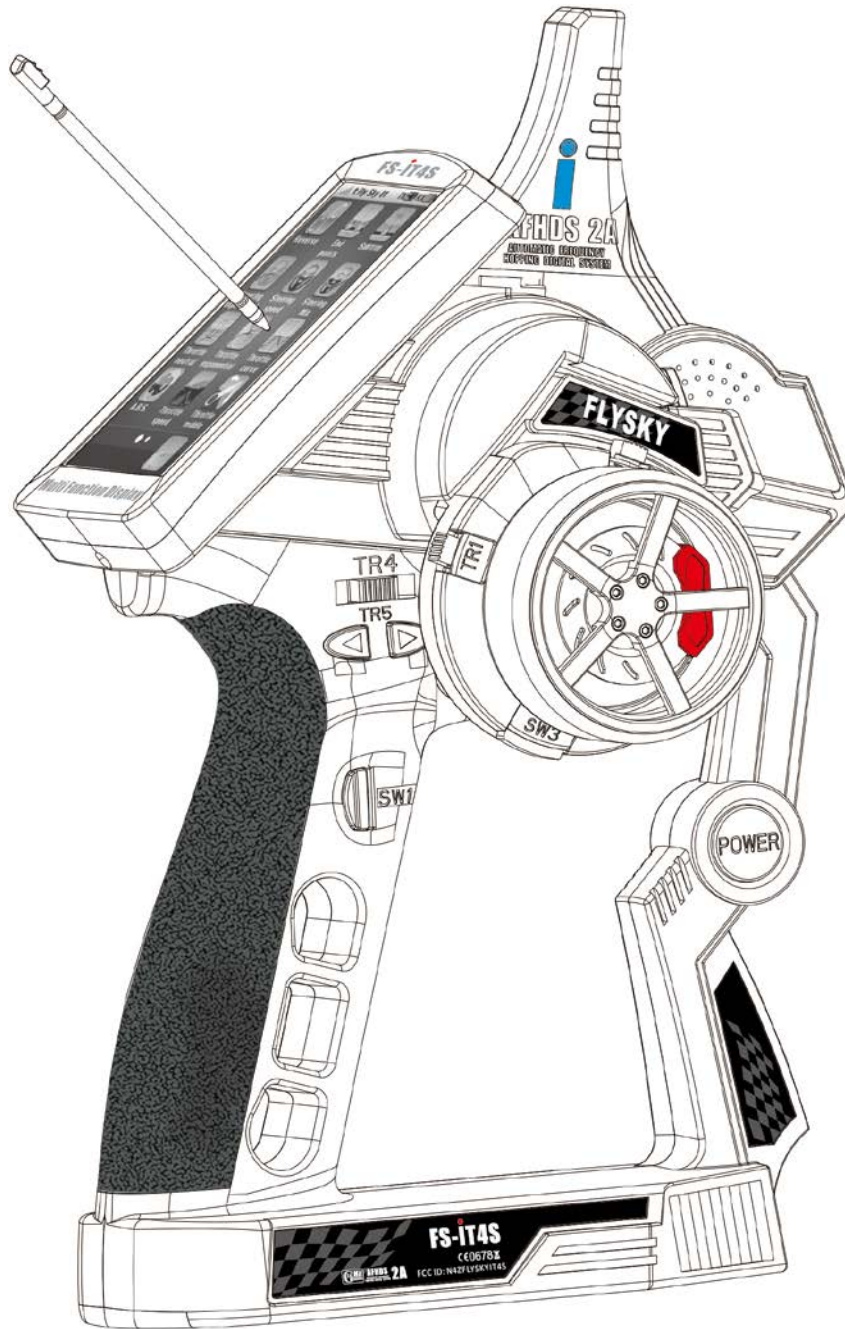

FS-IT4S

Digital proportional radio control system

INSTRUCTION MANUAL



CE 0678 FC



AFHDS 2A
AUTOMATIC FREQUENCY
HOPPING DIGITAL SYSTEM

WARNING:

This product is only for 15 years old or above





Thank you for purchasing our product, an ideal radio system for beginners or experienced users alike.

Read this manual carefully before operation in order to ensure your safety, and the safety of others or the safe operation of your system.

If you encounter any problem during use, refer to this manual first. If the problem persists, contact your local dealer or visit our service and support website for help:

www.flysky-cn.com/service.asp

Table of contents

1. Safety	4
1.1 Safety Symbols	4
1.2 Safety Guide.....	4
2. Introduction	6
2.1 System Features.....	6
2.3 Transmitter Overview	7
2.3.1 Transmitter Antenna	7
2.3.2 Wheel and Trigger	7
2.3.3 Status Indicator	8
2.3.4 Trims	8
2.4 Receiver Overview	8
2.4.1 Receiver Antenna	8
2.4.2 Status Indicator	8
2.4.3 Connectors	8
3. Getting Started	9
3.1 Transmitter Battery Installation.....	9
3.2 Connecting the Receiver and Servos	9
4. Operation Instructions	11
4.1 Power On	11
4.2 Binding.....	11
4.3 Pre-use Check	11
4.4 Adjusting Wheel Position	12
4.5 Adjusting Wheel Position Stiffness	12
4.6 Trims	12
4.7 Power Off	12
5. Home Screen	13
6 Reverse Function	14
6.1 End Points Function	14
6.2 Subtrim Function	14
6.2 Steering Exponential	15
6.3 Steering Speed.....	16
6.4 Steering Mix.....	16
6.5 Throttle Neutral.....	17
6.6 Throttle Exponential.....	18
6.7 Throttle Curve	18
6.8 A.B.S.....	19
6.9 Throttle Speed	21
7 Throttle Middle	22
7.1 Throttle Idel Up.....	22
7.2 Engine Cut	22
7.3 Boat Mode.....	23
7.4 Break Mixing	23
7.5 Mixes	23



7.6 Display Servos.....	24
7.7 Race Timer.....	24
7.8 Keys Function.....	25
7.9 Models.....	25
8.0 RX Setup.....	27
8.1 Bind with a receiver.....	27
8.2 RF std.: ADHDS 2A 2-way.....	27
8.3 Receiver PPM Output.....	27
8.4 RX Battery Monitor.....	28
8.5 Low Signal Alarm.....	28
8.6 FailSafe.....	28
8.7 Display Sensors.....	28
8.8 Choose Sensors.....	29
8.9 Speed and Distance.....	29
9 i-Bus Setup.....	30
9.1 Servos frequency.....	30
9.2 Range Test.....	30
10.0 System.....	31
10.1 Backlight Timeout: (Time).....	31
10.2 Backlight: (%).....	31
10.3 System Sound.....	31
10.4 Alarm Sound.....	31
10.5 Auto Power Off.....	31
10.6 Screen Calibration.....	31
10.7 Units.....	32
10.8 USB Function.....	32
10.9 Firmware Update.....	32
11 Product Specification.....	33
11.1 Transmitter Specification.....	33
11.2 Receiver Specification.....	33
Appendix 1 FCC Statement.....	34

1. Safety

1.1 Safety Symbols

Pay close attention to the following symbols and their meanings. Failure to follow these warnings could cause damage, injury or death.

 **Danger** • Not following these instructions may lead to serious injuries or death.

 **Warning** • Not following these instructions may lead to major injuries.

 **Attention** • Not following these instructions may lead to minor injuries.

1.2 Safety Guide



Prohibited



Mandatory



- **Do not fly at night or in bad weather like rain or thunderstorm. It can cause erratic operation or loss of control.**
- **Do not use the product when the visibility is limited.**
- **Do not use the product on rainy or snowy days. Should any type of moisture (water or snow) enter any component of the system, erratic operation and loss of control may occur.**
- **Interference could cause loss of control. To ensure the safety of you and others, do not operate in the following places:**
 - Near any site where other radio control activity may occur
 - Near high tension power lines or communication broadcasting antennas
 - Near people or roads
 - On any pond when passenger boats are present
- **Do not use this product when you are tired, uncomfortable, or under the influence of alcohol or drugs. It may cause serious injury to yourself as well as others.**
- **The 2.4GHz radio band is completely different from the previously used lower frequency bands. Always keep your model in sight as a large object can block the RF signal and lead to loss of control.**
- **Never grip the transmitter antenna when operating a model. It significantly degrades the RF signal quality and strength and may cause loss of control.**
- **Do not touch any part of the model that generates heat during operating or immediately after use, like the engine, motor, or speed control. These parts may be very hot and can cause serious burns.**



- **Misuse of this product can lead to serious injuries or death. To ensure the safety of you and your equipment, read this manual and follow the instructions.**
- **Make sure the product is properly installed in your model. Failure to do so may result in serious injury.**
- **Make sure to disconnect the receiver battery before turning off the transmitter. Failure to do so may lead to unintended operation and cause an accident.**
- **Ensure that all motors operate in the correct direction. If not, adjust the direction first.**
- **Make sure the model flies within a certain distance. Otherwise, it would cause loss of control.**

2. Introduction

The FS-iT4S is an 8-channel 2.4GHz AFHDS 2A digital proportional R/C system. It is compatible with cars and boats.

2.1 System Features

The AFHDS 2A (Automatic Frequency Hopping Digital System Second Generation) developed and patented by FLYSKY is specially developed for all radio control models. Offering superior protection against interference while maintaining lower power consumption and high reliable receiver sensitivity, FLYSKY's AFHDS technology is considered to be one of the leaders in the RC market today.



Bidirectional Communication

Capable of sending and receiving data, each transmitter is capable of receiving data from temperature, altitude and many other types of sensors, servo calibration and i-BUS Support.

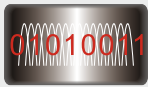

Multi-channel Hopping Frequency

This systems bandwidth ranges from 2.4055GHz to 2.475GHz. This band is divided in 140 channels. Each transmitter hops between 16 channels (32 for Japanese and Korean versions) in order to reduce interference from other transmitters.



Omni-directional Gain Antenna

The high efficiency Omni-directional high gain antenna cuts down on interference, while using less power and maintaining a strong reliable connection.



Unique ID Recognition System

Each transmitter and receiver has it's own unique ID. Once the transmitter and receiver have been paired, they will only communicate with each other, preventing other systems accidentally connecting to or interfering with the systems operation.



Low Power Consumption

The system is built using highly sensitive low power consumption components, maintaining high receiver sensitivity, while consuming as little as one tenth the power of a standard FM system, dramatically extending battery life.

2.3 Transmitter Overview

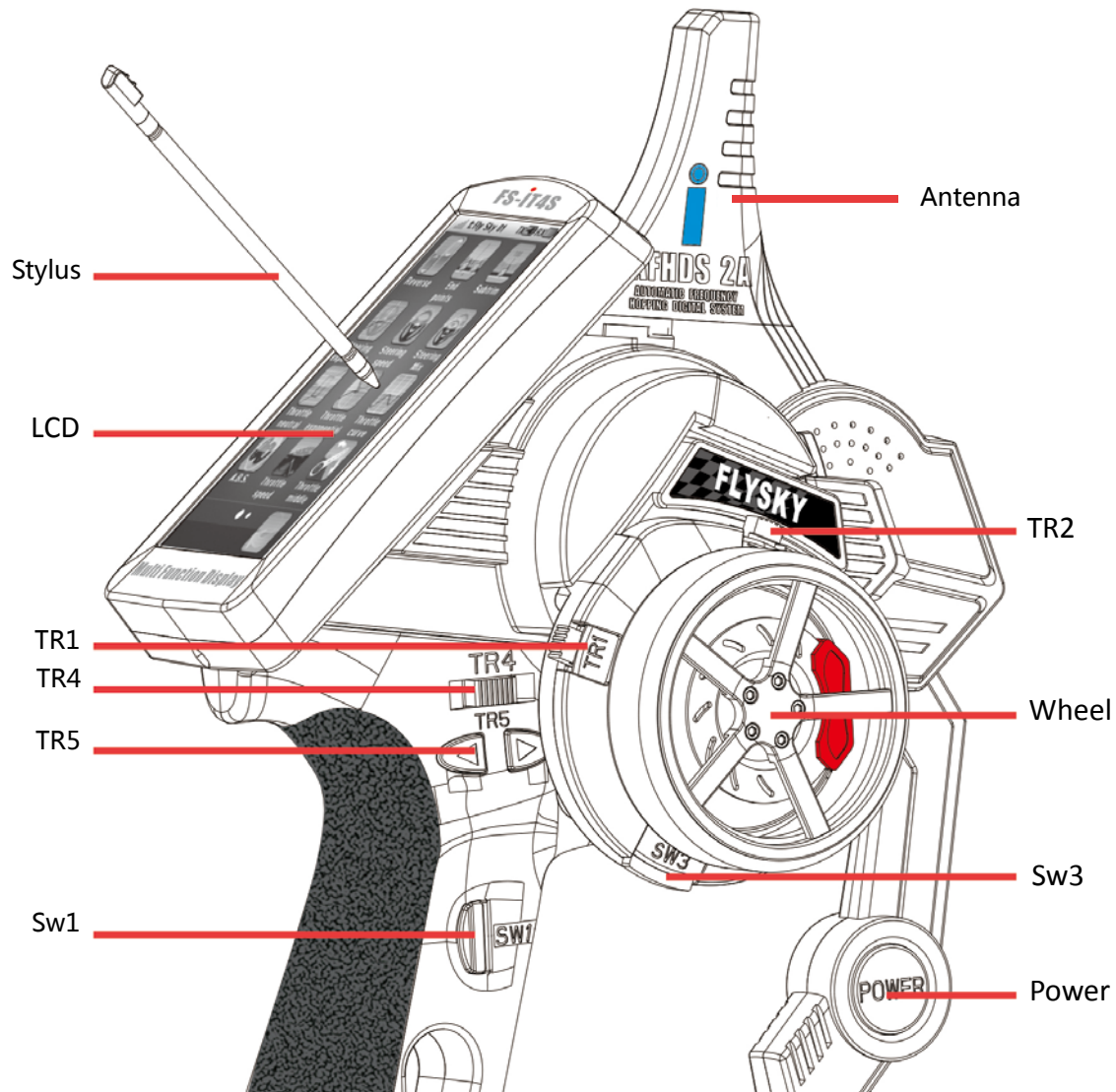

2.3.1 Transmitter Antenna

Precautions:

- For best signal quality, make sure that the antenna is at about a 90 degree angle to the model. Do not point the antenna directly at the receiver.
- Never grip the transmitter antenna when operating a model. It significantly degrades the RF signal quality and strength and may cause loss of control.

2.3.2 Wheel and Trigger

The FS-iT4S has two main control inputs, the wheel and trigger.

- Wheel: Steering, use to control the direction of the model.
- Trigger: Used for acceleration, breaking and reverse.

2.3.3 Status Indicator

The status indicator is used to indicate the power and working status of the transmitter.

- Off: the transmitter is powered off.
- Blue light: the transmitter is on and working.
- Flashing: the transmitter is binding.

2.3.4 Trims

There are 4 trims affecting surface functionality, one for throttle, steering, reverse and . Each time a trim is toggled, the trim will move one step. It is possible to make quicker trim adjustments by holding the trim in the desired direction. When the trim position reaches the middle, the transmitter beeps in a higher tone.

2.4 Receiver Overview

2.4.1 Receiver Antenna



Attention

- **For best signal quality, ensure that the receiver is mounted away from motors or metal parts. Also make sure that the antennas are mounted at a 90 degree angle to each other.**
-

2.4.2 Status Indicator

The status indicator is used to indicate the power status of the receiver.

- Off: the power is not connected.
- Lit in red: the receiver is on and working.
- Flashing quickly: the receiver is binding.
- Flashing slowly: the bound transmitter is off.

2.4.3 Connectors

The connectors are used to connect the parts of model and the receiver.

- CH1 to CH4 connectors are used to connect the servos, power or other parts.
- B/PPM connector is used to connect the bind cable for binding.

3. Getting Started

Before operation, install the battery and connect the system as instructed below.

3.1 Transmitter Battery Installation

⚠ Danger • Only use specified battery.

⚠ Danger • Do not open, disassemble, or attempt to repair the battery.

⚠ Danger • Do not crush/puncture the battery, or short the external contacts.

⚠ Danger • Do not expose to excessive heat or liquids.

Follow the steps to install the transmitter battery:

1. Open the battery compartment.
2. Insert a fully-charged battery into the compartment. Make sure that the battery makes good contact with the battery compartment's contacts.
3. Replace the battery compartment cover.

3.2 Connecting the Receiver and Servos

Connect the receiver and the servos as indicated below:

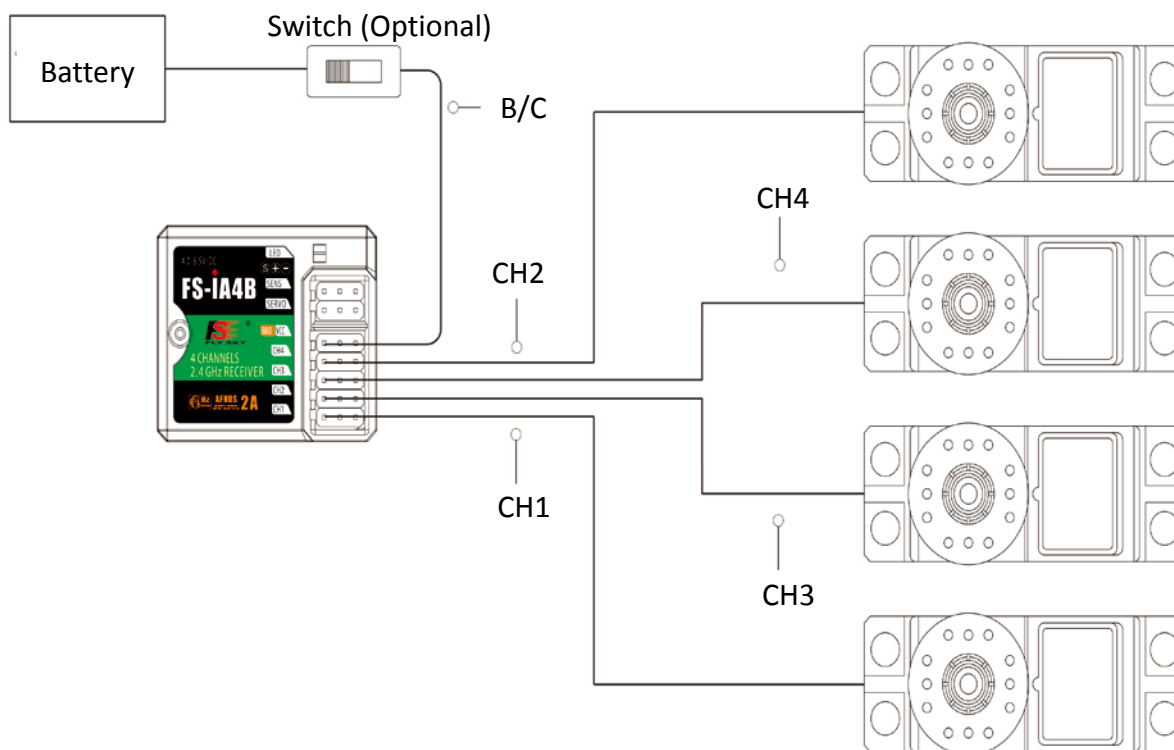

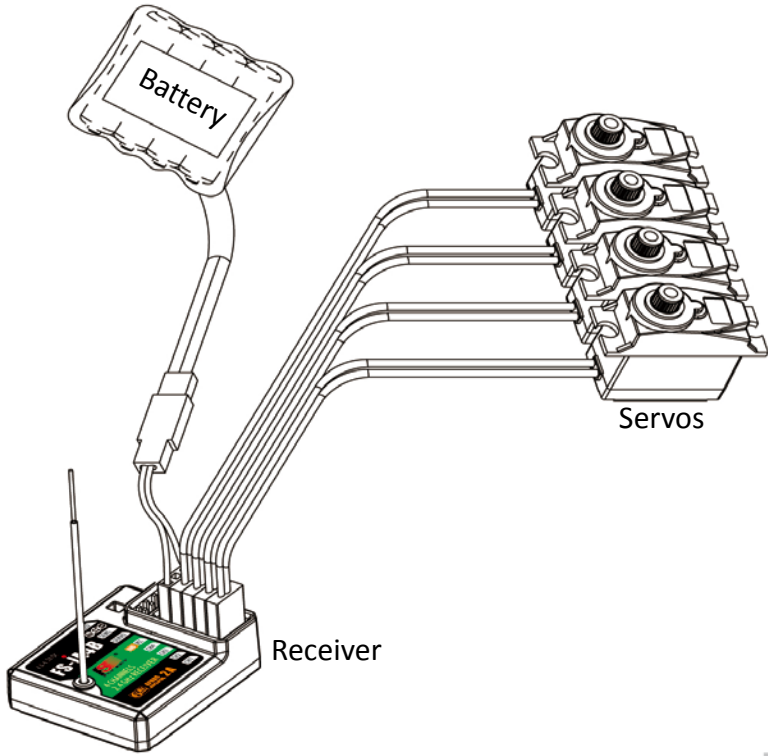



4. Operation Instructions

After setting up, follow the instructions below to operate the system.

4.1 Power On



Follow the steps below to turn on the system:

1. Check the system and make sure that:
 - The battery is fully charged and installed properly.
 - The receiver is correctly installed.
2. Hold the power button until screen lights up.
3. Connect the receiver power supply.

The system is start now. Operate with caution, or serious injury could result.

4.2 Binding

The transmitter and receiver have been pre-bound before delivery. If you are using another transmitter or receiver, follow the steps below to bind the transmitter and receiver:

1. Make sure a battery is installed in the transmitter and that the transmitter is turned off.
2. Connect the bind cable to the B/PPM connector of the receiver.
3. Connect the power to any of the CH1 to CH4 connectors. The indicator will start to flash, indicating that the receiver is in binding mode.
4. Turn the transmitter on and navigate to **[RX Setup]**  by pressing  and swiping from right to left on the screen and selecting the RX setup icon. Select **[Bind with a receiver]** and press yes to enter bind mode.
5. On the receiver, connect the bind cable into the bind port and connect the power. Once the binding is complete the transmitter should exit the bind menu automatically (Note: This only applies to two-way communication protocols).
6. Remove the bind cable from the receiver.
7. Check if all the servos work as expected. If anything is doesn't work as expected, restart this procedure from the beginning.

4.3 Pre-use Check

Before operation, perform the following steps to check the system:

1. Check to make sure that all servos and motors are working as expected
2. Check operating distance distance: one operator holds the transmitter, and another one moves the model away from the transmitter. Check the model and mark the distance from where the model starts to lose control. (Note: Sources of interference may affect signal quality)



Danger • **Stop operation if any abnormal activity is observed.**



Danger • **Make sure the model flies within the safe distance.**

4.4 Adjusting Wheel Position

The position of the wheel can be adjusted to be more comfortable to use.

1. Hold the transmitters handle firmly.
2. Grab the plastic underneath the wheel. (Do not pull the wheel itself as this could lead to long term wear and damage).
3. Rotate the wheel out and away from you to the desired position (Note: the max rotation is about 45°, attempting to push beyond the max rotation can cause damage to the transmitter).

Default Position

Fully Extended

4.5 Adjusting Wheel Position Stiffness

It is possible to adjust the stiffness so that the position of the wheel is easier or harder to move. To do this locate the allen head screw located below the mechanism, and use an allen key to change the stiffness (Clockwise to tighten).

4.6 Trims

Trims allow you to change the centre point of the steering, throttle, channel 3 and 4. An good example of this feature would be a model that always turns slightly left, in this case the steering trim can be used to correct the problem.

The System has 3 trim switches located behind the steering wheel.

4.7 Power Off

Follow the steps below to turn off the system:

1. Disconnect the receiver from the battery. (Do not power off your transmitter until the receiver has been powered off, as this may lead to loss of control.)
2. Slide the power switch of the transmitter down to the OFF position.



Danger



- **Make sure to disconnect the receiver battery before turning off the transmitter. Or it may lead to unintended operation and cause an accident.**

5. Home Screen

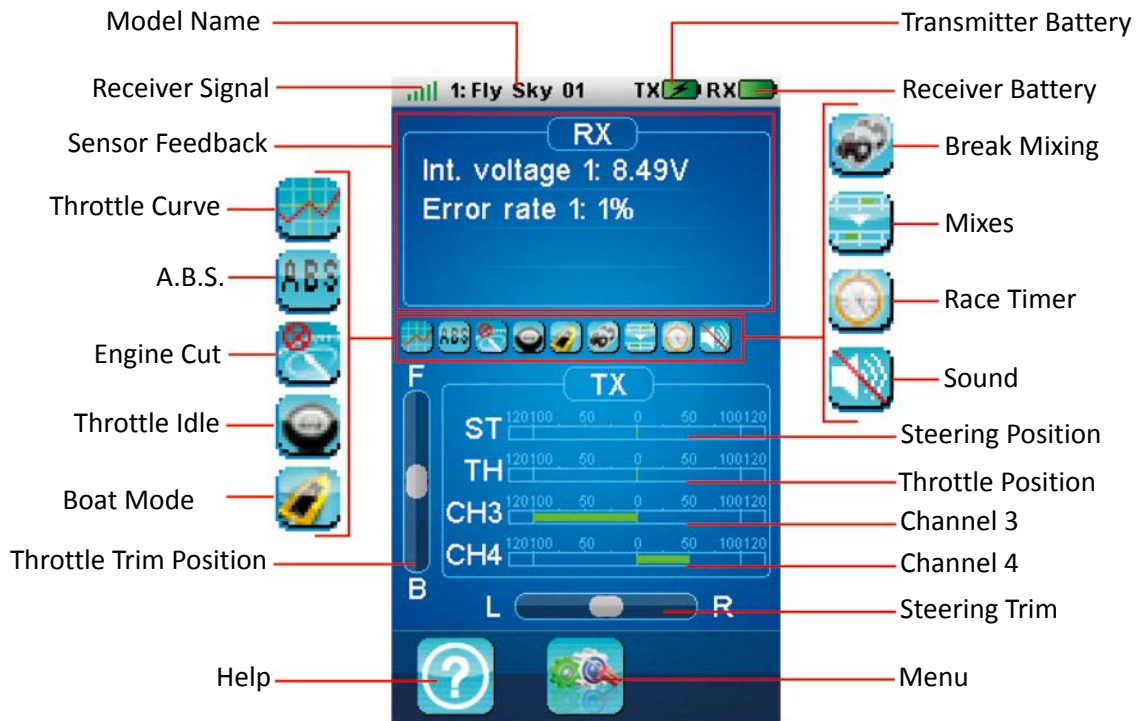
The home screen displays useful information about your model, including sensors, current active condition and timers.





The system's navigation is designed to be easy and quick, using both a stylus and fingers.

- To enter the main menu screen, press the  icon. Once the menu use your finger or stylus to swipe left to right on the screen to change page.
- To enter a function touch its corresponding icon. Navigate functions by swiping up and down to navigate lists and press an item on the list to select it.
- To go back to a previous menu press the  icon.

6 Reverse Function

The Reverse function is used to correct a servo or motor's direction in relation to the systems controls. For example if a servo is mounted upside down in order to fit inside a model (in this case steering), when the systems steering wheel is turned the servo will move in the opposite direction. To fix this all we need to do is reverse CH1.

- To reverse a channel, touch the channel in the list, when reversed the slider will be at the "REV".
- To reset the function to the default setting touch the  icon.
- To return to the main menu touch the  icon.

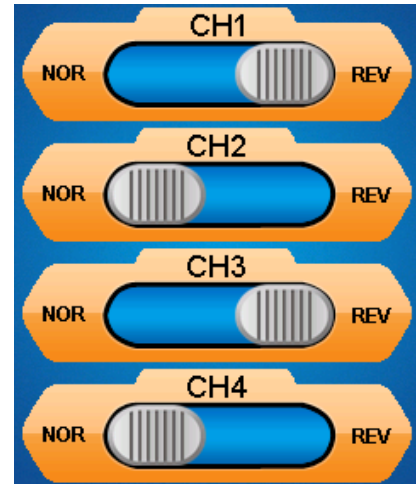

6.1 End Points Function

End points are the limits of the servos range of movement. There are 2 endpoints per channel, one is the low endpoint and one is the high endpoint.

To select an endpoint move the desired control surface in the direction you wish to change. The currently selected endpoint will be highlighted in yellow.

Once you have chosen an endpoint, touch the channel you wish to change.

At the top the current channel, selected endpoint and percentage are shown. The endpoints location is also shown as a bar and needle

To edit an endpoint's value drag the wheel at the bottom of the screen. Left to reduce the value and right to increase the value.

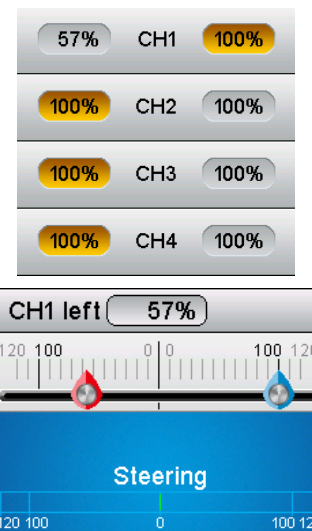

6.2 Subtrim Function

Subtrim changes the center point of the channel, for example if a car's wheels are slightly out of alignment the sub trim could be used to fix this.

To set the subtrim function:

1. Select the desired channel from the list.
2. Use the wheel at the bottom of the screen to change the value, a real time readout of the channels position can be seen in this menu as a green bar.
3. Select the back icon to return to the previous menu and save.

The sub trim has a value representing the current subtrim setting, followed by a graphic representation of the current trim position. Below the graphic there is a real time read out of the channels current position.

The method for changing settings in this function is the wheel located above the menu bar at the bottom.

- To restore default settings of a single channel, select the reset icon within its subtrim menu.
- To restore the entire function to default, select the reset icon in the channel selection menu.

Channel List	
CH1	-85
CH2	0
CH3	0
CH4	0

Subtrim setting and channel's current position



6.2 Steering Exponential

This function changes the response curve of the steering, there are 2 main parameters:

- Rate: Changes the outer limits of the steering, the default is 100%. Rate cannot be more than 100%.
- Exp.: Changes the steering curve, which changes the response of the steering wheel, the exp setting can be positive or negative. (Exponential)

Changes to the rate and exponential can be seen on the graph located in the center of the screen, the system also gives a real-time readout of the channels current position.

Changes to the rate and exponential can be seen on the graph, located in the center of the screen. The system also gives a real-time readout of the channels current position.

Note:

The system gives a real time readout of the channels position, not the wheels position. The wheel will not correlate with the graph if the rate is under 100% ,or another function like trim has made changes to the channels movement and/or outer.

By changing the steering curve we can make the wheel more or less sensitive in at different areas of its range of movement, for example, reducing sensitivity at the middle for more control when making fine adjustments.

This function must be set as active before use, to activate the function make sure that the icon in the bottom left corner is showing a tick, if there is no tick then press the icon to enable.

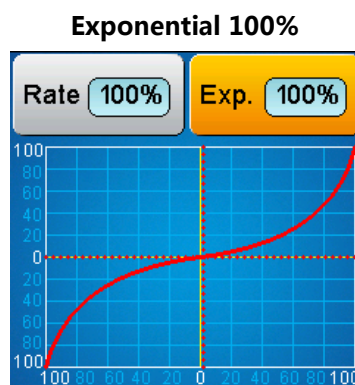
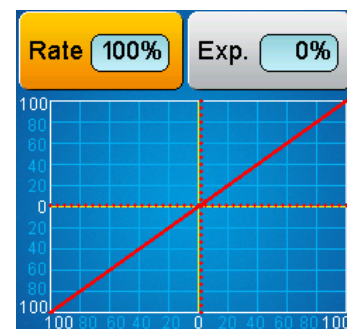

To set the steering exponential/rate:

1. Select the desired parameter, rate or exp.
2. Use the wheel at the bottom of the screen to change the value.

To restore the entire function to default, select the reset icon located at the bottom center of the screen.

This function can be toggled using a switch/button, this is assigned in the [Keys function].

To restore the entire function to default, select the reset icon located at the bottom center of the screen.

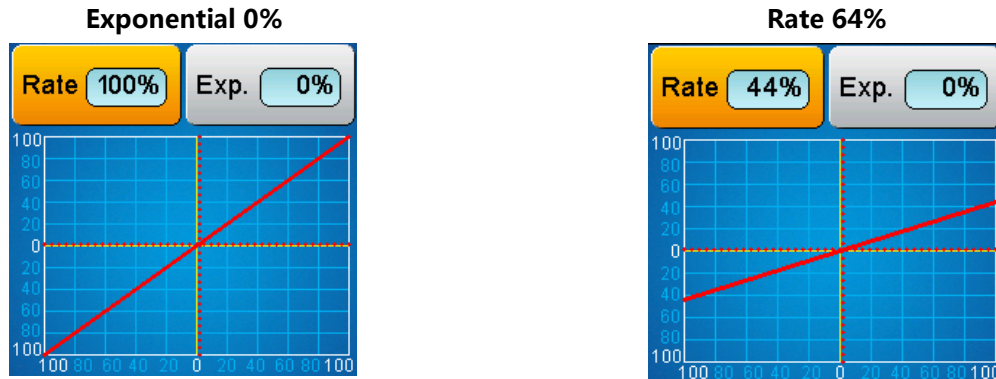

6.3 Steering Speed

This function changes the speed in which the steering travels, if the cars wheels are turning too fast, it could lead to loss of control, on the other hand if they don't change position fast enough the car will become sluggish and slow to make turns. This function is also used to simulate a realistic for scale models.

There are two variables:

Turn Speed: Sets how quickly the wheels turn from their starting position, to the position the systems controls indicates.

Return Speed: Sets how quickly the wheels turn back to their center position.

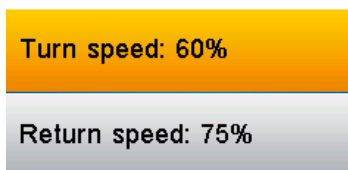

To set the steering speed:

1. Select a parameter to change.
2. Use the wheel at the bottom of the screen to change the value.

To restore the entire function to default, select the reset icon located at the bottom center of the screen.

6.4 Steering Mix

This function changes which wheels are involved in steering, front, rear, or 4 wheel steering. To enable this function select "crawler mode" from the functions main menu.

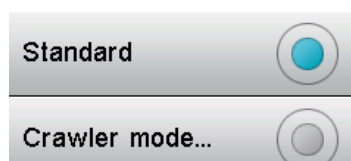

There are 4 types of steering control:

- Font side: Front wheel steering. (Default)
- Rear side: Rear wheel steering.
- Same phase: Front and rear steering at the same time, when turning a direction all the wheels will turn the same direction.
- Rev. phase (Reverse Phase): The front wheels and back wheels are both involved in the turning process however, the rear wheels will always turn the opposite direction to the front wheels.

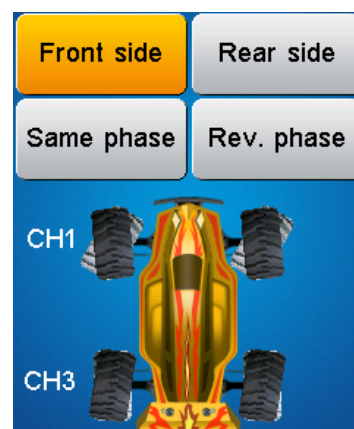

To set the steering mix:

Select the desired method of steering, the system shows a preview of the steering method on the screen in real-time when moving the system wheel.

To reset this function, select the reset icon located at the bottom middle of the screen.

6.5 Throttle Neutral

This function can set a “dead zone” for their throttle control, this means that the throttle will not function while still within the dead zone. It is also possible to set up the initial amount of throttle that will be applied when the throttle leaves the dead zone, although this can only be set for driving forward, not in reverse.

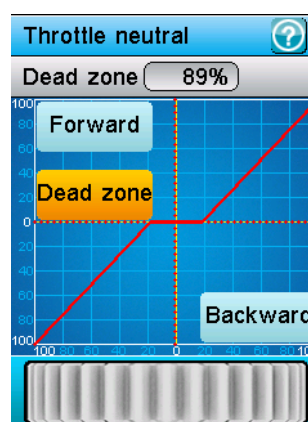

To set the throttle neutral:

- Dead zone
To setup the dead zone select the dead zone option at the left side of the screen, and use the wheel at the bottom of the screen to change the value. The current percentage will be shown above the graph, labeled as dead zone.
- Forward
First select [**Forward**], next move the wheel to set its value.

Once finished setting up these functions, press the back icon located at the bottom right of the screen to save.

6.6 Throttle Exponential

This function has two variables:

- Rate: Reducing the rate shrinks the outer limits of the curve, as the rate drops below 100% the graph will update in real-time. The maximum is 100%.
- Exp. (Exponential): Exponential adds curve, it is possible to move to +-100% creating opposite curves.

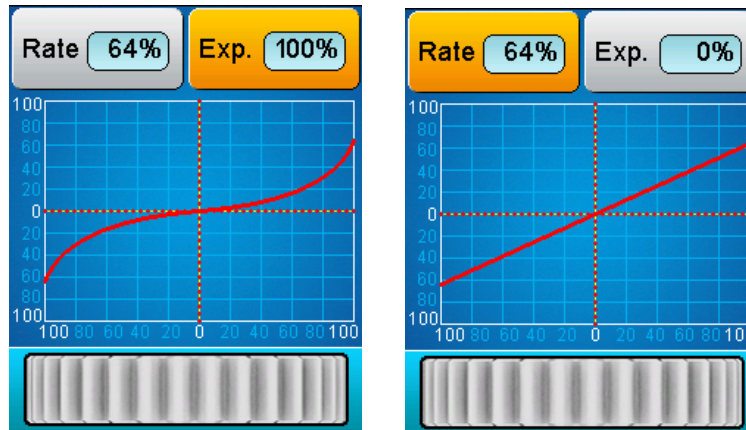

To reset this function select the standard steering mix from the functions main menu.

This function can be toggled using a switch/button, this is assigned in the "Keys function".

6.7 Throttle Curve

This function is used to add a curve to the throttle response, meaning that the throttle will respond differently throughout its range of movement.

This function must be activated and can be assigned to a button (See "Keys Function"). To activate this function press the icon located at the bottom left of the screen, once activated this icon should show a tick.

This function has 5 points that can be edited. To select a point simply touch the corresponding number (L is the lowest point and H is the highest point).

Once a point is selected use the wheel at the bottom of the screen to change its value, all changes will be shown in real-time on the graph, if the trigger is moved the graph will show the current throttle position.

To reset this function press the reset icon located at the middle bottom of the screen.

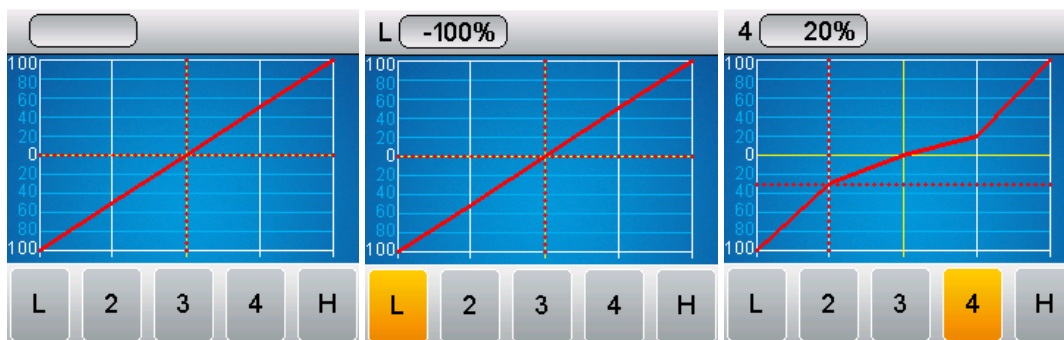



6.8 A.B.S.

A.B.S. stands for auto braking system, and is designed to stop the wheels from locking (which can lead to loss of control or a skid). A.B.S. manages this by regulating the amount of pressure the breaks use, this is done by pumping the breaks on and off rather than a constant force.

This function must be active to work, if the icon at the bottom left corner is not showing a tick, select it. When a tick is shown the function is active.

As a square wave, the peaks representing break on, and the drops break reduction.

Trigger point: Changes the point in which the A.B.S. will kick in. The trigger point is represented as a white line on the graph. To change the position of the trigger point use the wheel at the bottom of the screen.

Break return

Controls the amount the break will back off from full break, if set to 50 percent then when the breaks are active, the pulse will remove 50 percent of the breaks strength on each pulse.

Here the pulses are shown as a square wave, the peaks being break on, and drops being reduction in braking. As the break return function is edited the square wave will change to represent the current return value.

To edit this function simply use the wheel to change its value, as the value is changed the graph will show a new wave form in real time. To test apply the brakes, the graph should show another red waveform representing the current real-time effect. Below the graph is a bar that shows the braking position in real time, when this function is active and the break is applied the green bar will bounce, this is normal and is just showing the A.B.S. in action.

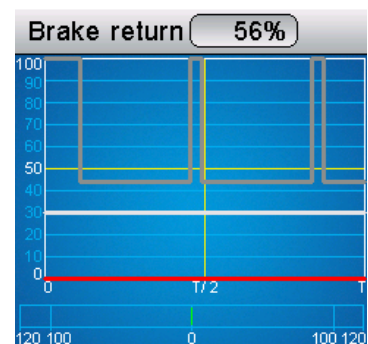

Delay

This determines how long it takes for the A.B.S. system to take effect. At a setting of 0% the A.B.S. system will take effect as soon as the brake is applied, however the higher the percentage the longer it will take for the A.B.S. to kick in.

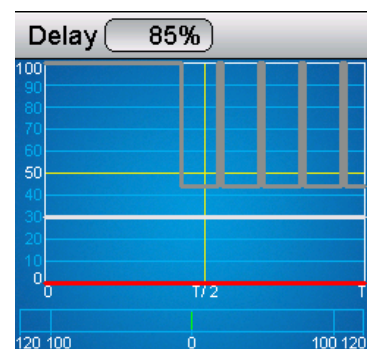

Cycle length

Increases or decreases the time between pulses, in this menu the A.B.S. function will be shown as a square wave, the peaks representing break on, and the drops break reduction.

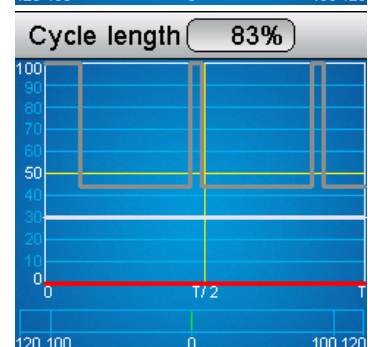

Trigger point

Changes the point in which the A.B.S. will kick in. The trigger point is represented as a white line on the graph. To change the position of the trigger point use the wheel at the bottom of the screen.

The higher the percentage the more the trigger has to be moved in order for the A.B.S. to kick in.

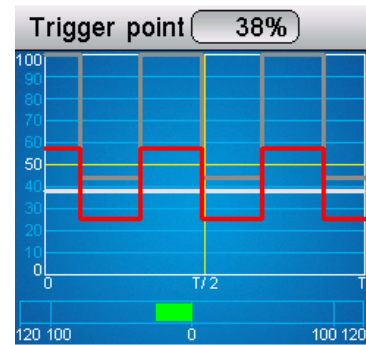

Duty cycle

Changes the length of each pulse and the gap between them, as the wheel at the bottom is moved it will change the braking from a symmetrical wave form, to a wave form with longer dips or longer peaks.

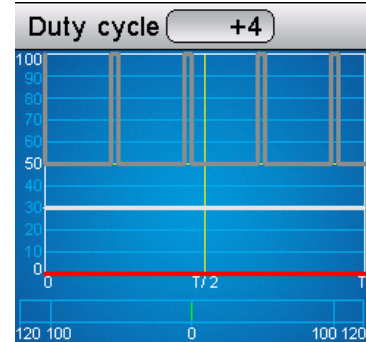

Changes to the wave form are shown in real time on the graph.

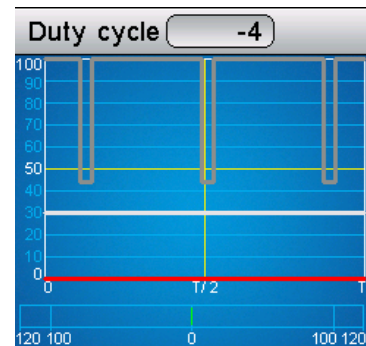

Steering mix

When turning A.B.S. can become a problem for some models, this function mixes braking and steering, so that when the car makes a turn the A.B.S. will be turned off and replaced with a constant braking pressure, this will be shown as %N.

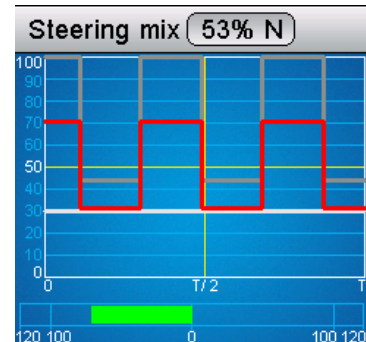

To have constant braking unless turning simply move the wheel the opposite direction so that the header shows %E.

To change this function simply use the wheel to take it from it' s off position, and apply a percentage of braking force.

The graph will show the results real-time, also when the trigger is moved the results will be show on the graph.

6.9 Throttle Speed

This function changes how quickly the throttle will react, both when pressed and released. This is useful to emulate different models such as big trucks, which in real life take longer to get up to speed and slow down.

There are 2 main settings in this function:

- Go: How quickly the throttle applies acceleration.
- Return: How quickly the throttle backs off.

To adjust these settings, select the desired setting and use the wheel to change its value, the lower the percentage the longer it will take for the throttle to catch up with the trigger movement. The bar in the middle of the screen will show the throttles current position in real time. When the bar is red it is showing the triggers position on the throttle position, when the function is active the red line will move first, followed by the green line as it catches up with the trigger position.

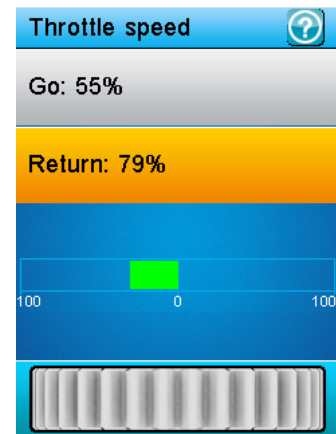

7 Throttle Middle

This function changes the midpoint of the throttle, this could be used in a middle in which the servo and the throttle position do not line up with no throttle, if this is the case the model may move as soon as it's turned on. To change the midpoint, use the wheel at the bottom of the screen, the current position will be shown on the screen in real time.

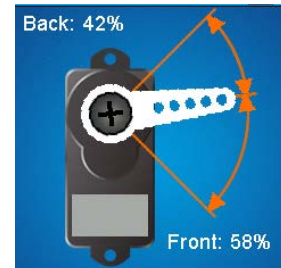

7.1 Throttle Idle Up

This function is used for models that use a fuel based engine, if left at 0 throttle these engines will stall. To combat this idle up makes sure that the engine always has some throttle in order to keep it from stalling. When finished using this mode, you can press the assigned button to bring the throttle to 0, effectively cutting the engine although this is usually done using the engine cut function.

This function must be assigned to a switch/button in order to be activated (see keys function).

To set this function first assigned it to a switch/button, once the button is pressed the icon in the bottom left corner of the screen (within the function) should become a tick. Then use the wheel at the bottom of the screen to change the value.



7.2 Engine Cut

Throttle cut is used for fuel based models and is used to cut the throttle, essentially cutting the engine. To edit the settings move the wheel at the bottom of the screen. When active the function will stop the throttle dropping below the defined point. For help setting up your model's engine consult the model's user manual.

This function must be assigned to a switch/button to be activated.

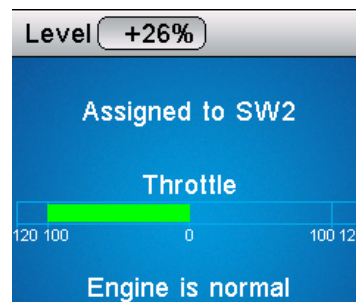

7.3 Boat Mode

This function is used only when you are using a model boat. When using this function the break functionality is disabled and the throttle channel is set to its lowest position.

To toggle this function select the box beside "Normal mode", when the function is active the text beside the box will change to "Boat mode".

To toggle this function select the box beside "Normal mode", when the function is active the text beside the box will change to "Boat mode".

7.4 Break Mixing

This function enables you to use models that require more than one braking channel, for example a model that has separate brakes for from and back breaking.

If your model uses extra channels for braking, each channel can be controlled separately and are slaves of the throttle channel. (Exponential and A.B.S. functions are the same as earlier discussed)

CH3	CH4
Exponential	Exponential
A.B.S.	A.B.S.

7.5 Mixes

This function is used to create a mix between channels and control methods. For example if at lower throttle some automated flap movement was desired then it is possible to create a mix to do this. The difference between curve mixes and linear mixes is that it is not possible to create a nonlinear relationship between the master and slave. It is possible to have up to 4 mixes.

1. After selected a mix, select the bottom left icon to ensure there is a tick in the box, next select the "master", this channel/input will be designate the slaves output. It is possible to select stick/knob, basic functions or a channel output.
2. Next select a slave. A slaves may only be output channels, however this also includes any unused aux channels. Once you have you slave selected you can apply a curve to the mix, to do this select either the low side or high side as desired and use the wheel to change the value, it is also possible to offset the channel in relation to the master using the offset option.

Master channel: Steering
Slave channel: Channel 3
Low side mix: 91
High side mix: 100
Offset: +0



Each curve mix can independently be signed to a toggle using the  icon.

7.6 Display Servos

This function displays the models channel output and can be used to test output and servo range, the test button at the middle bottom of the screen will cause the channels to move slowly through their entire range.

To toggle this function press the icon at the bottom center of the screen.

WARNING

If the model engine is powered on while the test function is activated will rev up.

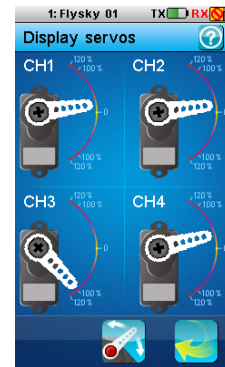

7.7 Race Timer

The race timer has 4 modes:

- Up timer: Counts up.
- Down timer: Counts down from the set time.
- Lap timer: Keeps track time for each individual lap.
- Lap memory: Records the results from the lap timer.

To start the timer touch the "Start" icon and to stop select the "Stop" icon.

To reset press the reset icon.



7.8 Keys Function

This function assigns the systems physical buttons to different functions. To assign a function to a key select the key from the diagram, then select a function from the list.

WARNING

If the model engine is powered on while the test function is activated will rev up.

To set the keys function:

1. Touch one of the trim or switches shown on the diagram.
2. Scroll down the list until you find the function you wish to assign and select it.
3. Once the selection has been made the function will automatically return to the previous menu.

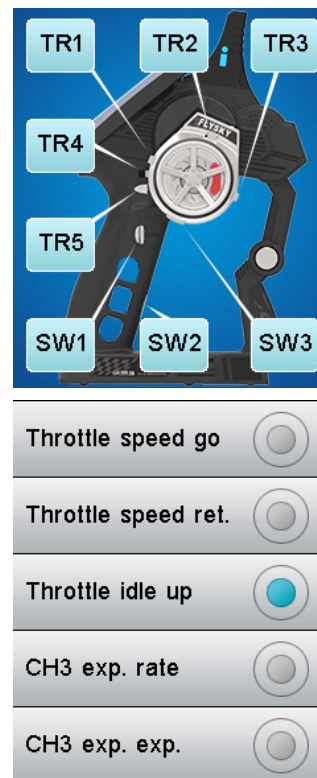

7.9 Models

The models function is used to change between, copy and delete model setups. The FS-iT4S can store up to 20 different models in the internal memory.

Selecting a model:

To select a model touch the select model menu, once in the menu touch the name of the model to load it.

Reset Model

To reset (delete model by resetting to default), first select a model from the model selection menu (as shown above), then press the reset model button. The system will ask for a confirmation before resetting the model.

Reset to default.

Are you sure?

Yes

No

Naming Models

To name a model, fist select a model from the model selection menu (as shown above), then touch the name menu button which will bring up a keyboard.

Once you have finished entering in the name using the keyboard press the [Icon] to save.

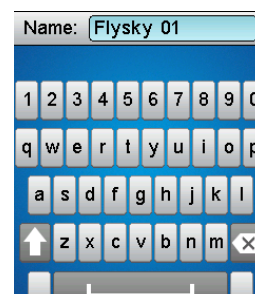

Copy Model

1. Select copy model from the menu (This will usually be the current model).
2. Select a copy source (the model you wish to make a copy of).
3. Select a target model (the model you wish to overwrite).

Copy source

This is the model you wish to copy.

Copy Target

This is the model you wish to overwrite.

WARNING

Once a model has been deleted or overwritten it is impossible to recover.

Select model: 1
Reset model
Name: Flysky 01
Copy model

8.0 RX Setup

8.1 Bind with a receiver

This function enables you to bind the RX and TX so that no other system may interfere with your models operation.

To bind the transmitter with a receiver:

1. Connect the bind cable to the RX, then connect the power.
2. On the TX select "Bind with a receiver" .
3. Once the RX and TX are bound the TX will exit this menu automatically (Unless using a 1-way communication protocol such as AFHDS 2A 1-way in which case you must exit this menu manually).

8.2 RF std.: ADHDS 2A 2-way

This menu allows you to change the communication protocol for the TX, the available protocols are:

- AFHDS
- AFHDS 2
- AFHDS 2A 1-Way
- AFHDS 2A 2-Way



Note

AFHDS 2A 2-Way is the latest, most stable and advanced communication protocol.

This will change the AFHDS mode.

Are you sure?

Yes

No

When changing mode you will be prompted to confirm.

8.3 Receiver PPM Output

When checked, the receiver only outputs PPM on CH1 output, however PPM is capable of transferring all channels even though there is only one physical output (When enabled the other 9 outputs are disabled).

To enable PPM touch the box in this menu. When the box is checked the PPM is active.

8.4 RX Battery Monitor

Monitors the receiver battery voltage. Use the supplied battery' s user manual to set the lower and higher voltages, so that the system can monitor battery level effectively.

Setting the voltage alarm sets a custom low battery level alarm.

To change settings, touch the desired value and move the wheel to set the new value.

- ❑ External sensor: This option enables monitoring battery status using an external sensor.
- ❑ Low voltage: This sets your batteries default low voltage value is 4.00V.
- ❑ Alarm voltage: Sets the low voltage alarm.
- ❑ High voltage: Set the maximum voltage when the battery is full. The default high voltage is 5.00V (Check your battery specifications).

External sensor	<input type="checkbox"/>
Low voltage: 4.00V	
Alarm voltage: 4.20V	
High voltage: 5.00V	

8.5 Low Signal Alarm

When checked, an alarm will be triggered if the receiver's packet error rate rises above 60%.

8.6 FailSafe

This function is used to protect models and users if the receiver loses signal and therefor is no longer controllable.

All 4 channels are listed in the failsafe menu, "off" means that in case of a loss of signal, the corresponding servo will keep its last received position, if it displays a percentage the servo will instead move to the selected position.

To set a failsafe position select a channel and select the icon at the bottom left of the screen, if it has a tick, it is active.

To set the value, move your channel to the desired position, for example to cut the throttle when signal is lost enter the throttle channel and move the stick to the bottom (-100%), then exit back to the failsafe channel list. Once the failsafe has been set the value will show up in the failsafe channel list instead of being listed as "off".

Steering	: -57%
Throttle	: Off
Channel 3	: Off
Channel 4	: Off
All channels	

8.7 Display Sensors

This function displays current active sensors.

The type of sensor is displayed on the left hand side, its ID in the middle and the sensors output on the right.

Type	ID	Value
TX voltage	1	4.11V

Under "Type" , and the sensors output on the right under "Value" . All sensors have numerical ID shown in the middle column.

At the bottom of the list this menu has an error rate display, this is a good indicator of signal quality.



8.8 Choose Sensors

The main screen can display the value of up to 4 sensors, this function selects which sensors are displayed. First select a slot, any sensors that are connected will automatically populate this list, select the desired sensor and exit the function.

There are 2 types of sensors, basic and advanced. A basic sensors only reports back 1 value, but an advanced sensor is able to monitor several things at once, for example altitude, temperature and speed.

8.9 Speed and Distance

This function allows the user to monitor the models RPM and how far it has traveled.

If the sensor appears in the menu, it means that there is one connected.

- Speed sensor
Selects the desired sensor.
- Set rotation lengt
When attaching a speed sensor to a wheel etc, it is important that the sensor knows exactly how far out from the sensor it is. The system uses this distance to calculate distance traveled.
- Odometer 1
Records the distance traveled during a session. (Note: Restarting the system will also reset odometer 1)
- Odometer 2
Records the total distance traveled since last reset. This means that the distance over several sessions will be added together.

Reset odometer 1: Resets odometer 1 to 0.

Reset odometer 2: Resets odometer 2 to 0.

This will reset
the odometer 1.

Are you sure?

Yes

No

9 i-Bus Setup

After connecting the i-Bus module to your receiver and servos, select steering, throttle, channel 3 or 4. The system will display a prompt saying "Press the corresponding servo interface button or touch cancel.". Locate the desired servo, and using the tool provided to push the channels button on the i-Bus module.

9.1 Servos frequency

Some types of servo will require a different frequency to function properly, to change this value simply use the wheel to change it. Consult your servos user manual to find out the correct frequency.

Note

The most common frequency is 50Hz.



9.2 Range Test

The range test function is useful for finding out if there are sources of interference nearby.

To perform a range test pair the RX and TX, then open this function. Press SW2 (Located near your small finger on the grip of the transmitter) and walk slowly away from your model.

10.0 System

10.1 Backlight Timeout: (Time)

The backlight timeout function controls how long the system will wait before turning off screens backlight.

Note

Backlight time can affect the battery life of your system, the longer the time, the shorter the battery will last.

To change the backlight time enter the function and select the desired time from the list.

10.2 Backlight: (%)

This function controls the backlight brightness. (Note: Increasing the brightness will reduce battery life)

To change the backlight brightness, use the wheel at the bottom of the screen to change the percentage.

10.3 System Sound

Toggles all system sounds (excluding alarms).

To disable the system sounds uncheck the box by touching it.

10.4 Alarm Sound

Toggles all alarm sounds.

To disable the alarm sounds uncheck the box by touching it.

10.5 Auto Power Off

The auto power off function powers off the system automatically after 2 min, unless a receiver is connected.

To enable this function check the box by touching it.

10.6 Screen Calibration

If the touch screen is not functioning correctly, use this function to recalibrate.

To recalibrate once inside the function touch the centre of the crosses as they appear on the screen. The system will exit the function once calibration is complete.



Note

It is recommended that you use the supplied stylus.

10.7 Units

Use this function to change between Metric and Imperial measurement systems.

10.8 USB Function

The system can be used with various computer based simulators via USB. To enable the simulator function select "FS-iT4S emulator" from the menu. To disable this function select "none". (Note: when the emulator mode is active the system cannot transmit data wirelessly)

Connecting PC charging and upgrade the firmware, USB data transmission will not work

10.9 Firmware Update

The internal software of the transmitter can be updated using the USB interface connected to a PC computer. Once this function is activated, all functions of the transmitter stop. To avoid any loss of control of the vehicle, turn its receiver off before entering this mode. A confirmation is requested.

When the firmware is updating, never disconnect the USB cable or remove the battery or the transmitter will become unusable.

This function can be helpful only when connected with computer. Follow the steps as shown below:

1. Download and open the newest official software.
2. Connect a transmitter with a computer by USB cable.
3. Enter transmitter firmware upgrade menu and press OK to complete.



11 Product Specification

11.1 Transmitter Specification

Channels	4
Model type	Car/Boat
Sensitivity	1024
Low voltage alarm	When lower than 3.7 V
Steering Range	90° L: 45° R: 45°
Throttle Range	35° F: 22.5° B: 12.5°
Weight	398 g
Dimension (Length x Width x Height)	157 x 116 x 258 mm
Power input	3.7 V
Display mode	WG 3.55inch Touch Resistive TFT Color Screen, 262k 240*240 pixels
Color	Black/white
Certificate	CE0678, FCC, C-TICK
RF range	2.4055-2.475 GHz
Channel bandwidth	500 KHz
Band	500KHz
RF power	less than 20 dBm
RF mode:	AFHDS 2A (Second generation automatic frequency hopping digital system)
Code type	GFSK
Data output	USB

11.2 Receiver Specification

Channels	4
Model type	Boat/Car
RF range	2.4055-2.475 GHz
Band	500GHz
Receiver sensitivity	-105 dBm
2.4G system	AFHDS 2A
Code type	GFSK
Antenna length	26 mm
Weight	10 g
Dimension (Length x Width x Height)	35.4 x 29.6 x 13 mm
Power input	4.0 to 6.5 V
Output	PWM/CPPM
Certificate	CE0678, FCC, C-TICK

Appendix 1 FCC Statement

This equipment has been tested and found to comply with the limits for a Class B digital device pursuant to part 15 of the FCC rules. These limits are designed to provide reasonable protection against harmful interference in a residential installation. This equipment generates, uses and can radiate radio frequency energy and, if not installed and used in accordance with the instructions, may cause harmful interference to radio communications. However, there is no guarantee that interference will not occur in a particular installation. If this equipment does cause harmful interference to radio or television reception, which can be determined by turning the equipment off and on, the user is encouraged to try to correct the interference by one or more of the following measures:

- Reorient or relocate the receiving antenna.
- Increase the separation between the equipment and receiver.
- Connect the equipment into an outlet on a circuit different from that to which the receiver is connected.
- Consult the dealer or an experienced radio/TV technician for help.

To assure continued compliance, any changes or modifications not expressly approved by the party responsible for compliance could void the user's authority to operate this equipment. (Example use only shielded interface cables when connecting to computer or peripheral devices).

This equipment complies with Part 15 of the FCC Rules. Operation is subject to the following two conditions:

- (1) This device may not cause harmful interference, and
- (2) This device must accept any interference received, including interference that may cause undesired operation.

Caution!

The manufacturer is not responsible for any radio or TV interference caused by unauthorized modifications to this equipment. Such modifications could void the user authority to operate the equipment.

The antenna(s) used for this transmitter must be installed to provide a separation distance of at least 20 cm from all persons and must not be co-located or operating in conjunction with any other antenna or transmitter.

Changes or modifications not expressly approved by the party responsible for compliance could void the user's authority to operate the equipment.

EU Statement

Hereby, FLYSKY RC MODEL TECHNOLOGY CO., LTD, declares that this FS-IT4 is in compliance with the essential requirements and other relevant provisions of Directive 1999/5/EC.

CE 0678



Digital proportional radio control system

<http://www.flysky-cn.com>
copy right 2008 @flysky co.,ltd