

# CMC191 Use Manual



# 1 ESL System platform

ESL system platform include CMC191 ESL reader, ESL tag, system data center. System data center sends command to read/write tag by Ethernet, when CMC191 receives the command it will scans the tag and update the tag image information, and return the result to system data center.

System architecture as follow diagram

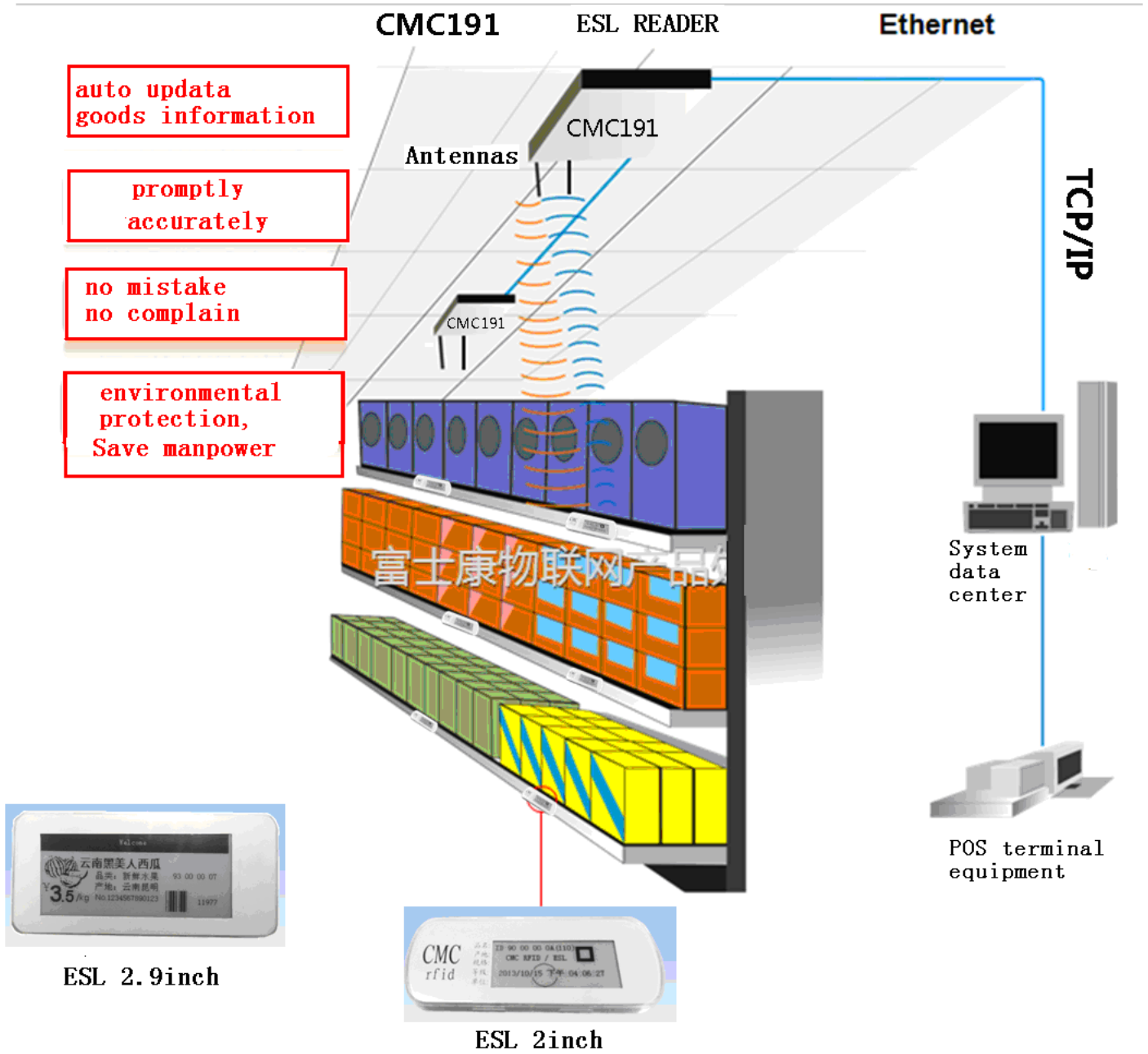

## 2 CMC191 setup diagrammatic drawing:

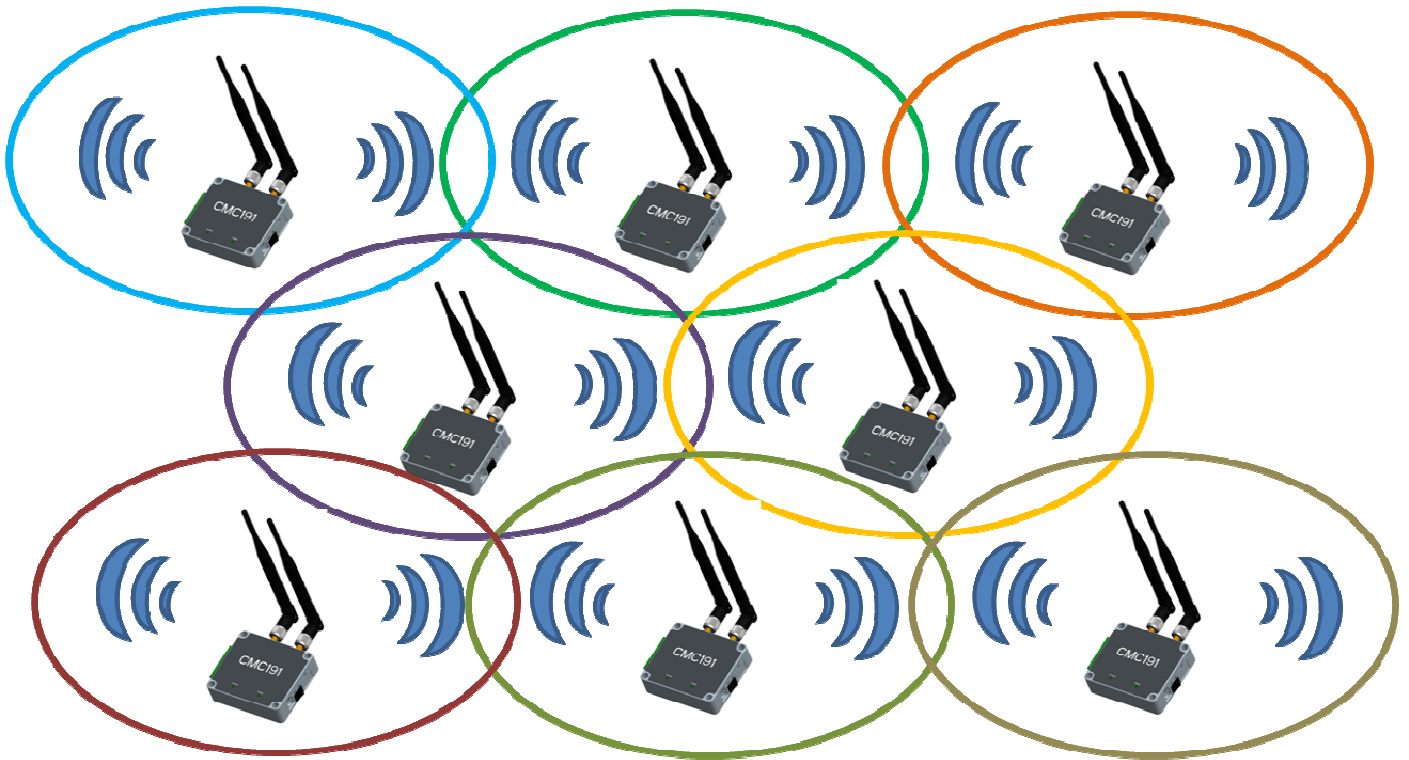

2.1 CMC191 identification range radius 25 meter;

2.2 Rod-like antennas radiation range is oblong (left to right radiation range is larger than front to back);

2.3 CMC191 will find its different channel from the others when it powers on. Different color means different channel;  
The same channel CMC191s do not be allowed;

## 3 CMC191 Appearance Specification:

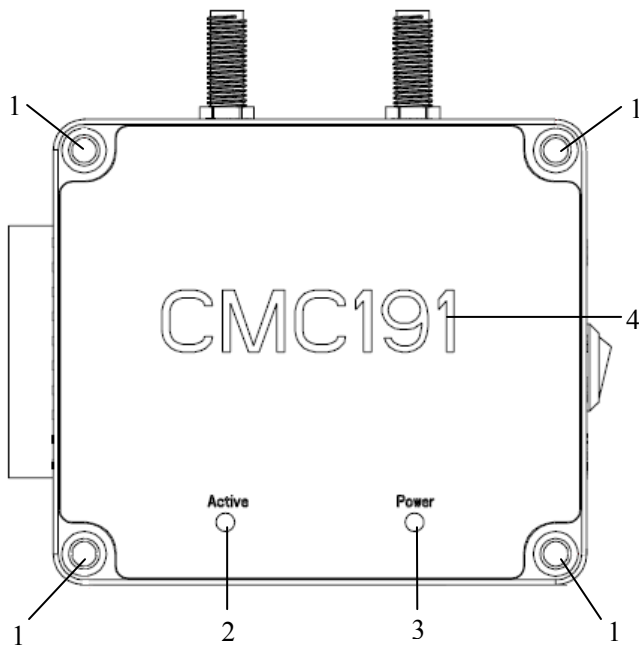

### Label Specification:

1. Confirm Screw Holes
2. Work LED
3. Power LED
4. Logo

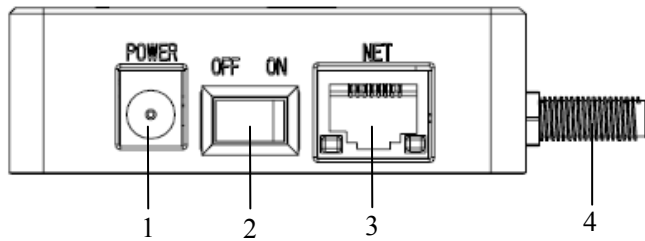

**Label specification:**

1. DC Input
2. Switch
3. Ethernet Input
4. Antenna Port

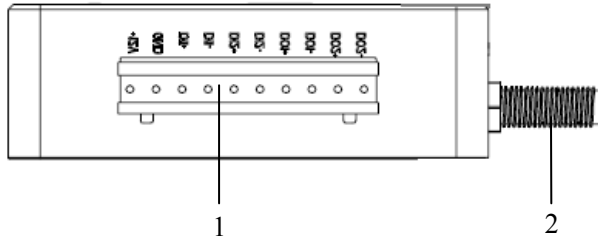

**Label specification:**

1. I/O Port
2. Antenna Port

■ **4 I/O port define:**

Label	Specification
+12V	DC12V Power
GND	Ground
DI1+	2 Input ports
DI1-	
DI2+	
DI2-	
DO1+	2 Output ports
DO1-	
DO2+	
DO2-	

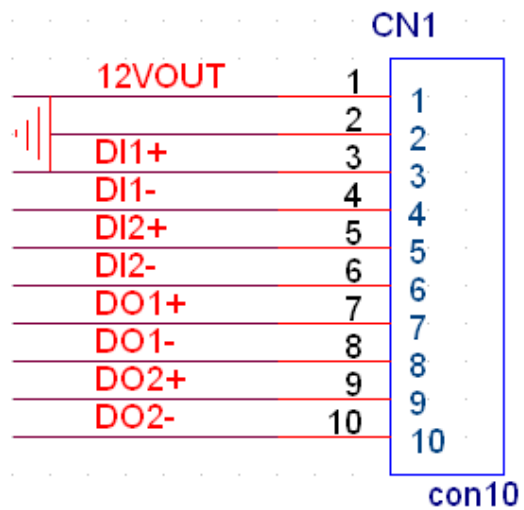

■ **5 Dimension (Unit: mm):**

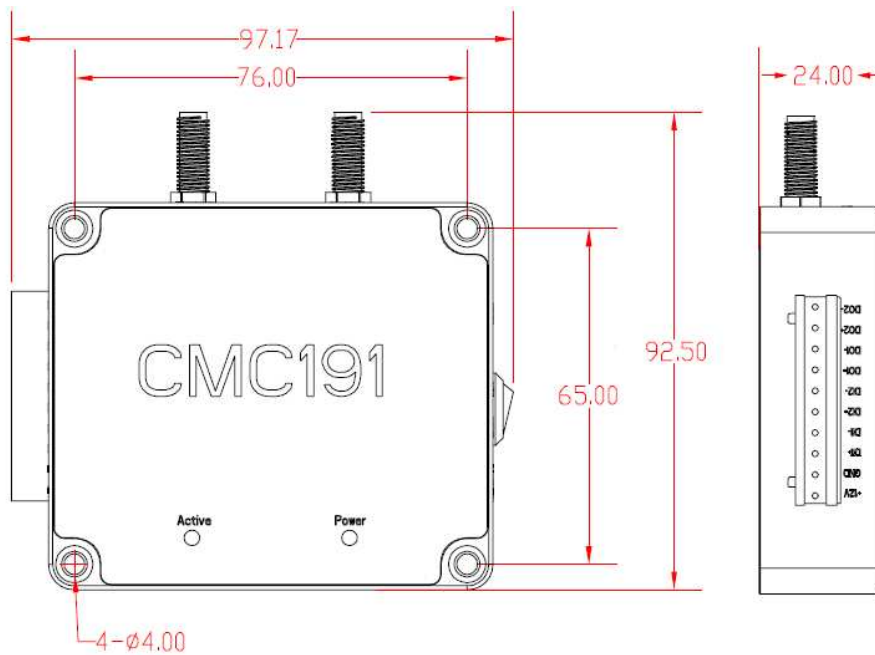

Unit:mm

## ■ 6 Installation instructions And Note

1. Suggest installation CMC191 on the roof ceiling, to make its radiation range well.
2. Please according to this specification choice positioning screw and a positioning hole.
3. Ensure that the background system to the CMC191 screen line length does not exceed 100m, Suggested the use of twisted pair shielded cable, otherwise it will affect the CMC191 signal strength and distance recognition.
4. Recognition distance of CMC191 depend on the gain of antenna、the angle between the tag and the antenna, The labels on items of medium, the surrounding environment, So in practical application, please according to the site conditions to select the best match.
5. Radiation antenna is elliptical (Radiation range wide, radiation range and narrow), Such as the use of CMC191 external antenna to antenna, please according to the characteristics in the selection of the best way to install.

## ■ 7 The use and maintenance of attention

1. Please use my company power adapter (AC:110V~220V,DC:12V/3A)。
  2. Do not put the equipment storage or installed in direct sunlight, high humidity and dew and other heat source location.
  3. Non authorized person shall not for the transformation of the equipment, decomposition and assembly; otherwise it will cancel the warranty period。
4. When the installation of a plurality of CMC191 signal interference situation, Please according to according to the site conditions to make the larger distance between the CMC191 of the same channel.

## ■ 8 Customer service commitment

Product warranty for one year, Damage if not natural disasters and man-made factors, the warranty period free warranty。

- ◆ Products sold no returns, except for the product quality problems need repair or replacement.
- ◆ The fault caused by the improper operation of man-made damage must pay for repair.

## FCC Statement

This equipment has been tested and found to comply with the limits for a Class B digital device, pursuant to part 15 of the FCC Rules. These limits are designed to provide reasonable protection against harmful interference in a residential installation. This equipment generates uses and can radiate radio frequency energy and, if not installed and used in accordance with the instructions, may cause harmful interference to radio communications. However, there is no guarantee that interference will not occur in a particular installation. If this equipment does cause harmful interference to radio or television reception, which can be determined by turning the equipment off and on, the user is encouraged to try to correct the interference by one or more of the following measures:

- Reorient or relocate the receiving antenna.
- Increase the separation between the equipment and receiver.
- Connect the equipment into an outlet on a circuit different from that to which the receiver is connected.
- Consult the dealer or an experienced radio/TV technician for help.

**FCC Statement**

This device complies with FCC radiation exposure limits set forth for an uncontrolled environment.

This device complies with Part 15 of the FCC Rules. Operation is subject to the following two conditions: (1) this device may not cause harmful interference, and (2) this device must accept any interference received, including interference that may cause undesired operation.

**Caution!**

Any changes or modifications not expressly approved by the party responsible for compliance could void the user's authority to operate the equipment.