

EGYZIA ANGOLO

Wall Mount Canopy Rangehood

- Installation Instructions
- Use and Care Information

READ AND SAVE THESE INSTRUCTIONS

The installer must leave these instructions with the homeowner. The homeowner must keep these instructions for future reference and for local electrical inspectors' use.

READ THESE INSTRUCTIONS BEFORE YOU START INSTALLING THIS RANGEHOOD

WARNING: - TO REDUCE THE RISK OF A RANGE TOP GREASE FIRE: Keep fan filters and grease laden surfaces clean. Always turn hood ON when cooking at high heat. Use high range setting on range only when necessary. Heat oil slowly on low to medium setting. Don't leave range unattended when cooking. Always use cookware and utensils appropriate for the type and amount of food being prepared.

WARNING: - TO REDUCE THE RISK OF INJURY TO PERSONS IN THE EVENT OF A RANGE TOP GREASE FIRE, OBSERVE THE FOLLOWING: SMOOTHER FLAMES with a close-fitting lid, cookie sheet, or metal tray, then turn off the burner. **BE CAREFUL TO PREVENT BURNS.** If the flames do not go out immediately **EVACUATE AND CALL THE FIRE DEPARTMENT. NEVER PICK UP A FLAMING PAN-** You may be burned. **DO NOT USE WATER,** including wet dishcloths or towels - a violent steam explosion will result. Use an extinguisher **ONLY** if: 1. You know you have a Class ABC extinguisher, and you already know how to operate it. 2. The fire is small and contained in the area where it started. 3. The fire department is being called. 4. You can fight the fire with your back to an exit.

ALL WALL AND FLOOR OPENINGS WHERE THE RANGEHOOD IS INSTALLED MUST BE SEALED.

This rangehood requires at least 24" of clearance between the bottom of the rangehood and the cooking surface or countertop. This minimum clearance may be higher depending on local building code. For example, for gas ranges, a minimum of 30" may be required. The maximum depth of overhead cabinets is 13". Overhead cabinets on both sides of the unit must be a minimum of 18" above the cooking surface or countertop. Consult the cooktop or range installation instructions given by the manufacturer before making any cuts. **MOBILE HOME INSTALLATION** The installation of this rangehood must conform to the Manufactured Home Construction and Safety Standards, Title 24 CFR, Part 3280 (formerly Federal Standard for Mobile Home Construction and Safety, Title 24, HUD, Part 280). Four wire power supply must be used and the appliance wiring must be revised. See Electrical Requirements.

LISEZ BIEN CETTE FICHE AVANT D'INSTALLER LA HOTTE

AVERTISSEMENT: - POUR RÉDUIRE LE RISQUE DE FEU: Gardez le ventilateur, les filtres ainsi que toute autre surface propre. Utilisez la hotte pour cuisson à haute température. N'utilisez le feu qu' si nécessaire. Chauffez l'huile doucement. Surveillez toujours la cuisson. Utilisez toujours des casseroles de taille convenable pour la cuisson.

AVERTISSEMENT: - POUR PRÉVENIR LES BLESSURES EN CAS DE FEU SUIVRE LES RECOMMANDATIONS SUIVANTES: ÉTOUFFEZ LE FEU avec un couvercle métallique et fermez le brûleur. **Si le feu ne s'éteint pas tout de suite, QUITTEZ LES LIEUX ET APPELEZ LES POMPIERS. NE TOUCHEZ JAMAIS UNE CASSEROLE EN FLAMMES. N'UTILISEZ JAMAIS DE L'EAU** ou un torchon mouillé pour éteindre le feu - ce qui pourrait causer une explosion de vapeur. **N'utilisez un extincteur que si:** 1. Vous avez un modèle ABC et vous connaissez bien son mode d'emploi. 2. Le feu est petit et peu répandu. 3. Les pompiers sont déjà prévenus. 4. Vous avez une sortie derrière vous.

TOUTE OUVERTURE DANS LE MUR OU LE PLANCHER À PROXIMITÉ DE LA HOTTE DOIT ÊTRE SCÉLÉ

Gardez 24 po. de hauteur entre le bas de la hotte et la surface de cuisson. Cette hauteur minimum peut être plus haute suivant le code municipal. Par exemple, les cuisinières à gaz peuvent requérir 30 po. de hauteur. Les armoires au-dessus ne dépasseront pas 13 po. de profondeur. Les armoires au-dessus de chaque côté devront être au moins à 18 po. au-dessus de la surface de cuisson. Consultez la fiche technique avant de découper les armoires. L'installation de cette hotte doit être conforme aux Règlements de Manufactured Home Construction and Safety Standards, titre 24 CFR, Section 3280 (anciennement Federal Standard for Mobile Home Construction and Safety Standards, titre 24 CFR, Section 3280 (anciennement Federal Standard for Mobile Home Construction and Safety, titre 24, HUD, Section 280). Le branchement électrique se fait avec une raccordement à 4 fils. Consultez la fiche technique électrique.

VENTING REQUIREMENTS

Determine which venting method is best for your application. Ductwork can extend either through the wall or the roof.

The length of the ductwork and the number of elbows should be kept to a minimum to provide efficient performance. The size of the ductwork should be uniform. Do not install two elbows together. Use duct tape to seal all joints in the ductwork system. Use caulking to seal exterior wall or floor opening around the cap.

Flexible ductwork is not recommended. If it is used, each foot of flexible ductwork used is equivalent to two feet of straight metal ductwork when calculating the duct run length. Thus, a flexible elbow equals two standard elbows.

Make sure there is proper clearance within the wall or floor for exhaust duct before making cuts. Do not cut a joist or stud unless absolutely necessary. If a joist or stud must be cut, then a supporting frame must be constructed. For best results, remote blowers should transition to 9" round duct as soon as possible. If small ducting is used, it should be transition to 9" round as soon as possible.

WARNING - To Reduce The Risk Of Fire, Use Only Metal Ductwork.



WARNING

- Venting system **MUST** terminate outside the home.
- **DO NOT** terminate the ductwork in an attic or other enclosed space.
- **DO NOT** use 4" laundry-type wall caps.
- Flexible-type ductwork is not recommended.
- **DO NOT** obstruct the flow of combustion and ventilation air.
- Failure to follow venting requirements may result in a fire.

ELECTRICAL REQUIREMENTS

A 120 volt, 60 Hz AC-only electrical supply is required on a separate 15 amp circuit, fused on both sides of the line. A time-delay fuse or circuit breaker is recommended. The fuse must be sized per local codes in accordance with the electrical rating of this unit as specified on the serial/rating plate located inside the unit near the field wiring compartment. **THIS UNIT MUST BE CONNECTED WITH COPPER WIRE ONLY.** Wire sizes must conform to the requirements of the National Electrical Code, ANSI/NFPA 70 - latest edition, and all local codes and ordinances. Wire size and connections must conform with the rating of the appliance. Copies of the standard listed above may be obtained from:

National Fire Protection Association
Batterymarch Park
Quincy, Massachusetts 02268

This appliance should be connected directly to the fused disconnect (or circuit breaker) through flexible, armored or nonmetallic sheathed copper cable. Allow some slack in the cable so the appliance can be moved if servicing is ever necessary. A UL Listed, 1/2" conduit connector must be provided at each end of the power supply cable (at the appliance and at the junction box).

When making the electrical connection, cut a 1 - 1 1/4" hole in the wall. A hole cut through wood must be sanded until smooth. A hole through metal must have a grommet.

WARNING - TO REDUCE THE RISK OF FIRE, ELECTRICAL SHOCK, OR INJURY TO PERSONS, OBSERVE THE FOLLOWING: Use this unit only in the manner intended by the manufacturer. If you have any questions, contact the manufacturer. Before servicing or cleaning unit, switch off power at service panel and lock service panel to prevent power from being switched on accidentally. When the service disconnecting means cannot be locked, securely fasten a prominent warning device, such as a tag, to the service panel.

Installation Work And Electrical Wiring Must Be Done By Qualified Person(s) In Accordance With All Applicable Codes And Standards, Including Fire-Rated Construction. When cutting or drilling into wall or ceiling, do not damage electrical wiring and other hidden utilities. Ducted fans must always be vented to the outdoors.

Sufficient air is needed for proper combustion and exhausting of gases through the flue (chimney) of fuel burning equipment to prevent backdrafting. Follow the heating equipment manufacturer's guideline and safety standards such as those published by the National Fire Protection Association (NFPA), and the American Society for Heating, Refrigeration and Air Conditioning Engineers (ASHRAE), and the local code authorities.

CAUTION: For General Ventilating Use Only. Do Not Use To Exhaust Hazardous or Explosive Materials and Vapors.

For Remote Blowers only: **CAUTION:** This unit has an unguarded impeller. Do Not Use In Locations Readily Accessible To People Or Animals.



WARNING

- Electrical ground is required on this rangehood.
- If cold water pipe is interrupted by plastic, nonmetallic gaskets or other materials, **DO NOT** use for grounding.
- **DO NOT** ground to a gas pipe.
- **DO NOT** have a fuse in the neutral or grounding circuit. A fuse in the neutral or grounding circuit could result in electrical shock.
- Check with a qualified electrician if you are in doubt as to whether the rangehood is properly grounded.
- Failure to follow electrical requirements may result in a fire.

RÈGLEMENTS D'ÉVACUATION

Confirmer la sortie d'évacuation - soit par le mur, soit par le toit.

Utilisez une longueur de tuyauterie minimale avec les moindres de coudes pour la plus grande efficacité. Le diamètre de tuyauterie doit être uniforme. N'installez jamais 2 coudes ensemble. Scellez bien tous les joints avec un ruban adhésif métallique à l'intérieur et scellez bien le clapet extérieur avec du calfeutrage.

Utilisez un tuyau d'évacuation rigide lorsque possible. Un tuyau flexible égale deux fois plus qu'un tuyau rigide, ce qui réduit la puissance d'évacuation.

Veillez à ce que l'espace pour le tuyau soit ample - ainsi on n'aurait pas besoin de découper les supports de mur mineur. Si ce découpage est nécessaire, veillez bien à ce qu'un renforcement soit mis en place.

Pour de meilleurs résultats, utilisez un tuyau de transition de 9 pouces dès que possible.

AVERTISSEMENT - Pour Ne Pas Risquer Un Feu, Utilisez Seulement Les Matériaux Métalliques.



AVERTISSEMENT

- Le système d'évacuation DOIT sortir à l'extérieur.
- N'ÉVACUEZ PAS le conduit soit dans une mansarde soit dans un espace fermé.
- N'UTILISEZ PAS un clapet de séchoir à 4 pouces.
- N'utilisez pas un conduit flexible.
- N'ENCOMBREZ PAS la circulation d'air.
- Faute de suivre cet avertissement pourrait occasionner un feu.

FICHE TECHNIQUE ÉLECTRIQUE

Le raccordement électrique doit se faire avec un circuit séparé de 15 ampères (fusible de chaque côté) à 120V, 60 Hz, courant alternatif. On recommande un coupe-circuit. La taille du fusible doit se conformer aux codes municipaux suivant la spécification électrique sur la plaque intérieure. Le diamètre du fil devra aussi se conformer aux règlements du code national électrique, ANSI/NFPA 70 - ainsi qu'aux règlements locaux et les spécifications de cet appareil. On peut obtenir ces informations chez:

L'Association Nationale de la Prévention du Feu
Bakermarch Park
Quincy, Massachusetts 02269

Raccordez cet appareil directement au coupe-circuit avec un fil flexible couvert en cuivre en laissant un peu de lâchement dans le fil pour permettre le déplacement de l'appareil. Veillez à ce qu'un contact d'un demi-pouce (1/2 po.) soit installé à chaque bout de fil (soit à l'appareil ainsi qu'à la boîte à fusibles).

Faites un trou de 1 1/4 po. dans le mur. S'il s'agit d'un trou en bois - sciez-le bien, tandis qu'un trou passant par le métal demande un bouchon-trou.

AVERTISSEMENT - POUR RÉDUIRE LE RISQUE DE FEU OU UNE SECOUSSE ÉLECTRIQUE: Suivez les recommandations du fabricant et entre en communication avec lui pour toute information. Fermez le courant avant tout entretien et veillez à ce qu'il reste fermé. Si on ne peut pas verrouiller le panneau du service électrique, affichez un avis de danger sur la porte.

L'Installation Et Le Raccordement Électrique Doivent Se Faire Par Un Technicien Qualifié Selon Tous Les Codes Municipaux. En perçant un mur veillez à ne pas perforer un autre fil électrique. Une hotte à évacuation extérieure doit être raccordée à l'extérieur. Si elle est à installer au-dessus d'une baignoire ou une douche, prévoir à ce qu'elle soit conforme à cet usage.

Afin d'obtenir un rendement maximal en ce qui a trait à la combustion ainsi qu'à l'évacuation des gaz par la conduite de cheminée, une bonne aération est nécessaire pour tous les appareils à combustion. Suivez les conseils et mesures de sécurité du fournisseur tels que ceux publiés par l'Association Nationale de la Sauvegarde contre l'Incendie et l'Association Américaine d'Ingénieurs de Chauffage, Frigorification et Air Climatisé ainsi que les codes municipaux.

AVIS: Pour L'évacuation Générale - Veillez à Ne Pas Evacuer Des Matériaux Ou Vapeurs Explosif.

AVIS: Pour La Hotte Avec Une Turbine Extérieure - Veillez Bien À Ce Que Les Lieux D'installation Soient Hors D'Atteinte Des Enfants Et Des Animaux.



AVERTISSEMENT

- Une prise à terre est nécessaire pour cette hotte.
- N'utilisez pas un tuyau à frotter froide pour la mise à terre s'il est branché à un joint plastique, non-métallique ou autre.
- NE JOIGNEZ PAS la mise à terre à conduit de gaz.
- N'INSTALLEZ PAS un fusible dans le circuit de mise à terre - ce qui peut causer une secousse électrique.
- Vérifiez avec un électricien certifié à ce que la hotte soit bien mise à terre.
- Faute de suivre ces recommandations pourrait occasionner un feu.

TOOLS NEEDED FOR INSTALLATION

- Saber Saw or Jig Saw
- Drill
- 1/4" Wood Drill Bit
- Pliers
- Phillips Screwdriver
- Flat Blade Screwdriver
- Wire Stripper or Utility Knife
- Metal Snips
- Measuring Tape or Ruler
- Level
- Paint
- Caulking Gun
- Duct Tape

PARTS SUPPLIED FOR INSTALLATION

- 1 Hardware Package
- 1 Literature Package

PARTS NEEDED FOR INSTALLATION

- 2 Conduit Connectors
- Power Supply Cable
- Wiring Cable - Optional Remote Blower Only
- 1 Wall or Roof Cap
- All Metal Ductwork

PLAN THE INSTALLATION

This rangehood can be installed as either ducted or ductless. The blower can be vented through the wall or ceiling. To vent through a wall, a 90° elbow is used. When installed ductless, the rangehood vents out of a ductless grate which is provided in the carton with the rangehood.

This rangehood can be used with an optional remote blower. If a remote blower is used, then the internal blower must be removed and discarded. Both blowers cannot be used together. The remote blower connects to the rangehood using a separate wiring cable not supplied with the rangehood. The wiring cable should be installed at the same time as the ductwork.

WARNING! BEFORE MAKING ANY CUTS OR HOLES FOR INSTALLATION, DETERMINE WHICH VENTING METHOD WILL BE USED AND CAREFULLY CALCULATE ALL MEASUREMENTS.

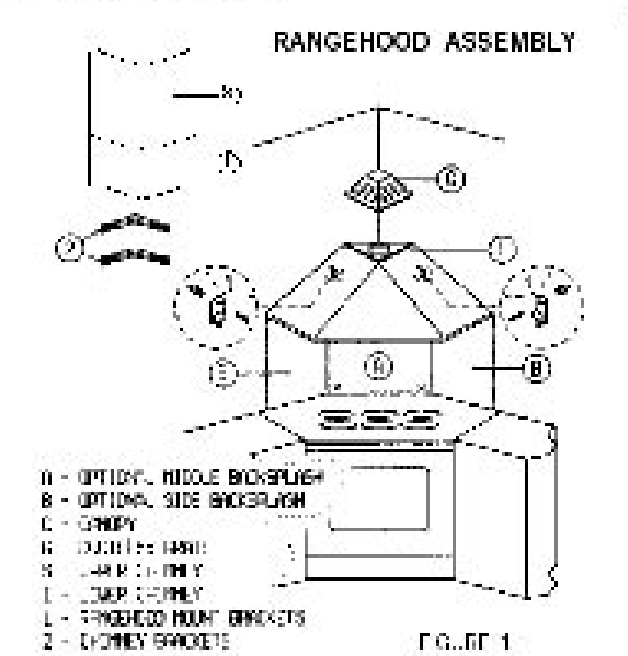

INSTALLATION DIMENSIONS

The Ezyzia Angelo chimney is adjustable and designed to meet varying ceiling heights. FIGURE 2 illustrates the standard installation for the Ezyzia Angelo which requires the canopy to be mounted 24" above the countertop. The chimney can be adjusted for ceilings between 8 feet and 9 feet.

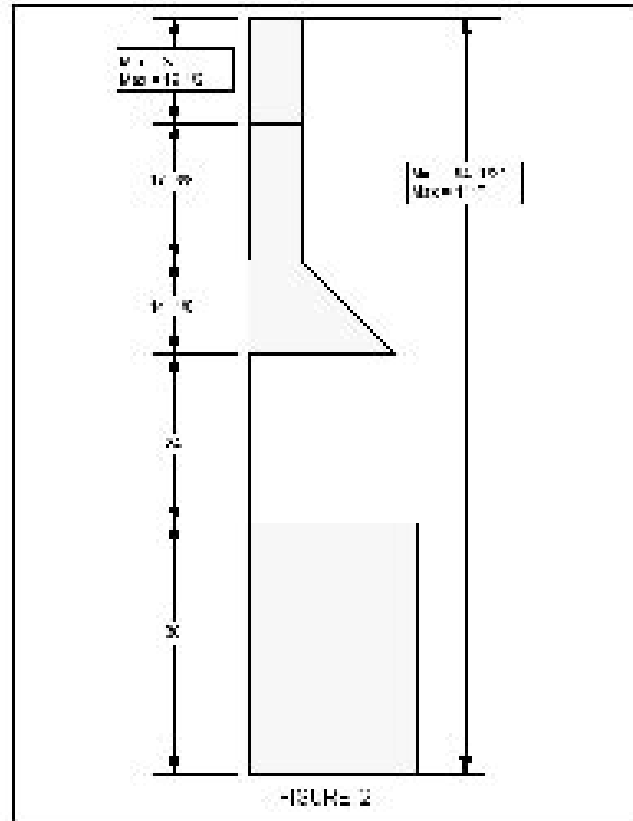

CALCULATE THE DUCTRUN LENGTH

The ductrun should not exceed 35 feet if ducted with 3" 144" by 10" rectangular duct and 60' equivalent feet. If ducted with 8" round ductwork, calculate the length of the ductwork by adding the equivalent feet in FIGURE 3 for each piece of duct in the system. An example is given in FIGURE 4. For best results, use no more than three 90° elbows. Make sure that there is a minimum of 24" of straight duct between elbows if more than one is used. Do not install two elbows together. Remote blowers require 8" round duct.

45° Elbow	7.0 feet
90° Elbow	6.0 feet
90° Flare Elbow	12.0 feet
Wall Cap	0.0 feet

FIGURE 3

9 Foot Straight Duct	9.0 feet
2 - 90° Elbows	12.0 feet
Wall Cap	0.0 feet
Total System	19.0 feet

FIGURE 4

⚠ WARNING

PERSONAL INJURY HAZARD

Because of the weight and size of the rangehood canopy, two or more people are needed to move and safely install the rangehood canopy.

Failure to properly fit rangehood could result in damage to the product or personal injury.

PREPARE THE WALL

1. Disconnect and move freestanding range from cabinet opening to provide easier access to upper cabinet and rear wall. Put a thick, protective covering over cooktop, set-in range or countertop to protect from damage or dirt.
2. Determine and clearly mark with a pencil the center line on the wall where the rangehood will be installed.
3. The canopy of the rangehood hangs from two mounting brackets (point 1 in FIGURE 5). If a backsplash is to be used with this rangehood, it must be installed before the rangehood. The height of the backsplash will determine the bottom edge of the canopy.

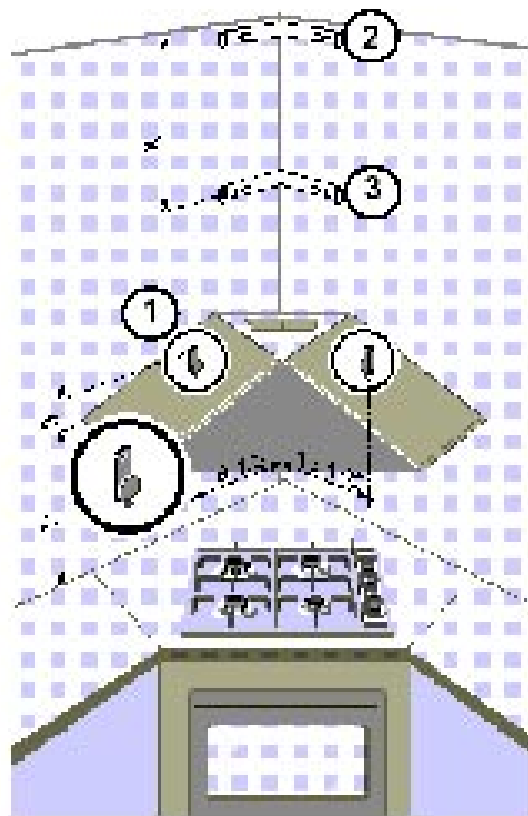
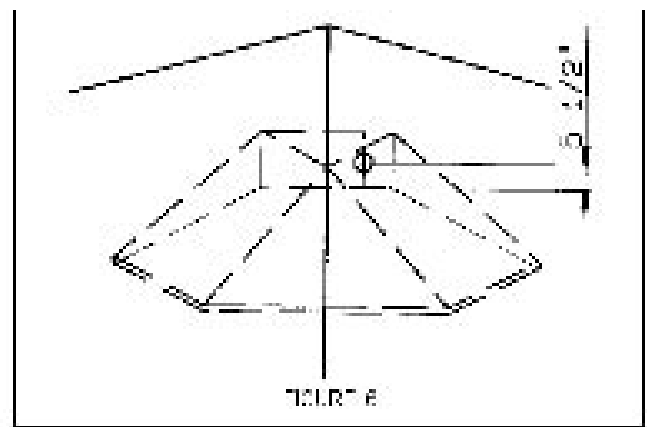

FIGURE 5

4. The chimney attaches to the wall by two mounting brackets (2 and 3 in FIGURE 5). The top bracket (2) must be installed 1-8" from the ceiling. The bottom bracket (3) must be installed at the bottom point of the upper chimney sleeve.

Determine the proper location for each bracket and install the brackets on the wall. **MAKE SURE THAT THE BRACKETS ARE SECURELY FASTENED TO THE WALL.**

5. Determine and make all necessary cuts in the wall for the ductwork. Install the ductwork before the rangehood.
6. Determine the proper location for the Power Supply Cable as indicated in FIGURE 6. Use a 1/4" Drill Bit to make this hole. Run the Power Supply Cable. Use caulking to seal around the hole. **DO NOT** turn on the power until installation is complete.



INSTALL THE RANGEHOOD

1. Remove the unit from the carton and place on a flat surface for assembly. Cover the surface to prevent accidental damage. Remove all parts including the mounting hardware before discarding the carton.
2. Remove the grease filters from the unit and set aside. The grease filters are removed by pressing the handle in front of the filter as indicated in FIGURE 7. When replacing, make sure that the filters are properly positioned with the handles in front and visible.

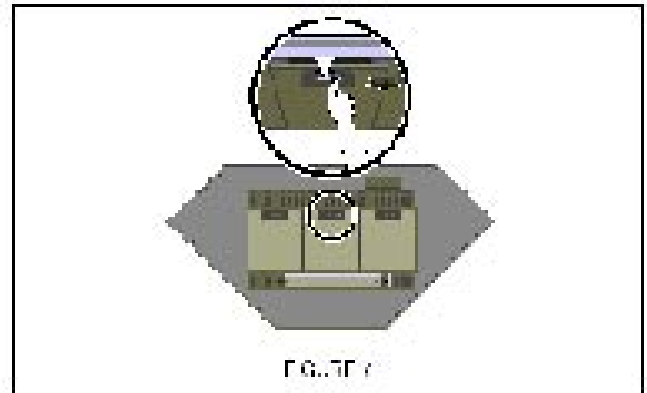

3. Remove the cover from the field wiring compartment. Remove the wiring electrical knockout using a flat-blade screwdriver. Feed the Power Supply Cable through the electrical knockout.
4. Rotate the two adjustment screws (R in FIGURE 8) until inserted halfway in the slot. Hang the canopy on the brackets. Due to the weight of the canopy, two people should lift it to avoid injuries. Make sure that the canopy is secure on the brackets.



5. The height of the canopy can be adjusted by rotating the two screws (R) indicated in FIGURE 8. These are also used to insure that the canopy is level.

6. Connect the Power Supply Cable to the rangehood. Attach the White lead of the power supply to the White lead of the rangehood with a twist-on type wire connector. Attach the Black lead of the power supply to the Black lead of the rangehood with a twist-on type wire connector. Connect the Green (Green and Yellow) ground wire under the Green grounding screw.

7. If your installation uses a remote blower, connect the wiring cable for the remote blower. DO NOT connect the remote blower to the Power Supply Cable. The wiring diagram for this rangehood is supplied next to the Use and Care Information on the rear of the Installation Instructions.

8. Replace the field wiring compartment cover and the grease filters.

For ductless installations:

The Egezia Angelo can be installed as ductless without the chimney only. A ductless grate is supplied in the carton with the rangehood as indicated in FIGURE 9. In this case, the chimney must be discarded. Ductless installations require a set of charcoal filters which are available from your dealer.

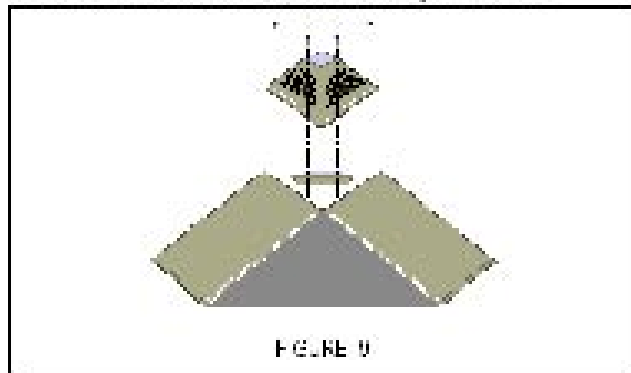

9. For ducted installations, the damper must be attached to the exhaust opening on the top of the canopy. Two small Phillips screws are provided with the damper to attach it to the canopy. Connect the ductwork and seal all connections with duct tape.

10. The chimney must be attached to the body of the rangehood. The attachment of the chimney (S in FIGURE 10) must be installed first.

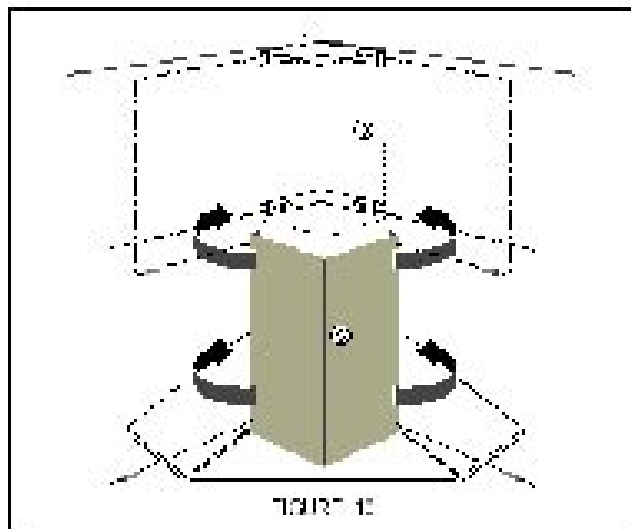

11. Once the upper section is installed, then the lower section must be installed (J in FIGURE 11). Both sections are secured to the wall under the mounting brackets. Once the chimney is in the final position, screws are used to secure the top and bottom of the chimney to the brackets.

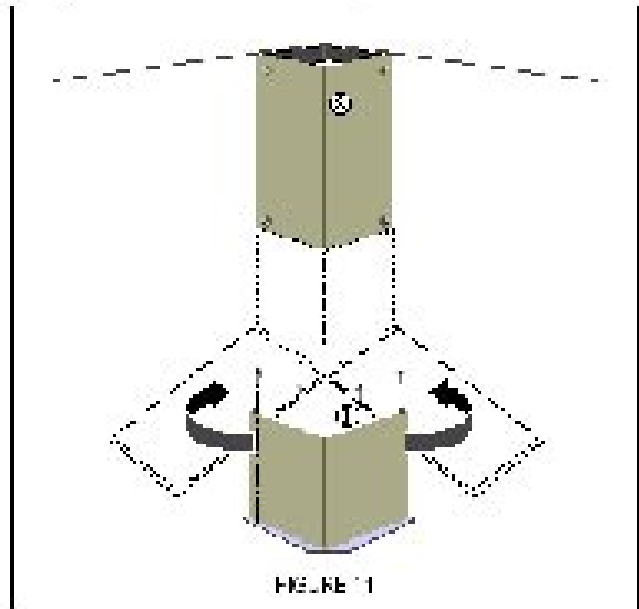

12. Turn the power supply on. Turn on blower and light. The rangehood controls are located in a gray panel (P) on the canopy's underside as indicated in FIGURE 12. To open the panel, press up on the front edge and release. If the rangehood does not operate, check that the circuit breaker is not tripped or the house fuse blown. If the unit still does not operate, disconnect the power supply and check that the wiring connections have been made properly.

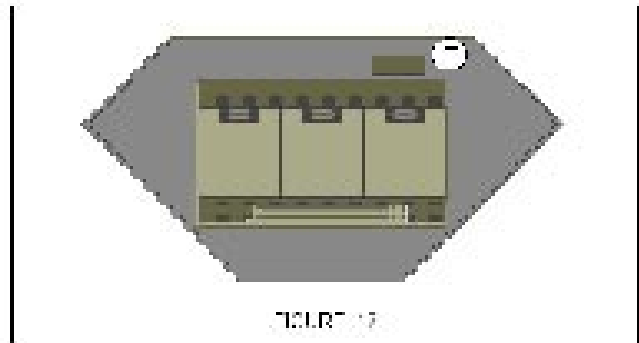

**WIRING DIAGRAMS
STANDARD INTERNAL BLOWER**

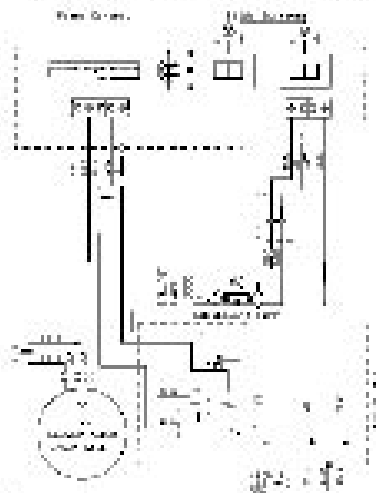

OPTIONAL REMOTE BLOWER

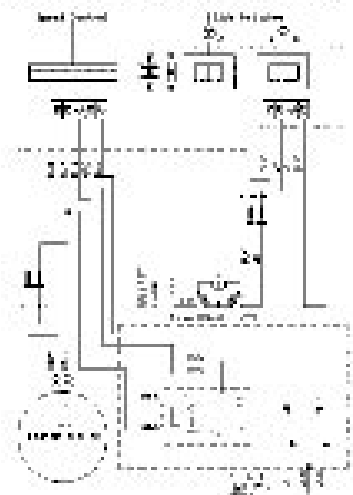

- This rangehood uses Fluorescent Lamp Type F32-T5W-T8 and Starter Type S2.
- * If a remote blower is used with this rangehood, current draw must not exceed 4 amps.

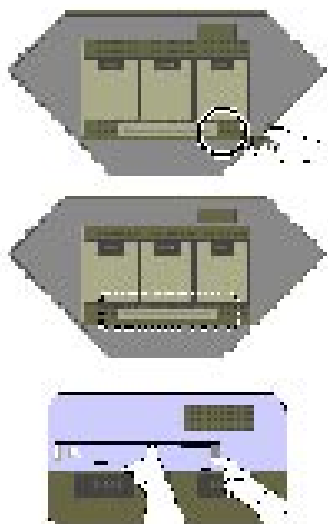

FIGURE 14

USE AND CARE INFORMATION

This rangehood system is designed to remove smoke, cooking vapors and odors from the cooktop area.

Rangehood Control Panel

The control panel, located on the right-hand side under the canopy, is designed to disappear from view when not needed. To open, press upward on the front edge and release. The panel will drop into sight. To close, push upward on the bottom left corner of the control panel and it will slide up into the hood. The position and function of each control button is indicated in FIGURE 13.

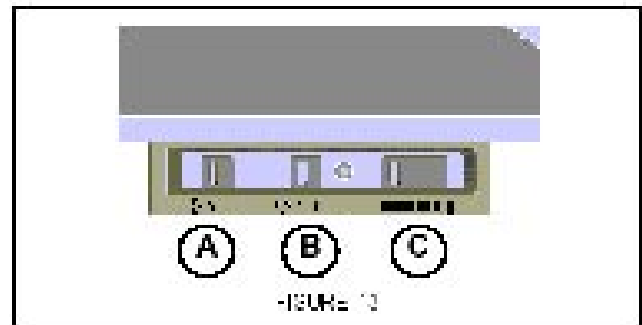

Light On/Off Button (A)

On/Off switch for the fluorescent light. Move the switch to "I" to turn the light ON and to "O" to turn it OFF.

Blower On/Off Button (B)

On/Off switch for the blower. Move the switch to "I" to turn the blower ON and to "O" to turn it OFF.

Blower Speed Button (C)

Variable speed control for blower. Move the switch to the Left for LOWER speeds and to Right for HIGHER speeds.

For Best Results

Start the rangehood before cooking and allow the unit to operate for several minutes after cooking is complete to clear all smoke and odors from the kitchen.

Cleaning

The metal grease filters should be cleaned frequently in hot detergent solution or washed in the dishwasher. Stainless steel cleaner should be used on stainless rangehoods. Abrasives and scouring agents can scratch stainless steel finishes and should not be used to clean finished surfaces. The filters should be reinstalled with handle side facing outwards.

Replacing the Fluorescent Light

To replace the fluorescent light, remove the diffuser clips from both ends of the glass diffuser as indicated in the first illustration of FIGURE 14. Carefully slide the glass diffuser all the way to one side. Lower the opposite end of the glass below the support flange, then remove the glass by sliding it back to the other direction as indicated in the second illustration. Replace the diffuser glass by reversing these directions.

WARRANTY & SERVICE

This rangehood carries a limited warranty against manufacturer's defects. To obtain warranty service, contact the dealer from whom you purchased the rangehood, or the local Faber distributor. If you cannot identify a local Faber distributor, contact Faber USA at (508) 358-6353 for the name of a distributor in your area.