

Clarion JX-4000

10 Mbit/sec WIRELESS TRANSCEIVER

Clarion/Hyperlink Wireless LAN Bridge Kit

Installation Manual

Wireless LAN Division

Clarion Corporation of America

Clarion®

Copyright © 1996, Clarion Corporation of America. All rights reserved. No part of the contents of this document may be transmitted or reproduced in any form or by any means without the written permission of Clarion Corporation of America.

Portions Copyright © 1998, Hyperlink Technologies, Inc. All rights reserved

WARNINGS

The manufacturer assumes no responsibility for damage caused by interference due to this equipment.

Contents

FCC Radio Interference Statement	4
Introduction	5
Features of the JX4000	5
Types of Installations	6
System Requirements	7
Kit Contents	7
Tools Required	7
JX-4000 Front & Rear Panel Features	8
Overall System Configuration	9
Antenna System Connections	10
Surveying the Antenna Site	10
Preparing for System Installation	11
Mounting & Cabling the Antenna System	11
LED Diagnostic Display	13
Clarion JX-4000 Specifications	14

APPENDICES

Antenna Mounting Instructions	Appendix A
-------------------------------	------------

Radio Frequency Interference Statement

USA - Federal Communications Commission (FCC): This device complies with Part 15 of FCC Rules. Operation of this device is subject to the following two conditions:

This device may not cause harmful interference.

This device must accept any interference that may cause undesired operation.

Information to User: This device must be installed and used in strict accordance with the manufacturer's instructions. However, there is no guarantee that interference to radio communications will not occur in a particular commercial installation. If this device does cause interference, which can be determined by turning the host equipment off and on, the user is encouraged to consult the instruction manual of the host equipment or the local device supplier. In case the device does cause harmful interference with an authorized radio service, the user/operator shall promptly stop operating the device until harmful interference has been eliminated.

The manufacturer is not responsible for any radio or television interference caused by unauthorized modification of this device or the substitution or attachment of connecting cables and equipment other than those supplied. The correction of interference caused by such unauthorized modification, substitution or attachment will be the responsibility of the user.

Introduction

The Clarion JX-4000 is a wireless transceiver providing 10 Mbit/sec burst data rate to support wireless connections in IEEE 802.3 and Ethernet II (TCP/IP) LAN. Equipped with a Hyperlink Extended Range Antenna System, the JX-4000 offers a high-performance long-range building-to-building network bridge.

The JX-4000 functions as an Ethernet MAU. It uses a state-of-the-art spread spectrum technology to implement robust 10 Mbps burst transmission. It also actualizes efficient utilization of frame buffers and coordination of RF and wired interface traffic to maintain high throughput.

The JX-4000 offers true “Plug and Play” installation. No additional driver software is required for operation. That is, the JX-4000 can be connected not only to a computer but also to a hub or to a router.

FEATURES OF THE JX-4000

The Clarion JX-4000 has the following features:

- Full wireless Ethernet 10 Mbps data rate.
- State-of-the-art spread spectrum technology provides reliable, secure, long range, radio link operation.
- True “Plug and Play” installation for compatibility with all 802.3 and Ethernet II LAN devices, all operating systems and all protocol stacks.

Types of Installations

The type of application will determine which type of kit to install:

Building-to-Building or Tower-to-Tower: Typically these installations will typically require directional Yagi or Grid Antenna kits.

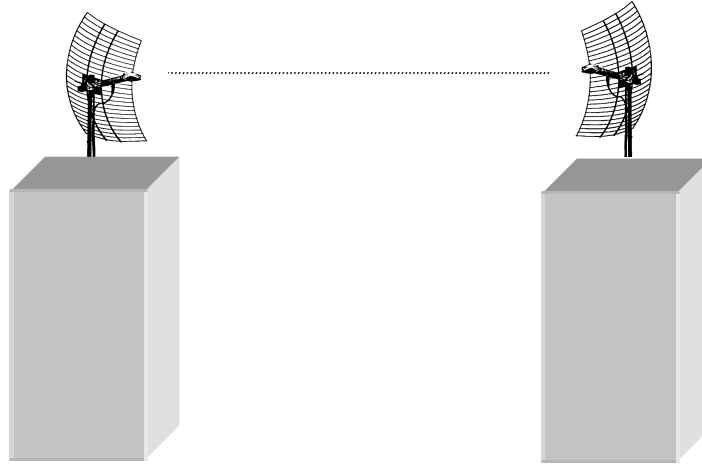

Central Node in a Multipoint Network or Mobile Network: This type of installation typically requires an Omni Directional Kit at the central node for 360 degree coverage.

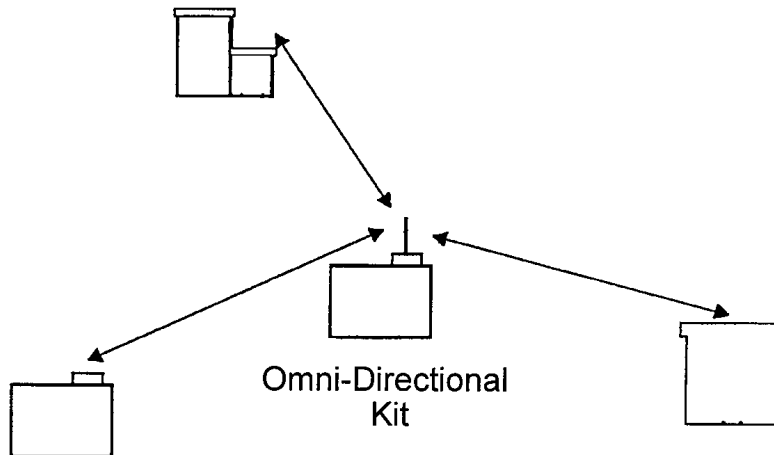

System Requirements

The Clarion/HyperGain™ Extended Range Bridge Kit provides a complete plug-

Clarion®

and-play solution for linking buildings in an outdoor environment. All you need to add is suitable masts or towers and some basic site planning. Please read this manual in its entirety before beginning the installation.

Kit Contents:

Each Kit contains the following items:

- Clarion JX-4000 Radio and DC Power Supply
- HyperGain Antenna (Omni, Yagi, or Grid)
- Interference Filter (On Certain Systems)
- HyperGain Lightning Protector
- 50 ft. Antenna Cable
- 4 ft. Jumper Cable
- Mounting Hardware
- Sealant Tape
- Manual

Tools Required:

- 7/16" open-end wrench or Adjustable Wrench
- #12-10 AWG or similar wire (for grounding)
- Wire Cutter / Stripper
- Pliers

Other Required Equipment:

- Suitable mast or tower hardware
- AUI Transceiver Cable
- AUI-equipped Network Hub or Card

Other Helpful Equipment and Tools:

- Cellular telephones or Walkie-talkies
- Binoculars
- Compass
- Handheld GPS

JX-4000 Front and rear Panel Features

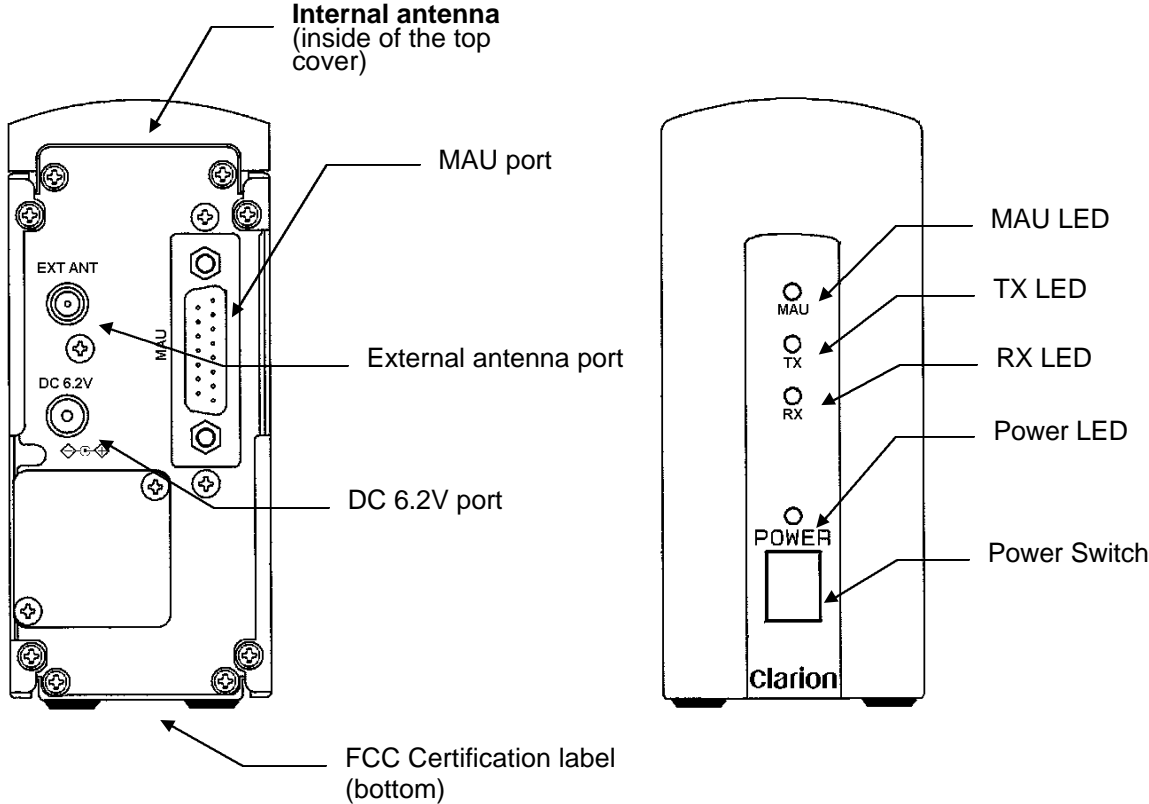

Overall System Configuration

The overall system configuration is shown below. Refer to this diagram while reading the section which follows, and during system installation.

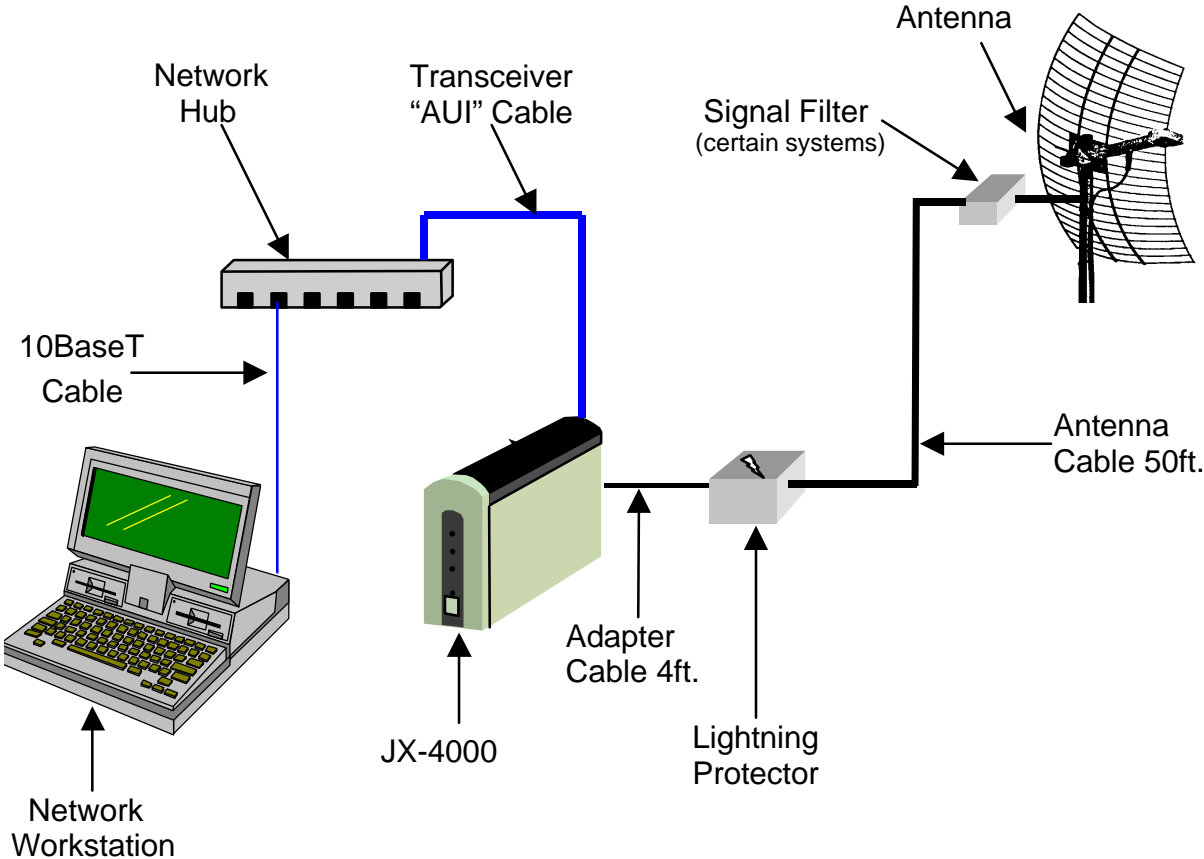

ANTENNA SYSTEM CONNECTION

Warning *The JX-4000 may only be operated using one of the approved antenna kits described herein. All antenna system components are equipped with unique connectors. Although these connectors may look similar to standard types they are not compatible with them. Attempting to attach standard connectors to system components can cause damage to the connectors and attached equipment. In addition, the JX-4000 External antenna port is equipped with a special Antenna recognition function which disables the transmit function in the event a non-approved antenna system is connected to the radio.*

Surveying the Antenna Site

Before beginning system installation, emphasis should be placed on system planning. It is important that no large obstructions exist near the antenna, such as retaining walls, chimneys, air-conditioning units or other antenna masts. These types of objects can have an impact on the antenna system performance.

Plan to mount the antenna as high as possible. You will need enough mast to elevate the antenna approximately 15 feet above the roof or above any obstruction that might be in the antenna's signal path.

You will need to identify the location where the antenna cable will be routed. If you run the antenna cable through the roof, a water-proof fitting will be required. Consult a building contractor or licensed electrician to help you with the routing if necessary. Take note of the length of the mast you will need and the type of mounting hardware required. The amplified antenna kit is shipped with U-Bolt mounting hardware which should be ideal for mounting the antenna and amplifier to most types of mast. Also, make plans on how you are going to talk to the person at the remote antenna while you are going through the antenna alignment procedure. For example, cellular phones or walkie talkies can be used.

Preparing for System Installation

Warning: These antennas are designed to be mounted in open areas such as rooftops or building exterior walls. They are designed to be installed at least 6 feet away from areas occupied by people. During system operation, always keep the antenna at least 1 foot away from your head.

Warning: Before performing the following steps make certain that there are not any power lines within 50 ft. If the mast should fall, either while installing or during operation, contact with any power lines will be fatal or result in a fire.

The Antennas are designed to be mounted on an aluminum or steel mast with a diameter from 1-1/4 inches to 2-1/8 inches. A larger diameter mast would be suggested for a more durable installation. The system includes a 50 foot antenna cable.

Note: The antenna cable has proprietary connectors at each end. Although these connectors resemble standard "N" type connectors, they will not mate with standard "N" connectors. Never attempt to attach a device which is not supplied with the kit as it can cause severe damage to the connectors.

In addition to the kit contents, you will need a ground wire and wire ties.

Mounting and Cabling the Antenna:

Note: Different model antenna kits have different mounting requirements and procedures. Refer to Appendix A in this manual for antenna mounting details.

1. Attach the mast mounting hardware to a solid structure on your building (e.g., the roof itself, concrete bulkhead, vent pipe).
2. Using the included mounting hardware, secure the antenna to the top section of the mast (see Appendix A for details).
3. If the kit contains a signal filter, then install the filter in-line between the 50 ft. cable and the antenna. Otherwise, screw one end of the 50 ft. directly onto the antenna.
4. Apply the included sealant tape around the joined connectors to prevent corrosion from the weather. Wrap the entire connection, overlapping each layer slightly to ensure a weather-tight seal.

5. Attach the one end of the antenna ground cable to the antenna mounting bracket or U-bolt and the other end to a building ground.
6. Very carefully raise the mast and loosely secure it with the mast mounting hardware. Use the plastic wire ties to tie the antenna cable to the mast every six to twelve inches.
7. Aim the directional antenna in the direction of the building you will be linked to. The omni-directional antennas should be mounted vertically and do not need to be aimed as they radiate in a 360 degree pattern.
8. Tighten the mast mounting screws. Do not do anything that would make it difficult to change the position of the antenna. It may be necessary to reposition the antennas while aiming them.
9. Route the antenna cable along the roof to the point where it enters the building. From the inside, pull the cable through the hole and take up any excess slack.
10. Attach the end of the 50 ft. antenna cable to the Lightning Protector. Attach the 4 foot adapter cable between the Lightning Protector and the JX-4000.
11. Attach a second ground wire to the ground lug on the Lightning Protector and to a good building ground.
12. Connect the JX-4000 to an "AUI-equipped" network hub using an "AUI" transceiver cable. A nearby network-connected workstation would be useful during system installation to verify proper operation.
12. Plug the included 6.2 VDC power supply into the JX-4000 and then into the building's AC power. Never use a power supply other than the one shipped with the system as it may cause damage to the radio. It is further recommended that the AC connection be through a commercially available "surge" protector power strip.

LED Diagnostic Display

During power-up, the front panel LEDs on the JX-4000 provide some diagnostic information. Refer to the table below for LED diagnostic information.

Label	Color	Description
MAU	Green	Indicates MAU signal (upload or download) is active.
TX	Red	<ol style="list-style-type: none"> 1. During the power-up cycle, it blinks on and off slowly five times in approximately one second to indicate that the firmware has passed its integrity; or, it flashes on and off very rapidly for four or five seconds to indicate that the firmware has been damaged. No indication described above is available in some case of hardware failure. 2. After normal power-up cycle, it Indicates radio transmission. 3. During the firmware-uploaded cycle ; refer description attached on the new firmware.
RX	Green	<ol style="list-style-type: none"> 1. Indicates radio signal detection. 2. Sometimes flashes even if no true signal receives because of optimized false alarm rate.
Power	Red	<ol style="list-style-type: none"> 1. It turns on at approximately 1/4 second after applying the power to indicate activation of the unit. 2. If the hardware check sequence fails, it turns off automatically at approximately 5 seconds after power on.

JX-4000 Specifications

Frequency Range:	2400-2483.5 MHz ISM band
Carrier Frequency:	2436.07 MHz
Modulation Type:	Direct Sequence Spread Spectrum
Chip Modulation:	BPSK, 32 Mcps
Processing Gain:	12dB (Nominal)
Communication Method:	Half Duplex
Channel Access Method:	SS-P-CSMA ¹
Type of Interface:	MAU (driven by AUI)
Datalink Interface:	IEEE802.3 or Ethernet II MAC
Network Addressing:	derived from attached NIC (<i>Note-1</i>)
RF MAC Protocol:	Radio encapsulation of IEEE802.3 or Ethernet II MAC frame.
Network Topology:	Peer to peer
Dimensions:	148mm(W) × 210mm(D) × 75mm(H)
Power Requirement:	+6.2VDC @ 2.0A max.
Operating Temperature:	0 ~ +40 C
Storage Temperature:	-20 ~ +60 C
Humidity:	0% ~ 90%

1. Note 1 JX-4000 has its own MAC address for configuration of operating parameters. JX-4000 also memorizes single MAC address of attached Network Interface Card(s) for re-transmission protocol.

¹ Spread Spectrum p-persistent CSMA

Appendix A

Antenna Mounting Instructions

Mounting Instructions - HG2408U Omnidirectional Antenna

The included bracket should be used to attach the antenna to a standard antenna mast or tower leg. Proper positioning of the brackets is shown in the following diagram. For best results, first attach the bracket to the tower or structure using the included V-bolt. Then, install the antenna into the bracket and lock in place with the integral bolt. Note that the bracket should only be tightened around the aluminum base, and not the fiberglass radome of the antenna.

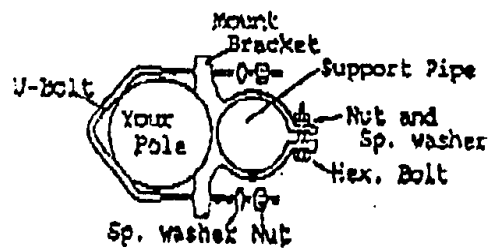
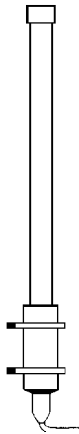

Mounting Instructions - HyperGain HG2414Y Directional Yagi Antenna

Yagi antennas are mounted using the included U-Bolts, Nuts, and Lock Washers as shown in the following illustration:

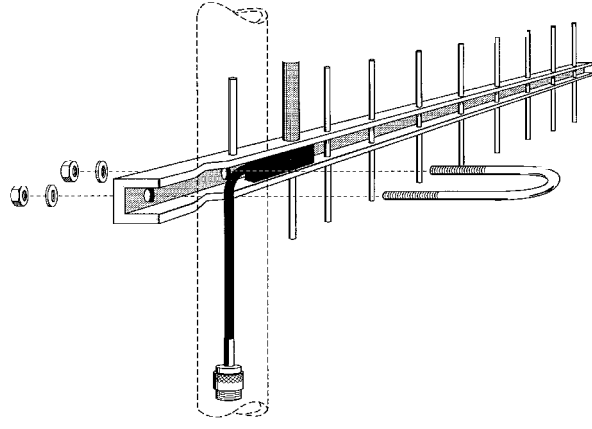

The antenna should be aimed as shown, in the direction of the other end of the wireless link.

Mounting Instructions - HyperGain HG2415Y Radome Enclosed Yagi Antenna

The antenna can be mounted to a mast or directly to an exterior wall as shown. The included U-bolts should be used for mast mounting. Note that in either case, the metal backing plate should be placed directly behind the plastic flange in order to provide greater stability.

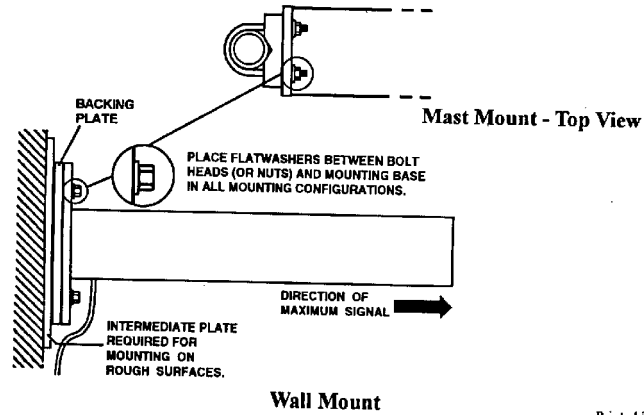
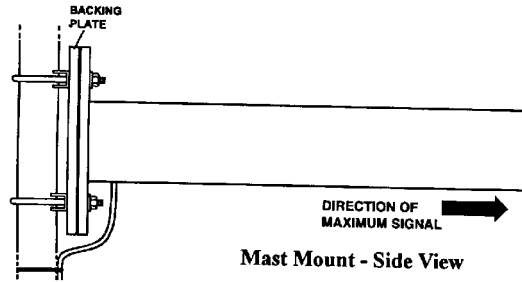

Mounting Instructions - HG2412U Omnidirectional Antenna

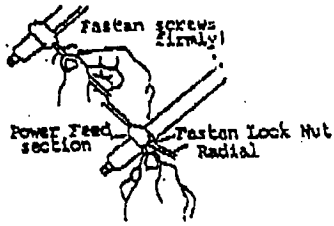

First install the 3 radials at the base of the antenna by screwing in by hand, and then tightening the lock nut with a wrench.

Mount the two mounting brackets to the Mount Support Pipe as shown. Then feed the antenna cable through the Mount Support Pipe and connect to the antenna. Use the included bolt and lock washer to fasten the Antenna to the Mount Support Pipe as shown.

Mount the assembled antenna vertically to the mast using the 2 included "V-bolts".

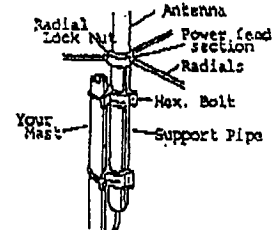
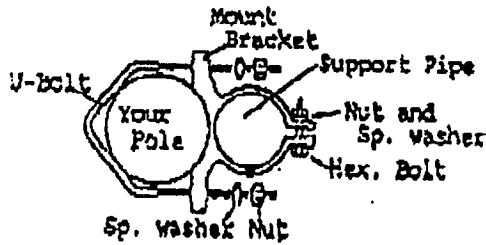
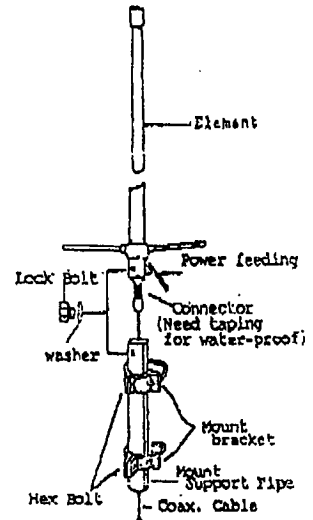

FIGURE 4 MOUNT TO POLE
MONTAR AL MASTIL

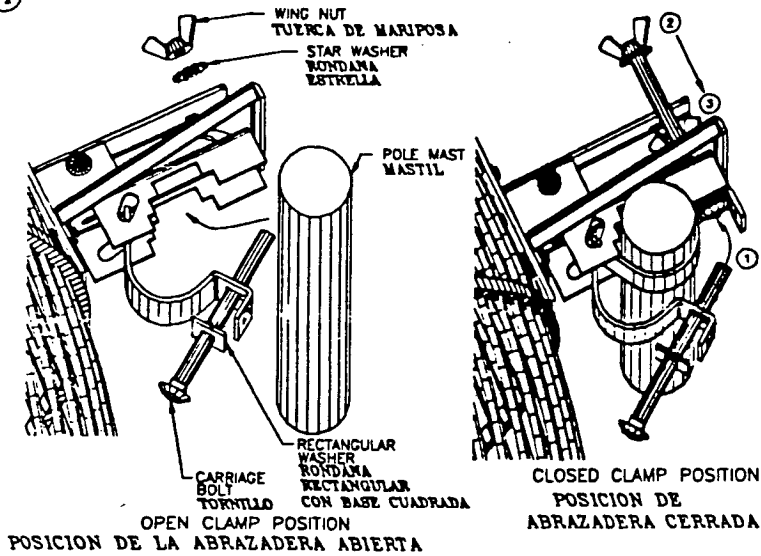
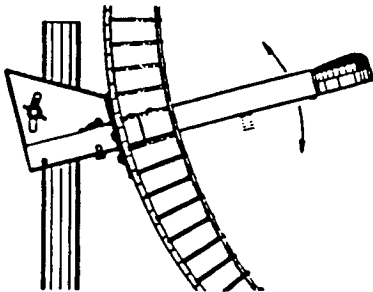
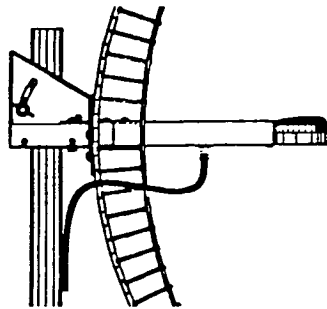

FIGURE 5 ANGLE ADJUSTMENT
AJUSTE DE ANGULO



PLACE ON POLE AND ADJUST FOR OPTIMUM PERFORMANCE
COLOQUE AL MASTIL Y AJUSTE PARA MAXIMA SENAL

FIGURE 6 CABLE ROUTING
GUIA DEL CABLE



**HyperLink
Technologies, INC.**

HyperGain™ Grid Antennas

HG2415G
HG2419G
HG2424GC

Installation Instructions

INSTALLATION STEPS PASOS PARA INSTALAR

- DETERMINE THE REQUIRED ANTENNA/DIPOLE POLARITY, EITHER VERTICAL OR HORIZONTAL. DETERMINE LA POLARIDAD REQUERIDA POR EL DIPOLO Y LA ANTENA. YA SEA VERTICAL U HORIZONTAL.
- ASSEMBLE THE REFLECTOR TO THE BRACKET IN EITHER THE VERTICAL OR HORIZONTAL DIRECTION (SEE FIGURE 1).
ARMAR EL REFLECTOR EN EL SOPORTE EN LA DIRECCION REQUERIDA. VERTICAL U HORIZONTAL (REFERIRSE A LA FIGURA 1).
- CONFIGURE DIPOLE (SEE FIGURE 2)
REMOVE ADAPTER/EXTENDER FOR 15dB. USE AS SUPPLIED FOR 19dB.
CONFIGURE EL DIPOLE (REFERIRSE A LA FIGURA 2)
QUITTE EL ADAPTADOR/EXTENSION PARA 15dB. USE EL MISMO PARA 19dB.
- ATTACH THE DIPOLE TO THE BRACKET IN EITHER THE VERTICAL OR HORIZONTAL DIRECTION INSERTING THE SCREW INTO THE MOUNTING HOLE CLOSEST TO THE REFLECTOR (SEE FIGURE 3).
ARMAR EL DIPOLE AL SOPORTE EN POSICION VERTICAL U HORIZONTAL INSERTANDO EL TORNILLO DENTRO DEL HOLLO DE MONTAJE MAS CERCAO AL REFLECTOR (REFIERASE A LA FIGURA 3).
- ATTACH THE ASSEMBLED ANTENNA TO THE MAST POLE (SEE FIGURE 4).
ARMAR LA ANTENA ENSAMBLADA AL MASTIL (REFIERASE A LA FIGURA 4).
- ADJUST THE ANGLE OF THE ANTENNA FOR THE MAXIMUM SIGNAL STRENGTH, THEN TIGHTEN THE CLAMP (SEE FIGURE 5).
AJUSTE EL ANGULO DE LA ANTENA PARA MAXIMA SENAL Y APRIETE LA ABRAZADERA (REFIERASE A LA FIGURA 5).
- ROUTE THE CABLE THROUGH THE ANTENNA, ATTACHING IT TO THE POLE (SEE FIGURE 6).
GUIE EL CABLE ATRAVEZ DE LA ANTENA, SUJETANDOLO AL MASTIL COMO SE MUESTRA EN LA FIGURA 6.

FIGURE FIGURA

① ATTACHING REFLECTOR TO MOUNTING BRACKET
 ARMADO DEL SOPORTE EN EL REFLECTOR

HORIZONTAL MOUNTING POSITION

POSICION DE MONTAJE HORIZONTAL

#10-32 x 3/8 SCREW
 4 PLACES TORNILLO LUGARES

#10-32 STAR WASHER
 4 PLACES RONDANAS LUGARES ILUSTRADOS

VERTICAL MOUNTING POSITION

POSICION DE MONTAJE VERTICAL

#10-32 x 3/8 SCREW
 4 PLACES TORNILLO LUGARES

#10-32 STAR WASHER
 4 PLACES RONDANA ESTRELLA LUGARES ILUSTRADOS

REFLECTOR
 REFLECTOR

BRACKET ASSEMBLY
 SOPORTE ENSAMBLADO

NOTE: MAKE SURE THE BRACKET IS MOUNTED IN THE CORRECTED POSITION, VERTICAL OR HORIZONTAL USE. REFER TO FIGURE 3 FOR ILLUSTRATION OF HORIZONTAL AND VERTICAL MOUNTING POSITION.
 ASEGURAR QUE EL SOPORTE ESTA EN LA POSICION CORRECTA VERTICAL U HORIZONTAL VER FIGURA 3, PARA ILUSTRACION DE LA POSICION DE MONTAJE.

FIGURE FIGURA

② DIPOLE CONFIGURATION
 CONFIGURACION DEL DIPOLE

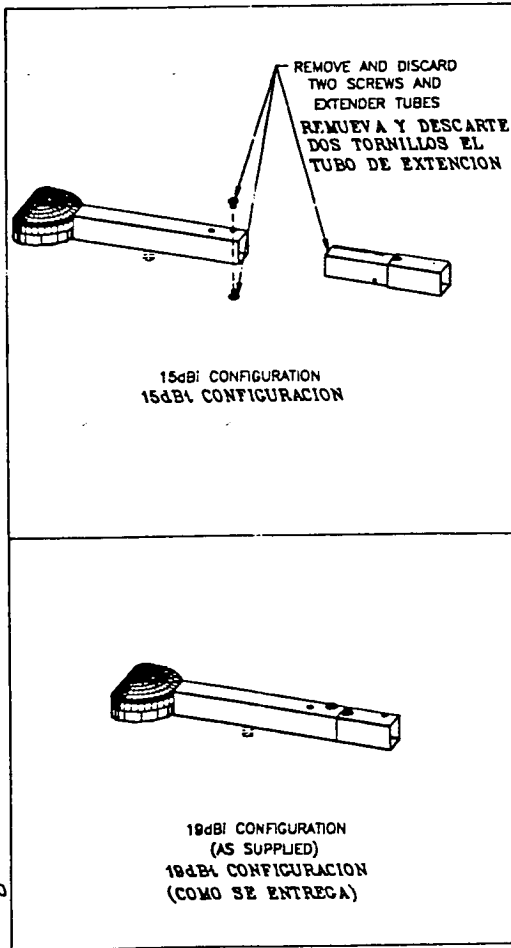

FIGURE FIGURA

③ INSTALLING DIPOLE TO REFLECTOR AND BRACKET
 INSTALACION DEL DIPOLE AL REFLECTOR Y SOPORTE

HORIZONTAL MOUNTING POSITION

HORIZONTAL POSICION DE MONTAJE

CONFIGURED DIPOLE
 (19dBi SHOWN)
 CONFIGURACION DEL DIPOLE

REFLECTOR
 (19dBi SHOWN)
 REFLECTOR
 (19dBi ILUSTRADO)

VERTICAL MOUNTING POSITION
POSICION DE MONTAJE VERTICAL

CONFIGURED DIPOLE
 (19dBi SHOWN)
 CONFIGURACION DEL DIPOLE
 (19dBi ILUSTRADO)

#8-32 x 1 3/8 SCREW
 TORNILLO

#8-32 LOCK NUT
 TUERCA DE SEGURIDAD

#8-32 x 1 3/8 SCREW
 TORNILLO

#8-32 LOCK NUT
 TUERCA DE SEGURIDAD

Grid Antenna Assembly

Assemble both halves of the antenna grid using the two stainless steel screws, washers and lock nuts provided (screws are installed in one half of grid boom when shipped). Be careful not to overtighten the lock nuts.

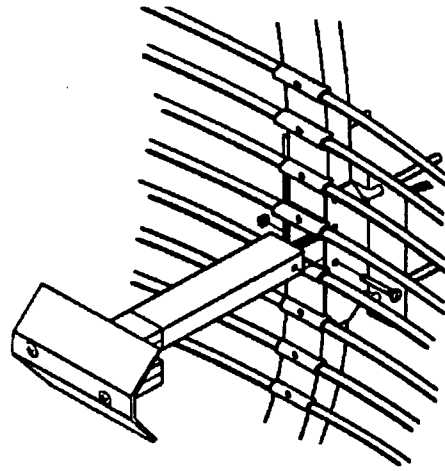

Install the antenna feedhorn using the tapping screw provided.

Grid Antenna Mounting

Install the grid antenna on the antenna mast using the two U-bolts, washers, nuts and brackets provided.

