

clarion®

Owner's manual & Installation manual
Mode d'emploi et manuel d'installation
Manual de instrucciones y de instalación

M502

Bluetooth® CD/USB/MP3/WMA RECEIVER
LECTEUR Bluetooth® CD/USB/MP3/WMA
RECEPTOR Bluetooth® CD/USB/MP3/WMA

CLARION PRODUCT REGISTRATION INFORMATION

For USA and Canada only
www.clarion.com

Dear Customer:

Congratulations on your purchase of a Clarion mobile electronic products. We are confident that you'll enjoy your Clarion experience.

There are many benefits to registering your product. We invite you to visit our website at www.clarion.com to register your Clarion product.

We have made product registration simple with our easy to use website. The registration form is short and easy to complete. Once you're registered, we can keep you informed of important product information.

Register at www.clarion.com - it's easy to keep your Clarion product up to date.

INFORMATIONS DE L'ENREGISTREMENT DE PRODUITS CLARION

Pour les États Unis et le Canada seulement
www.clarion.com

Cher client:

Nous vous remercions d'avoir acheté ce produit électronique mobile Clarion. Nous sommes confiants que vous apprécierez votre expérience Clarion.

Il y a beaucoup d'avantage à enregistrer votre produits. Nous vous invitons à visiter notre site Web www.clarion.com pour enregistrer votre produit Clarion.

Nous avons facilité la tâche d'enregistrement de produit simple et facile grâce à notre site Web. Le formulaire d'enregistrement est court et facile à compléter. Lorsque vous êtes enregistrer, nous pouvons vous tenir informé des informations important de produits.

Enregistrer à www.clarion.com - c'est facile de mettre à jour votre produit Clarion.

INFORMACIÓN DEL REGISTRO DE PRODUCTO DE CLARION

Para USA y Canada nomas
www.clarion.com

Querido Cliente:

Felicitaciones por su compra de producto electrónico móvil de Clarion. Estamos seguros que usted gozará de su experiencia con el producto de Clarion.

Hay muchas ventajas al registrar su producto. Le invitamos a que visite nuestro sitio en internet www.clarion.com para registrar su producto de Clarion.

Hemos hecho el registro de producto fácil en nuestro sitio. La forma de registro es corta y fácil de completar. Una vez que lo registre, podremos proporcionarle la información de su producto.

Regístrese en www.clarion.com - es fácil mantener su producto de Clarion actualizado.

Contents

Thank you for purchasing this Clarion product.

- Please fully read this owner's manual before operating this equipment.
- Check the contents of the enclosed warranty card and store it in a safe place with this manual.

1. FEATURES	2
Expanding Systems	2
2. PRECAUTIONS	2
Front Panel / Generalities	3
USB Port	3
3. CONTROLS	3
Operational Panel	3
Names of Button	3
Remote Control (RCX003)	4
Notes of remote control using	4
4. OPERATIONS	4
Basic Operations	4
System Setup	5
Audio Setup	6
Radio Operations	6
SiriusXM Satellite Radio Operations	6
USB Operations	8
iPod & iPhone Operations	9
Bluetooth Operations	10
AUX Operations	11
5. TROUBLE SHOOTING	12
6. ERROR DISPLAYS	12
7. SPECIFICATIONS	13
8. INSTALLATION / WIRE CONNECTION GUIDE	13
9. WARNING	16

1. FEATURES

- Built-in Bluetooth® Hands free(HFP) and Audio Streaming(A2DP & AVRCP)
- 4ch RCA Output with HPF/LPF and BEAT-EQ with 3 Band Parametric Equalizer
- SIRIUSXM Radio Direct Connect Ready



Expanding Systems

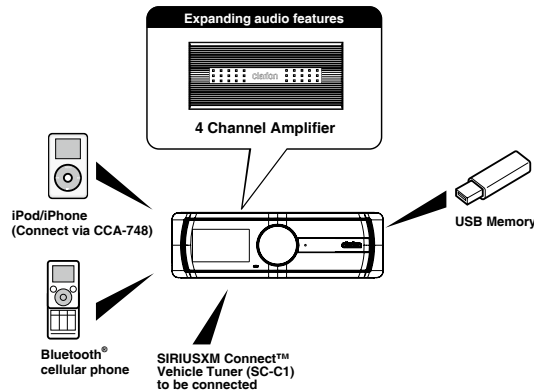

Note:

- The items listed outside of the frames are the commercial products generally sold.
- CCA-748 : Sold by separately.

2. PRECAUTIONS

⚠ WARNING

For your safety, the driver should not operate the controls while driving. Also, while driving, keep the volume to a level at which external sounds can be heard.

1. If you have parked the car for a long time in hot or cold weather, wait until the temperature in the car becomes normal before operating the unit.
2. Do not open the case, disassemble the unit, or lubricate the rotating parts.
3. FCC STATEMENT
 1. This device complies with Part 15 of the FCC Rules. Operation is subject to the following two conditions:
 - (1) This device may not cause harmful interference.
 - (2) This device must accept any interference received, including interference that may cause undesired operation.
 2. Changes or modifications not expressly approved by the party responsible for compliance could void the user's authority to operate the equipment.

NOTE: This equipment has been tested and found to comply with the limits for a Class B digital device, pursuant to Part 15 of the FCC Rules. These limits are designed to provide reasonable protection against harmful interference in a residential installation.

This equipment generates uses and can radiate radio frequency energy and, if not installed and used in accordance with the instructions, may cause harmful interference to radio communications. However, there is no guarantee that interference will not occur in a particular installation. If this equipment does cause harmful interference to radio or television reception, which can be determined by turning the equipment off and on, the user is encouraged to try to correct the interference by one or more of the following measures:

- Reorient or relocate the receiving antenna.
- Increase the separation between the equipment and receiver.
- Connect the equipment into an outlet on a circuit different from that to which the receiver is connected.

- Consult the dealer or an experienced radio/TV technician for help.
- 4. FCC Radiation Exposure Statement
This equipment complies with FCC radiation exposure limits set forth for an uncontrolled environment. This equipment should be installed and operated with minimum distance 20cm between the radiator & your bod.
- 5. "Made for iPod," and "Made for iPhone" mean that an electronic accessory has been designed to connect specifically to iPod, or iPhone, respectively, and has been certified by the developer to meet Apple performance standards.

Apple is not responsible for the operation of this device or its compliance with safety and regulatory standards. Please note that the use of this accessory with iPod or iPhone may affect wireless performance.

iPhone, iPod and iTunes are trademarks of Apple Inc., registered in the U.S. and other countries.

6. The Bluetooth word mark and logos are owned by the Bluetooth SIG, Inc. and any use of such marks by Clarion Co.,Ltd. is under license.
Other trademarks and trade names are those of their respective owners.
7. Pandora, the Pandora logo and other Pandora marks are trademarks or registered trademarks of Pandora Media, Inc. or its subsidiaries worldwide.
"If you have any issues with the Pandora application on your mobile phone, please direct them to pandora-support@pandora.com."
8. SiriusXM and all related marks and logos are trademarks of SiriusXM Radio, Inc. All rights reserved.

Front Panel / Generalities

For a longer service life, be sure to read the following cautions.

- Do not allow any liquids on the set from drinks, umbrellas, etc. Doing so may damage the internal circuitry.
- Do not disassemble or modify the set in any way. Doing so may result in damage.
- Do not let cigarettes burn the display. Doing so may damage or deform the body.
- If a problem should occur, have the set inspected at your store of purchase.

Cleaning the body

- Use a soft, dry cloth and gently wipe off the dirt.
- For tough dirt, apply some neutral detergent diluted in water to a soft cloth, wipe off the dirt gently, then wipe again with a dry cloth.
- Do not use benzene, thinner, car cleaner, etc., as these substances may damage the body or cause the paint to peel. Also, leaving rubber or plastic products in contact with the body for long periods of time may cause stains.

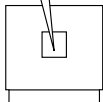

INFORMATION FOR USERS:

Changes or modifications to this product unapproved by the manufacturer will void the warranty and will violate FCC approval.

USB Port

- The USB memory sticks must be recognized as "USB mass storage class" to work properly. Some models may not operate correctly.

When the memorized data is lost or damaged by any chance, Clarion shall not be liable for any damage.

When using an USB memory stick, we recommend that you backup your data stored on it before using a personal computer etc.

- Data files may be broken when using USB memory sticks in the following situation: When disconnecting the USB memory stick or turning the power off during reading data. When affected static electricity or electric noise. Connect/disconnect the USB memory stick when it is not accessed.
- Connecting with the computer is not covered.

3. CONTROLS

Operational Panel

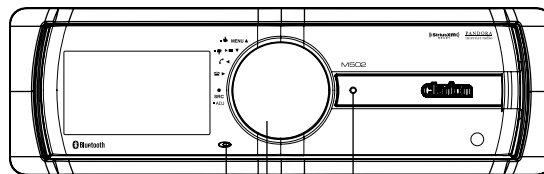

Names of Button

[CONTROL] Knob

- Power on (press)
- Power off (long press -> rotate it select "POWER OFF" ->press)
- Adjust volume level (rotate)
- Toggle the audio source (press)
- Previous/Next search (press - left/right)
- Select tuner band (press - up)(long press)

- **BT** mode – Terminate call
- **RADIO** mode – No function.
- **SIRIUSXM** mode – Direct search
- **AUX** mode – No function.
- **USB** mode – Search function
- **iPod** mode – iPod menu
- **PANDORA** mode – Station select

[MIC] Hole

- Internal microphone

Remote Control (RCX003)

[SRC/b] Button

- Toggle the audio source
- Power on (short press) / off (long press)

[◀, ▶] Buttons

- Preset station up / down
- Previous / next track
- Search (long press)

[SCN/PS/AS] Button

- Scan play / Preset scan
- Auto memory store (long press)

[BAND/TOP] Button

- MP3/WMA mode – Top play (long press)
- SIRIUSXM mode – Select tuner band, quit Replay(Replay mode) / Select category(long press)

[▲, ▼] Buttons

- Volume up / down

[▶/II] Button

- Play / Pause
- SiriusXM mode - Replay mode

[ISR] Button

- Recall ISR station stored in memory
- Store current station in ISR memory (long press)

[DISP] Button

- Display switch

[RDM] Button

- Random play

[RPT] Button

- Repeat play

[MUTE] Button

- Mute the volume

[1-6] Buttons

- [1] Button: Preset station 1.
- [2] Button: Preset station 2.
- [3] Button: Preset station 3.
- [4] Button: Preset station 4.
- [5] Button: Preset station 5.
- [6] Button: Preset station 6.

[SOUND] Button

- Sound effect setting

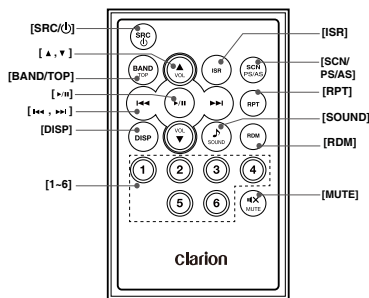

Notes of remote control using

Replacing the lithium battery of remote control unit.

When the range of the operation of the card remote control becomes short or no functions while operating. Replace the battery with a new lithium battery. Make sure the battery polarity replacement is correct.

1. Pull out the battery holder while pressing the stopper.
2. Insert the button-type battery with the stamped(+) mark facing upward.
Insert the battery holder into the remote control.



4. OPERATIONS

Basic Operations

Note:

- Refer to the diagrams in “3. CONTROLS” when reading this chapter.

CAUTION

When the unit is turned on, starting and stopping the engine with its volume raised to the maximum level may harm your hearings.
Be careful about adjusting the volume.

Power on / off

Notes:

- Start the engine before using this unit.
- Be careful about using this unit for a long time without running the engine. If you drain the car's battery too far, you may not be able to start the engine and this can reduce the service life of the battery.

1. Start the engine. The power button / knob illumination on the unit will light up.



2. Press the [CONTROL] knob on the front panel or [SRC / ϕ] button on the remote control to turn on the power under standby mode. The unit goes back to the last status after power on.
3. Press and hold the [CONTROL] knob (center long press) on the front panel, and rotate the [CONTROL] knob choose POWER OFF, then press the [CONTROL] knob on the front panel to turn off the power.
Or press and hold [SRC / ϕ] button on remote control to turn off the power.

Security password

Set:

After power on or reset, long press the [CONTROL] knob to select ADJUST, and press the [CONTROL] knob (left / right) to select CODE, then press the [CONTROL] knob to set password.
Rotate the [CONTROL] knob (left / right) to select a digit, and press the knob to confirm, after input all 4 digit.

Delete:

Delete the password of operation is the same as setting password.

Mute

Press the [MUTE] button on the remote control to mute the volume from the unit.

Note:

Doing the operation above again or adjusting volume will release muting.

Volume adjustment

Turn the [CONTROL] knob on the front panel. The adjustable range of volume is 0 to 40.

CAUTION

While driving, keep the volume level at which external sounds can be heard.

Playing source selection

Press [CONTROL] knob on the front panel repeatedly to choose desired playing source.

Note:

- Playing source selection means selecting work mode, such as RADIO mode and AUX mode, etc.

Display system time

Press the [DISP] button on the remote control to switch the display information, system time and playing source.

RESET

Note:

* When the [RESET] button is pressed, frequencies of radio stations, titles, etc. stored in memory are cleared.

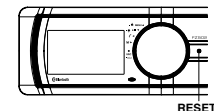

System Setup

At all mode, press and hold **[CONTROL]** knob (center long press), and rotate the **[CONTROL]** knob choose **ADJUST**, then press the **[CONTROL]** knob to enter system setup. Press **[CONTROL]** knob (left / right) to select options, rotate the **[CONTROL]** knob to adjust.

PCH MEMO (RADIO/SIRIUSXM mode)

Rotate the **[CONTROL]** knob to choose PCH 1 / PCH 2 / PCH 3 / PCH 4 / PCH 5 or PCH 6, press and hold **[CONTROL]** knob (center long press) to store it in the memory.

CLOCK

Press the **[CONTROL]** knob (right) to choose minute, and rotate the **[CONTROL]** knob to set minute.

Press the **[CONTROL]** knob (left) to choose hour, and rotate the **[CONTROL]** knob to set hour.

Then long press **[CONTROL]** knob (center) to confirm the time setting.

DX/LO (RADIO mode)

Rotate the **[CONTROL]** knob to choose radio local or distant at **RADIO** mode.

- **LO:** Only stations with strong signal can be received.
- **DX:** Stations with strong and weak signals can be received.

SELECT (BT mode)

This "SELECT" menu is intended to automatically paired by selecting a mobile phone was stored.

This unit can store three mobile phones. The mobile phone will be stored in paired order to the unit. The mobile phone can be stored up to three. The fourth mobile phone can not be stored. If you want to store a fourth mobile phone, please delete unwanted mobile phone from "SELETE" menu.

1. Rotate the **[CONTROL]** knob to choose the pair mobile phone name from the pairing list.
2. Press and hold the **[CONTROL]** knob to confirm.

DELETE (BT mode)

1. Rotate the **[CONTROL]** knob to choose the paired mobile phone name from the pairing list.
2. Press and hold the **[CONTROL]** knob to confirm.

DISCON (BT mode)

Disconnect currently connected mobile phone.

1. Rotate the **[CONTROL]** knob, mobile phone displays are currently connected.
2. Press and hold the **[CONTROL]** knob to disconnect.

PASSWORD (SIRIUSXM mode)

Press the **[CONTROL]** knob to enter old password, rotate the **[CONTROL]** knob to select a digit, press the **[CONTROL]** knob (left / right) to move the cursor. Press the **[CONTROL]** knob to confirm after input all 4 digit. Then input a new 4-digit number as above. (Original password: 0000)

LOCK (SIRIUSXM mode)

Press the **[CONTROL]** knob to lock current station, rotate the **[CONTROL]** knob to select a digit, press the **[CONTROL]** knob (left / right) to move the cursor. Long press the knob to confirm after input all 4 digit password.

UNLOCK (SIRIUSXM mode)

Press the **[CONTROL]** knob to unlock all locked stations, rotate the **[CONTROL]** knob to select a digit, press the **[CONTROL]** knob (left / right) to move the cursor. Press the **[CONTROL]** knob to confirm after input all 4 digit password.

UNSKIP (SIRIUSXM mode)

Press and hold the **[CONTROL]** knob to unskip all channels.

AUX SENS (AUX mode)

Rotate the **[CONTROL]** knob to choose AUX input sensitivity LOW, MID or HIGH at **AUX** mode.

MIC SEL (BT mode)

Rotate the **[CONTROL]** knob to choose microphone EXTERNAL or INTERNAL.

System Setup

MIC GAIN (BT mode)

Rotate the **[CONTROL]** knob to choose Mic gain: 1, 2, 3, 4, 5.
You can change the gain of MIC when a telephone partner cannot hear your voice.

TONE SEL (BT mode)

You can get mobile phone ring tone from the speaker.

Rotate the **[CONTROL]** knob to choose AUTO or INTERNAL.

- **AUTO:**
Mobile phone ring tone from the speaker.
- **INTERNAL:**
The unit original ring tone from the speaker.

AUTO ANS (BT mode)

To answer incoming calls automatically.

Rotate the **[CONTROL]** knob to choose AUTO ANS ON or OFF.

AUTO CON (BT mode): ON/OFF

Rotate the **[CONTROL]** knob to choose AUTO CON ON or OFF.

PIN CODE

Press the **[CONTROL]** knob, rotate the **[CONTROL]** knob to select a digit, press the **[CONTROL]** knob (left / right) to move the cursor. Press the **[CONTROL]** knob to confirm.

The PIN CODE default setting is "0000".

SCRN SVR: ON/OFF

Rotate the **[CONTROL]** knob to choose SCRAN SVR (screen saver) ON or OFF.

SCROLL: ON/OFF

For track information that is longer than the display panel:

When SCROLL is ON, the LCD will display ID3 TAG information cyclely, e.g.: TRACK->FOLDER->FILE->ALBUM->TITLE->ARTIST->TRACK->...

When SCROLL is OFF, the LCD will display one of the ID3 TAG information, the default is TRACK, but user can adjust it to other ID3

TAG information by pressing **[DISP]** button on the remote control.

S-CTRL (iPod mode) : ON/OFF

Rotate the **[CONTROL]** knob to choose S-CTRL (Simple control) ON or OFF.
* Refer to P9.

DIMMER: ON/OFF

Rotate the **[CONTROL]** knob to choose DIMMER ON or OFF.

- **ON:** LCD dimmer is active when small light of vehicle is turned ON.
- **OFF:** LCD always maximum brightness regardless of the vehicle small light.

REAR/S-W

Rotate the **[CONTROL]** knob to choose REAR or S-WOOFER(SUB-WOOFER).

SW PHASE

Rotate the **[CONTROL]** knob to choose REVERSE or NORMAL.

BEEP: ON/OFF

Rotate the **[CONTROL]** knob to choose button beep sound ON or OFF.

12/24H

Rotate the **[CONTROL]** knob to choose time format: 12 or 24 hours.

Audio Setup

Press the **[CONTROL]** knob to choose SOUND. First press shows current EQ. Rotate the **[CONTROL]** knob to choose BEAT EQ in this order:

OFF -> B-BOOST -> IMPACT -> EXCITE -> CUSTOM

To change CUSTOM setting, and press the **[CONTROL]** knob (center), then press **[CONTROL]** knob (right/left) to select EQ effects including: BASS-G -> BASS-F -> BASS-Q -> MID-G -> MID-F -> MID-Q -> TREBLE-G -> TREBLE-F, rotate the **[CONTROL]** knob to select a value.

BASS-G / MID-G / TREBLE-G: (-7)-(+7)

BASS-F: 50 / 100 / 200

BASS-Q : 0.7 / 1.0 / 1.4 / 2.0

MID-F: 500 / 1 K / 2 K

MID-Q: 0.7 / 1.0 / 1.4 / 2.0

TREBLE-F: 5 K / 10 K / 15 K

TREBLE-Q: 0.7 / 1.0 / 1.4 / 2.0

Then press the **[CONTROL]** knob (left / right) to select USER preset including:

BALANCE -> FADER -> M-B EX -> HPF(high pass filter) -> LPF(low pass filter) -> S-W VOL (Subwoofer Volume), rotate the **[CONTROL]** knob to select a value.

BALANCE:LEFT 1-7->CENTER->RIGHT 1-7

FADER:FRONT 1-7->CENTER->REAR 1-7

M-B EX: ON/OFF

HPF: THROUGH/60/90/120

LPF: THROUGH/60/90/120

SUBW VOL: (-6)-(+6)

Radio Operations

Select tuner as playing source

Press the **[CONTROL]** knob or **[SRC / ⏏]** button on the remote control to switch to the **RADIO** source.

Select one radio band

Press the the **[CONTROL]** knob (up long press) on the panel or **[BAND/TOP]** button on the remote control to select one radio band among FM1, FM2, FM3 and AM.

Manual tuning

During manual tuning, the frequency will be changed in steps.

Press **[CONTROL]** knob (left/right) on the panel or **[◀ ▶]** buttons on the remote control to tune in a higher / lower station.

Auto tuning

Press and hold **[CONTROL]** knob (left/right) on the panel or **[◀ ▶]** buttons the remote control to seek a higher / lower station. To stop searching, repeat the operation above or press other buttons having radio functions.

Note:

When a station is received, searching stops and the station is played.

Preset scan

Preset scan receives the stations stored in preset memory in order. This function is useful when searching for a desired station in memory.

1. Press the **[SCN/PS/AS]** button on the remote control.
2. When a desired station is tuned in, press the **[SCN/PS/AS]** button on the remote control again to continue receiving that station.

Note:

Be careful not to press and hold the **[SCN/PS/AS]** button, otherwise the auto store function is engaged and the unit starts storing stations.

Auto store

Only stations with sufficient signal strength will be detected and stored in the memory. Press and hold the **[SCN/PS/AS]** button on the remote control to start automatic station search. To stop auto store, press other buttons having radio functions.

Notes:

1. After auto store, the previous stored stations will be overwritten.
2. The unit has 4 bands, such as FM1, FM2, FM3 and AM. FM3 and AM can store by AS

Radio Operations

function. Each bands can store 6 stations, M502 can store 24 stations in total.

Manual store

When one expected radio station has been detected, press and hold number button on the remote control 1-6 to store it in the memory.

Recall the stored stations

Press one numeric button among 1 to 6 on the remote control or on the panel to select the corresponding stored station.

Local seeking

When LOCAL seeking is on, only those radio stations with strong radio signal could be received.

Refer to System Setup page 5.

Note:

The number of radio stations that can be received will decrease after the local seeking mode is on.

SiriusXM Satellite Radio Operations

Displaying the Identification (ID) Code

Before you listen to satellite radio, you must subscribe to the service using the SiriusXM Radio ID number.

1. Press **[SRC / ⏏]** button to activate SiriusXM-mode.
2. Press the **[CONTROL]** knob (left/right) to select channel "0".
The unit displays Radio ID.

Notes:

1. The Radio ID is located on the bottom of the SiriusXM Connect Vehicle Tuner.
2. Please note that the SiriusXM Radio ID does not include the letters I, O, S or F.
3. Activate the SiriusXM Connect Vehicle Tuner using one of the two methods below:
 - Online: Go to "www.siriusxm.com/activatenow" and choose ACTIVATE RADIO.
 - Phone: Call 1-800-XM-RADIO (1-800-967-2346).

Storing Channel Presets

1. Press **[BAND/TOP]** button on the remote control or long-press **[CONTROL]** (up) on the front panel to select the desired band you want to store the preset in. There are 3 Satellite Radio Preset bands.

Each press of **[BAND/TOP]** button on the remote control changes the band:

SXM1 -> SXM2 -> SXM3 -> SXM1

2. Tune to the desired channel and then press and hold one of the preset buttons (1 through 6) on the remote control to store the channel.
3. Repeat the procedure to store up to 5 other channels on to the same band.

Note:

- A total of 18 channels can be stored in the preset memory, 6 channels for each band (SXM1, SXM2 and SXM3).

Tuning Channels using Presets

1. Press **[BAND/TOP]** on the remote control to select the desired band of Presets you wish to access.
2. Press **[CONTROL]** knob (up/down) to the preset buttons (1 through 6) that has your desired Satellite Radio channel stored in memory.

Category Browsing

1. Long-press and hold **[BAND/TOP]** on the remote control to activate the Category Browsing mode.
2. Rotate **[CONTROL]** knob to select desired category.

SiriusXM Satellite Radio Operations

- Press **[CONTROL]** knob (left/right) to select desired channel within the selected Category. You can see channel name, channel number, artist, title or content by pressing **[DISP]** on the remote control.
- Press **[CONTROL]** knob to tune to selected channel.

Note:

- If no operation is performed for 10 seconds, the Category Browsing mode is canceled.

Artist & Song Alerts

While listening to SiriusXM Satellite Radio, you can be alerted when your favorite songs or artists are playing on other channels. The radio will display an Alert message when a matching artist or song is found on another channel. Then you can choose if you want to tune to that favorite or you can ignore it and stay on your current channel. Information on setting up the Artist and Song alerts is described below.

- While listening to favorite song, short-press **[RPT]** button on the remote control to add the artist or long-press **[RPT]** on the remote control button to add the song to the "Artist & Song Alerts" list.
- Rotate **[CONTROL]** knob and select **"YES"**, and press **[CONTROL]** knob to store item.
- Rotate **[CONTROL]** knob and select **"NO"**, and press **[CONTROL]** knob to quit.
- Press and hold **[CONTROL]** knob (center long press), and rotate the **[CONTROL]** knob to choose **ADJUST**, then to choose the **SEARCH**, and rotate **[CONTROL]** knob to select **"ALERT LIST"**. Rotate and press **[CONTROL]** knob to select desired alert item. Then select **"ON"** to activate alert, **"OFF"** to deactivate or **"DELETE"** to delete this item. (press and hold **[CONTROL]** knob) You can also activate and deactivate Alert function in System Setup menu.

Notes:

- You can store up to 50 items for Artist & Song Alerts. "XU(sect)/YE(mpty)" is displayed when the new item is stored. X is the total number of song titles or artist names stored in memory, and Y is the total number memory locations still available for storage.
- If either the artists or song title is not available, **"NO SONG"** or **"NO ARTIST"** will be displayed.
- If you try to store item when memory is full, **"MEMORY FULL"** is displayed. If you want to store another, please delete existing alert item.

Receiving and Tuning to an Alert

Whenever a stored artist or song is playing on another channel alert message, **"ART ALERT"** or **"SNG ALERT"** appears on the unit display. To tune to artist or song identified by the alert, press **[CONTROL]** knob.

Notes:

- If no operation is performed for 5 seconds, the unit returns to normal mode.
- Artist name and Song title which you have stored and which are currently playing will be displayed in category called **"MY MUSIC"** in search mode.

My Music search

You can access the channels which is broadcasting the contents in the activated Alert list.

- Press and hold **[CONTROL]** knob (center long press), and rotate the **[CONTROL]** knob to choose **ADJUST**, then to choose the **SEARCH**, and rotate **[CONTROL]** knob to select **"MY MUSIC LIST"**.
- Press **[CONTROL]** knob to display matched songs which are currently broadcasted
- Rotate **[CONTROL]** knob to select desired song, and press **[CONTROL]** to tune to that channel.

Note:

- If there is no matched songs broadcasted, it displays **"MEM EMPTY"**.

SiriusXM Satellite Radio Operations

Replay function

The Replay feature allows you to pause, rewind, and replay up to 30 minutes of live SiriusXM Satellite Radio.

- While listening to a SiriusXM channel, press **[▶|◀]** on the remote control to enter Replay mode. The display will show **"PAUSE"** when entering this mode.
- Press and hold **[CONTROL]** knob (down short press) or press **[▶|◀]** button to resume playback of the stored audio from the point at which it was paused. During playback, the SiriusXM Tuner will continue to store the channel audio until you exit the Replay mode.

During REPLAY playback:

- Fast rewind: Press and hold **[CONTROL]** knob (left).
- Fast forward: Press and hold **[CONTROL]** knob (right).
- Returning to the beginning of the current song: Press **[CONTROL]** knob (left). (If you press **[CONTROL]** knob (left) in the first 2 seconds of a song, you return to the beginning of the previous song.)
- Advancing to the beginning of the next song: press **[CONTROL]** knob (right).
- Long-press **[BAND/TOP]** to finish Replay mode.

Notes:

- If you continue to press **[CONTROL]** knob (right) until the end, the Replay mode is canceled, and the unit will change to live SiriusXM radio mode.
- If you change channels while in Replay mode, the unit will exit Replay mode to live Satellite mode and clear the Replay memory.
- Replay mode is being kept when you change the source other than SiriusXM mode.

iTunes song tagging

With iTunes song tagging, you can tag songs you hear while listening to SiriusXM Satellite Radio. The tagging information is saved in your radio until you connect your iPod

or iPhone and then the tagging information is transferred to your iPod/iPhone. When your iPod/iPhone to iTunes, you will then be able to preview and purchase the song that you heard while listening to SiriusXM Satellite Radio. Information on using the iTunes song tagging feature is described below.

- A song may be tagged while listening to a SiriusXM channel if the display shows the **"TAG"** icon.
- Press **[ISR]** button on the remote control while the desired song is playing.
- When completed, **"STORED TAG X OF 64"** is displayed. X means the number of tag stored.

Notes:

- During tagging, the iPod/iPhone takes priority to save the tag information. If no iPod/iPhone is connected, the tag information is saved to this unit.
- This unit can store up to 64 pieces of tag information. When the memory of the unit is full, **"MEMORY FULL"** may be displayed.
- When iPod/iPhone that doesn't support the tagging function is connected, **"TRANSFER FAIL"** may be displayed.
- If there is stored tag information on the unit, when an iPod/iPhone supporting the tag function is connected, the stored tag information will be transferred to iPod/iPhone automatically.
- If tag information already exists, **"ALREADY TAGGED"** will be displayed when you try to tag information again.
- Tagging may be canceled by changing the frequency or station.
- If a song is tagged and the remaining storage volume of the connected iPod/iPhone is sufficient to hold the song's tag information, it will be saved on the iPod/iPhone.

Changing the Display

Text information, such as the channel name, artist name/feature, song/program title and content is available with each SiriusXM channel. The unit can display this text information as

SiriusXM Satellite Radio Operations

explained below.

1. In SiriusXM mode, press [DISP] button on the remote control.

Each time you press this button, the display changes as shown below.

Band/Channel number/channel name =>
Artist Name => Song Title=> Content Info
=> Category Name => Clock => Band/
Channel number/channel name

- * If there is no text information, nothing will be displayed.

Parental Lock / Unlock

The SiriusXM Parental Control feature allows you to control access to channels that you consider inappropriate for younger listener. When enabled, the Parental Control feature requires you to enter a password to tune to the locked channels. Information on setting up the password, setting up the channels to be locked, and the method to access the locked channels is described below.

1. Long-press [CONTROL] knob and select **ADJUST**, then press [CONTROL] knob to enter and press [CONTROL] knob (right) to select "**PARENTAL PASSWORD**".

Press [CONTROL] knob to change password. Enter old password, new password. To enter code, rotate [CONTROL] knob to decide number and [CONTROL] knob (left/right) to select digit. Each time you need to press and hold [CONTROL] knob to confirm password. (Original password is "0000", after input four numbers, then long-press the [CONTROL] knob)

2. Long-press [CONTROL] knob and select **ADJUST**, then press [CONTROL] knob to enter and press [CONTROL] knob (right) to select "**LOCK CH**" and press [CONTROL] knob to start to lock channel. You will be asked to input password. Enter password and "**LOCK**" will be displayed if it is successful.
3. Long-press [CONTROL] knob and select **ADJUST**, then press [CONTROL] knob to enter and press [CONTROL] knob (right)

to select "**UNLOCKCH**". Enter password and you can unlock the channel.

4. For accessing the locked channels, select channel by "**DIRECT SELECT**". Press and hold [CONTROL] and select "**DIRECT SELECT**" by pressing [CONTROL] knob. Input desired locked channel (need to input 3 digit) and input password, then you can tune to that locked channel.

USB Operations

1. Insert a USB device into the rear of the unit USB cable.

When connecting a USB device, the unit will read the files automatically.

2. To remove the USB device, you should first select another source or turn off the power, in order to avoid damaging the USB device. Then take off the USB device. Move the cover to the right.

Pausing play

1. Press the [▶/||] button on the remote control to pause play.
"PAUSE" appears in the display.
2. To resume MP3/WMA play, press the [▶/||] button on the remote control again.

Selecting a track

Track-up

1. Press the [CONTROL] knob (right) on the panel or [▶] button on the remote control to move to the beginning of the next track.
2. Each time you press the [CONTROL] knob (right) on the panel or [▶] button on the remote control, the track advances to the beginning of the next track.

Track-down

1. Press the [CONTROL] knob (left) on the panel or [◀] button on the remote control to move back to the beginning of the current track.
2. Press the [CONTROL] knob (left) on the panel or [◀] button on the remote control to move back to the beginning of the previous track.

Fast-forward/Fast-reverse

Fast-forward

Press and hold the [CONTROL] knob (right) on the panel or [▶▶] button on the remote control.

Fast-reverse

Press and hold the [CONTROL] knob (left) on the panel or [◀◀] button on the remote control.

- * For MP3/WMA USB device, it takes some time until the start of searching and between

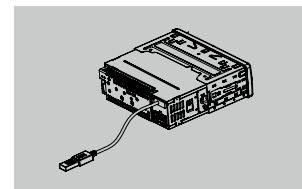

tracks. In addition, some errors may occur in the play time.

Folder Select

This function allows you to select a folder containing MP3/WMA files and start playing from the first track in the folder.

1. Press and hold [CONTROL] knob (up) on the panel.
Press and hold [CONTROL] knob (up) on the panel to move the next folder.
2. To select a track, press the [CONTROL] knob (right / left) on the panel or [◀▶] button on the remote control.

Search Function

1. Press the [CONTROL] knob (up) to enter FOLD SCH mode, and press [CONTROL] knob (center) to confirm, then rotate [CONTROL] knob to select the folder list search mode.
 2. Rotate the [CONTROL] knob to select a folder.
 3. Press the [CONTROL] button (center) to enter the file list search mode. And then the track list appears in the display.
 4. Turn the [CONTROL] knob to select a track.
 5. Press the [CONTROL] knob (center) to play.
- * When play back MP3 / WMA file, this function is performed in the current folder.

Top function

The top function resets the USB player to the first track of the USB device. Press and hold the [CONTROL] knob (down) to play the first track (track No. 1) on the USB device.

USB Operations

* In case of MP3/WMA, the first track of the current folder will be played.

Other various play functions

Scan play

This function allows you to locate and play the first 10 seconds of all the tracks recorded on a USB.

Press the [**SCN/PS/AS**] button on the remote control to perform scan play.

Repeat play

This function allows you to play the current track repeatedly or play a track currently being played in the MP3/WMA folder repeatedly.

1. Press the [**RPT**] button on the remote control once or more until "**TRK RPT**" appears on the display to perform repeat play, and "**RPT**" segment lights on.

2. For MP3/WMA files, press [**RPT**] button on the remote control repeatedly until "**FOLD RPT**" appears on the display for folder repeat play.
3. Press [**RPT**] button on the remote control repeatedly until "**RPT OFF**" appears on the display to cancel repeat playback, and "**RPT**" segment goes off.

Random play

This function allows you to play all tracks recorded on a USB device in a random order.

Press the [**RDM**] button on the remote control to perform random play.

iPod & iPhone Operations

Connect

Connect your iPod or iPhone to the USB slot via CCA-748 cable.

When connecting a device, the unit will read the files automatically. The track information display on the screen once playback start.

MENU

In the S-CTRL OFF mode, press the [**CONTROL**] knob (up), rotate the knob select "**MUSIC**" or "**VIDEO**".

Select "**MUSIC**", press the [**CONTROL**] knob, then rotate the [**CONTROL**] knob to show **PLAY LISTS / ARTISTS / ALBUMS / GENRES / SONGS / COMPOSERS**, then press the [**CONTROL**] knob to confirm.

Select "**VIDEO**", press the [**CONTROL**] knob, then rotate the [**CONTROL**] knob to show **MOVIES / MUSIC VIDEO / TV SHOWS / VIDEO PODCASTS / RENTALS**, then press the [**CONTROL**] knob to confirm.

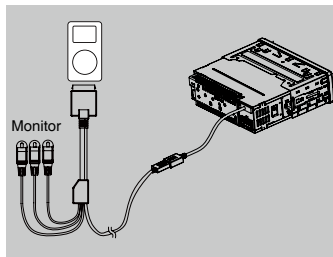

Note:

- In case of VIDEO Playback, CCA-748 cable and monitor (sold separately) are required.
- VIDEO MENU item is different by the model of connected iPod and language setting.

iPod & iPhone Operations

Repeat play

This function allows you to play the current track repeatedly or play all tracks in your iPod/iPhone repeatedly.

1. Press the [**RPT**] button on the remote control once or more until "**RPT ON**" appears on the LCD to perform repeat play.
2. Press [**RPT**] button on the remote control repeatedly until "**RPT OFF**" appears on the LCD to cancel repeat playback.

Random play

This function allows you to play all tracks in a random order.

1. Press the [**RDM**] button on the remote control once or more until "**RDM ALBUM**" appears on the LCD for album random play.
2. Press the [**RDM**] button on the remote control once or more until "**RDM SONG**" appears on the LCD to perform random play.
3. Press the [**RDM**] button on the remote control once or more until "**RDM OFF**" appears on the LCD to cancel random playback.

Setting iPod simple control mode

Use this function if you wish to operate through your iPod connected to this unit via the USB cable.

* The factory default setting is "**OFF**".

1. Press and hold [**CONTROL**] knob (center), and rotate the [**CONTROL**] knob choose **ADJUST**, then press the [**CONTROL**] knob (center) to enter system setup.
2. Rotate the [**CONTROL**] knob (left / right) to select "**S-CTRL**".
3. Rotate the [**CONTROL**] knob to select "**ON**" or "**OFF**".
 - **ON**: Operations are made through your iPod.
 - **OFF**: Operations cannot be made through your iPod.

Notes:

- When performing iPod operations using simple control mode, make the operations slowly. If repetitive operations are performed too quickly, unforeseen errors may occur.
- When performing iPod operations using simple control mode, please do not operate the iPod and the unit at the same time, otherwise there may be unexpected event happened.
- Some iPod models do not support this function. Consult your nearest **Clarion** dealer or website to confirm which models do not support this function.

iPod menu alphabet search

This function searches the subfolders for desired alphabetical letters.

1. Press the [**CONTROL**] knob (up), and rotate [**CONTROL**] knob to select the iPod menu mode.
2. Rotate the [**CONTROL**] knob to switch between categories.
MUSIC: PLAYLISTS, ARTISTS, ALBUMS, GENRES, SONGS, COMPOSERS
VIDEO: MOVIES, MUSIC VIDEOS, TV SHOWS VIDEO PODCASTS, RENTALS
3. Press the [**CONTROL**] knob. (The contents of the category are displayed.)
4. Press and hold the [**CONTROL**] knob (down).
5. Rotate the [**CONTROL**] knob to select the desired letter to search.
6. Press the [**CONTROL**] knob to perform search.

Listening to PANDORA

You can listen to PANDORA internet radio by connecting an iPod/iPhone that has PANDORA Application already installed.

To start streaming, connect the iPod/iPhone with PANDORA already launched.

When the unit displays "**PLEASE LAUNCH PANDORA APPLICATION ON MOBILE DEVICE**" in PANDORA mode, please launch the PANDORA Application by operating the iPod/iPhone connected.

1. Press the [**CONTROL**] knob (up) to enter **FOLD SCH** mode.

iPod & iPhone Operations

Selecting a station from list

Rotate the [CONTROL] knob to select "BY DATE" or "A-Z" and press the [CONTROL] knob to confirm.

- BY DATE: List in an created date order
- A-Z: List in an alphabetical order

Go to next station or previous station(an alphabetical order)

Press the [CONTROL] knob (right) on the panel or [▶▶] button on the remote control to go to next station.

Press the [CONTROL] knob (left) on the panel or [◀◀] button on the panel or remote control to go to previous station.

Thumbs up/down

1. Press the [RDM] button on the remote control for the thumbs up.
2. Press the [SCN] button on the remote control for the thumbs down.

Notes:

- You can personalize your stations by "thumbs up" or "thumbs down".
- PANDORA limits the number of thumbs down allowed on their service.
If you attempt to thumbs down songs beyond the limit, the current song continues to playback.

BOOKMARK artist or song

Press the [RPT] button on the remote control to Bookmark artist.

Press the [RPT] button on the remote control to Bookmark current artist of the song.

Skip

Press the [BAND/TOP] button on the remote control for the next song in station.

Note:

- PANDORA limits the number of skips allowed on their service. If you attempt to skip songs beyond the limit, "SKIP LIMIT" is displayed.

Play/Pause

Press the [▶|] button on the remote control for play/ pause.

Bluetooth Operations

The Bluetooth allows you to utilize your car's built-in audio system for wireless mobile phone or music handsfree communication. Some Bluetooth mobile phones have the audio features, and some portable audio players support Bluetooth feature. This system can play audio data stored in a Bluetooth audio device. The car stereo with Bluetooth will be able to retrieve phonebook contacts, received call, dialed call, missed call, incoming calls, outgoing call and listen to music.

Notes:

- Leaving it exposed to high temperatures or direct sunlight can cause distortion or discoloration which may result in a malfunction.
- This system will not operate or may operate improperly with some Bluetooth audio players.
- Clarion cannot guarantee the compatibility of all mobile phones together with unit.
- Audio playback will be set to the same volume level as set during telephone call. This might cause problems, if extreme volume level is set during telephone call.

Handsfree Operations

Pairing

1. Turn on Bluetooth function of your mobile phone.
2. Enter mobile phone's Bluetooth setup menu.
3. Search for new Bluetooth devices.
4. Select **M502** from the pairing list on the mobile phone.
5. Enter "0000" as the password (The password default setting is "0000").
6. After pairing successfully, the unit will enter Bluetooth mode automatically, and "BLUETOOTH CONNECTED" will appear on the LCD.

Making a call

Operation from Bluetooth menu

Press the [CONTROL] knob to switch the source to "BLUETOOTH".

• Dial Number

Press and hold the [CONTROL] knob (center) choose **ADJUST**, then rotate the [CONTROL] knob select **CALL LST**.

1. Press the [CONTROL] knob.
2. Rotate the [CONTROL] knob on the front panel to switch: **DIAL NUMBER / DIALLED CALL / MISSED CALL / RECEIVED CALL / MEMORY PHONEBOOK / SIM PHONEBOOK**
3. Press the [CONTROL] knob to confirm the selection, "WAITING" will appear on the LCD.
4. Press the [CONTROL] knob to dial.
5. Press the [CONTROL] knob (right) to terminate call.

• Dialed/Missed/ Received Call History

You can search any Dialed/Missed/Received Call History.

1. Rotate the knob to select "DIALED CALL", "MISSED CALL" or "RECEIVED CALL".
 2. Press the knob to enter the selected call history.
 3. Rotate the [CONTROL] knob to scroll the contacts.
 4. When the contact name or mobile phone No. is displayed, press the [CONTROL] knob (center) to call the mobile phone No. of that contact.
- * Press the [CONTROL] knob (right) to end the call.

• Call from Phonebook

User can search the contact name in the phonebook and make call.

1. Rotate the [CONTROL] knob to select "SIM PHONE BOOK" or "MEMORY PHONE BOOK".
 2. Press the [CONTROL] knob (center) to enter the selected phonebook.
 3. Rotate the [CONTROL] knob to scroll the contacts.
 4. When the contact name is displayed, press the [CONTROL] knob (center) to call the mobile phone No. of that contact.
- * Press the [CONTROL] knob (right) to end the call.

Bluetooth Operations

• Answering a call

You can answer an incoming call by pressing the [CONTROL] knob.

* Press the [CONTROL] knob (right) to reject an incoming call.

Audio Streaming Operations

What is audio streaming?

Audio streaming is a technique for transferring audio data such that it can be processed as a steady and continuous stream. Users can stream music from their external audio player to their car stereo wirelessly and listen to the tracks through the car's speakers. Please consult your nearest Clarion dealer for more information on the product of wireless audio streaming transmitter offered.

⚠ CAUTION

Please avoid operating your connected mobile phone while audio streaming as this may cause noise or sound choppy on the song playback.

Audio streaming may or may not resume after telephone interrupt as this is dependent on mobile phone.

System will always return to Radio mode if audio streaming is disconnected.

Note:

Be sure to read the chapter "Pairing" before proceeding.

Play / Pause a track

1. Push the [CONTROL] knob (down) to pause audio playback.
2. To resume audio playback, push the [CONTROL] knob (down) again.

Selecting a track

Track-up

1. Press the [CONTROL] knob (right) to move to the beginning of the next track.
2. Each time the [CONTROL] knob (right) is pressed, playback proceeds to another track in the advancing direction.

Track-down

1. Press the [CONTROL] knob (left) to move to the beginning of the previous track.
2. Each time the [CONTROL] knob (left) is pressed, playback proceeds to previous track in the reverse direction.

Note:

Playing order will depend on Bluetooth audio player. When [CONTROL] knob (left) is pressed, some A2DP devices will restart the current track depends on the duration of playback.

During music streaming playback, "A2DP" will be shown on the display. Information about tracks (e.g. the elapsed playtime, song title, etc.) cannot be displayed on this unit. When A2DP device is disconnected, "DISCONNECT" will be shown on the display

and return to previously selected audio source. Some Bluetooth audio players may not have play / pause synchronized with this unit. Please make sure both device and main unit are in the same play / pause status in **BT MUSIC** mode.

AUX Operations

Press the [CONTROL] knob on the panel or [SRC/0] button on the remote control once or more to select "AUX".

AUX is just for audio content with 3.5mm Jack connector plugged into audio-in socket on the front panel on the right of USB slot.

AUX Input sensitivity setting

1. Press and hold the [CONTROL] knob .
2. Turn the [CONTROL] knob to select "AUX SENS".
3. If the output level of connected external audio player is "HIGH", rotate the [CONTROL] knob and choose "LOW". And if the output level is "LOW", choose "HIGH".

5. TROUBLE SHOOTING

GENERAL

Problem	Cause	Measure
Unit can not power on.	Unit fuse blown.	Replace with new fuse of correct rating.
	Car battery fuse blown.	Replace with new fuse of correct rating.
Unit can not power on. Nothing happens when buttons are pressed.	The microprocessor has malfunctioned due to noise, etc.	Turn off the power. Press the [RESET] button with a thin rod.
Display is not accurate.		Note: When the [RESET] button is pressed, turn off the ACC power.*
No/low audio output.	Improper audio output connection.	Check wiring and correct.
	Volume set too low.	Increase volume level.
	Speakers damaged.	Replace speakers.
	Heavily biased volume balance.	Adjust the channel balance to center position.
Poor sound quality or distortion.	Speaker wiring is in contact with metal part of car.	Insulate all speaker wiring connections.
	Speaker power rating does not match unit.	Replace speakers.
	Wrong connections.	Check wiring and correct.
Unit resets itself when engine is off.	Speaker is shorted.	Check wiring and correct.
	Incorrect connection between ACC and Battery.	Check wiring and correct.

USB Devices

Problem	Cause	Measure
USB device cannot be inserted.	The USB device has been inserted with wrong direction.	Reversing the connection direction of the USB device, try it again.
	The USB connector is broken.	Replace with a new USB device.
USB device is not recognized.	The USB device is damaged.	Disconnect the USB device and reconnect. If the device is still not recognized, try replacing with a different USB device.
	Connectors are loose.	
No sound heard with the display "No File" shown.	No MP3/WMA file is stored in the USB device.	Store these files properly in the USB device.
Sound skips or is noisy.	MP3/WMA files are not encoded properly.	Use MP3/WMA files encoded properly.

Bluetooth

Problem	Cause	Measure
Cannot pair the Bluetooth enabled device with the car audio system.	The device does not support the profiles required for the system.	Use another device to connect.
	The Bluetooth function of the device is not enabled.	Refer to the user manual of the device for how to enable the function.
The audio quality is poor after connection with a Bluetooth-enabled device.	The internal microphone gain is not set correctly.	Adjust the gain of the internal microphone in System Setup.
	The external microphone is not set correctly nor properly positioned.	Adjust the gain and position of the external microphone. For example, stick the microphone onto the dashboard so it is close to the driver.

SiriusXM Advisory Messages

Message	Description
CHEK TUNER	Check the SiriusXM tuner connection on the back of the unit to ensure that its correctly connected.
CHK ANTENA	Ensure the SiriusXM antenna cable is connected to the SiriusXM tuner correctly. Check the SiriusXM antenna wire for breaks or sharp bends. Replace the antenna if necessary.
	Press RESET located..... If the message remains, the antenna may have been damaged.
NO SIGNAL	The vehicle must be outside, and the antenna must have a clear view of the southern sky. The magnetic antenna must be mounted on the outside of the vehicle for the best reception.
CHAN UNSUB	This channel is not included in your SiriusXM subscription plan. Call 1-800-XM-RADIO (1-800-967-2346) to subscribe.
CH UNAVAIL	This channel is not a valid SiriusXM channel. The channel number has been entered incorrectly, or the channel was removed from the SiriusXM channel lineup
CH LOCKED	The selected channel has been locked by the parental controls, or a mature channel has been selected.
	A prompt to enter the unlock code will appear. Enter the unlock code as described on page 8.
SUBSCRIPTN UPDATED	An update to your SiriusXM subscription has been received by the SiriusXM tuner. Press any button to continue.

6. ERROR DISPLAYS

If an error occurs, one of the following displays is displayed. Take the measures described below to solve the problem.

Display	Cause	Measure
ERROR 2	Do not support iPod & iPhone.	Change another device. * The head unit will return to RADIO mode.

If an error display other than the ones described above appears, press the **[RESET]** button. If the problem persists, turn off the power and consult your store of purchase.

* When the **[RESET]** button is pressed, frequencies of radio stations, titles, etc. stored in memory are cleared.

7. SPECIFICATIONS

FM Tuner

Frequency range: 87.9-107.9MHz
Usable sensitivity: 8dBμ
Frequency response: 30Hz-15kHz
Stereo separation: 30dB(1kHz)
Signal/noise ratio: >55dB

AM Tuner

Frequency range: 530-1710kHz
Usable sensitivity (S/N=20dB): 30dBμ

MP3/WMA mode

MP3 sampling rate: 8 kHz to 48 kHz
MP3 bit rate: 8 kbps to 320 kbps / VBR
WMA bit rate: 8 kbps to 320 kbps
Logical format: ISO9660 level 1,2
Joliet or Romeo file system

USB

Specification: USB 1.0/2.0
Playable audio format:
MP3(.mp3); MPEG 1/2/Audio Layer-3
WMA(.wma); Ver 7/8/9, 1/9,2

Bluetooth

Specification: Bluetooth Ver. 2.0+EDR
Profile: HFP (Hands-free Profile)
A2DP (Advanced Audio Distribution Profile)
AVRCP (AV Remote Control Profile)
PBAP (Phone Book Access Profile)
Send/Receive Sensitivity: Class 2

Audio Amplifier

Maximum power output:
200W (50W x 4)
Speaker impedance: 4Ω (4 to 8Ω allowable)

Input

Audio input sensitivity:
High: 320mV (at 1V output)
Mid: 650mV (at 1V output)

Low: 1.3V (at 1V output)
(input impedance 10 kΩ or greater)
Aux-in level: ≤2V

General

Power supply voltage:
14.4VDC (10.8 to 15.6V allowable),
negative ground
Fuse: 15A
Dimensions of the Main Unit:
188mm Width × 58mm Height × 190mm Depth
7-2/5(width) × 2-7/25(Height) × 7-12/25(Depth)
Weight of the Main Unit: 1.94lb. (0.88kg)
Dimensions of the Remote Control unit:
52mm Width × 7.5mm Height × 85.5mm Depth
2-3/64(Width) × 19/64(Height) × 3-11/32(Depth)
Weight of the Remote Control Unit:
0.77oz. (24g) (including battery)

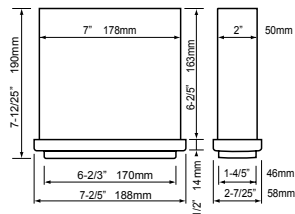

Note:

- Specifications and design are subject to change without notice for further improvement.

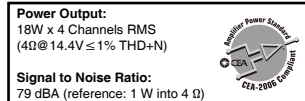

8. INSTALLATION / WIRE CONNECTION GUIDE

CONTENTS

1) Before Starting	13
2) Package Contents	13
3) General Cautions	13
4) Cautions on Installation	14
5) Installing the Source Unit	14
6) Removing the Source Unit	15
7) Wiring and Connections	15
8) Connecting the accessories	16

1) Before Starting

- This set is exclusively for use in cars with a negative ground 12 V power supply.
- Read these instructions carefully.
- Be sure to disconnect the battery "terminal" before starting. This is to prevent short circuits during installation. (Figure 1)

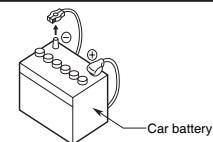

Figure 1

2) Package Contents

Source unit	1	Wire connector	1
Trim ring	1	Owner's manual	1
Mounting bracket	1	Warranty card	1
Screws M5x6 mm	4	Remote control (with battery)	1
L-key	2		

3) General Cautions

- Do not open the case. There are no user serviceable parts inside. If you drop anything into the unit during installation, consult your dealer or an authorized **Clarion** service center.
- Use a soft, dry cloth to clean the case. Never use a rough cloth, thinner, benzine, or alcohol etc. For tough dirt, apply a little cold or warm water to a soft cloth and wipe off the dirt gently.

4) Cautions on Installation

1. Prepare all articles necessary for installing the source unit before starting.
2. Install the unit within 30° of the horizontal plane. (Figure 2)
3. If you have to do any work on the car body, such as drilling holes, consult your car dealer beforehand.
4. Use the enclosed screws for installation. Using other screws can cause damage. (Figure 3)

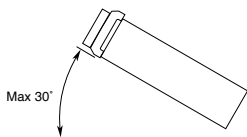

Figure 2

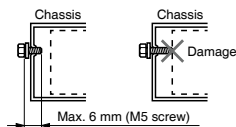

Figure 3

5) Installing the Source Unit

1. Place the mounting bracket into the instrument panel, use a screwdriver to bend each stopper of the mounting bracket inward, then secure the stopper.
2. Wire as shown in Section 7).
3. Insert the source unit into the mounting bracket until it locks.
4. Take care of the top and bottom of the trim ring and mount it so that all the hooks are locked.

Notes:

1. Some car models require special mounting kits for proper installation. Consult your **Clarion** dealer for details.
2. Fasten the front stopper securely to prevent the source unit from coming loose.

• Console opening dimensions

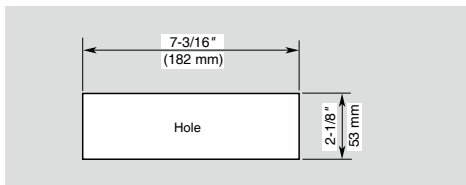

Notes of installation

1. Before installation, please make sure proper connections are conducted and the unit operates normally. Improper connection may result in damage to the unit.
2. Use only accessories designed and manufactured for this unit and other unauthorized accessories may result in damage to the unit.
3. Before installation, please fasten all power cables.
4. DO NOT install the unit in the place where close to hot area to prevent damage to electrical components such as the laser head.
5. Install the unit horizontally. Installing the unit more than 30 degree vertically may result in worse performance.
6. To prevent electric spark, connect the positive pole first and then the negative pole.

7. DO NOT block the cooling fan exit to ensure sufficient heating dissipation of this unit, or it may result in damage to this unit.

Unit installation Method A

1. Insert mounting bracket into dash board, choose appropriate mounting tab according to the gap width, bending the mounting tab outwards with a screwdriver to fix the mounting bracket in place.
2. Slide the unit into the bracket until you hear a click sound.

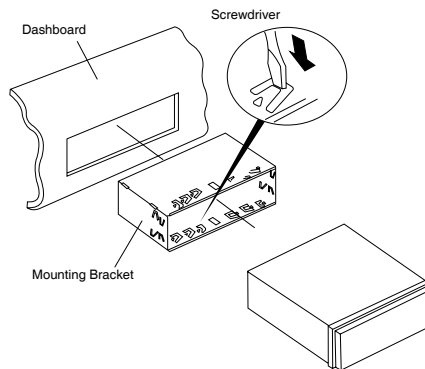

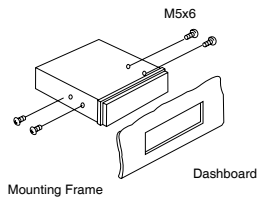
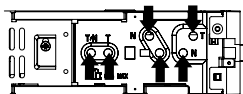
Method B

1. Insert this unit directly to the opening of the dashboard.
2. Place M5x6 cylindrical screw through the holes of the mounting frame located inside the opening to holes of the unit and fasten the screws to left & right.

Trim ring installation

Attach the trim ring around the front panel.

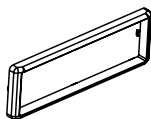
**6) Removing the Source Unit****Disassemble trim ring**

1. Push the trim ring to right and pull out the right part.

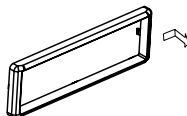

2. Push the trim ring to left and pull out the left part.

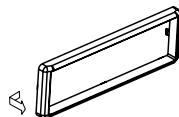
**Disassemble the unit**

1. Switch off the power.
2. Remove the trim ring.
3. Insert the removal keys straight back until they lock, then pull the unit out.
4. Disconnect all the wires.

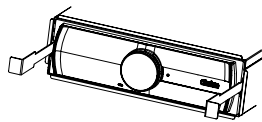
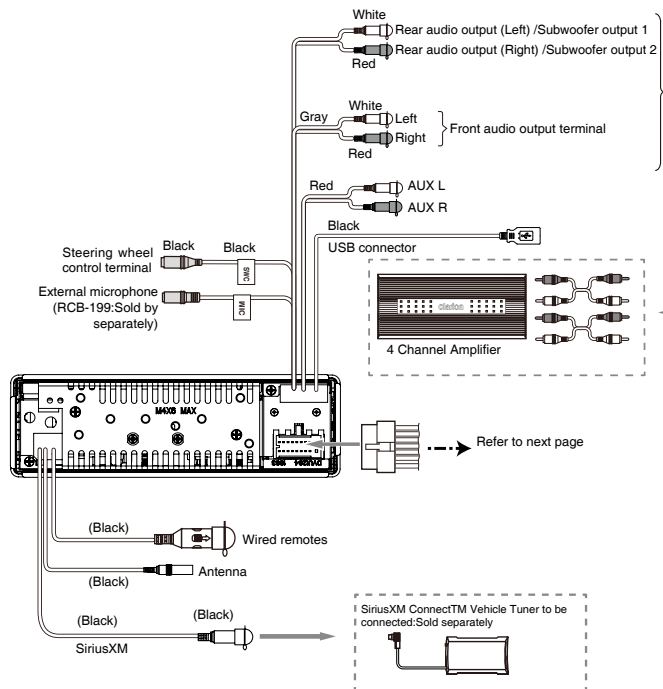
**7) Wiring and Connections**

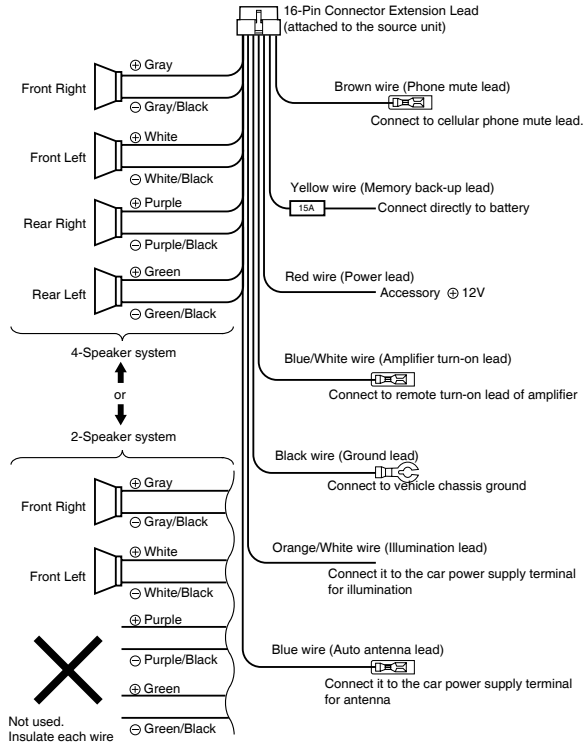

8) Connecting the accessories

• Connecting to the external amplifier

External amplifiers can be connected to the 4 channel RCA output connections. Ensure that the connectors are not grounded or shorted to prevent damage to the unit.

9. WARNING

-English:"

This device complies with industry Canada licence-exempt RSS standard(s). Operation is subject to the following two conditions:

- (1) this device may not cause interference, and
- (2) this device must accept any interference, including interference that may cause undesired operation of the device."

-French:"

Le présent appareil est conforme aux CNR d'Industrie Canada applicables technicien aux appareils radio exempts de licence. L'exploitation est autorisée aux deux conditions suivantes :

- (1) l'appareil ne doit pas produire de brouillage, et
- (2) l'utilisateur de l'appareil doit accepter tout brouillage radioélectrique subi, même si le brouillage est susceptible d'en compromettre le fonctionnement.»