

Car Navigation

QY-8700 MODEL

Navigation system manual

Table of contents

Names of Various Parts	3
Basic Operations	4
Bluetooth Operation	5
Navigation	6
Navigation System Settings	8
Route Guidance	9
About Information	10

 **Warning**

- Changes or modifications to this unit not expressly approved by the party responsible for compliance could void the user's authority to operate the equipment.

NOTE:

- This equipment has been tested and found to comply with the limits for a Class B digital device, pursuant to Part 15 of the FCC Rules. These limits are designed to provide reasonable protection against harmful interference in a residential installation. This equipment generates, uses and can radiate radio frequency energy and, if not installed and used in accordance with the instructions, may cause harmful interference to radio communications.

However, there is no guarantee that interference will not occur in a particular installation. If this equipment does cause harmful interference to radio or television reception, which can be determined by turning the equipment off and on, the user is encouraged to try to correct the interference by one or more of the following measures:

- Reorient or relocate the receiving antenna.
- Increase the separation between the equipment and receiver.
- Connect the equipment into an outlet on a circuit different from that to which the receiver is connected.
- Consult the dealer or an experienced radio/TV technician for help.

The device must not be co-located or operating in conjunction with any other antenna or transmitter.

To comply with FCC's and Industry Canada's RF radiation exposure limits for general population/uncontrolled exposure, this device must be installed to provide a separation distance of at least 20cm from all persons."

This device complies with Part 15 of the FCC Rules. Operation is subject to the following two conditions :

- This device may not cause harmful interference, and
- This device must accept any interference received, including interference that may cause undesired operation.

Shielded cables must be used with this unit to ensure compliance with the Class B FCC limits.

Names of Various Parts Panel Buttons

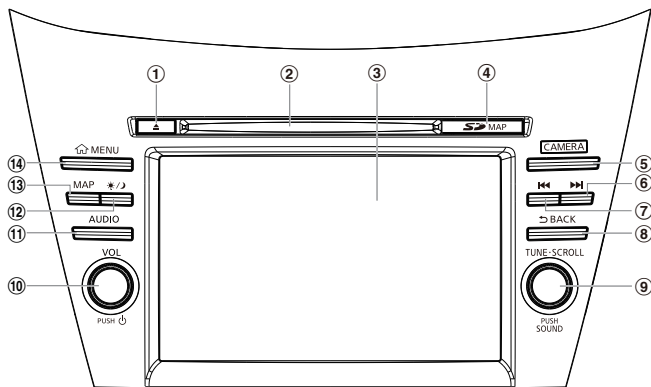

- ① [▲]Eject button: Short press it to eject the disc inside the unit.
- ② Disc slot: CD disc can be inserted for playing.
- ③ LCD(touch screen): To display the working statuses of various modes.
- ④ SD card slot: Map SD card.
- ⑤ [CAMERA] button: To enter camera mode.
- ⑥ [▶▶]Next Track button: In CD/USB/iPod/Bluetooth Audio Device mode, short press it to select the next track to play, and long press it to Fast Forward; in AM/FM mode, short press to search radio station frequency up automatically.

- ⑦ [◀◀]Previous Track button: In CD/USB/iPod/ Bluetooth Audio Device mode, short press it to select the previous track to play, and long press it to Fast Reverse; in AM/FM mode, short press to search radio station frequency down automatically.
- ⑧ [↶BACK] button: Back to the previous mode.
- ⑨ [TUNE-SCROLL] knob/[PUSH/SOUND] button: In AM/FM mode, rotate to search radio station frequency manually; press to store radio stations in memory. Press and turn the knob to jump to previous or next touch key and select it in source and menu mode. In other mode, press and turn the knob to adjust the volume balance.
- ⑩ [⏻] button/Volume Knob: Switch to adjust volume; short press to turn off/on audio device.
- ⑪ [AUDIO] Audio button: To enter audio selection screen or Audio Mode.
- ⑫ [☀/🌙]Day/night button: Press to switch between day or night mode.
- ⑬ [MAP] Map button: Press to enter the map screen.
- ⑭ [MENU] Menu button: Press to enter Menu Screen to select audio function or navigation function.



Caution

- It is prohibited to pull out the map SD card or the system will not work.

Basic Operations

Mode Switch

■ Switch to navigation mode

Press [MAP] button on the panel to switch to navigation mode for map display.

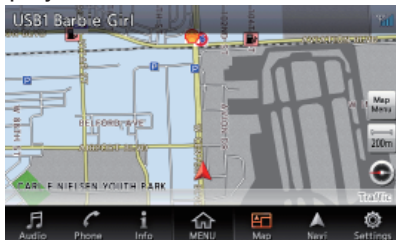

■ Switch to Bluetooth mobile phone mode

Touch switch to Bluetooth mobile phone mode.

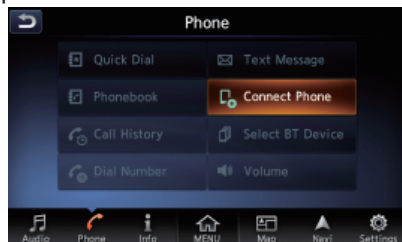

■ Switch to source mode

Press [AUDIO] button on the panel or touch to switch to source mode such as Radio mode.



Press [AUDIO] button or touch in Source mode to switch to source selection screen.



Main menu operations

On main menu screen you can enter corresponding work mode by touch the icons on the screen.

① Press [MENU] on the panel or

touch to enter main menu screen.

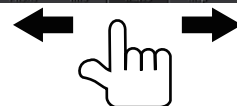

- Change page by dragging left or right or touch and .

Basic Settings

- ① Press [MENU] button on the panel.
- ② Touch to enter Settings Screen.

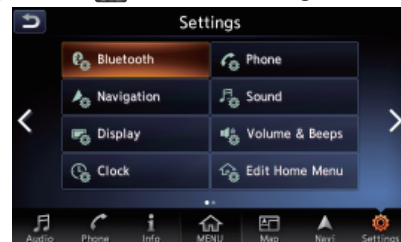



- ③ Touch the icon to enter the appropriate setting.

Source Media Mode

- ① Press [AUDIO] button on the panel or touch  to enter source screen.



- ② Touch the icon to enter the appropriate source media.

Bluetooth Operation Pair Bluetooth Device

- ① Touch  to enter Settings Screen.

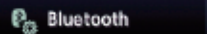
Then touch  to enter Bluetooth setting screen.



- ② Touch  to select the mobile phone or audio device to pair.



- ③ If you want to select the mobile phone to pair, touch .



- ④ If you want to select the audio device to pair, touch , and you have to edit the PIN (minimum 4 digits and maximum 16 digits) to pair the audio device.



- ⑤ After entering the PIN, touch  and operate as per the information prompted.



- ⑥ After successful pairing, it will automatically return to Bluetooth Setting screen.

Bluetooth Telephone

- ① Touch  to enter Phone screen.



- ② Touch the icon to enter the appropriate function.

Navigation

Menu Types and Operation

■ Map menu (Menu on current location map)

Touch  on the map screen to display the Map menu at the left side of the screen.

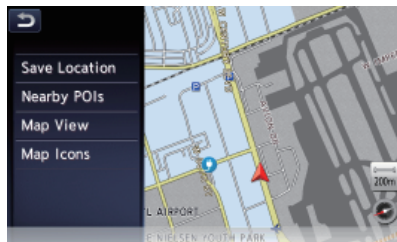

■ Location menu (Menu on scrolled map)

After scrolling the map by touching the Map screen, touch  on the screen to display the Location menu at the left side of the screen.

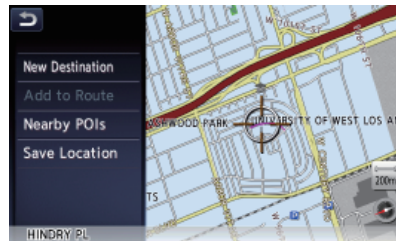

Map Screen Features

■ Types of the map

There are two types of map: the 2D map and the 3D map.

● 2D Map

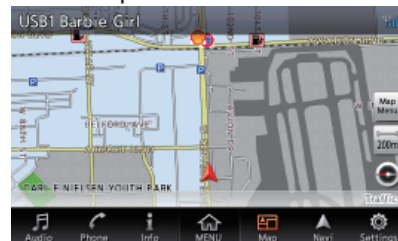

● 3D Map



■ Indicators on the map

Indicators displayed on the Map screen are different according to the conditions at that time.

Indicators on the map of the current location



- ① Audio mark
- ② Vehicle mark
- ③ [Map Menu] Map Menu key
- ④ [200m] Map scale key
- ⑤ [Map bearing] Map bearing mark

Indicators on the scrolled map

Indicators are displayed after scrolling the map.



- ① [Slow] (Slow Scroll) key
- ② Displays the name of the street under the cursor.

Indicators displayed during the route guidance mode

After a destination is set and travelling is started, the guidance route and various guidance information are displayed on the map.



- ① Small Turn Arrow display
- ② Guidance point
- ③ Distance to the waypoint/destination

Manipulating the Map Screen

■ Scrolling the map

Touching the Map screen displays a cursor at the centre of the screen, you can scroll the map.

■ Slow scroll mode operation

Touch **Slow** while scrolling the 2D map to display the following screen:



Keep touching the desired arrow key (←, →, ↑, ↓, ↖, ↗, ↘, ↙) moves the map slowly towards the corresponding direction. To quit the slow scroll mode, touch **Cancel**.

■ Zooming IN/OUT the map

- ① Touch **100m** to display the zoom in/out key.

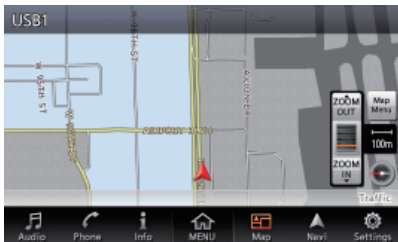

- ② Touch **ZOOM IN** or **ZOOM OUT** to change the map scale.

■ Changing the map appearance

The Map screen can be adjusted regarding orientation or appearance of the map.

- ① Touch **Map Menu** on the Map screen of the current vehicle location.
- ② Touch **Map View** to enter Map View screen.



- ③ Touch the corresponding key to change the map view.

Navigation System Settings

- ① Press **[MENU]/[MAP]/[AUDIO]** button on the panel to display the function bar.
- ② Touch **Navigation** to enter Navigation Settings Screen.

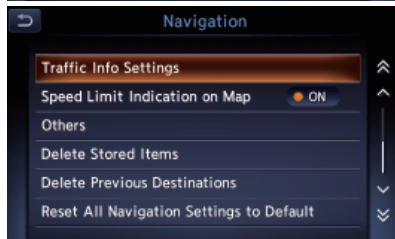
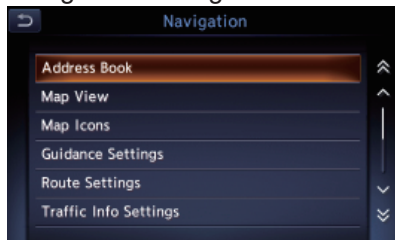

- ③ Touch the item to enter the appropriate setting.

Entering the Destination Searching Your Destination from the Destination Menu

You can search for a destination from the Destination menu by using various methods. Use a suitable searching method according to the place you wish to go to, then operate as per the information prompted.

Destination menu screen



Route Guidance

After you have entered the destination and started the route guidance, you will be guided along the route by screen display and by voice.

Junction Map

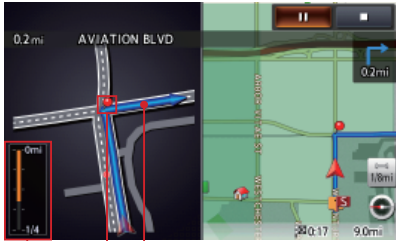

① ② ③

- ① Remaining distance indication
- ② Guidance route
- ③ Guidance point

Turn list on Route

The screen is always divided into two displays and the Turn List on Route is displayed on the left display if Turn List is activated.



① ②

- ① Turn List
- ② Scrolling key

Changing/Editing the Route Settings

From the Route menu, editing the current route, confirming the route information, setting the conditions of the route calculation, etc. can be performed.

- ① Press **[MENU]** button on the panel.
- ② Touch  to enter Route menu screen when a route had exist.



- ③ Touch the desired item to change or edit the route settings.

About Information

This screen sets or displays various information that is helpful for using the vehicle safely and comfortably.

- ① Press **[MENU]** button on the panel.
- ② Touch  to enter Info screen.

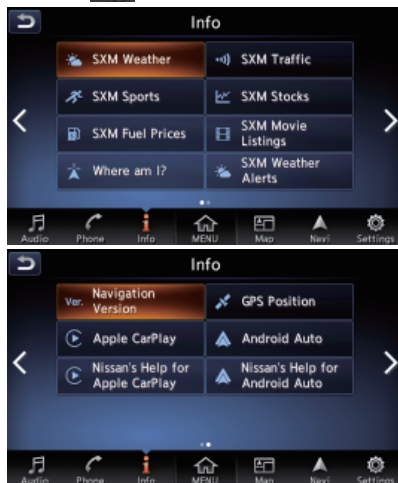

- ③ Touch the desired item to view the information, and about some items you can operate as per the information prompted.

