

FRONT PANELS



HomeBrite[®] Smart LED Bulbs



User Guide

Getting Started

- Download the HomeBrite[®] App from the Apple App StoreSM or Android Google PlayTM store.
- Within device settings, turn Bluetooth[®] ON.
Do not pair bulb(s) within device settings. Pair bulb(s) via HomeBrite App only.
- Install the HomeBrite bulbs. For a more reliable experience, install bulbs room-by-room, starting in a central area of your home.
- Turn the light switch to the "ON" position. Wait for the bulb(s) to pulse, signaling it's ready to connect.
HomeBrite bulb(s) are not compatible with dimmers.
- Launch the HomeBrite app.

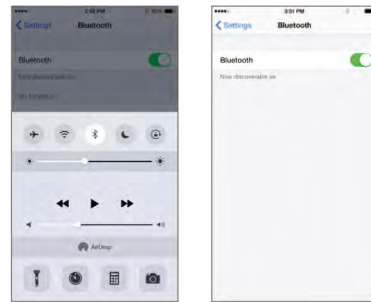

Launching HomeBrite App

- Create a 4-digit pin. Remember this PIN.
- Re-type PIN number.
- Tap "Next".

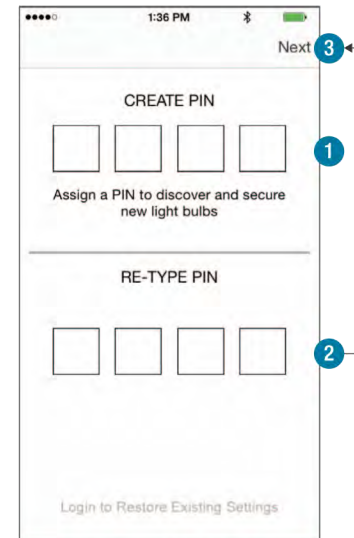

Do not use "Login to Restore Existing Settings" at initial setup (see Advanced Settings for more information)

- The app will automatically scan and pair with installed HomeBrite bulb(s) via Bluetooth.
- A success screen displaying paired HomeBrite bulb(s) will appear.
- Tap "Next" to control bulb(s).



Pairing Additional Bulbs

To pair an additional bulb(s) go to the Light Bulb Section in the Main Menu.

- Install new HomeBrite bulb(s).
- Turn the light switch "ON".
- Wait for the bulb(s) to pulse.
- Tap the Context Menu button and select "Discover New Bulbs".
- The app will automatically scan and pair with installed HomeBrite bulb(s) via Bluetooth.
- Once paired, the new bulb(s) will appear in the Light Bulb List View and Wheel View.

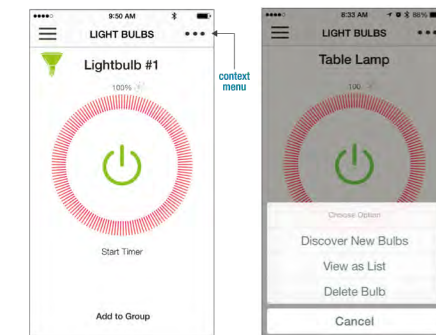

Deleting Bulbs and Groups

To delete a bulb, select Light Bulbs from the Main Menu.

- In Wheel View, choose the bulb you would like to delete.
- Tap the Context Menu button and select "Delete Bulb".
- A confirmation screen will appear. Tap "Yes".



- All instances of the bulb has been removed from your HomeBrite app.

To delete a group, select Groups from the Main Menu.

- In Wheel View, choose the group you would like to delete.
- Tap the Context Menu button and select "Delete Group".
- A confirmation screen will appear. Tap "Yes".

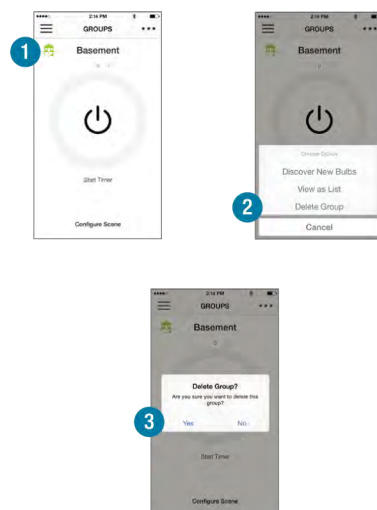

- The group has been removed from your HomeBrite app.

Main Menu

- Light Bulbs - view and control individual bulbs.
- Groups - view and control groups and configure scenes.
- Schedules - set or view schedules for bulbs or groups.
- Settings - save, share and restore configuration, reset all devices and app, browse help and about sections.

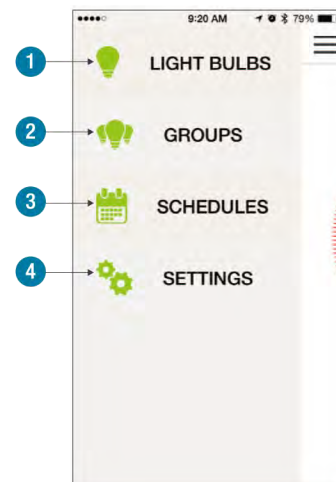

Wheel View

Wheel View allows you to view and control one bulb at a time.

- Turn bulb(s) or group(s) on or off by tapping the center POWER BUTTON.
- Dim bulb(s) or group(s) by rotating the DIMMING WHEEL.
- Swipe left or right to view and control additional bulbs.

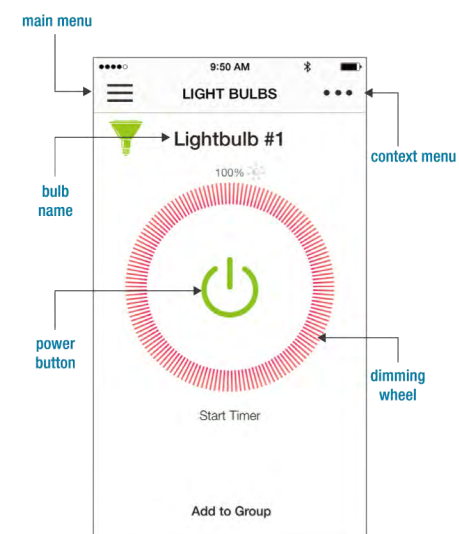

To view light bulbs as a List, tap the Context Menu button and select "View as List".

List View

List View allows you to control multiple bulbs from a single screen.

- Turn bulbs or groups on or off by tapping the power button.
- Dim bulbs or groups by adjusting the DIMMING SLIDER.
- Scroll up or down to view and control additional bulbs.

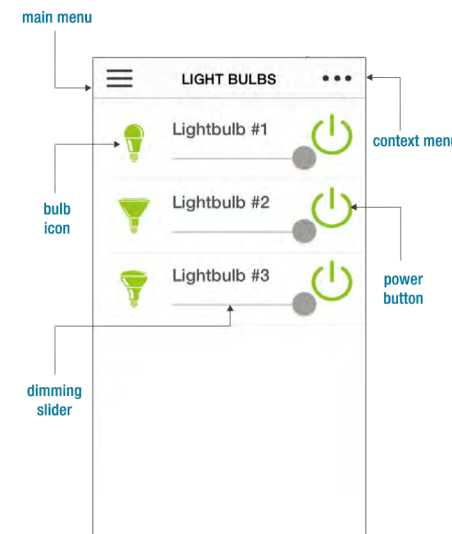

To view light bulbs as a Wheel, tap the Context Menu button and select "Wheel View".

Renaming Bulbs & Groups

- From Wheel or List View, tap light bulb name.
- Type in preferred name and tap "OK".
- The new name will appear.

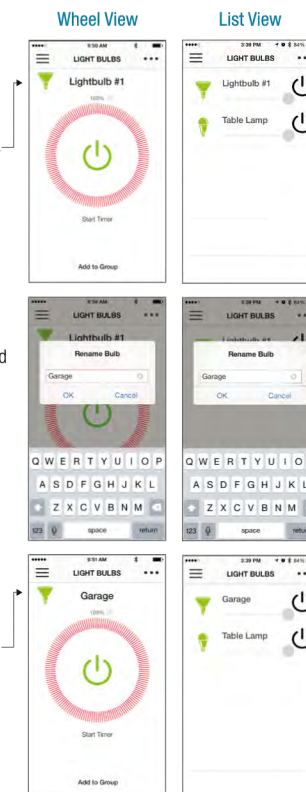

Customizing Icons

- From Wheel or List View, tap default bulb icon.
- The "Set icon" menu will appear. Select "Take Photo" to snap a new photo or select "Choose Existing" to use an existing photo.
- The new icon will appear.

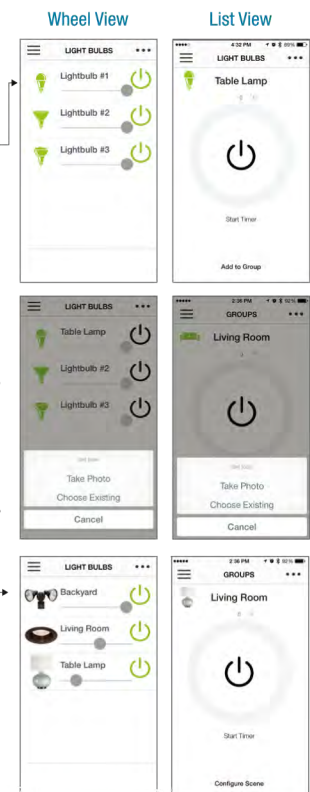

BACK PANELS

Create Groups

Create Groups to control multiple bulbs with a single tap.

- 1 From the Main Menu, select "Light Bulbs".
- 2 In Wheel View, choose a bulb and tap "Add to Group".
- 3 Tap "Add New Group" and create a name or select one from the list. Then tap "Done".
- 4 To add bulbs to an existing group, choose a bulb, tap "Add to Group" then select the group name.



- 5 In Wheel View, the Group name appear at the bottom of the screen.



Create up to 20 Groups per bulb.

Configure Scenes

Scenes allow you to modify a group's settings by adjusting each bulb's appearance.

- 1 From the Main Menu, select "Groups".
- 2 In Wheel View, choose a group and tap "Configure Scene".
- 3 Set the scene by adjusting the bulbs to be ON, OFF or dimmed, then tap "Done". The scene becomes the group's default setting.



- 2
- 3

Scenes are not available for the default 'All' Group.

Set Timers

Set countdown timers to turn bulbs or groups ON or OFF.

- 1 From the Main Menu, select "Light Bulbs" or "Groups."
- 2 In Wheel View, tap "Start Timer"



- 3 Adjust the countdown duration (hours and minutes) then tap "Done".

- 4 The countdown timer will display at the bottom of the screen.



Set Schedules

Set schedules to turn bulbs or groups ON or OFF at a set date and time.

- 1 From the Main Menu, select "Schedules".
- 2 Tap "New" or "Add Schedule".
- 3 Select a bulb or group and tap "Done".

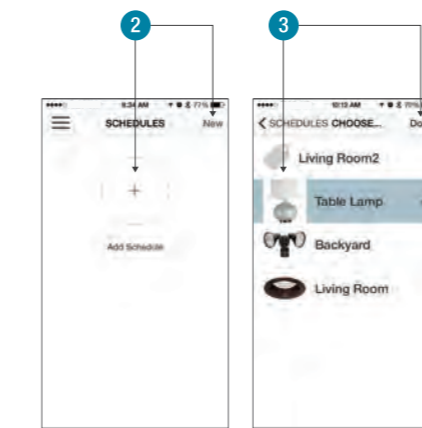

- 4 Set a Start and End Date..... and an On and Off time

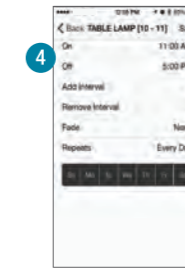

- 5 Set an optional in or out Fade as the scheduled time approaches.

- 6 Use "Repeats" to repeat a schedule on select days of the week

- 7 Once finished, tap "Save."



Save Configuration

- 1 From the main device, go to the Main Menu and select "Settings".

- 2 In the General menu, select "Login."

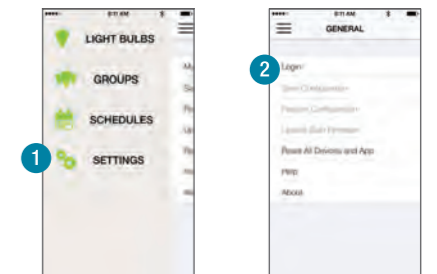

- 3 Tap 'Register' to create a new account.

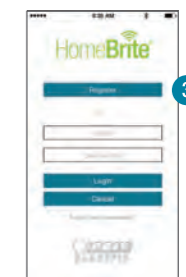

- 4 Enter an email address and password, then tap 'Register'



- 5 The General Settings menu will reappear. Select "Save Configuration."

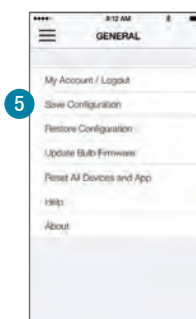

- 6 Tap "Yes" to confirm saving your configuration.

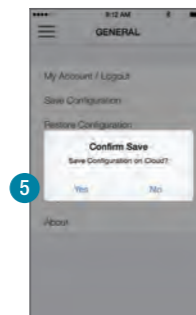

- 7 Your configuration is now saved and you are able to share it with other devices.

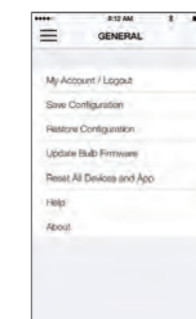

Restore and Share Configuration

- 1 On the new device, install and launch the HomeBrite app.

- 2 From the initial PIN screen, select "Login to Restore Existing Settings"

Do not create a new PIN from the new device

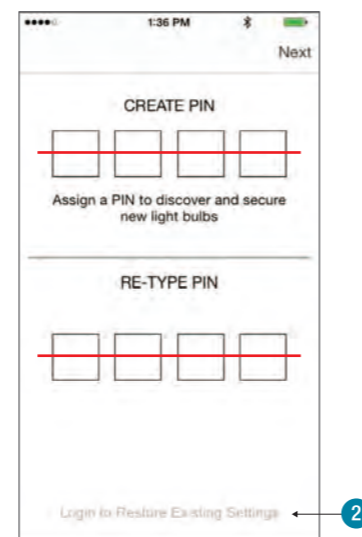

- 3 Enter the email address and password that was created on the main device to restore a configuration then tap "Login".



- 4 Tap "Yes" to confirm restore.

- 5 Tap "Yes" again to confirm the overwrite of any current settings.

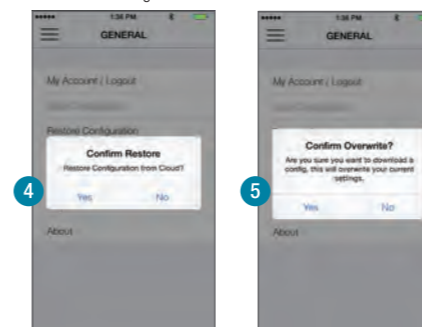

The saved bulbs, groups, schedules and settings will apply to the new device. Any changes made will impact the original device.

For Technical Support

Please contact Feit Electric at (562) 463-BULB (2852) info@feit.com



or visit us at: <http://www.feit.com/homebrite>

To hard reset HomeBrite bulb(s), place the bulb(s) on a single power supply such as a light switch or a table lamp. Turn the bulb(s) on for 18 seconds then turn it back off for 1 second. Repeat the process 4 times.

Compatible Devices & OS

Apple OS: iOS8+ Apple tablet: iPad Air

Apple phones: iPhone 5, 5s, 6 & 6 Plus

Android OS:

4.4.4 & 5.0+

Android phones:

Google Nexus 5
Samsung Galaxy S4 and S5
Samsung Galaxy Note 3
Motorola Moto G (1st)
Motorola Moto X (2nd)
LG G3 (Android 5.0 only)
Sony Xperia Z
HTC one M8

Android tablets:

Google Nexus 7
Samsung Galaxy Tab 4 - 10.1in

The Bluetooth® word mark and logos are registered trademarks owned by Bluetooth SIG, Inc. and any use of such marks by Feit Electric is under license. Other trademarks and trade names are those of their respective owners.

Google Play is a trademark of Google Inc.

Apple, the Apple logo, iPad, and iPhone are trademarks of Apple Inc., registered in the U.S. and other countries. App Store is a service mark of Apple Inc.

HomeBrite® is a registered trademark of Feit Electric Company, Inc.

HomeBrite®

FEIT ELECTRIC COMPANY
Pico Rivera, CA 90660

www.feit.com/homebrite

Pour télécharger le Guide de l'utilisateur français, allez à: www.feit.com/homebrite/homebrite-support.html

FCC Caution:

Any Changes or modifications not expressly approved by the party responsible for compliance could void the user's authority to operate the equipment.

This device complies with part 15 of the FCC Rules. Operation is subject to the following two conditions: (1) This device may not cause harmful interference, and (2) this device must accept any interference received, including interference that may cause undesired operation.

This equipment complies with FCC RF exposure guidelines. This equipment should be installed and operated with minimum distance 20cm between the radiator & your body.

Note: This equipment has been tested and found to comply with the limits for a Class B digital device, pursuant to part 15 of the FCC Rules. These limits are designed to provide reasonable protection against harmful interference in a residential installation. This equipment generates, uses and can radiate radio frequency energy and, if not installed and used in accordance with the instructions, may cause harmful interference to radio communications. However, there is no guarantee that interference will not occur in a particular installation. If this equipment does cause harmful interference to radio or television reception, which can be determined by turning the equipment off and on, the user is encouraged to try to correct the interference by one or more of the following measures:

- Reorient or relocate the receiving antenna.
- Increase the separation between the equipment and receiver.
- Connect the equipment into an outlet on a circuit different from that to which the receiver is connected.
- Consult the dealer or an experienced radio/TV technician for help.

IC Warning

This device complies with Industry Canada licence-exempt RSS standard(s). Operation is subject to the following two conditions:

- (1) this device may not cause interference, and
- (2) this device must accept any interference, including interference that may cause undesired operation of the device.

Le présent appareil est conforme aux CNR d'Industrie Canada applicables aux appareils radio exempts de licence. L'exploitation est autorisée aux deux conditions suivantes :

- (1) l'appareil ne doit pas produire de brouillage, et*
- (2) l'utilisateur de l'appareil doit accepter tout brouillage radioélectrique subi, même si le brouillage est susceptible d'en compromettre le fonctionnement.*

The device been tested is compliance with RF exposure guidelines, users can obtain Canadian information on RF exposure and compliance. The minimum distance from body to use the device is 20cm.

Le présent appareil est conforme

Après examen de ce matériel aux conformité ou aux limites d'intensité de champ RF,

les utilisateurs peuvent sur l'exposition aux radiofréquences et la conformité and compliance d'acquérir

les informations correspondantes. La distance minimale du corps à utiliser le dispositif est de 20cm.