

PROFESSIONAL WIRELESS INTERNET WEATHER STATION

Operation Manual

OVERVIEW

Outdoor sensor:

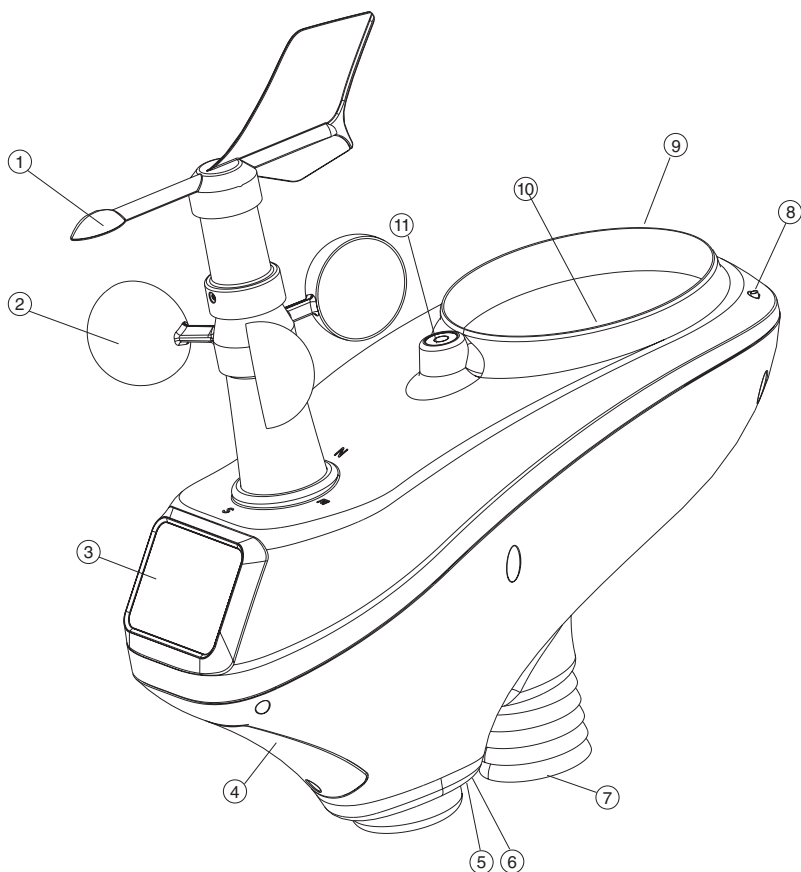

1. Wind Vane
2. Wind Speed Sensor
3. Solar panel
4. Battery compartment
5. LED Indicator: light on for 4s if the unit power up. Then the LED will flash once every 16 seconds (the sensor transmission update period).
6. Reset button
7. Thermo-hygro sensor
8. UV sensor
9. Light sensor
10. Rain collector
11. Bubble level

Indoor sensor

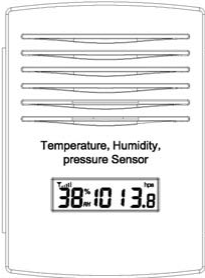

Display unit

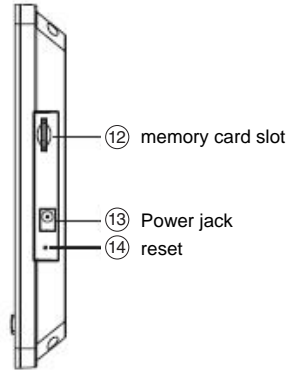
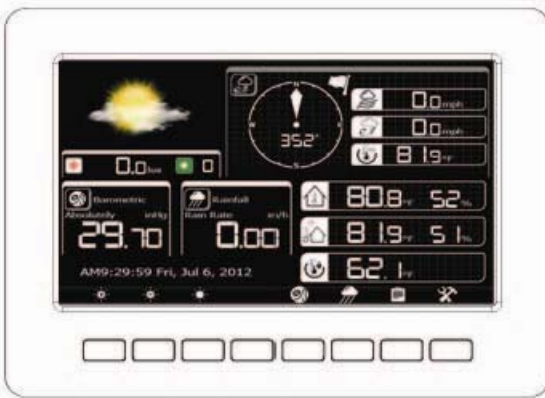

Contents

The weather station consists of the following parts.

QTY	Item
1	Display Console
1	Outdoor sensor(Thermo-hygrometer / Rain Gauge / Wind Speed Sensor /Transmitter)
1	Wind Vane
1	Indoor sensor
1	5V DC adaptor
1	Pole
2	Pole mounting U-bolt
4	Pole mounting clamps
4	Pole mounting nuts
4	Zip ties
1	User manual

Introduction

Thank you for your purchase this professional weather station. The outdoor sensor is solar powered and sends data to the console via a low-power radio. It allows you to upload your weather data to weather website: www.wunderground.com which you can share it with your friend.

This manual will guide you step-by-step through setting up your device. Use this manual to become familiar with your professional weather station, and save it for future reference.

Installation

Before placing and installing all components of the weather station at there final destination, please set up the weather station with all parts being nearby for testing the correct function.

Outdoor sensor

1. Attach the wind vane

Push the wind vane into the shaft, as shown in figure 1.

Tighten the set screw with the Allen Wrench (included) as shown in figure 2. Make sure the wind vane spin freely.

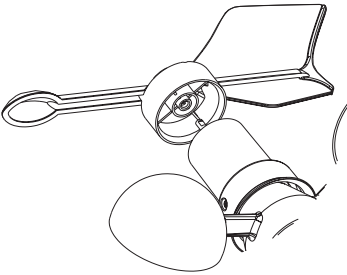

Figure 1

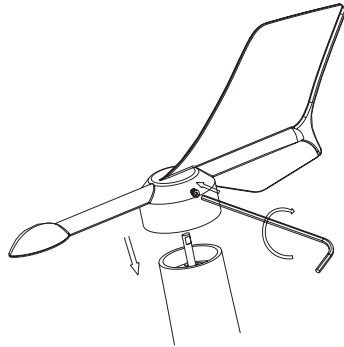

Figure 2

2. Insert the pole into the base, as shown in figure 3. Spin the lid onto the base as shown in figure 4.

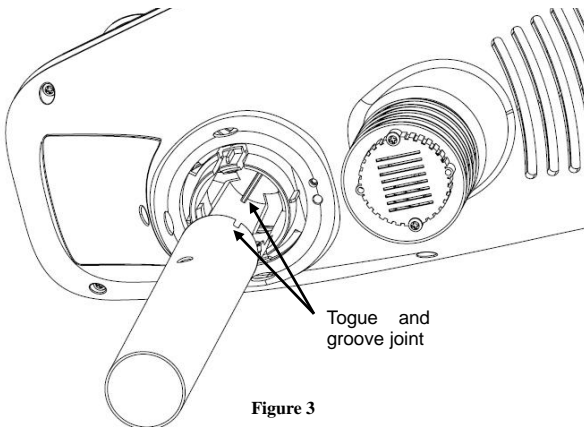

Figure 3

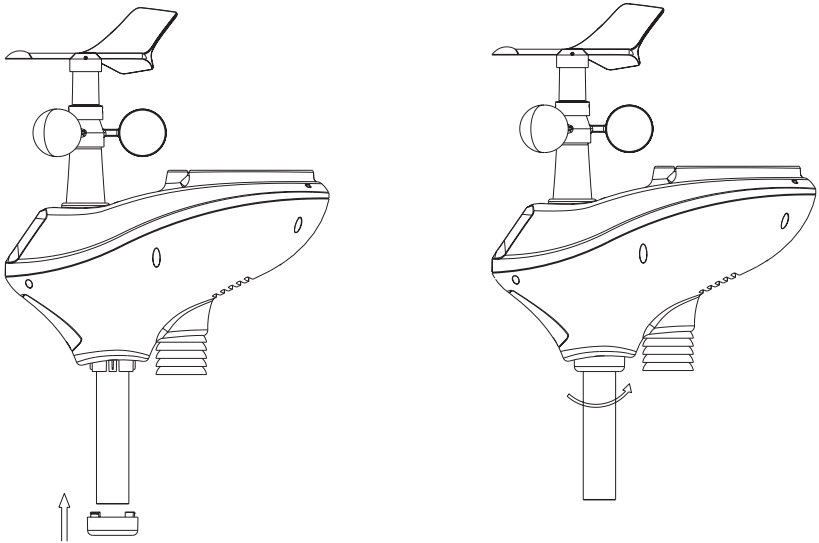

Figure 4

3. Locate the battery door on the thermo-hygrometer / rain gauge transmitter, as shown in Figure 5. Turn the set screw counter clockwise to loosen the screw to open the battery compartment. Insert 3XAA rechargeable batteries in the battery compartment. The LED indicator on the back of the transmitter will turn on for four seconds and normally flash once every 16 seconds (the sensor transmission update period).

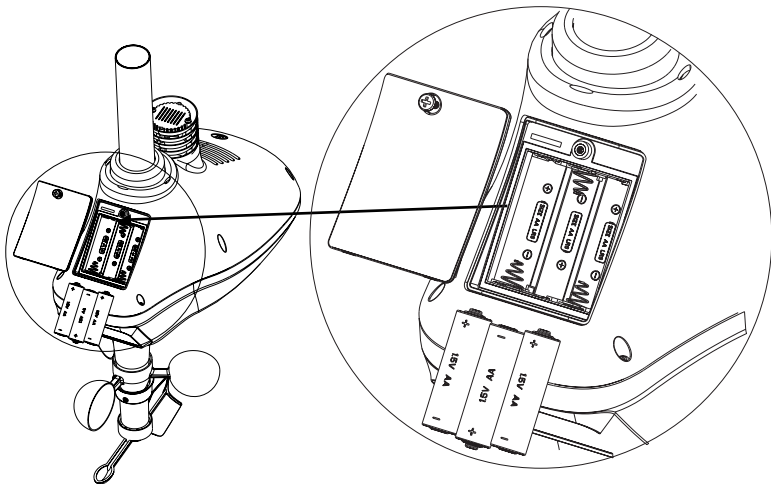

Figure 5

Note: If no LED light up or is lighted permanently, make sure the battery is inserted the correct way or a proper reset is happened. Do not install the batteries backwards. You can permanently damage the thermo-hygrometer.

4. Fasten the mounting pole to your mounting pole or bracket (purchased separately) with the two U-bolts, mounting pole brackets and nuts, as shown in Figure 6.

Tighten the mounting pole to your mounting pole with the U-Bolt assembly, as shown in Figure 7..

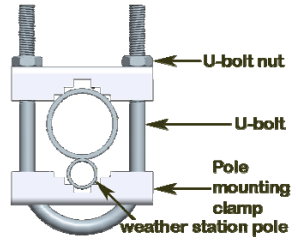

Figure 6

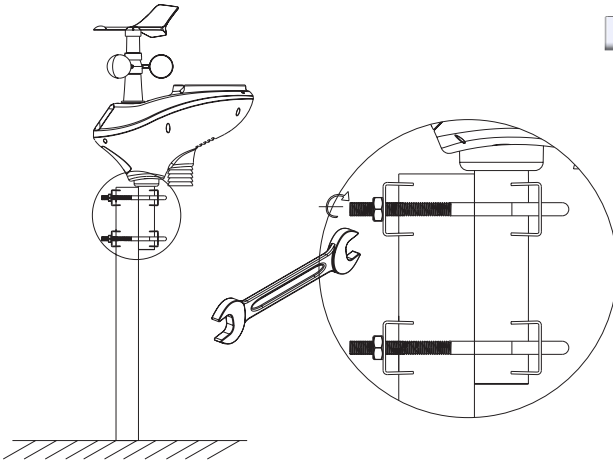

Figure 7

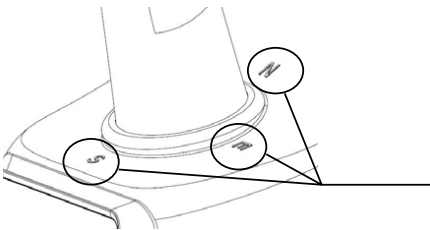

Figure 8

there are four alphabet letter of "N","E","S"and "W" representing for the direction of North, East, South and West, as Figure 8. Wind direction sensor has to be adjusted so that the directions on the sensor are matching with your real location. Permanent wind direction error will be introduced when the wind direction sensor is not positioned correctly during installation.

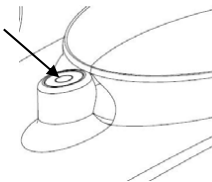

Figure 9

Level the sensors

Use the bubble level on the rain sensor as a guide to verify that sensors are level.

indoor sensor

Remove the battery door on the back of the sensor with a Philips screwdriver (there is only one screw, at the bottom of the unit). Insert two AAA batteries as shown in Figure 10 (we recommend lithium batteries for cold weather climates, but alkaline batteries are sufficient for most climates).

Replace the battery door and set screw. Note that the temperature, humidity and pressure will be displayed on the LCD display. Looking at the back of the unit from left to right, the polarity is (-) (+) for the top battery and (+) (-) for the bottom battery.

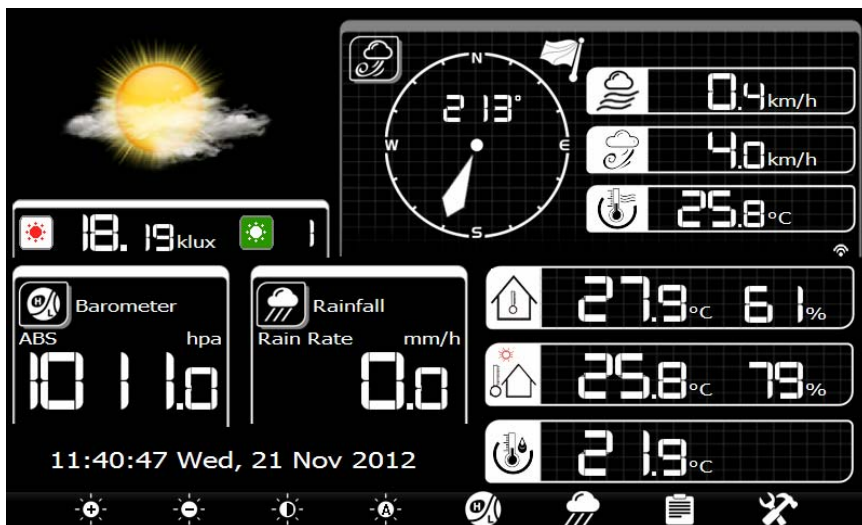



Figure 10

Initial Display Console Set Up

Connect the power adapter to power up the display console.

The display console starts to register the transmitter and receive the weather data from transmitter. The interface as below:



Then it start to scan the Wi-Fi network, if it didn't found the available Wi-Fi it will shows" not find any AP (Access Point)". Press  key to return to normal display mode. Only after connect to WLAN you can upload the data to weather website. If the data upload to server successfully, the icon  will show on beneath the wind chill.

Program Mode

1. Normal display Mode

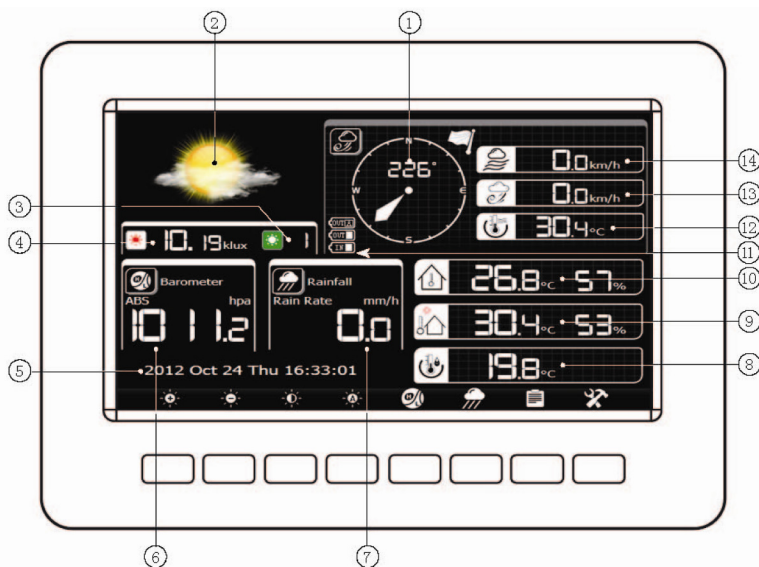







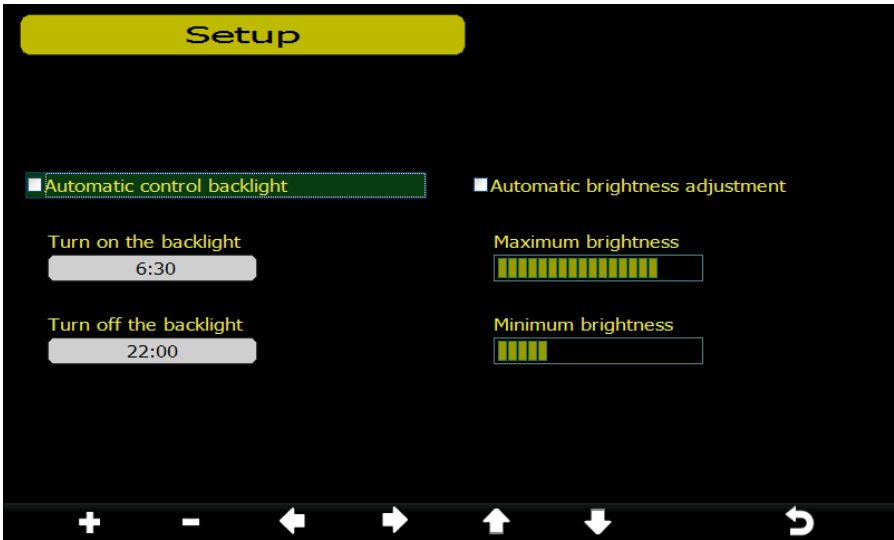

- | | |
|------------------------|-----------------------------------|
| 1. Wind direction | 8. Dew point |
| 2. Weather Forecast | 9. Outdoor Temperature & Humidity |
| 3. UV index | 10. Indoor Temperature & Humidity |
| 4. Light | 11. Low battery indicator |
| 5. Time and date | 12. Wind chill |
| 6. Barometric Pressure | 13. Gust |
| 7. Rainfall | 14. Wind speed |

Icon	Description
	Brightness control key Press this key to enhance the brightness
	Brightness control key Press this key to decrease the brightness
	Backlight on/off key Press this key to on/off the backlight
	Auto backlight control key Press this key to enter the auto backlight setup mode
	Pressure display key Press this key to choose the display between Absolute pressure and Relative pressure.
	Rain key Press this key to Shift the display between Rain Rate, Rain Day, Rain Week, Rain Month, and Rain Year.
	History key Press this key to enter History Mode
	Setting key Press this key to enter Setting Mode

2. Auto backlight setup mode



While in normal display, press the  key to enter Auto backlight setup Mode.



Icon	Description
	Select key Press this key to select the unit or scrolls the value
	Select key Press this key to select the unit or scrolls the value.
	Left key Press this key to select the set value.
	Right key Press this key to select the set value.
	Up arrow key Press this key to change the activated option field
	Down arrow key Press this key to change the activated option field
	Return key Press this key to return to previous mode









If the auto backlight turn-on time has been set, you can press  key to turn off the backlight within the turn on time. Backlight will turn on again automatically at next turn on time. You can press any key to turn on the backlight for 60s within the turn off time

3. History Mode

While in normal display, press the  key to enter History Mode. You can select the below sub-mode by pressing the  key.

3.1 MAX/MIN Mode



Icon	Description
	Selection key Press this key to select the weather MAX/MIN record which need to clear
	Selection key Press this key to select the weather MAX/MIN record which need to clear
	Enter key While select the weather MAX/MIN record, press this key to popup Message Box "Are you sure to clear the Max/Min?" press the  key or  key to confirm the selection.
	Up arrow key Press this key to change the activated option field
	Down arrow key Press this key to change the activated option field
	History key Press this key to select the History sub-Mode
	Return key Press this key to return to normal display mode

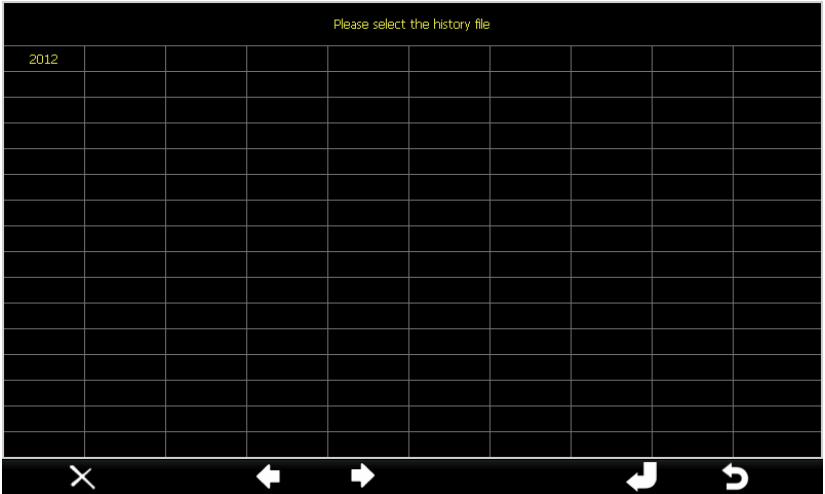

Press or key to select the history file of annual data. Press key to delete the selected file. Press key to exit and open the selected file. Press key to return to History record Mode.

While in History Record Mode, press the key to enter the page selection mode:

No.	Time	Indoor Temperature (°F)	Indoor Humidity (%)	Outdoor Temperature (°F)	Outdoor Humidity (%)	Wind (mph)	Gust (mph)	Dew Point (°F)	Wind Chill (°F)	Wind Dire (°)
625	PM6:54 7/3/2012	79.2	78	79.9	74	0.0	0.0	70.9	79.9	352
626	PM6:55 7/3/2012	79.2	78	79.9	74	0.0	0.0	70.9	79.9	352
627	PM6:56 7/3/2012	79.2	78	79.9	74	0.0	0.0	70.9	79.9	352
628	PM6:57 7/3/2012	79.2	78	79.9	73	0.0	0.0	70.5	79.9	352
629	PM6:58 7/3/2012	79.2	77	80.1	73	0.0	0.0	70.7	80.1	352
630	PM6:59 7/3/2012	79.3	77	80.1	73	0.0	0.0	70.7	80.1	352
631	PM7:00 7/3/2012	79.3	77	80.1	73	0.0	0.0	70.3	80.1	352
632	PM7:01 7/3/2012	79.5	77	80.1	73	0.0	0.0	70.5	80.2	352
633	PM7:02 7/3/2012	79.5	77	80.1	73	0.0	0.0	70.5	80.2	352
634	PM7:03 7/3/2012	79.5	77	80.1	73	0.0	0.0	70.5	80.2	352
635	PM7:04 7/3/2012	79.7	76	80.4	72	0.0	0.0	70.7	80.4	352
636	PM7:05 7/3/2012	79.7	75	80.4	72	0.0	0.0	70.7	80.4	352
637	PM7:06 7/3/2012	79.7	75	80.4	71	0.0	0.0	70.2	80.4	352
638	PM7:07 7/3/2012	79.7	75	80.4	71	0.0	0.0	70.2	80.4	352
639	PM7:08 7/3/2012	79.9	75	78.8	71	0.0	0.0	68.7	78.8	352
640	PM7:09 7/3/2012	79.9	75	80.6	70	0.0	0.0	70.0	80.6	352

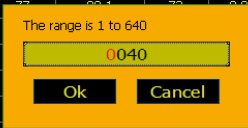

Press or to select a digit in a number, press key or key to change the number. Press or to change the activated option field and press key or key to confirm.

In the history record, Wind Direction indicator matches with the number as following table:

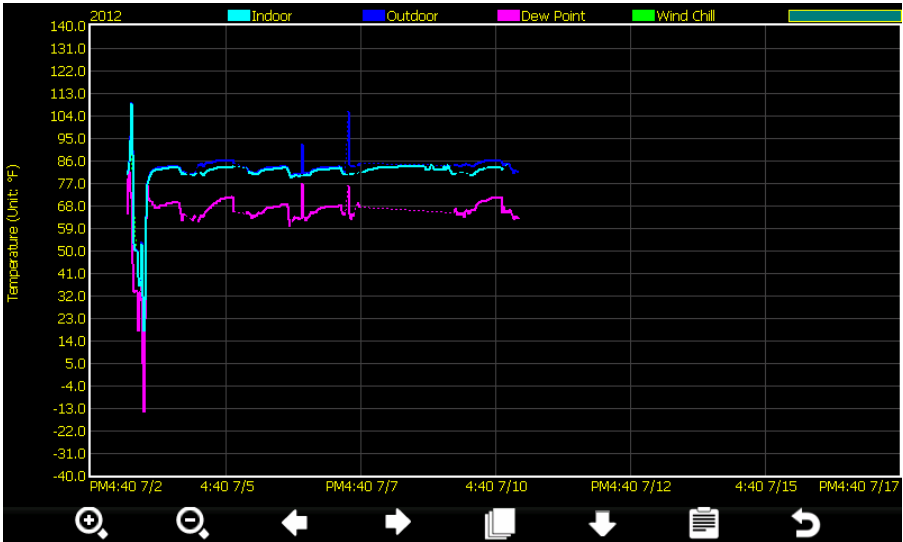

wind direction															
0	1	2	3	4	5	6	7	8	9	A	B	C	D	E	F
N	NNE	NE	NEE	E	EES	ES	ESS	S	SSW	SW	SWW	W	WWN	WN	WNN

3.3 History graph mode









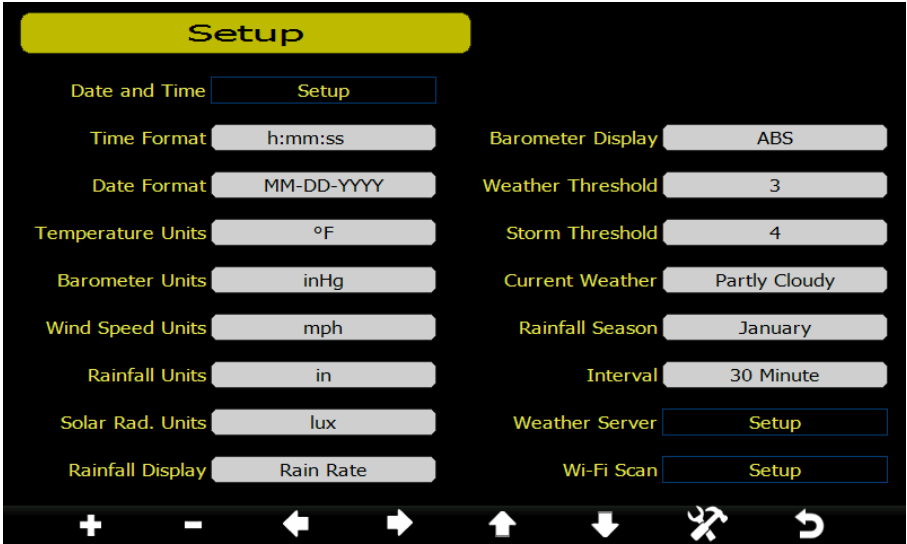

Icon	Description
	Zoom In key
	Zoom Out key
	Scroll left key Press this key to view the left of the scrollable area.
	Scroll right key Press this key to view the right of the scrollable area.
	Select file key Press this key to enter the file selection mode
	Page down key Press this key to scroll down the page you are viewing
	History key Press this key to select the sub-Mode
	Return key Press this key to return to previous mode

4. Setting Mode



While in normal display, press the  key to enter Setting Mode. You can select the below sub-mode by pressing the  key

4.1 Menu Setting Mode









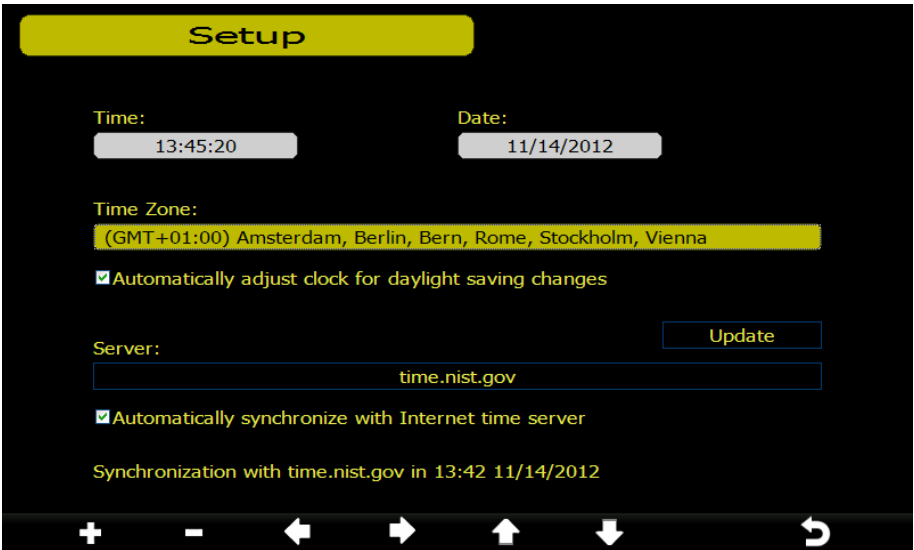

Icon	Description
	Select key Press this key to select the unit or scrolls the value
	Select key Press this key to select the unit or scrolls the value.
	Left key Press this key to select the set value.
	Right key Press this key to select the set value.
	Up arrow key Press this key to change the activated option field
	Down arrow key Press this key to change the activated option field
	Set key Press this key to select the Setting sub-Mode
	Return key Press this key to return to previous mode

4.1.1. Date and Time setting









While in Menu Setting Mode, press  key to select Date and Time Setup field, press  or  key to enter Date and Time Setup mode:









1) Time setting (hour/minute/second)

Press  key to select time setting field, the hour digit turn red, press the  or  key to change the hour setting. Press  to set the minute, the minute digit turn red, press the  or  key to change the minute setting. Press  to set the second, the second digit turn red, press the  or  key to change the second setting



2) Date setting

Press  key to select Date setting field, the day digit turn red, press the  or  key to change the day setting. Press  to set the month, the month digit turn red, press the  or  key to change the month setting. Press  to set the year, the year digit turn red, press the  or  key to change the year setting

3) Time zone setting

Press  key to select Time zone setting field, press the  or  key to change the time zone setting. Press  key to select Update field, press the  or  key to update the time immediately.

4) DST setting

If the state that were in the Time Zone observe DST, the option of “automatically adjust clock for Daylight Saving Change” will show on beneath the Time Zone setting. Press the  or  key to select this option..

5) Internet time server

The default server is time.nist.gov. Press  to popup the keyboard for you to type in the new server

6) Automatically synchronize with an internet time server

Press the  or  key to select

4.1.2 Time Format setting (H:mm:ss / h:mm:ss AM / AM h:mm:ss, default H:mm:ss)

4.1.3 Date Format setting (MM-DD-YY, DD-MM -YY or YY- MM-DD format, default DD-MM-YYYY)

4.1.4 Temperature unit setting (°C / °F, default °C)

- 4.1.5 Barometric unit (hPa / inHg / mmhg, default hPa)
- 4.1.6 Wind speed unit (km/h, m/s, bft, mph, knots default: m/s)
- 4.1.7 Rainfall unit (mm, inch, default: mm)
- 4.1.8 Solar Rad. unit (lux,fc,w/m²)
- 4.1.9 Rainfall display (Rain Rate, Rain Day, Rain Week, Rain Month, Rain Year)

Rain Rate: it forecast the rain per hour base on the recently 10 minute's rainfall. For example: the rainfall of recent 10 minutes is 12mm, the rain/hour is 12mm*6=72mm/h.

Note: The rain per day is reset to zero at 0:00hr every day. The rain per week is reset to zero at 0:00hr every Sunday, per month is reset to zero at 0:00hr every first day of the month. The reset of the rain per year refer to rainfall season section

4.1.10 Barometric display (Absolutely, Relative)

4.1.11 Weather threshold (2-4, default 3)

It's pressure sensitivity setting for weather forecasting. When the pressure rises over weather threshold in past 12 hours the weather upgrades (like from partly cloudy to sunny). When the pressure drops over weather threshold in past 12 hours the weather degrades (like from cloudy to raining). For areas that experience frequent changes in air pressure requires a higher level setting compared to an area where the air pressure is stagnant. For example if 4 is selected, then there must be a fall or rise in air pressure of at least 4hPa needed to change the weather forecast icons.

4.1.12 Storm threshold (3-9, default 4)

Similar to the general pressure sensitivity setting it is possible to adjust the storm threshold sensitivity form 3-9 (default 4). When there is a fall over storm threshold within 3 hours, the storm icon will appear.

4.1.13 Current weather

The five weather icons are Sunny, Partly Cloudy, Cloudy, Rainy and Storm.



Sunny



Partly Cloudy



Cloudy



Rainy





Storm

4.1.14 Rainfall season (default: January)

Rainfall season influence the annual rainfall maximum, minimum and total value. When one month was selected, the annual rainfall and annual max/min rainfall were zero clearing at 0:00 of the first day of the selected month,

4.1.15 Storing Interval (1-240minutes)

4.1.16 Weather Server

Press  or  key to enter Weather Server set up mode, type in the Station ID and password to upload the data.

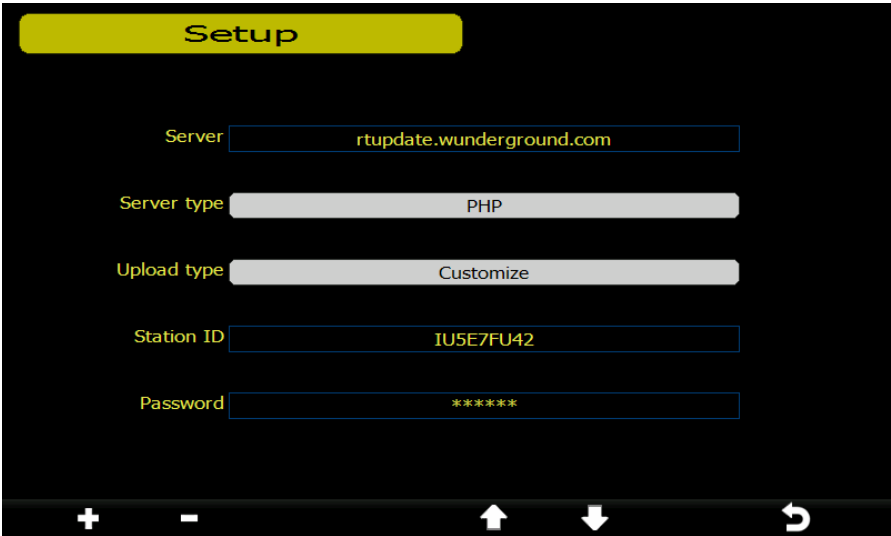

How to get the Station ID and password

Log into the weather website: www.wunderground.com →Click the weather station under local weather category, you will find the PWS(Personal Weather Station) information. → Click “ register my personal weather station” →After finishing signup you will get one Station ID

Once you have a Station ID and password you need to type them into your weather station. The password for each of your stations is the password you use to log in to Wunderground site.

Please Note: Make sure you enter the ID in all capitals, and the password exactly as you chose it, both fields are case sensitive.









4.1.17 Wi-Fi scan



Press  or  key to select the Wi-Fi network. Press  key to confirm and enter the password. Press  key to return to normal display mode. Only after connect to WLAN you can upload the data to weather website. If the data upload to server successfully, the icon  will show on beneath the wind chill.

4.2 Alarm Setting Mode



Icon	Description
	Select key Press this key to select the unit or scrolls the value
	Select key Press this key to select the unit or scrolls the value.
	Left key Press this key to select the set value.
	Right key Press this key to select the set value.
	Up arrow key Press this key to change the activated option field
	Down arrow key Press this key to change the activated option field
	Set key Press this key to select the Setting sub-Mode
	Return key Press this key to return to previous mode

The first row is high alarm value and the second row is low alarm value.

When a set weather alarm condition has been triggered, that particular alarm will sound for 120 second and the corresponding icon will flash until the weather condition doesn't meet the user set level. Press any key to mute the alarm.

4.3 Calibration Mode

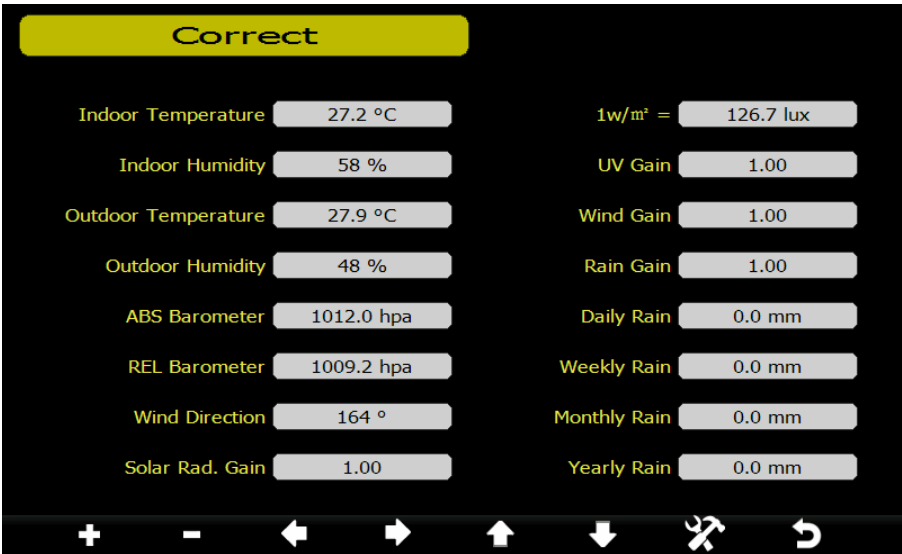

Icon	Description
	Select key Press this key to select the unit or scrolls the value
	Select key Press this key to select the unit or scrolls the value.
	Left key Press this key to select the set value.
	Right key Press this key to select the set value.
	Up arrow key Press this key to change the activated option field
	Down arrow key Press this key to change the activated option field
	Set key Press this key to select the Setting sub-Mode
	Return key Press this key to return to previous mode

Solar Rad. Gain calibration (default is 1.0, adjustment range 0.75 to 1.25)

UV calibration (default is 1.0, adjustment range 0.75 to 1.25)

Wind Calibration (default is 1.0, adjustment range 0.75 to 1.25)









Rain calibration (default is 1.0, adjustment range 0.75 to 1.25)

The conversion factor for Lux converter to w/m². (The range is 100-1000, default 126.7.)

4.4 Factory reset



4.4.2 Re-register indoor transmitter

Press  or  key to select re-register indoor transmitter. Press  or  key to popup the Message Box "Are you sure you want to register the new indoor transmitter?" Press  or  to select Yes or No. Press the  key or  key to confirm the selection.

4.4.3 Re-register outdoor transmitter

Please reference section 4.4.1. Procedures and settings are similar to re-register indoor transmitter

4.4.4 Clear History

Please reference section 4.4.1.





4.4.5 Clear Max/Min

Please reference section 4.4.1.

4.4.6 Reset Factory

Please reference section 4.4.1

4.4.7 Backup data

Press  or  key to select Backup data field, press the  or  key to enter backup mode:



Press or key to select the history year file. Press key or key to confirm the selection. Press or to change the activated option field. Press key to start backup, press key again to stop the backup. Please insert TF card before start backup. The data save as excel format as default setting.



- 4.4.8 Language (English, Chinese, Danish, Dutch, French, German, Italian, Spanish)
- 4.4.9 About information

About

Model: HP1000
Total storage: 39 MB
Available storage: 38 MB
OS version: 1.0.0
Firmware revision number: 1.0.0
Frequency: 868M
Indoor ID: --
Outdoor ID: --



Specifications

Outdoor data

Transmission distance in open field	:	100m(330 feet)
Frequency	:	433 MHz / 868 MHz / 915 MHz (option)
Temperature range	:	-40°C--60°C (-40°F to +140°F)
Accuracy	:	+ / - 1 °C
Resolution	:	0.1°C
Measuring range rel. humidity	:	1%~99%
Accuracy	:	+/- 5%
Rain volume display	:	0 – 9999mm (show — if outside range)
Accuracy	:	+ / - 10%
Resolution	:	0.3mm (if rain volume < 1000mm) 1mm (if rain volume > 1000mm)
Wind speed	:	0-50m/s (0~100mph) (show -- if outside range)
Accuracy:	:	+/- 1m/s (wind speed< 5m/s) +/-10% (wind speed > 5m/s)
Light	:	0-400k Lux
Accuracy	:	+/-15%
Measuring interval outdoor sensor	:	16 sec
Measuring interval indoor sensor	:	64 sec
Indoor data		
Indoor temperature range	:	-40°C--60°C (-40°F to + 140°F) (show --- if outside range)
Resolution	:	0.1°C
Measuring range rel. humidity	:	1%~99%
Resolution	:	1%

Measuring range air pressure : 300-1100hPa (8.85-32.5inHg)
Accuracy : +/-3hpa under 700-1100hPa
Resolution : 0.1hPa (0.01inHg)
Alarm duration : 120 sec

Power consumption

Base station : 5V DC adaptor (included)
Indoor sensor : 2xAAA alkaline batteries (not included)
Remote sensor : 3xAA alkaline rechargeable batteries (included)

Remark: Be sure to use 1.5V rechargeable battery for solar transmitter.

Where outdoor temperature is lower than -20°C, make sure proper type of batteries to be used to assure that the device can get enough power to maintain its function properly. Normal alkaline batteries is not allow to be used since when outdoor temperature is lower than -20 °C, the battery's discharging capability is greatly reduced.



Please help in the preservation of the environment and return used batteries to an authorized depot.

All rights reserved. This handbook must not be reproduced in any form, even in excerpts, or duplicated or processed using electronic, mechanical or chemical procedures without written permission of the publisher.

This handbook may contain mistakes and printing errors. The information in this handbook is regularly checked and corrections made in the next issue. We accept no liability for technical mistakes or printing errors, or their consequences. All trademarks and patents are acknowledged.

FCC Statement:

This equipment has been tested and found to comply with the limits for a Class B Digital Device, pursuant to Part 15 of the FCC Rules. These limits are designed to this equipment generates, uses, and can radiate radio frequency energy and, if not installed and used in accordance with the instructions, may cause harmful interference to radio communications. However, there is no guarantee that interference will not occur in a particular installation. If this equipment does cause harmful interference to radio or television reception, which can be determined by turning the radio or television off and on, the user is encouraged to try to correct interference by one or more of the following measures:

- Reorient or relocate the receiving antenna.
- Increase the separation between the equipment and receiver.
- Connect the equipment into an outlet on another circuit.
- Consult the dealer or an experienced radio/TV technician for help.

CAUTION : Any changes or modifications not expressly approved by the party responsible for compliance could void the user's authority to operate this equipment.