

# XR-150/XR-450 Portable Radio

## Manual

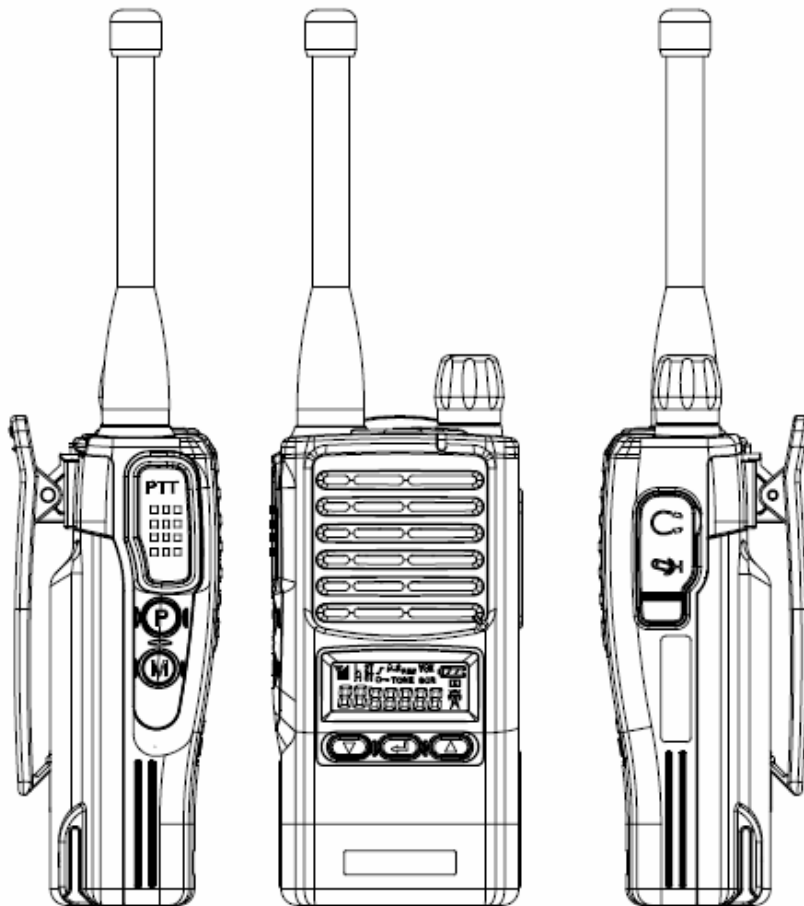

\* This Service manual is subject to change according to improvement of XR-150/XR-450 Portable Radio without notice.

\* Version #2 (2009-06-09)

## Table of Contents

<b>1. Features</b>	-----	<b>6</b>
<b>2. Components of XR-150/XR-450 Series Radio</b>	-----	<b>7</b>
<b>3. Appearance of XR-150/XR-450 Series Radio</b>	-----	<b>8</b>
<b>4. Basic Operation of XR-150/XR-450 Series Radio</b>	-----	<b>9</b>
4.1 Installation and Removing the Antenna	-----	9
4.2 Installation and Removing the Battery	-----	10
4.3 Installation and Removing the Belt Clip	-----	10
4.4 Accessory Connector	-----	11
4.5 Operating XR-150/XR-450 Radio	-----	11
<b>5. Charging the Battery</b>	-----	<b>12</b>
<b>6. Operating Instructions of XR-150/XR-450 Series Radio</b>	-----	<b>14</b>
<b>7. Precautions</b>	-----	<b>27</b>
<b>8. Safety Notes</b>	-----	<b>28</b>
<b>9. Specification</b>	-----	<b>29</b>
9.1 XR-150	-----	29
9.3 XR-450	-----	30

**Thank you for your purchase of the XR-150/XR-450 Series Radio.**

1. Before using the Radio, please read the enclosed user guide in details.
2. The functions and specifications are subject to be changed without notice for improvement of the Radio performance.

## RADIO FREQUENCY ENERGY SAFETY INFORMATION



Your Xradio radio generates RF electromagnetic energy during transmit mode. This radio is designed for and classified as “Occupational Use Only”, meaning it must be used only during the course of employment by individuals aware of the hazards, and the ways to minimize such hazards. This radio is NOT intended for use by the “General Population” in an uncontrolled environment.

This radio has been tested and complies with the FCC RF exposure limits for “Occupational Use Only”. In addition, your XRADIO radio complies with the following Standards and Guidelines with regard to RF energy and electromagnetic energy levels and evaluation of such levels for exposure to humans:

- FCC OET Bulletin 65 Edition 97-01 Supplement C, Evaluating Compliance with FCC Guidelines for Human Exposure to Radio Frequency Electromagnetic Fields.
- American National Standards Institute (C95.1-1992), IEEE Standard for Safety Levels with Respect to Human Exposure to Radio Frequency Electromagnetic Fields, 3 kHz to 300 GHz.
- American National Standards Institute (C95.3-1992), IEEE Recommended Practice for the Measurement of Potentially Hazardous Electromagnetic Fields– RF and Microwave.
- The following accessories are authorized for use with this product. Use of accessories other than those (listed in the instruction) specified may result in RF exposure levels exceeding the FCC requirements for wireless RF exposure.



To ensure that your expose to RF electromagnetic energy is within the FCC allowable limits for occupational use, always adhere to the following guidelines:

- **DO NOT** operate the radio without a proper antenna attached, as this may damaged the radio and may also cause you to exceed FCC RF exposure limits. A proper antenna is the antenna supplied with this radio by the manufacturer or antenna specifically authorized by the manufacturer for use with this radio.
- **DO NOT** transmits for more than 50% of total radio use time (“50%duty cycle”). Transmitting more than 50% of the time can cause FCC RF exposure compliance requirements to be exceeded. The radio is transmitting when the “TX indicator” lights red. You can cause the radio to transmit by pressing the “PTT” switch.
- **ALWAYS** keep the antenna at least 2.5 cm (1 inch) away from the body when

transmitting and only use the Xradio belt-clip which is listed in instructions when attaching the radio to your belt, etc., to ensure FCC RF exposure compliance requirements are not exceeded. To provide the recipients of your transmission the best sound quality, hold the antenna at least 5 cm (2 inches) from your mouth, and slightly off to one side.

The information listed above provides the user with the information needed to make him or her aware of RF exposure, and what to do to assure that this radio operates with the FCC RF exposure limits of this radio.

### **Electromagnetic Interference/Compatibility**

During transmissions, your XRADIO radio generates RF energy that can possibly cause interference with other devices or systems. To avoid such interference, turn off the radio in areas where signs are posted to do so. DO NOT operate the transmitter in areas that are sensitive to electromagnetic radiation such as hospitals, aircraft, and blasting sites.

### **Occupational/Controlled Use**

The radio transmitter is used in situations in which persons are exposed as consequence of their employment provided those persons are fully aware of the potential for exposure and can exercise control over their exposure.

### **OPERATING NOTES**

- When transmitting with a portable radio, hold the radio in a vertical position with its microphone 5 to 10 cm (2 to 4 inches) away from your mouth. Keep the antenna at least 2.5 cm (1 inch) from your head and body.
- If you wear a portable two-way radio on your body, ensure that the antenna is at least 2.5 centimeters (1 inch) from your body when transmitting.

### **PRECAUTIONS**

**WARNING! NEVER** hold the transceiver so that the antenna is very close to, or touching exposed parts of the body, especially the face or eyes, while transmitting. The transceiver will perform best if the microphone is 5 to 10 cm (2 to 4 inches) away from the lips and the transceiver is vertical.

**WARNING! NEVER** operate the transceiver with a headset or other audio accessories at high volume levels.

**CAUTION! NEVER** short the terminals of the battery pack.

**NEVER** connect the transceiver to a power source other than the Battery listed below Such a connection will ruin the transceiver.

**DO NOT** push the PTT when not actually desiring to transmit.

**AVOID** using or placing the transceiver in direct sunlight or in areas with temperatures below  $-30^{\circ}\text{C}$  ( $-22^{\circ}\text{F}$ ) or above  $+60^{\circ}\text{C}$  ( $+140^{\circ}\text{F}$ ). **DO NOT** modify the transceiver for any reason.

**MAKE SURE** the flexible antenna and battery pack are securely attached to the transceiver, and that the antenna and battery pack are dry before attachment. Exposing the inside of the transceiver to water will result in serious damage to the transceiver.

**BE CAREFUL!** The series transceivers employ waterproof construction, which corresponds to IPX7 of the international standard IEC 60529 (2001), 1 m depth for 30 minutes. However, once the transceiver has been dropped, waterproofing cannot be guaranteed due to the fact that the transceiver may be cracked, or the waterproof seal damaged, etc.

The use of non-XRADIO battery packs/chargers may impair transceiver performance and invalidate the warranty.

**FCC Notice Cautions.**

**Changes or Modifications not expressly approved by the party responsible for compliance could void the user's authority to operate the equipment.**

## 1. Feature

The XR-150/XR-450 series Radio is developed to be user-friendly and compact design, to have various features and to use at the construction / industrial / public areas for the safety & convenience of users.

The followings are the main features of the XR-150/XR-450 Series Radio.

- 16Groups and 512Channels are selectable.
- Call guard Squelch of standardized 53 CTCSS / 208 DCS
- Frequency inverter type of Scramble function
- Comander function
- Dual Tone Modulation Frequency (DTMF)
- Normal Scan / Priority Scan
- Advanced Speaker Protection technology
- VOX (Voice Operated Transmit)
- BCL (Busy Channel Lock)/BCLO (Busy Channel Lock Out)
- Time-Out Timer (TOT)
- High/Low RF Power Selectable
- 2 Tone /5 Tone
- Monitor
- Emergency/Siren
- 5 step Squelch control using RSSI.
- Lone Worker
- Remote Radio Stun / Revive(Use 5 tone)
- High-Quality Audio Output(Ø40 Speaker)
- PLL synthesizer type
- Signal Strength Meter
- Battery Status Indicator
- PC Program Tuning
- USB PC Programming
- Various Parameters and PC downloading methods
- DC+7.5V Li-ion/ 2,200 mAH high capacity Battery

## 2. Components of XR-150/XR-450 Series Radio

\* Components could be changed by buyer request.



**XR-150/450**



**XSB-2400**



**Antenna**



**Belt Clip**



**Hand Strap  
(Option)**



**Leather Case  
(Option)**

Figure 3-1) standard components of XR-150/XR-450 series Radio

### 3. Appearance of XR-150/XR-450 Series Radio

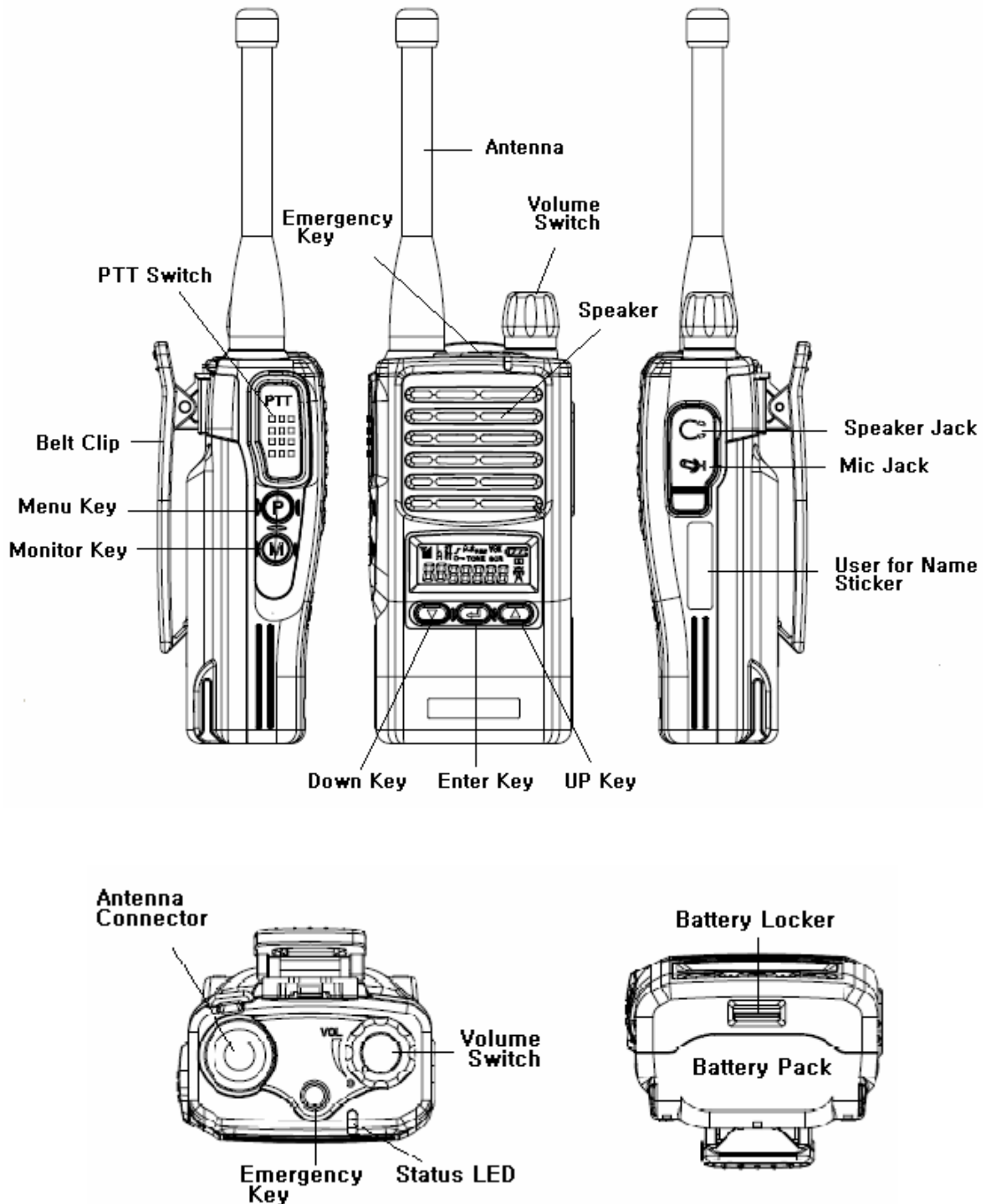

Figure 3-1) Appearance of XR-150/XR-450 Series Radio



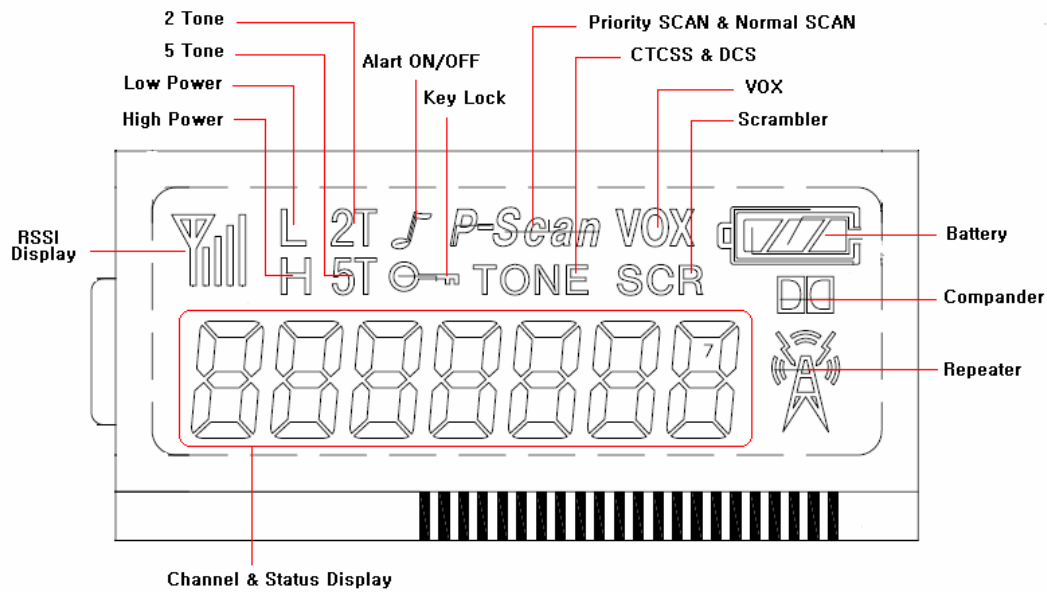

Figure 3-2) XR-150/XR-450 Series LCD Indication

## 4. Basic Operation of XR-150/XR-450 Series Radio

Pease read this manual carefully before using XR-150/XR-450 series Radio.

This manual contains important information about using Radio.

### 4.1 Installation and Removing the Antenna

To install the antenna, insert the antenna into antenna connector and screw the antenna clockwise. To remove the antenna, screw the antenna counter clockwise.

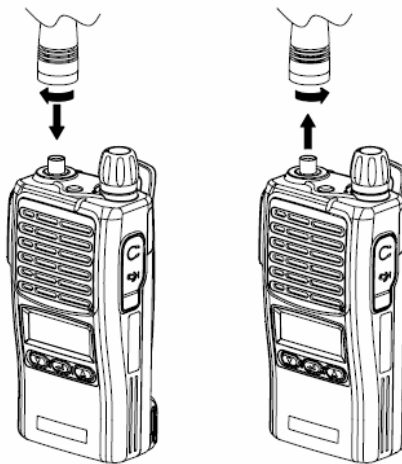



Figure 4-1) Installation and Removing the Antenna

 <b>Caution</b>	<p>When installation of the antenna, giving a strong pressure to the Radio or pulling the antenna with a strong power from the Radio can make a damage on the antenna connector, which may cause the Radio to have a critical problem.</p>
---	--

## 4.2 Installation and Removing the Battery

### 4.2.1 Installation of the battery

- To install battery, slide up the battery towards the top of the radio until battery latch is locked.

### 4.2.2 Removing the Battery

- Slide the battery latch located on the bottom of radio to the open position as shown in Figure 4-2.
- The battery is removed by pressing it against and sliding it towards the bottom of the radio

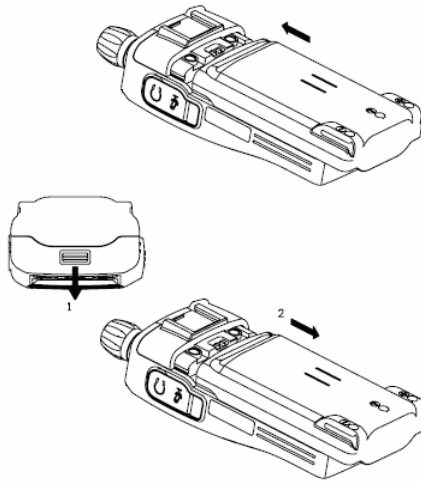

Figure 4-2) Installation and Removing the Battery

## 4.3 Installation and Removing the Belt Clip

- To attach belt clip to radio, align belt clip rails with the grooves in radio and slide the belt clip onto the mounting rails until it latches into place.
- To remove belt clip from radio, push up on tab of belt clip with flat bladed screw driver and at the same time, slide the belt clip towards the top of Radio figure 4-3).

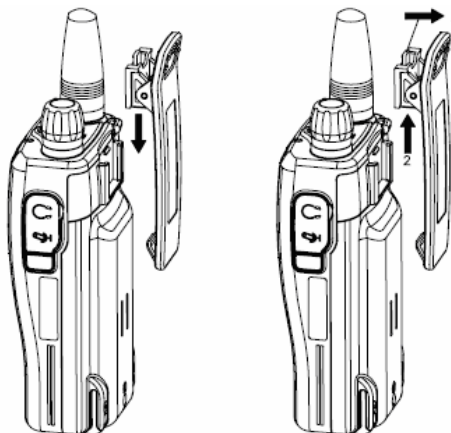

Figure 4-3) Installation and Removing the Belt Clip

#### 4.4 Accessory connector

Accessory connector is used to connect external speaker Mic, and headset, etc.

Please close the cover when nothing is connected.



Figure 4-4) Accessory connector

### 4.5 Operating XR-150/XR-450 RADIO

#### 4.5.1 ON/OFF/Volume Control

Turns the radio on and off and adjusts audio volume level.

#### 4.5.2 PTT Button(Push-To-Talk Button)

You can transmit by pressing PTT button. DTMF or 5-Tone ID is transmitted according to Transceiver setting. At this moment, you can't transmit your voice. And then Red LED will be ON and your voice will be transmitted.

Note) In case of setting BCLO and TOT function, the transmission will be restricted for other users when you transmit continuously.

#### 4.5.3 Menu Button(P, Program Menu Button)

Enter into Menu mode by pressing the Menu button (P) for 2 seconds.

The sequence of menu mode is as follows.

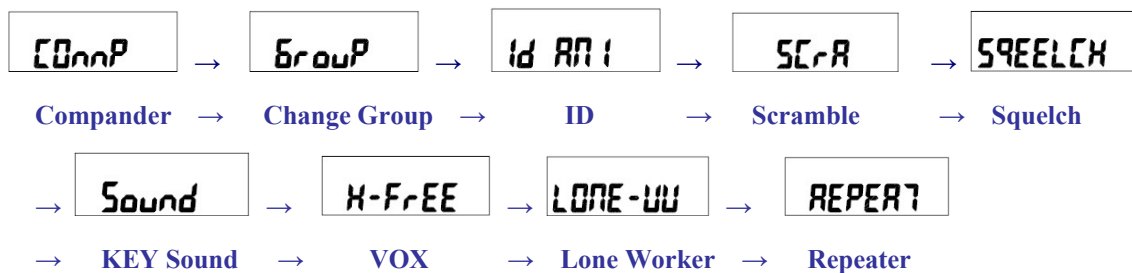

#### 4.5.4 Monitor Button(M)

The monitor mode is enabled and disabled by pressing the Monitor button (M) on the side.

Normal Mode : During pressing the (M) button for about 2 seconds, it is possible to check the receiving status.

Continuous Mode : During pressing the (M) button for more than 2 seconds, the Radio will make a “Beep” tone, which means the monitor function is maintained and if you press the (M) button again, the monitor function will be released.

### 4.5.5 Emergency Button

In case of emergency situation, if you press the Emergency button, a siren sound will be heard through the speaker in the Radio and the Radio will transmit the emergency signal to the party through the emergency channel.

### 4.5.6 Channel Buttons(▼,▲)

Channel Buttons(▼,▲) have 3 functions as shown in following.

- ① Channel buttons(▼,▲) are to change channels.
- ② Channel buttons(▼,▲) are to select menu at menu mode.
- ③ Channel buttons(▼,▲) are to change transmission power. By pressing Up button(▲) while PTT button is being pressed, the user can select "H"(High Power), or by pressing Down button(▼), the user can select "L"(Low Power).

### 4.5.7 Accessory Connector

The Accessory Connector is used when using an external speaker microphone or doing PC programming or making the Cloning or using as a Repeater.

### 4.5.8 RX /TX LED

This LED is a lamp indicating the current status of the Radio and please refer to the below contents.

- ① TX : Red Lamp
- ② RX : Green Lamp
- ③ CTCSS, DCS Error : Green Blinks.
- ④ Low Battery: Red Blinks With "beep" sound.

## 5. Charging the Battery

### 5.1 Safety Notes

1) The radio of XR-150/XR-450 series receives power from high-performance Li-ion battery(XSB-2400). XSB-2400 Battery is safe of high performance and highly reliable, and could be charged very fast. XSB-2400 Battery has been designed suitably only for the charger of Yeonhwa M Tech(DC-1000/DC-2000).

 Caution	The charging of the enclosed Radio on the other maker's charger will cause damage on the battery and also, will cause a trouble on the Radio.
--	---

- 2) Please charge the battery before using the radio for best performance and safety.
- 3) When you charge the battery that is installed in the Radio, please turn off the radio first to charge the battery.



The continuous rapid discharge (for example, when making a short circuit on the ‘+’ terminal of battery by a metal substance) may make a fatal defect and the battery can be exploded. Also, it can cause a fire.

4) Using the correct battery will improve the efficiency and safety.

### 5.2 The Time of Charging

Low battery voltage will make the radio less coverage and also make the performance worse. Please charge the battery in case of following:

- 1) When you think performance of the radio becomes lower
- 2) When the red lamp on RX/TX Led blinks (every 0.5 second) during transmission or reception
- 3) When the battery icon blinks
- 4) When “beep” sound is generated while the radio is in use.

### 5.3 How to Charge

- 1) Plug the DC-1000 charger into the electricity power outlet.
- 2) When charging the Radio with the battery installed, please turn off the power of the Radio and place the Radio on the charger (The charger has a slide slot.).
- 3) After completion of the charging, the green LED on the charger will light. However, please continue the charging for 30 more minutes for the complete full charge.

status	LED indication	status	LED indication
During charging	Red LED lights.	Detecting error	Red LED is off.
After charging	Green LED lights.	When charging	Green LED lights

### 5.4 Charger (DC-1000/DC-2000)

The DC-1000/DC-2000 charger is designed to charge only the Li-ion battery enclosed in this Radio.



Figure 5-2) Chargers for XR-150/XR-450 Series

## Specifications of DC-1000/DC-2000 Charger :

- INPUT VOLTAGE : DC+10.5V
- BATTERY : XSB-2400
- QUICK CHARGING TIME : In 4Hours and half
- OPERATION TEMPERATURE : 0°C~+50°C
- SIZE : 90(W)x105(D)x37(H)m/m
- Charging : 750mA(Fast charging)

## 6. Operating Instructions of XR-150/XR-450 Series Radio

### 6.1 Power On/Off

Turn Power switch clockwise. As soon as power is supplied, the backlight will be turned on.

If the user had set up the user ID, it will be displayed on the LCD and radio will enter into the latest state as a signal sound is generated.

- ☞ Caution) When turning (power) on the radio by pressing a button on it, the radio may enter into a special modes in which transmission and reception is impossible. Please don't turn on the radio by above way.

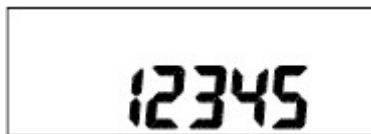

Figure 6-1) User ID

### 6.2 Transmission Method

For transmission, press PTT button on the left side of the radio. As soon as the user presses keys according to the setting, DTMF or 5-tone ID will be transmitted, and during this time, voice communication will be interrupted for several seconds. Then, red LEDs for transmission and reception will be turned on. It is recommended to talk 5 ~ 10cm away from the microphone for the best voice communication.

- ☞ Note: If the user makes transmission for more than a certain time while BCLO or TOT feature is on, transmission will be forcefully disconnected for other users.

- ☞ Caution) If present channel is TX Inhibited by pc program, TX will not be worked.  
(By PC Program, it could be set)

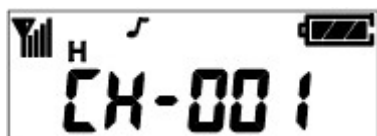

Figure 6-2) When receiving

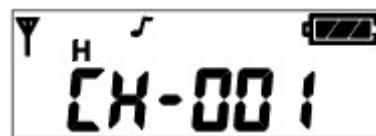

Figure 6-3) When transmitting

### 6.3 Reception Method

The user should not press PTT button during the reception. The user can adjust the volume by Volume switch, and during reception, the green LED will be turned on. Depending on conditions of the transmitting radio,

### 6.4 4 Changing Channels

Channel buttons (▼,▲) are to change channels. Press Up button (▲). Then, “beep” sound will be generated and the channel number will be increased. Or press Down button (▼) to decrease the channel. If the user presses Up or Down button while only one channel is set, the channel will not be changed and a different sound from “beep” will be generated. For fast increase or decrease channel numbers, press Channel buttons (▼,▲) for a while. In this case, however, “beep” sound will not be generated.

### 6.5 Adjusting the Transmission Power

The user can change the transmission power – High Power or Low Power. By pressing Up button (▲) while PTT button is being pressed, the user can select “H” (High Power), or by pressing Down button (▼), the user can select “L” (Low Power). By selecting Low power under good communication conditions, the user can extend the battery use time.

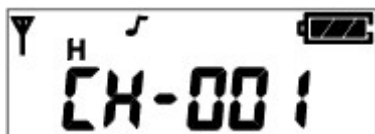

Figure 6-4) High Power

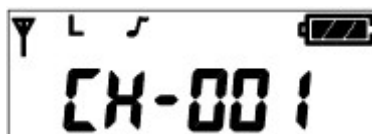

Figure 6-5) Low Power

### 6.6 Operation of Scan function

By pressing **Menu Button (P)** and **Enter Button ( )** in order within 0.5 second in Standby mode, the user can activate Scan function. After Scan function is activated, the radio will automatically search channels and detect a channel corresponding to the frequency. To deactivate Scan function, press **Menu Button (P)** once.

#### 6.6.1 Normal Scan

At the Scan mode, the LCD displays ‘SCAN’ icon. When the scan list is CH1, CH2, CH3, the Radio proceeds the channel scan in the sequence of CH1, CH2, CH3, CH1, CH2, .... During receiving a signal, if you press the UP(▲) or DOWN (▼) button, you can delete the receiving channel temporarily from the scan list and at that time, you can move to the next channel.



## 6.6.2 Priority Scan

At the Priority Scan mode, the LCD displays 'SCAN' and 'P-' icons. The Radio scans the channel in the sequence of CH1, P, CH2, P, CH3, ... at the priority scan mode. During receiving signal through the common channel, the Radio scans the priority channel periodically and if the Radio detects the Priority channel, it starts receiving the channel. During receiving the signal, you can move to the following scan channel by pressing the UP or DOWN button. If you press the **Enter** button, you can erase the current receiving channel temporarily from the scan list and at that time, you can move to the next channel.

But in the course of receiving the Priority channel signal, you can not change or erase the channel by the UP/DOWN buttons(▲,▼).



## 6.7 Key Lock function

During pressing the "Enter" button at the receiving standby mode, press the "▲" button within 0.5second and then, the Key Lock function will be executed and the key icon of LCD will appear. At this situation, the other key except for the PTT and the Monitor key will not be operated. In order to release the Lock function, press the "Enter" button and during pressing the button, press the "▼" button within 0.5second.

## 6.8 2TONE / 5TONE function

### 6.8.1 2TONE

You can use the private and group tone functions by the central control system which is using the 2TONE SIGNALLING. If the Radio receives the tone signal, the Radio will make a Beep sound which is advising the tone signal status and which means the Radio is ready to talk.

### 6.8.2 5TONE

At the tone mode, you can make the private & group calls by the 5TONE and each call memory has the call IDs up to 30 numbers. The set-up of call memory and 5-TONE is made by PC programming. If pressing the "Enter" button for 2seconds at the general mode, the Radio is converted to the call mode and if pressing the "P(Program-MENU)" button for 2seconds at the call mode, the Radio is converted to the general mode. By using the channel buttons (▲,▼) at the call mode, the call number of a channel which is available for the call is displayed.



Figure 6-6) General Mode



Figure 6-7) Call Mode



### 1) 1:1 Call at call mode

Press the “**Enter**” button for a long period(about 2seconds) at the general mode in order to enter into the call mode.

- ① Select your party to call by using the channel button (▲, ▼). If you ( ID : 12345 ) want to call your party(ID : 54321), select him(ID : 54321) by using the channel button (▲,▼) at the call mode.

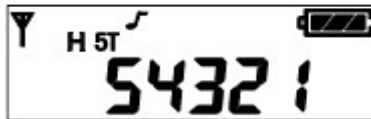

Figure 6-8) ID Selection

- ② You can call the party (ID : 54321) by pressing the “**Enter**” button and then, the Radio of your party(ID:54321) displays the ID number "12345". Even though your party’s Radio is in general mode, the Radio will be converted to the call mode automatically.

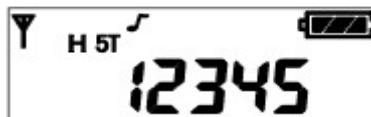

Figure 6-9) ID Transmission

- ③ After the call is completed, the Transmission and the Reception have no restriction, which means that the TX/RX will be free.

### 2) 2) Group(1:N) Call at call mode

- ① In order to make the Group call at the call mode, the following should be set up at the PC programming.
- ② If the 1<sup>st</sup> party (ID:53579) and the 2<sup>nd</sup> party(ID:52468) are in one group, the "5AAAA"which is a call number / call name(example : baseball player) should be designated. ("A" means that all the numbers are applied.)

- 3) If the caller makes a call to the group of baseball players, the caller’s Radio should press the “**Menu**” and “▲” buttons at the same time after selecting the party with ID “1AAAA”. In this case, the Radios of the party1 and the party2 display the ID "1AAAA". In case of the group call, the party’s Radio displays the group ID number.

After the call is completed, the Transmission and the Reception have no restriction, which means that the TX/RX will be free.



Figure 6-10) Group Call

### 3) RESET

This Reset function converts the TX/RX with no restriction to the previous Close mode. Press the Monitor button (M) at the call mode.

- ① The call signal will be transmitted to the party's Radio with the ID number + "C" tone.
- ② If the party's Radio is in the Close channel and after receiving the call with the "C" tone, the call is converted to the "TX/RX with no restriction" mode.

## 6.9 Emergency Call function

1) This Emergency call is used for calling the party in emergency and if pressing for about 2 seconds the button in Red color on the top side of Radio, the Emergency Call is transmitted.

In case of setting to the emergency call channel (available by PC programming) with your ID at the general mode or if the Radio is in the call mode, you can make an Emergency Call by pressing the button in Red color for about 2 seconds.

The transmission is sent with the "C" tone after your ID number.

- ① The party's Radio receives the "C" tone along with your ID number. The Radio recognizes it as an emergency call and displays your ID number with the consecutive alarm sound.
- 2) Without transmitting the emergency call to the party, the Radio itself makes the emergency call sound continuously.

## 6.10 STUN function

The Radio is lost or in case you don't want someone to use your Radio, the reception of STUN ID saved in the Radio protects the Radio from the use by someone.

(The Stun ID can be set up by PC Program.) If the STUN ID is saved in the Radio, the Radio can't be used even after the power off & on of Radio. After receiving the UNSTUN ID, you can use the Radio.



Figure 6-11) STUN Screen

## 6.11 Programming function

The Programming is the function for input of the data such as Frequency/Tone/Scan into the Radio.

### \* Programming Method

First, please prepare the Program cable for XR-150/XR-450 Series Radio.

- ① Press the “**P**” button of the Radio to turn on. Then, the **-Prog-** message is displayed.
- ② Connect the Programming cable to the Ear/Microphone Jack of Radio.
- ③ By using the PC Program, store the data and after disconnecting the cable, turn off the power and turn on the power again.



Figure 6-12) Program Screen

## 6.12 Cloning function

The CLONING is to copy the data such as Frequency/Tone/Scan into the other Radio.

### \* Cloning Method

- ① First, please prepare the Clone cable for XR-150/XR-450 Series Radio.
- ② The original Radio should be turned on with pressing the **PTT button** and the Radio to be copied should be turned on with pressing the “**P**” **button**.
- ③ The original Radio displays **-CLON-** message, and the Radio to be copied displays **-Prog-** message.
- ④ Connect the Clon cable to the Ear/Mic Jack of 2 Radios.
- ⑤ If pressing the “**Enter**” **button** of the original Radio, the copy is made and after completing, please disconnect the cable and turn off & on the power of the 2 Radios. Finally please use the Radio after checking if the copy is made without problem.

☞ Caution) If the Cloning is made into the other brand’s Radio, a malfunction can happen.



Figure 6-13) CLON Screen

### 6.13 Menu description

If pressing the "P" button on the side for 2 seconds, the Radio will be in Menu mode. The Menu mode consists of 9 Menus and you can use your desired Menu after selection.

☞ Caution) After entering into the Menu, if you don't operate the Menu for more than 8 seconds, the Menu mode will be terminated automatically and it is converted to the Receiving mode.

#### 6.13.1 Comander selection

This Comander selection is for On/Off of the Comander.

The selection can be made by the PC program and at the Menu.

- ① Enter into the Menu mode.
- ② By using the channel button(▲, ▼), choose the "Comp" and press the "Enter" button.



- ③ By using the channel button(▲, ▼), choose the ON("y") or the OFF("n") and press the "Enter" button to store.
- ④ In order to come out of the Menu mode, press the "P" button and by selecting the On/Off, the Comander ICON on LCD disappears/appears.



#### 6.13.2 Group change

The Radio is designed to have total 512 channels and 16 Groups and the selection of each Group & Channel can be available by PC program and Menu.

- ① Enter into the Menu mode.
- ② By using the channel button(▲, ▼), choose the "Group" and press the "Enter" button.



- ③ Using the channel button(▲, ▼), choose the Group and press the "Enter" button to store.
- ④ In order to come out of the Menu mode, press the "P" button.

### 6.13.3 ID output

This is for transmission of your ID and reception of your party's ID. ID is divided by DTMF and Call ID. Especially the Call ID transmits your ID to the party and also, the party's ID is displayed on your Radio to use your Radio in convenience and efficiently.

- ① Choose the "Id ANI" by the channel button and press the "Enter" button.



- ② After the "d-TON" message comes out, choose the ON("y")/OFF("n") by the channel button and press the "Enter" button.



- ③ After the "C-TON" message comes out, choose the ON("y")/OFF("n") by the channel button and press the "Enter" button.



- ④ Comes out of the Menu mode by pressing the "P" button.

### 6.13.4 Scramble selection

The Scramble is for protection from overhearing and the scramble reverses the voice signal from microphone to a specific frequency and a mixed voice in order for the other person not to hear your voice.

The selection can be available by PC program and Menu.

- ① Enter into Menu mode.
- ② Select "SCrA" by pressing Channel buttons (▼,▲), and press Enter button( ).



- ③ Select On(y) or Off (n) by pressing Channel buttons (▼,▲), and save the selected status by pressing **Enter** button( ).



- ④ Exit Menu mode by pressing Menu Button(P) button. Select “Off”. Then, the “ SCR “ symbol will disappear on the LCD

### 6.13.5 Set Squelch

Squelch sensitivity level is selectable by 5step.

By PC Program and menu, it could be set.

1. Enter into Menu mode.
2. Select “SQUELCH” by pressing Channel buttons (▼,▲), and press Enter button( ). Then, the message of the squelch sensitivity will be displayed.



3. Select squelch sensitivity -0~5- by pressing Channel buttons (▼,▲), and press Enter button( ) to save the level



4. Exit Menu mode by pressing Menu Button(P).

### 6.13.6 Set KEY Sound

Set Key Sound menu is to decide whether to generate sound or not when the user presses four buttons .

By PC Program and menu, it could be set.

1. Enter into Menu mode.
2. Select “Sound” by pressing Channel buttons (▼,▲), and press **Enter** button( ).



3. Select On(y) or Off (n) by pressing Channel buttons (▼,▲), and save the selected status by pressing

**Enter** button( ).



4. Exit Menu mode by pressing Menu Button(P) button. Select “Off”. Then, the “ ” symbol will disappear on the LCD.

### 6.13.7 Set VOX

Set VOX is to enable users to make transmission for VOX without pressing PTT button. (This function could be available with Ear Mic [External VOX]).

By PC Program and menu, it could be set.

1. Enter into Menu mode.
2. Select “H-FrEE” by pressing Channel buttons (▼,▲), and press **Enter** button( ).

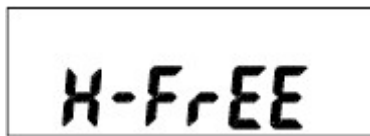

3. Select On(y) or Off (n) by pressing Channel buttons (▼,▲), and press **Enter** button( )..

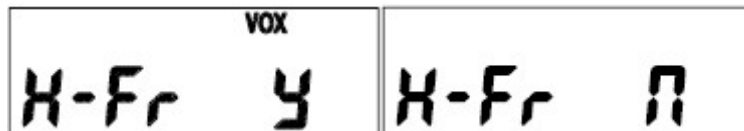

4. Select on(y). Then, the “vox , H-Fr 05” symbol s will appear on the LCD.

Set sensitivity by pressing Channel buttons (▼,▲), and press **Enter** button( ).



5. Select “Off”. Then, the “ vox “ symbol will disappear on the LCD.
6. Exit Menu mode by pressing Menu Button(P) button.

### 6.13.8 Set Lone Worker

The Set Lone Worker is for transmission of emergency alarm sound without pressing the designated button within a period of time when night patrol or guarding and the Lone Worker can be set to be ON/OFF.

The selection can be available by PC program and Menu.

1. Enter into Menu mode.

2. Select “LONE W” by pressing Channel buttons (▼,▲), and press **Enter** button( ).



3. Select On(y) or Off (n) by pressing Channel buttons (▼,▲), and save the selected status by pressing **Enter** button( ).



4. Exit Menu mode by pressing Menu Button (P) button.

### 6.13.9 Set Repeater

If you want to use the XR-150/XR-450 Series Radio as a repeater, you can operate the Repeater by On / Off. The Repeater function should be set up by PC program and if not, at the Menu mode the Repeater set-up is not shown.

1. Enter into Menu mode.
2. Select “REPEAT” by pressing Channel buttons (▼,▲), and press **Enter** button( ).



3. Select On(y) or Off (n) by pressing Channel buttons (▼,▲), and save the selected status by pressing **Enter** button( ).





4. Exit Menu mode by pressing Menu Button (P). Select “Off”. Then, the “ ” symbol will disappear on the LCD





## 7. Precautions

### 7.1 When using the XR-150/XR-450 Series Radios

 WARNING	Don't remove the antenna from the Radio or don't transform the antenna or don't make any change on the antenna. The strong electronic wave to be emitted from the Radio can have an effect on the performance of the Radio and can cause the Radio to have a defect.
--	--

 Caution	Don't use the accessories (such as rechargeable battery, adaptor, external speaker microphone and earphone, etc.) from the other makers, which can cause to make a defect on battery and a malfunction or a defect on the Radio.
--	--

 WARNING	Don't disassemble or reorganize the Radio. The disassembly or reorganization will be causes of defect or malfunction and it will be impossible to make repair afterward. Also, a punishment can be made by law.
--	---

 WARNING	Don't use the other frequency except for the permitted frequency in order not to be punished by law.
--	--

 Caution	<ul style="list-style-type: none"><li>• Don't give an excessive shock to the Radio.</li><li>• Don't place the Radio where the direct sunlight and/or the high temperature occurs.</li><li>• If the Radio is placed for a long time in car in summer, the hot temperature in the car may cause an explosion of battery.</li><li>• Don't make a damage to the battery by a sharp substance and/or an excessive shock.</li></ul>
--	---

### 7.2 Influences to the operations of Radio or other Equipments

The Radio emits a strong electronic wave, which may have an effect on the operation of other equipments and also, can be influenced by the other devices.

 WARNING	Please turn off the Radio before boarding on airplane. When you want to use the Radio in the airplane, please follow the rules in the airplane or the instructions by crew.
--	--

 <p><b>WARNING</b></p>	<p>In case of the area that medical equipments are being used, please use the Radio after discussion with the equipment maker or the related doctor.</p>
---	--

 <p><b>Caution</b></p>	<p>Please don't use the Radio at the place where computer or the other electric/electronic devices are being used, because the strong electronic wave from the Radio can have an effect on the equipments.</p>
---	--

## 8. Safety Notes

Please make sure to read the followings for safe and effective use of the Radio.

 <p><b>WARNING</b></p>	<ul style="list-style-type: none"> <li>• Please keep the Radio away at least 1inch from the body.</li> <li>• If the outside surface of antenna gets stripped out, it can make a burn on the skin.</li> <li>• If you contact a conductive metal to battery terminal, a heat can be made and it may cause fire, explosion and burn. Especially, please be careful when putting the battery in a pocket or a bag.</li> <li>• When using an earphone, please don't listen to the sound at a high level. The high sound may have a bad effect on your ear.</li> <li>• After setting the volume of the Radio at a low level, please adjust the volume step by step to the level you want. A sudden high sound may give a bad damage to the ear or the heart.</li> <li>• Please don't remove or replace or charge or discharge the battery at a dangerous area, since it may cause an explosion or a fire by an electrical spark.</li> <li>• At the area where an electromagnetic force can be made, please make sure to turn off the power of the Radio.</li> </ul>
---	---

## 9. Specification

### 9.1 XR-150

#### General

Frequency Range	VHF: 136 ~ 174 MHz
Frequency Stability	±2.5PPM (-30 to +60°C)
Programmable Channels	512 Channels/16 Group
Channel Spacing	Dual Channel Spacing 12.5/25 KHz
Dimensions	103mm (H)×52mm (W)×32mm (D)
Weight	250g (with Battery pack & Antenna)
Power Source	DC +7.5V rechargeable Li-ion 2200mAh battery pack
Current Drain (maximum)	Receive mode, rated audio out - 320mA (Audio Max) Transmit mode – 1,600mA(High), , 800mA(Low) Standby mode – 60mAh
Duty Cycle(5/5/90)	15.5 Hours(High) / 21 Hours(Low)

#### Receiver

Sensitivity	0.25uV 12 dB SINAD
Squelch Sensitivity	0.22uV 10dB SINAD
Selectivity	65dB (12.5KHz), 70dB (25KHz)
Spurious and Harmonic Rejection	70dB
Inter-modulation	65dB (12.5KHz), 70dB (25KHz)
FM Hum and Noise	40dB (12.5KHz), 45dB (25KHz)
Audio Output Power	1 Watt across an 16-ohm load
Audio Distortion	Less than 4% at rated output
Audio Response	+1, -3 dB from 6dB per octave de-emphasis Characteristic from 300 ~ 3000Hz
Speaker Impedance	16 ohms
IF Frequencies	21.4MHz and 455KHz
Input Impedance	50 ohms

#### Transmitter

RF Power Output	2W/5Watt
Spurious and Harmonic	70dB
FM Hum and Noise	40dB (12.5KHz), 45dB (25KHz)
Audio Distortion	3% maximum with 1KHz modulation
Audio Frequency Response	+1, -3dB from 6dB per octave pre-emphasis Characteristic from 300 ~ 3000Hz
Output Impedance	50ohms

## 9.2 XR-450

### General

Frequency Range	XR-450 : 400 ~ 512 MHz
Frequency Stability	±2.5PPM (-30 to +60 °C)
Programmable Channels	512 Channels/16 Group
Channel Spacing	Dual Channel Spacing 12.5/25 KHz
Dimensions	103mm (H)×52mm (W)×32mm (D)
Weight	250g (with Battery pack & Antenna)
Power Source	DC +7.5V rechargeable Li-ion 2200mAh battery pack
Current Drain (maximum)	Receive mode, rated audio out - 320mA (Audio Max) Transmit mode – 1600mA(High), 1,000mA(Low) Standby mode - 60mA
Duty Cycle(5/5/90)	15 Hours(High) / 20 Hours(Low)

### Receiver

Sensitivity	0.25uV 12 dB SINAD
Squelch Sensitivity	0.22uV 10dB SINAD
Selectivity	65dB (12.5KHz), 70dB (25KHz)
Spurious and Harmonic Rejection	70dB
Inter-modulation	65dB (12.5KHz), 70dB (25KHz)
FM Hum and Noise	40dB (12.5KHz), 45dB (25KHz)
Audio Output Power	1 Watt across an 16-ohm load
Audio Distortion	Less than 4% at rated output
Audio Response	+1, -3 dB from 6dB per octave de-emphasis Characteristic from 300 ~ 3000Hz
Speaker Impedance	16 ohms
IF Frequencies	45.3MHz and 455KHz
Input Impedance	50 ohms

### Transmitter

RF Power Output	4Watt/2Watt
Spurious and Harmonic	65dB
FM Hum and Noise	40dB (12.5KHz), 45dB (25KHz)
Audio Distortion	3% maximum with 1KHz modulation
Audio Frequency Response	+1, -3dB from 6dB per octave pre-emphasis Characteristic from 300 ~ 3000Hz
Output Impedance	50 ohms

