

(5) To use variable resistance with ADC data Input, set “VR / SEN Selection switch” on an Interface Board to VR.

(6) Change the variable resistance value of Interface Board and input ADC data value into FZ750BS/FZ750BC.

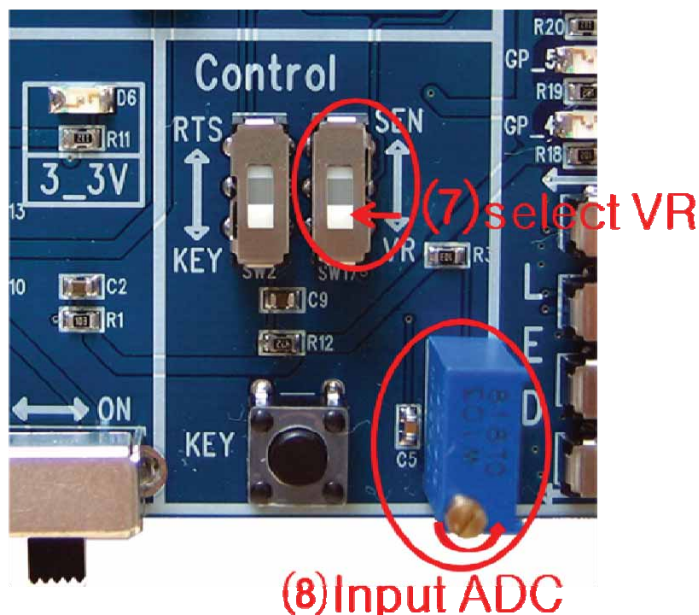

< Figure 9-1-2 ADC data Input using variable resistance >

9-1-3. KEY set-up

KEY(Digital Input) data transmission is possible by using FZ750BS/FZ750BC.

KEY transmission option is basically set to be disabled (0).

You can input KEY data through KEY port.

Set KEY transmission option of FZ750BS/FZ750BC set to be enabled as below.

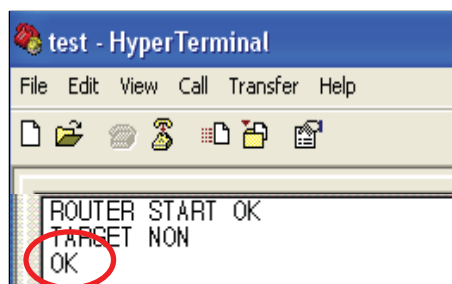

(1) Input “+++” through Serial port of PC.

(2) AT-Command can be used after “OK” is output from FZ750BS/FZ750BC.

If “OK” is not output even after inputting “+++”, press “Enter” key and input “+++” again, or reboot the device and input “+++”.

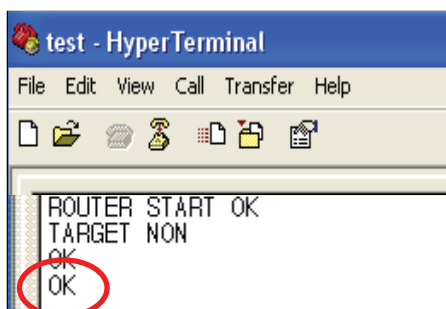

(3) Input “AT+SETKEY1” through Serial port of PC, and press “Enter” key.

(4) “OK” is output from FZ750BS/FZ750BC, which means that KEY transmission option is set to be enabled (1).

If KEY transmission option is enabled (1), FZ750BS/FZ750BC transmits KEY data to its target device.

※ If Device is set to Coordinator or Router, the Device transmits KEY data inputted to its target device regardless of the KEY option.

If KEY data is inputted into End Device, the End Device transmits the KEY data to its target device according to the KEY option (KEY option should be enabled) or makes wake-up (KEY option should be disabled) in a low power consumption mode.

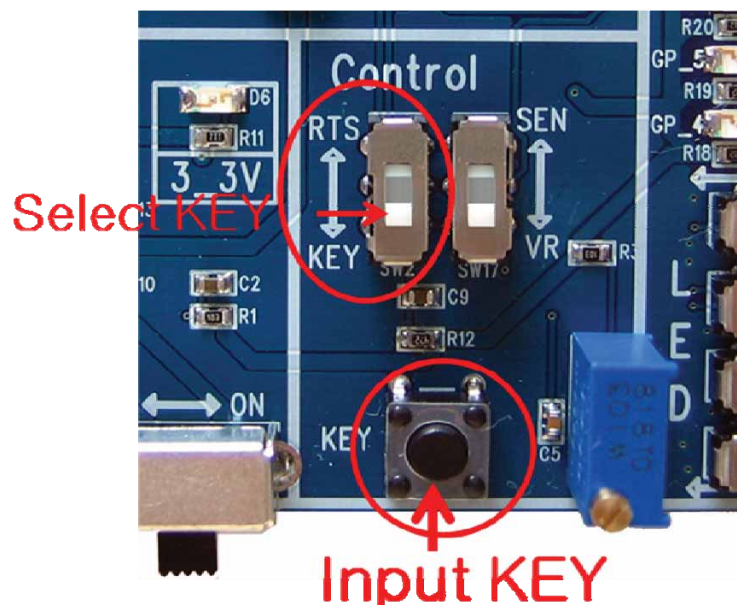

< Figure 9-1-3 KEY data Input Selection with Switch >

9-1-4. COUNT set-up

COUNT data transmission is possible by using FZ750BS/FZ750BC.

The COUNT transmission option is basically set to be disabled (0).

COUNT transmission of FZ750BS/FZ750BC is possible only when ADC data transmission option is set to be enabled.

If ADC transmission option and COUNT transmission of FZ750BS/FZ750BC are set to be enabled(1), FZ750BS/FZ750BC transmits COUNT data to its target device every certain time rather than transmits ADC Data.

“Enabling ADC data transmission option + Enabling COUNT (1)”: A Device transmits COUNT data instead of ADC data to its target device.

“Enabling ADC data transmission option + Disabled COUNT (0)”: A Device transmits ADC data to its target device.

“Disabled ADC data transmission option+ Enabling COUNT (1)”: Neither of them are sent even if the target device exists.

A commend **“AT+SETCOUNT1”** is used to set COUNT transmission option to be enabled (1).

COUNT data transmission and GPIO Value Transmission cannot be working at the same time. GPIO Option should be set to be disabled (0) for COUNT data transmission.

9-1-5. GPIO Set-up

GPIO Value Transmission is possible by using FZ750BS/FZ750BC.

GPIO Use Option of FZ750BS/FZ750BC is basically set to be disabled (0).

GPIO Value Transmission of FZ750BS/FZ750BC is possible only when KEY data or ADC data transmission Option is set to be enabled.

If KEY transmission option is set to Enable(1) and GPIO Option is set to INPUT(1), a Device reads GPIO Value and transmits the value to its target device rather than transmits KEY data when KEY data is inputted into the Device.

“Enabling KEY data transmission Option + GPIO INPUT(1)” : A device transmits GPIO Value to its target device rather than transmits KEY data when KEY data is inputted into the Device.

“Enabling KEY data transmission Option + GPIO Disable(0)” : A device transmits KEY data to its target device when the KEY data is inputted into the Device.

“Disabled KEY data transmission Option + GPIO INPUT(1)” : Neither of them are transmitted even if the target device exists.

If ADC transmission option of FZ750BS/FZ750BC is set to Enable(1) and GPIO Use Option is set to INPUT(1), FZ750BS/FZ750BC reads GPIO Value every certain time and transmits the value to its target device rather than reads ADC port and transmits ADC Data.

“Enabling ADC data transmission Option + GPIO INPUT(1)” : A Device transmits GPIO Value to its target device by Internal time rather than transmits ADC Data.

“Enabling ADC data transmission Option + GPIO Disable(0)” : A Device transmits ADC data to its target device by Internal time.

“Disabled ADC data transmission Option + GPIO Enable(1)” : Neither of them are transmitted even if the target device exists.

With a command **“AT+SETGPIO1”**, GPIO port is set to INPUT(1).

GPIO Value Transmission and COUNT data transmission cannot be working at the same time. COUNT Option should be set to be disabled (0) for GPIO Value Transmission.

(2)AT+SETGPIO1

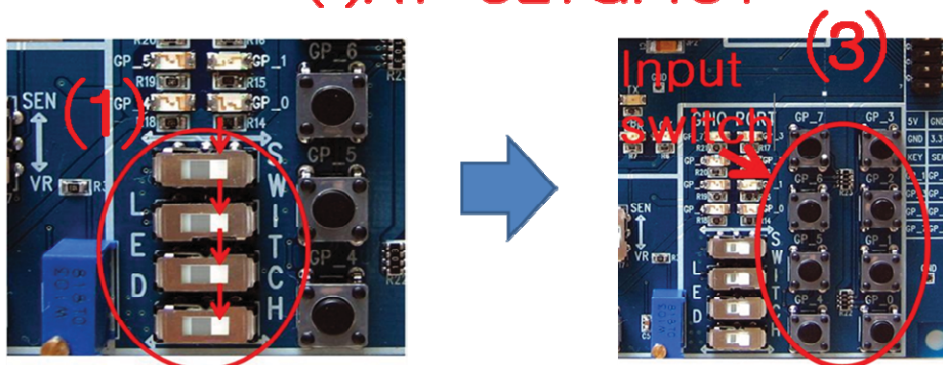

< Figure 9-1-5-(1) GPIO Input Selection with Switch >

※ When FZ750BS/FZ750BC reads GPIO port Value and transmits the Value to its target device, GPIO Option of the Device should be set to INPUT(1).

The target device outputs GPIO Value received through Serial.

If you want to make the target device output the received GPIO port Value through GPIO port, set GPIO port Use Option of the target device to OUTPUT(2).

When GPIO port Use Option of the target device is set to OUTPUT(2) and GPIO port of the target device is connected to LED on an Interface Board, The target device outputs the received GPIO data through Serial and outputs the GPIO Value through LED connected to GPIO.

With a command “AT+SETGPIO2”, GPIO OUTPUT(2) of FZ750BS/FZ750BC is set.

(2)AT+SETGPIO2

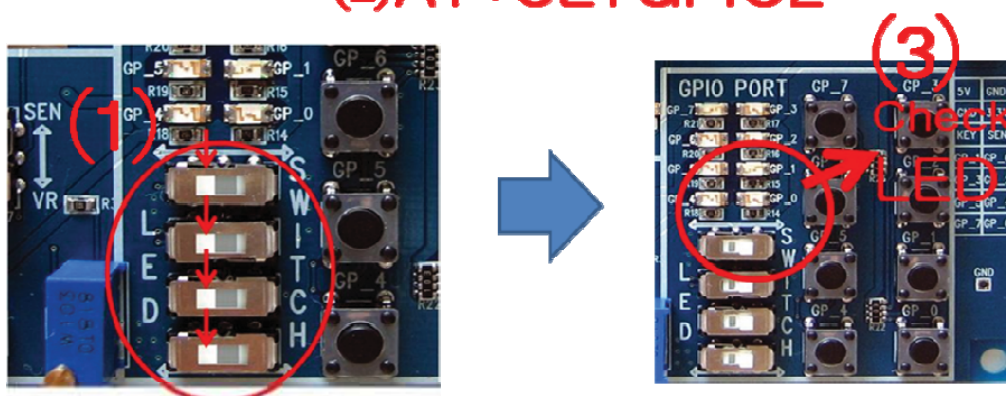

< Figure 9-1-5-(2) GPIO Output Selection with LED >

9-2. Target device set-up

To transmit Data, setting a target device, which is supposed to receive the Data, is required in terms of the Zigbee Network using FZ750BS/FZ750BC,.

With no target device, data transmission cannot be done even if data is inputted.

To set a target device, you need to know an IEEE ADDRESS of the Device.

9-2-1. Searching for an IEEE ADDRESS of FZ750BS/FZ750BC

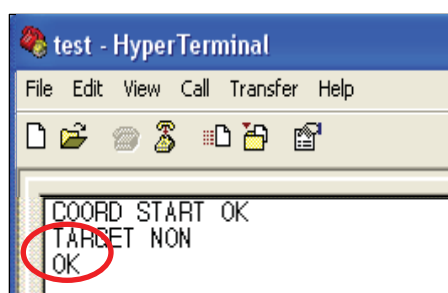

(1) Input “+++” through Serial port of PC while a Device operates. With Inputting “+++”, the mode of FZ750BS/FZ750BC switches from operation mode to AT-command mode.

Data transmission becomes possible when FZ750BS/FZ750BC is in an operation mode. Users can control FZ750BS/FZ750BC when the device is in an AT-command mode.

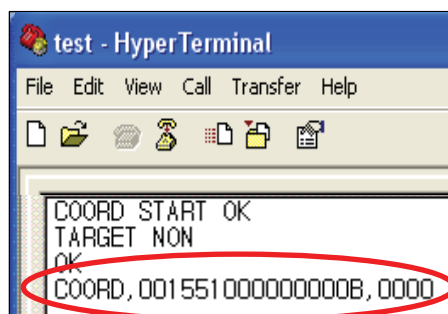

(2) “OK” is output from FZ750BS/FZ750BC, input “AT+GETLOCAL” through Serial port of PC and press Enter Key.

(3) “COORD,001551000000000B,0000” is output from the Device.

COORD : It is the Device Type of FZ750BS/FZ750BC.

001551000000000B : It is an IEEE ADDRESS of FZ750BS/FZ750BC.

0000 : It is a NETWORK ADDRESS.

(4) The IEEE ADDRESS “001551000000000B” is required for the target device set-up.

9-2-2. Target device set-up

Set a target device with the IEEE ADDRESS that is mentioned on the previous page.

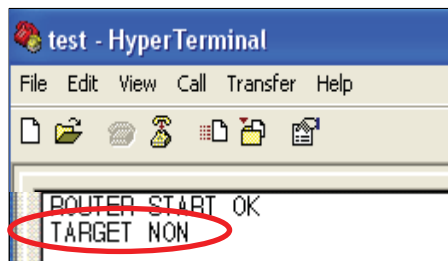

- (1) Turn the power of FZ750BS/FZ750BC ON.
- (2) FZ750BS/FZ750BC outputs a message "TARGET NON", which means that its target device is not set.

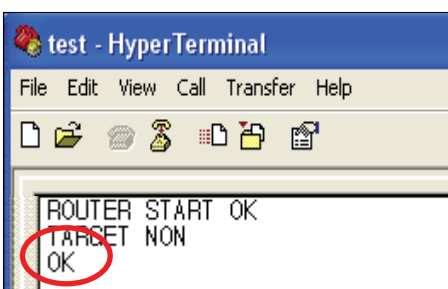

- (3) Input "+++" through Serial port of PC while FZ750BS/FZ750BC operates. "OK" is output. From then, its target device set-up is possible with AT Command.

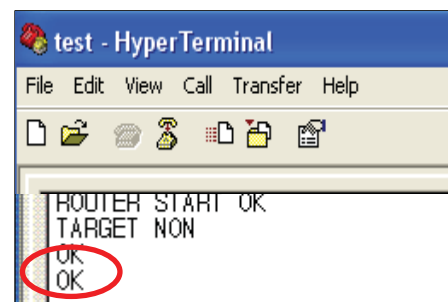

- (4) After "OK" is output from FZ750BS/FZ750BC "AT+SETTARGET001551000000000B" through Serial of PC and press "Enter" Key.

AT+SETTARGET : It is a command to save the target device's address.

001551000000000B : It is the target device's IEEE ADDRESS

- (5) "OK" is output from FZ750BS/FZ750BC which means that the command for saving target device is cognized. If "ERROR" is output, the command inputted is wrong.

- (6) Re-start FZ750BS/FZ750BC by inputting a command "ATZ" or turn the power of FZ750BS/FZ750BC off and on, again.

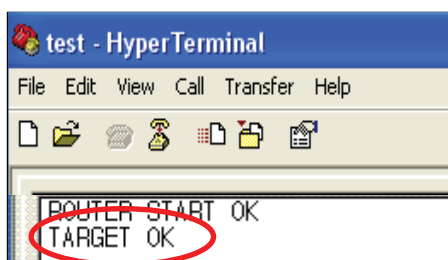

- (7) FZ750BS/FZ750BC is re-started and outputs a message "TARGET OK".

Now, the target device set-up using its address is completed.

If "TARGET ERROR" is output, FZ750BS/FZ750BC which has an IEEE ADDRESS "001551000000000B" does not exist in the

Zigbee Network or the address saved is wrong.

9-3. data transmission

Data transmission is done in the Zigbee Network.

Data is transmitted to the target device “001551000000000B” that is set on the previous page.

IEEE ADDRESS of the Device which is supposed to transmit the data is 0015510000000005.

9-3-1. UART data transmission

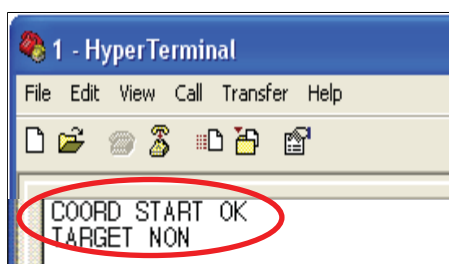

(1) Turn the power of FZ750BS/FZ750BC set to Coordinator ON.
The Zigbee Network is configured by Coordinator.

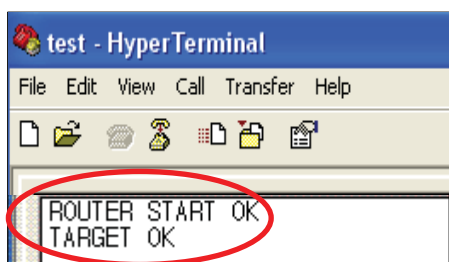

(2) Turn the power of FZ750BS/FZ750BC set to Router ON.
The Device participates in the Zigbee Network.
Its target device is automatically set.
A message “TARGET OK” is output.

If, “TARGET NON” or “TARGET ERROR” is output, its target device is not set.

Do the “9-2-2.Target device set-up”, again.

(3) Input “1234567890” into Hyper terminal and press “Enter(0x0D)” key.

FZ750BS/FZ750BC transmits data (1234567890) inputted, Carriage Return(0x0D), and Line Feed(0x0A) at the same time. (Do not input 0x0A. 0x0A is automatically added by FZ750BS/FZ750BC.)

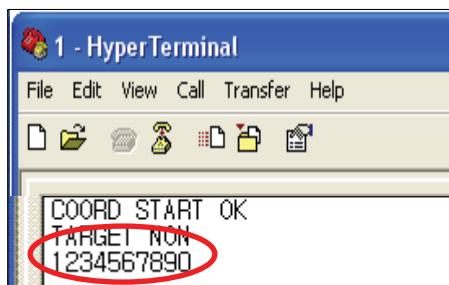

(4) Serial Data “1234567890” is output.

- ※ Input Serial data through UART port of FZ750BS/FZ750BC
 - ※ After inputting the serial data, press “Enter” key.
 - ※ 53 bit including “Enter” key is a maximum length of Serial data can be transmitted by FZ750BS/FZ750BC
 - ※ The Serial data sent from a Device is output through UART port of its target device.
 - ※ the other forms of data cannot be transmitted while the Serial data is inputted.
- ※ To transmit the other forms of data after Serial data transmission, you should wait until you get the Serial Data’s result value. In other words, the other data transmission becomes possible after OK LED or ERROR LED shows its status.

9-3-2. KEY data transmission

Process the data transmission in the Zigbee Network.

Process the data transmission with the target device “001551000000000B”.

IEEE ADDRESS of the Device which is supposed to transmit data is 0015510000000005.

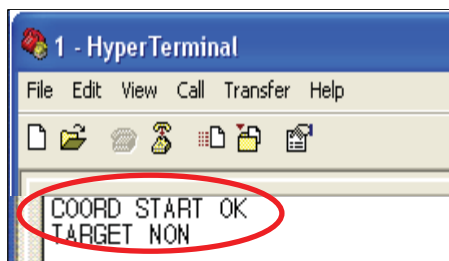

- (1) Turn the power of FZ750BS/FZ750BC set to Coordinator ON.
The Zigbee Network is configured by Coordinator.

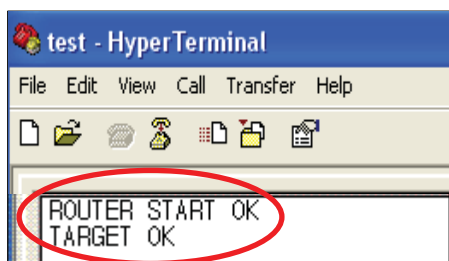

- (2) Turn the power of FZ750BS/FZ750BC set to Router ON.
The Device participates in the Zigbee Network.
Its target device is automatically set.
A message “TARGET OK” is output.

If, “TARGET NON” or “TARGET ERROR” is output, its target device is not set.
Do “9-2-2. Target device set-up” ,again.

(3) Input KEY data through KEY port of FZ750BS/FZ750BC.

Push KEY switch on an Interface Board.

KEY port of FZ750BS/FZ750BC operates when Low is inputted.

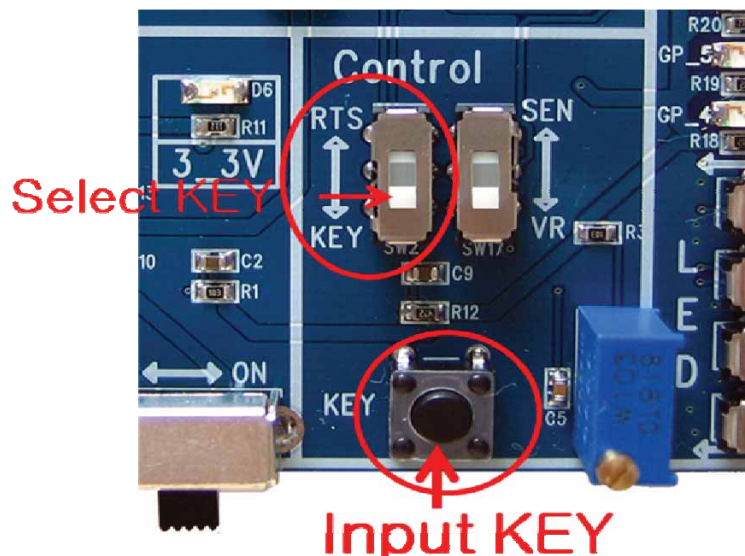

< Figure 9-3-2 KEY data Input >

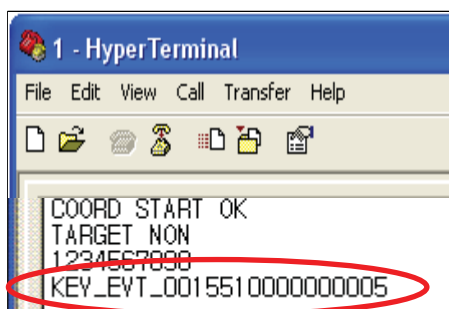

(4) KEY data “KEY_EVT_0015510000000005” is output.

KEY_EVT_ : it means that KEY data is received.

0015510000000005 : It is an Address of the Device which sent the KEY Data

※ Input KEY data through KEY port of FZ750BS/FZ750BC.

※ If you input Low(0V) through KEY port of FZ750BS/FZ750BC, FZ750BS/FZ750BC cognize it as KEY signal.

※ When the signal is inputted through the KEY port, FZ750BS/FZ750BC transmits a certain form of data to its target device.

※ KEY data is output transformed as a certain form through UART port of the target device.

※ To transmit the other forms of data after KEY data transmission, you should wait until you get the KEY Data's result value. In other words, the other data transmission becomes possible after OK LED or ERROR LED shows its status.

9-3-3. ADC data transmission

Data transmission is done in the Zigbee Network.

Data is transmitted to the target device "001551000000000B" that is set on the previous page.

IEEE ADDRESS of the Device which is supposed to transmit the data is 0015510000000005.

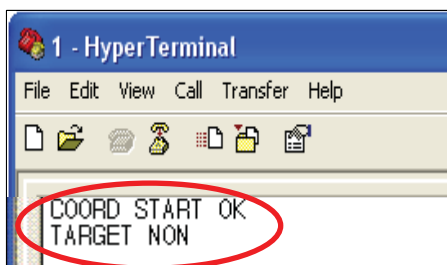

(1) Turn the power of FZ750BS/FZ750BC set to Coordinator ON.
The Zigbee Network is configured by Coordinator.

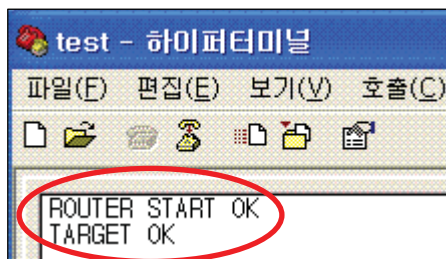

(2) Turn the power of FZ750BS/FZ750BC set to Router ON.
The Device participates in the Zigbee Network.
Its target device is automatically set.
A message "TARGET OK" is output.

If, "TARGET NON" or "TARGET ERROR" is output, its target device is not set.
Do the "9-2-2.Target device set-up", again.

(3) Input Analog data through ADC port of FZ750BS/FZ750BC.

Change Variable resistance of an Interface Board.

ADC port of FZ750BS/FZ750BC changes Analog Data (0V~1.5V) to Digital Data (0x0000~0x03FF).

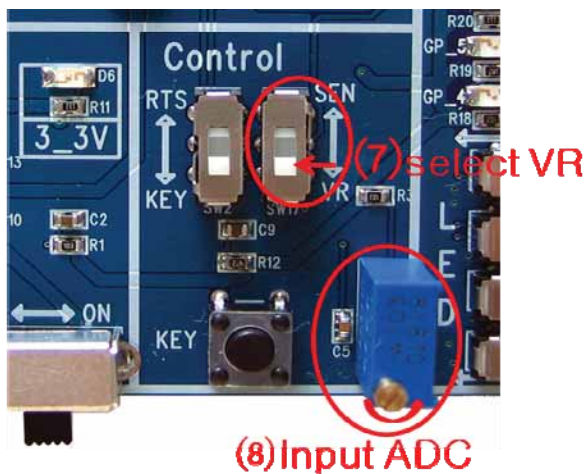

< Figure 9-3-3 ADC data Input >

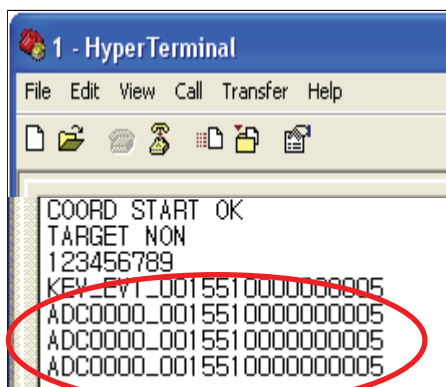

```

1 - HyperTerminal
File Edit View Call Transfer Help
COORD START OK
TARGET NON
123456789
KEY_EVT_0015510000000005
ADC0000_0015510000000005
ADC0000_0015510000000005
ADC0000_0015510000000005
ADC0000_0015510000000005

```

(4) ADC data “ADC0000_0015510000000005” is output

ADC0000_: It means ADC data 0000 is received.

0015510000000005: It is an address of the Device which transmitted ADC Data.

- ※ Input ADC data through ADC port of FZ750BS/FZ750BC.
- ※ The possible range of voltage for Input through ADD port is from 0V to 1.5V.
- ※ FZ750BS/FZ750BC reads ADC port every certain time and transmits.
(Refer to how to set internal time using GUI)
- ※ FZ750BS/FZ750BC changes Analog signal inputted through ADC port to Digital signal.
(0x0000 ~ 0x03FF)
- ※ FZ750BS/FZ750BC transmits the Digital data transformed to its target device.
- ※ ADC data that is transformed to Digital signal is output through UART port of the target device.

※ To transmit the other forms of data after ADC data transmission, you should wait until you get the ADC Data's result value. In other words, the other data transmission becomes possible after OK LED or ERROR LED shows its status.

9-3-4. COUNT data transmission

- (1) Set ADC data transmission Option to be enabled as shown on “9-1-2. ADC Set-up”
- (2) Set COUNT Option to be enabled for COUNT Transmission.
Use a command “AT+SETCOUNT1”.
- (3) After FZ750BS/FZ750BC participates in the Zigbee Network, set Enabling ADC transmission option (AT+SETADC1), Internal time (AT+SETTMR10: set internal time to 10seconds), and input “AT+SETCOUNT1”. FZ750BS/FZ750BC transmits COUNT Value to its target device by the internal time rather than transmits ADC Data.
- (4) COUNT data is output.
=> “CNT000A_0015510000000005” is output
 CNT000A_: COUNT data 000A is received.
 0015510000000005: This is an address of the Device which transmitted COUNT Data.

9-3-5. GPIO data transmission

< Transmitting GPIO data instead of KEY data >

- (1) Set KEY data transmission option to be enabled as shown on “9-1-3. KEY Set-up”.
- (2) Set GPIO Use to INPUT for GPIO data transmission.
Use a command “AT+SETGPIO1”.

Connect switch on an Interface Board to GPIO.

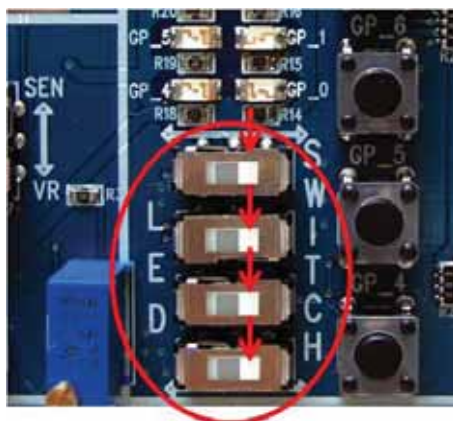

< Figure 9-3-5-(1) GPIO Input Selection (Select SWITCH) >

(3) After FZ750BS/FZ750BC participates in the Zigbee Network, set KEY transmission option to be enabled (AT+SETKEY1), input a command “AT+SETGPIO1”. Although KEY data is input, FZ750BS/FZ750BC transmits GPIO port to its target device rather than transmits KEY Data.

Input the value though GPIO port.

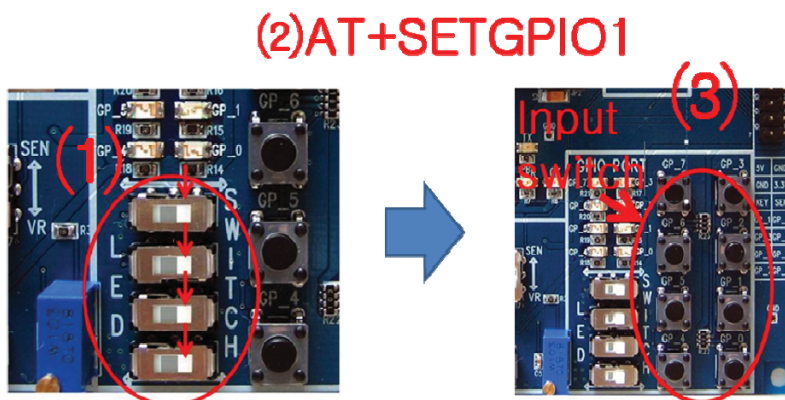

< Figure 9-1-5-(2) GPIO Input with Switch >

Input KEY data as the value remains.

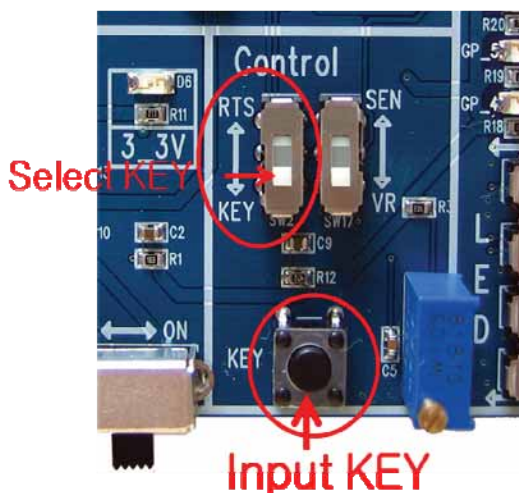

< Figure 9-1-5-(3) KEY data Input >

(4) GPIO data is output.

=> “GPT007F_0015510000000005” is output

GPT007F_: It means that GPIO data 007F is received.

0015510000000005: It is an address of the Device which transmitted GPIO Data.

< Transmitting GPIO data instead of ADC data >

(1) Set ADC data transmission Option to be enabled as shown on “9-1-2. ADC Set-up”.

(2) To transmit GPIO Data, set GPIO Use Option to INPUT.

- use a command “AT+SETGPIO1”.

Connect Switch on an Interface Board to GPIO.

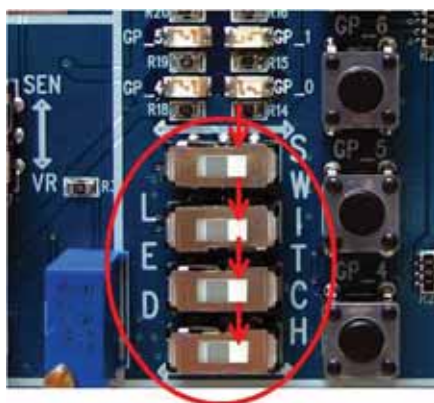

< Figure 9-3-5-(4) GPIO Input Selection (Select SWITCH) >

(3) After FZ750BS/FZ750BC participates in the Zigbee Network, set Enabling ADC transmission option (AT+SETADC1), Internal time (AT+SETTMR10: Internal time 10sec Set-up), and input “AT+SETGPIO1”. FZ750BS/FZ750BC transmits GPIO Value to its target device by the internal time rather than transmits ADC Data.

Input the value through GPIO port.

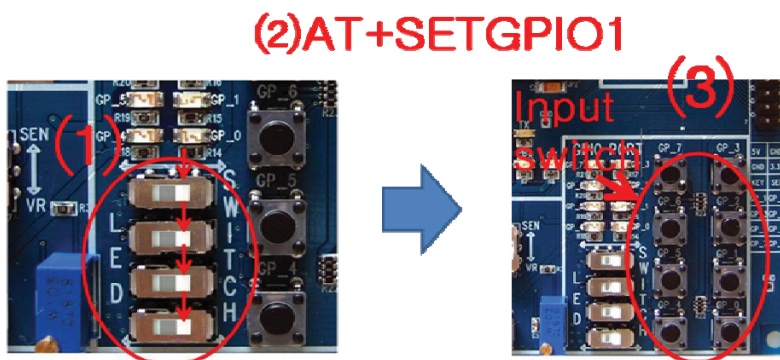

< Figure 9-1-5-(5) GPIO Input with Switch

FZ750BS/FZ750BC reads GPIO data value every certain time and transmits the value to its target device as the inputted value remains.

※ When COUNT data transmission option is set to be enabled(AT+SETCOUNT1), COUNT data is transmitted instead of GPIO data.

To transmit GPIO data, COUNT transmission option should be disabled. (AT+SETCOUNT0)

(4) GPIO data is output in Hyper Terminal of a target device.

=> "GPT007F_0015510000000005" is output.

GPT007F_: It means that GPIO data 007F is received.

0015510000000005: It is an address of the Device which transmitted the GPIO Data.

※ How to output the received GPIO data through GPIO port.

If a target device receives GPIO Data, the target device outputs a certain form of data through Serial port.

The following is how to output the received GPIO data through GPIO port.

1) Set GPIO port of FZ750BS/FZ750BC set to a target device to OUTPUT.

- use a command "AT+SETGPIO2".

2) Connect the GPIO port to LED on an Interface Board.

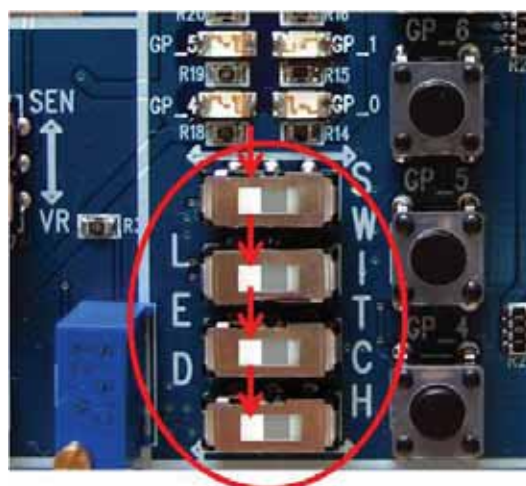

< Figure 9-3-5-(6) GPIO Output Selection (Select LED) >

3) When FZ750BS/FZ750BC set to a target device receives GPIO Data, the Device outputs a certain form of data through Serial port.

If "AT+SETGPIO2" is set, GPIO port outputs GPIO port value through LED on an Interface Board.

(2) AT+SETGPIO2

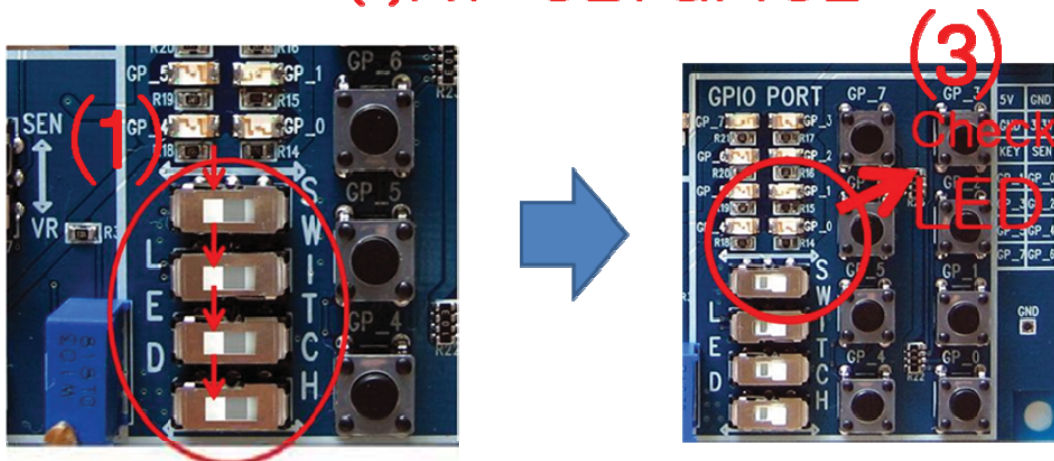

< Figure 9-3-5-(7) GPIO Output Check >

A recipe of KEY data : **KEY_EVT_0015510000000000BWrWn**
 Data type the IEEE address of transmitter

A recipe of ADC data : **ADC0012_0015510000000000BWrWn**
 Data type value the IEEE address of transmitter

A recipe of Serial data : **123456789abcdefgWrWn**
 Data

A recipe of Count data : **CNT0005_0015510000000000BWrWn**
 Data type value the IEEE address of transmitter

A recipe of GPIO data : **GPT007F_0015510000000000BWrWn**
 Data type value the IEEE address of transmitter

< FZ750BS/FZ750BC Forms of received data >

10. FZ750BS/FZ750BC Set-up using GUI(SENBEE)

To Set FZ750BS/FZ750BC, use Window GUI provided by Firmtech rather than use Serial program (Hyper Terminal)

First, turn the power of FZ750BS/FZ750BC on

Turning the power ON is for checking the Network's status.

You cannot connect FZ750BS/FZ750BC to GUI while the Device checks the Network's status.

It takes about 3 ~ 5 seconds.

After turning the power of FZ750BS/FZ750BC ON (If the Device is set to Factory set value), "ROUTER START ERROR" or "ROUTER START OK" is output, which means that checking Network is completed.

Window GUI can be used after the checking Zigbee Network's status.

GUI cannot be connected while FZ750BS/FZ750BC operates as End Device and FZ750BS/FZ750BC is in a low power consumption mode. (Device enters into a low power consumption mode if its target device is set)

If you want to operate FZ750BS/FZ750BC as End Device, put the FZ750BS/FZ750BC in a wake-up mode. You can set FZ750BS/FZ750BC using GUI from then.

Connect FZ750BS/FZ750BC set to End Device to GUI before the End Device enters into a low power consumption mode again. (End Device enters into the low power consumption mode again 1 second after wake-up)

The following should be prior to use Window GUI.

- (1) Connect FZ750BS/FZ750BC to an Interface Board, and connect COM port(Serial port) of PC.
- (2) Turn the power of FZ750BS/FZ750BC ON.
- (3) Check if the checking Zigbee Network's status is completed.

If the Zigbee Network does not exist, STATUS LED flickers quickly. GUI Connection is possible.

If a Device participates in the Zigbee Network and target device is not set, STATUS LED flickers once. GUI Connection is possible.

If a Device participates in the Zigbee Network and target device is set, STATUS LED is turned ON and OK /ERROR LED is turned OFF. GUI connection is possible.

- (4) Execute Window GUI after checking the Zigbee Network's status.



10-1. Serial port Connection

(1) Click "SERAIL PORT OPEN" Button.



(2) Select the ports connected FZ750BS/FZ750BC and select the signal speed.

(3) Click "OPEN" button.

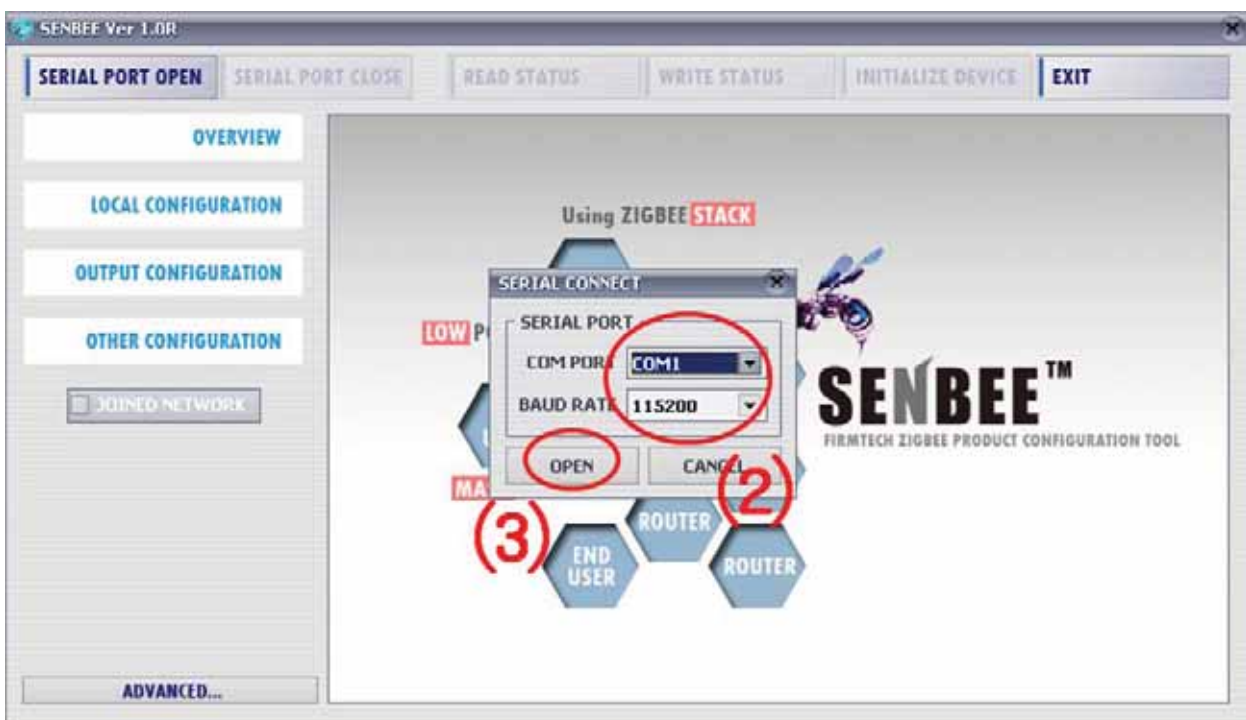

(4) Wait until Serial Connection is completed.

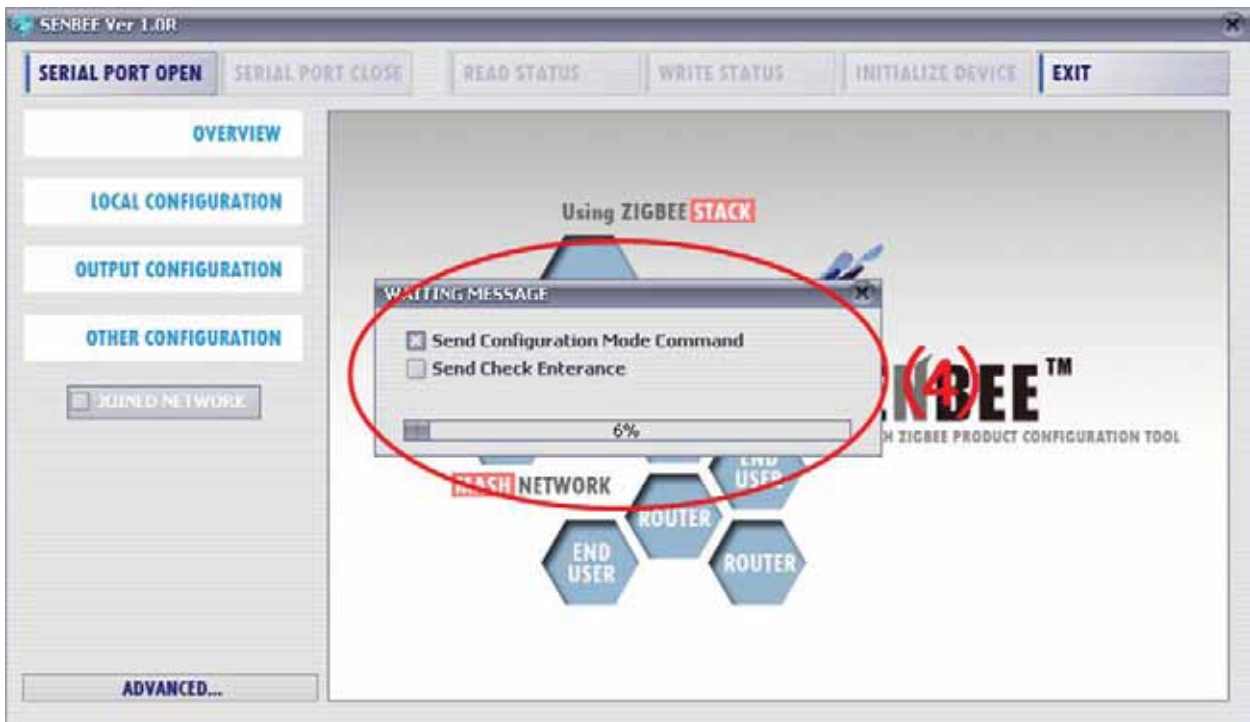

(5) Click "READ STATUS" button.



(6) Wait until READ STATUS is completed.

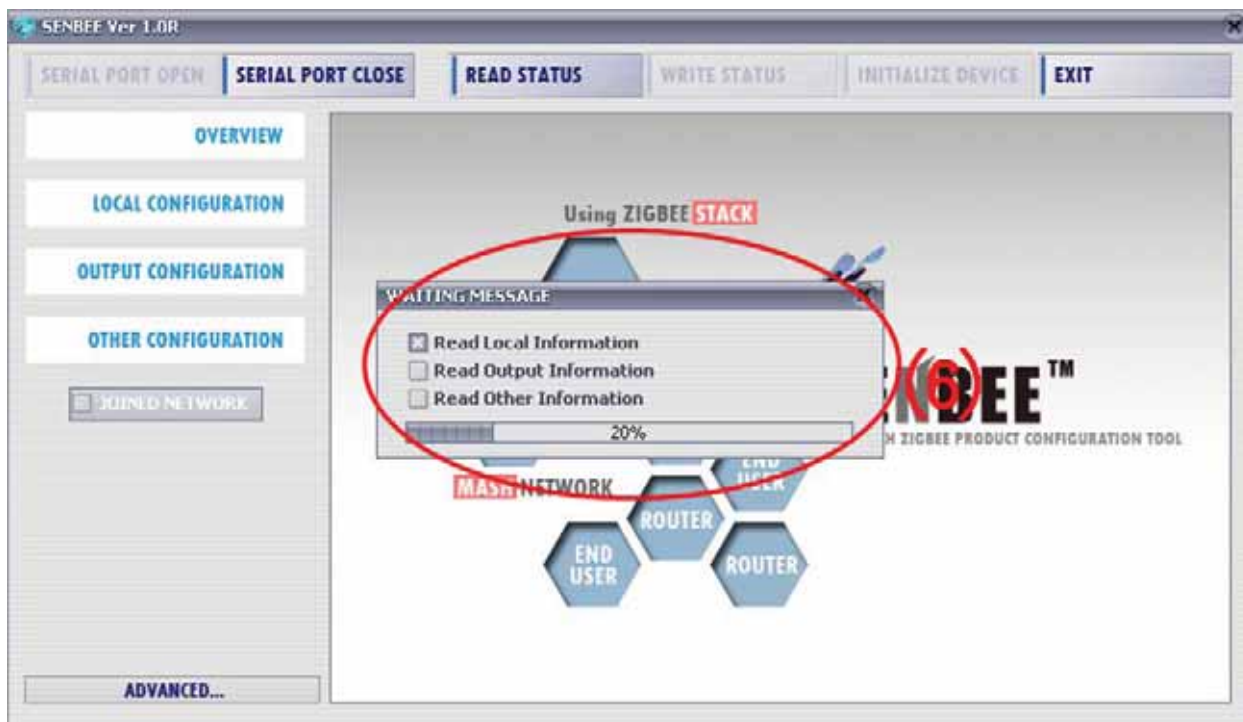

(7) The program is ready for set-up.



10-2. OVERVIEW

(1) Click "OVERVIEW" button.



(2) Check currently set value of FZ750BS/FZ750BC.

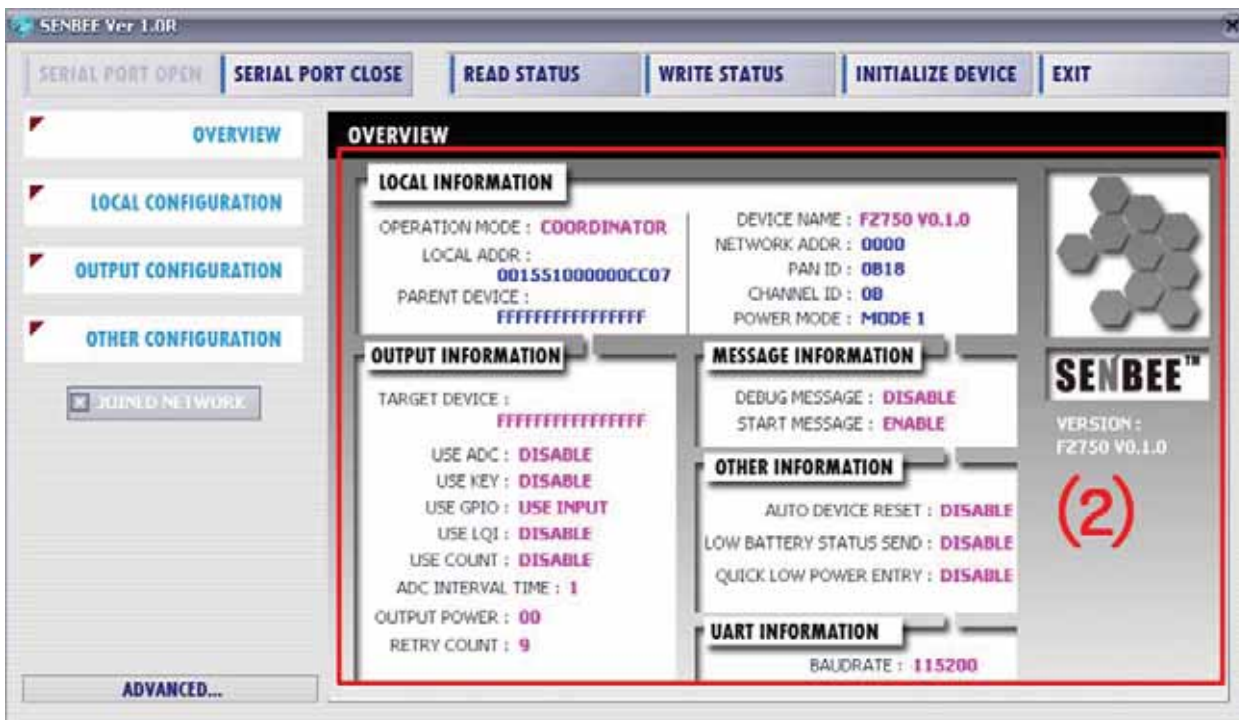

10-3. LOCAL CONFIGURATION

(1) Click “LOCAL CONFIGURATION” button.

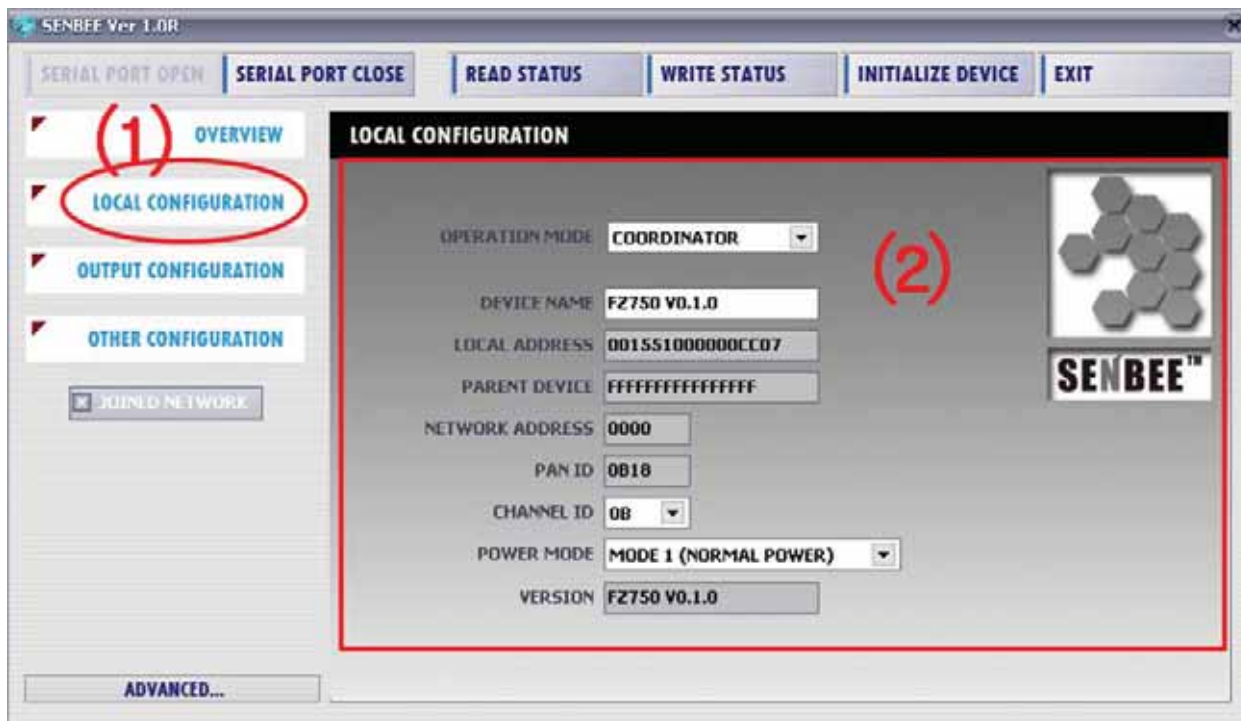

(2) Set Local Configuration of FZ750BS/FZ750BC.

“OPERATION MODE”: Select Device Type of Device Type as END DEVICE / ROUTER / COORD

“DEVICE NAME”: Set a name of FZ750BS/FZ750BC. (12bit is a maximum length)

“LOCAL ADDRESS”: It is an IEEE ADDRESS of FZ750BS/FZ750BC (Making correction is impossible)

“PARENT DEVICE”: It is a Parent node in the Zigbee Network. (Making correction is impossible)

“NETWORK ADDRESS”: It is a NETWORK ADDRESS (Making correction is impossible)

“PAN ID”: It is an Identifier given by Coordinator. (Making correction is impossible)

“CHANNEL ID”: Set channel for Zigbee Network Participation.(0B ~ 19)

The Channel of a Device should be the same as that of another one which is supposed to be in the same Zigbee Network. (0x1A Unserviceability)

“POWER MODE”: Set a low power consumption mode in the case of End Device

MODE 1: It uses 25uA in the low power consumption mode.

(The Device is not reset even if it is put in a wake-up mode)

MODE 2: It uses 2uA in the low power consumption mode.

(The Device is reset after it starts wake-up)

MODE 3: It uses 1uA in the low power consumption mode.

(The Device is reset after it starts wake-up)

“VERSION”: It shows a version of FZ750BS/FZ750BC Device. (Making correction is impossible)

10-4. OUTPUT CONFIGURATION

(1) Click “OUTPUT CONFIGURATION” button.

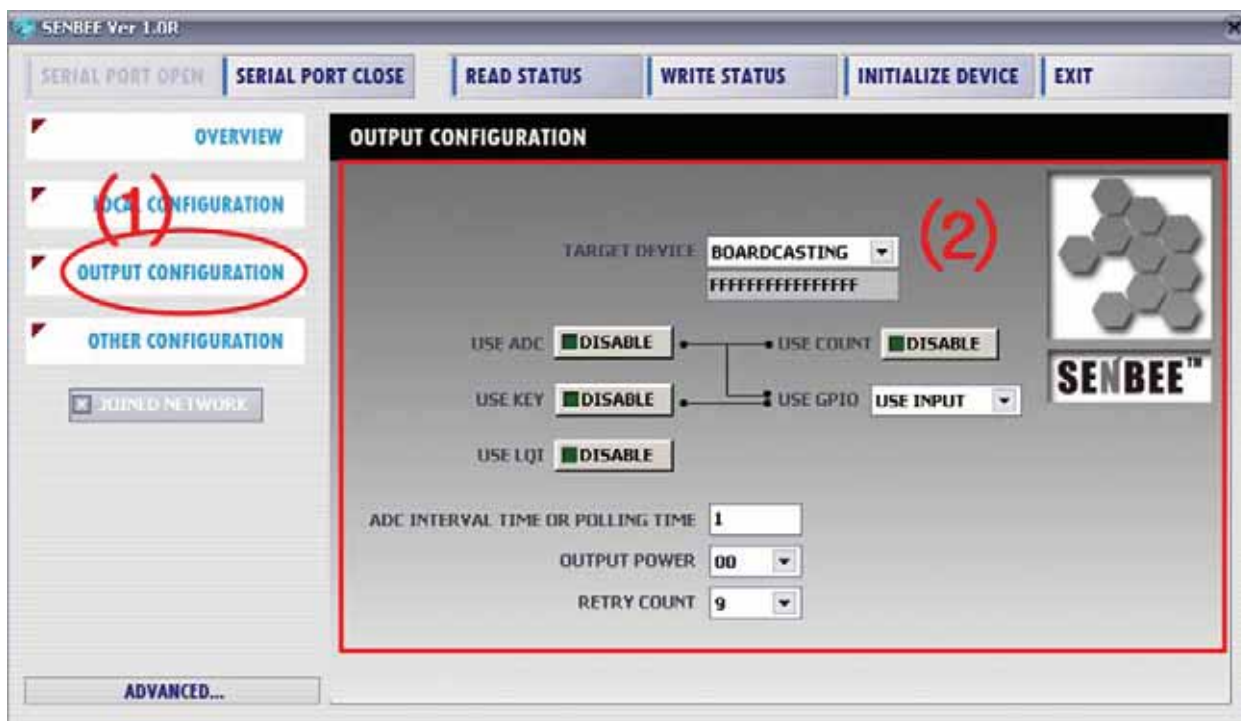

(2) Set Output Configuration of FZ750BS/FZ750BC.

“TARGET DEVICE”: Input an IEEE ADDRESS of the Device which is supposed to set a target device.

NONE TARGET: Select it if you don’t want to set any target devices.

BROADCASTING: Select it if you want set all devices to target devices.

USER INPUT: Input an IEEE ADDRESS of target device.

“USE ADC”: Set weather ADC port is used.

“USE KEY”: Set weather KEY port is used.

“USE LQI”: Set weather Receive Sensitivity of data received is output.

“USE COUNT”: Set weather COUNT Use Option is used.

“USE GPIO”: Set function of GPIO.

DISABLE: GPIO port is not used.

USE INPUT: GPIO port is used as Input.

USE OUTPUT: GPIO port is used as Output.

“ADC INTERVAL TIME OR POLLING TIME”: set internal time of FZ750BS/FZ750BC. (0 ~ 65000sec)

It is used for ADC Transmission in case of Coordinator and Router. (0 ~ 65000sec)

It is used when End Device enters into Low power consumption mode. (0 ~ 255sec)

“OUTPUT POWER”: Set Wireless Output Intensity of FZ750BS/FZ750BC. (Maximum: 0x00, minimum: 0x12)

“RETRY COUNT”: Set the number of re-transmission (0 ~ 9)

10-5. OTHER CONFIGURATION

(1) Click "OTHER CONFIGURATION" button.

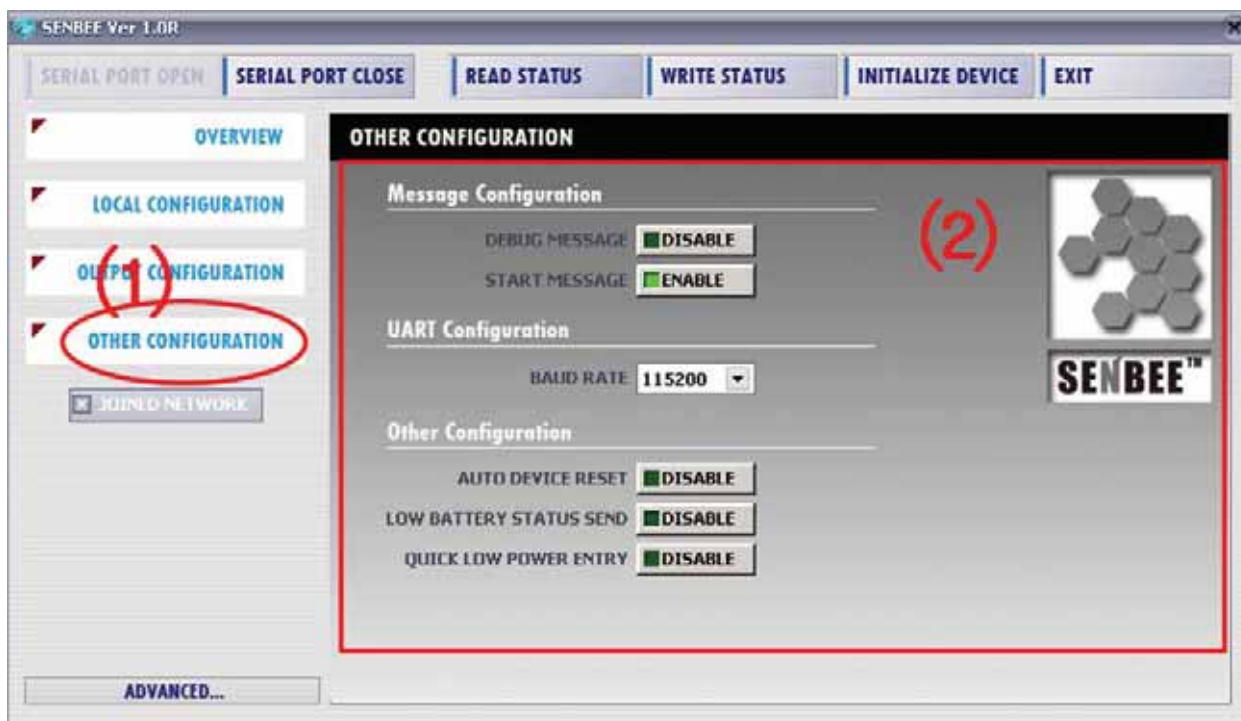

(2) Set OTHER Configuration of FZ750BS/FZ750BC.

<Message Configuration>

“**DEBUG MESSAGE**”: Set whether Debug message is output while FZ750BS/FZ750BC operates.

“**START MESSAGE**”: Set whether Start message is output while FZ750BS/FZ750BC operates.

<UART Configuration>

“**BAUD RATE**”: Set the signal speed of UART.

<Other Configuration>

“**AUTO DEVICE RESET**”: Set whether reset FZ750BS/FZ750BC when FZ750BS/FZ750BC fails to participate in the Zigbee Network.

Set whether reset FZ750BS/FZ750BC when FZ750BS/FZ750BC fails to set its target device.

“**LOW BATTERY STATUS SEND**”: Set whether Battery’s status of target device is transmitted when FZ750BS/FZ750BC’s Input Voltage is 2.6V.

“**QUICK LOW POWER ENTRY**”: Set whether Entry towards Low power consumption mode is processed quickly

10-6. WRITE STATUS

(1) Click “WRITE STATUS” button.

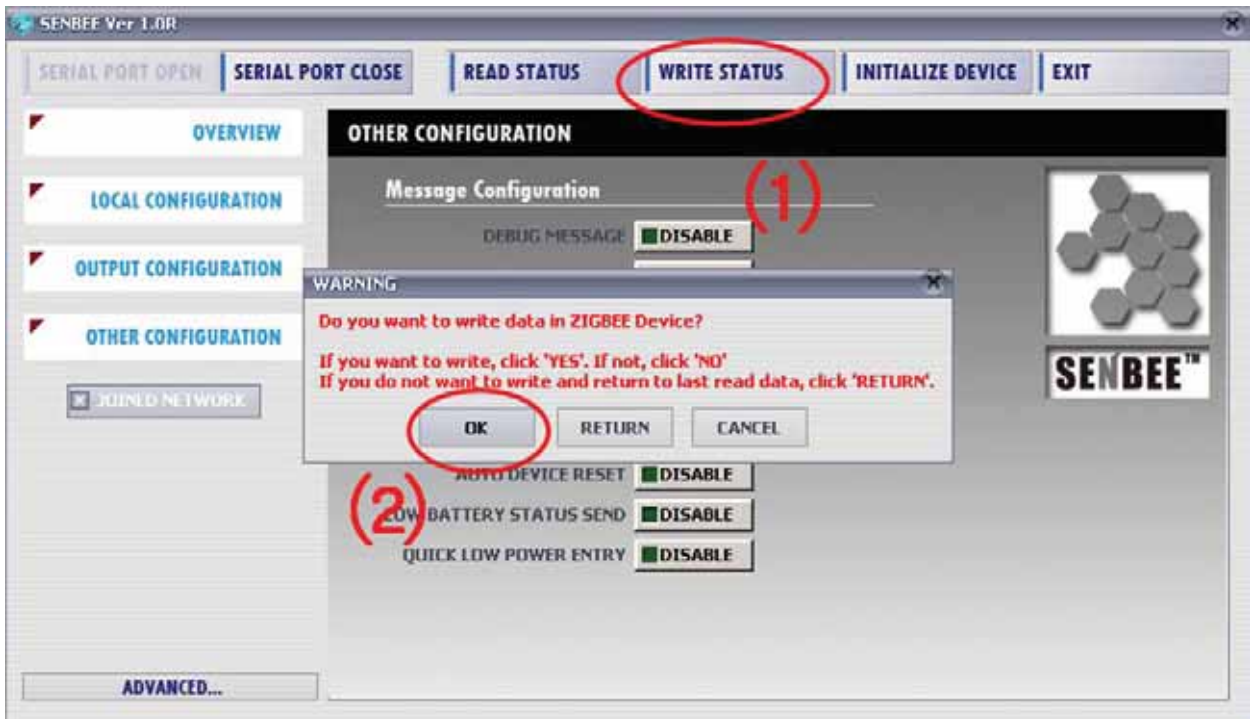

(2) Click “OK” button.

“OK”: Click it if you want to write data in FZ750BS/FZ750BC.

“RETURN”: Click it if you want return to last read data.

“CANCEL”: Click it if you want to cancel the process of WRITE STATUS .

(3) Wait until the WAITING MESSAGE is gone.



(4) Serial port is closed and program goes back to the initial scene.



(5) FZ750BS/FZ750BC set-up using Window GUI is completed.

Turn the power of the Device OFF and process set-up for other devices.

10-7. INITIALIZE DEVICE

It is used when you want to initialize a Device to factory set value.

All contents in the Device are removed and the Device goes back to factory set value.

To initialize FZ750BS/FZ750BC to factory set value, connect FZ750BS/FZ750BC to GUI and finish with WRITE STATUS.

INITIALIZE DEVICE button is not activated before that.

(1) Click "INITIALIZE DEVICE" button.

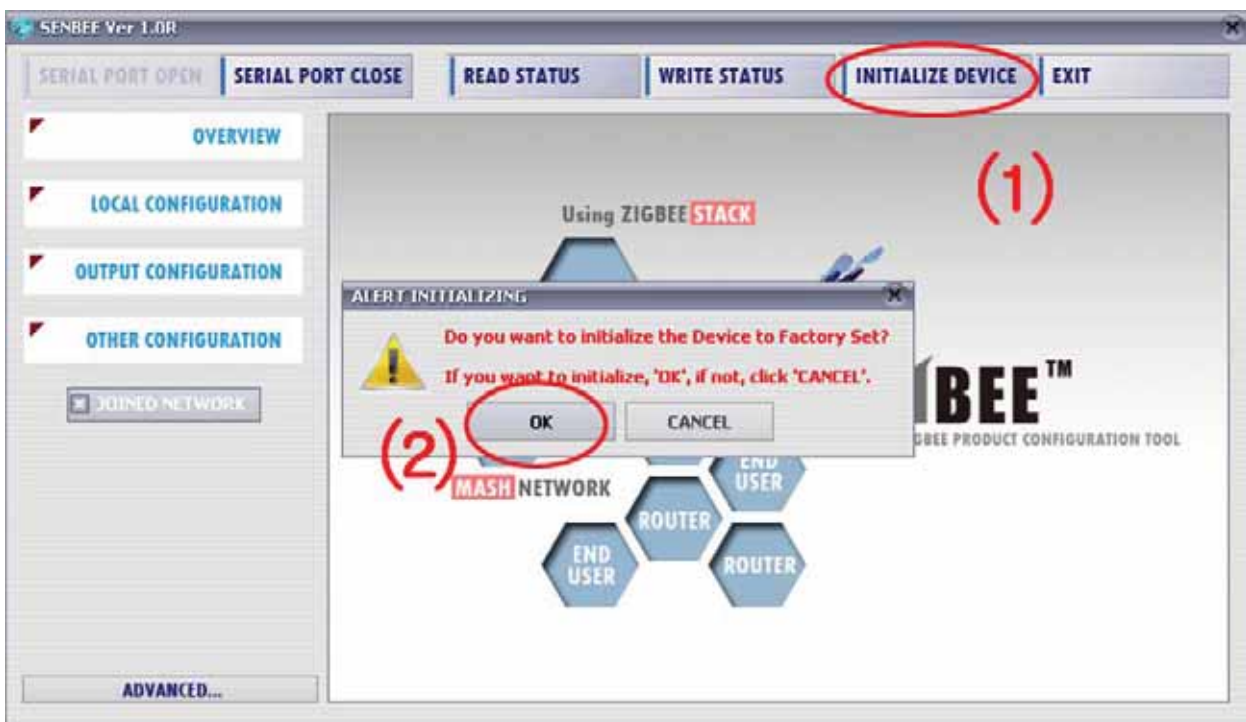

(2) Click "OK" button.

"OK": If you want to initialize the Device, click it.

"CANCEL": If you want to cancel the process, click it.

11. FZ750BS/FZ750BC Management TIP

Refer to the following to configure Zigbee Network properly in terms of data transmission and Controls.

11-1. FZ750BS/FZ750BC Device Type Set-up

(1) End Device Set-up

Set Z750BS/FZ750BC to End Device before Coordinator and Router is set. (**AT+SETEND**)

Turn the power of the FZ750BS/FZ750BC OFF.

(2) Router Set-up

Set FZ750BS/FZ750BC to Router before Coordinator is set. (**AT+SETROUTER**)

Turn the power of the FZ750BS/FZ750BC OFF.

(3) Coordinator Set-up

Set FZ750BS/FZ750BC to Coordinator. (**AT+SETCOORD**)

Turn the power of FZ750BS/FZ750BC OFF.

11-2. Zigbee Network Configuration

(1) Turn the power of FZ750BS/FZ750BC set to Coordinator ON.

(2) Turn the power of Router and End Device which are supposed to make 1 Depth ON.

- You can create Devices in 1 Depth up to 8.

(3) Turn the power of Router and End Device which are supposed to make 2 Depth ON.

- You can create Devices in 2 Depth up to the number of Router in 1 Depth * 8.
- Devices are automatically created in 1 Depth if any seats are available in 1 Depth.

(4) Turn the power of Router and End Device which are supposed to make 3 Depth ON.

- You can create Devices in 3 Depth up to the number of Router in 2 Depth * 8.
- Devices are automatically created in 1/2 Depth if any seats are available in 1/2 Depth.

(5) Turn the power of Router and End Device which are supposed to make 4 Depth ON.

- You can create Devices in 4 Depth up to the number of Router in 3 Depth * 8.
- Devices are automatically created in 1/2/3 Depth if any seats are available in 1/2/3 Depth.

11-3. [Set-up] target device & data transmission type

(1) Set target device of each Device after the Zigbee Network is configured.

Save an IEEE ADDRESS of target device by using a command “AT+SETTARGET”

Reset the Device so that its target device set-up can be processed.

< It is not recommended that there is a lot of traffic in the Zigbee Network. >

Refer to the meanings of **Traffic** in terms of Zigbee Network.

The Traffic is caused by “Zigbee Device which performs data transmission in the Zigbee Network”, “Zigbee Device which performs data transmission to get its target device”, “Zigbee Device which transmits data to its target device” “ACK data for checking if Zigbee Device transmits data its target device properly”, and “Transmitted data for checking if the Zigbee Network works properly.”

There is no traffic in case of Coordinator and Router unless they are turned ON again.

Coordinator and Router are always turned ON because they intermediate Devices.

In case of End Device, a lot of traffic is caused because the power of End Device is turned ON and OFF repeatedly.

If there are a lot of Nodes in the Zigbee Network, set the space of time longer for data transmission between the Nodes,

Especially, in case of End Device, great caution is required.

(A space of data transmission per 10 Devices: minimum 2seconds)

The Shorter the space of data transmission is, the more traffic in the Zigbee Network is caused.

Do not change target device too often. When you set or change a target device, data for transmission is more created to get its route. The more data there is in the Zigbee network, the more traffic is caused.

In case that End Device receives ACK data after data transmission, (For control using MICOM and data re-transmission) set ACK data transmission receipt to be enabled by using a command **AT+SETACK1**.

In this situation, more traffic in the Zigbee Network is caused in comparison.

If ACK data receipt is not required after data transmission using End device (For data transmission only), set ACK data receipt to be disabled by using a command **AT+SETACK0** .

In this situation, less traffic in the Zigbee Network is caused in comparison.

Do not set target device to FFFFFFFFFFFFFFFF(Broadcast) when performing data transmission.

If data is transmitted by Broadcast, all Routers in the middle transmit the data to all nodes again.

The more Devices using Broadcast data exist and the more Routers in the middle exist, the more traffic is caused in the Zigbee Network.

Do not use Broadcast data transmission unless it is essential.

When FZ750BS/FZ750BC performs a command to get information on Nodes participated in the Zigbee Network, a lot of traffic in the Zigbee Network is caused.

Because Router cannot save information on all nodes in the Zigbee Network, the inquired data is mostly transmitted by broadcast.

Broadcast data increase traffic in the Zigbee Network.

In case of you need, use AT command to inquire information on nodes in the Zigbee Network.

A lot of traffic in the Zigbee Network bothers data transmission and target device set-up

(2) Set data transmission type after target device set-up.

To set ADC data transmission, use commands “**AT+SETADC1**” and “**AT+SETTMR**”.

If FZ750BS/FZ750BC is Coordinator or Router, use a command “**AT+SETTMR**” for the set-up in **0 ~ 65000 sec**.

If FZ750BS/FZ750BC is End Device, use a command “**AT+SETTMR**” in **0 ~ 255 sec**.

The Device reads ADC port every certain time and transmits ADC data to its target device.

The target device receives “ADC0015_0015510000000005 + 0x0D + 0x0A”.

For setting KEY data transmission, use a command **AT+SETKEY1**.

If KEY data is inputted in a Device, the Device transmits KEY data to its target device.

The target device receives “KEY_EVT_0015510000000005 + 0x0D + 0x0A”.

No additional setting is required for Serial data transmission.

If Serial data is inputted in a Device, the Device transmits Serial data to its target device.

The target device receives “KEY_EVT_0015510000000005 + 0x0D + 0x0A”.

Press Enter key[ENTER](0x0D) after inputting Serial Data, and then the Serial data is finally sent.

The target device receives “Serial data from the Device + 0x0D + 0x0A”.

For setting COUNT data transmission, use a command **AT+SETCOUNT1**.

Process COUNT data transmission after ADC data transmission Set-up is completed.

A device transmits COUNT data to its target device every certain time.

The target device receives “CNT0005_0015510000000005 + 0x0D + 0x0A”

For setting GPIO data transmission, use a command **AT+SETGPIO1**(Set INPUT)

Set GPIO data transmission Option to INPUT after KEY data transmission is completed.

Set GPIO data transmission Option to INPUT after ADC data transmission is completed.

If KEY data transmission is completed to GPIO Transmission, a Device transmits GPIO data to its target device after inputting GPIO data and KEY Data.

If ADC data transmission is completed to GPIO Transmission, a Device transmits GPIO data to its target device every certain time.

The target device receives “GPT007F_0015510000000005 + 0x0D + 0x0A”.

Use GPIO Switch on an Interface Board for GPIO data Input.

※ A procedure is finished (“Device Type Set-up → Zigbee Network Configuration → target device set-up → data transmission Type→ data transmission is completed once → [ACK data Receipt](#)”), which means that the Zigbee Network configuration is completed.

11-4. START MESSAGE

(1) START MESSAGE

It means that FZ750BS/FZ750BC starts to operate.

START MESSAGE is output as Serial data through UART port.

If you don't want a Device to output the START MESSAGE, input AT command (AT+SETSTAMSG0).

(2) Sorts of START MESSAGE

COORD START OK

: A Device starts as Coordinator and the Zigbee Network is configured properly.

Thus, data transmission is possible.

COORD START ERROR

: A Device starts as Coordinator, and the Zigbee Network Configuration is failed.

In this situation, a normal Zigbee Network cannot be configured.

After initializing the Device to factory set value (AT&F) and set the Device to Coordinator again, Change the Channel used.

ROUTER START OK

: A Device starts as Router and the Zigbee Network is configured properly.

Thus, Zigbee Network Extension and data transmission is possible.

ROUTER START ERROR

: A Device starts as Router, and the Zigbee Network Configuration is failed.

See if there is Coordinator around.

See if there is Router participated in the Zigbee Network configured by Coordinator.

See if there is channel which is the same as the one Coordinator use.

END START OK

: A Device starts as End Device and the Zigbee Network is configured properly.
Thus, data transmission is possible.

END START ERROR

: A Device starts as Router, and the Zigbee Network Configuration is failed.
See if there is Coordinator around.
See if there is Router participated in the Zigbee Network configured by Coordinator.
See if there is Coordinator which has 8 child nodes.
See if there is Router which participates in the Zigbee Network and has 8 child nodes.

TARGET NON

: There is no IEEE ADDRESS of target device saved.
In this case, data transmission is not possible.
Set a target device to process data transmission.

TARGET OK

: Target Set-up is properly done by using an IEEE ADDRESS of target device.
Data transmission is possible.

TARGET ERROR

: Target Set-up using IEEE ADDRESS of target device is failed.
See if there is the target device in the Zigbee Network.
If there is the target device participated in the Zigbee network, check if the IEEE ADDRESS of the target device is correctly saved.

OK

: The message "OK" is output from FZ750BS/FZ750BC when a Device switches its mode from operation mode to AT command mode.
- Use a command +++ to make the Device switches its mode from operation mode to AT command mode.
The message "OK" is also output when a Device switches its mode from AT command mode to operation mode.
- Use a command "ATO" to make the Device switches its mode AT command mode to operation mode.

11-5. DEBUG MESSAGE

(1) DEBUG MESSAGE

It is output from FZ750BS/FZ750BC when the Device starts to operate.

The DEBUG MESSAGE is output as Serial data through UART port.

It shows the status related to data transmission.

If you want Device to output the Debug message, use AT Command (AT+SETDEBMSG1).

(2) Sorts of DEBUG MESSAGE

[SEND]

: FZ750BS/FZ750BC sent data to its target device.

Transmission for other data is not possible.

[ACK_OK:0001]

: FZ750BS/FZ750BC got ACK from its target device after transmitting data to the target device.

Transmission for other data is possible afterwards.

- If FZ750BS/FZ750BC transmits Count Data, the Count value is output.
- If FZ750BS/FZ750BC transmits ADC, KEY, or Serial Data, Count Value is meaningless.

[WAIT_ACK_T.O]

: FZ750BS/FZ750BC failed to get ACK after transmitting data to its target device.

Transmission for other data is possible afterwards.

[RE_SEND:1]

: FZ750BS/FZ750BC re-sent data to its target device.

If FZ750S/FZ750BC fails to get ACK after transmitting data successfully, the Device judges that the data transmission is failed. In this case, The Device retransmits the data as many times as it is set. The number of time is also output together.

Transmission for other data is not possible.

(Transmission for other data is possible after a Device receives ACK or data transmission is error ([WAIT_ACK_T.O])).

[NACK_OK:0001]

: Wireless data from FZ750BS/FZ750BC was output properly when ACK Option is set to “No ACK Receipt” (**AT+SETACK0**), but no information on data Receipt of target device.

Transmission for other data is possible afterwards.

- data transmission by Broadcast also has the same message when ACK Option is set to “No ACK Receipt” (**AT+SETACK0**).
- If FZ750BS/FZ750BC transmits Count Data, the Count value is output.
- If FZ750BS/FZ750BC transmits ADC, KEY, or Serial Data, Count Value is meaningless.

[NACK_ERR]

: Wireless data from FZ750BS/FZ750BC was not output when ACK Option is set to “No ACK Receipt” (**AT+SETACK0**).

Transmission for other data is possible afterwards.

[OVER_FLOW]

: Serial data inputted was longer than 53bit. (Caution: A maximum length of Serial data is 53bit.)
Initialize the Serial data inputted, and then data transmission can be continuously processed.

[VCC_ERR]

: The voltage inputted into FZ750BS/FZ750BC was below 2.5V.

(FZ750BS/FZ750BC doesn't operate properly if the voltage is input below 2.5V)

[BAT_LOW]

: The voltage inputted into FZ750BS/FZ750BC was 2.6V.

If you want to know whether the voltage inputted is okay, set Battery Option to be enabled by using a command **AT+SETBATTERY1**. The Device warns that the voltage inputted is not good by transmitting data ““BAT2600_0015510000000005” when the voltage of 750BS/FZ750B becomes 2.6V,

If you don't want to use the battery option, use a command **AT+SETBATTERY0**.

11-6. RESET OPTION

(1) RESET OPTION

FZ750BS/FZ750BC operates properly in the Zigbee Network.

Once the power of FZ750BS/FZ750BC is turned ON, the device automatically participates in the Zigbee Network. After the Zigbee Network Participation, the Device outputs “ROUTER START OK” or “END START OK”. Target device Se-up is possible afterwards.

FZ750BS/FZ750BC outputs “ROUTER START ERROR” or “END START ERROR” if there is no Zigbee Network around or the Device cannot participate in the Zigbee Network.

Target device set-up is prior to data transmission.

Turn the power of FZ750BS/FZ750BC ON, and then the Device is participated in the Zigbee Network. If FZ750BS/FZ750BC has its target device's Address, FZ750BS/FZ750BC searches if its target device is participated in the Zigbee Network.

If the target device of FZ750BS/FZ750BC is participated in the Zigbee Network and the target device is properly set, “TARGET OK” is output. Data transmission becomes possible from then.

If the target device of FZ750BS/FZ750BC is not participated in the Zigbee Network and the target device is failed, “TARGET ERROR” is output.

When RESET OPTION is set to be enabled with a command `AT+SETRESET1` , FZ750BS/FZ750BC fails to participate in the Zigbee Network and its target device is not properly set, FZ750BS/FZ750BC is reset.

When RESET OPTION is set to be disabled with a command `AT+SETRESET0` , FZ750BS/FZ750BC fails to participate in the Zigbee Network and its target device is not properly set, FZ750BS/FZ750BC is put on standby for a handle by users.

11-7. How to connect FZ750BS/FZ750BC to Magnetic Sensor & Set-up for operation

The case of using other senses should be the same as below.

(1) Choice for magnetic sensor

Choose the magnetic sensor which operates as below.

< It operates as Low(0V) after magnetic is connected >

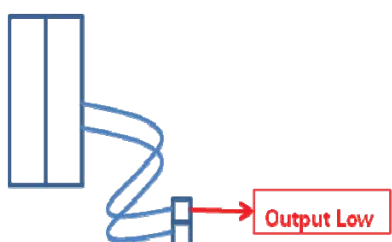

< It operates as High(3V) after magnetic is off >

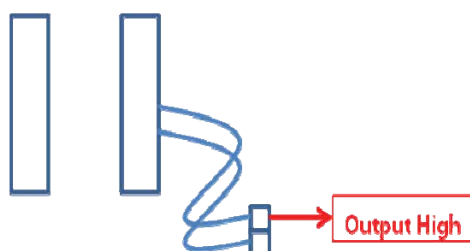

(2) Connection between FZ750BS/FZ750BC and magnetic sensor

The following is how to connect FZ750BS/FZ750BC to magnetic sensor.

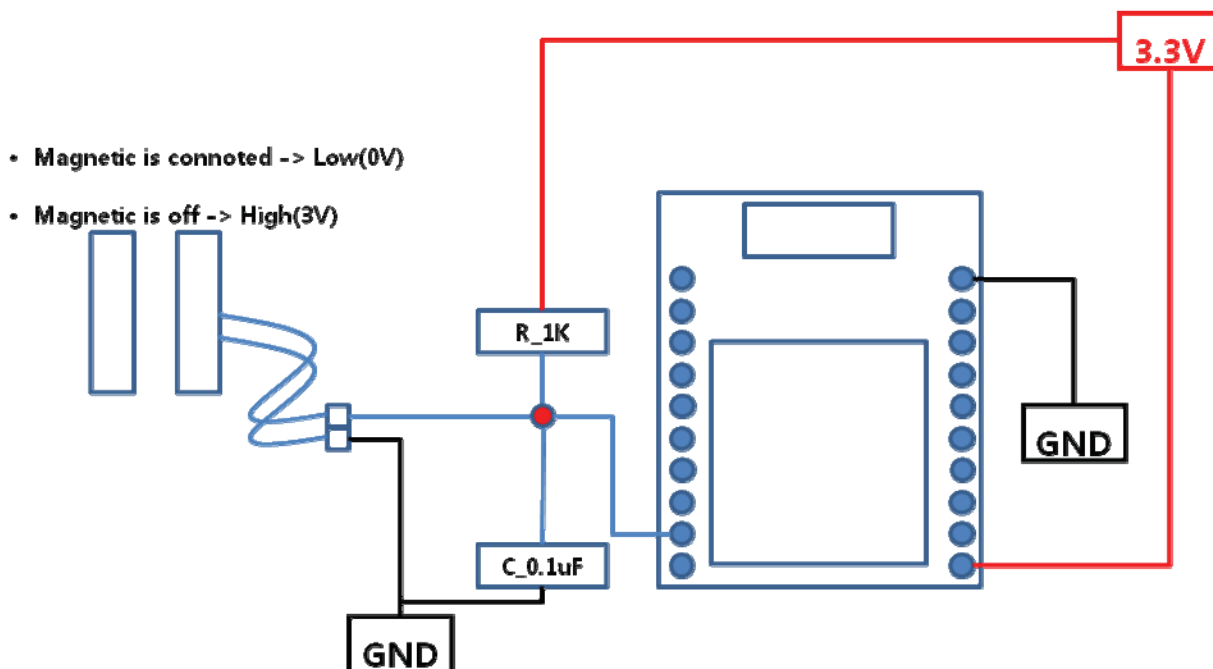

(3) FZ750BS/FZ750BC set-up and operation of Magnetic sensor

Set FZ750BS/FZ750BC to End Device to connect it to a sensor.

It operates differently depending on how set FZ750BS/FZ750BC.

- ① FZ750BS/FZ750BC is in a low power consumption mode 1. (check whether the door is open or closed)

The following figure shows how FZ750BS/FZ750BC cognize the value of sensor depending on how the sense operates.

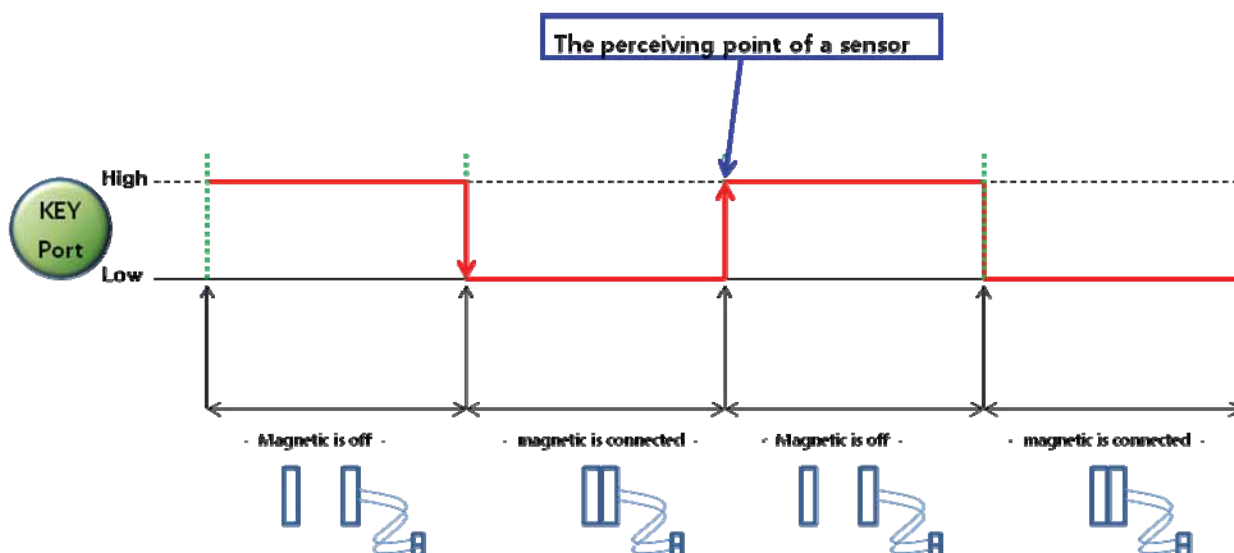

FZ750BS/FZ750BC in the low power consumption1 cognize the point when the value of sensor connected to KEY port is changed from Low to High. **The point means a moment when the magnetic sensor is unconnected.**

If the magnetic sensor is connected to a door, it senses when the door is open.

FZ750BS/FZ750BC transmits data to its target device once when wake-up occurs in the low power consumption mode 1.

If the magnetic sensor is connected to a door, it transmits data once as the door is closed.

- ② FZ750BS/FZ750BC is in a low power consumption mode 3. (Check one option of the door between Security and Emergency)

The following figure shows how FZ750BS/FZ750BC cognize the value of sensor depending on how the sense operates.

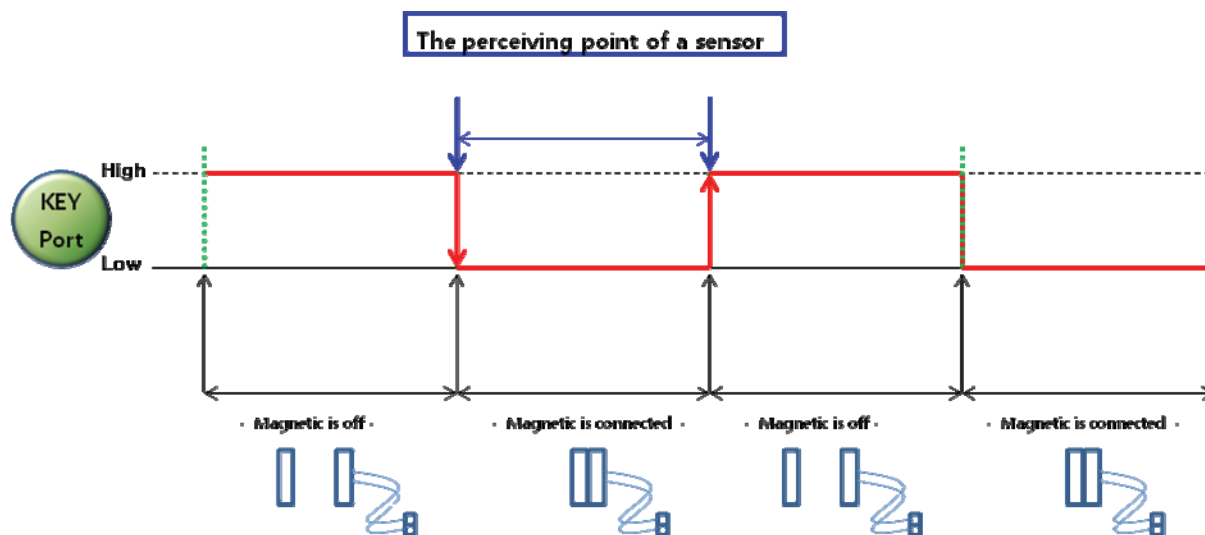

FZ750BS/FZ750BC in the low power consumption mode3 cognize the point when the value of sensor connected to KEY port becomes Low. The point means a moment when the magnetic sensor is connected.

If the magnetic sensor is connected to a door, it senses when the door is closed.

FZ750BS/FZ750BC transmits data successively when wake-up occurs in the low power consumption mode3.

If magnetic sensor is connected to a door, FZ750BS/FZ750BC transmits data successively.

If switch is connected rather than magnetic sensor is connected (in case of emergency), FZ750BS/FZ750BC transmits data successively.

※ If FZ750BS/FZ750BC is used for security through connecting it to the magnetic sensor, which continuously check the door open, the magnetic sensor operates in the opposite way to the explanation above. In other words, FZ750BS/FZ750BC uses a sensor which outputs Low when the magnetic is connected so the door can be open or closed. (Low power consumption mode 1), FZ750BS/FZ750BC uses a sensor which outputs Low when the magnetic is unconnected so the door for security is open (Low power consumption mode 3).

※ If you want to use other sensors which are not mentioned here, use them after setting FZ750BS/FZ750BC to appropriate status in accordance with the sensor you use.

12. AT-Command

12-1. Command Category

Command Category	Index	AT Command
Set Command	1	AT+SETEND[ENTER]
	2	AT+SETROUTER[ENTER]
	3	AT+SETCOORD[ENTER]
	4	AT+SETADC1[ENTER]
	5	AT+SETADC0[ENTER]
	6	AT+SETKEY1[ENTER]
	7	AT+SETKEY0[ENTER]
	8	AT+SETCOUNT1[ENTER]
	9	AT+SETCOUNT0[ENTER]
	10	AT+SETTMR60[ENTER]
	11	AT+SETTARGET1234567890123456[ENTER]
	12	AT+SETDEVNAME123456789012[ENTER]
	13	AT+SETBAUD9600[ENTER]
	14	AT+SETCHANNEL0B[ENTER]
	15	AT+SETRETRY3[ENTER]
	16	AT+SETACK1[ENTER]
	17	AT+SETACK0[ENTER]
	18	AT+SETPMODE1[ENTER]
	19	AT+SETSTAMSG1[ENTER]
	20	AT+SETSTAMSG0[ENTER]
	21	AT+SETDEBMSG1[ENTER]
	22	AT+SETDEBMSG0[ENTER]
	23	AT+SETTXPOWER00[ENTER]
	24	AT+SETLQI1[ENTER]
	25	AT+SETLQI0[ENTER]
	26	AT+SETRESET1[ENTER]
	27	AT+SETRESET0[ENTER]
	28	AT+SETLPQUICK1[ENTER]
	29	AT+SETLPQUICK0[ENTER]
	30	AT+SETBATTERY1[ENTER]
	31	AT+SETBATTERY0[ENTER]
	32	AT+SETGPIO0[ENTER]
	33	AT+SETGPIO1[ENTER]
	34	AT+SETGPIO2[ENTER]

Get Command	35	AT+GETPAN[ENTER]
	36	AT+GETVER[ENTER]
	37	AT+GETTMR[ENTER]
	38	AT+GETACK[ENTER]
	39	AT+GETKEY[ENTER]
	40	AT+GETADC[ENTER]
	41	AT+GETLQI[ENTER]
	42	AT+GETBAUD[ENTER]
	43	AT+GETLOCAL[ENTER]
	44	AT+GETCOUNT[ENTER]
	45	AT+GETRETRY[ENTER]
	46	AT+GETPMODE[ENTER]
	47	AT+GETTARGET[ENTER]
	48	AT+GETPARENT[ENTER]
	49	AT+GETSTAMSG[ENTER]
	50	AT+GETDEBMSG[ENTER]
	51	AT+GETCHANNEL[ENTER]
	52	AT+GETTXPOWER[ENTER]
	53	AT+GETDEVNAME[ENTER]
	54	AT+GETRESET[ENTER]
55	AT+GETLPQUICK[ENTER]	
56	AT+GETBATTERY[ENTER]	
57	AT+GETGPIO[ENTER]	

Request Command	58	AT+REQADDR[ENTER]
	59	AT+REQEXTADDR1234[ENTER]
	60	AT+REQNWKADDR1234567890123456[ENTER]

Special Command	61	+++
	62	AT[ENTER]
	63	ATO[ENTER]
	64	ATZ[ENTER]
	65	AT&F[ENTER]

12-2. Function of AT Command

12-2-1. AT+SETEND

Feature	FZ750BS/FZ750BC is set to End Device by a command AT+SETEND .
Response	OK[0X0D][0X0A]
Description	To apply the device type you set, you need to reset FZ750BS/FZ750BC after you set a type of the Device.
Ex.	Host -> FZ750BS/FZ750BC : AT+SETEND[ENTER] FZ750BS/FZ750BC -> Host : OK[0x0D][0x0A]

12-2-2. AT+SETROUTER

Feature	FZ750BS/FZ750BC is set to Router by a command AT+SETROUTER .
Response	OK[0X0D][0X0A]
Description	To apply the device type you set, you need to reset FZ750BS/FZ750BC after you set a type of the Device.
Ex.	Host -> FZ750BS/FZ750BC : AT+SETROUTER[ENTER] FZ750BS/FZ750BC -> Host : OK[0x0D][0x0A]

12-2-3. AT+SETCOORD

Feature	FZ750BS/FZ750BC is set to Coordinator by a command AT+SETCOORD .
Response	OK[0X0D][0X0A]
Description	To apply the device type you set, you need to reset FZ750BS/FZ750BC after you set a type of the Device.
Ex.	Host -> FZ750BS/FZ750BC : AT+SETCOORD[ENTER] FZ750BS/FZ750BC -> Host : OK[0x0D][0x0A]

12-2-4. AT+SETADC1

Feature	ADC data transmission is set to be enabled by a command AT+SETADC1 .
Response	OK[0X0D][0X0A]
Description	Analog data inputted through ADC port is read by FZ750BS/FZ750BC every certain time and changed to Digital Data. FZ750BS/FZ750BC transmits the Digital data to its target device. data from 0V to 1.5V can be input through ADC port. The target device outputs the received data through Serial.
Ex.	Host -> FZ750BS/FZ750BC : AT+SETADC1[ENTER] FZ750BS/FZ750BC -> Host : OK[0x0D][0x0A]

12-2-5. AT+SETADC0

Feature	ADC data transmission is set to be disabled by a command AT+SETADC0 .
Response	OK[0X0D][0X0A]
Description	-
Ex.	Host -> FZ750BS/FZ750BC : AT+SETADC0[ENTER] FZ750BS/FZ750BC -> Host : OK[0x0D][0x0A]

12-2-6. AT+SETKEY1

Feature	KEY data transmission is set to be enabled by a command AT+SETKEY1 .
Response	OK[0X0D][0X0A]
Description	<p>FZ750BS/FZ750BC senses signal inputted through KEY port and transmits the signal to its target device.</p> <p>If FZ750BS/FZ750BC is set to Coordinator or Router, KEY port senses LOW signal(0V) regardless of KEY option.</p> <p>FZ750BS/FZ750BC is set to End Device in a low power consumption mode1, KEY port senses the signal changed from LOW(0V) to High(3V).</p> <p>FZ750BS/FZ750BC is set to End Device in a low power consumption mode2 or 3, KEY port senses LOW signal (0V).</p>
Ex.	Host -> FZ750BS/FZ750BC : AT+SETKEY1[ENTER] FZ750BS/FZ750BC -> Host : OK[0x0D][0x0A]

12-2-7. AT+SETKEY0

Feature	KEY data transmission is set to be disabled by a command AT+SETKEY0 .
Response	OK[0X0D][0X0A]
Description	<p>FZ750BS/FZ750BC does not sense signal inputted through KEY port and also not transmit the signal to its target device.</p> <p>If FZ750BS/FZ750BC is set to End Device with disabled KEY Data, wake-up occurs in a low power consumption mode by signal inputted though KEY port, but does not transmit KEY data to its target device.</p> <p>Once End Device enters into a low power consumption mode, it cannot control other things at all.</p> <p>End Device can control other things after wake-up.</p>
Ex.	Host -> FZ750BS/FZ750BC : AT+SETKEY0[ENTER] FZ750BS/FZ750BC -> Host : OK[0x0D][0x0A]

12-2-8. AT+SETCOUNT1

Feature	COUNT data transmission is set to be enabled by a command AT+SETCOUNT1 .
Response	OK[0X0D][0X0A]
Description	FZ750BS/FZ750BC transmits increased Internal Hexa Count value to its target device by Internal time. To transmit COUNT Data, ADC data transmission should be set to be enabled. In other words, FZ750BS/FZ750BC transmits Internal hexa count instead of ADC Data. Increased internal count value is from 0 to 50000. (0x0000 ~ 0xC350)
Ex.	Host -> FZ750BS/FZ750BC : AT+SETCOUNT1[ENTER] FZ750BS/FZ750BC -> Host : OK[0x0D][0x0A]

12-2-9. AT+SETCOUNT0

Feature	COUNT data transmission is set to be disabled by a command AT+SETCOUNT0
Response	OK[0X0D][0X0A]
Description	-
Ex.	Host -> FZ750BS/FZ750BC : AT+SETCOUNT0[ENTER] FZ750BS/FZ750BC -> Host : OK[0x0D][0x0A]

12-2-10. AT+SETTMR60

Feature	Internal time of FZ750BS/FZ750BC is set by a command AT+SETTMR60
Response	OK[0X0D][0X0A]
Description	FZ750BS/FZ750BC transmits ADC/COUNT data by internal time or makes wake-up in a low power consumption mode. Coordinator or Router transmits ADC/COUNT data by internal time. (set 60sec: A Device transmits ADC/COUNT data to its target device every 60sec) End Device makes wake-up in a low power consumption mode by internal time. (set 60 sec: wake-up from a device in a low power consumption mode occurs every 60 seconds) Input seconds for setting an Internal time. (example. 5sec -> 5, 1min -> 60) Possible value for Input in case of Coordinator or Router is from 0 to 65000. (Maximum 18hours) Possible value for Input in case of End Device is from 0 to 255. (Maximum 4min 20sec) Internal time saved is applied after FZ750BS/FZ750BC is reset.
Ex.	Host -> FZ750BS/FZ750BC : AT+SETTMR60[ENTER] FZ750BS/FZ750BC -> Host : OK[0x0D][0x0A]

12-2-11. AT+SETTARGET1234567890123456

Feature	FZ750BS/FZ750BC saves an address of its target device by a command AT+SETTARGET1234567890123456
Response	OK[0X0D][0X0A]
Description	<p>IEEE ADDRESS of a target device is 16bit.</p> <p>When FZ750BS/FZ750BC is reset, the FZ750BS/FZ750BC searches if its target device exists in the Zigbee network by using the IEEE ADDRESS of the target device.</p> <p>If the target device exists in the Zigbee network, the target device is set to a target of FZ750BS/FZ750BC.</p> <p>It is applied after FZ750BS/FZ750BC is reset.</p>
Ex.	<p>Host -> FZ750BS/FZ750BC : AT+SETTARGET1234567890123456[ENTER]</p> <p>FZ750BS/FZ750BC -> Host : OK[0x0D][0x0A]</p>

12-2-12. AT+SETDEVNAME123456789012

Feature	A name of FZ750BS/FZ750BC is set by a command AT+SETDEVNAME123456789012 .
Response	OK[0X0D][0X0A]
Description	<p>A maximum of length for a name is 12 bit.</p> <p>If any Devices inquire IEEE ADDRESS in the zigbee network, FZ750BS/FZ750BC shows its IEEE ADDRESS and its name. (AT+REQADDR)</p>
Ex.	<p>Host -> FZ750BS/FZ750BC : AT+SETDEVNAME123456789012[ENTER]</p> <p>FZ750BS/FZ750BC -> Host : OK[0x0D][0x0A]</p>

12-2-13. AT+SETBAUD9600

Feature	UART Communication speed is set to by a command AT+SETBAUD9600 .
Response	OK[0X0D][0X0A]
Description	<p>Possible communication speed for setting are 9600, 19200, 38400, 57600, 115200, and 230400.</p> <p>To apply UART Communication speed set, you need to reset FZ750BS/FZ750BC.</p>
Ex.	<p>Host -> FZ750BS/FZ750BC : AT+SETBAUD9600[ENTER]</p> <p>FZ750BS/FZ750BC -> Host : OK[0x0D][0x0A]</p>

12-2-14. AT+SETCHANNEL0B

Feature	A wireless channel of FZ750BS/FZ750BC is set by a command AT+SETCHANNEL0B
Response	OK[0X0D][0X0A]
Description	Possible wireless channel are 0B, 0C, 0D, 0E, 0F, 10, 11, 12, 13, 14, 15, 16, 17, 18, and 19. To apply the wireless channel set, you need to reset FZ750BS/FZ750BC.
Ex.	Host -> FZ750BS/FZ750BC : AT+SETCHANNEL0B[ENTER] FZ750BS/FZ750BC -> Host : OK[0x0D][0x0A]

12-2-15. AT+SETRETRY3

Feature	Numbers of wireless re-transmission is set by a command AT+SETRETRY3
Response	OK[0X0D][0X0A]
Description	If FZ750BS/FZ750BC does not ACK after wireless data transmission, the FZ750BS/FZ750BC tries the transmission again. Possible numbers of re-transmission is from 0 to 9.
Ex.	Host -> FZ750BS/FZ750BC : AT+SETRETRY3[ENTER] FZ750BS/FZ750BC -> Host : OK[0x0D][0x0A]

12-2-16. AT+SETACK1

Feature	ACK after data transmission is set to be enabled by a command AT+SETACK1 .
Response	OK[0X0D][0X0A]
Description	After wireless data transmission, FZ750BS/FZ750BC cognizes that the Transmission is completed by getting ACK. ACK does not work if data is transmitted by broadcast even if the ACK is set to be enabled.
Ex.	Host -> FZ750BS/FZ750BC : AT+SETACK1[ENTER] FZ750BS/FZ750BC -> Host : OK[0x0D][0x0A]

12-2-17. AT+SETACK0

Feature	ACK after data transmission is set to be disabled by a command AT+SETACK0 .
Response	OK[0X0D][0X0A]
Description	After wireless data transmission, FZ750BS/FZ750BC cognizes that the Transmission is completed by getting ACK
Ex.	Host -> FZ750BS/FZ750BC : AT+SETACK0[ENTER] FZ750BS/FZ750BC -> Host : OK[0x0D][0x0A]

12-2-18. AT+SETPMODE1

Feature	A low power consumption mode is set by a command AT+SETPMODE1 .
Response	OK[0X0D][0X0A]
Description	<p>If FZ750BS/FZ750BC is set to End Device, It uses a low power consumption mode.</p> <p>PMODE1: the Devices uses about 25uA in the low power consumption mode.</p> <p>Wake-up terms of FZ750BS/FZ750BC: Internal time, KEY Input, Reset FZ750BS/FZ750BC is not reset. (except for the term of Reset)</p> <p>PMODE2: the Devices uses about 2uA in the low power consumption mode</p> <p>Wake-up terms of FZ750BS/FZ750BC: Internal time, KEY Input, Reset FZ750BS/FZ750BC is reset when wake-up occurs.</p> <p>PMODE3: the Devices uses about 2uA in the low power consumption mode</p> <p>Wake-up terms of FZ750BS/FZ750BC : KEY Input, Reset FZ750BS/FZ750BC is reset when wake-up occurs.</p>
Ex.	Host -> FZ750BS/FZ750BC : AT+SETPMODE1[ENTER] FZ750BS/FZ750BC -> Host : OK[0x0D][0x0A]

12-2-19. AT+SETSTAMSG1

Feature	Messages related Start are set to be enabled by a command AT+SETSTAMSG1 .
Response	OK[0X0D][0X0A]
Description	<p>When FZ750BS/FZ750BC is in an operation mode, the received data and Start message is output.</p> <p>Start messages of FZ750BS/FZ750BC: ROUTER START ERROR, ROUTER START OK, TARGET NON, TARGET ERROR, TARGET OK, OK(after ATO Input)</p>
Ex.	Host -> FZ750BS/FZ750BC : AT+SETSTAMSG1[ENTER] FZ750BS/FZ750BC -> Host : OK[0x0D][0x0A]

12-2-20. AT+SETSTAMSG0

Feature	Messages related Start is set to be disabled by a command AT+SETSTAMSG0 .
Response	OK[0X0D][0X0A]
Description	When FZ750BS/FZ750BC is in an operation mode, nothing is output, but the received Data. Start messages of FZ750BS/FZ750BC: ROUTER START ERROR, ROUTER START OK, TARGET NON, TARGET ERROR, TARGET OK, OK(after ATO Input)
Ex.	Host -> FZ750BS/FZ750BC : AT+SETSTAMSG0[ENTER] FZ750BS/FZ750BC -> Host : OK[0x0D][0x0A]

12-2-21. AT+SETDEBMSG1

Feature	Messages related to debug are set to be enabled by a command AT+SETDEBMSG1 .
Response	OK[0X0D][0X0A]
Description	When FZ750BS/FZ750BC is in an operation mode, It outputs the value related to data transmission through Serial. Debug messages of FZ750BS/FZ750BC: [SEND], [ACK_OK:0001], [WAIT_ACK_T.O], [RE_SEND:1], [VCC_ERR], [NACK_OK], [NACK_ERR], [OVER_FLOW], [BAT_LOW]
Ex.	Host -> FZ750BS/FZ750BC : AT+SETDEBMSG1[ENTER] FZ750BS/FZ750BC -> Host : OK[0x0D][0x0A]

12-2-22. AT+SETDEBMSG0

Feature	Messages related to debug is set to be enabled by a command AT+SETDEBMSG0 .
Response	OK[0X0D][0X0A]
Description	When FZ750BS/FZ750BC is in an operation mode, It does not output the value related to data transmission through Serial.
Ex.	Host -> FZ750BS/FZ750BC : AT+SETDEBMSG0[ENTER] FZ750BS/FZ750BC -> Host : OK[0x0D][0x0A]

12-2-23. AT+SETTXPOWER00

Feature	Wireless Output Value of FZ750BS/FZ750BC is set by a command AT+SETTXPOWER00 .
Response	OK[0X0D][0X0A]
Description	You can choose among 00, 01, 02, 03, 04, 05, 06, 07, 08, 09, 0A, 0B, 0C, 0D, 0E, 0F, 10, 11, and 12 for setting the Wireless Output Value. A maximum value is 00. A minimum value is 12.
Ex.	Host -> FZ750BS/FZ750BC : AT+SETTXPOWER00[ENTER] FZ750BS/FZ750BC -> Host : OK[0x0D][0x0A]

12-2-24. AT+SETLQI1

Feature	Receive Sensitivity Output of Received data is set to be enabled by a command AT+SETLQI1 .
Response	OK[0X0D][0X0A]
Description	FZ750BS/FZ750BC outputs the Receive Sensitivity of wireless data received. However, FZ750BS/FZ750BC does not output the wireless data received.
Ex.	Host -> FZ750BS/FZ750BC : AT+SETLQI1 [ENTER] FZ750BS/FZ750BC -> Host : OK[0x0D][0x0A]

12-2-25. AT+SETLQI0

Feature	Receive Sensitivity Output of Received data is set to be disabled by a command AT+SETLQI0 .
Response	OK[0X0D][0X0A]
Description	-
Ex.	Host -> FZ750BS/FZ750BC : AT+SETLQI0[ENTER] FZ750BS/FZ750BC -> Host : OK[0x0D][0x0A]

12-2-26. AT+SETRESET1

Feature	In case that FZ750BS/FZ750BC fails to participate in the Zigbee Network and its target device is not set properly, Device Re-set is set to be enabled by a command AT+SETRESET1 .
Response	OK[0X0D][0X0A]
Description	FZ750BS/FZ750BC set its target device after its power is turned ON. If the target device is not set, FZ750BS/FZ750BC is automatically reset.
Ex.	Host -> FZ750BS/FZ750BC : AT+SETRESET1[ENTER] FZ750BS/FZ750BC -> Host : OK[0x0D][0x0A]

12-2-27. AT+SETRESET0

Feature	In case that FZ750BS/FZ750BC fails to participate in the Zigbee Network and its target device is not set properly, Device Re-set is set to be disabled by a command AT+SETRESET0 .
Response	OK[0X0D][0X0A]
Description	FZ750BS/FZ750BC set its target device after its power is turned ON. If the target device is not set, FZ750BS/FZ750BC is put on standby for a handle of users.
Ex.	Host -> FZ750BS/FZ750BC : AT+SETRESET0[ENTER] FZ750BS/FZ750BC -> Host : OK[0x0D][0x0A]

12-2-28. AT+SETLPQUICK1

Feature	In case of end Device, the time when End Device enters into a low power consumption mode is set to be quick by a command AT+SETLPQUICK1 .
Response	OK[0X0D][0X0A]
Description	End Device originally makes wake-up or enters into a low power consumption mode 1sec after data transmission. However a Device enters into a low power consumption mode immediately without this extra 1sec.
Ex.	Host -> FZ750BS/FZ750BC : AT+SETLPQUICK1[ENTER] FZ750BS/FZ750BC -> Host : OK[0x0D][0x0A]

12-2-29. AT+SETLPQUICK0

Feature	In case of end Device, any certain time when End Device enters into a low power consumption mode to is not intentionally set by a command AT+SETLPQUICK0 .
Response	OK[0X0D][0X0A]
Description	-
Ex.	Host -> FZ750BS/FZ750BC : AT+SETLPQUICK0[ENTER] FZ750BS/FZ750BC -> Host : OK[0x0D][0x0A]

12-2-30. AT+SETBATTERY1

Feature	In case that the inputted voltage of FZ750BS/FZ750BC is 2.6V, the FZ750BS/FZ750BC informs its target the inputted voltage by a command AT+SETBATTERY 1 .
Response	OK[0X0D][0X0A]
Description	FZ750BS/FZ750BC transmits data "BAT2600_001551000000005" to its target device.
Ex.	Host -> FZ750BS/FZ750BC : AT+SETBATTERY1[ENTER] FZ750BS/FZ750BC -> Host : OK[0x0D][0x0A]

12-2-31. AT+SETBATTERY0

Feature	In case that the inputted voltage of FZ750BS/FZ750BC is 2.6V, the FZ750BS/FZ750BC does not inform its target the inputted voltage by a command AT+SETBATTERY0 .
Response	OK[0X0D][0X0A]
Description	-
Ex.	Host -> FZ750BS/FZ750BC : AT+SETBATTERY0[ENTER] FZ750BS/FZ750BC -> Host : OK[0x0D][0x0A]

12-2-32. AT+SETGPIO0

Feature	GPIO port is set to be disabled by a command AT+SETGPIO0
Response	OK[0X0D][0X0A]
Description	-
Ex.	Host -> FZ750BS/FZ750BC : AT+SETGPIO0[ENTER] FZ750BS/FZ750BC -> Host : OK[0x0D][0x0A]

12-2-33. AT+SETGPIO1

Feature	GPIO port is set to be for Input by a command AT+SETGPIO1 .
Response	OK[0X0D][0X0A]
Description	<p>When FZ750BS/FZ750BC transmits GPIO port value to its target device by inputting the value (Low/High) through the GPIO port, FZ750BS/FZ750BC should be set to be for Input.</p> <p>GPIO port consists of 8 bit. (GPIO 0 ~ GPIO 7)</p> <p>The initial set value of GPIO port is High(1). In other words, a Device reads GPIO port without data inputted, and transmits it to its target device. The target device outputs 00FF(11111111). The front numbers of it "00" are meaningless Data.</p> <p>If FZ750BS/FZ750BC transmits GPIO data to its target device, the target device outputs "GPT003F_001551000000000B".(3F = 00111111)</p>
Ex.	Host -> FZ750BS/FZ750BC : AT+SETGPIO1[ENTER] FZ750BS/FZ750BC -> Host : OK[0x0D][0x0A]

12-2-34. AT+SETGPIO2

Feature	GPIO port is set to be for Output by a command AT+SETGPIO2 .
Response	OK[0X0D][0X0A]
Description	To output received GPIO data as value(Low/High), GPIO port should be set to be for Output. GPIO port consists of 8 bit. (GPIO 0 ~ GPIO 7) The initial set value of GPIO is High (1). In other words, all GPIO of FZ750BS/FZ750BC is output as High even if none of received GPIO data exists. (FF = 11111111) If FZ750BS/FZ750BC receives "GPT003F_001551000000000B", the Device outputs 3F(00111111) through GPIO port.
Ex.	Host -> FZ750BS/FZ750BC : AT+SETGPIO2[ENTER] FZ750BS/FZ750BC -> Host : OK[0x0D][0x0A]

12-2-35. AT+GETPAN

Feature	PAN ID in the Zigbee Network is output through Serial by a command AT+GETPAN .
Response	078D[0X0D][0X0A]
Description	One PAN ID is shared in a Zigbee network.
Ex.	Host -> FZ750BS/FZ750BC : AT+GETPAN[ENTER] FZ750BS/FZ750BC -> Host : 078D[0x0D][0x0A]

12-2-36. AT+GETVER

Feature	The version of FZ750BS/FZ750BC is output through Serial by a command AT+GETVER .
Response	FZ750 V0.2.0[0X0D][0X0A]
Description	-
Ex.	Host -> FZ750BS/FZ750BC : AT+GETVER[ENTER] FZ750BS/FZ750BC -> Host : FZ750 V0.2.0[0x0D][0x0A]

12-2-37. AT+GETTMR

Feature	The Internal time Set value of FZ750BS/FZ750BC is output through Serial by a command AT+GETTMR .
Response	10[0X0D][0X0A]
Description	The value is output as seconds.
Ex.	Host -> FZ750BS/FZ750BC : AT+GETTMR[ENTER] FZ750BS/FZ750BC -> Host : 10[0x0D][0x0A]

12-2-38. AT+GETACK

Feature	ACK set value is output through Serial by a command AT+GETACK .
Response	1[0X0D][0X0A]
Description	1 is output, which means that the function is used. 0 is output, which means that the function is not used.
Ex.	Host -> FZ750BS/FZ750BC : AT+GETACK[ENTER] FZ750BS/FZ750BC -> Host : 1[0x0D][0x0A]

12-2-39. AT+GETKEY

Feature	KEY set value is output through Serial by a command AT+GETKEY .
Response	1[0X0D][0X0A]
Description	1 is output, which means that the function is used. 0 is output, which means that the function is not used.
Ex.	Host -> FZ750BS/FZ750BC : AT+GETKEY[ENTER] FZ750BS/FZ750BC -> Host : 1[0x0D][0x0A]

12-2-40. AT+GETADC

Feature	ADC set value is output through Serial by a command AT+GETADC .
Response	0[0X0D][0X0A]
Description	1 is output, which means that the function is used. 0 is output, which means that the function is not used.
Ex.	Host -> FZ750BS/FZ750BC : AT+GETADC[ENTER] FZ750BS/FZ750BC -> Host : 0[0x0D][0x0A]

12-2-41. AT+GETLQI

Feature	LQI set value is output through Serial by a command AT+GETLQI .
Response	0[0X0D][0X0A]
Description	1 is output, which means that the function is used. 0 is output, which means that the function is not used.
Ex.	Host -> FZ750BS/FZ750BC : AT+GETLQI[ENTER] FZ750BS/FZ750BC -> Host : 0[0x0D][0x0A]

12-2-42. AT+GETBAUD

Feature	UART Communication set value is output through Serial by a command AT+GETBAUD .
Response	115200[0X0D][0X0A]
Description	-
Ex.	Host -> FZ750BS/FZ750BC : AT+GETBAUD[ENTER] FZ750BS/FZ750BC -> Host : 115200[0x0D][0x0A]

12-2-43. AT+GETLOCAL

Feature	Device Type, IEEE ADDRESS, and Network Address of FZ750BS/FZ750BC is output through Serial by a command AT+GETLOCAL .
Response	ROUTER,0015510000000005,0001[0X0D][0X0A]
Description	ROUTER: It shows the Device type of FZ750BS/FZ750BC 0015510000000005: It shows an IEEE ADDRESS of FZ750BS/FZ750BC. 0001: It shows a Network address of FZ750BS/FZ750BC. The network address is shown only when the Device participates in the Zigbee Network. If the Device does not participate in the Zigbee Network, the network address is shown as FFFF.
Ex.	Host -> FZ750BS/FZ750BC : AT+GETLOCAL[ENTER] FZ750BS/FZ750BC -> Host : ROUTER,0015510000000005,0001[0x0D][0x0A]

12-2-44. AT+GETCOUNT

Feature	COUNT set value is output through Serial by a command AT+GETCOUNT .
Response	0[0X0D][0X0A]
Description	1 is output, which means that the function is used. 0 is output, which means that the function is not used.
Ex.	Host -> FZ750BS/FZ750BC : AT+GETCOUNT[ENTER] FZ750BS/FZ750BC -> Host : 0[0x0D][0x0A]

12-2-45. AT+GETRETRY

Feature	Re-transmission set value is output through Serial by a command AT+GETRETRY .
Response	3[0X0D][0X0A]
Description	-
Ex.	Host -> FZ750BS/FZ750BC : AT+GETRETRY[ENTER] FZ750BS/FZ750BC -> Host : 3[0x0D][0x0A]

12-2-46. AT+GETPMODE

Feature	Low power consumption mode Set value is output through Serial by a command AT+GETPMODE.
Response	1[0X0D][0X0A]
Description	1 is output, which means the device uses a low power consumption mode1. 2 is output, which means the device uses a low power consumption mode2. 3 is output, which means the device uses a low power consumption mode3.
Ex.	Host -> FZ750BS/FZ750BC : AT+GETPMODE[ENTER] FZ750BS/FZ750BC -> Host : 1[0x0D][0x0A]

12-2-47. AT+GETTARGET

Feature	IEEE ADDRESS of target device is output through Serial by a command AT+GETTARGET.
Response	001551000000000B,ENABLE[0X0D][0X0A]
Description	001551000000000B: It shows an IEEE ADDRESS of target device. ENABLE: It means that the target device is properly set. If DISABLE is output, the target device which has the address does not exist in the Zigbee Network or The target device is improperly set. Or it could be the case that only an IEEE ADDRESS of the target device is saved by a command "AT+SETTARGET".
Ex.	Host -> FZ750BS/FZ750BC : AT+GETTARGET[ENTER] FZ750BS/FZ750BC -> Host : 001551000000000B,ENABLE[0x0D][0x0A]

12-2-48. AT+GETPARENT

Feature	IEEE ADDRESS of parent node is output through Serial by a command AT+GETPARENT.
Response	001551000000000B[0X0D][0X0A]
Description	The depth of Zigbee Network can be expected by Parent nodes. The address which is used in the Zigbee Network is assigned from Parent nodes.
Ex.	Host -> FZ750BS/FZ750BC : AT+GETPARENT[ENTER] FZ750BS/FZ750BC -> Host : 001551000000000B[0x0D][0x0A]

12-2-49. AT+GETSTAMSG

Feature	Messages related Start set value is output through Serial by a command AT+GETSTAMSG .
Response	1[0X0D][0X0A]
Description	1 is output, which means that the function is used. 0 is output, which means that the function is not used.
Ex.	Host -> FZ750BS/FZ750BC : AT+GETSTAMSG[ENTER] FZ750BS/FZ750BC -> Host : 1[0x0D][0x0A]

12-2-50. AT+GETDEBMSG

Feature	Messages related Debug Set value is output through Serial by a command AT+GETDEBMSG .
Response	1[0X0D][0X0A]
Description	1 is output, which means that the function is used. 0 is output, which means that the function is not used.
Ex.	Host -> FZ750BS/FZ750BC : AT+GETDEBMSG[ENTER] FZ750BS/FZ750BC -> Host : 1[0x0D][0x0A]

12-2-51. AT+GETCHANNEL

Feature	RF Channel set value is output through Serial by a command AT+GETCHANNEL .
Response	0B[0X0D][0X0A]
Description	A channel is shared in a Zigbee Network. data transmission is possible between Devices which use the same channel in a zigbee Network.
Ex.	Host -> FZ750BS/FZ750BC : AT+GETCHANNEL[ENTER] FZ750BS/FZ750BC -> Host : 0B[0x0D][0x0A]

12-2-52. AT+GETTXPOWER

Feature	Wireless Output Intensity Set value is output through Serial by a command AT+GETTXPOWER .
Response	00[0X0D][0X0A]
Description	-
Ex.	Host -> FZ750BS/FZ750BC : AT+GETTXPOWER[ENTER] FZ750BS/FZ750BC -> Host : 00[0x0D][0x0A]

12-2-53. AT+GETDEVNAME

Feature	The name of Device is output through Serial.
Response	FZ750 V0.2.0[0X0D][0X0A]
Description	As a set value of the name, a version of FZ750BS/FZ750BC is set.
Ex.	Host -> FZ750BS/FZ750BC : AT+GETDEVNAME[ENTER] FZ750BS/FZ750BC -> Host : FZ750 V0.2.0[0x0D][0x0A]

12-2-54. AT+GETRESET

Feature	If FZ750BS/FZ750BC fails to participate in the Zigbee Network or its target device is not set, set value related to Re-set is output through Serial by a command AT+GETRESET .
Response	1[0X0D][0X0A]
Description	1 is output, which means that the function is used. 0 is output, which means that the function is not used.
Ex.	Host -> FZ750BS/FZ750BC : AT+GETRESET[ENTER] FZ750BS/FZ750BC -> Host : 1[0x0D][0x0A]

12-2-55. AT+GETLPQUICK

Feature	In case of End Device, set value related to extra 1second before the End Device enters into a low power consumption mode is output by a command AT+GETLPQUICK .
Response	1[0X0D][0X0A]
Description	1 is output, which means that the extra 1 second is not used. 0 is output, which means that the extra 1 second is used.
Ex.	Host -> FZ750BS/FZ750BC : AT+GETLPQUICK[ENTER] FZ750BS/FZ750BC -> Host : 1[0x0D][0x0A]

12-2-56. AT+GETBATTERY

Feature	In case that the Input voltage of FZ750BS/FZ750BC is 2.6V, set value related the Input voltage is output to its target device by a command AT+GETBATTERY .
Response	0[0X0D][0X0A]
Description	1 is output, which means that the function is used. 0 is output, which means that the function is not used.
Ex.	Host -> FZ750BS/FZ750BC : AT+GETBATTERY[ENTER] FZ750BS/FZ750BC -> Host : 0[0x0D][0x0A]

12-2-57. AT+GETGPIO

Feature	GPIO Use set value is output through Serial by a command AT+GETGPIO .
Response	1[0X0D][0X0A]
Description	1 is output, which means that GPIO port is used for Input. 2 is output, which means that GPIO port is used for Output. 0 is output, which means that GPIO port is not used.
Ex.	Host -> FZ750BS/FZ750BC : AT+GETGPIO[ENTER] FZ750BS/FZ750BC -> Host : 1[0x0D][0x0A]

12-2-58. AT+REQADDR

Feature	An IEEE ADDRESS of a device in an operation mode is output through Serial by a command AT+REQADDR .
Response	OK[0X0D][0X0A] 001551000000000B,FZ750BS/FZ750BC V0.1.0,C[0X0D][0X0A] 001551000000000A,FZ750BS/FZ750BC V0.1.0,R[0X0D][0X0A] 001551000000000C,FZ750BS/FZ750BC V0.1.0,R[0X0D][0X0A] OK[0X0D][0X0A]
Description	OK: the first "OK" means that the command is cognized properly. 001551000000000A: It shows an IEEE ADDRESS of a device in an operation mode. FZ750BS/FZ750BC V0.1.0: It shows a name of a device in an operation mode. R: It shows a type of Device in an operation mode. OK: The last "OK" means that Operation by the command is completed. (The operation is completed about 10 seconds after the command is inputted.) In case of End Device in a low power consumption mode, its address is not searched. Address can be searched through a lot of routes. If there is a lot of traffic in the Zigbee Network, Address cannot be output. Other Controls cannot be processed before OK, which Operation by the command is completed, is output.
Ex.	Host -> FZ750BS/FZ750BC : AT+REQADDR[ENTER] FZ750BS/FZ750BC -> Host : OK[0X0D][0X0A] 001551000000000B,FZ750BS/FZ750BC V0.1.0,C[0X0D][0X0A] 001551000000000A,FZ750BS/FZ750BC V0.1.0,R[0X0D][0X0A] 001551000000000C,FZ750BS/FZ750BC V0.1.0,R[0X0D][0X0A] OK[0X0D][0X0A]

12-2-59. AT+REQEXTADDR1234

Feature	An IEEE ADDRESS of FZ750BS/FZ750BC which has a network address “1234” is output through Serial by a command AT+REQEXTADDR1234 .
Response	OK[0X0D][0X0A] 001551000000000B[0X0D][0X0A] OK[0X0D][0X0A]
Description	OK: The first “OK” means that the command is properly cognized. 001551000000000B: It shows an IEEE address of FZ750BS/FZ750BC which has a network address “1234’. OK: The last “OK” means that operation by the command is completed. If the FZ750BS/FZ750BC does not exist in the Zigbee Network, It outputs ERROR after 15seconds.
Ex.	Host -> FZ750BS/FZ750BC : AT+REQEXTADDR0000[ENTER] FZ750BS/FZ750BC -> Host : OK[0X0D][0X0A] 001551000000000B[0X0D][0X0A] OK[0X0D][0X0A]

12-2-60. AT+REQNWKADDR1234567890123456

Feature	A Network address of FZ750BS/FZ750BC which has an IEEE ADDRESS “1234567890123456” is output through Serial by a command AT+REQNWKADDR1234567890123456
Response	OK[0X0D][0X0A] 0000[0X0D][0X0A] OK[0X0D][0X0A]
Description	OK: The first “OK” means that the command is properly cognized. 0000: It shows a Network address of FZ750BS/FZ750BC which has an IEEE ADDRESS “1234567890123456”. OK: The last “OK” means that operation by the command is completed. If the FZ750BS/FZ750BC does not exist in the Zigbee Network, It outputs ERROR after 15sec.
Ex.	Host -> FZ750BS/FZ750BC : AT+REQNWKADDR001551000000000B[ENTER] FZ750BS/FZ750BC -> Host : OK[0X0D][0X0A] 0000[0X0D][0X0A] OK[0X0D][0X0A]

12-2-61. +++

Feature	Mode of FZ750BS/FZ750BC switches from operation mode to AT command mode by a command +++ .
Response	OK[0x0D][0x0A]
Description	data is transmitted in operation mode. FZ750BS/FZ750BC is controlled in AT command mode. By inputting +++ OK is output in AT command mode..
Ex.	Host -> FZ750BS/FZ750BC : +++ FZ750BS/FZ750BC -> Host : OK[0X0D][0X0A]

12-2-62. AT

Feature	Whether host is properly connected to FZ750BS/FZ750BC is checked by a command AT .
Response	OK[0x0D][0x0A]
Description	You can check the status in AT Command. If the Device is in operation mode and its target is set, data inputted is transmitted to the target device.
Ex.	Host -> FZ750BS/FZ750BC : AT[ENTER] FZ750BS/FZ750BC -> Host : OK[0X0D][0X0A]

12-2-63. ATO

Feature	Mode of FZ750BS/FZ750BC is switched from AT command mode to operation mode by a command ATO .
Response	OK[0x0D][0x0A]
Description	-
Ex.	Host -> FZ750BS/FZ750BC : ATO[ENTER] FZ750BS/FZ750BC -> Host : OK[0X0D][0X0A]

12-2-64. ATZ

Feature	FZ750BS/FZ750BC is Soft reset by a command ATZ .
Response	OK[0X0D][0X0A]
Description	FZ750BS/FZ750BC is reset after OK, which means that the command is properly cognized, is output. It has the same result as when you approve the power of FZ750BS/FZ750BC again.
Ex.	Host -> FZ750BS/FZ750BC : ATZ[ENTER] FZ750BS/FZ750BC -> Host : OK[0X0D][0X0A]

12-2-65. AT&F

Feature	FZ750BS/FZ750BC is Hard reset by a command AT&F .
Response	OK[0X0D][0X0A]
Description	FZ750BS/FZ750BC is reset after OK, which means that the command is properly cognized, is output. Set value of FZ750BS/FZ750BC is changed to the initial factory set value.
Ex.	Host -> FZ750BS/FZ750BC : AT&F[ENTER] FZ750BS/FZ750BC -> Host : OK[0X0D][0X0A]

※ Noise Preventing Method for Zigbee Application Configurations

If power goes off forcefully during operation of FZ750BX/FZ760BX, data inside the flash memory can be erased due to unstable voltage.

This data erasing problem can be prevented by stabilizing input power for FZ750BX/FZ760BX and by using a Voltage Detector IC.

A Voltage Detector IC used here must have a Voltage Detect Level over 1.8V and a Reset Delay. (If a Voltage Detector IC with other Detect Level and Delay Time is used, it may cause severer data erasing in the flash memory. We highly recommend of using **RT9818B-18GV from Richtek.**)

For input power stabilization, a 33uF Capacitor (Tantal/Electrolytic/Neo Capacitor, excluding Ceramic type) and a 0.1uF Capacitor (Ceramic type) are used near the power port of FZ750BX/FZ760BX.

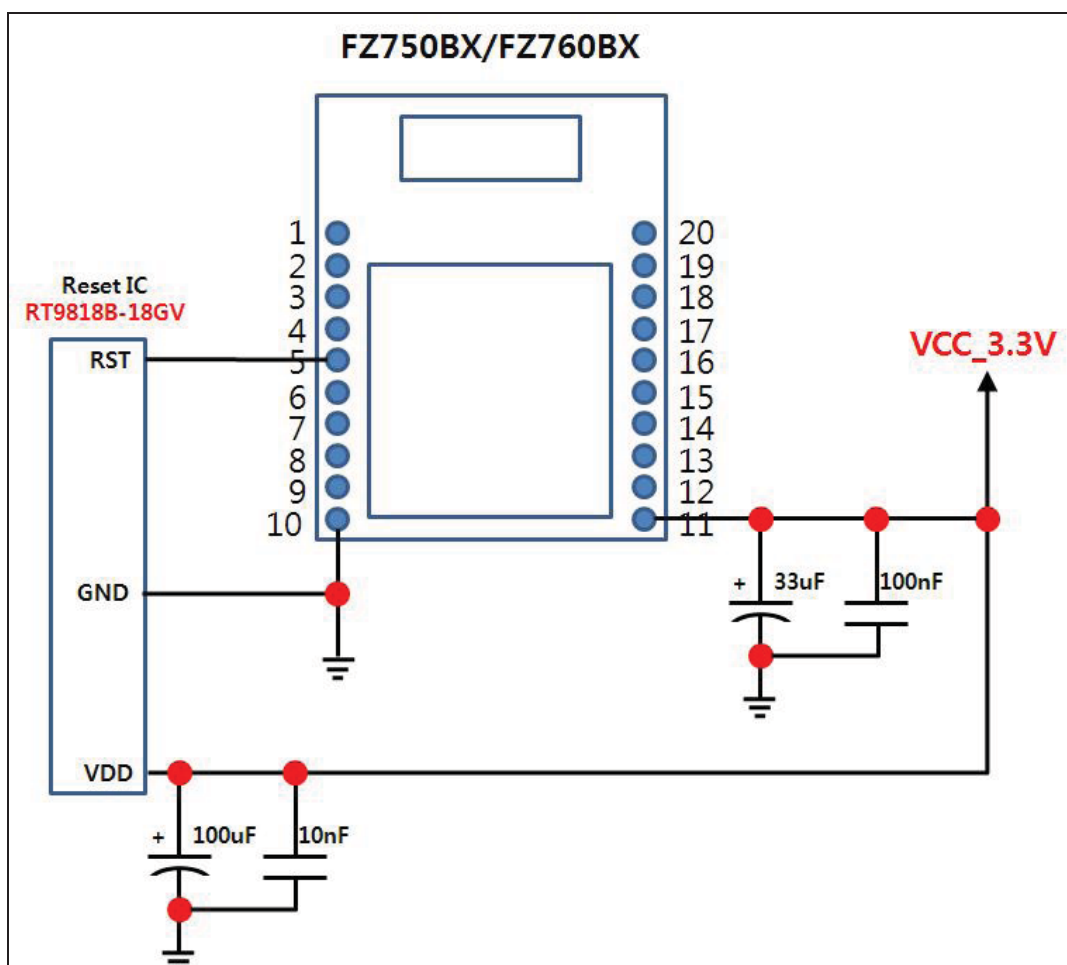

If a Voltage Detector IC cannot be used for any reason, connect 3.3V to the reset port of FZ750BX/FZ760BX.

(But, it is highly recommended to use a **Voltage Detector IC.**)

