

Copyright©2000

All Rights Reserved - Printed in Taiwan

Notebook Computer User Guide

Original Issue: 2000/9

This manual guides you in setting up and using your new notebook computer. Information in this manual has been carefully checked for accuracy and is subject to change without notice.

No part of this manual may be reproduced, stored in a retrieval system, or transmitted, in any form or by any means, electronic, mechanical, photocopy, recording, or otherwise, without prior written permission.

Trademarks

Product names used herein are for identification purposes only and may be the trademarks of their respective companies.

IBM, AT, PS/2, and Token Ring are registered trademarks and OS/2 is a trademark of International Business Machines Corporation.

Microsoft, MS-DOS, Windows, and Windows Sound System are trademarks of Microsoft Corporation.

Intel and Intel Pentium is a registered trademark of Intel Corporation.

Sound Blaster, Sound Blaster Pro are trademarks of Creative Technology.

All other brands or product names mentioned in this manual are trademarks or registered trademarks of their respective companies.

FCC Information to User

Safety and Care Instructions

No matter what your level of experience with computers, please make sure you read the safety and care instructions. This information can help protect you and your computer from possible harm.

Radio and television interference

Warning: Use the specified shielded power cord and shielded signal cables with this computer, so as not to interfere with radio and television reception. If you use other cables, it may cause interference with radio and television reception.

This equipment has been tested and found to comply with the limits for a Class B digital device, pursuant to Part 15 of the FCC Rules. These limits are designed to provide reasonable protection against harmful interference in a residential installation. This equipment generates, uses and can radiate radio frequency energy and, if not installed and used in accordance with the instructions, may cause harmful interference to radio communications.

However, there is no guarantee that interference will not occur in a particular installation. If this equipment does not cause harmful interference to radio or television reception, which can be determined by turning the equipment off and on, the user is encourage to try to correct the interference by one or more of the following measures:

- Reorient or relocate the receiving antenna
- Increase the separation between the device and receiver
- Connect the device into an outlet on a circuit different from that to which the receiver is connected.
- Consult the dealer or an experienced radio/television technician for help.

You may find helpful the following booklet, prepared by the Federal Communications Commission: Interference Handbook (stock number 004-000-00345-4). This booklet is available from the U.S. Government Printing Office, Washington, DC20402

Warning: The user must not modify or change this computer without approval. Modification could void authority to this equipment.

Canadian Department of Communications Compliance Statement

This Class B digital apparatus meets all requirement of the Canadian Interference-Causing Equipment Regulations..

Avis de conformite aux normes du ministère des Communications du Canada

Cet appareil numérique de la classe B respecte toutes les exigences du Règlement sur le matériel brouilleur du Canada.

Shielded Cables Notice

All connections to other computing devices must be made using shielded cables to maintain compliance with FCC regulations.

Peripheral Devices Notice

Only peripherals (input/output devices, terminals, printers, etc) certified to comply with Class B limits may be attached to this equipment. Operation with non-certified peripherals is likely to result in interference to radio and TV reception.

CD-ROM Notice

The CD-ROM is a Class One Laser Product.

Caution

Changes or modifications not expressly approved by the manufacturer may void the user's authority, which is granted by the Federal Communications Commission, to operate this computer.

Use Conditions

This part complies with Part 15 of the FCC Rules. Operation is subject to the following conditions: (1) this device may not cause harmful interference, and (2) this device must accept any interference received, including interference that may cause undesired operation.

About Your Notebook Computer



Congratulation for having purchased your new Professional Multimedia Notebook. This notebook incorporates the strongest features which integrate the latest technologies available in the notebook industry.

Your new notebook computer not only drives today multimedia applications but also be ready for tomorrow exciting new software.

This Professional Multimedia Notebook is a freedom, flexibility, and functionality notebook which users are demanding for a long time.

About Your User Guide

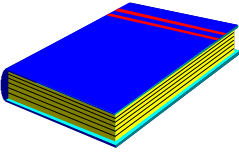

Welcome to your Professional Multimedia Notebook User Guide. This manual covers everything you need to know in learning how to use your computer. This manual also assumes that you know the basic concepts of Windows and the PC. You will start doing a lot of great and fun things with your computer.

This manual is divided into eight chapters.

- Chapter 1 gives introduction on your computer features.
- Chapter 2 provides step-by-step instructions to help you begin using your notebook as quickly as possible.
- Chapter 3 describes how to operate the standard features of your computer.
- Chapter 4 illustrates how to integrate video and sound chips into impressive presentation.
- Chapter 5 illustrates how to connect external device to your computer.
- Chapter 6 explains how to use the System BIOS Setup program.
- Chapter 7 explains how to use the external PortBar and internal module options of your computer.
- Chapter 8 offers instructions on how to care and maintain

your notebook.

Table of Contents

ABOUT YOUR NOTEBOOK COMPUTER	5
ABOUT YOUR USER GUIDE	6
1 INTRODUCTION.....	12
1.1 FEATURE HIGHLIGHT.....	13
1.2 UNPACKING THE COMPUTER	15
1.3 THE INSIDE OF THE NOTEBOOK	16
<i>Status Icons</i>	19
1.4 THE FRONT SIDE OF THE NOTEBOOK	21
1.5 THE REAR SIDE OF THE NOTEBOOK.....	23
1.6 THE LEFT SIDE OF THE NOTEBOOK.....	25
1.7 THE RIGHT SIDE OF THE NOTEBOOK.....	26
1.8 THE UNDERSIDE OF THE NOTEBOOK.....	28
1.9 NOTEBOOK ACCESSORIES	29
1.10 NOTEBOOK OPTIONS	30
2 GETTING STARTED.....	32
2.1 USING THE BATTERY PACK.....	33
<i>Extending Battery Life</i>	35
2.2 CONNECTING THE AC POWER SOURCE.....	36
2.3 STARTING YOUR COMPUTER.....	37
2.4 ADJUSTING THE DISPLAY CONTROLS	38
2.5 INSTALLING THE NOTEBOOK DEVICE DRIVERS	39
<i>Running the Phdisk Suspend Utility</i>	39
<i>Running the PHDISK /Create /Partition</i>	40
<i>Running the PHDISK /Create /File</i>	40
<i>Installing the VGA Device Driver</i>	41

	<i>Installing the Modem Device Driver</i>	43
	<i>Installing the LAN Driver</i>	45
	<i>Installing the Audio Device Driver</i>	47
	<i>Installing Easy Button Driver</i>	48
	<i>Installing ZV-port Driver</i>	49
2.6	TURNING OFF YOUR COMPUTER	50
3	USING YOUR NOTEBOOK	52
3.1	STARTING YOUR OPERATING SYSTEM	53
3.2	KNOWING THE STATUS OF YOUR COMPUTER	53
3.3	UNDERSTANDING THE KEYBOARD FUNCTIONS	54
	<i>Basic Keyboard Functions</i>	57
	<i>Cursor Control Keys</i>	58
	<i>Screen Control Keys</i>	59
	<i>Windows 95/98 Hot Keys</i>	60
	<i>Special Function Keys</i>	60
3.4	USING THE GLIDE PAD POINTING DEVICE	61
3.5	CONFIGURING YOUR SCREEN DISPLAY	63
	<i>Possible Display Configurations</i>	64
	<i>Changing the Display Properties under Windows 98</i>	65
3.6	KNOWING THE POWER SAVING FEATURES	65
3.7	USING THE FDD	67
3.8	WORKING WITH THE BUILT-IN HDD	68
3.9	HOW TO ACCESS THE CD-ROM/DVD-ROM DRIVE	69
3.10	USING PCMCIA CARDS	71
	<i>What is PCMCIA?</i>	71
	<i>What is CardBus?</i>	74
	<i>What is ZV Port?</i>	74
	<i>Setting up the PCMCIA Controller</i>	75
	<i>Inserting and Removing a PCMCIA Card</i>	75
	<i>Making PC Cards Work</i>	77

	<i>Hot Swapping PC Cards</i>	78
4	FUN WITH MULTIMEDIA	81
4.1	NOTEBOOK MULTIMEDIA FEATURES	82
4.2	AUDIO SOUND SYSTEM FEATURES	82
4.3	SETTING UP THE AUDIO DRIVER PROPERTIES	83
4.4	WINDOWS MULTIMEDIA PROGRAMS	83
4.5	RECORDING SOUNDS	84
	<i>Using the Built-in Microphone</i>	87
	<i>Using an External Microphone</i>	88
	<i>Using the Built-in CD-ROM/DVD-ROM Drive</i>	88
	<i>Using an External Audio Input Device</i>	89
4.6	PLAYING AUDIO AND SOUND	90
	<i>Using the Media Player</i>	90
4.7	PLAYING VIDEO AND MPEG FILES	92
4.8	USING PC CARDS WITH ZV PORT	92
4.9	USING DVD.....	92
5	CONNECTING TO PERIPHERALS	95
5.1	USING A SERIAL MOUSE	96
5.2	USING AN EXTERNAL KEYBOARD (PS/2)	97
5.3	USING THE USB PORT	98
5.4	CONNECTING A PARALLEL PRINTER	99
5.5	USING AN EXTERNAL MONITOR (VGA PORT)	100
5.6	USING THE SIR PORT (OPTIONAL)	101
5.7	USING THE TV PORT	103
5.8	USING THE EXTERNAL AUDIO SYSTEM	104
6	CUSTOMIZING YOUR NOTEBOOK	106
6.1	RUNNING THE BIOS SETUP PROGRAM.....	107
6.2	USING THE MAIN MENU SETUP	109
6.2.1	<i>Internal HDD Sub-Menu</i>	112

6.3	USING THE ADVANCED CMOS SETUP	113
6.3.1	<i>Peripheral Sub-Menu</i>	115
6.3.2	<i>Chip Multi-function Sub-Menu</i>	117
6.3.3	<i>Advance Chipset Control Sub-Menu</i>	117
6.4	SECURITY MENU SETUP	118
6.5	USING POWER SAVING SETUP	121
6.6	USING THE BOOT SETUP	125
6.7	HOW TO EXIT THE SETUP PROGRAM	126
6.8	HOW TO UPGRADE THE BIOS	127
7	USING OPTIONS	128
7.1	LAN MODULE OPTION	129
	<i>Connecting the Internal LAN Module</i>	129
7.2	MODEM MODULE OPTION	129
	<i>Connecting the Internal Modem</i>	130
7.3	PORTBAR OPTION.....	130
	<i>Features of the PortBar</i>	131
	<i>Connecting the PortBar to Your System</i>	132
7.4	SYSTEM UPGRADE	133
	<i>Memory Upgrade Procedure</i>	133
	<i>Installing Memory Module</i>	134
8	CARING FOR YOUR NOTEBOOK	138
8.1	IMPORTANT SAFETY INSTRUCTIONS.....	139
8.2	CLEANING YOUR COMPUTER.....	141
8.3	MAINTAINING THE LCD QUALITY.....	142
8.4	MAINTAINING YOUR HARD DISK.....	142
8.5	BATTERY CARE GUIDELINES	143
8.6	WHEN YOU TRAVEL	144
APPENDIX A	HARDWARE SYSTEM INFORMATION	146

A.1	SYSTEM SPECIFICATION.....	147
	<i>Processor Unit.....</i>	<i>147</i>
	<i>System Memory.....</i>	<i>147</i>
	<i>LCD Display.....</i>	<i>147</i>
	<i>VGA System.....</i>	<i>147</i>
	<i>Disk Drives.....</i>	<i>148</i>
	<i>Audio System.....</i>	<i>148</i>
	<i>PCMCIA.....</i>	<i>148</i>
	<i>Glide Pad.....</i>	<i>149</i>
	<i>Keyboard.....</i>	<i>149</i>
	<i>Flash BIOS.....</i>	<i>149</i>
	<i>I/O Ports.....</i>	<i>149</i>
	<i>Infrared Port (Optional).....</i>	<i>150</i>
	<i>AC/DC Power Supply Adapter.....</i>	<i>150</i>
	<i>Battery.....</i>	<i>150</i>
	<i>Weight and Dimension.....</i>	<i>150</i>
A.2	IRQ USAGE SUMMARY.....	150
A.3	DMA CHANNEL USAGE SUMMARY.....	151

1 Introduction

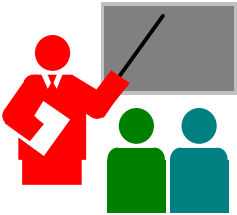

Your Notebook PC is a fully IBM compatible portable personal computer. With the latest features in mobile computing and multimedia technology, this notebook makes a natural traveling companion. Lightweight and compact, your Notebook PC runs on a whole wide range of general business, personal productivity, entertainment, and professional applications. It is ideal for use in the office, at home, and on the road.

With its all-in-one design, full functionality is built-in with no need to change external devices. Your Notebook PC makes an ideal choice for use in the office, the schoolroom, at home, on the road and all other occasions.

1.1 Feature Highlight

Before we go to identify each part of your Notebook PC, we will first introduce you to other notable features of your computer.

Processing Unit

- Your notebook runs on Intel Pentium III microprocessor, with integrated 256KB L2 Cache and Intel Celeron microprocessor, with integrated 128KB L2 Cache. Check with your dealer on the CPU type and speed.
- Fully compatible with an entire library of PC software based on operating systems such as MS-DOS, Windows 95/98, and Windows NT/2000. It also runs on future versions of Windows.

Memory

This notebook provides two memory slots for installing 144-pin SODIMM modules up to 256MB using 32MB, 64MB, and 128MB SDRAM modules.

PCMCIA

Provides two PCMCIA slots that allows you to insert either two Type II or one Type III cards.

AGP Local Bus Architecture

- AGP 2X video local bus and 2D/3D Graphic Engine with 4/8MB VRAM. Supports Zoomed Video (ZV) Port technology for smooth full-screen motion picture playback capabilities.

PCI Local Bus Architecture

- 32-bit PCI Enhanced IDE optimizes the data transfer between the CPU and hard disk drives. Support ultra DMA33/66 PIO Mode up to PIO Mode 4, bus mastering for LBA Scheme.
- 32-bit PCMCIA CardBus PCI technology that is also backward compatible with 16-bit PC cards.

Audio System

Full-duplex 16-bit stereo audio system with wavetable function and Plug-and-Play features. Sound Blaster and Sound Blaster Pro compatible.

Flash BIOS

Flash EPROM BIOS allows you to easily upgrade the System BIOS using the Phoenix Flash utility program.

Power and System Management

- Integrated SMM on system chipset that shuts down components not in use to reduce power consumption. Power Management user control on System BIOS SETUP allows you to activate and deactivate power saving features.
- Auto Suspend hot-key allows you to suspend the system operation instantly and resume at the press of the power button.
- System Password for User and Supervisor included on the BIOS SETUP Program to protect unauthorized use or your computer.

1.2 Unpacking the Computer

Your computer comes securely packaged in a sturdy cardboard shipping carton. Upon receiving your computer, open the carton and carefully remove the contents. In addition to this User Guide, the shipping carton should also contain the following items:

- The Notebook Computer
- An AC Adapter and AC Power Cord
- Li-Ion or NiMH Battery Pack(s)
- Utility Diskettes/CD
- Hardcopy/E-book User Guide
- Quick Setup Manual

Carefully inspect each component to make sure that nothing is missing and/or damaged. If any of these items are missing or damaged, notify your dealer immediately. Be sure to save the shipping materials and the carton in case you need to ship the computer or if you plan to store the computer away sometime in the future.

1.3 The Inside of the Notebook

The notebook computer is compact with features on every side. First, look at the inside of the system. The following sections describe inside features.

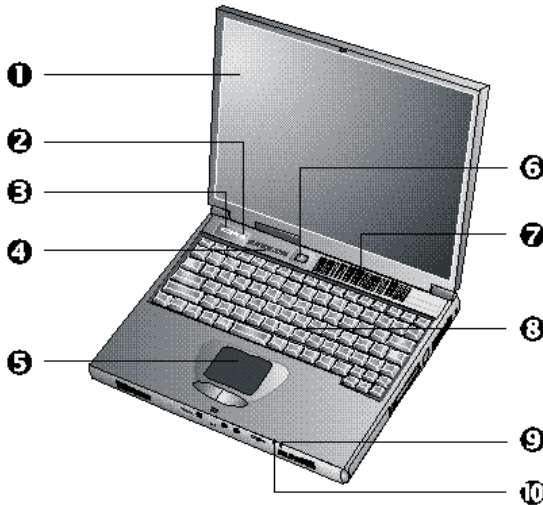

- | | |
|-----------------------------|-------------------------------|
| ❶. Color LCD Display | ❷. Internet Button |
| ❸. E-Mail Button | ❹. Status LED Indicator Panel |
| ❺. Touchpad Pointing Device | ❻. Power On/Resume Button |
| ❽. Cooling Fan Vent | ❼. Keyboard |
| ❾. Power Indicator | ❿. Battery Charging LED |
- Color LCD Display
The notebook computer comes with a color LCD that you can adjust for a comfortable viewing position. The LCD can be a 12.1" TFT (Thin Film Transistor)/DSTN (Dual Scan Super-Twisted Nematic) color LVDS with

800x600 SVGA (Super Video Graphics Array) resolution panels, or 13.3" or 14.1" TFT color LVDS with 1024x768 XGA (Extended Graphics Array) resolution panels. The features of the Color LCD Display are summarized as follows:

- DSTN/TFT color LVDS with 800x600 SVGA or 1024x768 XGA resolution panels.
 - Capable of displaying 64K colors (32-bit high color) on either SVGA or XGA LVDS panels.
 - LVDS display control hot-keys allows you to adjust the contrast of the LCD.
 - Simultaneous display capability for LCD and external desktop computer monitor.
 - LCD display can be upgraded from 12.1" TFT to 13.3" or 14.1" TFT.
- **Internet button**
This latest technology is designed specifically for providing a very convenient way in connecting Internet only by pressing Internet button as shown in the graphics. For more understanding and interesting, you can refer Section 2.5 to recognize the driver installation procedures in activating Internet button.
 - **E-mail button**
This is the most convenient way to access the outlook utility just by pressing this button, you can omit several procedures in entering into Outlook environment.
 - **Status LED Indicator Panel**
keep you informed of your notebook computer's current operating status. Descriptions of the status icons appear in the following section.

- **Touchpad Pointing Device**
Microsoft and IBM PS/2 mouse compatible with two select buttons. Supports tapping selection and dragging function. It works like a standard computer mouse. Simply move your fingertip over the Glide Pad to control the position of the cursor. Use the selection buttons below the Glide Pad to select menu items.
- **Power On/Resume Button**
Switches the computer power on and off, or resumes whenever it is in Suspend mode.
- **Cooling Fan Vent**
Emits the heat out of your computer and keeps it within operating temperature.

 ***Do not block the fan while the notebook is in use.***

- **Keyboard**
 - Standard QWERTY-key layout and full-sized 86/87 keys keyboard with Windows 98 hot-keys, embedded numeric keypad, 12 function keys, inverted “T” cursor arrow keys, and separate page screen control keys.
 - Wide extra space below the keyboard panel for your wrist or palm to sit-on comfortably during typing.
- **Power Indicator**
Lets you know that power to the system is turned on. This LED is positioned so that you can see the power state whether the LVDS panel is opened or closed.
 - ➔ Lights green when the system is powered on using the AC adapter or battery.
 - ➔ Lights amber when battery is warning in low battery power.

- Lights green blinking when in Suspend to RAM (or Suspend to Disk if you already created Save to Disk partition in HDD by using PHDISK utility in the MS-DOS) mode and critically low battery power. We strongly recommend that users create Save to Disk partition as this will prevent your data from loss when power is critically low.
- Battery Charging LED
 - Lights to indicate battery charging status.
 - Lights amber to indicate the battery is charging.
 - Lights off to indicate the battery is fully charged or no battery installed.

STATUS ICONS

The notebook computer uses status lights marked with icons to communicate system status. See the following figure and list for each icon's meaning.

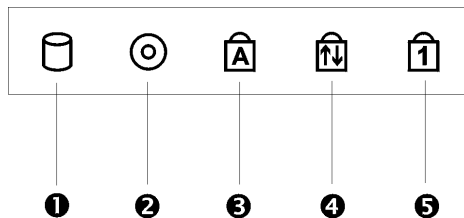

- ❶. Drive Access
- ❷. Diskette Drive Access
- ❸. Caps Lock
- ❹. Scroll Lock
- ❺. Num Lock

Status LED Icons

- **Drive Access**
When LED in green light indicates that the system is accessing either the CD-ROM or DVD-ROM.
- **Diskette Drive Access**
When LED in green light indicates that the system is accessing data from or is retrieving data to the floppy diskette drive.
- **Caps Lock**
When LED in green light indicates that the Caps Lock key on the keyboard is activated. When activated, all alphabet keys typed in will be in upper-case or capital letters.
- **Scroll Lock**
When LED in green light indicates that the Scroll Lock key on the keyboard is activated. The Scroll Lock key has different functions depending on the software you are using.
- **Num Lock**
When LED in green light indicates that the Num Lock key on the keyboard is activated. When activated, the embedded numeric keypad will be enabled.

1.4 The Front Side of the Notebook

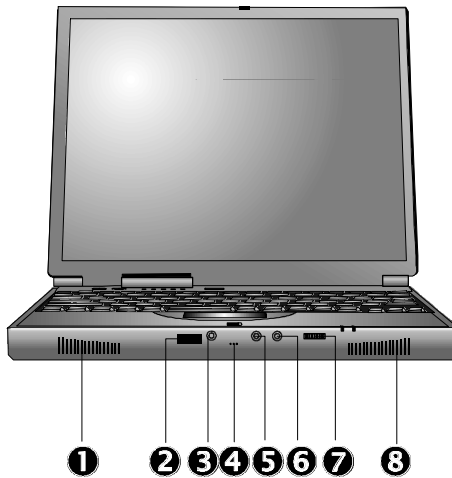

- ❶. Built-in Stereo Speakers ❷. Optional IR Port ❸. Microphone Jack
- ❹. Integrated Microphone ❺. Stereo Line-In Jack ❻. Headphone Jack
- ❼. Volume Control ❽. Built-in Stereo Speakers

- Built-in Stereo Speakers
Integrated left and right mini stereo speakers for sound and audio output for your multimedia presentations or listening pleasure.
- Optional IR Port
Wireless data transfer of files between your notebook computer and an IR-equipped device or notebook computer. You can also print to an IR-

equipped printer without using cables. The SIR mode provides up to 115.2Kbps of data transfer rate. This optional port is available for some models only.

- **Audio Ports**

From left to right, the jacks are Microphone, Line In & Headphones described as follows:

- ➔ **Microphone Jack**

Allows you to connect an external microphone for monophonic recording or amplification through the unit. Plugging in an external microphone disables the built-in microphone. Lets you connect an external microphone to record monophonic sound directly into your notebook computer.

- ➔ **Integrated Microphone**

Integrated mono microphone for instant voice recording and simultaneous voice conversation.

- ➔ **Stereo Line-In Jack**

Lets you connect an external audio device such as CD player, a tape deck, or a synthesizer as an input source. Use a cable to connect to the Line-Out port on the other audio system to record or play.

- ➔ **Headphone Jack**

Lets you plug in a stereo headphone, powered speakers, or earphone set with 1/8 inch phono plug for personal listening.

- **Thumb Wheel Volume Control**

Allows you to control the speaker volume.

1.5 The Rear Side of the Notebook

You'll find system ports for connecting optional devices (like a printer or external monitor) to the back of your notebook computer. The ports are described after the figure.

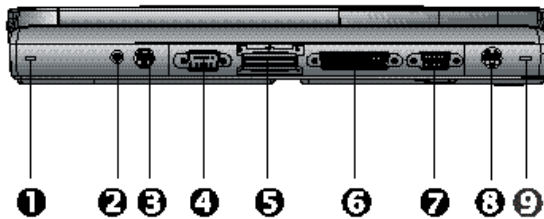

- 1 9.** PortBar Notches **2.** AC Power Port **3.** PS/2 Port
4. Serial Port **5.** Optional Expansion Port **6.** Parallel Port
7. Monitor (Video) Port **8.** Optional TV Port

- **PortBar Notches**
Use these notches to secure the PortBar to the back of the system. There are two PortBar notches located at the both ends of the rear side of the system.
- **AC Power Port**
Lets you connect the AC power adapter in supplying continuous power to your notebook and recharging the battery.
- **PS/2 Port**
Lets you connect an external PS/2-style mouse, PS/2-style keyboard, or PS/2-style numeric keypad to the system. With an optional Y-cable

adapter, you also can connect any combination on two of these devices simultaneously.

- **Serial Port**
Lets you connect a 9-pin external pointing device such as a high-speed modem, mouse, or other serial devices.
- **Optional 80-Pin Expansion Port**
Lets you connect to the notebook PortBar. This optional port is available for some models only.
- **Parallel Port**
Use this port to connect a parallel printer or other parallel device. The parallel port supports Enhanced Capabilities Port (ECP) standard. The standard provides you with a greater processing speed than the conventional parallel port. The port also supports bi-directional and uni-directional protocols.

 ***The default setting for the parallel port on your notebook computer is set to Enhanced Capabilities Port (ECP). Some older parallel devices may not function with the ECP default setting. You may need to adjust the setting to accommodate your parallel device by changing the BIOS setting.***

- **Monitor (Video) Port**
Lets you attach an external CRT monitor for wider display. You can run the LCD display and the external CRT monitor simultaneously or switch it to CRT only using the display hot-key.
- **TV Port**
Lets you connect to a S-Video TV connector for presentation or VCD, DVD watching. This optional port is available for some models only.

1.6 The Left Side of the Notebook

The left side of your notebook computer provides the features shown in the following figure.

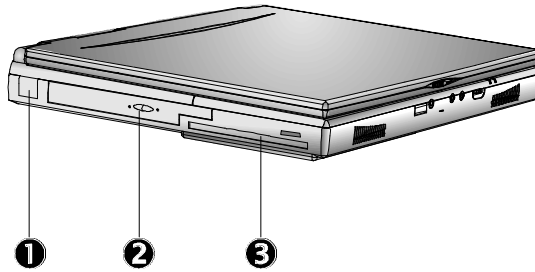

❶. USB

❷. CD-ROM/DVD-ROM

❸. Diskette Drive

Left Side Features

- **USB Port**
The Universal Serial Bus (USB) port allows you to connect up to 127 USB-equipped peripheral devices (for example, printers, monitors, scanners and so on) to your notebook computer.
- **CD-ROM/DVD-ROM**
Allows you to load and start programs from a compact disc (CD) or a digital video disc (DVD) and play conventional audio CDs.
- **Diskette Drive**
A 3.5-inch floppy diskette drive comes installed in the notebook computer. The drive accepts 1.44 MB/1.2MB floppy diskettes.

1.7 The Right Side of the Notebook

The right side of the notebook computer offers the features shown in the following figure.

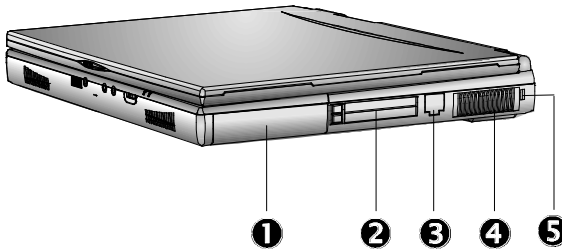

- ❶. Battery Bay
- ❷. PC Card Slots
- ❸. Modem / LAN Port
- ❹. Cooling Fan Vent
- ❺. Kensington Lock

Right Side Features

- **Battery Bay**
Stores the Nickel Metal-Hydride (NiMH) or Lithium-Ion (Li-Ion) battery pack for off-the-cord operation or battery recharging.
- **PCMCIA Slot**
 - Lets you connect various PC cards such as Modem cards, Ethernet LAN cards, and SCSI cards.
 - Double-deck PCMCIA slots that support two Type II PC cards at the same time, or one Type III PC card in the bottom slot.
 - Supports both 5V and 3V 32-bit CardBus and 16-bit PC cards including PC cards with ZV function. The Zoom Video (ZV) port is supported in the top slot only.

- Modem/LAN Port

If you purchase an internal fax modem, a 56K internal fax/data modem is installed. It keeps you connected to the outside world through networks. If you purchase an internal 10Base-T/100Base-TX LAN module, it connects your computer to other computers/networks through a local area network (LAN).

Build-in Modem and LAN modules are available as option. You can install only one module in the notebook PC and cannot use them simultaneously. If you need to use them simultaneously, you need to use other PC card in PCMCIA socket instead.

- Cooling Fan Vent

Emits the heat out of your computer and keeps it within operating temperature.



Do not block the fan while the notebook is in use.

- Locking Device Keyhole

Lets you attach a Kensington security system or a compatible lock to secure your notebook computer.

1.8 The Underside of the Notebook

The bottom of the notebook computer offers the following features.

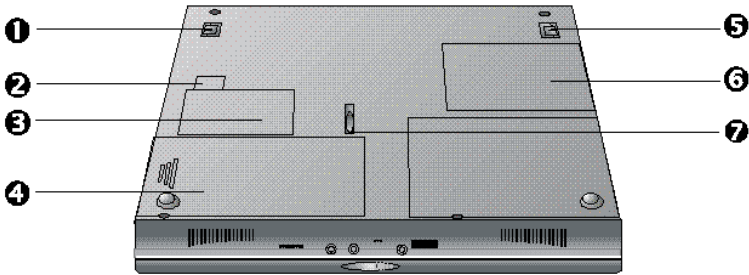

- | | |
|----------------------------------|-----------------------------|
| ❶. Tilt Foot | ❷. Modem or LAN Compartment |
| ❸. Modem or LAN Card Compartment | ❹. Battery Bay |
| ❺. Tilt Foot | ❻. Memory Compartment |
| ❼. Battery Release Latch | |

Bottom of the System

- Tilt Foot
Provides flexible keyboard angle.
- Modem or LAN compartment
Provides Modem or LAN module inserted into the space.
- Modem or LAN Card Compartment
Provides optional Modem card or LAN card inserted into this compartment for executing relative functions.

- **Battery Bay**
Equipped with a rechargeable Nickel-Metal-Hydride (NiMH) or Lithium-Ion (Li-Ion) battery.
- **Memory Compartment**
Remove the screw to find two DIMM slots. One is inserted with SDRAM memory board configured by the factory. The other is empty for upgrade use.
- **Battery Release Latch**
Slide the latch to the other end and hold it. While holding the latch, slide the battery bay outwards to remove the battery.

1.9 Notebook Accessories

AC Adapter

The AC Adapter supplies external power to your notebook computer and charges the internal battery pack simultaneously. The AC adapter has an auto-switching design that can connect to any 100VAC ~ 240VAC power outlets. You just change the power cord if you are going to use your notebook in other countries with different connector outlets.

When you connect the AC adapter, it charges the battery whether or not the notebook computer is powered on.

Battery Pack

Aside from the AC adapter, your computer can also be powered through the internal battery pack. The battery pack uses rechargeable Nickel-Metal Hydride (NiMH) or Lithium-Ion (Li-Ion) battery cells that provide long computing hours when fully charged and power management enabled. You

should always leave the battery inside your computer even when using the AC adapter as it also acts as a back-up power supply in case power from the AC adapter is cut off. It is also very important to have the battery pack always charged to prevent battery cell degradation.

1.10 Notebook Options

DVD-ROM Device Pack

This device pack option plugs into the Device Bay and used for reading DVD or playing DVD titles. DVD-ROM drives are also backward compatible with CD-ROM, so you can also use any audio CDs, video CDs, photo CDs, and recorded CD (CD-R).

Internal Ethernet LAN module

This notebook comes with an optional 10Base-T/100Base-TX LAN module that supports data transfer rates at 10Mbps and can be up to 100Mbps.

Internal Modem Module

This notebook comes equipped with a 56K capable internal fax/ data modem that allows you to communicate with others via fax, email, or connect to an online service or bulletin board.

2 Getting Started

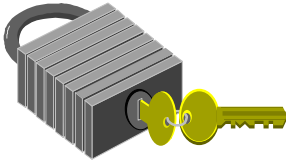

Your Notebook is designed and pre-configured for easy setup and use. This chapter describes the installation steps you should follow to get the notebook up and running as quickly as possible. Contact your dealer if they have pre-installed all the needed drivers to fully operate your computer or if there is an update on the driver installation of the notebook.

2.1 Using the Battery Pack

The notebook is designed to operate with one of the following power sources:

- With AC power using the AC adapter connected to an electrical outlet.
- With a Nichel Metal-Hydrde (NiMH) or Lithium-Ion (Li-Ion) battery pack.

You should use the AC adapter whenever possible, relying on the battery pack only when AC power is unavailable.

Before you use your notebook computer, install and recharge the battery pack first. The rechargeable Ni-MH or Li-Ion battery pack allows you to operate the notebook without an external power source. When you connect the AC power adapter, the battery immediately starts to recharge. Normal battery charging time is 2.5 ~ 3.5 hours for Lithium-Ion (Li-Ion) battery pack when your computer is turned off.

For maximum battery performance, fully discharge the battery first before recharging it. To do so, unplug the AC adapter, turn off power management features (through Setup and Windows), and turn on the system. Once the battery is fully discharged, plug in the AC adapter and recharge the battery.

If you do not discharge the battery completely, it fails to accept a full recharge.

 ***For Li-Ion battery, it is not necessary to discharge the battery before recharge it. Li-Ion battery is vulnerable than Ni-MH battery, do not charge it with other power adapter, or it may cause fire or explosion.***

Installing the Battery Pack

This notebook provides the most convenient way to install the battery pack into your computer. With the extended nose directed toward the compartment, insert the battery pack.

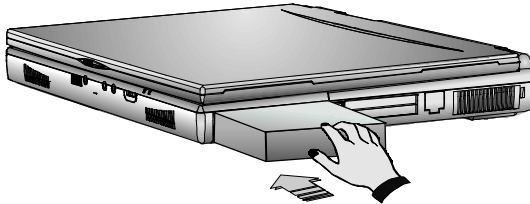

Removing the Battery Pack

To remove the battery pack, slide the latch and push out the battery pack simultaneously.

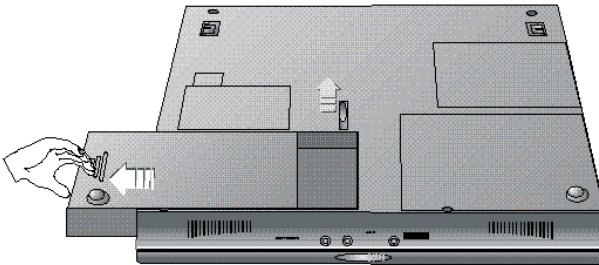

Replacing the Battery Pack

When your notebook estimates that the battery only has enough charge to continue for a few minutes, it will alert you to a low battery condition by blinking the battery icon on the LED status panel and a battery low warning beep. If you are consuming a lot of power by using the audio system, the

PCMCIA slots, the hard, floppy disk drives, and CD-ROM drive (or DVD ROM drive), your notebook might run out of charge much sooner than you expect. You should always respond to the battery low indication by connecting to AC power or turning off your notebook, or suspending your notebook to disk. If you do not do so, the notebook will automatically suspend to disk and turn off. The contents of the memory will store in the Suspend-to-Disk partition. You will be unable to restart the notebook until you have connected to the AC adapter or installed a charged battery. To replace the battery pack, refer to the previous sections on “Installing the Battery Pack” and “Removing the Battery Pack.”

 ***If you do not have a “Suspend-to-Disk” partition or file prepared beforehand and the battery is running low, the system will not be able to enter suspend to disk mode, but would rather enter suspend to RAM mode. The contents will be saved to the memory instead and you need to connect the AC adapter.***

 ***Be sure to save your data before replacing the battery pack or connecting the AC adapter. Failure to do so can result in data loss.***

EXTENDING BATTERY LIFE

It is important to be aware of the simple things for extending the life of the system main battery while you are on the road. You should find a working place where the external lighting is not too bright and turn down the screen brightness and contrast. Also, please refer to Chapter 6 “Customizing Your Computer” for details about power management features and the modes available.

2.2 Connecting the AC Power Source

The AC adapter provides external power source to your computer and charges the internal battery pack at the same time. The AC adapter also has an auto-switching design that can connect to any 100VAC ~ 240VAC power outlets.

To connect the power adapter:

1. Plug the AC power cord into the power socket of the AC power adapter.
2. Plug the other end of the AC power cord to a live AC wall outlet.

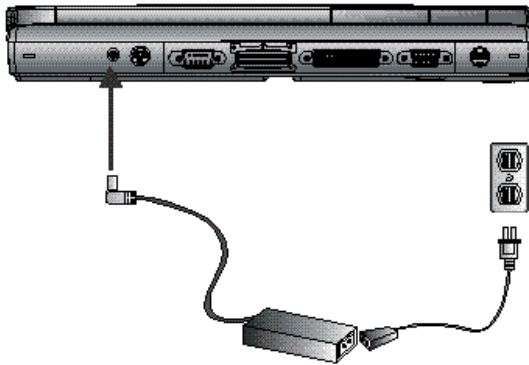

3. Plug the connector of the AC adapter to the DC-IN port found at the back of the computer.

Whenever possible, it is advisable to always have the AC adapter connected to the notebook and the battery pack installed. This ensures continuous power supply and prevents any data loss incurring from sudden power breakdown.

- **For the power supply of this equipment, an approved power cord has to be used. For a rated current up to 6A and an equipment weight more than 3kg, a power cord not lighter than H05VV-F, 2G, 0.75mm², has to be used.**
- **Make sure the socket and any extension cord(s) you use can support the total current load of all the connected devices.**
- **Before cleaning the computer, make sure it is disconnected from any external power supplies (i.e. AC adapter or car adapter).**

2.3 Starting Your Computer

The Power/Resume button is found on the top of the base unit. Press the Power/Resume button to start your computer and check that if the Power LED turns on.

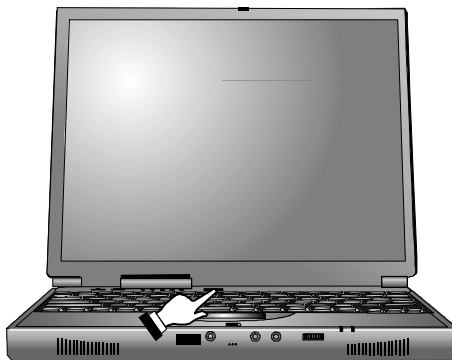

After a few seconds, the computer's display will turn on and your computer will begin to execute the Power On Self Test or POST to check if all system

components are running properly. Any errors found during the test will be displayed on the screen and may generate short beep sound as well.

After the test, the screen will also display a message “**press <F2> to enter SETUP**”. You don’t need to run this program at the moment as your dealer already made the necessary settings for your computer optimal operation. Refer to Chapter 6 on running the SETUP program later.

After the test has completed, your computer will start to search and boot up the operating system from your hard drive. The notebook computer normally comes with a Windows 98/2000 operating system pre-installed in your hard drive. Consult the Windows 98/2000 manual on how to use the program. If not, contact your dealer for assistance.

2.4 Adjusting the Display Controls

The LCD brightness adjustment is controlled by <Fn> +<F8> and <Fn> + <F9> keys respectively. You need to press these hot-key controls after powering on your notebook to suit your viewing pleasure. Press the <Fn> key using your left finger and while still holding the key, press the arrow cursor keys using your right finger.

 ***For TFT color screens, only the Brightness hot-key controls are functional.***

The Brightness hot-key control adjusts the brightness on the LCD. The brightness hot-key control will not set the LCD completely dark or bright; it provides sufficient lighting to the LCD to match the external lighting of the surrounding. The brighter the room, the more you need to increase the brightness of the LCD.

2.5 Installing the Notebook Device Drivers

If you already have an operating system like DOS or Windows installed into your notebook computer, it is best to install the needed device drivers for using the built-in devices of your computer. Before installing the drivers, check with your dealer first if they have already installed all the drivers along with the operating system. If not, follow the procedures below:

RUNNING THE PHDISK SUSPEND UTILITY

The PHDISK utility of the notebook allows you to create a suspend-to-disk (STD) partition or file that is used to save the opened files when you activate STD mode and power off the computer. If you want to make use of the STD feature, you need first to run the PHDISK utility. There are two options for executing this utility:

1. **PHDISK /Create /Partition** - you can choose to run Suspend-to-Disk and save your work into an allocated fixed disk partition. This option should be done before partitioning and formatting your hard disk. The advantage of this option is that it is more secure since the files are saved in a separate partition and has no risk of being deleted. The disadvantage of this is that you need to allocate enough disk partition for future memory upgrade. The STD partition should always be larger than the system memory RAM.
2. **PHDISK /Create /File** - you can also choose to run Suspend-to-Disk and save your work into a STD file. You do not need to allocate an extra disk partition when running this option. The advantage of this is that you do not need to allocate or waste extra disk partition. The disadvantage of this option is that it is less secure since there is risk of deleting the STD file although the file is hidden.

RUNNING THE PHDISK /CREATE /PARTITION

Before you run this option, you should carefully consider how much disk size you need to allocate for the STD partition. The STD partition should be larger than the installed system memory RAM. If you are planning to install more memory in the future, it is recommended to allocate more disk space. Run FDISK under DOS and leave around 5% of disk space for Non-DOS partition. This will later be used by the PHDISK for creating the STD partition.

If you already run FDISK before, you need to delete the original partition of the hard disk.

Load the notebook driver CD and look for the PHDISK program file. Run “**PHDISK /Create /Partition**” or “**PHDISK /C /P**”. The PHDISK utility program will automatically assign a disk size in reference to the installed system RAM to be allocated for the STD partition. After PHDISK has completed the STD partition, you will be prompted to reboot the system.

RUNNING THE PHDISK /CREATE /FILE

Creating a STD file is much simpler since you do not need to allocate an extra disk partition. Load the notebook driver CD and look for the PHDISK program file. Run “**PHDISK /Create /File**” or “**PHDISK /C /F**”. PHDISK will create the **SAVE2DSK.BIN** file on Drive C. The size of this file will depend on the installed RAM memory of your computer. This file also is hidden and has read-only attributes. You must not delete this file.

 ***During power on or restart, the system will detect if STD partition or file is present. If not, it will show a red colored dialog box informing you that “Save to Disk Partition Not Present” and “Save to Disk Feature Disabled”. This warning message can be disable from "Advanced", "Save to Disk Warning" in BIOS setting by pressing F2 during system boot***

 **Whenever you upgrade the memory, you need to delete the existing STD partition or file and create a new one according to the new memory size. Run PHDISK /Delete /Partition or PHDISK /Delete /File to delete existing STD partition or file.**

Installing Windows NT/2000 from CD-ROM or DVD ROM

To install Windows NT directly from your CD-ROM or DVD-ROM, insert Windows NT installation CD into CD-ROM drive and enter BIOS Setup menu. Go to Boot menu and select “**ATAPI CD-ROM Drive**” as your boot device. For NT user, Please go to **Advanced** menu, then **Installed OS**, then select “**Others**” and select “**ATAPI CD-ROM Drive**” as your boot device. Go to Exit menu and select “**Exit Saving Changes**”.

Installing Windows 98/95/Me from CD-ROM or DVD-ROM

The easiest way to install Windows 98/95 is to boot from Windows 98 start-up disk. With Windows 98 start-up disk, you don't need to install CD-ROM driver since the start-up disk can support virtually all CD-ROM device. Insert Windows 98 Installation CD into CD-ROM drive and run “**setup.exe**”.

INSTALLING THE VGA DEVICE DRIVER

Following is the procedure for installing the Trident Video Accelerator 3D Adapter (English) VGA driver to your computer:

Installing VGA driver for Windows 2000

1. Boot Windows 2000 from your hard disk and insert the disc containing the VGA driver for Windows.

2. Click the **Start** button, then click **Settings**, and **Control Panel**. Double click **System** and then "**Hardware**", click **Device Manager** tab.
3. Click **Display adapters** and double click **Trident Video Accelerator CyberBlade-ii**. Select the **Driver** page and click **Update Driver** button.
4. Click **Next** to continue.
5. Tick **Specify a location** and **Have Disk**, then click **Browse** button. Then, navigate to "E:\Driver\Win2k\VGA" and click **Next**.
6. Click **Next** to accept the updated VGA driver
7. Click **Finish** and then restart computer to finish VGA driver installation.

Installing VGA device driver for Windows NT/98/Me

1. Insert the CD containing the VGA driver for Windows into CD-ROM drive.
2. Click the **Start** button, then point to **Settings**, and click **Control Panel**.
3. Double-click on the **Display** icon and click on the **Setting** tab.
4. Click **Advanced** then **Adapter**
5. Click **Change** and **Next**, then select **Display a list of all the drivers in a specific location**. Now you can select the driver you want, then click **Next**.
6. Click **Have Disk** to change display driver from CD-ROM
7. Click **Browse** button and navigate to the VGA driver location as "**E:\Driver\NT4.0\VGA**" "**E:\Driver\Win98\VGA**".
8. Click the **OK** button and select **Next** to continue the setup procedure.
9. Select **Yes** to restart your computer in order to finish the setup procedure.

INSTALLING THE MODEM DEVICE DRIVER

Following is the procedure for installing the ASKEY Data Fax Modem driver to your computer:

Installing modem driver for Windows 2000

1. Click the **Start** button, point to **Settings**, then click **Control Panel**.
2. Double-click on the **System** icon, **Hardware**, then click on the **Device Manager** folder tab.
3. Under the **Other Devices** line, highlight the **PCI Simple Communications Controller**.
4. Double Click **PCI Simple Communications Controller**, then click **Driver**
5. Select **Update Driver**, then **Next**
6. Select “**Search for a suitable driver for my device**”, and click **Next**.
7. Tick on “**Specify a location box**”. Then, click **Next** and **Browse** button and navigate to the modem driver location as “**E:\Driver\Win2K\Modem**”. Click **OK** and **Next** to begin searching the driver.
8. Click **Next** then **Finish** to complete the modem driver installation.

Installing modem driver for Windows NT

1. Boot Windows NT from your hard disk and insert the disc containing the Modem driver for Windows.

2. Click the **Start** button, then click **Run**. In the Run dialog box, click **Browse** button and navigate to the directory as “**E:\driver\NT4.0\modem\setup.exe**” where the modem driver is located.
3. Click **OK** to run the program. The EDSP Configuration box appears for you to set up the COM port.
4. Click **OK**. Then, point to **Start, Settings, and Control Panel**.
5. In the Control Panel box, double click the **Modem** icon. The Install New Modem message box appears. Click **Next** to detect modem.
6. When your modem are detected, a message box will appear to advise you the detected modem with its COM port. Click **Next** to continue with the installation.
7. Click **Finish** to show the Modem Properties message box. You will see the modem type and the attached port here.
8. Click **Close** to end this driver setting.

Installing modem driver for Win98/WinMe

1. Run E:\Driver\Win98\Modem\Setup.exe
2. Click **Next** to process next procedure.
3. It will prompt you to insert CD or disk. Click **OK** then click **Browse**, and navigate to the modem driver location as "E:\Driver\Win98\Modem and then click OK
4. Select "**Yes, I want to restart my computer now**" to finish the installation

INSTALLING THE LAN DRIVER

Following is the procedure for installing the Intel 82559 Fast Ethernet LAN driver:

Installing LAN driver for Windows NT

1. Boot Windows NT from your hard disk and **copy the whole "E:\Driver\NT4.0" folder into the hard disk**. (Install from CD directly is not commended).
2. Click the **Start** button, then click **Settings**, and **Control Panel**. Double click **Network** and click **Yes** to install network.
3. With **Wired to Network box** ticked on, click **Next**.
4. Click **Select from list** and **Have disk**.
5. Type "**E:\Driver\NT4.0\LAN**" and click **OK**.
6. Click **OK** and click **Next** to proceed with next step.
7. Select **Network Protocols** you need and click **Next** to proceed the next step.
8. Select **Network Services** and click **Next** to proceed the next step.
9. Click **Next** to continue installation.
10. When Windows prompts you that **Setup needs to copy some Windows files**, insert Windows NT disc and type "**E:\i386**". Then, click **Continue**.
11. Select "**Intel PRO PCI Adapter**" and click **Continue**.
12. Windows will ask you if you have DHCP server on your network. Ask your system administrator and click either **Yes** or **No**.

13. After enabling or disabling network binding, click **Next** to continue with the next procedure.
14. Click **Next** to start network.
15. Windows might ask your computer name, workgroup or domain. Input your data and click **Next**.
16. Finally, click **Finish** and click **Yes** to restart computer.

Installing LAN driver for Windows Me/2000

1. Install the LAN module first and boot Windows from your hard disk and insert the disc containing the LAN driver for Windows.
2. Click the **Start** button, then click **Settings**, and **Control Panel**. Double click System (for Win 2000, you need to click one more tab "**Hardware**") and click **Device Manager**.
3. Highlight "**Intel 8255X-based PCI Ethernet Adapter (10/100)**" or "**Network Adapter**" and then click **Update Driver**
4. Select "**Specify the location of the driver**" or "**Specify a location**" and click **Browse** to **E:\Driver\WinMe\LAN** (Please change to "**Win2K**" as the OS you are using) please specify **82557.inf** file and click **Next**
5. Select "**One of the other package**" (WinMe), then select "**Intel 8255X-based PCI Ethernet Adapter (10/100)**"
6. Follows the instruction of the system to finish and restart the computer.

Installing LAN driver for Windows 98

1. Boot Windows 98 from your hard disk and insert the disc containing the LAN driver for Windows 98.

2. Click the **Start** button, then click **Settings**, and **Control Panel**. Double click **System** and click **Device Manager** tab. Under **Other devices**, you'll see **PCI Ethernet Controller**. Select it and click **Remove** button.
3. Click **Refresh** button. The **Add New Hardware Wizard** will detect PCI Ethernet Controller. Click **Next** to search for the driver.
4. Click **Next** to continue.
5. Tick **Specify a location** and click **Browse** button. Then, navigate to "E:\Driver\Win98\LAN" and click **Next**.
6. Click **Next** to accept the updated driver for **Intel 8255X-base PCI Ethernet Adapter (10/100)**.
7. Click **Next** to continue with LAN driver installation.
8. Insert the disk labeled "**Windows 98 Second Edition CD-ROM**", and then click **OK**.
9. Type "**E:\Win98**", then click "**OK**".
10. Click **Finish** to complete installation.
11. Restart Computer to finish setting up LAN.

INSTALLING THE AUDIO DEVICE DRIVER

Your notebook computer uses the VIA PCI Audio controller embedded in VIA chipset core.

Installing Audio Driver for Windows NT4.0/98/2000/Me

1. Boot Windows from your hard disk and insert the disc containing the Audio driver for respective Windows version.

2. Click the **Start** button, then click **Run**. In the Run dialog box, click the **Browse** button and navigate to the directory as “**E:\driver\Win98\Audio**” “**E:\driver\NT4.0\Audio**”, “**E:\driver\Win2k\Audio**” and run “**setup.exe**”.
3. Click **Next** to proceed with the next step.
4. Select **Install** and click **Next** to begin installing the audio driver.
5. For NT user, it is necessary to **Add VIA Audio Controller** and **VIA MIDI External Port**. Then you can also select whether install **Microsoft Sidewinder 3D Pro Joystick** or not.
6. Select “**Yes, I want to restart my computer now**” and click **Finish** to complete the audio installation.
7. For Win98, the Notebook PC will also need Windows 98 operating system driver to complete the installation.

INSTALLING EASY BUTTON DRIVER

Following is the procedure for installing the Internet and e-mail button keys.

Installing Easy Button driver for Windows NT/98

1. Boot Windows from your hard disk and insert the disc containing the Internet/e-mail button driver.
2. Click the **Start** button, then click **Run**. In the Run dialog box, click **Browse** button and navigate to the directory as “**E:\driver\Win98\Easy button\setup.exe**”. Please use “**NT4.0**” path for Windows NT
3. The **Welcome** dialog will appear. Click **Next** to continue with the installation.

4. If you wish to install the driver in a different directory, click **Browse**. Otherwise, click **Next** to continue with the next step.
5. The **Select Program Folder** dialog box will appear. To setup icon on a different folder, you may type a new folder name or select one from the existing Folder list. Click **Next** to continue.
6. Click **Finish** to complete installation.

INSTALLING ZV-PORT DRIVER

The upper pcmcia slot of your notebook supports ZV-port. You need to ZV-port driver before you can use the slot for mpeg card. Following is the procedure for installing the ZV-port driver.

Installing ZV-port driver for Windows 98/WinMe

1. Boot Windows from your hard disk and insert the disc containing the ZV-port driver.
2. Click the **Start** button, then click **Run**. In the Run dialog box, click **Browse** button and navigate to the directory as "**E:\Win98\driver\ZV-port\setup.exe**". Please use "**WinMe**" path for Windows Me
3. Click **Next** to continue.
4. The **Welcome** dialog box will appear. Click **Next** to continue with the installation.
5. The **User Information** dialog box will appear. After inputting the name and company, click **Next** to continue.
6. Click **Next** to start copying files.
7. Click **Finish** to complete Setup.

Installing ALPS – Touch Pad driver for Windows 98/Me/2000

1. Click the **Start** button, then point to **Settings**, and click **Control Panel**.
2. Double-click on the **System** icon (For Win2000, please one more tab “**Hardware**”), and then click on the **Device Manager** folder tab.
3. It will find the mouse, and then double click **PS/2 Compatible Mouse Port**
4. Click **Driver**, and then **Update Driver**
5. Click **Next** and select **Display a list of all the driver in a specific location** for you to select the driver you want.
6. Click "**Have Disk**" then click **Browse** to navigate to "E:\driver\Win98\Touch Pad and then **OK** to search driver
7. We are applying the certificate of driver to Microsoft currently. You can bypass the license declaration and continue to install the driver. Follow the instruction to finish the installation. If the mouse fails to response, it is normal, because the driver is changed. Please just press the **Enter** and restart the computer by keyboard to finish the installation.

2.6 Turning off Your Computer

If you are not going to use the computer for awhile, it is best to turn off the power of the computer for longer use. Before turning off the power, you need to close first all application programs and shutdown the operating system. Then, press the power button to switch off the power of your computer. If you are using Windows 95/98 or its newer version, the system will power off by itself whenever you shut down the operating system.

After turning off the computer, make it a habit to leave the LVDS panel open for a while whenever used for an extended period of time. This allows the inside parts of the computer to cool off. Closing the panel will force the heat up against the LCD screen, which may degrade the LCD when done regularly. More importantly, never close the LVDS panel for a long period of time when computer is on and power saving features are disabled.

3 Using Your Notebook



This chapter describes how to operate the standard built-in features of the notebook that you normally would use in your day-to-day computer work. If you are new to computers and to your operating system, you also need to read the manual for the operating system on how to work with your computer. It is very important to familiarize yourself well with the operating system. The succeeding chapters let you know how to go beyond the basics and try other exciting features.

3.1 Starting Your Operating System

The operating system is a must ingredient in using your computer. Without an operating system, it is like playing chess without the chessboard. It is the platform for all your software application programs to run on. The most popular operating system today is Microsoft Windows. You should have one installed by your dealer unless you are an expert computer user and would need a more powerful operating system. If you have an operating system already installed in your computer, then you would be up and running after you power on your computer and boot up the system. Check your operating system manual on how to run it.

3.2 Knowing the Status of Your Computer

The Status LED Panel, located at the top of the base unit, provides you with several graphical icons with LEDs (Light Emitting Diode) in representing your system's activity and status. This includes power source and power management status. You will glance it from time to time as you use your computer.

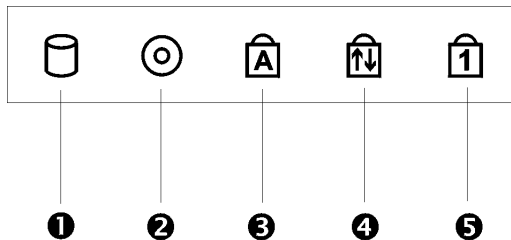

①. Drive Access

②. Diskette Drive Access

③. Caps Lock

④. Scroll Lock

⑤. Num Lock

Status LED Icons

- **Drive Access**
The drive folder icon indicates that the system is accessing either the HDD, CD-ROM, or DVD-ROM.
- **Diskette Drive Access**
The drive folder icon indicates that the system is accessing FDD. When this LED lights, the notebook writes data to or retrieves data from the floppy diskette drive.
- **Caps Lock**
The Caps Lock icon indicates that the Caps Lock key on the keyboard is activated. When activated, all alphabet keys typed in will be in upper-case or capital letters.
- **Scroll Lock**
The Scroll Lock icon indicates that the Scroll Lock key on the keyboard is activated. The Scroll Lock key has different functions depending on the software you are using.
- **Num Lock**
The Num Lock icon indicates that the Num Lock key on the keyboard is activated. When activated, the embedded numeric keypad LED will be enabled.

3.3 Understanding the Keyboard Functions

Your notebook computer is equipped with an 86-key keyboard that provides all the functionality of a full-sized 101 or 102-key IBM keyboard. Aside from

the standard typewriter-layout keyboard of your computer, there are a number of extra features and function controls on the built-in keyboard including Windows 95/98 hot keys.

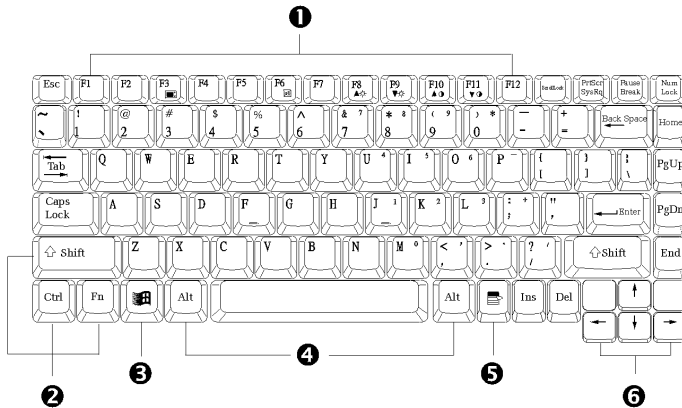

- 1**. Function Keys
- 2**. Control Keys
- 3**. Windows Start Menu Key
- 4**. Control Keys
- 5**. Windows Shortcut Key
- 6**. Cursor Control Keys









Keyboard



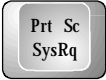

Key features and operations are described below:

- **Function Keys**
Function keys are application-driven, like **F1** through **F12** can be found on the keyboard. These keys work together with the **Fn** key to activate special functions. Some keys (printed in blue on keypad) are preprogrammed with dual functions.
- **Windows 95/98 keys**
Use the following two keys to facilitate your work:



- ➔ Start Menu key
Displays the Start menu.
- ➔ Shortcut/Application key
Provides quick access to shortcut menus. This key acts like a right mouse button.
- **Cursor Control keys**
Cursor control keys let you position the cursor on the screen where you want. In the screen, the cursor is a blinking underline, block, or vertical bar depending on the application. The cursor indicates where the next text typed is inserted.
- **Typewriter keys**
Typewriter keys (also called *alphanumeric* keys) are used to enter text and characters. Keys with blue print on them behave differently when combined with control keys.
- **Control keys – **Ctrl**, **Alt**, **Fn**, and **Shift**** are controls used in conjunction with other keys to change their functions. To use control keys, press and hold the control key while pressing another key. For example, “Press **Ctrl C**” means to hold down the **Ctrl** key and type the letter **C**. Key combinations work specific to the application you are running.

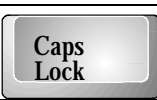

BASIC KEYBOARD FUNCTIONS

Keypad	Function Description
	<Enter> key. Execute a command. Within many text editing application programs, the <Enter> key inserts a hard carriage return, just like what ordinary typewriter does.
	<Esc> key. Press this key to cancel or escape from a command or function.
	<PrtSc> key. Known as the Print Screen key. Press this key to send information on the screen to a printer connected to the parallel port. <SysRq> key. Used for multitasking operating system.
	<Pause Break> key. Press this key to temporarily halt execution of a command. Pressing any other key resumes execution of a command.
	<Ins> key. Known as the Insert key. Press this key to toggle the keyboard data entry from insert to type over mode.
	 key. Known as the Delete key. Press this key to delete the character to the right of the cursor, or delete marked texts or items.
	<Backspace> key. Press this key to delete the character to the left of the cursor.
	<Shift> key. Press this key in combination with alphabet letters to produce uppercase letters in typing. Use this key in combination with those two-character keys (found on the second row of the keyboard) to produce the upper marked keys. Also used in most application program in combination with other keys to execute a certain command.





Keypad	Function Description
	<Tab> key. Press this key to move the cursor to the next tab stop on the right. This key works much the same as in ordinary typewriter.
	<Ctrl> key. Known as the Control key. Used in most application program in combination with other keys to execute a certain command.
	<Alt> key. Known as the Alternate key. Used in most application program in combination with other keys to execute a certain command.
	<Scroll Lock> key. Used in most application program to scroll the screen without having to move the cursor.
	< Num Lock > key. Activates the embedded 15-key numeric keypad. The keys are color coded blue.
	<Caps Lock> key. Used in most application program to always activate uppercase alphabet characters.

CURSOR CONTROL KEYS



Keypad	Function Description
	Up arrow key. Moves the cursor up one line at a time.
	Down arrow key. Moves the cursor down one line at a time.

Keypad	Function Description
	Left arrow key. Moves the cursor to the left one space at a time.
	Right arrow key. Moves the cursor to the right one space at a time.

SCREEN CONTROL KEYS





Keypad	Function Description
	<Home> key. Moves the cursor to the beginning of a screen or line.
	<PgUp> key. Moves the cursor up one screen at a time
	<PgDn> key. Moves the cursor down one screen at a time
	<End> key. Moves the cursor to the end of a screen or line.







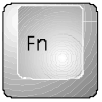

WINDOWS 95/98 HOT KEYS

Keypad	Function Description
	<Start> key. Pulls up the Windows 95 Start menu.
	<Right Click> key. Performs a mouse right-click function for Windows 95/98.

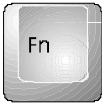
SPECIAL FUNCTION KEYS

The notebook has special system function keys which activate key serving dual functions. When pressed in conjunction with the <Fn> key, these keys set specific system parameters and are sometimes referred to as “hot keys”.

Keypad	Function Description
 + 	Switches display between LCD, CRT, or LCD and CRT simultaneously.
 + 	→ In DOS/Win95/Win98 (APM mode) /WinNT, means to enter Suspend-to-RAM mode. Your files will be saved into the memory and power off the computer. The Power Saving LED will also blink. Press the power button to resume.

Keypad	Function Description
	➔ In Win98 (ACPI mode)/Win2000, no function in this environment.
 + 	Switch the LCD display mode in expanded or non-expanded view. These combination keys only work in a 640x480 resolution mode.
 + 	Enable or Disables the built-in system speaker volume to on or off mode.
 + 	Increases the brightness of LCD display incrementally.
 + 	Decreases the brightness of LCD display incrementally.

3.4 Using the Glide Pad Pointing Device

Your computer comes with a built-in Glide Pad pointing device that is found on the center of the palm-rest surface.

The Glide Pad offers a number of options that let you customize how it functions. To access these options, locate the Control Panel and double click on the mouse icon. The options let you control the size and color of the cursor, cursor speed, the accepted double-click speed, and selection button orientation.

The Glide Pad works a mouse pointing device replacement that is used under

Windows-based operating system. Before using the Glide Pad, you need first to load or install the device driver to activate the device. You can also use the standard Microsoft or IBM PS/2 driver which is compatible with the Glide Pad device and is normally used under Windows-based operating system. However, if you want to utilize the added features of the Glide Pad, you may want to try installing its own device driver that comes with added utilities for enhancing the function of the device.

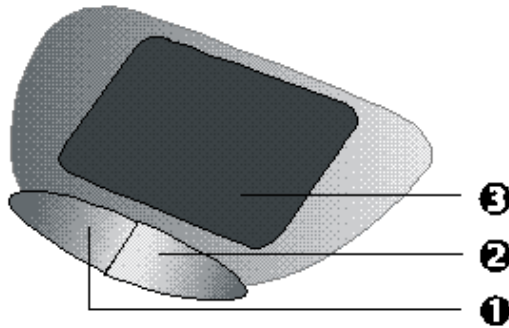

❶. Left Selection Button

❷. Right Selection Button

❸. Glide Pad

Glide Pad Features

Here how to use the Glide Pad pointing device:

1. The rectangular surface acts like a miniature duplicate of your display screen. To move the mouse cursor, place the finger lightly on the sensor pad and move in the desired direction. If you reach the end of the pad, lift your finger and place it back down on the other side of the pad.
2. To select an item, click on the item by pressing the left button control or by simply tapping on the surface once. A light, quick tap always works best. To execute an item, click the left button twice or do a quick double tap on the surface.
3. To simulate holding the mouse button down (dragging an icon or selection), use the tap-and-drag gesture. This feels much like a double-click, except that the finger remains on the pad after the second tap: Tap, lift, tap, hold and move. The simulated button remains held as long as the finger remains on the pad.



Avoid spilling any liquid on the Glide pad surface and always keep the Glide pad surface and pointing finger dry from sweat build-up. Also do not expose Glide pad to any magnetic source object.

3.5 Configuring Your Screen Display

The VGA display function of your notebook is based on a high performance PCI local bus controller and is fully IBM VGA compatible. This controller offers a large set of extended functions and higher resolutions especially useful when you are connecting an external high-resolution and high-frequency.

Refer to Section 5 “Installing the Notebook Device Drivers” of Chapter 2 in this manual, the procedures on how to install the VGA device driver under

Windows98. After installing the VGA driver, you would then configure the display resolution or screen size to match your LCD display panel. This notebook computer model provides 800x600 as well as 1024x768 LVDS panels. You would also probably want to set the amount of color output to display sharper images and photos.

POSSIBLE DISPLAY CONFIGURATIONS

The table below shows you the possible display resolution you can set when using either or both the LCD display or the external monitor (CRT):

Display	Possible Resolution	Maximum Colors
800x600 SVGA LCD	640x480	65,536 colors
	800x600	65,536 colors
	1024x768*	65,536 colors
1024x768 XGA LCD	640x480	65,536 colors
	800x600	65,536 colors
	1024x768	65,536 colors
CRT Only	640x480	16 million colors
	800x600	16 million colors
	1024x768	65,536 colors
Both	640x480	65,536 colors
	800x600	65,536 colors
	1024x768* (SVGA LCD)	65,536 colors
	1024x768 (XGA LCD)	65,536 colors

 * - **denotes special panning feature that allows higher resolution modes to be displayed on the LCD or CRT. This feature will show a section of a larger screen, and will automatically pan or scroll the screen horizontally and vertically when the mouse reaches the edge of the display.**

 **65,536 or 64K colors is also equivalent to 16-bit high color while 16 million or 16M colors is equivalent to 32-bit true color.**

 **You can use the <Fn> + <F3> hot-key to switch the display between LCD only, CRT only, and LCD and CRT display.**

CHANGING THE DISPLAY PROPERTIES UNDER WINDOWS 98

To change the display properties of your screen under Windows98, just right-click on the desktop area and select Properties or go to the Control Panel and click on the Display icon. The Display Properties dialog box will appear on your screen. Click on the Settings tab to set your desired configuration. Make sure to follow the configuration table above.

 **If you cannot configure the display properties, change the display driver first as mentioned on Section 5 “Installing the Notebook Device Drivers” of Chapter 2 in this manual. Consult your dealer for the latest Windows 98 AGP VGA driver.**

3.6 Knowing the Power Saving Features

One of the great features in your notebook computer aside from its superior performance is the ability to save energy power. Your computer is designed to incorporate intelligent and advanced power management functions that turns off power of most components when system is idle or not in use. This does not affect the performance of your system as it monitors the activity of your computer and resumes power and operating speed when activity is detected. This feature not only gives you longer battery hours but cooler systems and components as well. For more information on how to control the power

management features of your computer, refer to Chapter 6 on running the BIOS SETUP program.

The definitions of power management mode are depicted as follows:

Full-On Mode

No device in the system is executed in power management, the system can respond to all applications at maximum performance.

Doze Mode

The CPU clock is slow down when there is no system activity, but all other devices are in full-on state. This mode is controlled by the system itself.

Suspend to RAM mode

All devices are powered off except the other supporting components and system memory where your working files are stored. You can activate this either using the <Fn> + <F4> hot-key or by setting the Suspend timer on the BIOS setup program. To resume full-on state, press the power button.

Suspend to Disk mode

When this mode is activated, the context of the entire system is saved to disk and all components and devices are powered off, while all clocks are also stopped (except Real Time Clock or RTC). You can activate this by setting the Suspend mode to “Save to Disk” on the BIOS Setup program. To resume full-on state, you can press the power button.

 ***You must run the PHDISK utility first before you can activate Suspend-to-Disk.***

Mechanical off Mode

All power, except the RTC (real time clock), has been turned off from the system. This includes external AC power source and battery power source.

3.7 Using the FDD

The floppy disk drive (FDD) is probably one of the most used device on a computer. Your system ships with a standard 3.5-inch 1.44-MB diskette drive already installed in the left side of the system. The other disk drives on your computer are the hard disk drive and the CD-ROM or DVD-ROM drive. Disk drives are designated with drive letters with the floppy drive usually assigned as Drive A: and the hard drive and CD-ROM or DVD-ROM drive as Drive C: and Drive D: respectively.

The floppy disk drive (FDD) is a 3.5" diskette drive that can read and write to high-density 1.44MB diskettes or double-density 720KB diskettes. The diskette has an imprinted arrow on the front upper left corner, and a sliding write-protect tab on the bottom left corner of the diskette. When opened, the write-protect tab prevents any data from being written to or erased from the diskette. This also protects your diskette from getting infected by virus when used on other computers.

Insert the diskette with the arrow and label facing up and the shutter cover towards the drive. Slide the diskette into the drive until it is totally inserted and the eject button pops out. Remember to format new diskettes first using your operating system.

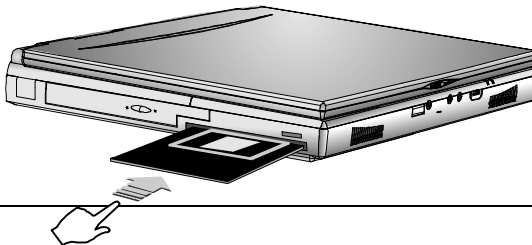

To eject or remove the diskette, make sure that the system is not accessing the diskette drive. Check the Status LED Indicator panel if the Drive Folder icon is activated or not. If not, then press the eject button on the drive to release the diskette.

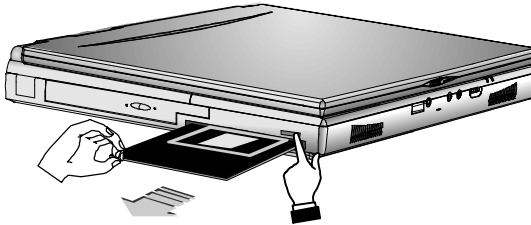

Always remove the diskette whenever you are placing the notebook computer into the carrying case for transport.

Always check the inserted diskette for virus before using it.

Always back up original diskette copies of your software programs.

3.8 Working with the Built-in HDD

Your notebook computer is equipped with a built-in large capacity 2.5 inch IDE hard disk drive where you store or install your computer operating system and all application software programs. The hard disk unit is located on the left side of your computer just underneath the palm-rest panel assembly. Like floppy diskette, you also need to format the hard disk before using. The internal hard disk is normally assigned as Drive C after formatting. Sometimes divided into two partitions, adding a Drive D. Since your computer supports

different hard disk capacities (up to 10GB or above), you also need to setup the disk type first on your computer's BIOS SETUP program before formatting the disk drive. Your computer supports Auto-detect hard disk type, so you do not need to set it manually. Your dealer should already have done all this for you. You can refer to **Chapter 6** on how to run the BIOS SETUP program.

You can increase the system's storage capacity by replacing the standard hard disk drive with a drive of greater storage capacity.

 ***If you wish to replace your hard disk, contact your local dealer for more information about this dealer-installable device.***

 ***Always turn off your computer first before removing the hard disk drive. Failure to do so might damage the computer and the hard disk. Avoid jarring or moving the computer while the hard disk is still being accessed.***

3.9 How to Access the CD-ROM/DVD-ROM Drive

Your system ships with either a 24X CD-ROM or 8X DVD-ROM drive installed on the left side of your computer. You would normally use the CD-ROM drive for installing operating system and software application programs. Unlike the disk drives, you can only read from the CD-ROM drive. You also need to install first the CD-ROM device driver before being able to access it. Refer to Section 5 "Installing the Notebook Device Drivers" of Chapter 2 in this manual, on how to install the driver or contact your dealer for assistance.

To insert and remove a disc on the drive:

1. Make sure the computer is turned on. Press the eject button found on the door cover of the CD-ROM drive. The CD tray mechanism will pop-out slightly and slowly pull out the whole length of the tray.
2. Place the disc on top of the CD tray with the label side facing up. Gently press the compact disc onto the center spindle to secure the disc.

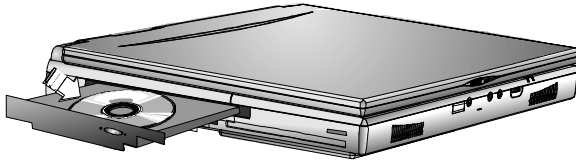

3. To remove the disc, press on the center spindle and pull up the disc from the side until the disc snaps out of the spindle lock.

 ***If the eject function is disabled by software or a power failure occurs the Emergency Eject Hole allows you to manually remove a CD from the reader.***

4. To close the CD-ROM drive, simply push the CD tray inside. The CD-ROM LED will activate when the disc is detected. Wait until the LED has turned off, then start to read the disc.

How to care the CD

When you handle CDs, pay attention to the following guidelines:

- Always pick up the CD by its edges.
- Avoid scratching or soiling the side of the CD that has no printing or writing on it.
- Do not write on or apply labels to either side of the CD.
- Keep the CD away from direct sunlight or high temperatures.

- Clean fingerprints or dust from the CD by wiping it with a soft cloth.

 **The CD-ROM reader is a Class 1 Laser Product.**

3.10 Using PCMCIA Cards

WHAT IS PCMCIA?

PCMCIA or Personal Computer Memory Card International Association is a non-profit trade association and standards body composed of over 500 member companies that defines the industry standard for the PC Card technology. The goal of PCMCIA is to ensure that any PC Card can work in any mobile computer built with a PCMCIA slot.

A PC Card is a peripheral device that can add a wide variety of capabilities to your computer including memory, mass-storage, LAN, fax/modem, wireless communications, and multimedia. The PCMCIA standardized PC Card is roughly the dimensions of a credit card, and has a standardized 68-pin connector at one end. The main benefits of the PC Card are its low-power consumption, small size and ruggedness.

Today, PCMCIA promotes the interoperability of PC Cards not only in mobile computers, but in such diverse products as digital cameras, cable TV, set-top boxes, and automobiles.

To allow manufacturers to add functions and technologies in the PC Card form factor, PCMCIA has defined two PC Card types:

Type	Thickness	Sample Devices
Type II	5.0 mm	Fax/Modem & Network Cards
Type III	10.5 mm	Hard Disks (ATA Cards) High-End Communication Cards

Type II Cards

Type II card has a thickness of 5.0 millimeters (mm). Type II cards are often storage or communications devices such as battery backed Static Random Access Memory (SRAM), Read Only Memory (ROM), Flash Memory, LAN, and Small Computer System Interface (SCSI). Typical Type II cards include input/output (I/O) features such as modems and LANs. The features for Type II Cards include following characters:

- **Type II Extended Cards**
Many PC cards are Type II extended cards. The extended card has an additional physical component that protrudes beyond the traditional card size. The extension can be as large as 40 mm deep by 9.65 mm high. This extension provides room for additional electronics as well as a location for external connectors.
- **Communication Cards**
Both network PC cards and fax/modem cards can use with your notebook computer. You can insert a fax/modem in either slot. Always insert the fax/modem card before using your fax/modem software application. If you start the application before inserting the fax/modem card, the application typically does not find the card.
- **Storage Cards**
When you insert a storage card or small hard drive card in the notebook computer, it appears as a unique drive depending on the type of card and the slot you are using.

The following table provides sample drive designations.

Sample Drive Designations	
Drive letter	Location/Device
C:	Internal hard disk
D:	Internal hard disk, 2nd partition

Sample Drive Designations	
Drive letter	Location/Device
E:	CD-ROM reader
F:	Slot 1, IDE/ATA hard drive
G:	Slot 0, high-speed memory card
H:	Slot 1, high-speed memory card

Type III Cards

Type III cards are thicker (10.5 mm) than Type II cards and allow no extensions. Type III card uses include advanced function I/O cards with added features such as multimode cards (cards with more than one function such as a combined modem and LAN card) and small hard drive cards.

Other Cards

Other kinds of PC cards are available to notebook computer users.

- **Global Positioning System (GPS)**
enable the tracking of remote units that equipped with the GPS device. (for example, delivery trucks) This device is useful in searching city map when driving.
- **Paging**
receiving remote paging messages
- **Serial**
adding an extra serial communications port
- **Multimedia**
combining animation and sound
- **Video**
recording, displaying, and capturing full-motion video
- **Audio**
enable the use of sound

 **For more PCMCIA information on the Internet, visit the PCMCIA home page at <http://www.pc-card.com>.**

WHAT IS CARDBUS?

CardBus is the high-performance 32-bit PCI bus master interface from PCMCIA. It runs up to 33MHz clock speed and operates at only 3.3V. Your notebook computer incorporates the CardBus inside with a double deck PCMCIA slot that supports one Type III card or two Type II cards at the same time. Aside from 3.3V CardBus PC cards, you can also insert existing 5V 16-bit PC cards which can also be detected and used by your computer. Another new type of PC card that has come out with the CardBus is the Zoomed Video or ZV port card. See section below.

WHAT IS ZV PORT?

Zoomed Video Port or ZV Port, is an adaptation of the PCMCIA port to allow a new type of PC card called "ZV Port Card" to be inserted into your computer. The proposed ZV Port PCMCIA standard eliminates sending large amounts of multimedia (video and audio) through the CPU or system bus, allowing for much higher overall system performance during multimedia usage. ZV Port technology is the enabling platform for the implementation of multimedia capabilities on notebook PCs. These capabilities include: video playback of MPEG1 and MPEG2 full motion video, video capture.

ZV Port - How it Works

With a ZV Port card inserted in your computer, compressed video data flows from hard disk, CD-ROM, LAN or other source. Across the system bus to the PCMCIA Cardbus controller, which passes it to the MPEG decoder in the PC Card slot, which returns uncompressed video data back to the PC Card controller. Using the ZV Port interface, the PC Card controller sends the

uncompressed video stream directly to the video/graphics controller and to the audio chip, and on to the display screen and speakers. In a PC without the ZV Port interface, there is no direct connection between the PC Card controller and the graphics controller, so the uncompressed data must wind back through the system bus, and possibly through the CPU, to get from the one component to the other.

 ***The 32-bit card bus also has zoomed video support in the top slot only. Also, this 32-bit structure is backward compatible, but also accepts new cards.***

SETTING UP THE PCMCIA CONTROLLER

In order for your computer to identify inserted PC cards and configure them to work, you need first to make sure that you have the Card and PCMCIA driver software loaded properly into your operating system.

INSERTING AND REMOVING A PCMCIA CARD

The double-deck PCMCIA slot built in at your computer supports either two PCMCIA Type II cards at the same time or one Type II card and one Type III card at the same time. The double-deck PCMCIA slot compartment includes a top slot and a bottom slot. Your computer also includes hot swapping capability, that allows you to exchange cards while the computer is turn on and start using it immediately.

Inserting PC Cards

To insert a PC card into the PCMCIA slot:

1. Locate the PC card slot cover on the right side of the computer.

2. Insert the side of PC card with the 68-pin socket into the PC slot. The face label of the card should also be facing up. You can insert either two Type II or one Type III card into the slots.
3. When the full length of the card is almost inside the slot, push firmly but slowly, to ensure full connection with the computer. The PC card will be detected and once the needed driver is installed, it will generate a beep sound to indicate that the card is detected.

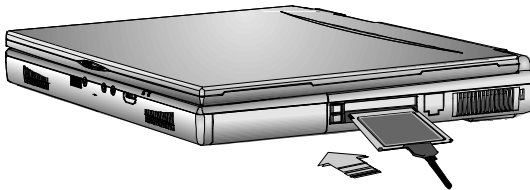

Removing PC Cards

To remove a PC card from the PCMCIA slot, you should first disable the PCMCIA card setting in the system as described followings:

1. Click the **Start** button, then point to **Settings**, and click **Control Panel**.
2. Double-click on **PC Card** icon to appear the **PC Card Properties** box.
3. Select the socket from the list that you want to remove on the **Socket Status** folder tab, and click **Stop** button. The system then disables the function of PCMCIA card.
4. Then you can remove the inserted PC card, push the button found on the left side of the PC slot to release the eject button. Then push it again to release the PC card. The upper left button releases the card on the top slot while the lower left button releases the card on the bottom slot.

5. When the PC card has moved out a space out of the slot, hold the edges of the card and slowly slide it out.

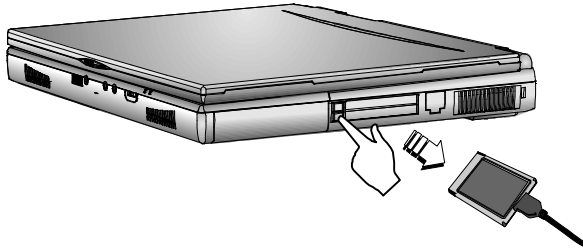

MAKING PC CARDS WORK

Since PC cards come in different types and brands, making every card work on your computer may not that be easy. Except for memory cards and fax/modem cards, other PC cards like network, SCSI or multifunction cards (MFC) need additional driver installation and configuration in making the card work. This additional driver may already be built-in under Windows 95/98 that Windows will try to detect and prompts you if you want to install the driver. If the driver is not included under Windows 95/98, you will need to insert the CD-ROM driver or driver diskette provided by the PC card manufacturer into the CD-ROM drive or floppy disk drive and install to Windows 95/98. You need to read the manual guide of the PC card on how to configure and operate the card.

 ***Some PC cards require additional system resources. Before inserting a PC card you may have to disable either the IR port, USB port, or the 56K internal modem. Check the Windows 98 device manager to ensure that one of these devices is disabled before inserting a PC card.***

HOT SWAPPING PC CARDS

Just like floppy disk drive, your PCMCIA slots allow you to replace one PC card with another even while your computer is on. However, you need to remember the rule that if the PC card is in use, you must not remove it. Below are some examples on how to handle PC cards when hot swapping:

- Do not remove a network card while your system is connected to the network.
- Do not remove fax/modem card while the card is transferring data into or from your computer.
- Do not remove a hard disk or ATA card while your computer is accessing the card.

To remove PC cards under Windows 95/98 while the computer is on, you need to stop the PC card device first under the PC Card properties box. Follow these steps:

1. In the Control Panel, double-click on **PC Card (PCMCIA)**. If there is a PC card icon on your Windows taskbar, you can also click on it to immediately go to the PC Card properties box.
2. Click on the PC card you want to remove and click **Stop**.
3. Wait until your system has prompted you that the PC card can already be removed.

 ***PC cards draw power even when not in use. To save energy, press the button to disconnect the card when it is not in use. You can leave the card in the slot while it is disconnected for easy storage.***

