

**CW001**  
**Mini-note**  
**User Guide**

**Copyright©2008**

**All Rights Reserved - Printed in Taiwan**

CW001 Mini-note User Guide

Original Issue: 2008/11

This manual guides you in setting up and using your new Mini-note. Information in this manual has been carefully checked for accuracy and is subject to change without notice.

No part of this manual may be reproduced, stored in a retrieval system, or transmitted, in any form or by any means, electronic, mechanical, photocopy, recording, or otherwise, without prior written permission.

## **Trademarks**

Product names used herein are for identification purposes only and may be the trademarks of their respective companies.

Microsoft, Windows XP, Windows Vista, and Windows Sound System are trademarks of Microsoft Corporation.

Intel ®, Intel ® Atom, Intel ® HD Audio (Azalia) are registered trademark of Intel Corporation.

Sound Blaster, Sound Blaster Pro are trademarks of Creative Technology.

All other brands or product names mentioned in this manual are trademarks or registered trademarks of their respective companies.

## **FCC Compliance Statement**

This equipment has been tested and found to comply with the limits for a class B digital device, pursuant to part 15 of the FCC Rules. These limits are designed to provide reasonable protection against harmful interference in a residential installation.

---

This equipment generates, uses and can radiate radio frequency energy and, if not installed and used in accordance with the instructions, may cause harmful interference to radio communications. However, there is no guarantee that interference will not occur in a particular installation. If this equipment does cause harmful interference to radio or television reception, which can be determined by turning the equipment off and on, the user is encouraged to try to correct the interference by one or more of the following measures:

- Reorient or relocate the receiving antenna.
- Increase the separation between the equipment and receiver.
- Connect the equipment into an outlet on a circuit different from that to which the receiver is connected.
- Consult the dealer or an experienced radio/TV technician for help.

### **FCC Declaration of conformity**

Model No. : CW001

Responsible party: First International Computer, Inc.

Address: No. 300, Yang Guang St., Nei Hu, Taipei, Taiwan.

Telephone No.: 886-8751-8751

This device complies with Part 15 of the FCC Rules. Operation is subject to the following two conditions:

1. This device may not cause harmful interference.
2. This device must accept any interference received, including interference that may cause undesired operation.

Any changes or modifications (including the antennas) made to this device that are not expressly approved by the manufacturer may void the user's authority to operate the equipment.

### **FCC RF Radiated Exposure Statement**

15.247 (b)(4), the EUT meets the requirement that it be operated in a manner that ensures the public is not exposed to radio frequency energy levels in excess of the Commission's guidelines (1.1307, 1.1310, 2.1091 and 2.1093)

This Transmitter has been demonstrated co-location compliance requirements with (Bluetooth / FCC ID: EUNCW001-02).

This transmitter must not be co-located or operating in conjunction with any other antenna or transmitter.

This equipment complies with FCC RF radiation exposure limits set forth for an uncontrolled environment. To maintain compliance with FCC RF exposure compliance requirements, avoid direct contact to the transmitting antenna during transmitting.

**Warning:** Use the specified shielded power cord and shielded signal cables with this computer, so as not to interfere with radio and television reception. If you use other cables, it may cause interference with radio and television reception.

You may find helpful the following booklet, prepared by the Federal Communications Commission: Interference Handbook (stock number 004-000-00345-4). This booklet is available from the U.S. Government Printing Office, Washington, DC20402

**Warning:** The user must not modify or change this computer without approval. Modification could void authority to this equipment.

## 5.21 Regulatory information/Disclaimers

---

Installation and use of this Wireless LAN device must be in strict accordance with the instructions included in the user documentation provided with the product. Any changes or modifications (including the antennas) made to this device that are not expressly approved by the manufacturer may void the user's authority to operate the equipment. The manufacturer is not responsible for any radio or television interference caused by unauthorized modification of this device, or the substitution of the connecting cables and equipment other than manufacturer specified. It is the responsibility of the user to correct any interference caused by such unauthorized modification, substitution or attachment. Manufacturer and its authorized resellers or distributors will assume no liability for any damage or violation of government regulations arising from failing to comply with these guidelines.

## **Canadian Department of Communications Compliance Statement**

The Class B digital apparatus meets all requirements of the Canadian Interference Causing Equipment Regulation.  
Cet appareil numérique de la class B respecte toutes les exigences du Règlement sur le matériel brouilleur du Canada.

### **電波障害自主規制について**

この装置は、情報処理装置等電波障害自主規制協議会（VCCI）の基準に基づくクラスB情報技術装置です。この装置は、家庭環境で使用することを目的としていますが、この装置がラジオやテレビジョン受信機に近接して使用されると、受信障害を引き起こすことがあります。取扱説明書に従って正しい取り扱いをしてください。

### **Shielded Cables Notice**

All connections to other computing devices must be made using shielded cables to maintain compliance with FCC regulations.

## **Peripheral Devices Notice**

Only peripherals (input/output devices, terminals, printers, etc) certified to comply with Class B limits may be attached to this equipment. Operation with non-certified peripherals is likely to result in interference to radio and TV reception.

## **Optical Disk Drive Notice**

The optical disk drive is Class 1 Laser Product.

## **Caution**

Changes or modifications not expressly approved by the manufacturer may void the user's authority, which is granted by the Federal Communications Commission, to operate this computer.

## **Use Conditions**

This part complies with Part 15 of the FCC Rules. Operation is subject to the following conditions: (1) this device may not cause harmful interference, and (2) this device must accept any interference received, including interference that may cause undesired operation.

## **European Notice**

For the following equipment: Notebook PC



Is herewith confirmed to comply with the requirements set out in the Council Directive on the Approximation of the Laws of the Member States relating to Electromagnetic Compatibility (2004/108/EC), Low-voltage Directive (96/68/EEC), the procedures given in European Council Directive 99/5/EC and 2004/104/EC.

The equipment was passed. The test was performed according to the following

European standards:

- EN 300 328 V.1.7.1
- EN 301 489-1 V.1.6.1 / EN 301 489-17 V.1.2.1
- EN 50385
- EN 60950-1

#### **Regulatory statement (R&TTE)**

● European standards dictate maximum radiated transmit power of 100mW EIRP

and frequency range 2.400-2.4835GHz;

● In France, the equipment must be restricted to the 2.4465-2.4835GHz frequency

range and must be restricted to indoor use.

Operation of this device is subjected to the following National regulations and may be prohibited to use if certain restriction should be applied.

## **802.11b and 802.11g Restrictions:**

- European standards dictate maximum radiated transmit power of 100mW EIRP and frequency range 2.400-2.4835GHz;
- In France, the equipment must be restricted to the 2.4465-2.4835GHz frequency range and must be restricted to indoor use."

## **Important Safety Instructions**

This section gives you detailed information about how to maintain a safe working environment while using the Notebook (Laptop). You can maintain its condition and performance by following these guidelines. Please read it carefully to ensure maximum safety.

1. Please read these safety instructions carefully.
2. Please keep this User manual for later reference.
3. Please keep this equipment from humidity.
4. Do not use this product near water, for example, near a bathtub, wash bowl, kitchen sink or laundry tub, in a wet basement or near a swimming pool.
5. Avoid using a telephone (other than a cordless type) during an electrical storm. There may be a remote risk of electric shock from lightning.
6. Do not use the telephone to report a gas leak in a vicinity of the leak.
7. Lay this equipment on a reliable surface when install. A drop or fall could cause injury.
8. All cautions and warnings on the equipment should be noted.
9. Do not operate the Notebook (Laptop) with the cover removed. For safety reason, the equipment should only be opened by qualified service personnel.
10. Always disconnect all telephone lines & all power cords from the wall outlet before servicing or disassembling this product. To reduce the risk of personal injury from electrical shock or hot surfaces, disconnect the power



---

cord from the wall outlet, and allow the internal system components to cool before touching.

11. Refer your system for servicing to qualified service personal under the following conditions:
  - When the power cord or plug is damaged or frayed.
  - If liquid has been spilled into the product.
  - If the product has been exposed to rain or water.
  - If the product does not operate normally when the operating instructions are followed. Adjust only those controls that are covered by the operating instructions, since improper adjustment of other controls may result in damage and will often require extensive work by a qualified technician to restore the product to normal condition.
  - If the product has been dropped or the cabinet has been damaged.
  - If the product displays a distinct change in performance, it indicates a need for service.
  - If the equipment has obvious sign of breakage.
12. The unit can be operated at maximum ambient temperature of 35°C.
13. Li-Ion battery is vulnerable, do not charge it with other power adapter, or it may cause fire or explosion
14. This product should be operated from the type of power indicated on the marking label. If you are not sure of the type of power available, consult your dealer or local power company.
15. Use only a power adapter approved for use with this Notebook (Laptop).
16. Do not install near any heat sources such as radiators, heat registers, stoves, or other apparatus (including amplifiers) that produce heat.
17. If the Notebook (Laptop) is not in use for a long time, disconnect it from mains to avoid possible damage by transient over-voltage.
18. The risk of ignition caused by small metallic objects, such as paper clips or staples, moving around inside TRANSPORTABLE EQUIPMENT during transportation shall be reduced objects entering the equipment, please do not remove dummy card from the product.

## **Installation Restrictions**

1. If an extension cord is used with this product, make sure that the total ampere rating of the equipment plugged into the extension cord does not exceed the extension cord ampere rating. Also, make sure that the total rating of all products plugged into the wall outlet does not exceed the fuse rating.
2. Never push objects of any kind into this product through cabinet slots as they may touch dangerous voltage points or short out parts that could result in a fire or electronic shock. Never spill liquid of any kind on the product.
3. For electrical safety concerns, only use telephone cables rated 26AWG or higher.
4. Unplug this product from the wall outlet before cleaning. Do not use liquid cleaners or aerosol cleaners. Use a dry cloth for cleaning. Ensure that no liquid enters the system.

## **Laser Compliance Statement**

The CD-ROM/DVD-ROM/CD-RW/DVD-RW drive in this computer is a laser product. The CD-ROM/DVD-ROM/CD-RW/DVD-RW drive's classification label (shown below) is located on the drive.

### **CLASS 1 LASER PRODUCT**

Caution: Use to any controls or adjustments or procedures other than those specified herein may result in hazardous radiate exposure. To prevent exposure to laser emanations (Harmful to Human eyes), do not attempt to disassemble this unit.

## **Battery (Lithium)**

### ***Note:***

1. The following caution statement is located in the service and operating

- 
- manual or on the label adjacent to the battery.
2. Risk of explosion if battery is replaced by an incorrect type.
  3. Do not dispose of batteries in a fire.

### **1. English**

CAUTION: DANGER OF EXPLOSION IF BATTERY IS INCORRECTLY REPLACED. REPLACE ONLY WITH SAME OR EQUIVALENT TYPE RECOMMENDED BY THE MANUFACTURER. DISCARD USED BATTERIES ACCORDING TO THE MANUFACTURER'S INSTRUCTIONS.

### **2. French**

IL Y A DANGER D'EXPLOSION S'IL Y A REMPLACEMENT INCORRECT DE LA BATTERIE. REMPLACER UNIQUEMENT AVEC UNE BATTERIE DU MÊME TYPE OU D'UN TYPE RECOMMANDÉ PAR LE CONSTRUCTEUR. METTER AU RÉBUT LES BATTERIES USAGÉES CONFORMÉMENT AUX INSTRUCTIONS DU FABRICANT.

### **3. German**

VORSICHT ! Explisionsgefahr bei unsachgemäßen Austausch der Batterie. Ersatz nur durch denselben oder einem vom Hersteller empfohlenem ähnlichen Typ. Entsorgung gebrauchter Batterien nach Angaben des Herstellers.

### **4. Swedish**

Explosionsfara vid felaktigt batteribyte. Använd samma batterityp eller en ekvivalent typ som rekommenderas av apparattillverkaren. Kassera använt batteri enligt fabrikantens instruction.

### **5. Danish**

Lithiumbatteri- Eksplosionsfare ved fejlagtig håndtering. Udskiftning må kun ske med batteri af samme fabrikat og type. Lever det brugte batteri tilbage til leverandoren.

## 6. Norwegian

Eksplosjonsafe ved feilaktig skifte av batteri. Benytt samme batteritype eller en tilsvarende type anbefalt av apparatfabriknten. Brukte batterier kasseres i henhold til fabrikantens instruksjoner.

## 7. Finnish

Paristo voi räjähtää, jos se on virheellisesti asennettu. Vaihda paristo ainostaan laitevalmistajan suosittelemaan tyyppiin. Hävitä käyteen paristo valmistajan ohjeiden mukaisesti.

## Power Cord Set Requirements

- An approved power cord has to be used.
- Make sure the socket and any extension cord(s) you use can support the total current load of all the connected devices.
- Before cleaning the computer, make sure it is disconnected from any external power supplies (i.e. AC adapter).
- The power cord set (appliance coupler, flexible cord, and wall plug) you received with the Notebook (Laptop) meets the requirements for use in the country where you purchased the equipment.
- Power cord sets for use in other counties must meet the requirements of the country where you use the computer. For more information on power cord set requirement, contact your local authorized dealer, reseller, or service provider.

- 
- Protect the power cord from being walked on or pinched particularly at plugs, convenience receptacles, and the point where they exit from the apparatus.

### **Power Lines**

Do not locate the antenna near overhead light or power circuits, or where it could fall into such power or circuits.

**Warning:** When installing or realigning an outside antenna system, extreme care should be taken to keep from touch such power lines or circuits. Contact with them could be fatal.

### **Television antenna connectors protection (for system TV tuner card) (Optional)**

#### **External television antenna grounding**

If an outside antenna or cable system is to be connected to your mini EPC, make sure that the antenna or cable system is electrically grounded to provide some protection against voltage surges and static charges.

Article 810 of the National Electrical Code. ANSI/NFPA 70, provide information with regard to proper grounding of the mast and supporting structure, grounding of the lead-in wire to an antenna discharge unit, size of grounding conductors, location of antenna discharge unit, connection to grounding electrodes, and requirements for the grounding electrode.

#### **Lightning protection**

For added protection of any product during a lightning storm or when it is left unattended or unused for long periods of time, unplug the product from the wall outlet and disconnect the antenna or cable system.



Må Kun tilkoples kabel-TV nett via galvanisk isolator.

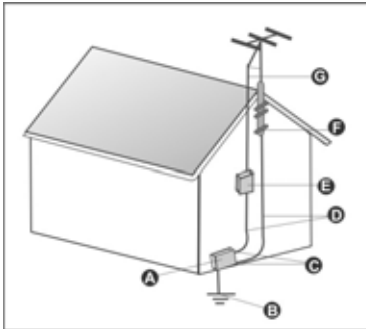

	Grounding Component
A	Electric Service Equipment
B	Power Service Grounding Electrode System (NEC Art 250, Part H)
C	Ground Clamps
D	Grounding Conductors (NEC Section 810-21)
E	Antenna Discharge Unit (NEC Section 810-20)
F	Ground Clamp
G	Antenna lead-in wire

Antenna grounding

## CATV Cable Safety

Make sure that your CATV system installer has connected the Coaxial cable shield to the grounding system of the building, as close to the point of cable entry as practical.

## TV Antenna

The TV antenna supplied with any TV Tuner module is intended for Indoor use only. Please do not use your TV Tuner module outdoors.

## Battery Pack

"Do not incinerate, (or) disassemble; may explode or release toxic materials.  
Do not short circuit; may cause burns. "

---

## About Your Mini-note



**C**ongratulation for having purchased your new Mini-note. This Mini-note incorporates the newest features to serve your daily needs easily for anywhere you go.

## About Your User Guide

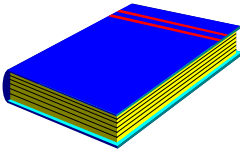

**W**elcome to your New Mini-note User Guide. This manual introduces you to the basic concepts of your new Mini-note.

This manual is divided into eight chapters.

- Chapter 1 Introduction
- Chapter 2 Getting Started
- Chapter 3 Using Your Mini-note
- Chapter 4 Multimedia Setup
- Chapter 5 Connecting External devices
- Chapter 6 System BIOS Setup
- Chapter 7 Upgrade Options
- Chapter 8 Care and Maintenance

Appendix A System Specifications



---

# Table of Contents

<b>ABOUT YOUR MINI-NOTE .....</b>	<b>15</b>
<b>ABOUT YOUR USER GUIDE.....</b>	<b>16</b>
<b>1 INTRODUCTION.....</b>	<b>21</b>
1.1 FEATURE HIGHLIGHT .....	22
1.2 UNPACKING THE MINI-NOTE .....	24
1.3 THE INSIDE OF THE MINI-NOTE.....	25
<i>Mini-note Status Icons</i> .....	27
<i>The Function of Easy Buttons</i> .....	29
1.4 THE FRONT SIDE OF THE MINI-NOTE .....	30
1.5 THE REAR SIDE OF THE NOTEBOOK.....	30
1.6 THE LEFT SIDE OF THE MINI-NOTE .....	31
1.7 THE RIGHT SIDE OF THE MINI-NOTE.....	32
1.8 THE UNDERSIDE OF THE MINI-NOTE.....	34
1.9 MINI-NOTE ACCESSORIES .....	36
<b>2 GETTING STARTED .....</b>	<b>37</b>
2.1 USING THE BATTERY PACK .....	38
<i>Extending Battery Life</i> .....	40
2.2 CONNECTING THE AC POWER SOURCE.....	41
2.3 STARTING YOUR MINI-NOTE .....	42
2.4 ADJUSTING THE DISPLAY CONTROLS .....	43
2.5 DEVICE DRIVERS INSTALLATION .....	43
<i>Installing Windows XP from Optical Disk Drive</i> .....	44
<i>Installing the Chipset Driver</i> .....	44
<i>Installing the VGA Device Driver</i> .....	45
<i>Installing the Audio Device Driver</i> .....	45
<i>Installing the Touch Pad Device Driver</i> .....	46

	<i>Installing the AzureWave Wireless LAN Device Driver (IEEE 802.11 b/g).....</i>	46
	<i>Installing the Billionton Wireless LAN Device Driver (IEEE 802.11 b/g/n ) .....</i>	47
	<i>Installing Bluetooth Device Driver .....</i>	47
	<i>Installing the LAN Device Driver.....</i>	48
	<i>Installing the Card Reader Device Driver .....</i>	48
	<i>Installing the Camera Device Utility .....</i>	49
	<i>Installing the Hotkey Utility.....</i>	49
2.6	TURNING OFF YOUR MINI-NOTE.....	50
<b>3</b>	<b>USING YOUR MINI-NOTE.....</b>	<b>53</b>
3.1	STARTING YOUR OPERATING SYSTEM .....	54
3.2	UNDERSTANDING THE KEYBOARD FUNCTIONS .....	54
	<i>Basic Keyboard Functions .....</i>	56
	<i>Cursor Control Keys .....</i>	58
	<i>Screen Control Keys.....</i>	58
	<i>Windows Hot Keys.....</i>	59
	<i>Special Function Keys.....</i>	59
3.3	USING THE TOUCHPAD POINTING DEVICE .....	61
3.4	CONFIGURING YOUR SCREEN DISPLAY .....	63
	<i>Possible Display Configurations.....</i>	63
	<i>Changing the Display Properties under Windows.....</i>	64
3.5	KNOWING THE POWER SAVING FEATURES .....	64
3.6	WORKING WITH THE BUILT-IN HDD.....	66
3.7	EXPRESSCARD.....	66
	<i>Inserting and Removing a ExpressCard.....</i>	66
3.8	USING FLASH MEMORY CARDS.....	68
	<i>Flash Memory Card .....</i>	68
<b>4</b>	<b>FUN WITH MULTIMEDIA .....</b>	<b>71</b>

---

4.1	MULTIMEDIA FEATURES .....	72
4.2	AUDIO SOUND SYSTEM FEATURES .....	72
4.3	SETTING UP THE AUDIO DRIVER PROPERTIES .....	73
4.4	WINDOWS MULTIMEDIA PROGRAMS .....	73
4.5	RECORDING SOUNDS .....	74
	<i>Using an External Microphone</i> .....	77
4.6	PLAYING AUDIO AND SOUND .....	77
	<i>Using the Windows Media Player</i> .....	78
4.7	PLAYING VIDEO AND MPEG FILES .....	78
<b>5</b>	<b>CONNECTING TO PERIPHERALS .....</b>	<b>81</b>
5.1	USING THE USB PORT .....	82
5.2	USING AN EXTERNAL MONITOR PORT .....	83
5.3	USING THE EXTERNAL AUDIO SYSTEM.....	84
5.4	USING THE LAN PORT.....	84
5.5	USING THE WIRELESS LAN .....	85
<b>6</b>	<b>CUSTOMIZING YOUR MINI-NOTE.....</b>	<b>87</b>
6.1	RUNNING THE BIOS SETUP PROGRAM .....	88
6.2	USING THE MAIN MENU SETUP .....	90
6.3	USING THE ADVANCED CMOS SETUP.....	92
6.4	SECURITY MENU SETUP .....	94
6.5	USING THE BOOT SETUP .....	95
6.6	HOW TO EXIT THE SETUP PROGRAM.....	96
6.7	HOW TO UPGRADE THE BIOS.....	97
<b>7</b>	<b>USING OPTIONS .....</b>	<b>99</b>
	SYSTEM UPGRADE .....	100
7.1	MEMORY UPGRADE.....	100
	<i>Installing Memory Module</i> .....	100
7.2	HARD DISK UPGRADE.....	102

---

7.3	WIRELESS MODULE INSTALLATION.....	103
<b>8</b>	<b>CARING FOR YOUR MINI-NOTE.....</b>	<b>1055</b>
8.1	IMPORTANT SAFETY INSTRUCTIONS .....	106
8.2	CLEANING YOUR MINI-NOTE .....	108
8.3	MAINTAINING THE LCD QUALITY .....	108
8.4	MAINTAINING YOUR HARD DISK .....	109
8.5	BATTERY CARE GUIDELINES.....	110
8.6	WHEN YOU TRAVEL.....	111
<b>APPENDIX A</b>	<b>SYSTEM SPECIFICATION.....</b>	<b>113</b>
	SYSTEM SPECIFICATION .....	114
	<i>Processor Unit</i> .....	114
	<i>System Memory</i> .....	114
	<i>LCD Display</i> .....	114
	<i>VGA System</i> .....	114
	<i>Storage</i> .....	115
	<i>Audio System</i> .....	115
	<i>ExpressCard</i> .....	115
	<i>Webcam</i> .....	115
	<i>Touchpad</i> .....	115
	<i>Keyboard</i> .....	116
	<i>Flash BIOS</i> .....	116
	<i>I/O Ports</i> .....	116
	<i>Wireless devices</i> .....	116
	<i>AC/DC Power Supply Adapter</i> .....	116
	<i>Battery</i> .....	116
	<i>Weight and Dimension</i> .....	117

# 1 Introduction

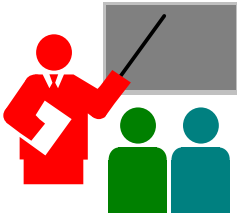

**Y**our Mini-note is a fully Windows® compatible portable computer. Slim, sleek ultra-portable computer. This device matches all the demands for high performance computing and multimedia technology.

Your Mini-note runs a wide variety to customize your special requirements, personal productivity, entertainment, professional applications and especially ideal for use on the road.

## 1.1 Feature Highlight

Before we identify each part of your Mini-note, we will first introduce you to other notable features of your Mini-note.

### ***Processing Unit***

- Check Your Mini-note runs on Intel® Atom microprocessor that is integrated with 512KB L2 Cache. Check with your dealer on the CPU type and speed.
- Fully compatible with an entire library of PC software based on operating systems such as Windows XP.

### ***Memory***

This Mini-note provides one memory slot for installing DDRII SDRAM 200-pin SODIMM module up to 2GB using 512MB or 1024MB DDRII SDRAM module.

### ***Wide Screen LCD Display***

Provides 10.1" 1024 x 600 (16:10) wide screen LCD display.

### ***Wireless LAN***

- IEEE 802.11b/g, half PCI-E Mini Card.
- IEEE 802.11b/g/n, full PCI-E Mini Card

### ***Bluetooth***

Provides Bluetooth function with USB Interface.

***Webcam***

Provides Webcam function with 1.3M pixels.

***USB 2.0***

Provides two USB2.0 ports for fastest I/O data transmission.

***Express Card***

Provides one ExpressCard slot for faster new-generation PC card solution.

***Graphic System***

Provides blazing graphics controller embedded in Intel 945 GSE chipset.

***PCI Local Bus Architecture***

32-bit PCI Enhanced IDE optimizes the data transfer between the CPU and SATAII hard disk drives. Support ultra DMA ATA-300 PIO Mode up to PIO Mode 4, bus mastering for LBA Scheme.

***Audio System***

Compliant with Intel HD Audio (Azalia). Sound Blaster compatible. Support 32-bit, multi-channel audio system output.

***Flash BIOS***

Flash BIOS allows you to easily upgrade the System BIOS using the Phoenix Flash utility program.

***Power and System Management***

- Integrated SMM (System Management Mode) on system chipset that shuts down components not in use to reduce power consumption. To execute power management, you can set up the parameter in Power Options properties by pointing your mouse to Control Panel of Windows.

- Closing the Mini-note (lowering the cover) allows you to stand by the system operation instantly. To wake up the system, press the power button or open the cover lid.
- System Password for User and Supervisor included on the BIOS SETUP Program to protect unauthorized use of your Mini-note.

## 1.2 Unpacking the Mini-note

Your Mini-note comes securely packaged in a sturdy cardboard shipping carton. Upon receiving your Mini-note, open the carton and carefully remove the contents. In addition to this User Guide, the shipping carton should also contain the following items:

- The Mini-note
- An AC Adapter and AC Power Cord
- Li-Ion Battery Pack
- CD Driver Utility and User Guide
- Quick Setup Manual

Carefully inspect each component to make sure that nothing is missing and/or damaged. Be sure to save the shipping materials and the carton in case you need to ship the Mini-note or store for an extended period of time.



## 1.3 The Inside of the Mini-note

The Mini-note is compact with features on every side. First, look at the inside of the system. The following sections describe inside features.



- |                               |                                  |
|-------------------------------|----------------------------------|
| 1. Webcam                     | 2. Color Widescreen LCD Display. |
| 3.7. Built-in Stereo Speakers | 4. Power On/Resume Button        |
| 5. LED Indicators             | 6. Integrated Microphone         |
| 8. Easy Buttons               | 9. Keyboard                      |
| 10. Touchpad Pointing Device  |                                  |

- Webcam  
The Webcam is 1.3M pixels. It can be used as a communication device that transmits instant image through network for conference.
- Color Widescreen LCD Display  
The Mini-note comes with a color LCD that you can adjust for a comfortable viewing position. The LCD is 10.1" TFT color LCD with

1024 x 600 (WSVGA) resolution panels. The features of the Color LCD Display are summarized as follows:

- ⊖ TFT color LCD with Widescreen 10.1" 1024 x 600 (WSVGA) resolution panels.
  - ⊖ Capable of displaying 16M colors (32-bit true color)
  - ⊖ LCD display control hot-keys allow you to adjust the brightness of the LCD.
  - ⊖ Simultaneous display capability for LCD and external desktop computer monitor.
- 
- **Built-in Stereo Speakers**  
Integrated mini stereo speaker provides sound and audio output for your multimedia presentations or listening pleasure.
  - **Power On/Resume Button**  
Switches the Mini-note power on and off, or resumes whenever it is in Suspend and Hibernate mode.
  - **LED Indicators**  
Keeps you informed of your Mini-note current power status and operating status. Description of the status icons appears in the latter part of this section.
  - **Integrated Microphone**  
Integrated mono microphone for instant voice recording and simultaneous voice conversation.
  - **Easy Buttons**  
There are three easy buttons used for Webcam transmitting, e-mail connecting, and Internet accessing instantly and easily. Description of the easy buttons appears in the latter part of this section.

- Keyboard
  - Standard QWERTY-key layout and full-sized 83 keys keyboard with Windows system hot-keys, embedded numeric keypad, 10 hot keys, inverted "T" cursor arrow keys, and separate page screen control keys.
  - Wide space below the keyboard panel for your wrist or palm to sit-on comfortably during typing.
- Touchpad Pointing Device

Microsoft mouse compatible with two Touchpad click buttons. The two select buttons located at each side of the Touchpad support tapping selection and dragging functions. These buttons work like a standard notebook mouse. Simply move your fingertip over the Touchpad to control the position of the cursor. Use the selection buttons at each side of the Touchpad to select menu items.

## MINI-NOTE STATUS ICONS

---

The Status LED Panel keeps you informed of the Mini-note's current power and operating status. Each LED is marked with an icon to designate the system status.

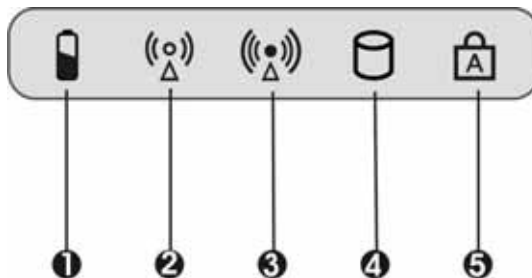

1. Battery Charging
3. 802.11 b/g/n Access

2. WLAN/Bluetooth Access
4. Drive Access

## 5. Caps Lock

- Battery Charging LED  
Lights to indicate battery in charging status.
  - ⊖ Lights on to indicate that the battery is in charging.
  - ⊖ When the light is off, it indicates the battery is fully charged or no battery installed.
- WLAN/Bluetooth Access  
When LED turns on indicates that the wireless LAN & Bluetooth module is activated. When LED lights off, it indicates that the function is disabled.
- 802.11b/g/n Access  
When LED turns on indicates that the system is implementing the 802.11b/g/n.
- Drive Access  
When LED turns on indicates that the system is accessing the Hard Disk Drive.
- Caps Lock  
When LED turns on indicates that the Caps Lock key on the keyboard is activated. When activated, all alphabet keys typed in will be in uppercase or capital letters.

## **THE FUNCTION OF EASY BUTTONS**

---

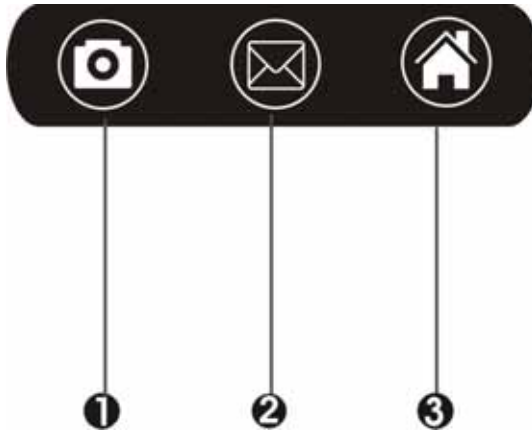

1. WebCam Button      2. E-Mail Button      3. Internet Button

- **WebCam Button**  
Press this button to transmit instant image as a communication device for network conference.
- **E-mail Button**  
This is the most convenient way to access the outlook utility just by pressing this button. You can simplify several procedures in entering into Outlook environment.
- **Internet Button**  
This technology is designed specifically for providing a very convenient way in connecting Internet only by pressing Internet button as shown in the graphics. Just Press this button to open the Internet Explorer directly.

## 1.4 The Front Side of the Mini-note



1. Microphone Jack

2. Headphone Jack

- **Microphone Jack**  
Allows you to connect an external microphone for monophonic sound recording directly into your Mini-note computer.
- **Headphone Jack**  
Lets you plug in a stereo headphone, powered speakers, or earphone set with 1/8 inch phono plug for personal listening.

## 1.5 The Rear Side of the Notebook

The system ports at the back of your notebook computer can connect the devices as described followings.



1. Locking Device Keyhole

2. VGA Port

- Locking Device Keyhole  
Lets you attach a Kensington security system or a compatible lock to physically secure your Mini-note.
- VGA Port  
Lets you attach an external monitor or projector for wider display. You can run the LCD display and the external monitor simultaneously or switch it to monitor only using the display hot-key.

## 1.6 The Left Side of the Mini-note

The left side of your Mini-note provides the features shown in the following figure.



1. USB 2.0 Port
3. ExpressCard Slot

2. Air-Outlet Vent

- **USB 2.0 Port**  
The Universal Serial Bus (USB) port allows you to connect USB 2.0-compliant devices (for example, printers, scanners and so on) to your Mini-note.
- **Air-Outlet Vent**  
Emits the heat out of your Mini-note and keeps it within operating temperature.
- **ExpressCard Slot**  
A newly developed PC Card interface, its connector has 26 pins and has a potential transfer rate of up to 500 MB/sec (or 250 MB/sec in each direction).

## 1.7 The Right Side of the Mini-note

The right side of the Mini-note offers the features shown in the following figure.





1. 4 in 1 card slot  
3. LAN Port

2. USB 2.0 Port  
4. DC Power Port

## Right Side Features

- 4 in 1 card slot  
The card slot supports SD, MMC, MS (Memory Stick), and MS\_Pro flash memory card format. You can use either of the 4 types flash memory cards for extra storage media. Please pay attention to correct direction when you insert the flash memory card. For more detail of flash card, you can refer to Chapter 3.7
- USB 2.0 Port  
The Universal Serial Bus (USB) port allows you to connect USB 2.0-compliant devices (for example, printers, scanners and so on) to your Mini-note.
- LAN Port  
An internal 10Base-T/100Base-TX and 1G (option) Ethernet LAN module connects your computer to other computers/networks through a local area network (LAN).

- DC Power Port  
Lets you connect the AC power adapter in supplying continuous power to your Mini-note and recharging the battery.

## 1.8 The Underside of the Mini-note

The bottom of the Mini-note offers the following features.



- |                                   |                          |
|-----------------------------------|--------------------------|
| 1. HSPDA/802.11 b/g/n Compartment | 2. Memory Compartment    |
| 3. Battery Lock Latch             | 4. Battery Bay           |
| 5. Wireless LAN Compartment       | 6. SIM Card Compartment  |
| 7. Hard Disk Compartment          | 8. Battery Release Latch |

### **Bottom of the System**

- HSPDA/IEEE802.11 b/g/n Compartment  
This compartment is equipped with full mini socket with PCI-E and USB interface, it is ready for IEEE802.11 b/g/n execution.
- Memory Compartment  
There is one SO-DIMM memory slot for installing memory module.

- **Battery Lock Latch**  
Push the latch to the left side to lock and secure the battery. This action is available to release the battery when the battery lock latch has located to unlock status at the right side.
- **Battery Bay**  
Equipped with a choice of Lithium-Ion (Li-Ion) battery pack.
- **Wireless LAN Compartment**  
This compartment is for installing Wireless LAN module to enable the Wireless LAN function. It is half mini socket with PCI-E and USB Interface. We strongly suggest that Wireless LAN module should be installed only by certified dealer.
- **SIM Card Compartment**  
Open this cover of this compartment for SIM Card installation.

***⚠ Before installing or replacing Sim card, be sure to turn off power, remove battery pack and prohibit any hot plug.***

- **Hard Disk Compartment**  
Open this cover of this compartment to replace with other Hard Disk Drive. Please refer to Chapter 7 for how to replace it.
- **Battery Release Latch**  
To release the battery, first locate the Battery Lock Latch at the left side with unlock status, then push the Battery Release Latch to the right end to remove the battery pack.

## 1.9 Mini-note Accessories

### ***AC Adapter***

The AC Adapter supplies external power to your Mini-note and charges the internal battery pack simultaneously. The AC adapter has an auto-switching design that can connect to any 100VAC ~ 240VAC power outlets. Change the power cord if you are going to use your Mini-note in countries with different connector outlets.

When you connect the AC adapter, it charges the battery whether or not the Mini-note is powered on.

### ***Battery Pack***

Aside from the AC adapter, your Mini-note can also be powered through the internal battery pack. The battery pack uses rechargeable Lithium-Ion (Li-Ion) battery cells that provide long computing hours when fully charged and power management enabled. You should always leave the battery inside your Mini-note even when using the AC adapter as it also acts as a back-up power supply in case power from the AC adapter is cut off. It is also very important to have the battery pack always charged to prevent battery cell degradation.

## 2 Getting Started

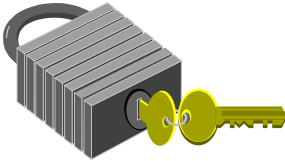

**Y**our Mini-note is designed and pre-configured for easy setup and use. This chapter describes the installation steps you should follow to get the Mini-note up and running as quickly as possible.

## 2.1 Using the Battery Pack

The Mini-note is designed to operate with one of the following power sources:

- With AC power using the AC adapter connected to an electrical outlet.
- With a Lithium-Ion (Li-Ion) battery pack.

You should use the AC adapter whenever it is possible, relying on the battery pack only when AC power is unavailable.

When you use your Mini-note the first time, please operate it without an external power source. You can connect the AC power adapter to immediately recharge the battery, when the battery pack is used up and the mini-note is turn off.

If you do not discharge the battery completely, it fails to accept a full recharge.

***⚠ Li-Ion battery is vulnerable, do not charge it with other power adapter, or it may cause fire or explosion.***

### ***Installing the Battery Pack***

This Mini-note provides the most convenient way to install the battery pack into your Mini-note. With the extended nose directed toward the compartment, insert and push the battery pack.



### ***Removing the Battery Pack***

To remove the battery pack, slide the lock latch to the end of right side to unlock the battery lock latch (1), then slide the battery release latch to the end of left side to release the battery latch (2), and take out the battery pack with your finger (3) simultaneously.



## ***Replacing the Battery Pack***

When your Mini-note estimates that the battery only has enough charge to continue for a few minutes, it will pop-up a warning message to alert you for recharging the battery. If you are consuming a lot of power by using the audio system, and the hard disk drives, your Mini-note might run out of charge much sooner than you expect. You should always respond to the battery low indication by connecting to AC power or turning off your Mini-note, or suspending your Mini-note to disk. If you do not do so, the Mini-note will automatically suspend to disk and turn off. The contents of the memory will store in the hard disk drive. You will be unable to restart the Mini-note until you have connected to the AC adapter or installed a charged battery. To replace the battery pack, refer to the previous sections on "Installing the Battery Pack" and "Removing the Battery Pack."

- ⚠ For Window XP, the suspend mode (Hibernate or Standby) can be chosen at Power Options of Windows's Control Panel)***
- ⚠ Be sure to save your data before replacing the battery pack or connecting the AC adapter. Failure to do so can result in data loss.***

## **EXTENDING BATTERY LIFE**

---

It is important to be aware of the simple things for extending the life of the system main battery while you are on the road. You should find a working place where the external lighting is not too bright and turn down the screen brightness. Also, you can choose the available mode on the Power Management item of the Control Panel in Windows.



## 2.2 Connecting the AC Power Source

The AC adapter provides external power source to your Mini-note and charges the internal battery pack at the same time. The AC adapter also has an auto-switching design that can connect to any 100VAC ~ 240VAC power outlets.

To connect the power adapter:

1. Plug the AC power cord into the power socket of the AC power adapter.
2. Plug the other end of the AC power cord to a live AC wall outlet.



3. Plug the connector of the AC adapter to the DC-IN port found at the right side of the Mini-note.

**⚠ Whenever possible, it is advisable to always have the AC adapter connected to the Mini-note and the battery pack installed. This ensures continuous power supply and prevents any data loss incurring from sudden power breakdown.**

- ***For the power supply of this equipment, an approved power cord has to be used.***
- ***Make sure the socket and any extension cord(s) you use can support the total current load of all the connected devices.***
- ***Before cleaning the Mini-note, make sure it is disconnected from any external power supplies (i.e. AC adapter).***

## 2.3 Starting Your Mini-note

The Power/Resume button is found on the left-top of the base unit. Press the Power/Resume button to start your Mini-note and check that if the Power LED turns on.



After a few seconds, the Mini-note's display will turn on and your Mini-note will begin to execute the Power On Self Test or POST to check if all system components are running properly. Any error found during the test will be displayed on the screen and may generate short beep sound as well.

After the test, the screen will also display a message "**press <F2> to enter SETUP**". You don't need to run this program at the moment as your dealer already made the necessary settings for your Mini-note optimal operation. Refer to Chapter 6 on running the SETUP program later.

After the test has completed, your Mini-note will start to search and boot up the operating system from your hard drive. The Mini-note normally comes with a Windows operating system pre-installed in your hard drive. Consult the Windows manual on how to use the program. If not, contact your dealer for assistance.

## 2.4 Adjusting the Display Controls

The LCD brightness adjustment is controlled by **<Fn> +<F8>** and **<Fn> + <F9>** keys respectively. You need to press these hot-key controls after powering on your Mini-note to suit your viewing pleasure.

The Brightness hot-key control adjusts the brightness on the LCD. The brightness hot-key control will not set the LCD completely dark or bright; it provides sufficient lighting to the LCD to match the external lighting of the surrounding. The brighter the room, the more you need to increase the brightness of the LCD.

## 2.5 Device Drivers Installation

If you already have an operating system installed into your Mini-note, it is best to install the needed device drivers for using the built-in devices of your Mini-note. Before installing the drivers, check with your dealer first if they have already installed all the drivers along with the operating system. If not, follow the procedures below:

## **INSTALLING WINDOWS XP FROM OPTICAL DISK DRIVE**

---

To install Windows XP directly from your USB - Slim Combo Drive (optional), please go to **Boot** menu of **BIOS** setup menu. Use arrow key to select "USB CDROM", then use "+" or "-" to move it to the top. Go to **Exit** menu and select "**Exit Saving Changes**". Accordingly, insert the Windows XP installation CD into USB - Slim Combo Drive (optional) with following the instructions on the screen to finish the installation.

### **Driver Installation Note:**

*∞ Please install Chipset and VGA driver first.*

*∞ The Bluetooth and Camera devices must be activated before installing Bluetooth or Camera driver.*

## **INSTALLING THE CHIPSET DRIVER**

---

Your Mini-note uses the advanced chipset. Installing the driver to enhance the stability and performance.

### ***Installing Chipset device driver for Windows XP***

1. Click the **Start** button, then point to **Run**. The **Run** dialog box appears.
2. Click the **Browse** button and specify the directory as "**E:\Drivers\WinXP\Chipset\Setup.exe**".
3. Click "**OK**" to execute the setup program. The **Setup** box appears.
4. Click "**Next**" continuously to install this driver when screen displays this command.
5. Click "**Yes**" continuously to install driver.
6. Click "**Next**" twice to continue the installation.

7. Tick the option "**Yes, I want to restart my computer now.** ", and press "**Finish**" to restart your system.

## **INSTALLING THE VGA DEVICE DRIVER**

---

Following is the procedure for installing the Video Accelerator 3D Adapter VGA driver to your Mini-note:

### *Installing VGA device driver for Windows XP*

1. Click the **Start** button, then point to **Run**. The **Run** dialog box appears.
2. Click the **Browse** button and specify the directory as "**E:\Drivers\WinXP\VGA\Setup.exe**".
3. Click "**OK**" to execute the setup program. The **Setup** box appears.
4. Click "**Next**" continuously to install this driver when screen displays this command.
5. Click "**Yes**" continuously to install driver.
6. Click "**Next**" twice to continue the installation.
7. Tick the option "**Yes, I want to restart my computer now.**", and press "**Finish**" to restart your system.

## **INSTALLING THE AUDIO DEVICE DRIVER**

---

Your Mini-note uses the Realtek Audio controller.

### *Installing Audio device driver for Windows XP*

1. Click the **Start** button, then point to **Run**. The **Run** dialog box appears.
2. Click the **Browse** button and specify the directory as "**E:\Drivers\WinXP\Audio\Setup.exe**".

where the audio driver is located.

3. Click "**OK**" to execute the setup program. The **Setup** box appears.
4. Click "**Next**" to continue the installation.
5. Tick the option "**Yes, I want to restart my computer now.**", and press "**Finish**" to restart your system.

## **INSTALLING THE TOUCH PAD DEVICE DRIVER**

---

Please follow the procedures below for installing the Touch Pad driver:

### *Installing Touch Pad device driver for Windows XP*

1. Click the **Start** button, then point to **Run**. The **Run** dialog box appears.
2. Click the **Browse** button and specify the directory as  
**"E:\Drivers\WinXP\Touch Pad\setup.exe"**
3. Click "**OK**" to execute the setup program. The **Setup** box appears.
4. Click "**Next**" to continue the installation.
5. Click "**Finish**" to complete the installation.
6. Click "**Yes**" to restart your system.

## **INSTALLING THE AZUREWAVE WIRELESS LAN DEVICE DRIVER (IEEE 802.11 B/G)**

---

Please follow the procedures below for installing the Wireless LAN driver:

### *Installing AzureWave Wireless LAN driver for Windows XP*

1. Click the **Start** button, then point to **Run**. The **Run** dialog box appears.
2. Click **Browse** button and specify the directory as  
**"E:\Drivers\WinXP\AzureWave\Wireless LAN\Setup.exe"**

3. Click "**OK**" to execute the setup program. The **Setup** box appears.
4. Click "**Next**" twice to execute the setup program.
5. Click "**Install**" to implement setup program to install this driver.
6. Click "**Finish**" to complete the installation.

## **INSTALLING THE BILLIONTON WIRELESS LAN DEVICE DRIVER (IEEE 802.11 B/G/N)**

---

Please follow the procedures below for installing the Wireless LAN driver:

### *Installing Billionton Wireless LAN driver for Windows XP*

1. Click the **Start** button, then point to **Run**. The **Run** dialog box appears.
2. Click **Browse** button and specify the directory as "**E:\Drivers\WinXP\Billionton\Wireless LAN\Setup.exe**".
3. Click "**OK**" to execute the setup program. The **Setup** box appears.
4. Click "**Next**" to execute the setup program.
5. Choose "**I accept the terms in the license agreement**" and click "**Next**".
6. Click "**Install**" to implement setup program to install this driver.
7. Click "**Finish**" to complete the installation.

## **INSTALLING BLUETOOTH DEVICE DRIVER**

---

Please follow the procedures below for installing the Bluetooth driver:

### *Installing Bluetooth device driver for Windows XP*

1. Click the **Start** button, then point to **Run**. The **Run** dialog box appears.

2. Click the **Browse** button and specify the directory as.  
"**E:\Drivers\WinXP\Bluetooth\Setup.exe**".
3. Click "**OK**" to execute the setup program. The **Setup** box appears.
4. Click "**Next**" to continue the following steps.
5. Choose "**I accept the terms in the license agreement**" and click "**Next**".
6. Click "**Install**" to implement setup program to install this driver.
7. Click "**Finish**" and then press "**Yes**" to restart your system.

## **INSTALLING THE LAN DEVICE DRIVER**

---

Please follow the procedures below for installing the LAN driver:

### ***Installing LAN device driver for Windows XP***

1. Click the **Start** button, then point to **Run**. The **Run** dialog box appears.
2. Click the **Browse** button and specify the directory as.  
"**E:\Drivers\WinXP\LAN\setup.exe** "
3. Click "**OK**" to execute the setup program. The **Setup** box appears.
4. Click "**Next**" to execute the setup program
5. Click "**Install**" to implement setup program to install this driver.
6. Click "**Finish**" to complete the installation.

## **INSTALLING THE CARD READER DEVICE DRIVER**

---

Please follow the procedures below for installing the Card Reader driver:



### ***Installing Card Reader device driver for Windows XP***

1. Click the **Start** button, then point to **Run**. The **Run** dialog box appears.
2. Click the **Browse** button and specify the directory as  
**"E:\Drivers\WinXP\Card Reader\setup.exe"**
3. Click **"OK"** to execute the setup program. The **Setup** box appears.
4. Click **"OK"** to complete the installation.

### **INSTALLING THE CAMERA DEVICE UTILITY**

---

Please follow the procedures below for installing the Camera utility:

#### ***Installing Camera utility for Windows XP***

1. Click the **Start** button, then point to **Run**. The **Run** dialog box appears.
2. Click the **Browse** button and specify the directory as  
**"E:\Drivers\WinXP\Camera\UVCMonitor.exe"**.
3. Click **"OK"** to execute the setup program. The **Setup** box appears.
4. The dialog box will close when complete the installation.

### **INSTALLING THE HOTKEY UTILITY**

---

Please follow the procedures below for installing the Hotkey utility:

#### ***Installing Hotkey utility for Windows XP***

1. Click the **Start** button, then point to **Run**. The **Run** dialog box appears.
2. Click the **Browse** button and specify the directory as  
**"E:\Drivers\WinXP\Hotkey\setup.exe"**.
3. Click **"OK"** to execute the setup program. The **Setup** box appears.

4. Click "**Next**" to execute the setup program.
5. Click "**Install**" to implement setup program to install this driver.
6. Tick the option "**Yes, restart the computer now**", and press "**Finish**" to restart your system.
1. Installing the Novatel

## 2.6 Turning off Your Mini-note

If you are not going to use the Mini-note for a while, it is best to turn off the power of the Mini-note. Before turning off the power, you need to first close all application programs and shut down the operating system.

After turning off the Mini-note, make it a habit to leave the LCD panel open for a while whenever used for an extended period of time. This allows the inside parts of the Mini-note to cool off. Closing the panel will force the heat up against the LCD screen, which may degrade the LCD when done regularly. More importantly, never close the LCD panel for a long period of time when it is on and power saving features are disabled.

This page is intended to be blank.



# 3 Using Your Mini-note



**T**his chapter describes how to operate the standard built-in features of the Mini-note.

## 3.1 Starting Your Operating System

The operating system is the software foundation for your Mini-note. It is the platform for all your software application programs to run on. The most popular operating system today is Microsoft® Windows®. The Mini-note comes with an operating system pre-installed and needs only to be setup and configured during initial use.

## 3.2 Understanding the Keyboard Functions

Your Mini-note is equipped with an 83 keys keyboard that provides all the functionality of a full-sized 101 or 102-key keyboard. Aside from the standard typewriter-layout keyboard of your Mini-note, there are a number of extra features and function controls on Mini-note.



- |                           |                        |
|---------------------------|------------------------|
| 1. Function Keys          | 2. Control Keys        |
| 3. Windows Start Menu Key | 4. Control Keys        |
| 5. Windows Shortcut Key   | 6. Cursor Control Keys |

## Keyboard

Key features and operations are described below:

- **Function Keys**

Function keys are application-driven, like **F1** through **F12** can be found on the keyboard. These keys work together with the **Fn** key to activate special functions. Some keys (printed in blue on keypad) are preprogrammed with dual functions.

- **Control keys** — **Ctrl**, **Alt**, **Fn**, and **Shift** are controls used in conjunction with other keys to change their functions. To use control keys, press and hold the control key while pressing another key. For example, "Press **Ctrl-C**" means to hold down the **Ctrl** key and type the letter **C**. Key combinations work especially to the application you are running.

- **Windows keys**

Use the following two keys to facilitate your work:

- Start Menu key  
Displays the Start menu.
- Shortcut/Application key  
Provides quick access to shortcut menus. This key acts like a right mouse button.

- **Cursor Control keys**



Cursor control keys let you position the cursor on the screen where you want. In the screen, the cursor is a blinking underline, block, or vertical bar depending on the application. The cursor indicates where the next text typed is inserted.

- **Typewriter keys**











Typewriter keys (also called *alphanumeric* keys) are used to enter text and characters. Keys with blue print on them behave differently when combined with control keys.

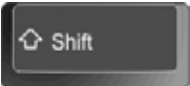

## BASIC KEYBOARD FUNCTIONS

---

Keypad	Function Description
	< <b>Enter</b> > key. Execute a command. Within many text editing application programs, the <Enter> key inserts a hard carriage return, just like what ordinary typewriter does.
	< <b>Esc</b> > key. Press this key to cancel or escape from a command or function.
	< <b>Ins</b> > key. Known as the Insert key. Press this key to toggle the keyboard data entry from insert to type over mode.







Keypad	Function Description
	<p>&lt;<b>Fn</b>&gt; + &lt;<b>PrtScr</b>&gt; key. Known as the Print Screen key. Press this key to map the whole screen to share memory for your specific usage.</p>
	<p>&lt;<b>Del</b>&gt; key. Known as the Delete key. Press this key to delete the character to the right of the cursor, or delete marked texts or items.</p>
	<p>&lt;<b>Pause</b>&gt; key. Press this key to temporarily halt execution of a command. Pressing any other key to resume execution of a command.</p>
	<p>&lt;<b>Backspace</b>&gt; key. Press this key to delete the character to the left of the cursor.</p>
	<p>&lt;<b>Shift</b>&gt; key. Press this key in combination with alphabet letters to produce uppercase letters in typing. Use this key in combination with those two-character keys (found on the second row of the keyboard) to produce the upper marked keys. Also used in most application program in combination with other keys to execute a certain command.</p>
	<p>&lt;<b>Tab</b>&gt; key. Press this key to move the cursor to the next tab stop on the right. This key works much the same as in ordinary typewriter.</p>
	<p>&lt;<b>Ctrl</b>&gt; key. Known as the Control key. Used in most application program in combination with other keys to execute a certain command.</p>
	<p>&lt;<b>Alt</b>&gt; key. Known as the Alternate key. Used in most application program in combination with other keys to execute a certain command.</p>
	<p>&lt;<b>Num Lock</b>&gt; key. Activates the embedded 15-key numeric keypad. The keys are color coded blue.</p>
	<p>&lt;<b>Caps Lock</b>&gt; key. Used in most application program to always activate uppercase alphabet characters.</p>

Keypad	Function Description
 + 	< <b>Fn</b> > + < <b>Scroll Lock</b> > key. Used in most application program to scroll the screen without having to move the cursor.





## CURSOR CONTROL KEYS





---

Keypad	Function Description
	<b>Up arrow key.</b> Moves the cursor up one line at a time.
	<b>Down arrow key.</b> Moves the cursor down one line at a time.
	<b>Left arrow key.</b> Moves the cursor to the left one space at a time.
	<b>Right arrow key.</b> Moves the cursor to the right one space at a time.



## SCREEN CONTROL KEYS

---

Keypad	Function Description
 + 	< <b>Fn</b> > + < <b>Home</b> > key. Moves the cursor to the beginning of a screen or line.
 + 	< <b>Fn</b> > + < <b>PgUp</b> > key. Moves the cursor up one screen at a time









Keypad	Function Description
 + 	< <b>Fn</b> > + < <b>PgDn</b> > key. Moves the cursor down one screen at a time
 + 	< <b>Fn</b> > + < <b>End</b> > key. Moves the cursor to the end of a screen or line.



## WINDOWS HOT KEYS

Keypad	Function Description
	< <b>Start</b> > key. Pulls up the Windows Start menu.
	< <b>Right Click</b> > key. Performs a mouse right-click function for Windows system.

## SPECIAL FUNCTION KEYS

The Mini-note has special system function keys that activate key serving dual functions. When pressed in conjunction with the <**Fn**> key, these keys set specific system parameters and are sometimes referred to as "hot keys".

Keypad	Function Description
 The image shows two keyboard keys: an 'Fn' key on the left and an 'F1' key on the right. The 'F1' key has a small Bluetooth symbol in the bottom right corner. A plus sign is placed between the two keys to indicate they are pressed together.	To enable or disable the Bluetooth function.
 The image shows two keyboard keys: an 'Fn' key on the left and an 'F2' key on the right. The 'F2' key has a small Wireless LAN symbol in the bottom right corner. A plus sign is placed between the two keys to indicate they are pressed together.	To enable or disable the Wireless LAN function.
 The image shows two keyboard keys: an 'Fn' key on the left and an 'F3' key on the right. The 'F3' key has a small icon representing a display switch (LCD, CRT, or LCD and CRT) in the bottom right corner. A plus sign is placed between the two keys to indicate they are pressed together.	Switches display between LCD, CRT, or LCD and CRT simultaneously.
 The image shows two keyboard keys: an 'Fn' key on the left and an 'F5' key on the right. The 'F5' key has a small Wireless LAN symbol in the bottom right corner. A plus sign is placed between the two keys to indicate they are pressed together.	To enable or disable the 802.11b/g/n function.
 The image shows two keyboard keys: an 'Fn' key on the left and an 'F6' key on the right. The 'F6' key has a small speaker icon in the bottom right corner. A plus sign is placed between the two keys to indicate they are pressed together.	To mute or open the built-in system speaker.
 The image shows two keyboard keys: an 'Fn' key on the left and an 'F7' key on the right. The 'F7' key has a small touchpad icon in the bottom right corner. A plus sign is placed between the two keys to indicate they are pressed together.	To activate or deactivate the touchpad function.
 The image shows two keyboard keys: an 'Fn' key on the left and an 'F8' key on the right. The 'F8' key has a small sun icon with a downward-pointing triangle in the bottom right corner. A plus sign is placed between the two keys to indicate they are pressed together.	Decrease the brightness of LCD display incrementally.
 The image shows two keyboard keys: an 'Fn' key on the left and an 'F9' key on the right. The 'F9' key has a small sun icon with an upward-pointing triangle in the bottom right corner. A plus sign is placed between the two keys to indicate they are pressed together.	Increases the brightness of LCD display incrementally.

Keypad	Function Description
 The image shows two keyboard keys: a black 'Fn' key on the left and a grey 'F10' key on the right. The 'F10' key has a speaker icon and a downward-pointing triangle. A plus sign is positioned between the two keys.	Decrease the audio volume incrementally.
 The image shows two keyboard keys: a black 'Fn' key on the left and a grey 'F11' key on the right. The 'F11' key has a speaker icon and an upward-pointing triangle. A plus sign is positioned between the two keys.	Increase the audio volume incrementally.

### 3.3 Using the Touchpad Pointing Device

Your Mini-note comes with a built-in Touchpad pointing device that is found on the center of the palm-rest surface.

The Touchpad offers a number of options that let you customize how it functions. To access these options, locate the **Control Panel** and double click on the **Mouse** icon. The options let you control the size and color of the cursor, cursor speed, the accepted double-click speed, and selection button orientation.

The Touchpad works a mouse pointing device replacement that is used under Windows-based operating system. You can use the standard Microsoft driver that is compatible with the Touchpad device and is normally used under Windows-based operating system. However, if you want to utilize the added features of the Touchpad, you may want to try installing its own device driver that comes with added utilities for enhancing the function of the device.



1. Left Selection Button
2. Right Selection Button
3. Touchpad

## **Touchpad Features**

Here how to use the Touchpad pointing device:

1. The rectangular surface acts like a miniature duplicate of your display screen. To move the mouse cursor, place the finger lightly on the sensor pad and move in the desired direction. If you reach the end of the pad, lift your finger and place it back down on the other side of the pad.
2. To select an item, click on the item by pressing the left button control or by simply tapping on the surface once. A light, quick tap always works best. To execute an item, click the left button twice or do a quick double tap on the surface.

⚠ *Avoid spilling any liquid on the Touchpad surface and always keep the Touchpad surface and pointing finger dry from sweat built-up. Also do not expose Touchpad to any magnetic source object.*

## 3.4 Configuring Your Screen Display

The VGA display function of your Mini-note contains RAM-based Digital-to-Analog Converter (RAMDAC) that transforms the digital data from the graphics and video subsystems to analog data for the CRT monitor. This controller offers a large set of extended functions and higher resolutions especially useful when you are connecting an external high-resolution and high-frequency CRT or LCD.

Please Refer to Section 5 "Installing the Mini-note Device Drivers" of Chapter 2 in this manual for the procedures on how to install the VGA device driver under Windows. After installing the VGA driver, you would then configure the display resolution or screen size to match your LCD display panel. This Mini-note model provides Wide screen 10.1" 1024 x 600 (WSVGA) resolution panels. You would also probably want to set the amount of color output to display sharper images and photos.

### **POSSIBLE DISPLAY CONFIGURATIONS**

The table below shows you the possible display resolution you can set when using either the LCD display or the external monitor (CRT):

Display	Possible Resolution	Maximum Colors
Widescreen 10.1" WSVGA LCD	1024 x 600	16 million colors
CRT Only	1600 x1200	16 million colors

	(Maximum resolution)	
--	----------------------	--

- ⊗ ***65,536 or 64K colors is also equivalent to 16-bit high color while 16 million or 16M colors is equivalent to 32-bit true color.***
- ⊗ ***You can use the <Fn> + <F3> hot-key to switch the display between LCD only, CRT only, or both LCD and CRT display.***

## CHANGING THE DISPLAY PROPERTIES UNDER WINDOWS

---

To change the display properties of your screen under Windows system, just right-click on the desktop area and select Properties or go to the Control Panel and click on the Display icon. The Display Properties dialog box will appear on your screen. Click on the Settings tab to set your desired configuration. Make sure to follow the configuration table above.

- ⊗ ***If you cannot configure the display properties, change the display driver first as mentioned on Section 5 "Installing the Mini-note Device Drivers" of Chapter 2 in this manual. Consult your dealer for the latest Windows VGA driver.***

## 3.5 Knowing the Power Saving Features

Aside from its superior performance, one of the great features in your Mini-note is the ability to conserve power. Your Mini-note is designed to incorporate intelligent and advanced power management functions that turn off power of most components when system is idle or not in use. This feature not only gives you longer battery life but also cools the systems and components as well.



The definitions of Standby Mode, Hibernation Mode, and Shutdown are depicted as follows:

### ***Standby Mode***

Standby Mode is mainly for power saving. When the Standby Mode is activated, your display and hard drive are shut down and all open applications and documents are stored in RAM (Random Access Memory). This allows your Mini-note to wake up quickly, but a low level of power is required to maintain this suspended state. How quickly your system power down into Standby mode is up to you by setting proper times in Power Options of Control Panel in Window. While the Mini-note is in Standby mode, the LED of power indicator flashes. To resume your working again, you can press the power button to return your work to the screen where you left off.

### ***Hibernation Mode***

In Hibernation mode, all system devices are powered down and the contents of RAM are stored on your hard drive. Hibernate mode uses less power than Standby mode, but takes a bit longer time to resume. When your Mini-note goes into hibernation, Windows saves your entire desktop state before powering down your Mini-note. You don't need to save and close each document before you put your Mini-note into hibernation. When you press power button again, system will bring your Mini-note out of hibernation. You'll find your applications and documents open on your desktop exactly as you left them.

### ***Shutdown***

All power has been turned off from the Mini-note. This means that no power including external AC power source and battery power source will be consume by the Mini-note.

## 3.6 Working with the Built-in HDD

Your Mini-note is equipped with a built-in large capacity 2.5 inch hard disk drive where you store and run your Mini-note's operating system and application software programs.

## 3.7 ExpressCard

### **INSERTING AND REMOVING A EXPRESSCARD**

---

Your Mini-note includes hot swapping capability, that allows you to exchange cards while the computer is turn on and start using it immediately.

#### ***Inserting ExpressCard***

To insert a ExpressCard into the ExpressCard slot:

1. Locate the ExpressCard slot cover on the right side of the computer.
2. Insert the side of ExpressCard into the ExpressCard slot. The face label of the card should also be facing up.
3. When the full length of the card is almost inside the slot, push firmly but slowly, to ensure full connection with the computer. The ExpressCard will be automatically detected, and once the needed driver is installed, it will generate a beep sound to indicate that the card is detected.



### ***Removing ExpressCard***

To remove a ExpressCard from the ExpressCard slot, you should first disable the ExpressCard card setting in the system as described followings:

1. Double click the **ExpressCard** icon on the right bottom side of the task bar.
2. Select the socket from the list that you want to remove, and click **Stop** button. The system then disables the function of ExpressCard card.
3. Then you can remove the inserted ExpressCard. To release the ExpressCard, just push the ExpressCard again to the end. Then the ExpressCard will automatically bounce off the ExpressCard slot.
4. When the ExpressCard has moved out a space out of the slot, hold the edges of the card and slowly slide it out.



**⚠** *The power consumption of ExpressCard/54 is about 2.1W, while the consumption of ExpressCard/34 is about 1.3W. To save energy, press the button to disconnect the card when it is not in use.*

## 3.8 Using Flash Memory Cards

### **FLASH MEMORY CARD**

---

Flash Memory is a memory storage media. It is used by most digital camera, Flash memory card is built with different form factor and brand name. The 4 in 1 card slot in this Mini-note supports following cards as SD, MS (Memory Stick), MMC, and MS\_Pro.

**⚠** *For a single moment, only one card can be inserted into the 4 in 1 card slot.*

### ***Inserting Flash Memory Card***

To insert a flash memory card into the slot, please pay more attention whenever insert the flash memory card into the slot with the correct side.

You should position the copper connector at the bottom side. All of these cards should be located at the center of the slots in inserting.

Only one correct side can be accepted for the 4 in 1 card slot. If you cannot insert the card into the 4 in 1 slot or you had inserted the card but it is not recognized by the computer, please remove the card and insert it again. To prevent the damage made both on card and the slot, never forced an entry into the slot with incorrect side.



### ***Removing Flash Memory Card***

To remove the flash memory card, you can pull out the card directly, there is no release button for flash memory slot.



# 4 Fun with Multimedia

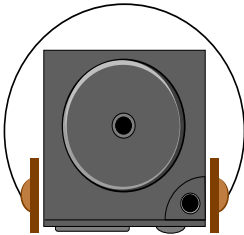

**T**his chapter lets you make full use of all the multimedia features of your Mini-note in having fun and excitement during work or leisure.

## 4.1 Multimedia Features

Your Mini-note is rich in multimedia features that make your computing fun, comfortable, exciting and easy. Your Mini-note is well able to perform all multimedia tasks through the following:

- Intel® Atom Processor
- Up to 2GB DDRII- SDRAM
- USB - Slim Combo Drive (optional)
- Provides blazing graphics embedded in the Intel 945 GSE chipset
- Full-duplex 16-bit stereo speaker with wavetable support. Sound Blaster compatible.

## 4.2 Audio Sound System Features

Your Mini-note has a built-in 16-bit stereo sound controller that allows you to record, store, and playback voice, music and other sound effects with built-in mixer controls. An integrated full-duplex microphone and twin mini-speakers are also built-in into your Mini-note to allow you to record and playback sound anytime and anywhere.

At the front side of your Mini-note, you will find the audio ports that include the following:

- External 1/8-inch microphone jack that connects external microphone for recording purpose.
- Earphone or headphone jack for personal listening.
- Sound volume adjust by K/B hot-key



## 4.3 Setting up the Audio Driver Properties

Before you can start using the audio capabilities of your Mini-note, you need first to setup properly the audio driver after installing Windows. If you bought your Mini-note with Windows pre-installed, it is most likely that your dealer have configured the sound driver for you. If not, you must refer to Chapter 2 on how to setup the sound drivers for Windows.

## 4.4 Windows Multimedia Programs

Windows provides several multimedia programs that you can run with the built-in features of your Mini-note. Pointing the **Start** button, **Programs**, **Accessories**, then **Entertainment**, you will find the Multimedia programs group. (The section below use Window XP as examples)

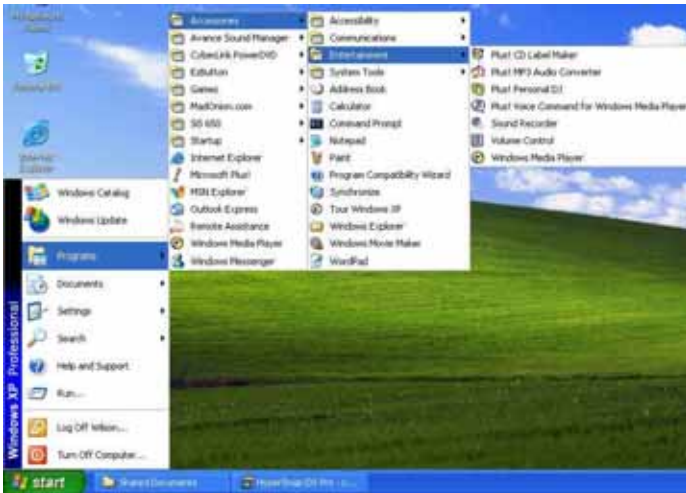

**Figure 4-1 Entertainment Programs Group**

The standard multimedia components are as follows:

- Windows Media Player - for playing sound, video and animation files
- Sound Recorder - for recording sounds and playback
- Volume Control - for adjusting the volume of mixer

***For more information on how to operate these multimedia components, run the program and click on the Help menu.***

## 4.5 Recording Sounds

Your Mini-note allows you to record voice and other sounds in several ways and stores them as files on your hard disk. These voice or sound files can then

be played back through the internal speaker or earphone jack using an external speaker, headphone, or earphone set. You can also use the files as voice annotations on many applications for more real presentation. This section will describe briefly how you can record sounds under Windows operating system.

To record sounds, you need to run the Sound Recorder program from the Multimedia program groups. The control buttons of the Sound Recorder are simple to understand which comprise of the Fast Rewind, Fast Forward, Play, Stop, and Record buttons. Click the Help menu on how to operate the Sound Recorder.



**Figure 4-2 Sound Recorder**

The Sound Recorder also allows you to record sound from different input audio source like the following:

- From the external microphone
- From the USB - Slim Combo Drive (optional)

Since you could record sound from different input sources, you must first set the proper audio input recording device under the Recording Control panel. To do this:

1. Double-click on the Volume Control on the taskbar or click Start button, then point to Programs, Accessories, Entertainment and then click on Volume Control.

2. Click **Properties** in the Options main menu.
3. Click the round button for Recording and tick off each component that list in the "Shows the following Volume Controls" box.

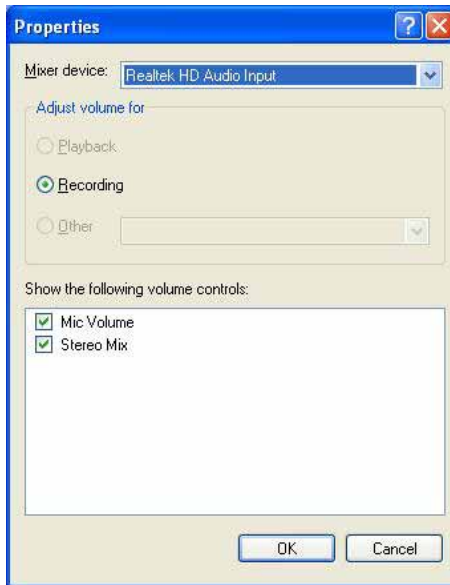

**Figure 4-3 Audio Properties**

4. Click OK and the Recording Control dialog box will appear. Here, you will select the input device for the recording source. If you want to record from the USB - Slim Combo Drive (optional) with audio music, you must click on stereo mix.

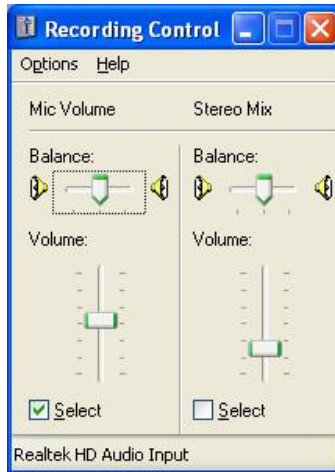

**Figure 4-4** Recording Volume Control

## **USING AN EXTERNAL MICROPHONE**

---

Your Mini-note allows you to connect an external microphone for high quality recording. The external microphone jack is found on the front side of your Mini-note. Use only microphone with 1/8-inch mini-jack connector. Follow the same procedure for recording voice.

## **4.6 Playing Audio and Sound**

Your Mini-note has built-in twin speakers to playback audio and sound. You can also adjust the volume manually by adjusting the volume control hotkeys found on the keyboard.

For more quality sound output, you can choose to connect an external amplified speaker or earphone from headphone jack. Always minimize the volume first before placing the phone set to your ear.

## **USING THE WINDOWS MEDIA PLAYER**

---

The easiest way to playback multimedia media files is to run the Windows Media Player. Follow these steps:

1. Click on **Start**, point to **Programs, Accessories**, and then **Entertainment**.
2. Click on **Windows Media Player** to start program.
3. Click on the File menu and select the file you want to play.
4. When the file is recognized and open, click on the **Play** button to start playback.

## 4.7 Playing Video and MPEG Files

Your Mini-note is capable of running video motion files as well as MPEG (Motion Picture Expert Group) files on CD, DVD, or CD-RW. By using software MPEG program, you can watch real full-motion picture on your Mini-note. You can also run the Windows Media Player under the Entertainment programs group as well to show all media device programs.

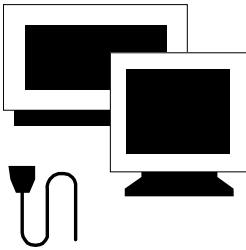

**Figure 4-6** Windows Media Player

This page is intended to be blank.



# 5 Connecting to Peripherals



**T**his chapter describes how you attach additional peripheral devices to your Mini-note. The Mini-note allows you to add a printer or mouse; connect an external monitor and keyboard, or other compatible peripheral device. Use of additional devices is described in this chapter.

## 5.1 Using the USB Port

USB (Universal Serial Bus) is a hardware interface that enables you to connect multiple devices (such as printers, mice, keyboards, storage devices, joysticks, digital cameras, and video conference cameras, etc.) to your Mini-note, and up to 127 devices can be attached. Besides, USB's hot swap capability allows everything to be plugged in and unplugged without turning the system off.

Microsoft, HP, Compaq, Intel, Agere, NEC and Philip are seven core members of USB-IF to have worked on USB 2.0 standardization. USB 2.0 offers data transfer rate up to 480Mbps (megabits per second) compared to USB 1.1 devices, which transfer at speeds of 12Mbps. So, you could know that USB 2.0 can transfer data between the Mini-note and its peripherals 40 times faster than USB 1.1. However, USB 2.0 is fully backward compatible, you will be able to use a USB 1.1 device in a USB 2.0 compliant system.



- ⌘ ***Depending on your operational requirements, you may need to disable other ports in order to release system resource for the USB port.***
- ⌘ ***The USB bus distributes 0.5 amps (500 milliamps) of power through each port. For the purpose of power saving, please disconnect your USB device while not in use.***

## 5.2 Using an External Monitor Port

Your computer has a 15-pin Monitor port for supporting any external CRT or LCD color monitor. You need a display signal cable (usually provided with the monitor). One end of the cable must have a 15-pin connector for the system.

To connect an external monitor:

1. Turn off your computer and make sure the monitor power switch is turned off.

**⚠ *The notebook computer must be powered off or suspended while the monitor is being connected. Although you can connect the external Monitor without power off the computer and the external monitor, however, it is harmful to both devices and it shortens the life of these devices.***

2. Connect the connector cable of the monitor to the VGA port at the back of your computer.
3. Connect the monitor power cable and plug it into a properly grounded wall outlet.
4. Turn on the power of the monitor.
5. Turn on your computer. Both the LCD panel and the monitor screen will show the display. Your computer is set at default to run at simultaneous display mode.
6. If you only want to show the display on the external monitor or projector and shut off the LCD display, you can use the <Fn> + <F3> hot-key to switch display type between LCD and external monitor. Keep pressing the hot-key until you get the display to external monitor only.



**☞ Refer to Chapter 3 regarding the possible External CRT resolutions and how to change the display properties.**

## 5.3 Using the External Audio System

At the front side of your Mini-note, you will find the built-in audio ports. You can connect Microphone jacks, earphone or powered speaker.

To connect to an audio jack:

1. Locate the audio port (Microphone, Headphone) that you want to use to the target device.
2. Plug the jack into the port on the front side of the system.

**☞ If you use external speaker and experience the sound distortion or feedback, please lower the volume. Some factors is caused by too close locating the microphone and speaker from each other, moving away the external audio option from the unit may also help.**

## 5.4 Using the LAN Port

This Mini-note comes with an internal 10Base-T/100Base-TX LAN and 1000Mbps (Option) module that connects your Mini-note to other

notebook/networks through a local area network (LAN) and supports data transfer rates at 10Mbps and can be up to 100Mbps. The 10Base-T standard also called Twisted Pair Ethernet is connected with RJ-45 connectors. The 100Base-TX is based on the older Ethernet standard. Because it is 10 times faster than Ethernet, it is often referred to as Fast Ethernet.

The built-in LAN module provides a standard RJ-45 connector.

To connect the twisted-pair cable to your LAN port:

1. Locate the twisted-pair cable in the accessories box in Mini-note shipping carton. Each end of the cable has a RJ-45 connector.
2. Connect one end of the cable into the network wall outlet or HUB.
3. Connect the other end of the cable into the Mini-note RJ-45 LAN port.



## 5.5 Using the Wireless LAN

Wireless LAN lets user connect to the LAN environment without using any wire to traditional RJ-45 jack. User can enjoy the wireless connection within the range of Access Point (AP) of LAN.

Access Point (AP) is the wireless transmission and receiving device, it generally connects to the server of a LAN environment or act as a LAN hub with wireless connection. Access point can be set in an office environment, airport, major railway station, etc. that depends on the construction of each country. In most case, you probably can use it at office, please consult with the network department of your company for more details.

This Mini-note integrates built-in 802.11b/g or 802.11 b/g/n wireless LAN module. IEEE 802.11b standard supports 11 Mbps wireless connection speed. However, IEEE 802.11g supports 54Mbps wireless connection speed, and is backward compatible with the slower 802.11b. IEEE 802.11n uses MIMO Technology. Wireless LAN module is similar to LAN module. You need to install software driver before using it. Please refer to chapter 2.5 on how to install the driver.

# 6 Customizing Your Mini-note

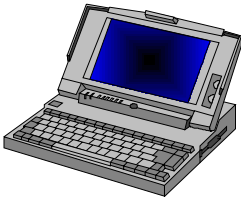

**Y**our Mini-note uses the Phoenix BIOS Setup program allowing your system configuration to be altered to best suit your computing needs: User-adjustable options include system time and date, disk drive configuration and password setup.

BIOS information stored in the CMOS RAM will remain permanent unless changed. Default factory settings are used to optimize performance of your Mini-note and do not need further alteration to operate your Mini-note. Use caution when changing any BIOS settings.

## 6.1 Running the BIOS Setup Program

Your Mini-note is setup and pre-configured. The Mini-note's BIOS (Basic Input-Output System) Setup program may be used to change system configuration information such as the current date and time, or your hard disk drive type. The Setup program can be accessed when you power on the system and pressing the <F2> function key before the Microsoft® Windows® operating system begins.

The settings that you specify within the Setup program are recorded in a special area memory called the **CMOS RAM**. This memory is backed up by a battery so that it will not be erased when you turn off or reset the system. Whenever you turn on the Mini-note, the system will read the settings stored in the CMOS RAM and compare them to the equipment check conducted during the Power On Self Test (POST). If an error occurs, an error message will be displayed on the screen, and you will then be prompted to run the Setup Program.

Press the <F2> key to run the BIOS Setup program. The BIOS Setup program is organized into five menus which you can select using the <--> and <--> keys. To move from one option to another, you use the up and down arrow keys while using the <F5> and <F6>, or <+> and <-> keys to change the settings. On the right hand side of the screen are some brief help descriptions of each item you want to change.

On the BIOS Setup program, you will find the following parts on the screen:

- **Item Specific Help**  
The right side of the screen. This area describes each parameter and its available settings.



- **Menu Bar**  
The top line of the screen. Each of the five selections displays its own screen.
- **Parameters**  
The left side of the screen. This area lists the parameters and their current settings.
- **Key Status Bar**  
The bottom part of the screen. These lines display the keys available to move the cursor, select a particular function and so forth.

To exit the BIOS Setup program, simply press the <Esc> key and select from the Exit menu whether you want to Save Changes, Discard Changes, and Exit Discard Changes.

## 6.2 Using the Main Menu Setup

Phoenix BIOS Setup Utility				
Main	Advanced	Security	Boot	Exit
System Time: [07 :54 :32] System Date: [10/28/2008]  BIOS revision: IMB05  IDE Channel 0 Master FUJITSU MHZ2120BH G2-(S1)  CPU Type: Intel (R) Atom(TM) CPU N270 CPU Speed: 1600 MHz  System Memory: 640 KB Extended Memory: 1038336 KB				Item Specific Help  <Tab>, <Shift-Tab>, or <Enter> selects field.
<b>F1 Help</b>	<b>↑ ↓ Select Item</b>	<b>- / + Change Values</b>	<b>F9 Setup Defaults</b>	
<b>Esc Exit</b>	<b>← → Select Menu</b>	<b>Enter Select Sub-Menu</b>	<b>F10 Save and Exit</b>	

- System Time  
 Allows you to change the system time using the hour:minute:second format of the .  
 Enter the current time for reach field and use the <Tab>, <Shift>+<Tab>, or <Enter> key to move from one field or back to another.  
 You can also change the system time from your operating system.

- **System Date**  
Allows you to set the system date using the month/date/year format. Enter the current time for each field and use the <Tab>, <Shift>+<Tab>, or <Enter> key to move from one field or back to another.  
You can also change the system time from your operating system.
- **IDE Channel 0 Master**  
This field is for information only as the BIOS automatically detects the storage media.
- **CPU Type**  
This field reports the CPU type information detected by the BIOS during Power-On Self-Test (POST).
- **CPU Speed**  
This field reports the CPU speed information detected by the BIOS during Power-On Self-Test (POST).
- **System Memory**  
This field reports the amount of base (or conventional) memory found by the BIOS during Power-On Self-Test (POST).
- **Extended Memory**  
This field reports the amount of extended memory found by the BIOS during Power-On Self-Test (POST).
- **BIOS Revision**  
This field is for information only as the BIOS displays the BIOS version during the Power-On Self-Test (POST).

## 6.3 Using the Advanced CMOS Setup

Phoenix BIOS Setup Utility				
Main	Advanced	Security	Boot	Exit
			Item Specific Help	
Legacy USB Support	[Enabled]		Enable support for	
USB – Device 29, Function 7:	[Enabled]		Legacy Universal Serial	
Boot-time Diagnostic Screen:	[Disabled]		Bus	
Total Graphics Memory	[MaxDVMT]			
DVMT Graphics Memory	216MB			
Energy Star Support	[Enabled]			
<b>F1 Help</b>	<b>↑↓</b>	<b>Select Item</b>	<b>- / +</b>	<b>Change Values</b>
<b>F9 Setup Defaults</b>				
<b>Esc Exit</b>	<b>←→</b>	<b>Select Menu</b>	<b>Enter</b>	<b>Select Sub-Menu</b>
			<b>F10 Save and Exit</b>	

- Legacy USB Support  
Enable or Disable the Legacy Universal Serial Bus support
- USB – Device 29, Function 7  
Enable or Disable the USB 2.0 controller support.
- Boot-time Diagnostic Screen  
Lets you choose display or not display the diagnostic screen during system boot.

- **Total Graphics Memory**  
Lets you select total graphics memory size for internal graphics device.  
The Options are 64MB,128MB and MaxDVMT
- **DVMT Graphics Memory**  
Display DVMT graphics memory size
- **Energy Star Support**  
Lets you activate or inactivate the function of Energy Star Support.

## 6.4 Security Menu Setup

Phoenix BIOS Setup Utility				
Main	Advanced	Security	Boot	Exit
			Item Specific Help	
Supervisor Password Is:		Clear	Supervisor Password controls access to the setup utility.	
User Password Is:		Clear		
Set Supervisor Password		[Enter]		
Set User Password		[Enter]		
Password on boot		[Disabled]		
<b>F1 Help</b>	<b>↑ ↓ Select Item</b>	<b>- / + Change Values</b>	<b>F9 Setup Defaults</b>	
<b>Esc Exit</b>	<b>← → Select Menu</b>	<b>Enter Select Sub-Menu</b>	<b>F10 Save and Exit</b>	

- Supervisor Password Is  
Set/Clear selections show that the Mini-note is under controlled by Supervisor Password or not.
- User Password Is  
Set/Clear selections show that the Mini-note is under controlled by User Password or not.
- Set Supervisor Password  
Supervisor password gives you the authority in accessing the setup utility. You also need to enter this password in system booting and resuming from suspend mode. When you press <Enter> in this field, the Set Supervisor Password dialog box appears. Enter a new password with up to 8 alpha-numeric characters, and then re-enter it for confirmation.

- Set User Password  
Enter the user password when boot the system or resume from suspend mode.
- Password on Boot  
If you set this field to Enabled, your Mini-note will always ask for the password every time you boot your .

## 6.5 Using the Boot Setup

This item allows you to set the search drive sequence where the system will try to boot up first.

Phoenix BIOS Setup Utility				
Main	Advanced	Security	Boot	Exit
LAN BOOT: [Disabled]			Item Specific Help	
<p><b>Boot priority order</b></p> <p>1: USB FDC:</p> <p>2: USB CDROM:</p> <p>3: USB KEY:</p> <p>4: USB HDD:</p> <p>5: IDE HDD: FUJITSU MHZ2120BH G2-(S1)</p> <p>6: PCI BEV</p>			Enable LAN boot.	
F1 Help	↑ ↓	Select Item	- / +	Change Values
F9 Setup Defaults	F10 Save and Exit			
Esc Exit	← →	Select Menu	Enter	Select Sub-Menu

- LAN Boot  
Lets you Enable or Disable the LAN boot function.

- Boot priority order  
This item allows you to set the search drive sequence where the system will try to boot up first.  
To select the boot device, you can use the up or down arrow key, then press <+> to move up the device in the list or press <-> to move down the device in the list. To exit from this menu, press <Esc>.

## 6.6 How to Exit the Setup Program

There are two choices to escape from the Setup program.

Phoenix BIOS Setup Utility							
	Main	Advanced	Security	Boot	Exit		
	Exit Saving Changes Exit Discarding Changes Load Setup Defaults Discard Changes Save Changes				Item Specific Help Exit System Setup and save your changes to CMOS.		
F1	Help	↑ ↓	Select Item	- / +	Change Values	F9	Setup Defaults
Esc	Exit	← →	Select Menu	Enter	Select Sub-Menu	F10	Save and Exit

- Exit Saving Changes  
Saves all changes to CMOS while running the BIOS setup program and exit from the system setup program.



- **Exit Discarding Changes**  
Allows you to discard all changes made while running the BIOS setup program and exit from the system setup program.
- **Load Setup Defaults**  
Lets you load the default values for all setup items.
- **Discard Changes**  
Reverts to previously selected settings.
- **Save Changes**  
Saves Setup data to CMOS.

## 6.7 How to Upgrade the BIOS

Your Mini-note uses EPROM Flash BIOS chip that allows you to easily upgrade the BIOS program. When you update the BIOS, any customized settings you made are lost.

To upgrade the BIOS:

1. Put in the BIOS Update data into the USB device.
2. Power on the system with the diskette in the diskette drive.
3. On the DOS prompt, type the following command.

```
A:\>Phlash XXXXXX.ROM (BIOS filename) or  
A:\>XXXXXX.BAT (Batch file for BIOS file)  
Press <Enter> to run this BIOS utility. After the system has been  
successfully run this program, a message similar to the following appears:
```

```
Flash memory has been successfully programmed,  
press any key to restart the system. If the  
system does not restart, turn it off, then turn  
on again.
```

4. Press any key to restart this system.

Contact your dealer for the latest BIOS update file.

# 7 Using Options

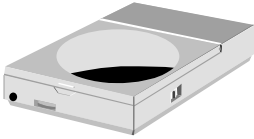

**T**his chapter describes the advanced features and expandable architecture in your Mini-note.

## System Upgrade

This section provides some steps in doing system upgrade for your Mini-note. The upgrade procedures include the following:

***∞ Before installing or replacing memory module, be sure to turn off power, remove battery pack and prohibit any hot plug.***

### 7.1 Memory Upgrade

Your Mini-note offers 200-pin SODIMM (Small Outline Dual Inline Memory Module) at least 512MB DDR-SDRAM. The memory compartment is located inside your computer.

***∞ Please contact dealer for changing or adding DDR2-SDRAM module. It is not available for users to change it by themselves.***

#### **INSTALLING MEMORY MODULE**

---

Your computer comes with standard 512MB or 1024MB of synchronous DDR2 SO-DIMM.

The 512MB and 1024MB memory modules are available:

To install the memory module:

1. Make sure the system is powered off, the battery also is removed and that no peripheral devices are attached.
2. Turn the computer upside-down and locate the screws that secure the back cover at the underside of the notebook.

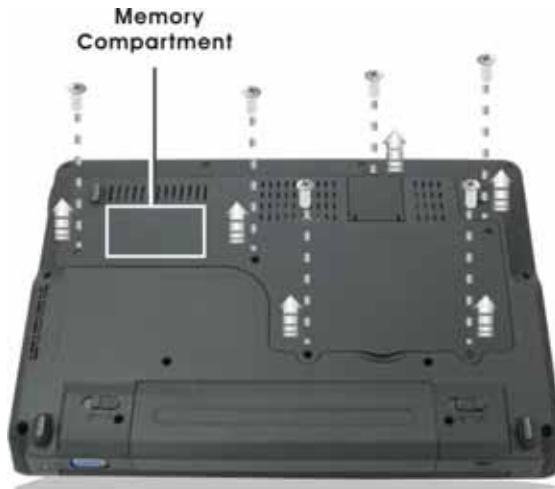

3. Locate the memory module into the empty memory module sockets. (Your system comes with one memory module already installed in the socket.)

***Notice : Avoid touching the exposed components inside the system. Doing so may damage the system***

4. Insert the connector of the memory module into the socket. Make sure the notch of the memory module fits the nose of the socket.
  - Hold the memory module at a 30-degree angle and push its connector into the memory socket of the notebook.
  - Press down on the edge of the memory module until the locking tabs on both sides is locked.
5. Put the DIMM door back and secure the screw on the DIMM door.
6. Turn the system over.

To remove a memory module, push the locking tabs aside from the memory module until the module pops up. Then, remove the memory module.

## 7.2 Hard Disk Upgrade

Your Mini-note computer offers one 2.5" format, 9.5mm height hard disk. If the volume does not fit your need or it is crashed, you can upgrade it by replacing with new hard disk. Please do the following steps to change it.

1. Remove the screw and open the cover by lifting its upper side cover.

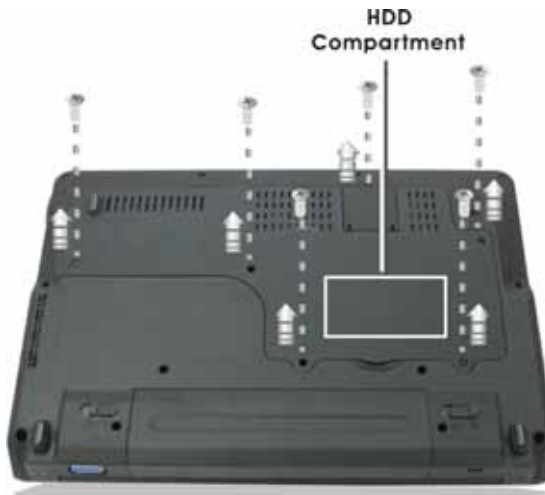

2. Take out the hard disk from the compartment by finger carefully
3. Remove the screws and connector from the hard disk gently-
4. Remove the crane screws located at each side of the hard disk.
5. Rotate and tighten the crane screws to the new hard disk.
6. Attach the connector to the new hard disk precisely.

7. Place the hard disk back to the compartment.
8. Cover the lid, then rotate and tighten the screws.
9. Set the boot device as DVD/CD-RW Combo drive and Primary Master as Auto on BIOS setup menu. Please refer to Chapter 6 about the setting of BIOS setup menu. Then, boot the system by using WinXP CD-ROM and the system will detect the hard disk automatically and prompt you how to format the new disk.

**⚠ Please tighten the screws located at each side of the hard disk before operating the hard disk. Any vibration may cause damage for the running hard disk.**

**⚠ Please contact dealer or certified technician for changing the hard disk drive. The damage of changing HDD resulting from users may not be under warranty**

## 7.3 Wireless Module Installation

This Mini-note uses Mini-PCI Card Wireless LAN module for wireless connection. It provides two compartments for installing IEEE 802.11b/g half PCI-E Mini Card and IEEE 802.11b/g/n Full PCI-E Mini Card to meet your specific requirements.





# 8 Caring for Your Mini-note



**Y**our Mini-note the latest features in mobile computing and multimedia technology. If properly cared for and maintained, the performance and reliability of the Mini-note can be greatly prolonged.

## 8.1 Important Safety Instructions

This section gives you detailed information about how to maintain a safe working environment while using the Mini-note. You can maintain its condition and performance by following these guidelines. Please read it carefully to ensure maximum safety.

- Before cleaning the Mini-note, make sure it is disconnected from any external power supplies (i.e. AC adapter, car adapter and so on).
- When cleaning, do not use liquid or spray detergent for cleaning. Instead, use moisture sheet or a cloth for cleaning.
- The socket-outlet shall be installed near the Mini-note and shall be easily accessible.
- Please keep the Mini-note away from humidity.
- Lay the Mini-note on a reliable flat surface when operating. A drop or fall may cause injury.
- The openings on the enclosure are for air convection hence the Mini-note can be protected from overheating. **DO NOT COVER THE OPENINGS.**
- Be careful of using power supply. The Mini-note has specific power requirements.
- Use only a power adapter approved for use with this Mini-note.
- While unplugging the power cord, disconnect it by the plug head, not by its wire.
- Make sure the socket and any extension cords you may use can support the total current load of all the connected devices.

- Though your AC adapter is suitable for universal international voltage, it still requires a stable and continual power supply. Make sure the voltage of the power source when connect the Mini-note to the power outlet. If your are not sure of your local power specifications, consult your dealer or local power company.
- Place the power cord in such a way that people can not step on it. Do not place anything over the power cord.
- All cautions and warnings on the Mini-note should be noted.
- If the Mini-note is not in use for a long time, disconnect it from mains to avoid possible damage by transient over-voltage.
- Never pour any liquid into openings as this may cause fire or electrical shock.
- Never open the body of Mini-note. For safety reason, the Mini-note should only be opened by qualified service personnel.
- If one of the following situations arises, have the Mini-note checked by service personnel:
  - The power cord or plug is damaged.
  - Liquid has penetrated into the Mini-note.
  - The Mini-note has been exposed to moisture.
  - The Mini-note has not worked well or you can not get it work according to user's manual.
  - The Mini-note has dropped and damaged.
  - The Mini-note shows signs of breakage.
- Do not leave or store this Mini-note in an environment unconditioned. Storage temperature above 60°C (140°F) may damage the Mini-note.

- An approved power cord has to be used for the Mini-note power supply. For a rated current up to 6A and an equipment weight more than 3kg, a power cord not lighter than H05VV-F, 2G, 0.75mm<sup>2</sup>, has to be used.
- To avoid any damage to the internal device, please disconnect the AC adapter first and remove the battery pack from the Mini-note when replacing any internal device.

## 8.2 Cleaning Your Mini-note

When it is necessary to clean the plastic case and keyboard, use a soft, lint-free cloth, slightly dampened with a mild detergent solution or use the contents of any commercially available Mini-note cleaning kit.

Never use alcohol, petroleum-based solvents, or harsh detergents to clean the Mini-note. Also never spray any liquids directly on the Mini-note case, keyboard, or screen. If the liquid-crystal display (LCD) screen has become smeared or dusty, clean the screen by first applying a mild glass cleaner to a soft, clean, lint-free cloth, and gently wipe the glass. Never apply liquids directly on the screen surface. Moreover, do not use paper towels to clean the display screen. Paper can scratch the display screen matte.

## 8.3 Maintaining the LCD Quality

When it comes to screen problems, heat plays a significant role. After a typical working session, users routinely close the Mini-note the cover. The display surface - no matter what type it is - and the components inside the Mini-note radiate heat; when you close the cover, you trap the heat against the screen. To help prolong the life of your Mini-note, leave the cover open for ten minutes to let the heat disperses.

You should also enable the power management of your Mini-note to turn off the LCD power and display when the system is inactive for some time.

Adding a screen saver also helps prolong the life of your Mini-note screen.

Follow the safety guidelines mentioned earlier and how to clean your Mini-note.

## 8.4 Maintaining Your Hard Disk

Losing your data has the same consequences as a system break down. Users must make it a habit of doing hard disk maintenance every week or so. Here is some maintenance you could do:

- Always back up your data files from your hard disk.
- Install the virus detecting program to monitor virus that could tamper your files.
- Use SCANDISK occasionally to correct any errors found in the directory and File Allocation Table. This will also free up space from any unused sectors.
- Never move or raise the Mini-note while the hard disk is being accessed, most especially don't jar the hard disk as this may cause a hard disk crash.
- Use hard disk maintenance programs like **Disk Defragmenter** of Windows. These reorganize your hard disk by eliminating fragmentation and improving your hard disk access time.
- Install a system password in your Mini-note so others won't be able to use the hard disk.

## 8.5 Battery Care Guidelines

The battery pack sold with the Mini-note requires reasonable care and handling to ensure efficient operation and maximum life. There is a risk of fire and chemical burn if the battery pack is handled improperly.

To ensure that the battery pack endures normal life cycle, always observe the following precautions when handling the battery pack:

- Handle batteries carefully. Do not try to disassemble, crush, puncture, open, drop, mutilate, short external contacts, disposed of in water or fire, or expose it to temperatures higher than 45°C.
- Recharge batteries only as described in this manual and only in ventilated areas. Never use an external charger other than the one supplied with your Mini-note.
- Do not leave batteries in hot locations for more than a day or two.
- Do not leave your battery in your Mini-note for longer than 1 month without plugging in the power adapter.
- Do not leave battery in storage for more than 2 months without recharging it to prevent over discharge. Over discharge will hurt the battery
- Dispose dead battery properly to protect the environment. The batteries contain hazardous chemicals and should not be thrown out with household or office trash.
- You should always discharge your battery before recharging it on either of these two conditions: first, this is the first time you start to use your battery; second, you had not charge the battery for more than 2 months.

## 8.6 When You Travel

For safety and convenience when traveling, please follow these instructions:

- Back up all needed files on your hard disk before traveling.
- Recharge your battery overnight to ensure full battery power before you leave.
- Don't forget to bring along the AC adapter and extra battery pack.
- Try to bring backup software as well.
- Check the voltage rating and the outlet type of your destination. If the power cord of the adapter is different, then you need to purchase a suitable one. Consult your dealer.
- Carry your Mini-note in its carrying case or in a briefcase. Never check-in the Mini-note as a luggage.
- Remember to apply those power saving features and techniques to save battery power.

This page is intended to be blank.



# APPENDIX A

## System Specification

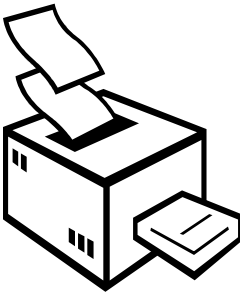

**T**his appendix provides technical specifications for the Mini-note.

## System Specification

### **PROCESSOR UNIT**

---

- Intel® Atom microprocessor
- 1.6 GHz CPU, FSB 533MHz
- 512KB integrated L2 cache for the processor

### **SYSTEM MEMORY**

---

- One 200-pin memory slot
- 512MB and 1024MB memory modules using 200-pin SODIMM
- DDR2 – 533/667 SDRAM modules
- Maximum memory size 2GB

### **LCD DISPLAY**

---

- 10.1" WSXGA (16:10) Color TFT LCD, 1024 x 600
- Maximum 16M true colors on all LCD display

### **VGA SYSTEM**

---

- Integrated Intel 945 GSE graphic engine
- Simultaneous LCD and external monitor (CRT) display
- Maximum 16 million colors on LCD display at 1024 x 600 resolution (CRT only) for 10.1" LCD

- Maximum 16 million colors on external monitor or projector at 1600x1200 resolution (Non-Interlaced)

## **STORAGE**

---

- 2.5" Format 9.5 mm High SATAII HDD Module; Bus Mastering, Ultra DMA ATA-300 Support for LBA Scheme
- Support system boot from external USB device
- 4-in-1 (SD, MS, MMC, and MS\_Pro) card reader

## **AUDIO SYSTEM**

---

- Compliant with Intel HD Audio (Azalia 2 channels)
- H/W Audio Sound Blaster 16 compatible
- Built-in dual speakers
- Audio input jacks for microphone (MIC)
- Audio output jack for external speaker or headphone (Line-Out)
- Sound volume adjust by K/B Hot-Keys

## **EXPRESSCARD**

---

One 34mm, PCI-ExpressCard slot

## **WEBCAM**

---

One Webcam with USB2.0 CMOS 1.3M pixel

## **TOUCHPAD**

---

Integrated Touchpad (Serial/USB mouse) pointing device with 2 click buttons

## **KEYBOARD**

---

- Full-sized 83-keys keyboard with Windows systems hot-keys, inverted T-cursor keys, 10 hot keys, 12 function keys, and embedded numeric keypad
- Provides international language keyboard

## **FLASH BIOS**

---

512K Flash ROM BIOS for easy BIOS upgrade

## **I/O PORTS**

---

- 1 x VGA port
- 2 x Universal Serial Bus (USB 2.0)
- 1 x 10Base-T/100Base-TX LAN port (1G Option)

## **WIRELESS DEVICES**

---

- IEEE 802.11b/g, Half Mini-PCI card
- Bluetooth, USB Interface
- IEEE 802.11b/g /n, Full Mini Card or USB Interface

## **AC/DC POWER SUPPLY ADAPTER**

---

Universal auto-switching (100V~240V) 40W adapter, 20 Volt

## **BATTERY**

---

- Rechargeable 4 Cells Li-ion battery pack with Smart Battery function
- Approximately 4.5 Hours (for 4 Cells) Battery Life (for Battery Mark)

## **WEIGHT AND DIMENSION**

---

- 263 (W) x 185 (D) x 19.6 ~ 27 (H) mm
- Approximately 1.3 kg

This page is intended to be blank.