

# **Daria SVE00 Netbook User Guide**



**Copyright©2009**

**All Rights Reserved - Printed in Taiwan**

Daria SVE00 Netbook User Guide

Original Issue: 2009/12

This manual guides you in setting up and using your new netbook. Information in this manual has been carefully checked for accuracy and is subject to change without notice.

No part of this manual may be reproduced, stored in a retrieval system, or transmitted, in any form or by any means, electronic, mechanical, photocopy, recording, or otherwise, without prior written permission.

## **Trademarks**

Product names used herein are for identification purposes only and may be the trademarks of their respective companies.

Microsoft, Windows 7, Windows XP, Windows Vista, and Windows Sound System are trademarks of Microsoft Corporation.

Intel ®, Intel ® Atom, Intel ® HD Audio (Azalia) are registered trademark of Intel Corporation.

Sound Blaster, Sound Blaster Pro are trademarks of Creative Technology.

All other brands or product names mentioned in this manual are trademarks or registered trademarks of their respective companies.

---

## **FCC Compliance Statement**

This equipment has been tested and found to comply with the limits for a class B digital device, pursuant to part 15 of the FCC Rules. These limits are designed to provide reasonable protection against harmful interference in a residential installation.

This equipment generates uses and can radiate radio frequency energy and, if not installed and used in accordance with the instructions, may cause harmful interference to radio communications. However, there is no guarantee that interference will not occur in a particular installation. If this equipment does cause harmful interference to radio or television reception, which can be determined by turning the equipment off and on, the user is encouraged to try to correct the interference by one or more of the following measures:

- Reorient or relocate the receiving antenna.
- Increase the separation between the equipment and receiver.
- Connect the equipment into an outlet on a circuit different from that to which the receiver is connected.
- Consult the dealer or an experienced radio/TV technician for help.

### **CAUTION:**

Any changes or modifications not expressly approved by the party responsible for compliance could void the user's authority to operate the equipment.

This device complies with Part 15 of the FCC Rules. Operation is subject to the following two conditions:

1. This device may not cause harmful interference and
2. This device must accept any interference received, including interference that may cause undesired operation.

### **RF exposure warning**

---

This equipment must be installed and operated in accordance with provided instructions and must not be co-located or operating in conjunction with any other antenna or transmitter. End-users and installers must be provide with antenna installation instructions and transmitter operating conditions for satisfying RF exposure compliance.

SAR Value: 0.00603 W/kg

## **FCC Declaration of conformity**

Model No. : Daria SVE00

Responsible party: First International Computer, Inc.

Address: No. 300, Yang Guang St., Nei Hu, Taipei, Taiwan.

Telephone No.: 886-8751-8751

This device complies with Part 15 of the FCC Rules. Operation is subject to the following two conditions:

## **Canadian Department of Communications Compliance Statement**

The Class B digital apparatus meets all requirements of the Canadian Interference Causing Equipment Regulation.  
Cet appareil numérique de la class B respecte toutes les exigences du Règlement sur le matériel brouilleur du Canada.

## 電波障害自主規制について

この装置は、情報処理装置等電波障害自主規制協議会（VCCI）の基準に基づくクラスB情報技術装置です。この装置は、家庭環境で使用することを目的としていますが、この装置がラジオやテレビジョン受信機に近接して使用されると、受信障害を引き起こすことがあります。取扱説明書に従って正しい取り扱いをしてください。

## **European Notice**

---

For the following equipment: Notebook PC



It is herewith confirmed to comply with the requirements set out in the Council Directive on the Approximation of the Laws of the Member States relating to Electromagnetic Compatibility (2004/108/EC), Low-voltage Directive (2006/95/EC) and the Amendment Directive (93/68/EEC), the procedures given in European Council Directive (1999/5/EC) and (2004/108/EC).

The equipment was passed. The test was performed according to the following European standards:

EN55022: 2006 + A1: 2007

EN61000-3-2: 2006

EN61000-3-3: 1995 + A1: 2001 + A2: 2005

EN55024: 1998 + A1: 2001 + A2: 2003

IEC61000-4-2: 1995 + A1: 1998 + A2: 2000;

IEC61000-4-3: 2006; IEC61000-4-4: 2004;

IEC61000-4-5: 2005; IEC 61000-4-6: 2003 + A1: 2004 + A2:2006;

IEC61000-4-8: 1993 + A1: 2000; IEC6100-4-11: 2004

EN 301 489-1 V1.8.1:2008; EN 301 489-17 V1.3.2: 2007

EN 300 328 V1.7.1 (2006-10)

EN 50392: 2002

EN 60950-1:2001

## **Regulatory statement (R&TTE)**

European standards dictate maximum radiated transmit power of 100mW EIRP and frequency range 2.400-2.4835GHz;

In France, the equipment must be restricted to the 2.4465-2.4835GHz frequency range and must be restricted to indoor use.

Operation of this device is subjected to the following National regulations and may be prohibited to use if certain restrictions should be applied.

You are cautioned that changes or modifications not expressly approved by the party responsible for compliance could void your authority to operate the equipment.

## **Important Safety Instructions**

This section gives you detailed information about how to maintain a safe working environment while using the Notebook (Laptop). You can maintain its condition and performance by following these guidelines. Please read it carefully to ensure maximum safety.

1. Please read these safety instructions carefully.
2. Please keep this User manual for later reference.
3. Please keep this equipment from humidity.
4. Do not use this product near water, for example, near a bathtub, wash bowl, kitchen sink or laundry tub, in a wet basement or near a swimming pool.
5. Avoid using a telephone (other than a cordless type) during an electrical storm. There may be a remote risk of electric shock from lightning.
6. Do not use the telephone to report a gas leak in a vicinity of the leak.
7. Lay this equipment on a reliable surface when install. A drop or fall could cause injury.
8. All cautions and warnings on the equipment should be noted.

- 
9. Do not operate the Notebook (Laptop) with the cover removed. For safety reason, the equipment should only be opened by qualified service personnel.
  10. Always disconnect all telephone lines & all power cords from the wall outlet before servicing or disassembling this product. To reduce the risk of personal injury from electrical shock or hot surfaces, disconnect the power cord from the wall outlet, and allow the internal system components to cool before touching.
  11. Refer your system for servicing to qualified service personal under the following conditions:
    - When the power cord or plug is damaged or frayed.
    - If liquid has been spilled into the product.
    - If the product has been exposed to rain or water.
    - If the product does not operate normally when the operating instructions are followed. Adjust only those controls that are covered by the operating instructions, since improper adjustment of other controls may result in damage and will often require extensive work by a qualified technician to restore the product to normal condition.
    - If the product has been dropped or the cabinet has been damaged.
    - If the product displays a distinct change in performance, it indicates a need for service.
    - If the equipment has obvious sign of breakage.
  12. The unit can be operated at maximum ambient temperature of 35°C.
  13. Li-Ion battery is vulnerable, do not charge it with other power adapter, or it may cause fire or explosion
  14. This product should be operated from the type of power indicated on the marking label. If you are not sure of the type of power available, consult your dealer or local power company.
  15. Use only a power adapter approved for use with this Notebook (Laptop).
  16. Do not install near any heat sources such as radiators, heat registers, stoves, or other apparatus (including amplifiers) that produce heat.
-

17. If the Notebook (Laptop) is not in use for a long time, disconnect it from mains to avoid possible damage by transient over-voltage.
18. The risk of ignition caused by small metallic objects, such as paper clips or staples, moving around inside TRANSPORTABLE EQUIPMENT during transportation shall be reduced objects entering the equipment, please do not remove dummy card from the product.

## **Installation Restrictions**

1. If an extension cord is used with this product, make sure that the total ampere rating of the equipment plugged into the extension cord does not exceed the extension cord ampere rating. Also, make sure that the total rating of all products plugged into the wall outlet does not exceed the fuse rating.
2. Never push objects of any kind into this product through cabinet slots as they may touch dangerous voltage points or short out parts that could result in a fire or electronic shock. Never spill liquid of any kind on the product.
3. For electrical safety concerns, only use telephone cables rated 26AWG or higher.
4. Unplug this product from the wall outlet before cleaning. Do not use liquid cleaners or aerosol cleaners. Use a dry cloth for cleaning. Ensure that no liquid enters the system.

## **Laser Compliance Statement**

The CD-ROM/DVD-ROM/CD-RW/DVD-RW drive in this computer is a laser product. The CD-ROM/DVD-ROM/CD-RW/DVD-RW drive's classification label (shown below) is located on the drive.

<p><b>CLASS 1 LASER PRODUCT</b></p>
-------------------------------------

<p>Caution: Use to any controls or adjustments or procedures other than those specified herein may result in hazardous radiate exposure. To prevent exposure to laser emanations (Harmful to Human eyes), do not</p>
--



---

attempt to disassemble this unit.

## **Battery (Lithium)**

### ***Note:***

1. The following caution statement is located in the service and operating manual or on the label adjacent to the battery.
2. Risk of explosion if battery is replaced by an incorrect type.
3. Do not dispose of batteries in a fire.

### **1. English**

CAUTION: DANGER OF EXPLOSION IF BATTERY IS INCORRECTLY REPLACED. REPLACE ONLY WITH SAME OR EQUIVALENT TYPE RECOMMENDED BY THE MANUFACTURER. DISCARD USED BATTERIES ACCORDING TO THE MANUFACTURER'S INSTRUCTIONS.

### **2. French**

IL Y A DANGER D'EXPLOSION S'IL Y A REMPLACEMENT INCORRECT DE LA BATTERIE. REMPLACER UNIQUEMENT AVEC UNE BATTERIE DU MÊME TYPE OU D'UN TYPE RECOMMANDÉ PAR LE CONSTRUCTEUR. METTER AU RÉBUT LES BATTERIES USAGÉES CONFORMÉMENT AUX INSTRUCTIONS DU FABRICANT.

### **3. German**

VORSICHT ! Explosionsgefahr bei unsachgemäßen Austausch der Batterie. Ersatz nur durch denselben oder einem vom Hersteller empfohlenem ähnlichen Typ. Entsorgung gebrauchter Batterien nach Angaben des Herstellers.

### **4. Swedish**

Explosionsfara vid felaktigt batteribyte. Använd samma batterityp eller en ekvivalent typ som rekommenderas av apparattillverkaren. Kassera använt batteri enligt fabrikantens instruction.

## 5. Danish

Lithiumbatteri- Eksplosionsfare ved fejlagtig håndtering. Udskiftning må kun ske med batteri af samme fabrikat og type. Lever det brugte batteri tilbage til leverandoren.

## 6. Norwegian

Eksplosjonsfare ved feilaktig skifte av batteri. Benytt samme batteritype eller en tilsvarende type anbefalt av apparatfabriknten. Brukte batterier kasseres i henhold til fabrikantens instruksjoner.

## 7. Finnish

Paristo voi räjähtää, jos se on virheellisesti asennettu. Vaihda paristo ainostaan laitevalmistajan suosittelemaan tyyppiin. Hävitä käteet paristo valmistajan ohjeiden mukaisesti.

## Power Cord Set Requirements

- An approved power cord has to be used.
- Make sure the socket and any extension cord(s) you use can support the total current load of all the connected devices.
- Before cleaning the computer, make sure it is disconnected from any external power supplies (i.e. AC adapter).
- The power cord set (appliance coupler, flexible cord, and wall plug) you received with the Notebook (Laptop) meets the requirements for use in the country where you purchased the equipment.

- 
- Power cord sets for use in other countries must meet the requirements of the country where you use the computer. For more information on power cord set requirement, contact your local authorized dealer, reseller, or service provider.
  - Protect the power cord from being walked on or pinched particularly at plugs, convenience receptacles, and the point where they exit from the apparatus.

### **Power Lines**

Do not locate the antenna near overhead light or power circuits, or where it could fall into such power or circuits.

**Warning:** When installing or realigning an outside antenna system, extreme care should be taken to keep from touch such power lines or circuits. Contact with them could be fatal.

## Television antenna connectors protection (for system TV tuner card) (Optional)

### External television antenna grounding

If an outside antenna or cable system is to be connected to your Netbook, make sure that the antenna or cable system is electrically grounded to provide some protection against voltage surges and static charges.

Article 810 of the National Electrical Code. ANSI/NFPA 70, provide information with regard to proper grounding of the mast and supporting structure, grounding of the lead-in wire to an antenna discharge unit, size of grounding conductors, location of antenna discharge unit, connection to grounding electrodes, and requirements for the grounding electrode.

### Lightning protection

For added protection of any product during a lightning storm or when it is left unattended or unused for long periods of time, unplug the product from the wall outlet and disconnect the antenna or cable system.



Må Kun tilkoples kabel-TV nett via galvanisk isolator.

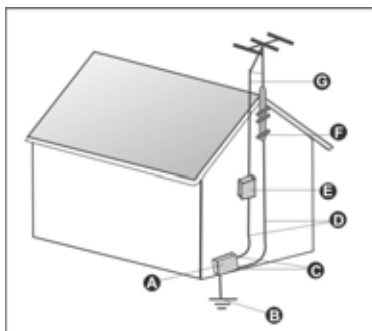

	Grounding Component
A	Electric Service Equipment
B	Power Service Grounding Electrode System (NEC Art 250, Part H)
C	Ground Clamps
D	Grounding Conductors (NEC Section 810-21)
E	Antenna Discharge Unit (NEC Section 810-20)
F	Ground Clamp
G	Antenna lead-in wire

Antenna grounding

---

### **CATV Cable Safety**

Make sure that your CATV system installer has connected the Coaxial cable shield to the grounding system of the building, as close to the point of cable entry as practical.

### **TV Antenna**

The TV antenna supplied with any TV Tuner module is intended for Indoor use only. Please do not use your TV Tuner module outdoors.

### **Battery Pack**

"Do not incinerate, (or) disassemble; may explode or release toxic materials.  
Do not short circuit; may cause burns. "

## About Your Netbook



**C**ongratulation for having purchased your new Netbook.  
This Netbook incorporates the newest features to serve your daily needs easily for anywhere you go.

---

# About Your User Guide

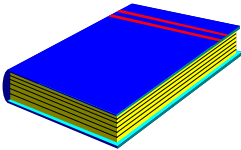

**W**elcome to your New Netbook User Guide. This manual introduces you to the basic concepts of your new Netbook.

This manual is divided into eight chapters.

- Chapter 1 Introduction
- Chapter 2 Getting Started
- Chapter 3 Using Your Netbook
- Chapter 4 Connecting to Peripherals
- Chapter 5 Customizing your Netbook
- Chapter 6 Caring for your Netbook

Appendix A System Specifications

## Table of Contents

<b>ABOUT YOUR NETBOOK .....</b>	<b>14</b>
<b>ABOUT YOUR USER GUIDE.....</b>	<b>15</b>
<b>1 INTRODUCTION.....</b>	<b>21</b>
1.1 FEATURE HIGHLIGHT .....	22
1.2 UNPACKING THE NETBOOK .....	24
1.3 THE INSIDE OF THE NETBOOK.....	25
<i>Netbook Status Icons</i> .....	27
<i>The Function of Easy Buttons</i> .....	29
1.4 THE LEFT SIDE OF THE NETBOOK.....	30
1.5 THE RIGHT SIDE OF THE NETBOOK.....	31
1.6 THE UNDERSIDE OF THE NETBOOK.....	32
1.7 NETBOOK ACCESSORIES .....	33
<b>2 GETTING STARTED .....</b>	<b>35</b>
2.1 USING THE BATTERY PACK .....	36
<i>Extending Battery Life</i> .....	36
2.2 CONNECTING THE AC POWER SOURCE.....	37
2.3 STARTING YOUR NETBOOK.....	38
2.4 ADJUSTING THE DISPLAY CONTROLS .....	39
2.5 DEVICE DRIVERS INSTALLATION.....	40
<i>Installing Windows 7 from Optical Disk Drive</i> .....	40
<i>Installing the Chipset Driver</i> .....	40
<i>Installing the VGA Device Driver</i> .....	41
<i>Installing the Audio Device Driver</i> .....	42
<i>Installing the Touch Pad Device Driver</i> .....	42
<i>Installing the Wireless LAN Device Driver</i> .....	43
<i>Installing the Bluetooth Driver &amp; Utility</i> .....	43



---

	<i>Installing The Bluetooth Device Driver &amp; Utility</i> .....	44
	<i>Installing the 3G HSDPA Device Driver (Optional)</i> .....	44
	<i>Installing the LAN Device Driver</i> .....	45
	<i>Installing the Camera Device Utility</i> .....	45
	<i>Installing the Utility Program Component Device Driver</i> .....	46
	<i>Installing the Hotkey Utility</i> .....	46
2.6	TURNING OFF YOUR NETBOOK.....	47
<b>3</b>	<b>USING YOUR NETBOOK</b> .....	<b>48</b>
3.1	STARTING YOUR OPERATING SYSTEM.....	49
3.2	UNDERSTANDING THE KEYBOARD FUNCTIONS.....	49
	<i>Basic Keyboard Functions</i> .....	51
	<i>Cursor Control Keys</i> .....	53
	<i>Screen Control Keys</i> .....	53
	<i>Windows Hot Keys</i> .....	54
	<i>Special Function Keys</i> .....	54
3.3	USING THE TOUCHPAD POINTING DEVICE .....	56
3.4	CONFIGURING YOUR SCREEN DISPLAY .....	58
	<i>Possible Display Configurations</i> .....	58
	<i>Changing the Display Properties under Windows</i> .....	59
3.5	KNOWING THE POWER SAVING FEATURES .....	59
3.6	WORKING WITH THE BUILT-IN HDD .....	61
3.7	SIM CARD .....	61
	<i>Inserting and Removing a SIM Card</i> .....	61
3.8	USING FLASH MEMORY CARDS .....	63
	<i>Flash Memory Card</i> .....	63
<b>4</b>	<b>CONNECTING TO PERIPHERALS</b> .....	<b>65</b>
4.1	USING THE USB PORT .....	66
4.2	USING AN EXTERNAL MONITOR PORT .....	67
4.3	USING THE EXTERNAL AUDIO SYSTEM.....	68

---

4.4	USING THE LAN PORT .....	68
4.5	USING THE WIRELESS LAN.....	69
<b>5</b>	<b>CUSTOMIZING YOUR NETBOOK.....</b>	<b>71</b>
5.1	RUNNING THE BIOS SETUP PROGRAM .....	72
5.2	USING THE MAIN MENU SETUP .....	74
5.2.1	<i>Internal HDD Sub-Menu</i> .....	76
5.3	USING THE ADVANCED CMOS SETUP.....	77
5.4	SECURITY MENU SETUP .....	78
5.5	USING THE BOOT SETUP .....	79
5.6	HOW TO EXIT THE SETUP PROGRAM.....	80
5.7	HOW TO UPGRADE THE BIOS.....	81
<b>6</b>	<b>CARING FOR YOUR NETBOOK.....</b>	<b>83</b>
6.1	IMPORTANT SAFETY INSTRUCTIONS .....	84
6.2	CLEANING YOUR NETBOOK .....	86
6.3	MAINTAINING THE LCD QUALITY .....	86
6.4	MAINTAINING YOUR HARD DISK .....	87
6.5	BATTERY CARE GUIDELINES .....	88
6.6	WHEN YOU TRAVEL.....	89
<b>APPENDIX A</b>	<b>SYSTEM SPECIFICATION.....</b>	<b>90</b>
	SYSTEM SPECIFICATION .....	91
	<i>Processor Unit</i> .....	91
	<i>System Memory</i> .....	91
	<i>LCD Display</i> .....	91
	<i>VGA System</i> .....	91
	<i>Storage</i> .....	92
	<i>Audio System</i> .....	92
	<i>Webcam</i> .....	92
	<i>Touchpad</i> .....	92

---

<i>Keyboard</i> .....	93
<i>Flash BIOS</i> .....	93
<i>I/O Ports</i> .....	93
<i>Wireless devices</i> .....	93
<i>AC/DC Power Supply Adapter</i> .....	93
<i>Battery</i> .....	93
<i>Weight and Dimension</i> .....	94



# 1 Introduction

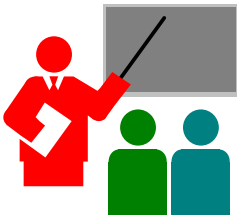

**Y**our Netbook is a fully Windows® compatible portable computer. Slim, sleek ultra-portable computer. This device matches all the demands for optimized mobile computing technology.

## 1.1 Feature Highlight

Before we identify each part of your Netbook, we will first introduce you to other notable features of your Netbook.

### ***Processing Unit***

- Check Your Netbook runs on Intel® N450 Pine-View microprocessor that is integrated with 512KB L2 Cache. Check with your dealer on the CPU type and speed.
- Fully compatible with an entire library of PC software based on operating systems such as Windows 7.

### ***Memory***

This Netbook provides one memory slot for installing DDRII SDRAM 200-pin SODIMM module up to 2GB using 512MB or 1024MB DDRII SDRAM module.

### ***Wide Screen LCD Display***

Provides 10.1" 1024 x 600 (16:9) wide screen LCD display.

### ***Wireless LAN***

- IEEE 802.11b/g/n, half PCI-E Mini Card.

### ***Bluetooth***

Provides Bluetooth function with USB Interface.

***HSPDA 3G***

Provides greatly expand transfer capacity for data, audio and video transmission. It is always working with SIM card.

***Webcam***

Provides Webcam function with 1.3M pixels.

***USB 2.0***

Provides two USB2.0 ports for fastest I/O data transmission.

***Graphic System***

Provides blazing graphics controller embedded in Intel N450 CPU.

***PCI Local Bus Architecture***

32-bit PCI Enhanced IDE optimizes the data transfer between the CPU and SATA1 hard disk drives. Support ultra DMA ATA-300 PIO Mode up to PIO Mode 4, bus mastering for LBA Scheme.

***Audio System***

Compliant with Intel HD Audio (Azalia). Sound Blaster compatible. Support 32-bit, multi-channel audio system output.

***Flash BIOS***

Flash BIOS allows you to easily upgrade the System BIOS using the Phoenix Flash utility program.

## ***Power and System Management***

- Integrated SMM (System Management Mode) on system chipset that shuts down components not in use to reduce power consumption. To execute power management, you can set up the parameter in Power Options properties by pointing your mouse to Control Panel of Windows.
- Closing the Netbook (lowering the cover) allows you to stand by the system operation instantly. To wake up the system, press the power button or open the cover lid.
- System Password for User and Supervisor included on the BIOS SETUP Program to protect unauthorized use of your Netbook.

## 1.2 Unpacking the Netbook

Your Netbook comes securely packaged in a sturdy cardboard shipping carton. Upon receiving your Netbook, open the carton and carefully remove the contents. In addition to this User Guide, the shipping carton should also contain the following items:

- The Netbook
- An AC Adapter and AC Power Cord
- Li-Ion Battery Pack
- DVD Driver Utility and User Guide
- Quick Setup Manual



Carefully inspect each component to make sure that nothing is missing and/or damaged. Be sure to save the shipping materials and the carton in case you need to ship the Netbook or store for an extended period of time.

## 1.3 The Inside of the Netbook

The Netbook is compact with features on every side. First, look at the inside of the system. The following sections describe inside features.



1. Webcam
3. Power On/Resume Button
5. LED Indicators
7. Keyboard

2. Color Widescreen LCD Display.
4. Easy Buttons
6. Integrated Microphone
8. Touchpad Pointing Device

- Webcam  
The Webcam is 1.3M pixels. It can be used as a communication device that transmits instant image through network for conference.
- Color Widescreen LCD Display  
The Netbook comes with a color LCD that you can adjust for a comfortable viewing position. The LCD is 10.1" TFT color LCD with 1024 x 600 (WSVGA) resolution panels. The features of the Color LCD Display are summarized as follows:
  - ⊖ TFT color LCD with Widescreen 10.1" 1024 x 600 (WSVGA) resolution panels.
  - ⊖ Capable of displaying 16M colors (32-bit true color)
  - ⊖ LCD display control hot-keys allow you to adjust the brightness of the LCD.
  - ⊖ Simultaneous display capability for LCD and external desktop computer monitor.
- Power On/Resume Button  
Switches the Netbook power on and off, or resumes whenever it is in Standby and Hibernate mode.
- Easy Buttons  
There are two easy buttons used for Wireless LAN accessing and Screen Rotate executing instantly and easily. Description of the easy buttons appears in the latter part of this section.
- LED Indicators  
Keeps you informed of your Netbook current power status and operating status. Description of the status icons appears in the latter part of this section.

- Integrated Microphone  
Integrated mono microphone for instant voice recording and simultaneous voice conversation.
- Keyboard
  - Standard QWERTY-key layout and full-sized 83 keys keyboard with Windows system hot-keys, embedded numeric keypad, 10 hot keys, inverted "T" cursor arrow keys, and separate page screen control keys.
  - Wide space below the keyboard panel for your wrist or palm to sit-on comfortably during typing.
- Touchpad Pointing Device  
Microsoft mouse compatible with two Touchpad click buttons. The two select buttons located at each side of the Touchpad support tapping selection and dragging functions. These buttons work like a standard notebook mouse. Simply move your fingertip over the Touchpad to control the position of the cursor. Use the selection buttons at each side of the Touchpad to select menu items.

## **NETBOOK STATUS ICONS**

---

The Status LED Panel keeps you informed of the Netbook's current power and operating status. Each LED is marked with an icon to designate the system status.

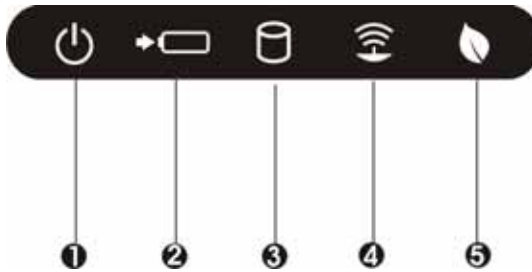

1. Power Indicator
2. Battery Charging
3. Drive Access
4. WLAN/Bluetooth Access
5. Silent Mode

- Power Indicator
  - Lets you know that power to the system is turned on. This LED is positioned so that you can see the power state whether the LCD panel is opened or closed.
  - ⊖ Lights green when the system is powered on.
  - ⊖ Lights green blinking when the system is in Standby mode.
  - ⊖ Lights amber blinking when the battery power is critical low.
- Battery Charging LED
  - Lights to indicate battery in charging status.
  - ⊖ Lights on to indicate that the battery is in charging.
  - ⊖ When the light is off, it indicates no battery installed.
  - ⊖ Lights orange to indicate that the battery is in discharging.
  - ⊖ Lights orange blinking when the battery **is in low capacity (8%)**.
  - ⊖ Lights green to indicate the battery is fully charged.
  - ⊖ Lights green blinking when the battery is in charging.

- **Drive Access**  
When LED turns on indicates that the system is accessing the Hard Disk Drive.
- **WLAN/Bluetooth Access**  
When LED turns on indicates that the wireless LAN & Bluetooth module is activated. When LED lights off, it indicates that the function is disabled.
- **Silent Mode**  
When LED in blue blinking light indicates that the system is decreasing the CPU performance speed in order to save power for extending battery life and operation time.

## **THE FUNCTION OF EASY BUTTONS**

---



1. WLAN/Bluetooth Access Button      2. Screen Rotate Button

- **WLAN/Bluetooth Button**  
Push this button to activate or inactivate the WLAN/Bluetooth. When you activate the WLAN/Bluetooth function, it will search the WLAN/Bluetooth signal automatically if you had installed the driver.

- Internet Button  
This easy button is designed specifically for executing the Screen Rotate function on the touchpad.

## 1.4 The Left Side of the Netbook

The left side of your Netbook provides the features shown in the following figure.

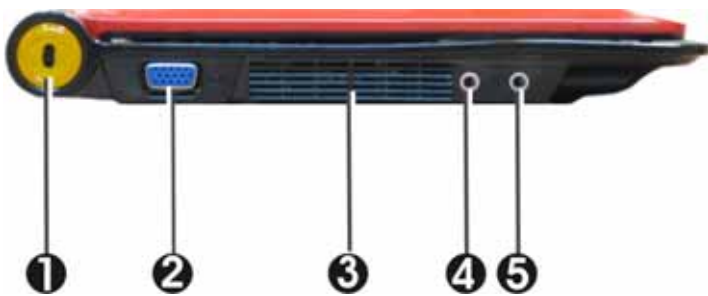

- |                           |                    |
|---------------------------|--------------------|
| 1. Locking Device Keyhole | 2. VGA Port        |
| 3. Air-Outlet Vent        | 4. Microphone Jack |
| 5. Headphone Jack         |                    |

- Locking Device Keyhole  
Lets you attach a Kensington security system or a compatible lock to physically secure your notebook computer.
- VGA Port  
Lets you attach an external monitor or projector for wider display. You can run the LCD display and the external monitor simultaneously or switch it to monitor only using the display hot-key.
- Air-Outlet Vent  
Emits the heat out of your Netbook and keeps it within operating

temperature.

- **Microphone Jack**  
Allows you to connect an external microphone for monophonic sound recording directly into your Netbook computer.
- **Headphone Jack**  
Lets you plug in a stereo headphone, powered speakers, or earphone set with 1/8 inch phono plug for personal listening.

## 1.5 The Right Side of the Netbook

The right side of the Netbook offers the features shown in the following figure.



- 1. 4 in 1 card slot
- 4. SIM card slot
- 6. DC Power Port

- 2. 3. USB 2.0 Port
- 5. LAN Port
- 7. Locking Device Keyhole

### **Right Side Features**

- **4 in 1 card slot**  
The card slot supports SD, MMC, MS (Memory Stick), and MS\_Pro flash memory card format. You can use either of the 4 types flash memory cards for extra storage media. Please pay attention to correct direction when you insert the flash memory card. For more detail of flash card, you can refer to Chapter 3.8.
- **USB 2.0 Port**  
The Universal Serial Bus (USB) port allows you to connect USB 2.0-compliant devices (for example, printers, scanners and so on) to your Netbook.
- **3G SIM Card Slot**  
Open the cover of this slot for SIM Card installation. (SIM card is always working with 3G HSDPA PCI-E Card)
- **LAN Port**  
An internal 10Base-T/100Base-TX and 1G Ethernet LAN module connects your computer to other computers/networks through a local area network (LAN).
- **DC Power Port**  
Lets you connect the AC power adapter in supplying continuous power to your Netbook and recharging the battery.
- **Locking Device Keyhole**  
Lets you attach a Kensington security system or a compatible lock to physically secure your Netbook.

## 1.6 The Underside of the Netbook

The bottom of the Netbook offers the following features.





1. 2. Built-in Stereo Speakers  
Compartment 4. Battery Bay

3. Hard Disk

## **Bottom of the System**

- Built-in Stereo Speakers  
Integrated mini stereo speaker provides sound and audio output for your multimedia presentations or listening pleasure.
- Hard Disk Compartment  
Open this cover of this compartment to replace with other Hard Disk Drive.
- Battery Bay  
Equipped with a choice of Lithium-Ion (Li-Ion) battery pack.

## 1.7 Netbook Accessories

### ***AC Adapter***

The AC Adapter supplies external power to your Netbook and charges the internal battery pack simultaneously. The AC adapter has an auto-switching design that can connect to any 100VAC ~ 240VAC power outlets. Change the

power cord if you are going to use your Netbook in countries with different connector outlets.

When you connect the AC adapter, it charges the battery whether or not the Netbook is powered on.

## ***Battery Pack***

Aside from the AC adapter, your Netbook can also be powered through the internal battery pack. The battery pack uses rechargeable Lithium-Ion (Li-Ion) battery cells that provide long computing hours when fully charged and power management enabled. You should always leave the battery inside your Netbook even when using the AC adapter as it also acts as a back-up power supply in case power from the AC adapter is cut off. It is also very important to have the battery pack always charged to prevent battery cell degradation.

## 2 Getting Started

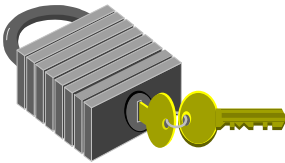

**Y**our Netbook is designed and pre-configured for easy setup and use. This chapter describes the installation steps you should follow to get the Netbook up and running as quickly as possible.

## 2.1 Using the Battery Pack

The Netbook is designed to operate with one of the following power sources:

- With AC power using the AC adapter connected to an electrical outlet.
- With a Lithium-Ion (Li-Ion) battery pack.

You should use the AC adapter whenever it is possible, relying on the battery pack only when AC power is unavailable.

When you use your Netbook the first time, please operate it without an external power source. You can connect the AC power adapter to immediately recharge the battery, when the battery pack is used up and the Netbook is turn off. (Before you use your Netbook, recharge the battery pack first. The rechargeable Li-Ion battery pack allows you to operate the Netbook without an external power source. When you connect the AC power adapter, the battery immediately starts to recharge. For maximum battery performance, fully discharge the battery before recharging it the first time. To do so, unplug the AC adapter, turn off power management features (through Setup and Windows), and turn on the system. Once the battery is fully discharged, plug in the AC adapter and recharge the battery.)

If you do not discharge the battery completely, it fails to accept a full recharge.

***⚠ Li-Ion battery is vulnerable, do not charge it with other power adapter, or it may cause fire or explosion.***

### **EXTENDING BATTERY LIFE**

---

It is important to be aware of the simple things for extending the life of the system main battery while you are on the road. You should find a working place where the external lighting is not too bright and turn down the screen

brightness. Also, you can choose the available mode on the Power Management item of the Control Panel in Windows.

## 2.2 Connecting the AC Power Source

The AC adapter provides external power source to your Netbook and charges the internal battery pack at the same time. The AC adapter also has an auto-switching design that can connect to any 100VAC ~ 240VAC power outlets.

To connect the power adapter:

1. Plug the AC power cord into the power socket of the AC power adapter.
2. Plug the other end of the AC power cord to a live AC wall outlet.



3. Plug the connector of the AC adapter to the DC-IN port found at the right side of the Netbook.

- ***Whenever possible, it is advisable to always have the AC adapter connected to the Netbook and the battery pack installed. This ensures continuous power supply and prevents any data loss incurring from sudden power breakdown.***
  
- ***For the power supply of this equipment, an approved power cord has to be used.***
- ***Make sure the socket and any extension cord(s) you use can support the total current load of all the connected devices.***
- ***Before cleaning the Netbook, make sure it is disconnected from any external power supplies (i.e. AC adapter).***

## 2.3 Starting Your Netbook

The Power/Resume button is found on the left-top of the base unit. Press the Power/Resume button to start your Netbook and check that if the Power LED turns on.



After a few seconds, the Netbook's display will turn on and your Netbook will begin to execute the Power On Self Test or POST to check if all system components are running properly. Any error found during the test will be displayed on the screen and may generate short beep sound as well.

After the test, the screen will also display a message "**press <F2> to boot SETUP**". You don't need to run this program at the moment as your dealer already made the necessary settings for your Netbook optimal operation. Refer to Chapter 6 on running the SETUP program later.

After the test has completed, your Netbook will start to search and boot up the operating system from your hard drive. The Netbook normally comes with a Windows operating system pre-installed in your hard drive. Consult the Windows manual on how to use the program. If not, contact your dealer for assistance.

## 2.4 Adjusting the Display Controls

The LCD brightness adjustment is controlled by <Fn> +<F8> and <Fn> + <F9> keys respectively. You need to press these hot-key controls after powering on your Netbook to suit your viewing pleasure.

The Brightness hot-key control adjusts the brightness on the LCD. The brightness hot-key control will not set the LCD completely dark or bright; it provides sufficient lighting to the LCD to match the external lighting of the surrounding. The brighter the room, the more you need to increase the brightness of the LCD.

## 2.5 Device Drivers Installation

If you already have an operating system installed into your Netbook., it is best to install the needed device drivers for using the built-in devices of your Netbook. Before installing the drivers, check with your dealer first if they have already installed all the drivers along with the operating system. If not, follow the procedures below:

### **INSTALLING WINDOWS 7 FROM OPTICAL DISK DRIVE**

---

To install Windows 7 directly from your USB - Slim Combo Drive (optional), please go to **Boot** menu of **BIOS** setup menu. Use arrow key to select "USB CDROM", then use "+" or "-" to move it to the top. Go to **Exit** menu and select "**Exit Saving Changes**". Accordingly, insert the Windows 7 installation DVD into USB - Slim Combo Drive (optional) with following the instructions on the screen to finish the installation.

### **Driver Installation Note:**

- ⌘ Before install driver & utility , please turn off the item "User Account Control settings" of User Accounts in Control Panel.*
- ⌘ Please install chipset driver first.*
- ⌘ Before install Hotkey utility , please install Utility Program Component driver first .*

### **INSTALLING THE CHIPSET DRIVER**

---

Your Netbook uses the advanced chipset. Installing the driver to enhance the stability and performance.



### *Installing Chipset device driver for Windows 7*

1. Click the **Start** button, then point to **Run**. The **Run** dialog box appears.
2. Click the **Browse** button and specify the directory as "**E:\Drivers\x86\Chipset\Setup.exe**".
3. Click "**OK**" to execute the setup program. The **Setup** box appears.
4. Click "**Next**" continuously to install this driver when screen displays this command.
5. Click "**Yes**" to accept the License Agreement.
6. Click "**Next**" twice to continue the following step.
7. Tick the option "**Yes, I want to restart this computer now.**", and press "**Finish**" to restart your system.

## **INSTALLING THE VGA DEVICE DRIVER**

---

Following is the procedure for installing the Video Accelerator 3D Adapter VGA driver to your Netbook:

### *Installing VGA device driver for Windows 7*

1. Click the **Start** button, then point to **Run**. The **Run** dialog box appears.
2. Click the **Browse** button and specify the directory as "**E:\Drivers\x86\VGA\Setup.exe**".
3. Click "**OK**" to execute the setup program. The **Setup** box appears.
4. Click "**Next**" continuously to install this driver when screen displays this command.
5. Click "**Yes**" continuously to install driver.
6. Click "**Next**" twice to continue the installation.

7. Tick the option "**Yes, I want to restart my computer now.**", and press "**Finish**" to restart your system.

## **INSTALLING THE AUDIO DEVICE DRIVER**

---

Your Netbook uses the Realtek Audio controller.

### *Installing Audio device driver for Windows 7*

1. Click the **Start** button, then point to **Run**. The **Run** dialog box appears.
2. Click the **Browse** button and specify the directory as "**E:\Drivers\x86\Audio\Setup.exe**" where the audio driver is located.
3. Click "**OK**" to execute the setup program. The **Setup** box appears.
4. Click "**Yes**" to continue the installation.
5. Tick the option "**Yes, I want to restart my computer now.**", and press "**OK**" to restart your system.

## **INSTALLING THE TOUCH PAD DEVICE DRIVER**

---

Please follow the procedures below for installing the Touch Pad driver:

### *Installing Touch Pad device driver for Windows 7*

1. Click the **Start** button, then point to **Run**. The **Run** dialog box appears.
2. Click the **Browse** button and specify the directory as "**E:\Drivers\x86\Touch Pad\Setup.exe**".
3. Click "**OK**" to execute the setup program. The **Setup** box appears.
4. Click "**Next**" to execute the setup program. The **Welcome** box appears.
5. Select "**I accept this agreement**" and click "**Next**" to continue the installation.

6. Click "**Finish**" to complete the installation.
7. Click "**Restart Now**" to restart your system.

---

## **INSTALLING THE WIRELESS LAN DEVICE DRIVER**

---

Please follow the procedures below for installing the Wireless LAN driver:

### *Installing Wireless LAN driver for Windows 7*

1. Click the **Start** button, then point to **Run**. The **Run** dialog box appears.
2. Click **Browse** button and specify the directory as "**E:\Drivers\x86\Wireless Lan\setup.exe**".
3. Click "**OK**" to execute the setup program. The **Setup** box appears.
4. Click "**Install**" to begin the installation.
5. Click "**Finish**" to complete the installation.

---

## **INSTALLING THE BLUETOOTH DRIVER & UTILITY**

---

Please follow the procedure for installing the Bluetooth driver & utility:

### *Installing Bluetooth device driver & utility for Windows 7*

1. Click the **Start** button, then point to **Run**. The **Run** dialog box appears.
2. Click the **Browse** button and specify the directory as "**E:\Drivers\x86\Bluetooth\Billionton\Setup.exe**".
3. Click "**OK**" to execute the setup program. The **Setup** box appears.
4. Click "**Next**" continuously to install this driver when screen displays this command.
5. Tick the option "**I accept the terms in the license agreement**", and press "**Next**" to continue.

6. Click "**Install**" to continue the installation.
7. Press "**Finish**", then press "**Yes**" to restart your system.

## **INSTALLING THE BLUETOOTH DEVICE DRIVER & UTILITY**

---

Please follow the procedures below for installing the Bluetooth driver & utility:

### *Installing Bluetooth device driver for Windows 7*

1. Click the **Start** button, then point to **Run**. The **Run** dialog box appears.
2. Click the **Browse** button and specify the directory as.  
"**E:\Drivers\x86\Bluetooth\AzureWave\Setup.exe**".
3. Click "**OK**" to execute the setup program. The **Setup** box appears.
4. Click "**Next**" to continue the following steps.
5. Choose "**I accept the terms in the license agreement**" and click "**Next**" twice.
6. Click "**Install**" to implement setup program to install this driver.
7. Click "**Finish**" to complete the installation.

## **INSTALLING THE 3G HSDPA DEVICE DRIVER (OPTIONAL)**

---

Please follow the procedures below for installing the 3.5G HSDPA driver:

### *Installing 3G HSDPA device driver for Windows 7*

1. Click the **Start** button, then point to **Run**. The **Run** dialog box appears.
2. Click the **Browse** button and specify the directory as.  
"**E:\Drivers\x86\3G\Setup.exe**".

3. Click "**OK**" to execute the setup program. The **Setup** box appears.
4. Select a language and click "**OK**" to execute the setup program.
5. Click "**Next**" to continue.
6. Click "**I Agree**" the license when it appears the terms for the license agreement.
7. Click "**Next**" to implement setup program to install this driver.
8. Click "**Install**" to continue.
9. Click "**Finish**" to complete the installation.

### **INSTALLING THE LAN DEVICE DRIVER**

---

Please follow the procedures below for installing the LAN driver:

#### ***Installing LAN device driver for Windows 7***

1. Click the **Start** button, then point to **Run**. The **Run** dialog box appears.
2. Click the **Browse** button and specify the directory as.  
**"E:\Drivers\x86\LAN\setup.exe "**
3. Click "**OK**" to execute the setup program. The **Setup** box appears.
4. Click "**Next**" to execute the setup program
5. Click "**Install**" to implement setup program to install this driver.
6. Click "**OK**" to continue the installation.
7. Click "**Finish**" to complete the installation.

### **INSTALLING THE CAMERA DEVICE UTILITY**

---

Please follow the procedures below for installing the Camera utility:

## ***Installing Camera utility for Windows 7***

1. Click the **Start** button, then point to **Run**. The **Run** dialog box appears.
2. Click the **Browse** button and specify the directory as **"E:\Drivers\x86\Camera\Utility\setup.exe"**.
3. Click **"OK"** to execute the setup program. The **Setup** box appears.
4. Click **"Next"** to execute the setup program.
5. Click **"Next"** to continue the installation.
6. Click **"Finish"** to complete the installation.

## **INSTALLING THE UTILITY PROGRAM COMPONENT DEVICE DRIVER**

---

Please follow the procedures below for installing the Utility Program Component driver:

## ***Installing Utility Program Component driver for Windows 7***

1. Click the **Start** button, then point to **Run**. The **Run** dialog box appears.
2. Click the **Browse** button and specify the directory as **"E:\Drivers\x86\Utility Program Component\Setup.exe"**.
3. Click **"OK"** to execute the setup program. The **Setup** box appears.
4. Click **"Next"** to execute the setup program.
5. Click **"Finish"** to complete the installation.

## **INSTALLING THE HOTKEY UTILITY**

---

Please follow the procedures below for installing the Hotkey utility:

### *Installing Hotkey utility for Windows 7*

1. Click the **Start** button, then point to **Run**. The **Run** dialog box appears.
2. Click the **Browse** button and specify the directory as "**E:\Drivers\x86\Hotkey\setup.exe**".
3. Click "**OK**" to execute the setup program. The **Setup** box appears.
4. Click "**Next**" to execute the setup program.
5. Click "**Install**" to implement setup program to install this driver.
6. Tick the option "**Yes, restart the computer now**", and press "**Finish**" to restart your system.

## 2.6 Turning off Your Netbook

If you are not going to use the Netbook for a while, it is best to turn off the power of the Netbook. Before turning off the power, you need to first close all application programs and shut down the operating system.

After turning off the Netbook, make it a habit to leave the LCD panel open for a while whenever used for an extended period of time. This allows the inside parts of the Netbook to cool off. Closing the panel will force the heat up against the LCD screen, which may degrade the LCD when done regularly. More importantly, never close the LCD panel for a long period of time when it is on and power saving features are disabled.

## 3 Using Your Netbook



**T**his chapter describes how to operate the standard built-in features of the Netbook.



## 3.1 Starting Your Operating System

The operating system is the software foundation for your Netbook. It is the platform for all your software application programs to run on. The most popular operating system today is Microsoft® Windows®. The Netbook comes with an operating system pre-installed and needs only to be setup and configured during initial use.

## 3.2 Understanding the Keyboard Functions

Your Netbook is equipped with an 87 keys keyboard that provides all the functionality of a full-sized 101 or 102-key keyboard. Aside from the standard typewriter-layout keyboard of your Netbook, there are a number of extra features and function controls on Netbook.

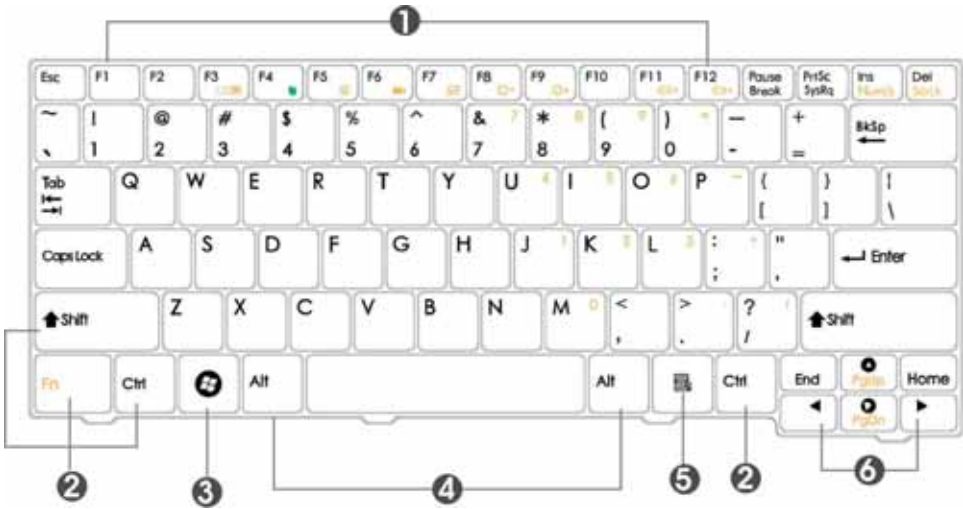

- |                           |                        |
|---------------------------|------------------------|
| 1. Function Keys          | 2. Control Keys        |
| 3. Windows Start Menu Key | 4. Control Keys        |
| 5. Windows Shortcut Key   | 6. Cursor Control Keys |

## Keyboard

Key features and operations are described below:

- **Function Keys**







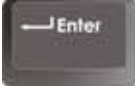

Function keys are application-driven, like **F1** through **F12** can be found on the keyboard. These keys work together with the **Fn** key to activate special functions. Some keys (printed in blue on keypad) are preprogrammed with dual functions.



- **Control keys** — **Ctrl**, **Alt**, **Fn**, and **Shift** are controls used in conjunction with other keys to change their functions. To use control keys, press and hold the control key while pressing another key. For example, "Press **Ctrl-C**" means to hold down the **Ctrl** key and type the letter **C**. Key combinations work especially to the application you are running.
- **Windows keys**  
Use the following two keys to facilitate your work:
  - Start Menu key  
Displays the Start menu.
  - Shortcut/Application key  
Provides quick access to shortcut menus. This key acts like a right mouse button.
- **Cursor Control keys**  
Cursor control keys let you position the cursor on the screen where you want. In the screen, the cursor is a blinking underline, block, or vertical bar depending on the application. The cursor indicates where the next text typed is inserted.
- **Typewriter keys**  
Typewriter keys (also called *alphanumeric* keys) are used to enter text and characters. Keys with blue print on them behave differently when combined with control keys.

## BASIC KEYBOARD FUNCTIONS

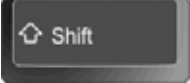
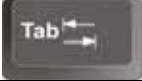



---

<b>Keypad</b>	<b>Function Description</b>
	<p>&lt;<b>Enter</b>&gt; key. Execute a command. Within many text editing application programs, the &lt;Enter&gt; key inserts a hard carriage return, just like what ordinary typewriter does.</p>

Keypad	Function Description
	< <b>Esc</b> > key. Press this key to cancel or escape from a command or function.
	< <b>Ins</b> > key. Known as the Insert key. Press this key to toggle the keyboard data entry from insert to type over mode.
	< <b>PrtScr</b> > key. Known as the Print Screen key. Press this key to map the whole screen to share memory for your specific usage.
	< <b>Del</b> > key. Known as the Delete key. Press this key to delete the character to the right of the cursor, or delete marked texts or items.
	< <b>Pause</b> > key. Press this key to temporarily halt execution of a command. Pressing any other key to resume execution of a command.
	< <b>Backspace</b> > key. Press this key to delete the character to the left of the cursor.
	< <b>Shift</b> > key. Press this key in combination with alphabet letters to produce uppercase letters in typing. Use this key in combination with those two-character keys (found on the second row of the keyboard) to produce the upper marked keys. Also used in most application program in combination with other keys to execute a certain command.
	< <b>Tab</b> > key. Press this key to move the cursor to the next tab stop on the right. This key works much the same as in ordinary typewriter.
	< <b>Ctrl</b> > key. Known as the Control key. Used in most application program in combination with other keys to execute a certain command.
	< <b>Alt</b> > key. Known as the Alternate key. Used in most application program in combination with other keys to execute a certain command.



Keypad	Function Description
	< <b>Fn</b> > + < <b>Num Lock</b> > key. Activates the embedded 15-key numeric keypad. The keys are color coded blue.
	< <b>Caps Lock</b> > key. Used in most application program to always activate uppercase alphabet characters.
	< <b>Fn</b> > + < <b>Scroll Lock</b> > key. Used in most application program to scroll the screen without having to move the cursor.

## CURSOR CONTROL KEYS

Keypad	Function Description
	<b>Up arrow key.</b> Moves the cursor up one line at a time.
	<b>Down arrow key.</b> Moves the cursor down one line at a time.
	<b>Left arrow key.</b> Moves the cursor to the left one space at a time.
	<b>Right arrow key.</b> Moves the cursor to the right one space at a time.

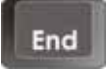

## SCREEN CONTROL KEYS

Keypad	Function Description
	< <b>Home</b> > key. Moves the cursor to the beginning of a screen or line.

Keypad	Function Description
	< <b>Fn</b> > + < <b>PgUp</b> > key. Moves the cursor up one screen at a time
	< <b>Fn</b> > + < <b>PgDn</b> > key. Moves the cursor down one screen at a time
	< <b>End</b> > key. Moves the cursor to the end of a screen or line.

## WINDOWS HOT KEYS









---

Keypad	Function Description
	< <b>Start</b> > key. Pulls up the Windows Start menu.
	< <b>Right Click</b> > key. Performs a mouse right-click function for Windows system.

## SPECIAL FUNCTION KEYS

---

The Netbook has special system function keys that activate key serving dual functions. When pressed in conjunction with the <**Fn**> key, these keys set specific system parameters and are sometimes referred to as "hot keys".

Keypad	Function Description
	Switches display between LCD, CRT, or LCD and CRT simultaneously.
	To open the Power Saving Mode function.
	To mute or open the built-in system speaker.
	To open the Webcam function.
	To close the touchpad function.
	Decrease the brightness of LCD display incrementally.
	Increases the brightness of LCD display incrementally.
	Decrease the audio volume incrementally.

Keypad	Function Description
 The image shows two laptop keys: the 'Fn' key on the left and the 'F12' key on the right. A plus sign is positioned between them, indicating a function key combination. The 'F12' key has a small speaker icon on it.	Increase the audio volume incrementally.

## 3.3 Using the Touchpad Pointing Device

Your Netbook comes with a built-in Touchpad pointing device that is found on the center of the palm-rest surface.

The Touchpad offers a number of options that let you customize how it functions. To access these options, locate the **Control Panel** and double click on the **Mouse** icon. The options let you control the size and color of the cursor, cursor speed, the accepted double-click speed, and selection button orientation.

The Touchpad works a mouse pointing device replacement that is used under Windows-based operating system. You can use the standard Microsoft driver that is compatible with the Touchpad device and is normally used under Windows-based operating system. However, if you want to utilize the added features of the Touchpad, you may want to try installing its own device driver that comes with added utilities for enhancing the function of the device.





1. Left Selection Button
2. Right Selection Button
3. Touchpad

### **Touchpad Features**

Here how to use the Touchpad pointing device:

1. The rectangular surface acts like a miniature duplicate of your display screen. To move the mouse cursor, place the finger lightly on the sensor pad and move in the desired direction. If you reach the end of the pad, lift your finger and place it back down on the other side of the pad.
2. To select an item, click on the item by pressing the left button control or by simply tapping on the surface once. A light, quick tap always works best. To execute an item, click the left button twice or do a quick double tap on the surface.

**⚠ Avoid spilling any liquid on the Touchpad surface and always keep the Touchpad surface and pointing finger dry from sweat built-up. Also do not expose Touchpad to any magnetic source object.**

## 3.4 Configuring Your Screen Display

The VGA display function of your Netbook contains RAM-based Digital-to-Analog Converter (RAMDAC) that transforms the digital data from the graphics and video subsystems to analog data for the CRT monitor. This controller offers a large set of extended functions and higher resolutions especially useful when you are connecting an external high-resolution and high-frequency CRT or LCD.

Please Refer to Section 5 "Installing the Netbook Device Drivers" of Chapter 2 in this manual for the procedures on how to install the VGA device driver under Windows. After installing the VGA driver, you would then configure the display resolution or screen size to match your LCD display panel. This Netbook model provides Wide screen 10.1" 1024 x 600 (WSVGA) resolution panels. You would also probably want to set the amount of color output to display sharper images and photos.

### **POSSIBLE DISPLAY CONFIGURATIONS**

---

The table below shows you the possible display resolution you can set when using either the LCD display or the external monitor (CRT):

Display	Possible Resolution	Maximum Colors
Widescreen 10.1" WSVGA LCD	1024 x 600	16 million colors
CRT Only	1400 x1050 (Maximum resolution)	16 million colors

- ⌘ *65,536 or 64K colors is also equivalent to 16-bit high color while 16 million or 16M colors is equivalent to 32-bit true color.*
- ⌘ *You can use the <Fn> + <F3> hot-key to switch the display between LCD only, CRT only, or both LCD and CRT display.*

## **CHANGING THE DISPLAY PROPERTIES UNDER WINDOWS**

---

To change the display properties of your screen under Windows system, just right-click on the desktop area and select Properties or go to the Control Panel and click on the Display icon. The Display Properties dialog box will appear on your screen. Click on the Settings tab to set your desired configuration. Make sure to follow the configuration table above.

- ⌘ *If you cannot configure the display properties, change the display driver first as mentioned on Section 5 "Installing the Netbook Device Drivers" of Chapter 2 in this manual. Consult your dealer for the latest Windows VGA driver.*

## **3.5 Knowing the Power Saving Features**

Aside from its superior performance, one of the great features in your Netbook is the ability to conserve power. Your Netbook is designed to incorporate intelligent and advanced power management functions that turn off power of most components when system is idle or not in use. This feature not only gives you longer battery life but also cools the systems and components as well.

The definitions of Standby Mode, Hibernation Mode, and Shutdown are depicted as follows:

## ***Standby Mode***

Standby Mode is mainly for power saving. When the Standby Mode is activated, your display and hard drive are shut down and all open applications and documents are stored in RAM (Random Access Memory). This allows your Netbook to wake up quickly, but a low level of power is required to maintain this suspended state. How quickly your system power down into Standby mode is up to you by setting proper times in Power Options of Control Panel in Window. While the Netbook is in Standby mode, the LED of power indicator flashes. To resume your working again, you can press the power button to return your work to the screen where you left off.

## ***Hibernation Mode***

In Hibernation mode, all system devices are powered down and the contents of RAM are stored on your hard drive. Hibernate mode uses less power than Standby mode, but takes a bit longer time to resume. When your Netbook goes into hibernation, Windows saves your entire desktop state before powering down your Netbook. You don't need to save and close each document before you put your Netbook into hibernation. When you press power button again, system will bring your Netbook out of hibernation. You'll find your applications and documents open on your desktop exactly as you left them.

## ***Shutdown***

All power has been turned off from the Netbook. This means that no power including external AC power source and battery power source will be consumed by the Netbook.

## 3.6 Working with the Built-in HDD

Your Netbook is equipped with a built-in large capacity 2.5 inch hard disk drive where you store and run your Netbook's operating system and application software programs.

## 3.7 SIM Card

### **INSERTING AND REMOVING A SIM CARD**

---

For removing or exchanging the SIM card, please turn off the computer first, then start using this function.

#### ***Inserting SIM Card***

To insert an SIM Card into the SIM Card slot:

1. Locate the SIM Card slot cover on the right side of the computer.
2. Insert the SIM Card into the SIM Card slot. The face label of the card should also be facing up.
3. When the full length of the card is almost inside the slot, push firmly but slowly, to ensure full connection with the computer. The SIM Card will be automatically detected, and once the needed driver is installed, it will generate a beep sound to indicate that the card is detected.



## ***Removing SIM Card***

To remove a SIM Card from the SIM Card slot, you should first disable the SIM Card setting in the system as described followings:

1. Double click the **SIM Card** icon on the right bottom side of the task bar.
2. Select the socket from the list that you want to remove, and click **Stop** button. The system then disables the function of SIM Card.
3. Then you can remove the inserted SIM Card. To release the SIM Card, just push the SIM Card again to the end. Then the SIM Card will automatically bounce off the SIM Card slot.
4. When the SIM Card has moved out a space out of the slot, hold the edges of the card and slowly slide it out.



## 3.8 Using Flash Memory Cards

### **FLASH MEMORY CARD**

---

Flash Memory is a memory storage media. It is used by most digital camera, Flash memory card is built with different form factor and brand name. The 4 in 1 card slot in this Netbook supports following cards as SD, MS (Memory Stick), MMC, and MS\_Pro.

***⚠ For a single moment, only one card can be inserted into the 4 in 1 card slot.***

#### ***Inserting Flash Memory Card***

To insert a flash memory card into the slot, please pay more attention whenever insert the flash memory card into the slot with the correct side.

You should position the copper connector at the bottom side. All of these cards should be located at the center of the slots in inserting.

Only one correct side can be accepted for the 4 in 1 card slot. If you cannot insert the card into the 4 in 1 slot or you had inserted the card but it is not recognized by the computer, please remove the card and insert it again. To

prevent the damage made both on card and the slot, never forced an entry into the slot with incorrect side.



## ***Removing Flash Memory Card***

To remove the flash memory card, you can pull out the card directly, there is no release button for flash memory slot.





## 4 Connecting to Peripherals

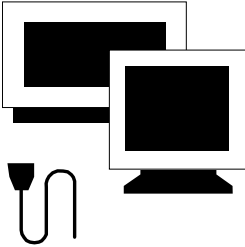

**T**his chapter describes how you attach additional peripheral devices to your Netbook. The Netbook allows you to add a printer or mouse; connect an external monitor and keyboard, or other compatible peripheral device. Use of additional devices is described in this chapter.

## 4.1 Using the USB Port

USB (Universal Serial Bus) is a hardware interface that enables you to connect multiple devices (such as printers, mice, keyboards, storage devices, joysticks, digital cameras, and video conference cameras, etc.) to your Netbook, and up to 127 devices can be attached. Besides, USB's hot swap capability allows everything to be plugged in and unplugged without turning the system off.

Microsoft, HP, Compaq, Intel, Agere, NEC and Philip are seven core members of USB-IF to have worked on USB 2.0 standardization. USB 2.0 offers data transfer rate up to 480Mbps (megabits per second) compared to USB 1.1 devices, which transfer at speeds of 12Mbps. So, you could know that USB 2.0 can transfer data between the Netbook and its peripherals 40 times faster than USB 1.1. However, USB 2.0 is fully backward compatible, you will be able to use a USB 1.1 device in a USB 2.0 compliant system.



- ⚡ ***Depending on your operational requirements, you may need to disable other ports in order to release system resource for the USB port.***
- ⚡ ***The USB bus distributes 0.5 amps (500 milliamps) of power through each port. For the purpose of power saving, please disconnect your USB device while not in use.***

## 4.2 Using an External Monitor Port

Your computer has a 15-pin Monitor port for supporting any external CRT or LCD color monitor. You need a display signal cable (usually provided with the monitor). One end of the cable must have a 15-pin connector for the system.

To connect an external monitor:

1. Turn off your computer and make sure the monitor power switch is turned off.

**⚠ *The notebook computer must be powered off or suspended while the monitor is being connected. Although you can connect the external Monitor without power off the computer and the external monitor, however, it is harmful to both devices and it shortens the life of these devices.***

2. Connect the connector cable of the monitor to the VGA port at the back of your computer.
3. Connect the monitor power cable and plug it into a properly grounded wall outlet.
4. Turn on the power of the monitor.
5. Turn on your computer. Both the LCD panel and the monitor screen will show the display. Your computer is set at default to run at simultaneous display mode.
6. If you only want to show the display on the external monitor or projector and shut off the LCD display, you can use the <Fn> + <F3> hot-key to switch display type between LCD and external monitor. Keep pressing the hot-key until you get the display to external monitor only.



**☞ Refer to Chapter 3 regarding the possible External CRT resolutions and how to change the display properties.**

## 4.3 Using the External Audio System

At the front side of your Netbook, you will find the built-in audio ports. You can connect Microphone jacks, earphone or powered speaker.

To connect to an audio jack:

1. Locate the audio port (Microphone, Headphone) that you want to use to the target device.
2. Plug the jack into the port on the front side of the system.

**☞ If you use external speaker and experience the sound distortion or feedback, please lower the volume. Some factors is caused by too close locating the microphone and speaker from each other; moving away the external audio option from the unit may also help.**

## 4.4 Using the LAN Port

This Netbook comes with an internal 10Base-T/100Base-TX LAN and 1000Mbps module that connects your Netbook to other notebook/networks

through a local area network (LAN) and supports data transfer rates at 10Mbps and can be up to 100Mbps. The 10Base-T standard also called Twisted Pair Ethernet is connected with RJ-45 connectors. The 100Base-TX is based on the older Ethernet standard. Because it is 10 times faster than Ethernet, it is often referred to as Fast Ethernet.

The built-in LAN module provides a standard RJ-45 connector.

To connect the twisted-pair cable to your LAN port:

1. Locate the twisted-pair cable in the accessories box in Netbook shipping carton. Each end of the cable has a RJ-45 connector.
2. Connect one end of the cable into the network wall outlet or HUB.
3. Connect the other end of the cable into the Netbook RJ-45 LAN port.



## 4.5 Using the Wireless LAN

Wireless LAN lets user connect to the LAN environment without using any wire to traditional RJ-45 jack. User can enjoy the wireless connection within the range of Access Point (AP) of LAN.

Access Point (AP) is the wireless transmission and receiving device, it generally connects to the server of a LAN environment or act as a LAN hub with wireless connection. Access point can be set in an office environment, airport, major railway station, etc. that depends on the construction of each country. In most case, you probably can use it at office, please consult with the network department of your company for more details.

This Netbook integrates 802.11 b/g/n wireless LAN module. IEEE 802.11b standard supports 11 Mbps wireless connection speed. However, IEEE 802.11g/802.11n supports 54Mbps and 150Mbps wireless connection speed respectively, and is backward compatible with the slower 802.11b. IEEE 802.11n uses MIMO Technology. Wireless LAN module is similar to LAN module. You need to install software driver before using it. Please refer to chapter 2.5 on how to install the driver.

# 5 Customizing Your Netbook

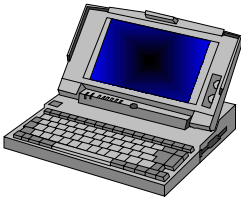

**Y**our Netbook uses the Phoenix BIOS Setup program allowing your system configuration to be altered to best suit your computing needs: User-adjustable options include system time and date, disk drive configuration and password setup.

BIOS information stored in the CMOS RAM will remain permanent unless changed. Default factory settings are used to optimize performance of your Netbook and do not need further alteration to operate your Netbook. Use caution when changing any BIOS settings.

## 5.1 Running the BIOS Setup Program

Your Netbook is setup and pre-configured. The Netbook's BIOS (Basic Input-Output System) Setup program may be used to change system configuration information such as the current date and time, or your hard disk drive type. The Setup program can be accessed when you power on the system and pressing the <**F2**> function key before the Microsoft® Windows® operating system begins.

The settings that you specify within the Setup program are recorded in a special area memory called the **CMOS RAM**. This memory is backed up by a battery so that it will not be erased when you turn off or reset the system. Whenever you turn on the Netbook, the system will read the settings stored in the CMOS RAM and compare them to the equipment check conducted during the Power On Self Test (POST). If an error occurs, an error message will be displayed on the screen, and you will then be prompted to run the Setup Program.

Press the <**F2**> key to run the BIOS Setup program. The BIOS Setup program is organized into five menus which you can select using the <-- and --> keys. To move from one option to another, you use the up and down arrow keys while using the <F5> and <F6>, or <+> and <-> keys to change the settings. On the right hand side of the screen are some brief help descriptions of each item you want to change.

On the BIOS Setup program, you will find the following parts on the screen:

- **Item Specific Help**  
The right side of the screen. This area describes each parameter and its available settings.



- **Menu Bar**  
The top line of the screen. Each of the five selections displays its own screen.
- **Parameters**  
The left side of the screen. This area lists the parameters and their current settings.
- **Key Status Bar**  
The bottom part of the screen. These lines display the keys available to move the cursor, select a particular function and so forth.

To exit the BIOS Setup program, simply press the <Esc> key and select from the Exit menu whether you want to Save Changes, Discard Changes, and Exit Discard Changes.

## 5.2 Using the Main Menu Setup

Phoenix BIOS Setup Utility				
Main	Advanced	Security	Boot	Exit
System Time: [07 :54 :32] System Date: [12/11/2009] BIOS revision: SV0E6D-1907-0307 ▶ SATA1 Port 1 [ATAPI Removable] CPU Type: Intel (R) Atom(TM) CPU N450 CPU Speed: 1600 MHz Installed Memory: 2048 MB Available to OS 2037 MB Used by devices 11 MB				Item Specific Help <Tab>, <Shift-Tab>, or <Enter> selects field.
<b>F1 Help</b>	<b>↑ ↓ Select Item</b>	<b>- / + Change Values</b>	<b>F9 Setup Defaults</b>	
<b>Esc Exit</b>	<b>← → Select Menu</b>	<b>Enter Select Sub-Menu</b>	<b>F10 Save and Exit</b>	

- System Time  
 Allows you to change the system time using the hour:minute:second format of the .  
 Enter the current time for reach field and use the <Tab>, <Shift>+<Tab>, or <Enter> key to move from one field or back to another.  
 You can also change the system time from your operating system.

- **System Date**  
Allows you to set the system date using the month/date/year format. Enter the current time for each field and use the <Tab>, <Shift>+<Tab>, or <Enter> key to move from one field or back to another.  
You can also change the system time from your operating system.
- **BIOS Revision**  
This field is for information only as the BIOS displays the BIOS version during the Power-On Self-Test (POST).
- **SATA1 Port 1**  
This field is for information only as the BIOS automatically detects the storage media.
- **CPU Type**  
This field reports the CPU type information detected by the BIOS during Power-On Self-Test (POST).
- **CPU Speed**  
This field reports the CPU speed information detected by the BIOS during Power-On Self-Test (POST).
- **Installed Memory**  
This field reports the amount of base (or conventional) memory found by the BIOS during Power-On Self-Test (POST).
- **Available to OS**  
This field reports the amount of Operating System available size found by the BIOS during Power-On Self-Test (POST).
- **Used by Devices**  
This field is for the information as the BIOS reserved the size for BIOS processing.

## 5.2.1 INTERNAL HDD SUB-MENU

Phoenix SecureCore(tm) Setup Utility		
Main		
SATA Port 1 [ATAPI Removable]		Item Specific Help
Type:	<b>Auto</b>	User = you enter parameters of hard-disk drive installed at this connection.
LBA Format		Auto = autotypes hard-disk drive installed here.
Total Sector:	312581808	CD-ROM = a CD-ROM drive is installed here.
Maximum Capacity:	160GB SATA1	ATAPI Removable= removable disk drive is installed here.
Multi-Sector Transfers:	[16 Sectors]	
LBA Mode Control:	[Enabled]	
32 Bit I/O:	[Disabled]	
Transfer Mode:	[FPIO 4 / DMA 2]	
Ultra DMA Mode:	[Mode 5]	
SMART Monitoring	Enabled	
<b>F1 Help    ↑ ↓ Select Item    -/+ Change Values    F9 Setup Defaults</b> <b>Esc Exit    ←--&gt; Select Menu    Enter Select ▶ Sub-Menu    F10 Save and Exit</b>		

You cannot modify all items on this menu, this sub-menu is for information only as the BIOS automatically detects the type of Hard Drive.

## 5.3 Using the Advanced CMOS Setup

Phoenix BIOS Setup Utility						
Main	Advanced	Security	Boot	Exit	Item Specific Help	
<p>Setup Warning</p> <p>Setting items on this menu to incorrect value may cause your system to malfunction.</p> <p>Large Disk Access Mode: <b>[Dos]</b></p> <p>Legacy USB Support <b>[Enabled]</b></p>				<p>UNIX, Novell NetWare, or other operating systems, select 'Other'. If you are installing new software and the drive fails, change this selection and try again.</p> <p>Different operating systems require different representations of drive geometries.</p>		
<b>F1</b>	<b>Help</b>	<b>↑ ↓</b>	<b>Select Item</b>	<b>- / +</b>	<b>Change Values</b>	<b>F9 Setup Defaults</b>
<b>Esc</b>	<b>Exit</b>	<b>← →</b>	<b>Select Menu</b>	<b>Enter</b>	<b>Select Sub-Menu</b>	<b>F10 Save and Exit</b>

- **Large Disk Access Mode:**  
This field lets you select Other or Dos option for specific operating system.
- **Legacy USB Support**  
Enable or Disable the Legacy Universal Serial Bus support

## 5.4 Security Menu Setup

Phoenix BIOS Setup Utility				
Main	Advanced	Security	Boot	Exit
			Item Specific Help	
Supervisor Password Is:		Clear	Supervisor Password controls access to the setup utility.	
User Password Is:		Clear		
Set Supervisor Password		[Enter]		
Set User Password		[Enter]		
Password on boot		[Disabled]		
<b>F1 Help</b>	<b>↑ ↓ Select Item</b>	<b>- / + Change Values</b>	<b>F9 Setup Defaults</b>	
<b>Esc Exit</b>	<b>← → Select Menu</b>	<b>Enter Select Sub-Menu</b>	<b>F10 Save and Exit</b>	

- Supervisor Password Is  
Set/Clear selections show that the Netbook is under controlled by Supervisor Password or not.
- User Password Is  
Set/Clear selections show that the Netbook is under controlled by User Password or not.
- Set Supervisor Password  
Supervisor password gives you the authority in accessing the setup utility. You also need to enter this password in system booting. When you press <Enter> in this field, the Set Supervisor Password dialog box appears. Enter a new password with up to 8 alpha-numeric characters, and then re-enter it for confirmation.

- Set User Password  
Enter the user password when boot the system.
- Password on Boot  
If you set this field to Enabled, your Netbook will always ask for the password every time you boot your .

## 5.5 Using the Boot Setup

This item allows you to set the search drive sequence where the system will try to boot up first.

Phoenix BIOS Setup Utility							
Main	Advanced	Security	Boot	Exit			
<p><b>Boot priority order</b></p> <p>1: USB FDC:</p> <p>2: USB CDROM:</p> <p>3: USB KEY:</p> <p>4: USB HDD:</p> <p>5: IDE 2: WDC WD1600BEVT-22A23T0-(S1</p> <p>6: PCI BEV</p>			<p>Item Specific Help</p> <p>Keys used to view or configure devices:</p> <p>Up and Down arrows select a device.</p> <p>&lt;+&gt; and &lt;-&gt; moves the device up or down.</p> <p>&lt;f&gt; and &lt;r&gt; specifies the device fixed or removable.</p>				
F1	Help	↑ ↓	Select Item	- / +	Change Values	F9	Setup Defaults
Esc	Exit	← →	Select Menu	Enter	Select Sub-Menu	F10	Save and Exit





- **Exit Discarding Changes**  
Allows you to discard all changes made while running the BIOS setup program and exit from the system setup program.
- **Load Setup Defaults**  
Lets you load the default values for all setup items.
- **Discard Changes**  
Reverts to previously selected settings.
- **Save Changes**  
Saves Setup data to CMOS.

## 5.7 How to Upgrade the BIOS

Your Netbook uses EPROM Flash BIOS chip that allows you to easily upgrade the BIOS program. When you update the BIOS, any customized settings you made are lost.

To upgrade the BIOS:

1. Put in the BIOS Update data into the USB device.
2. Power on the system with the diskette in the diskette drive.
3. On the DOS prompt, type the following command.

```
A:\>Phlash XXXXXX.ROM (BIOS filename) or  
A:\>XXXXXX.BAT (Batch file for BIOS file)  
Press <Enter> to run this BIOS utility. After the system has been  
successfully run this program, a message similar to the following appears:
```

```
Flash memory has been successfully programmed,  
press any key to restart the system. If the  
system does not restart, turn it off, then turn  
on again.
```

4. Press any key to restart this system.

Contact your dealer for the latest BIOS update file.

## 6 Caring for Your Netbook



**Y**our Netbook the latest features in mobile computing and multimedia technology. If properly cared for and maintained, the performance and reliability of the Netbook can be greatly prolonged.

## 6.1 Important Safety Instructions

This section gives you detailed information about how to maintain a safe working environment while using the Netbook. You can maintain its condition and performance by following these guidelines. Please read it carefully to ensure maximum safety.

- Before cleaning the Netbook, make sure it is disconnected from any external power supplies (i.e. AC adapter, car adapter and so on).
- When cleaning, do not use liquid or spray detergent for cleaning. Instead, use moisture sheet or a cloth for cleaning.
- The socket-outlet shall be installed near the Netbook and shall be easily accessible.
- Please keep the Netbook away from humidity.
- Lay the Netbook on a reliable flat surface when operating. A drop or fall may cause injury.
- The openings on the enclosure are for air convection hence the Netbook can be protected from overheating. **DO NOT COVER THE OPENINGS.**
- Be careful of using power supply. The Netbook has specific power requirements.
- Use only a power adapter approved for use with this Netbook.
- While unplugging the power cord, disconnect it by the plug head, not by its wire.
- Make sure the socket and any extension cords you may use can support the total current load of all the connected devices.

- Though your AC adapter is suitable for universal international voltage, it still requires a stable and continual power supply. Make sure the voltage of the power source when connect the Netbook to the power outlet. If you are not sure of your local power specifications, consult your dealer or local power company.
- Place the power cord in such a way that people can not step on it. Do not place anything over the power cord.
- All cautions and warnings on the Netbook should be noted.
- If the Netbook is not in use for a long time, disconnect it from mains to avoid possible damage by transient over-voltage.
- Never pour any liquid into openings as this may cause fire or electrical shock.
- Never open the body of Netbook. For safety reason, the Netbook should only be opened by qualified service personnel.
- If one of the following situations arises, have the Netbook checked by service personnel:
  - The power cord or plug is damaged.
  - Liquid has penetrated into the Netbook.
  - The Netbook has been exposed to moisture.
  - The Netbook has not worked well or you can not get it work according to user's manual.
  - The Netbook has dropped and damaged.
  - The Netbook shows signs of breakage.
- Do not leave or store this Netbook in an environment unconditioned. Storage temperature above 60°C (140°F) may damage the Netbook.

- An approved power cord has to be used for the Netbook power supply. For a rated current up to 6A and an equipment weight more than 3kg, a power cord not lighter than H05VV-F, 2G, 0.75mm<sup>2</sup>, has to be used.
- To avoid any damage to the internal device, please disconnect the AC adapter first and remove the battery pack from the Netbook when replacing any internal device.

## 6.2 Cleaning Your Netbook

When it is necessary to clean the plastic case and keyboard, use a soft, lint-free cloth, slightly dampened with a mild detergent solution or use the contents of any commercially available Netbook cleaning kit.

Never use alcohol, petroleum-based solvents, or harsh detergents to clean the Netbook. Also never spray any liquids directly on the Netbook case, keyboard, or screen. If the liquid-crystal display (LCD) screen has become smeared or dusty, clean the screen by first applying a mild glass cleaner to a soft, clean, lint-free cloth, and gently wipe the glass. Never apply liquids directly on the screen surface. Moreover, do not use paper towels to clean the display screen. Paper can scratch the display screen matte.

## 6.3 Maintaining the LCD Quality

When it comes to screen problems, heat plays a significant role. After a typical working session, users routinely close the Netbook the cover. The display surface - no matter what type it is - and the components inside the Netbook radiate heat; when you close the cover, you trap the heat against the screen. To help prolong the life of your Netbook, leave the cover open for ten minutes to let the heat disperses. (while the heat disperses.)

You should also enable the power management of your Netbook to turn off the LCD power and display when the system is inactive for some time.

Adding a screen saver also helps prolong the life of your Netbook screen.

Follow the safety guidelines mentioned earlier and how to clean your Netbook.

## 6.4 Maintaining Your Hard Disk

Losing your data has the same consequences as a system break down. Users must make it a habit of doing hard disk maintenance every week or so. Here is some maintenance you could do:

- Always back up your data files from your hard disk.
- Install the virus detecting program to monitor virus that could tamper your files.
- Use SCANDISK occasionally to correct any errors found in the directory and File Allocation Table. This will also free up space from any unused sectors.
- Never move or raise the Netbook while the hard disk is being accessed, most especially don't jar the hard disk as this may cause a hard disk crash.
- Use hard disk maintenance programs like **Disk Defragmenter** of Windows. These reorganize your hard disk by eliminating fragmentation and improving your hard disk access time.
- Install a system password in your Netbook so others won't be able to use the hard disk.

## 6.5 Battery Care Guidelines

The battery pack sold with the Netbook requires reasonable care and handling to ensure efficient operation and maximum life. There is a risk of fire and chemical burn if the battery pack is handled improperly.

To ensure that the battery pack endures normal life cycle, always observe the following precautions when handling the battery pack:

- Handle batteries carefully. Do not try to disassemble, crush, puncture, open, drop, mutilate, short external contacts, disposed of in water or fire, or expose it to temperatures higher than 45°C.
- Recharge batteries only as described in this manual and only in ventilated areas. Never use an external charger other than the one supplied with your Netbook.
- Do not leave batteries in hot locations for more than a day or two.
- Do not leave your battery in your Netbook for longer than 1 month without plugging in the power adapter.
- Do not leave battery in storage for more than 2 months without recharging it to prevent over discharge. Over discharge will hurt the battery
- Dispose dead battery properly to protect the environment. The batteries contain hazardous chemicals and should not be thrown out with household or office trash.
- You should always discharge your battery before recharging it on either of these two conditions: first, this is the first time you start to use your battery; second, you had not charge the battery for more than 2 months.



## 6.6 When You Travel

For safety and convenience when traveling, please follow these instructions:

- Back up all needed files on your hard disk before traveling.
- Recharge your battery overnight to ensure full battery power before you leave.
- Don't forget to bring along the AC adapter and extra battery pack.
- Try to bring backup software as well.
- Check the voltage rating and the outlet type of your destination. If the power cord of the adapter is different, then you need to purchase a suitable one. Consult your dealer.
- Carry your Netbook in its carrying case or in a briefcase. Never check-in the Netbook as a luggage.
- Remember to apply those power saving features and techniques to save battery power.

# APPENDIX A

## System Specification

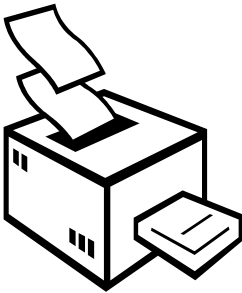

**T**his appendix provides technical specifications for the Netbook.

# System Specification

## **PROCESSOR UNIT**

---

- Intel® N450 microprocessor
- 1.6 GHz CPU, FSB 667 MHz
- 512KB integrated L2 cache for the processor

## **SYSTEM MEMORY**

---

- One 200-pin memory slot
- 512MB and 1024MB **up to 2GB** memory modules using 200-pin SODIMM
- DDR2 667 SDRAM modules
- Maximum memory size 2GB

## **LCD DISPLAY**

---

- 10.1" WSXGA (16:9) Color TFT LCD, 1024 x 600
- Maximum 16M true colors on all LCD display

## **VGA SYSTEM**

---

- Providing graphic engine Integrated in Intel N450 CPU
- Simultaneous LCD and external monitor (CRT) display
- Maximum 16 million colors on LCD display at 1024 x 600 resolution (CRT only) for 10.1" LCD

- Maximum 16 million colors on external monitor or projector at 1600x1200 resolution (Non-Interlaced)

## **STORAGE**

---

- 2.5" Format 9.5 mm High SATA1 HDD Module; Bus Mastering, Ultra DMA ATA-300 Support for LBA Scheme
- Support system boot from external USB device
- 4-in-1 (SD, MS, MMC, and MS\_Pro) card reader

## **AUDIO SYSTEM**

---

- Compliant with Intel HD Audio (Azalia 2 channels)
- H/W Audio Sound Blaster 16 compatible
- Built-in dual speakers
- Audio input jacks for microphone (MIC)
- Audio output jack for external speaker or headphone (Line-Out)
- Sound volume adjust by K/B Hot-Keys

## **WEBCAM**

---

One Webcam with USB2.0 CMOS 1.3M pixel

## **TOUCHPAD**

---

Integrated Touchpad (Serial/USB mouse) pointing device with 2 click buttons

## **KEYBOARD**

---

- Full-sized 87-keys keyboard with Windows systems hot-keys, inverted T-cursor keys, 9 hot keys, 12 function keys, and embedded numeric keypad
- Provides international language keyboard

## **FLASH BIOS**

---

512K Flash ROM BIOS for easy BIOS upgrade

## **I/O PORTS**

---

- 1 x VGA port
- 2 x Universal Serial Bus (USB 2.0)
- 1 x SIM Card slot
- 1 x 4 in 1 Card slot
- 1 x 10/100/1000Mbps LAN port

## **WIRELESS DEVICES**

---

- IEEE 802.11b/g/n, Half Mini-PCI card
- Bluetooth, USB Interface
- HSDPA 3 G, Full Mini Card or USB Interface

## **AC/DC POWER SUPPLY ADAPTER**

---

Universal auto-switching (100V~240V) 40W adapter, 20 Volt

## **BATTERY**

---

- Rechargeable 3 Cells Li-ion battery pack with Smart Battery function

- Approximately 4 Hours (for 3 Cells, 2800mAH) Battery Life (for Idle Mode)

## **WEIGHT AND DIMENSION**

---

- 285 (W) x 215 (D) x 26 (H) mm
- Approximately 1.2 kg