

# **FIC**

## **WB-B55**

### **User Guide**



**First International Computer, Inc.**



---

**Copyright©2003**

**All Rights Reserved - Printed in Taiwan**

Notebook Computer User Guide

Original Issue: 2003/6

This manual guides you in setting up and using your new notebook computer. Information in this manual has been carefully checked for accuracy and is subject to change without notice.

No part of this manual may be reproduced, stored in a retrieval system, or transmitted, in any form or by any means, electronic, mechanical, photocopy, recording, or otherwise, without prior written permission.

## **Trademarks**

Product names used herein are for identification purposes only and may be the trademarks of their respective companies.

Microsoft, MS-DOS, Windows, and Windows Sound System are trademarks of Microsoft Corporation.

Intel ®, Centrino™, Pentium ® M, Banias, Calexico are registered trademark of Intel Corporation.

Sound Blaster, Sound Blaster Pro are trademarks of Creative Technology.

All other brands or product names mentioned in this manual are trademarks or registered trademarks of their respective companies.

## **FCC Information to User**

### **Safety and Care Instructions**

No matter what your level of experience with computers, please make sure you read the safety and care instructions. This information can help protect you and your computer from possible harm.

### **Radio and television interference**

**Warning:** Use the specified shielded power cord and shielded signal cables with this computer, so as not to interfere with radio and television reception. If you use other cables, it may cause interference with radio and television reception.

This equipment has been tested and found to comply with the limits for a Class B digital device, pursuant to Part 15 of the FCC Rules. These limits are designed to provide reasonable protection against harmful interference in a residential installation. This equipment generates, uses and can radiate radio frequency energy and, if not installed and used in accordance with the instructions, may cause harmful interference to radio communications. However, there is no guarantee that interference will not occur in a particular installation. If this equipment does not cause harmful interference to radio or television reception, which can be determined by turning the equipment off and on, the user is encourage to try to correct the interference by one or more of the following measures:

- Reorient or relocate the receiving antenna
- Increase the separation between the device and receiver
- Connect the device into an outlet on a circuit different from that to which the receiver is connected.
- Consult the dealer or an experienced radio/television technician for help.

---

You may find helpful the following booklet, prepared by the Federal Communications Commission: Interference Handbook (stock number 004-000-00345-4). This booklet is available from the U.S. Government Printing Office, Washington, DC20402.

**Warning:** The user must not modify or change this computer without approval. Modification could void authority to this equipment.

### **FCC RF Exposure**

FCC RF Radiation Exposure Statement:

This Transmitter must not be co-located or operating in conjunction with any other antenna or transmitter.

This equipment complies with FCC RF radiation exposure limits set forth for an uncontrolled environment. This equipment should be installed and operated with a minimum distance of 20 centimeters between the radiator and your body.

15.247 (b)(4), the EUT meets the requirement that it be operated in a manner that ensures the public is not exposed to radio frequency energy levels in excess of the Commission's guidelines (1.1307, 1.1310, 2.1091 and 2.1093)

### **Canadian Department of Communications Compliance Statement**

This Class B digital apparatus meets all requirements of the Canadian Interference-Causing Equipment Regulations.

## **Shielded Cables Notice**

All connections to other computing devices must be made using shielded cables to maintain compliance with FCC regulations.

## **Peripheral Devices Notice**

Only peripherals (input/output devices, terminals, printers, etc) certified to comply with Class B limits may be attached to this equipment. Operation with non-certified peripherals is likely to result in interference to radio and TV reception.

## **Optical Disk Drive Notice**

The optical disk drive is Class One Laser Product.

## **Caution**

Changes or modifications not expressly approved by the manufacturer may void the user's authority, which is granted by the Federal Communications Commission, to operate this computer.

## **Use Conditions**

This part complies with Part 15 of the FCC Rules. Operation is subject to the following conditions: (1) this device may not cause harmful interference, and (2) this device must accept any interference received, including interference that may cause undesired operation.

---

# About Your Notebook Computer



**C**ongratulation for having purchased your new Professional Multimedia Notebook. This notebook incorporates the strongest features, which integrate the latest technologies available in the notebook industry.

Your new notebook computer not only drives today multimedia applications but also be ready for tomorrow exciting new software.

This Professional Multimedia Notebook is a freedom, flexibility, and functionality notebook that users are demanding for a long time.

## About Your User Guide

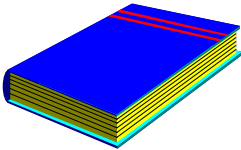

**W**elcome to your Professional Multimedia Notebook User Guide. This manual covers everything you need to know in learning how to use your computer. This manual also assumes that you know the basic concepts of Windows and the PC. You will start doing a lot of great and fun things with your computer.

This manual is divided into eight chapters.

- Chapter 1 gives introduction on your computer features.
- Chapter 2 provides step-by-step instructions to help you begin using your notebook as quickly as possible.
- Chapter 3 describes how to operate the standard features of your computer.
- Chapter 4 illustrates how to integrate video and sound chips into impressive presentation.
- Chapter 5 illustrates how to connect external device to your computer.
- Chapter 6 explains how to use the System BIOS Setup program.
- Chapter 7 explains how to use the internal module options of your computer.
- Chapter 8 offers instructions on how to care and maintain your notebook.



---

# Table of Contents

<b>ABOUT YOUR NOTEBOOK COMPUTER.....</b>	<b>5</b>
<b>ABOUT YOUR USER GUIDE.....</b>	<b>6</b>
<b>1 INTRODUCTION.....</b>	<b>13</b>
1.1 FEATURE HIGHLIGHT.....	14
1.2 UNPACKING THE COMPUTER.....	16
1.3 THE INSIDE OF THE NOTEBOOK.....	18
<i>Notebook Status Icons</i> .....	20
<i>The Function of Easy Buttons</i> .....	22
1.4 THE FRONT SIDE OF THE NOTEBOOK.....	23
1.5 THE REAR SIDE OF THE NOTEBOOK.....	23
1.6 THE LEFT SIDE OF THE NOTEBOOK.....	26
1.7 THE RIGHT SIDE OF THE NOTEBOOK.....	27
1.8 THE UNDERSIDE OF THE NOTEBOOK.....	28
1.9 NOTEBOOK ACCESSORIES.....	29
<b>2 GETTING STARTED.....</b>	<b>31</b>
2.1 USING THE BATTERY PACK.....	32
<i>Extending Battery Life</i> .....	34
2.2 CONNECTING THE AC POWER SOURCE.....	35
2.3 STARTING YOUR COMPUTER.....	36
2.4 ADJUSTING THE DISPLAY CONTROLS.....	37
2.5 INSTALLING THE NOTEBOOK DEVICE DRIVERS.....	37
<i>Installing Windows XP from Optical Disk Drive</i> .....	38
<i>Installing the Chipset Driver</i> .....	38
<i>Installing the VGA Device Driver</i> .....	39
<i>Installing the Audio Device Driver</i> .....	39
<i>Installing the Modem Device Driver</i> .....	40

	<i>Installing EzButton Utility</i> .....	40
	<i>Installing the Wireless LAN Device Driver and Utility</i> .....	41
	<i>Installing the LAN Device Driver</i> .....	42
	<i>Installing ALPS - Touch Pad driver</i> .....	43
	<i>Installing GV3 Driver</i> .....	43
2.6	TURNING OFF YOUR COMPUTER.....	44
<b>3</b>	<b>USING YOUR NOTEBOOK</b> .....	<b>45</b>
3.1	STARTING YOUR OPERATING SYSTEM .....	46
3.2	UNDERSTANDING THE KEYBOARD FUNCTIONS .....	46
	<i>Basic Keyboard Functions</i> .....	49
	<i>Cursor Control Keys</i> .....	50
	<i>Screen Control Keys</i> .....	51
	<i>Windows Hot Keys</i> .....	52
	<i>Special Function Keys</i> .....	52
3.3	USING THE GLIDE PAD POINTING DEVICE .....	53
3.4	CONFIGURING YOUR SCREEN DISPLAY .....	55
	<i>Possible Display Configurations</i> .....	56
	<i>Changing the Display Properties under Windows</i> .....	56
3.5	KNOWING THE POWER SAVING FEATURES .....	57
3.6	WORKING WITH THE BUILT-IN HDD.....	58
3.7	HOW TO ACCESS THE OPTICAL DISK DRIVE.....	59
3.8	USING PCMCIA CARDS.....	61
	<i>What is PCMCIA?</i> .....	61
	<i>What is CardBus?</i> .....	63
	<i>Inserting and Removing a PCMCIA Card</i> .....	63
	<i>Making PC Cards Work</i> .....	65
	<i>Hot Swapping PC Cards</i> .....	66
<b>4</b>	<b>FUN WITH MULTIMEDIA</b> .....	<b>67</b>
4.1	NOTEBOOK MULTIMEDIA FEATURES.....	68

---

4.2	AUDIO SOUND SYSTEM FEATURES .....	68
4.3	SETTING UP THE AUDIO DRIVER PROPERTIES .....	69
4.4	WINDOWS MULTIMEDIA PROGRAMS .....	69
4.5	RECORDING SOUNDS .....	70
	<i>Using an External Microphone</i> .....	73
	<i>Using the Built-in Optical Disk Drive</i> .....	73
4.6	PLAYING AUDIO AND SOUND .....	74
	<i>Using the Windows Media Player</i> .....	75
4.7	PLAYING VIDEO AND MPEG FILES .....	75
4.8	USING DVD .....	76
<b>5</b>	<b>CONNECTING TO PERIPHERALS .....</b>	<b>79</b>
5.1	USING A SERIAL PORT .....	80
5.2	CONNECTING A PARALLEL PRINTER .....	81
5.3	USING AN EXTERNAL KEYBOARD (PS/2) .....	82
5.4	USING THE USB PORT .....	83
5.5	USING AN EXTERNAL MONITOR PORT .....	84
5.6	USING THE IEEE 1394 PORT .....	85
5.7	USING THE EXTERNAL AUDIO SYSTEM .....	86
5.8	USING THE LAN PORT .....	87
5.9	USING THE WIRELESS LAN .....	88
5.10	USING THE MODEM PORT .....	89
<b>6</b>	<b>CUSTOMIZING YOUR NOTEBOOK .....</b>	<b>91</b>
6.1	RUNNING THE BIOS SETUP PROGRAM .....	92
6.2	USING THE MAIN MENU SETUP .....	94
	6.2.1 <i>Internal HDD Sub-Menu</i> .....	97
6.3	USING THE ADVANCED CMOS SETUP .....	97
	6.3.1 <i>I/O Device Configuration Sub-Menu</i> .....	100
6.4	SECURITY MENU SETUP .....	101
6.5	USING THE BOOT SETUP .....	104

---

6.6	HOW TO EXIT THE SETUP PROGRAM .....	105
6.7	HOW TO UPGRADE THE BIOS.....	106
<b>7</b>	<b>USING OPTIONS.....</b>	<b>109</b>
7.1	SYSTEM UPGRADE.....	110
	<i>Memory Upgrade</i> .....	110
	<i>Installing Memory Module</i> .....	111
7.2	HARD DISK UPGRADE .....	112
	<i>Upgrade Hard Disk</i> .....	112
7.3	WIRELESS MODULE INSTALLATION.....	114
<b>8</b>	<b>CARING FOR YOUR NOTEBOOK.....</b>	<b>115</b>
8.1	IMPORTANT SAFETY INSTRUCTIONS .....	116
8.2	CLEANING YOUR COMPUTER .....	118
8.3	MAINTAINING THE LCD QUALITY .....	119
8.4	MAINTAINING YOUR HARD DISK .....	119
8.5	BATTERY CARE GUIDELINES.....	120
8.6	WHEN YOU TRAVEL.....	121
<b>APPENDIX A</b>	<b>SYSTEM SPECIFICATION.....</b>	<b>123</b>
	<i>Processor Unit</i> .....	124
	<i>System Memory</i> .....	124
	<i>LCD Display</i> .....	124
	<i>VGA System</i> .....	124
	<i>Storage</i> .....	125
	<i>Audio System</i> .....	125
	<i>PCMCIA</i> .....	125
	<i>Glide Pad</i> .....	125
	<i>Keyboard</i> .....	125
	<i>Flash BIOS</i> .....	126
	<i>I/O Ports</i> .....	126

---

<i>Wireless devices</i> .....	126
<i>AC/DC Power Supply Adapter</i> .....	126
<i>Battery</i> .....	126
<i>Weight and Dimension</i> .....	127



# 1 Introduction

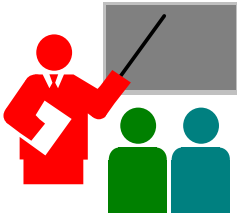

**Y**our Notebook PC is a fully Windows compatible portable personal computer. With the latest features in mobile computing and multimedia technology, this notebook makes a natural traveling companion. With leap of technology and compact, your Notebook PC runs on a whole wide range of general business, personal productivity, entertainment, and professional applications. It is ideal for use in the office, at home, and on the road.

Your Notebook PC makes an ideal choice for use in the office, the schoolroom, at home, on the road and all other occasions.

## 1.1 Feature Highlight

Before we go to identify each part of your Notebook PC, we will first introduce you to other notable features of your computer.

This notebook uses the platform with certified Intel® Centrino™ Mobile Technology. It supports the new Intel® Pentium® M processor, the core-logic architecture that absolutely fits the processor and the built-in excellent Intel® PRO/Wireless solution.

The Centrino™ Mobile Technology is a new concept of N/B that is capable of power-saving long operation time and easy accessing wireless connection. The CPU is specialized design for power saving feature with adequate speed. You can get the same powerful performance as high speed Intel Pentium® 4, yet without consuming so much energy.

### *Processing Unit*

- Your notebook runs on Intel Pentium® M microprocessor which is integrated with 1024 KB L2 Cache. Check with your dealer on the CPU type and speed.
- Fully compatible with an entire library of PC software based on operating systems such as Windows 2000/XP.

### *Wireless LAN*

Intel® Pro/Wireless network solution

### *Memory*

This notebook provides two memory slots for installing DDR SDRAM **200**-pin SODIMM modules up to 1024MB using 128MB, 256MB or 512MB DDR SDRAM modules



***PCMCIA***

Provides two PCMCIA slots that allow you to insert the Type II card

***IEEE 1394***

Provides one IEEE 1394 port for fast data transmission by external hard disk or digital video (DV)

***USB 2.0***

Provides three USB 2.0 ports for fastest I/O data transmission

***Graphic System***

Provides blazing graphics controller embedded in Intel Montara-GM chipset

***PCI Local Bus Architecture***

- 32-bit PCI Enhanced IDE optimizes the data transfer between the CPU and hard disk drives. Support ultra DMA 100 PIO Mode up to PIO Mode 4, bus mastering for LBA Scheme.
- 32-bit PCMCIA CardBus PCI technology that is also backward compatible with 16-bit PC cards.

***Audio System***

Full-duplex 16-bit stereo audio system output. Sound Blaster and Sound Blaster Pro compatible.

***Flash BIOS***

Flash BIOS allows you to easily upgrade the System BIOS using the Phoenix Flash utility program.

## *Power and System Management*

- Integrated SMM (System Management Mode) on system chipset that shuts down components not in use to reduce power consumption. To execute power management, you can set up the parameter in Power Options properties by pointing your mouse to Control Panel of Windows.
- Suspend hot-key allows you to suspend the system operation instantly and resume at the press of the power button.
- System Password for User and Supervisor included on the BIOS SETUP Program to protect unauthorized use of your computer.

## 1.2 Unpacking the Computer

Your computer comes securely packaged in a sturdy cardboard shipping carton. Upon receiving your computer, open the carton and carefully remove the contents. In addition to this User Guide, the shipping carton should also contain the following items:

- The Notebook Computer
- An AC Adapter and AC Power Cord
- Li-Ion Battery Pack
- Utility CD
- Hardcopy User Guide/E-book
- Quick Setup Manual

Carefully inspect each component to make sure that nothing is missing and/or damaged. If any of these items is missing or damaged, notify your dealer immediately. Be sure to save the shipping materials and the carton in case you need to ship the computer or if you plan to store the computer away sometime in the future.

## 1.3 The Inside of the Notebook

The notebook computer is compact with features on every side. First, look at the inside of the system. The following sections describe inside features.

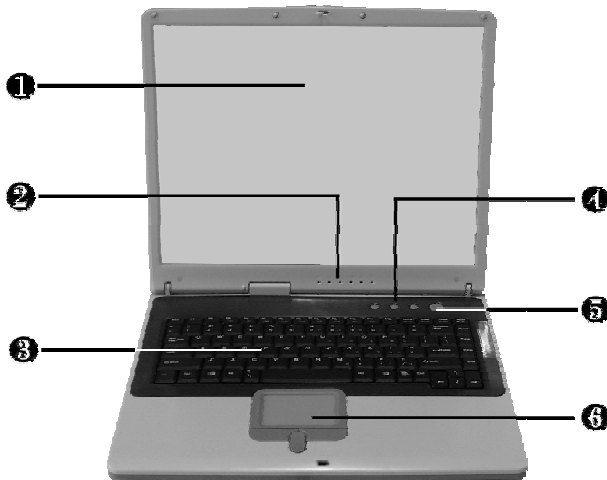

- |                           |                             |
|---------------------------|-----------------------------|
| 1. Color LCD Display      | 2. Status LED Indicator     |
| 3. Keyboard               | 4. Easy Buttons             |
| 5. Power On/Resume Button | 6. Touchpad Pointing Device |

- Color LCD Display

The notebook computer comes with a color LCD that you can adjust for a comfortable viewing position. The LCD can be 15" TFT color LCD with 1024x768 XGA (Extended Graphics Array) or 1280 X 1024 SXGA+ (Super Extended Graphics Array) resolution panels. The features of the Color LCD Display are summarized as follows:

- TFT color LCD with 15" 1024x768 XGA or 1280 X 1024 SXGA+ resolution panels.
- Capable of displaying 16M colors (32-bit true color) on either size panels.
- LCD display control hot-keys allows you to adjust the brightness of the LCD.
- Simultaneous display capability for LCD and external desktop computer monitor.
- Status LED Indicator  
Keeps you informed of your notebook computer's current operating status and power status. Description of the status icons appears in the latter part of this section.
- Keyboard
  - Standard QWERTY-key layout and full-sized 88 keys keyboard with Windows system hot-keys, embedded numeric keypad, 7 hot keys, inverted "I" cursor arrow keys, and separate page screen control keys.
  - Wide extra space below the keyboard panel for your wrist or palm to sit-on comfortably during typing.
- Easy Buttons  
There are three easy buttons used for activating wireless function and accessing user-defined functions instantly and easily. Description of the easy buttons appears in the latter part of this section.
- Power On/Resume Button  
Switches the computer power on and off, or resumes whenever it is in Suspend mode.

- **Touchpad Pointing Device**  
Microsoft and IBM PS/2 mouse compatible with three select buttons as one Scroll button and two Touchpad click buttons. These three buttons array below the Glide pad. The middle one is located with the Scroll button that lets you execute the scroll page function. The two click buttons located at each side support tapping selection and dragging functions. These buttons work like a standard computer mouse. Simply move your fingertip over the Glide Pad to control the position of the cursor. Use the selection buttons below the Glide Pad to select menu items.

## NOTEBOOK STATUS ICONS

---

The Status LED Panel keeps you informed of the notebook's current operating and power status. Each LED is marked with an icon to designate the system status.

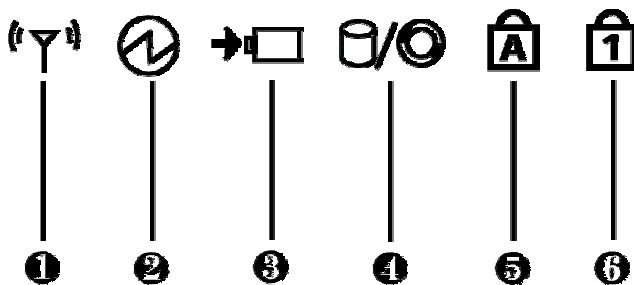

- |                         |                    |
|-------------------------|--------------------|
| 1. Wireless LAN Status  | 2. Power Indicator |
| 3. Battery Charging LED | 4. HDD/CD Access   |
| 5. Caps Lock            | 6. Num Lock        |

- **Wireless LAN Status**  
When LED in green light indicates that the system is accessing data from or is retrieving data by wireless LAN.

- **Power Indicator**  
Lets you know that power to the system is turned on. This LED is positioned so that you can see the power state whether the LCD panel is opened or closed.
  - Lights green when the system is powered on.
  - Lights green blinking when the system is in Suspend to RAM.
- **Battery Charging LED**  
Lights to indicate battery in charging status.
  - Lights green to indicate that the battery is in charging.
  - Lights off to indicate the battery is fully charged or no battery installed.
- **HDD/CD Access**  
When LED in green light indicates that the system is accessing either the Hard Disk or optical disk drive.
- **Caps Lock**  
When LED in yellow light indicates that the Caps Lock key on the keyboard is activated. When activated, all alphabet keys typed in will be in uppercase or capital letters.
- **Num Lock**  
When LED in yellow light indicates that the Num Lock key on the keyboard is activated. When activated, the embedded numeric keypad will be enabled.

## THE FUNCTION OF EASY BUTTONS

---

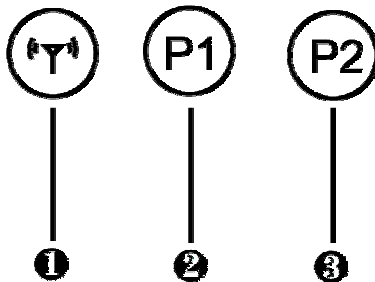

1. Wireless LAN Button      2. Easy Button 1      3. Easy Button 2

- **Wireless LAN Button**  
Push this button to activate or inactivate the Wireless LAN. When you activate the wireless LAN function, it will search the wireless LAN signal automatically if you had installed the driver.
- **Easy Button 1**  
You can define the specific function by yourself to active the program. For example, you can define it to access the outlook 98/2000/2002... utility just by pressing this button. You can simplify several procedures in entering into Outlook 98/2000/2002... environment. For more understanding and interesting, you can refer Section 2.5 to recognize the driver installation procedures in activating Easy Button 1.
- **Easy Button 2**  
You can define the specific function by yourself to active the program. For example, you can define it for providing a very convenient way in connecting Internet only by pressing this button. For more understanding and interesting, you can refer Section 2.5 to recognize the driver installation procedures in activating Easy Button 2.



## 1.4 The Front Side of the Notebook

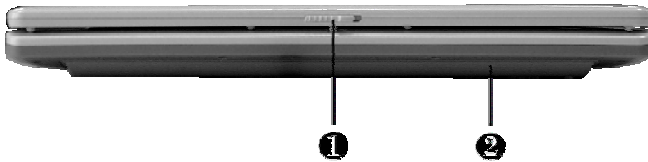

1. Cover Switch

2. Battery

- **Cover Switch**  
The cover (LCD panel) is locked when it is closed. Slide the button right aside to release the latch for opening the cover of the computer.
- **Battery**  
The battery provides the power for the N/B when there is no AC power available. Please refer to chapter 2.1 for how to attach and detach the battery.

## 1.5 The Rear Side of the Notebook

The system ports at the back of your notebook computer can connect various devices. Each port is described as followings.

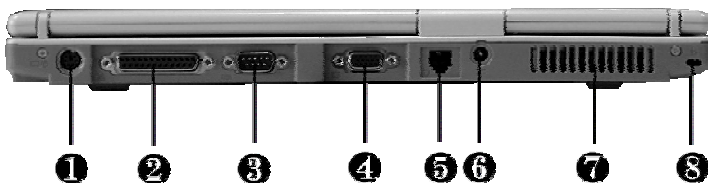

1. PS/2 Port

2. Print Port

3. COM Port

- 4. VGA Port
- 5. Modem Port
- 6. DC-In Port
- 7. Air-Outlet Vent
- 8. Locking Device Keyhole

- PS/2 Port

Lets you connect an external PS/2-style mouse, PS/2-style keyboard, or PS/2-style numeric keypad to the system. With an optional Y-cable adapter, you also can connect any combination on two of these devices simultaneously.

- Print Port

Use this port to connect a parallel printer or other parallel device. The parallel port supports Enhanced Capabilities Port (ECP) standard. The standard provides you with a greater processing speed than the conventional parallel port. The port also supports bi-directional protocols.

 *The default setting for the parallel port on your notebook computer is set to Enhanced Capabilities Port (ECP). Some older parallel devices may not function with the ECP default setting. You may need to adjust the setting to accommodate your parallel device by changing the BIOS setting.*

- COM Port

Lets you connect a 9-pin external serial device such as a PDA, mouse, or other serial devices.

- VGA Port

Lets you attach an external CRT monitor for wider display. You can run the LCD display and the external CRT monitor simultaneously or switch it to CRT only using the display hot-key.

- Modem Port

A 56K internal fax/data modem is installed. It keeps you connected to the outside world through networks.

- **DC-In Power Port**  
Lets you connect the AC power adapter in supplying continuous power to your notebook and recharging the battery.
- **Air-Outlet Vent**  
Emits the heat out of your computer and keeps it within operating temperature.
- **Locking Device Keyhole**  
Lets you attach a Kensington security system or a compatible lock to secure your notebook computer.

## 1.6 The Left Side of the Notebook

The left side of your notebook computer provides the features shown in the following figure.

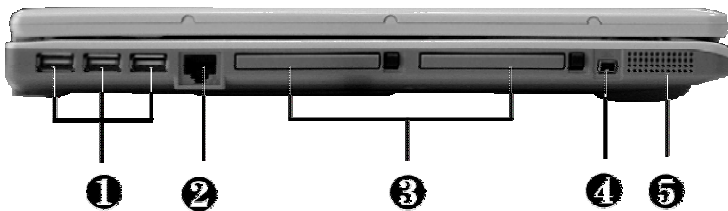

- |                             |              |
|-----------------------------|--------------|
| 1. USB Port                 | 2. LAN Port  |
| 3. PC Card Slot             | 4. IEEE 1394 |
| 5. Built-in Stereo Speakers |              |

### Left Side Features

- **USB Port**  
The Universal Serial Bus (USB) port allows you to connect up to 127 USB-equipped peripheral devices (for example, printers, scanners and so on) to your notebook computer.
- **LAN Port**  
An internal 10Base-T/100Base-TX LAN module connects your computer to other computers/networks through a local area network (LAN).
- **PC Card Slot**
  - ➔ Lets you connect various PC cards such as memory card
  - ➔ Supports both 3V, 5V 32-bit CardBus and 16-bit PC cards.

- IEEE 1394  
IEEE 1394 port is a high speed I/O port that can transfer high levels of data in real-time, such as external hard disk, Digital Video Camera.
- Built-in Stereo Speakers  
Integrated left and right mini stereo speakers located at the two sides of the N/B for sound and audio output for your multimedia presentations or listening pleasure.

## 1.7 The Right Side of the Notebook

The right side of the notebook computer offers the features shown in the following figure.



1. Built-in Stereo Speakers
2. Volume Control
3. Microphone Jack
4. Headphone Jack
5. Optical Disk Drive.

### Right Side Features

- Built-in Stereo Speakers  
Integrated left and right mini stereo speakers located at the two side of the N/B for sound and audio output for your multimedia presentations or listening pleasure.
- Volume Control  
Allows you to control the speaker volume.

- **Microphone Jack**  
Allows you to connect an external microphone for monophonic sound recording directly into your notebook computer.
- **Headphone Jack**  
Lets you plug in a stereo headphone, powered speakers, or earphone set with 1/8 inch phono plug for personal listening.
- **Optical Disk Drive**  
Allows you to load and start programs from a compact disc (CD) or a digital video disc (DVD) and play conventional audio CDs. It also can make CD by using CD-R or CD-RW.

## 1.8 The Underside of the Notebook

The bottom of the notebook computer offers the following features.

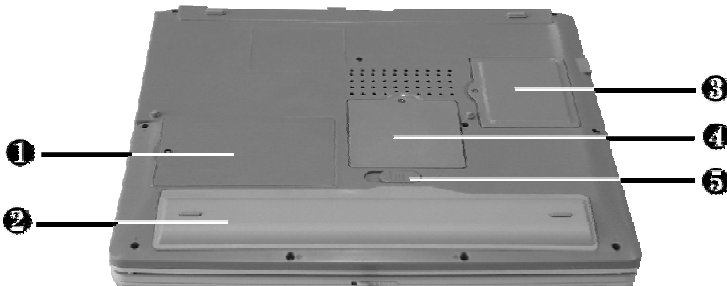

1. Hard Disk Compartment
2. Battery Bay
3. Wireless LAN Compartment
4. Memory Compartment
5. Battery Release Latch

### Bottom of the System

- **Hard Disk Compartment**  
Open this cover of this compartment to replace with other Hard Disk Drive. Please refer to Chapter 7 for how to replace it.
- **Battery Bay**  
Equipped with a choice of Lithium-Ion (Li-Ion) battery pack.
- **Wireless LAN Compartment**  
Provides optional wireless LAN card inserted into this compartment for executing relative functions.
- **Memory Compartment**  
Remove the screw to find two DIMM slots. One is inserted with DDR SDRAM memory board configured by the factory. The other is empty for upgrade use.
- **Battery Release Latch**  
Push the latch to the left end to remove the battery pack.

## 1.9 Notebook Accessories

### *AC Adapter*

The AC Adapter supplies external power to your notebook computer and charges the internal battery pack simultaneously. The AC adapter has an auto-switching design that can connect to any 100VAC ~ 240VAC power outlets. You just change the power cord if you are going to use your notebook in other countries with different connector outlets.

When you connect the AC adapter, it charges the battery whether or not the notebook computer is powered on.

## ***Battery Pack***

Aside from the AC adapter, your computer can also be powered through the internal battery pack. The battery pack uses rechargeable Lithium-Ion (Li-Ion) battery cells that provide long computing hours when fully charged and power management enabled. You should always leave the battery inside your computer even when using the AC adapter as it also acts as a back-up power supply in case power from the AC adapter is cut off. It is also very important to have the battery pack always charged to prevent battery cell degradation.



## 2 Getting Started

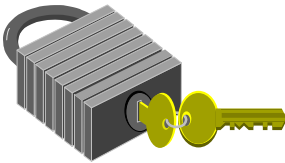

**Y**our Notebook is designed and pre-configured for easy setup and use. This chapter describes the installation steps you should follow to get the notebook up and running as quickly as possible. Contact your dealer if they have pre-installed all the needed drivers to fully operate your computer or if there is an update on the driver installation of the notebook.

## 2.1 Using the Battery Pack

The notebook is designed to operate with one of the following power sources:

- With AC power using the AC adapter connected to an electrical outlet.
- With a Lithium-Ion (Li-Ion) battery pack.

You should use the AC adapter whenever it is possible, relying on the battery pack only when AC power is unavailable.

Before you use your notebook computer, install and recharge the battery pack first. The rechargeable Li-Ion battery pack allows you to operate the notebook without an external power source. When you connect the AC power adapter, the battery immediately starts to recharge. Normal battery life is 4 hours for Lithium-Ion (Li-Ion) battery pack.

For maximum battery performance, fully discharge the battery first before recharging it when you start to use it first time. To do so, unplug the AC adapter, turn off power management features (through Setup and Windows), and turn on the system. Once the battery is fully discharged, plug in the AC adapter and recharge the battery.

If you do not discharge the battery completely, it fails to accept a full recharge.

 ***Li-Ion battery is vulnerable, do not charge it with other power adapter, or it may cause fire or explosion.***

### ***Installing the Battery Pack***

This notebook provides the most convenient way to install the battery pack into your computer. With the extended nose directed toward the compartment, insert and push the battery pack.

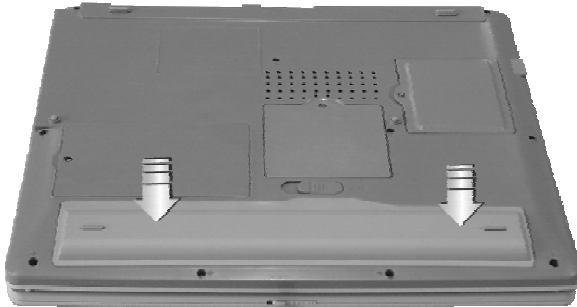

### ***Removing the Battery Pack***

To remove the battery pack, slide the latch to the end of left side to pop-out the battery pack, and then take out the battery pack with your finger.

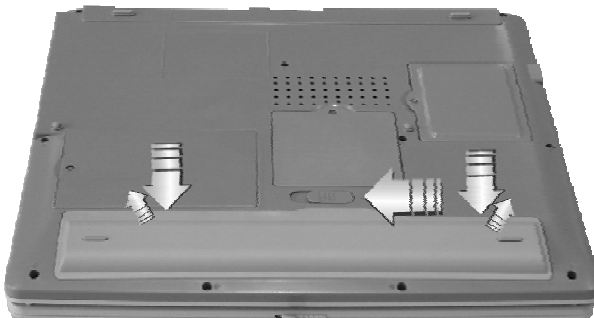

## ***Replacing the Battery Pack***

When your notebook estimates that the battery only has enough charge to continue for a few minutes, it will alert you with a battery low warning beep. If you are consuming a lot of power by using the audio system, the PCMCIA slots, the hard disk drives, and optical disk drive, your notebook might run out of charge much sooner than you expect. You should always respond to the battery low indication by connecting to AC power or turning off your notebook, or suspending your notebook to disk. If you do not do so, the notebook will automatically suspend to disk and turn off. The contents of the memory will store in the hard disk drive. You will be unable to restart the notebook until you have connected to the AC adapter or installed a charged battery. To replace the battery pack, refer to the previous sections on "Installing the Battery Pack" and "Removing the Battery Pack."

 *For Window 2000/XP, the suspend mode (Hibernate or Standby) can be chosen at Power Options of Windows's Control Panel)*

 *Be sure to save your data before replacing the battery pack or connecting the AC adapter. Failure to do so can result in data loss.*

## **EXTENDING BATTERY LIFE**

---

It is important to be aware of the simple things for extending the life of the system main battery while you are on the road. You should find a working place where the external lighting is not too bright and turn down the screen brightness. Also, you can choose the available mode on the Power Management item of the Control Panel in Windows.

## 2.2 Connecting the AC Power Source

The AC adapter provides external power source to your computer and charges the internal battery pack at the same time. The AC adapter also has an auto-switching design that can connect to any 100VAC ~ 240VAC power outlets.

To connect the power adapter:

1. Plug the AC power cord into the power socket of the AC power adapter.
2. Plug the other end of the AC power cord to a live AC wall outlet.

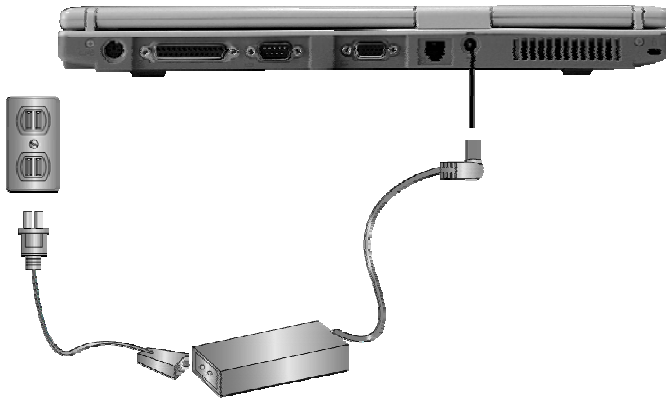

3. Plug the connector of the AC adapter to the DC-IN port found at the rear side of the computer.

**☛** *Whenever possible, it is advisable to always have the AC adapter connected to the notebook and the battery pack installed. This ensures continuous power supply and prevents any data loss incurring from sudden power breakdown.*

- *For the power supply of this equipment, an approved power cord has to be used.*
- *Make sure the socket and any extension cord(s) you use can support the total current load of all the connected devices.*
- *Before cleaning the computer, make sure it is disconnected from any external power supplies (i.e. AC adapter).*

## 2.3 Starting Your Computer

The Power/Resume button is found on the top of the base unit. Press the Power/Resume button to start your computer and check that if the Power LED turns on.

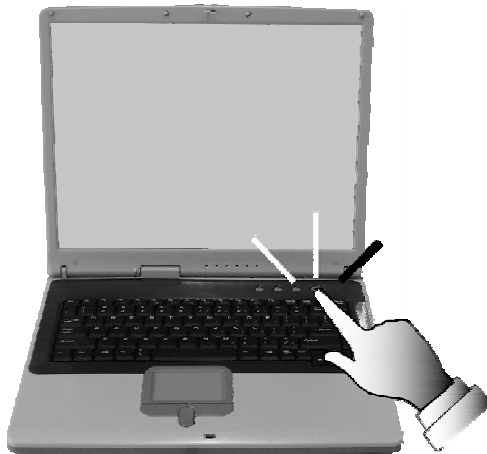

After a few seconds, the computer's display will turn on and your computer will begin to execute the Power On Self Test or POST to check if all system components are running properly. Any error found during the test will be displayed on the screen and may generate short beep sound as well.

After the test, the screen will also display a message "**press <F2> to enter SETUP**". You don't need to run this program at the moment as your dealer already made the necessary settings for your computer optimal operation. Refer to Chapter 6 on running the SETUP program later.

After the test has completed, your computer will start to search and boot up the operating system from your hard drive. The notebook computer normally comes with a Windows operating system pre-installed in your hard drive. Consult the Windows manual on how to use the program. If not, contact your dealer for assistance.

## 2.4 Adjusting the Display Controls

The LCD brightness adjustment is controlled by <Fn> +<F8> and <Fn> + <F9> keys respectively. You need to press these hot-key controls after powering on your notebook to suit your viewing pleasure.

The Brightness hot-key control adjusts the brightness on the LCD. The brightness hot-key control will not set the LCD completely dark or bright; it provides sufficient lighting to the LCD to match the external lighting of the surrounding. The brighter the room, the more you need to increase the brightness of the LCD.

## 2.5 Installing the Notebook Device Drivers

If you already have an operating system installed into your notebook computer, it is best to install the needed device drivers for using the built-in devices of your computer. Before installing the drivers, check with your dealer

first if they have already installed all the drivers along with the operating system. If not, follow the procedures below:

## **INSTALLING WINDOWS XP FROM OPTICAL DISK DRIVE**

---

To install Windows XP directly from your optical disk drive, please go to **Boot** menu of **BIOS** setup menu. Use arrow key to select "CD-ROM Drive", then use "+" or "-" to move it to the top. Go to **Exit** menu and select "**Exit Saving Changes**". Accordingly, insert the Windows XP installation CD into optical disk drive with following the instructions on the screen to finish the installation.

## **INSTALLING THE CHIPSET DRIVER**

---

Your notebook computer uses the advanced chipset. Installing the driver to enhance the stability and performance.

### *Installing Chipset device driver for Windows XP*

1. Click the **Start** button, then point to **Run**. The **Run** dialog box appears.
2. Click the **Browse** button and specify the directory as.  
"E:\Drivers\WinXP\Chipset\Setup.exe".
3. Click "**OK**" to execute the setup program. The **Setup** box appears.
4. Click "**Next**" continuously to install this driver when screen displays this command.
5. Click "**Yes**" to accept the License Agreement .
6. Click "**Next**" to continue the following step.
7. Tick the option "**Yes, I want to restart my computer now.**",  
and press **Finish** to restart your system.