

APR-06-1999 14:30

# TYCO Oscar's Radio Control Raceway

## INSTRUCTION SHEET

Before starting, your toy requires (1) 9 volt battery, (4) "AA" batteries and a Phillips screwdriver (not included) for assembly.

### How to Install the Batteries

#### Step ① Remote Control

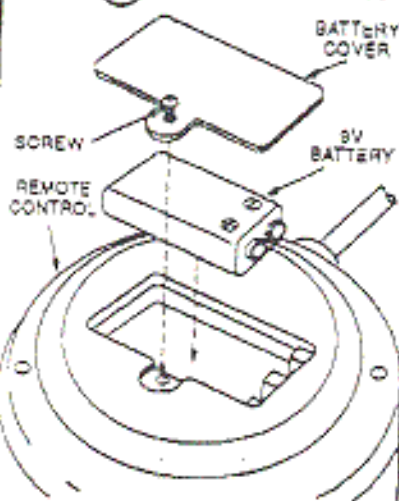

- Unscrew the battery cover on the back of the remote control, using a Phillips screwdriver and remove.
- Insert (1) 9 volt alkaline battery into the battery compartment carefully noting the direction of the (+) and (-) symbols as shown.
- Replace the cover and tighten the screw.

#### Step ② Oscar's Race Car

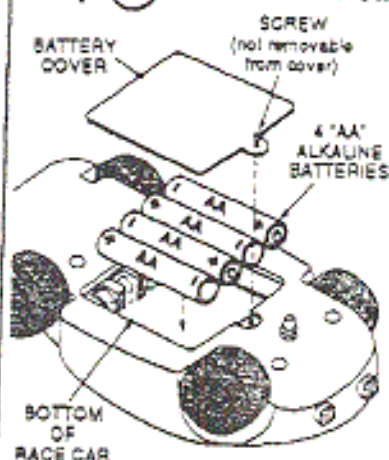

- Take Oscar's Race Car and turn it upside down.
- Unscrew the battery cover on the bottom and remove.
- Insert 4 "AA" size alkaline type batteries into the battery compartment as shown, carefully noting the direction of the (+) and (-) symbols.
- Replace the cover and tighten the screw.

### How the Race Car works

#### Step ③ How to turn car ON

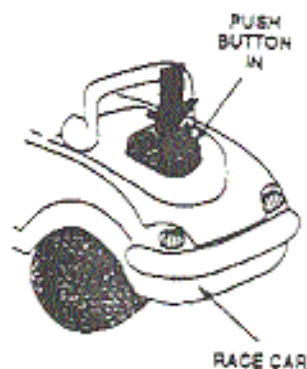

- To turn Oscar's Race Car "ON", push in the Button on the front hood of the car as shown.

Note: This button is not an "ON-OFF" switch. The Race Car will automatically turn itself off after 3 minutes of not being used

#### Step ④ How the Remote Control Works

##### BUTTON A

This button, when pressed, will help you steer the race car onto a different lane when approaching the various intersections of your raceway.

##### BUTTON B

Pressing the top arrow will make the car go forward. Pressing the bottom arrow will make the car go in reverse.

##### BUTTON C

When you press this button a car horn will sound.

Note: The remote control has no ON-OFF switch but instead has a sleep mode which turns itself ON automatically when you start playing with the buttons

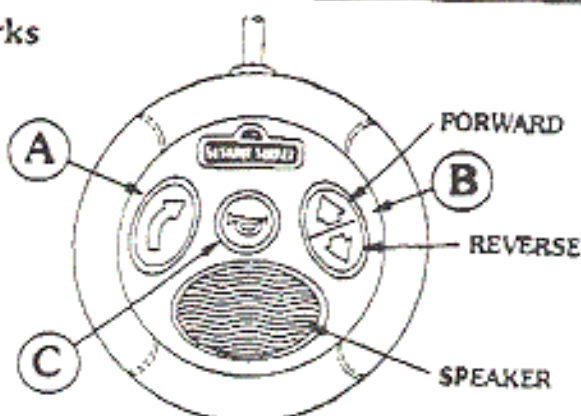

MAR 27 10/1999

TO: TN YUNG CA/04/99 No. 39237  
FM: Nick S.

TO: TN YUNG 04/06/99

APR-06-1999 14:31

8

### Step 5 How to snap the track together

- A. The track pieces snap together easily by holding an end with Slots on top of an end with Locking Tabs.
- C. Carefully line up both ends as shown and push the track with the Slots down firmly until they lock together.
- Note: Always assemble your track on a hard, flat surface.

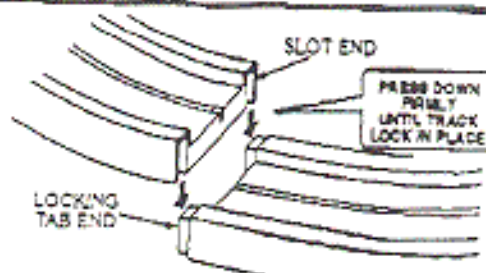

### Step 6 Assemble the entire track layout as shown below

- A. Carefully assemble all the track, as shown at right.
- Note: Assemble the accessory pieces to the track layout after you assemble the entire layout.

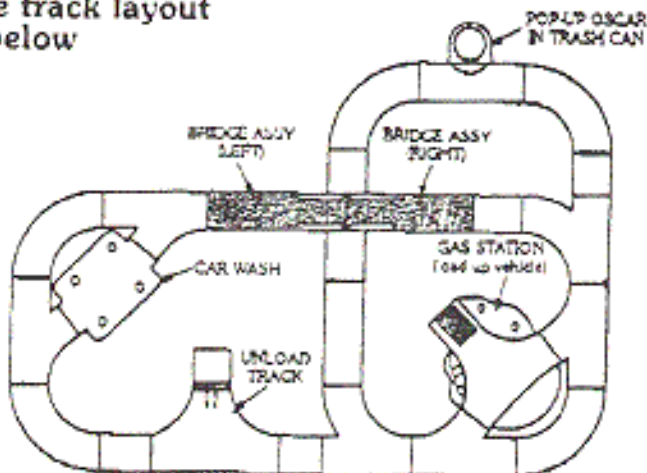

## HOW TO ASSEMBLE ACCESSORIES

### Step 7 Assemble Service Station

- A. First locate the Service Station
- B. Align the Posts under the Station over the holes in the Service Station track and press down firmly until they snap in place.
- C. Make sure the Gas Pump is securely pressed in place on the track.

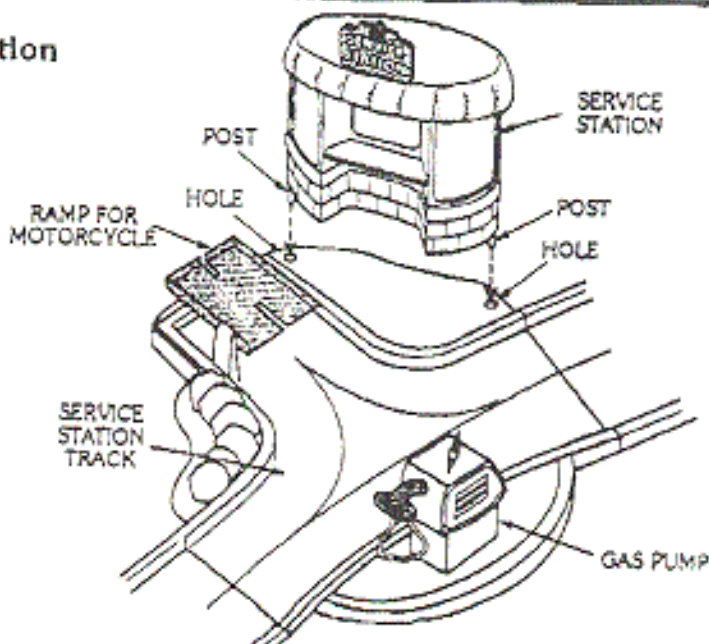

MARCH 19, 1999

2

TO: TN YUNG 04/06/99  
FM: Nick S.



APR-26-1999 14:32

**Step 8 Assemble the Car Wash Accessory**

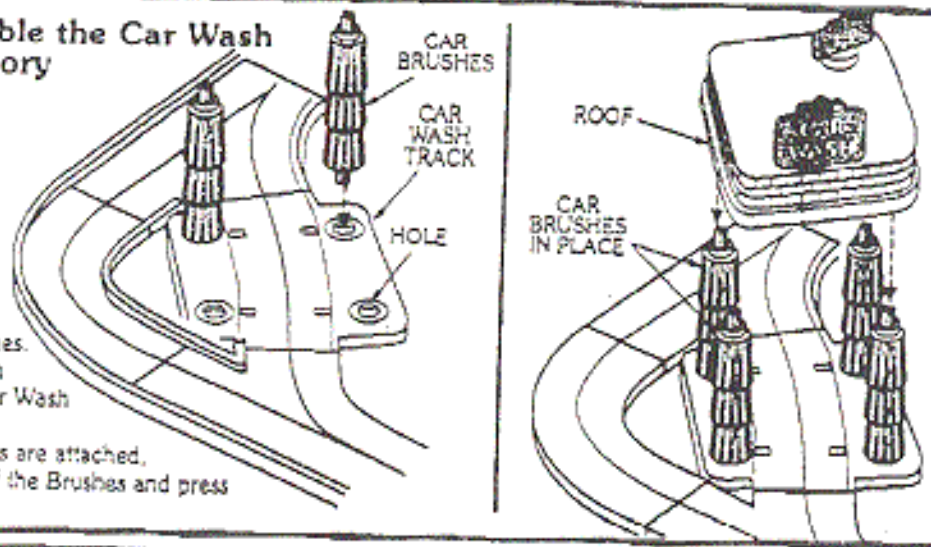

- A. Locate the (4) Car Brushes.
- B. Press all 4 Brushes down into the holes on the Car Wash Track as shown.
- C. When all the Car Brushes are attached, place the Roof on top of the Brushes and press firmly in place.

**Step 9 How to Attach Race Car to Trailer**

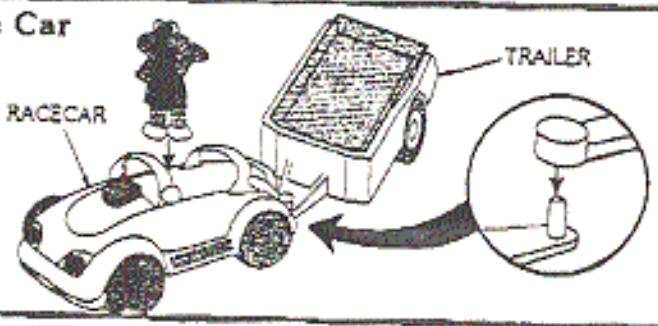

- A. Locate the Race Car and the Trailer.
- B. Attach the two together as shown in the inset drawing.
- C. Place these two pieces on the track layout and place Elmo or one of the other characters in the Race Car.

**Step 10 How to load the Motorcycle onto the Trailer**

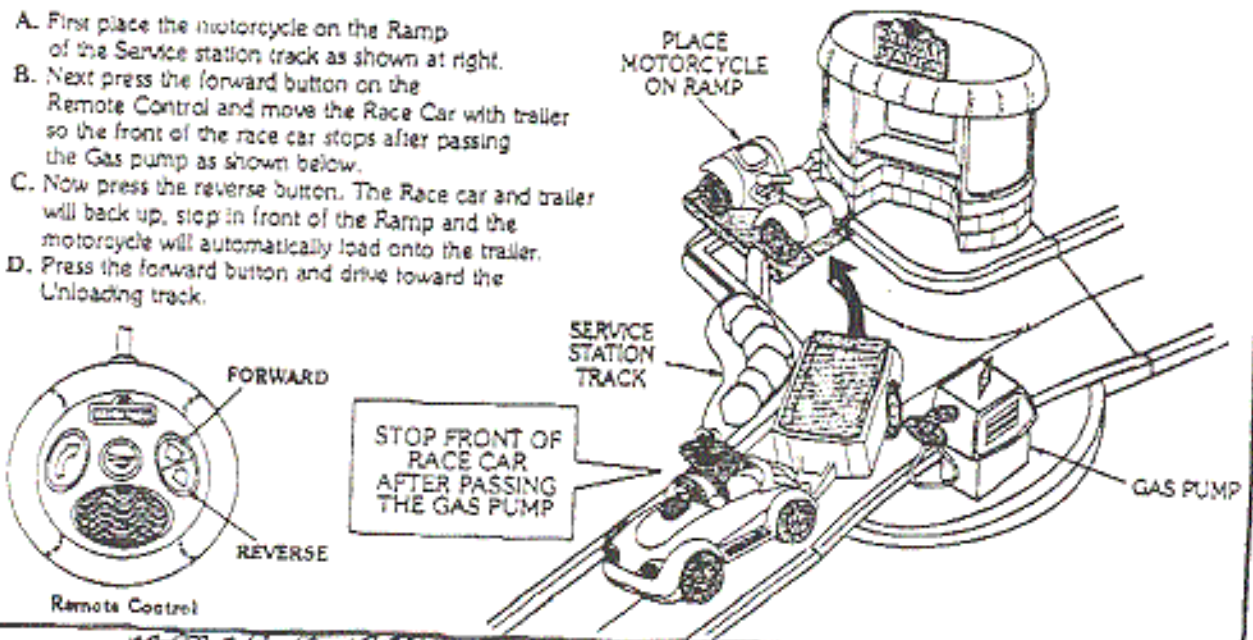

- A. First place the motorcycle on the Ramp of the Service station track as shown at right.
- B. Next press the forward button on the Remote Control and move the Race Car with trailer so the front of the race car stops after passing the Gas pump as shown below.
- C. Now press the reverse button. The Race car and trailer will back up, stop in front of the Ramp and the motorcycle will automatically load onto the trailer.
- D. Press the forward button and drive toward the Unloading track.

MARCH 10, 1999  
 04/06/99

TO: TN YUNG  
 FROM: ALEX S.

5D

APR-06-1999 14:33

### Step 11 How to unload the Motorcycle from the Unloading Track

- A. While still pressing the forward button on the remote control, drive the race car so the front of the car stops just after passing the Unloading Track.
- B. Now press the reverse button. The Race car and trailer will back up, and stop at the Unloading Ramp. The motorcycle will automatically roll off the trailer and down the Unloading Ramp.

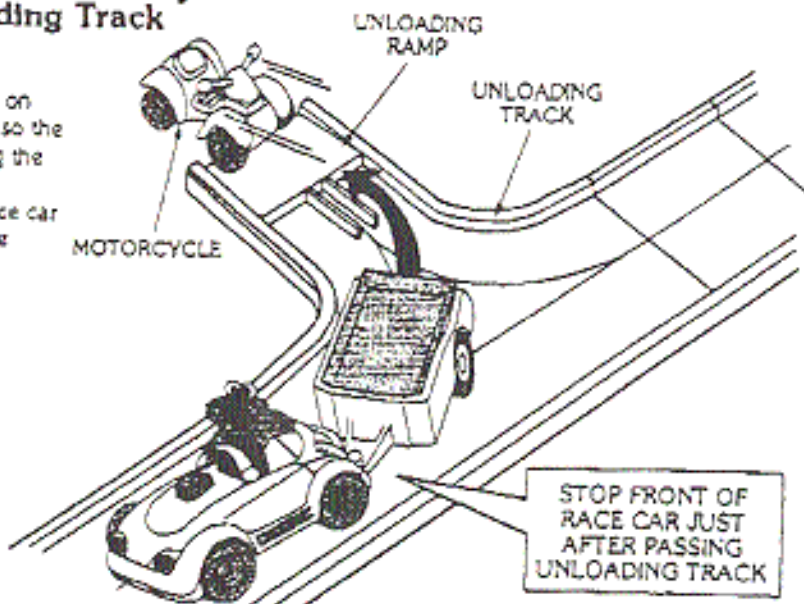

TO:  
TJUNG  
YUNG  
FROM:  
NICKS  
09/00/1999

### Step 12 Assemble Accessory Items

**Note:** Now that we've explained how to operate your Remote Control Raceway you can now assemble the various accessory items like the Stop Sign, Traffic Light, etc. included in this set into the various mounting holes located around the raceway.

- The drawing shown at right will show you where to place the various pieces by simply pressing them in place.

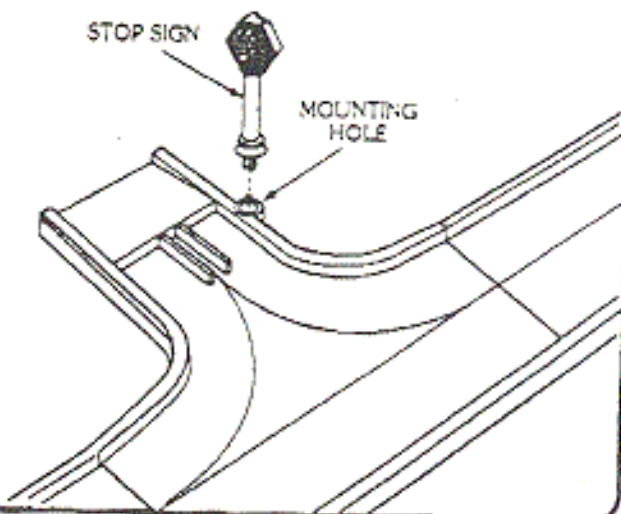

#### CAUTION

- Non-rechargeable batteries are not to be recharged.
- Rechargeable batteries are to be removed from the product before they are charged.
- If removable rechargeable batteries are used, they are only to be charged under adult supervision.

- Do not mix alkaline, standard (carbon-zinc) or rechargeable (nickel-cadmium) batteries.
- Do not mix old and new batteries.
- Only batteries of the same or equivalent type as recommended are to be used.
- Be sure to insert batteries with the correct polarities and always follow the toy and battery manufacturers' instructions.

- Exhausted batteries are to be removed from the product.
- The supply terminals are not to be short-circuited.

#### FCC NOTE TO CONSUMERS

Changes or modifications to this unit not expressly approved by the party responsible for compliance could void the user's authority to operate the equipment.