

Fisher-Price®

Sweet Dreams Monitor

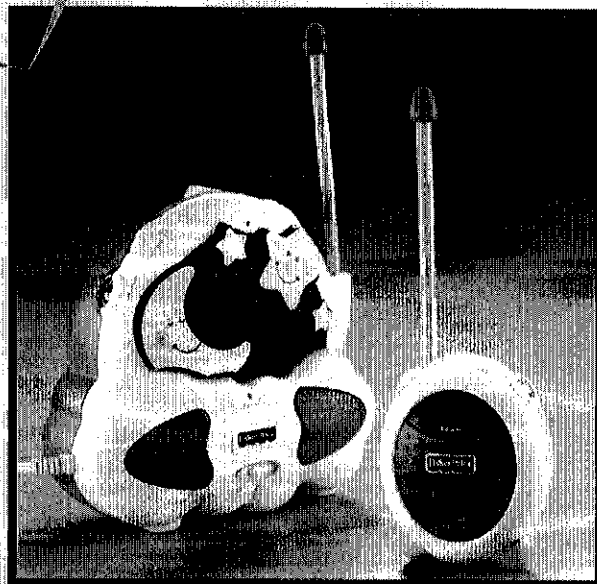

Model Number: B9638

For proper set-up and use, please read these instructions.

Please keep this instruction sheet for future reference,
as it contains important information.

Transmitter is electrically powered.

Receiver is powered by the AC adaptor (included, plugs
into standard household outlets 120V AC). Receiver
also runs on battery power (9V alkaline battery - not included).

Requires one PR12 light bulb (included).

An adult must install the battery (if used) and replace the light bulb.

Tool needed for battery installation and
light bulb replacement: Phillips screwdriver.

www.fisher-price.com

IMPORTANT!

CAUTION

This product cannot replace responsible adult supervision.

- This product is not intended to be used as a medical monitor and its use should **not** replace adult supervision.
- Test sound reception of receiver before first-time use and whenever you change location of transmitter.
- To prevent entanglement:
 - Never place transmitter in a crib or playpen. Keep transmitter and receiver out of baby's reach.
 - Never use extension cords with the AC adaptor.
- Never use transmitter or receiver near water (ie.: bathtub, sink, laundry tub or wet basement, etc.).
- Always use transmitter and receiver where there is adequate ventilation. To prevent overheating, keep transmitter and receiver away from heat sources such as radiators, heat registers, direct sunlight, stoves, amplifiers, or other appliances which produce heat.
- Never attempt to modify this product.

Consumer Information

Occasionally a consumer may experience a problem with one of our products. If this should happen, please call us toll-free, rather than return this product to the store. Usually, we can solve the problem over the telephone or send you replacement parts.

Please call Fisher-Price® Consumer Relations, toll-free at **1-800-432-5437**, between 8 AM - 6 PM EST, Monday through Friday. Hearing-impaired consumers using TTY/TDD equipment, please call 1-800-382-7470.

Or write to:
Fisher-Price® Consumer Relations
636 Girard Avenue
East Aurora, New York 14052

Receiver Battery Installation (Optional)

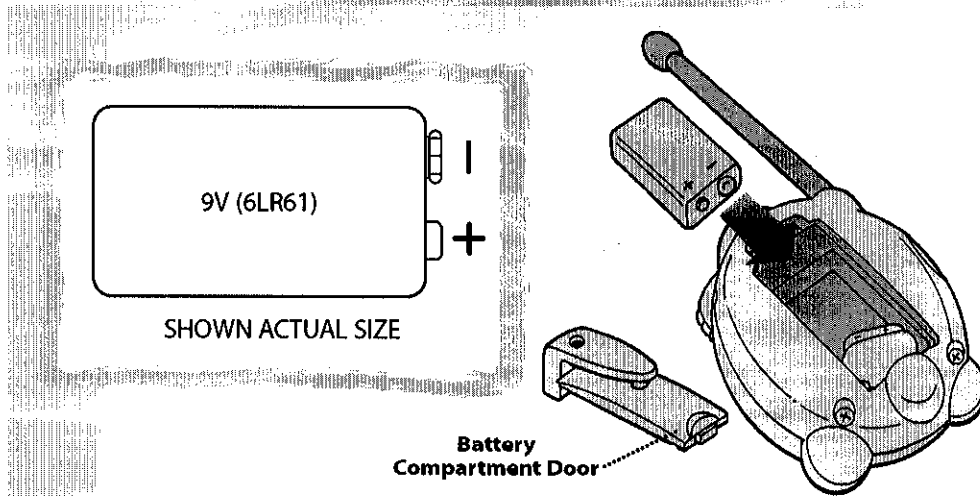

- Locate battery compartment door on back of receiver.
- Loosen screw in battery compartment door with a Phillips screwdriver. Lift to remove battery compartment door.
- Snap terminals of a fresh, 9V **alkaline** battery into receiver connectors.
- Replace battery compartment door and tighten screw. Do not over-tighten.

Battery Safety Information

Batteries may leak fluids that can cause a chemical burn injury or ruin your product. To avoid battery leakage

- Insert battery as indicated inside the battery compartment.
- Remove battery during long periods of non-use. Always remove an exhausted battery from the product. Dispose of battery safely. Do not dispose of battery in a fire. The battery may explode or leak.
- Never short-circuit the battery terminals.
- Use only a battery of the same or equivalent type, as recommended.
- Do not charge a non-rechargeable battery.
- Remove a rechargeable battery from the product before charging.
- If a removable, rechargeable battery is used, it is only to be charged under adult supervision.

Testing Sound Reception

Test transmitter transmission and receiver reception.

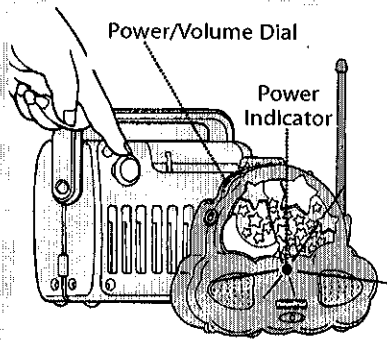

Place transmitter in room in which you intend to use it. Rotate transmitter power/volume dial to turn power on. Turn on a radio.

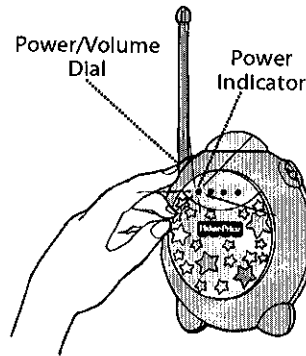

Place receiver in room in which you intend to use it. Rotate power/volume dial to turn power on. Adjust receiver location.

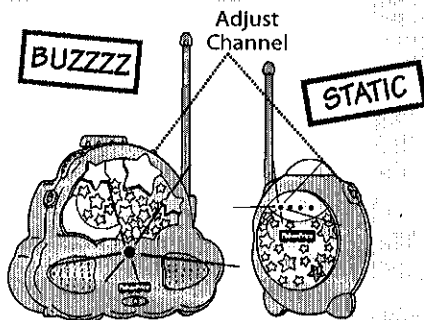

- Variable light display lights when sound is received receiver:
 - One or two dots light for shallow sounds.
 - Three or more dots light for louder sounds.
- If you experience interference (buzzing or static, etc.) while using one channel setting, switch **both** units to other channel. Selecting a channel is usually a one time adjustment.

Hint: All four dots in receiver variable light display light:

- If you turn receiver power on before transmitter power, you will also hear static noise. Turn volume down and turn transmitter power on.
- If the receiver is too far away from the transmitter, move the receiver closer to the transmitter.
- If loud sounds are transmitting.

Setup & Use

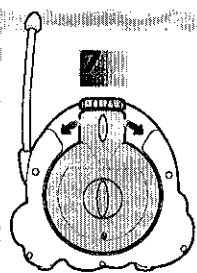
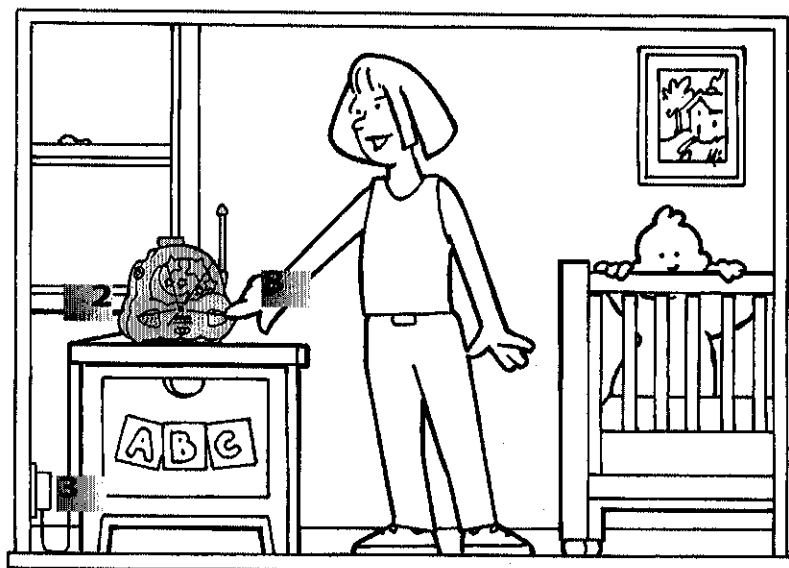

Back View
Transmitter

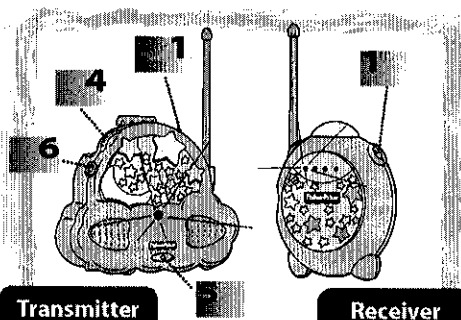





Transmitter

Receiver

Setup & Use

IMPORTANT! Test sound reception of this monitor before first time use and whenever you change location of transmitter (see page 5).

- 1 Set transmitter channel switch to same channel as receiver.
- 2 Place transmitter in same room with child. Point microphone directly toward crib or play area.
- 3 Unwrap and fully extend power cord for best transmission. Insert power cord plug into wall outlet.
- 4 Rotate transmitter power/volume dial to turn power on. Power indicator lights.
- 5 Choose a **soothing mode:**
 -  Light only
 -  Light and Music
 -  Light and Nighttime Nature Sounds
- 6 Choose a **light mode:**
 -  Ceiling Light Show
 -  Night Light
- 7 If you chose Ceiling Light Show (**proj.**), adjust projector on the back of transmitter so that it projects on ceiling over baby's crib.
- 8 Press soothing button on transmitter to activate your selection. Rotate power/volume dial to adjust volume. Light/music/nature sounds will turn on for about five minutes and then automatically turn off. If you'd like to immediately turn off light/music/nature sounds, press soothing button on transmitter again.

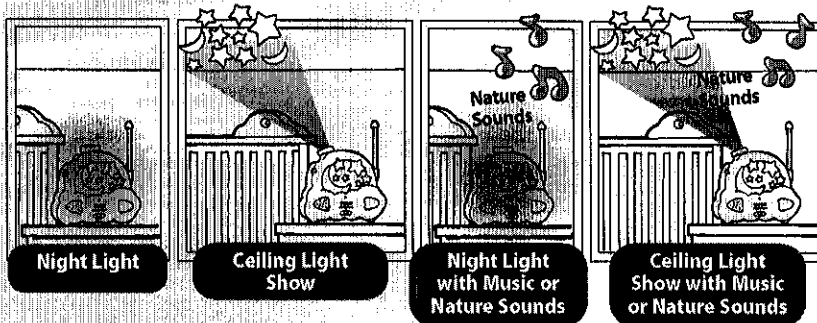

Setup & Use

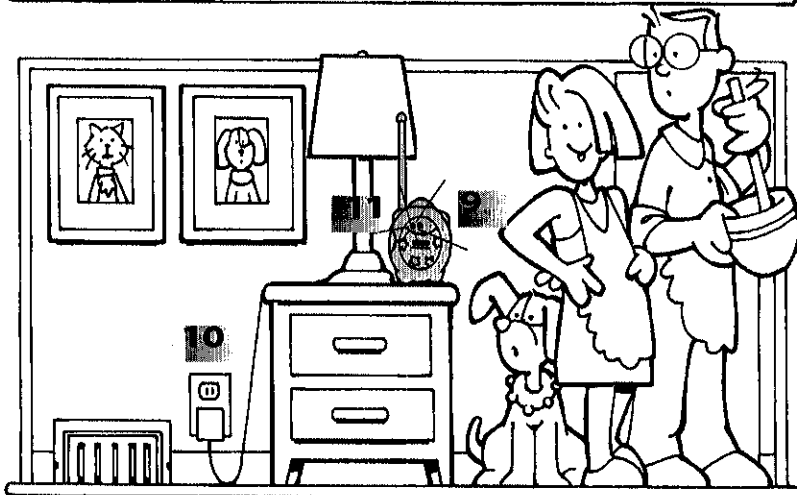
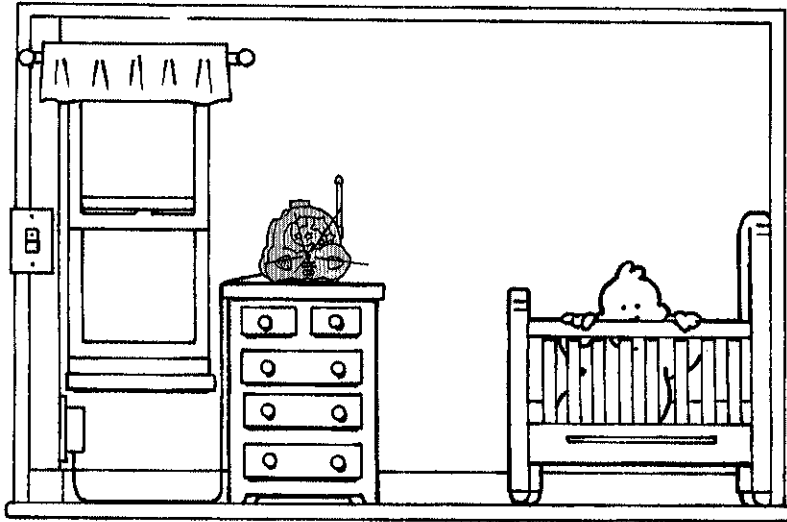

Setup & Use

- Place receiver where you will see or hear it.
- Unwrap and fully extend AC adaptor cord for best reception. Insert AC adaptor jack into receiver socket and plug into wall outlet.
Note: To use a 9V alkaline battery for power source, refer to "Receiver Battery Installation" instructions on page 4.
- Rotate remote control receiver power/volume dial to turn power on. Power indicator lights. Rotate power/volume dial to adjust volume.

Note: AC adaptor is 120 VAC, 60Hz, 3W input; 6 VDC 100mA output; center positive polarity; plug OD is 5.5 mm, plug ID is 1.5 mm.

One (1) Year Limited Warranty

Fisher-Price, Inc., 636 Girard Avenue, East Aurora, New York 14052 warrants that the Sweet Dreams™ Monitor is free from all defects in material and workmanship when used under normal conditions for a period of one (1) year from the date of purchase. Should the product fail to perform properly, we will repair or replace it at our option, free of charge. Purchaser is responsible for shipping the product to Consumer Relations at the address indicated above and for all associated freight and insurance cost. Fisher-Price, Inc., will bear the cost of shipping the repaired or replaced item to you. This warranty is void if the owner repairs or modifies the product. This warranty excludes any liability other than that expressly stated above including but not limited to any incidental or consequential damages.

SOME STATES DO NOT ALLOW THE EXCLUSION OR LIMITATION OF INCIDENTAL OR CONSEQUENTIAL DAMAGES, SO THE ABOVE LIMITATION OR EXCLUSION MAY NOT APPLY TO YOU.

THIS WARRANTY GIVES YOU SPECIFIC LEGAL RIGHTS, AND YOU MAY ALSO HAVE OTHER RIGHTS WHICH MAY VARY FROM STATE TO STATE.

Replacing the Light Bulb (Glass Bulb)

IMPORTANT! Should light bulb become non-functional, you are advised to remove and replace it. This should be carried out away from child's sleep or play area.

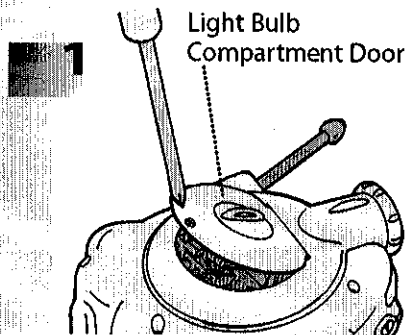

- Loosen screws in light bulb compartment door with a Phillips screwdriver.
- Lift to remove light bulb compartment door.

Hint: You may need to fit a flat edged object to pry light bulb compartment door up.

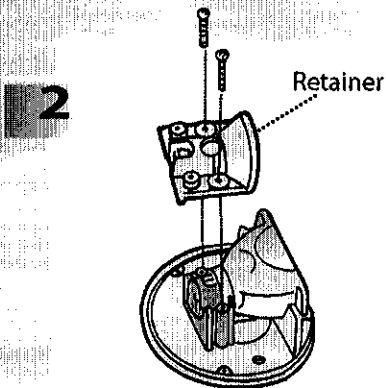

- Turn light bulb compartment door so that inside faces up.
- Loosen and remove two screws in the retainer with a Phillips screwdriver.
- Remove retainer.

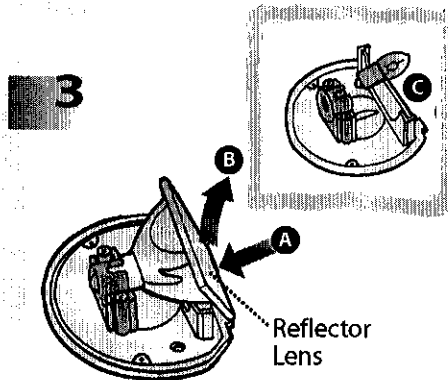

- While pressing lens of reflector **A**, lift it **B** from light bulb compartment cover.
- Remove and properly discard light bulb **C**.
- Replace light bulb with a new PR12 or equivalent light bulb.

Note: When replacing light bulb, be sure to discard light bulb properly. Beware of cracked or broken glass.

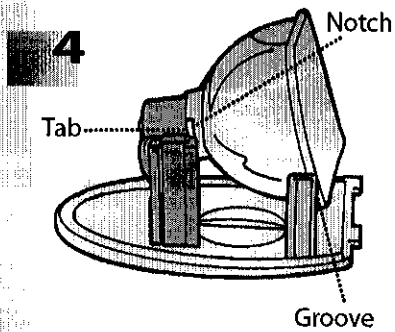

- At an angle, fit reflector over new light bulb.
- Align notch in reflector with tab in light bulb receptacle.
- Push reflector lens slightly and fit reflector edges into grooves in light bulb compartment cover.

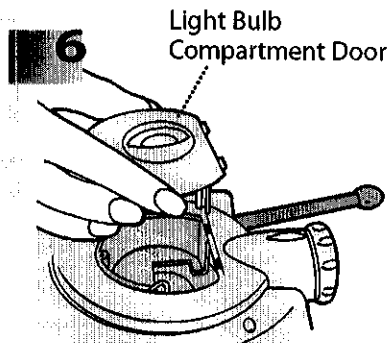

- Fit light bulb compartment door into back of transmitter. Press light bulb compartment door to "snap" into place.
- Tighten screws in light bulb compartment door with Phillips screwdriver. Do not over-tighten.

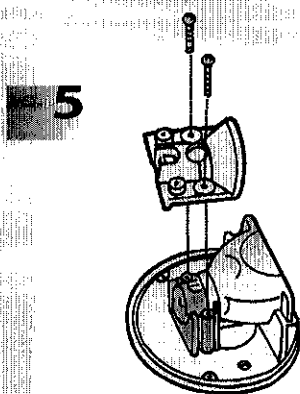

- Replace retainer and insert two screws.
- Tighten screws with a Phillips screwdriver. Do not over-tighten.

Problems & Solutions

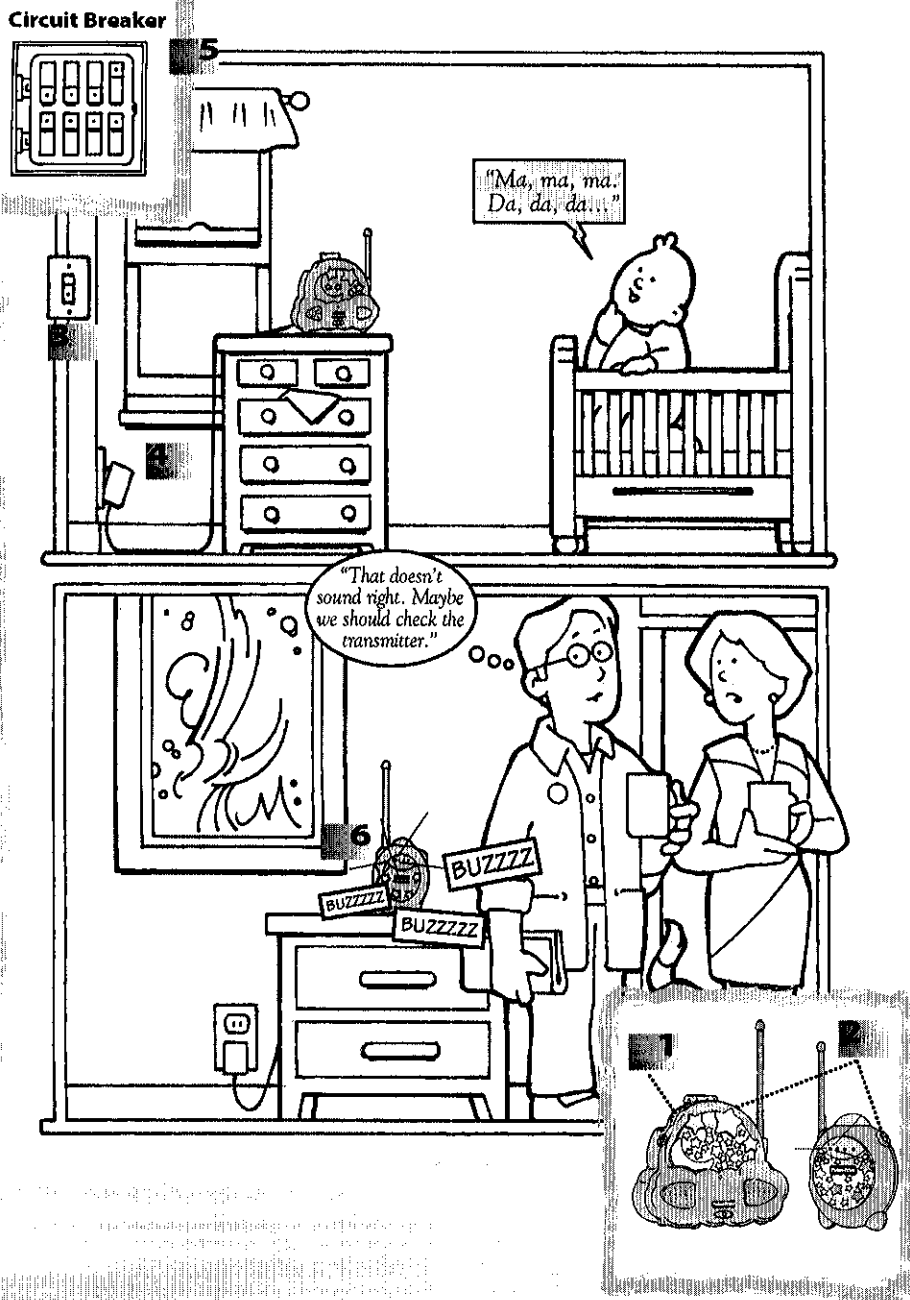

Problems & Solutions

PROBLEMS

- 1 Transmitter power indicator not lit.
- 2 You hear static or buzzing from remote control receiver.
- 3 Transmitter power indicator not lit.
- 4 Transmitter power indicator not lit.
- 5 Transmitter power indicator not lit.
- 6 You hear static or buzzing and all four dots lit on remote control receiver.

SOLUTIONS

- 1 Turn transmitter power on. Power indicator lights.
- 2 Make sure channel switches on both transmitter receiver are set to same channel.
- 3 Make sure light switch that controls power flow to wall outlet is on.
- 4 Check transmitter power cord plug-to-outlet connection.
- 5 Power is off because circuit breaker for baby's room is off. Make sure house fuses and circuit breakers are on.
- 6 Check all five solutions above. Any one or more of these solutions should solve the problem.

Hint: If, after checking all of these solutions, you believe that your transmitter power cord or AC adaptor is damaged, please call Fisher-Price® at 1-800-432-5437.

Problems & Solutions

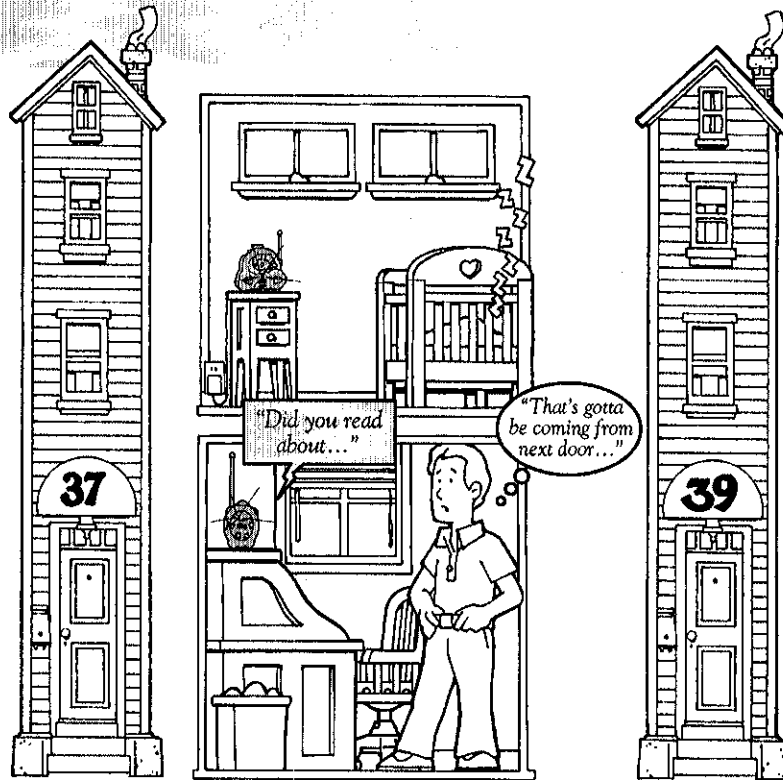

PROBLEM

You can hear conversations or sounds from other homes.

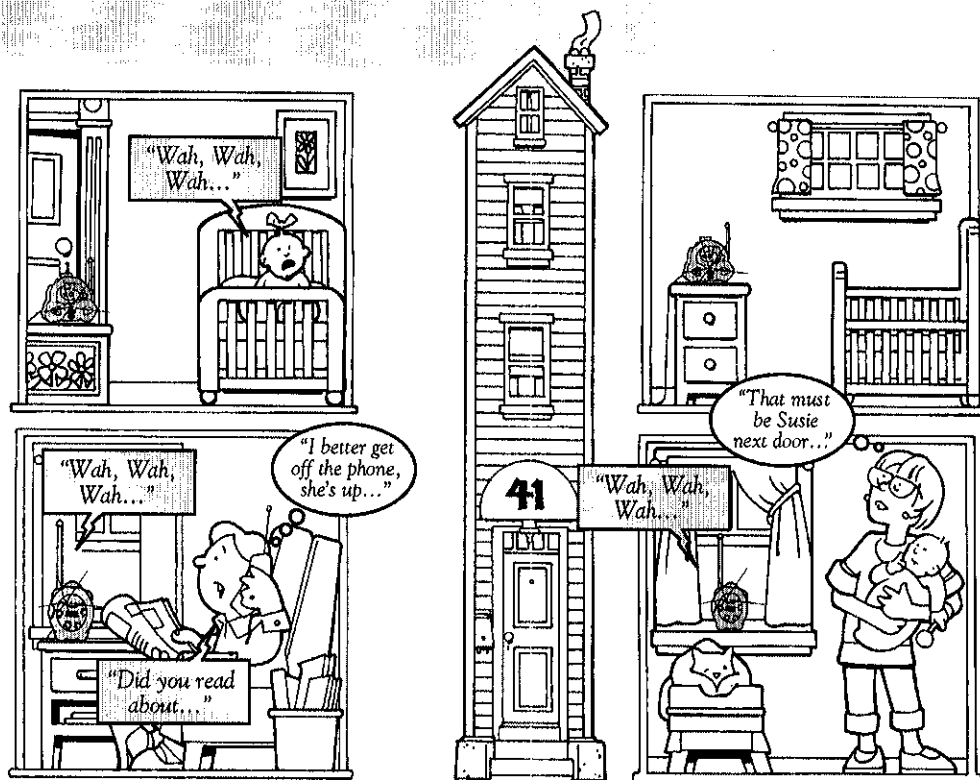

SOLUTION

There is signal interference due to other nursery monitors on same channel or cordless telephone use. Change channel switches on both transmitter and receiver to eliminate source of interference.

Hints:

- Do not use more than one transmitter and one receiver at same time in same household.
- Always remember that you are using public air waves when using your monitor. Conversations, even from rooms near transmitter, may broadcast to other nursery monitors, radios, cordless telephones, or scanners outside your home. To protect privacy of your home, always turn transmitter off when not in use.

Problems & Solutions

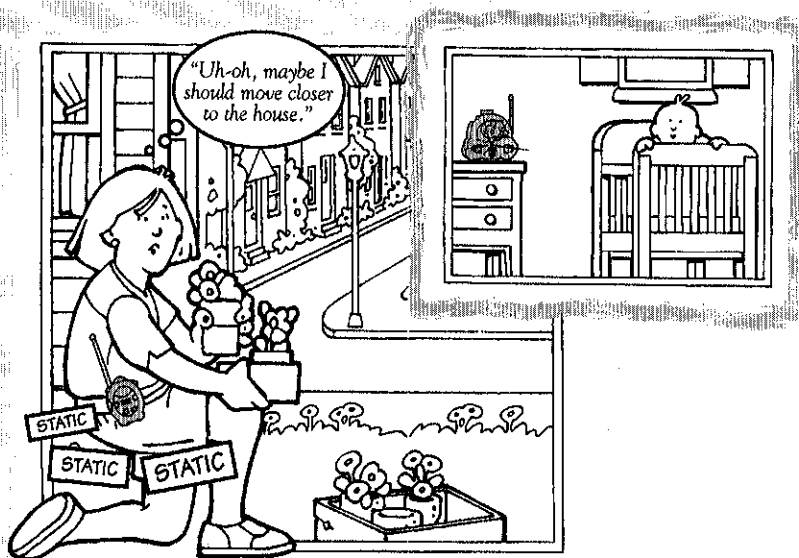

PROBLEM

You hear static or buzzing because receiver is out of range of transmitter.

SOLUTION

Move receiver closer to transmitter.

Note: Range varies depending on surrounding conditions such as noise levels, physical obstructions and signal interference.

Hint: If you cannot hear your child and all four dots do not light, your receiver battery is weak. Replace remote control/receiver battery with a fresh, 9V **alkaline** battery or use AC adaptor for power source.

Care

Excess dirt in transmitter and remote control receiver microphone will hamper transmission of sound. Clean outer surface of transmitter and receiver with a cloth lightly dampened with a mild cleaning solution. Never immerse transmitter, receiver or AC adaptor.

Class frequency 49.830Mhz, field strength 79.2dBuV/m at 3m

Class frequency 49.890Mhz, field strength 79.2dBuV/m at 3m

FCC Note (United States Only)

This equipment has been tested and found to comply with the limits for a Class B digital device pursuant to part 15 of the FCC rules. These limits are designed to provide reasonable protection against harmful interference in a residential installation. This equipment generates, uses and can radiate radio frequency energy and, if not installed and used in accordance with the instructions, may cause harmful interference to radio communications. However, there is no guarantee that interference will not occur in a particular installation. If this equipment does cause harmful interference to radio or television reception, which can be determined by turning the equipment off and on, the user is encouraged to try to correct the interference by one or more of the following measures:

- Reorient or relocate the receiving antenna.
- Increase the separation between the equipment and receiver.
- Connect the equipment into an outlet on a circuit different from that to which the receiver is connected.
- Consult the dealer or an experienced radio/TV technician for help.

Note: Changes or modifications not expressly approved by the manufacturer responsible for compliance could void the user's authority to operate the equipment.

Sweet Dreams™ Monitor

Model Number: B9638

This device complies with Part 15 of the FCC Rules. Operation is subject to the following two conditions: (1) This device may not cause harmful interference and (2) this device must accept any interference received, including interference that may cause undesired operation.

Sweet Dreams™ Monitor

Consumer Relations Department

636 Girard Avenue

East Aurora, New York 14052

Tel. No. 716-687-3000

Fisher-Price, Inc. A subsidiary of Mattel, Inc. East Aurora, New York 14052, U.S.A.

©2013 Mattel, Inc. All Rights Reserved.

™ and ® designate U.S. trademarks of Mattel, Inc.

Printed in China

RECEIVED 27 JUN 2013