

**Fisher-Price®**

# Sparkling Symphony™

## Bouncer



**Model Number: 79635**

Please keep this instruction sheet for future reference,  
as it contains important information.

Adult assembly is required. Tool required for assembly:  
Phillips Screwdriver (not included).

Requires three "C" (LR14) **alkaline** batteries (not included).

[www.fisher-price.com](http://www.fisher-price.com)



## **WARNING**

### **To prevent serious injury and/or falls:**

- Never use on any elevated surface, since child's movement may cause bouncer to slide or tip over.
- Never use as a carrier or lift while child is seated.
- Always use the restraint system.
- Never leave child unattended.
- Never use as a car seat.
- Never use with a child able to sit up unassisted.

# Parts

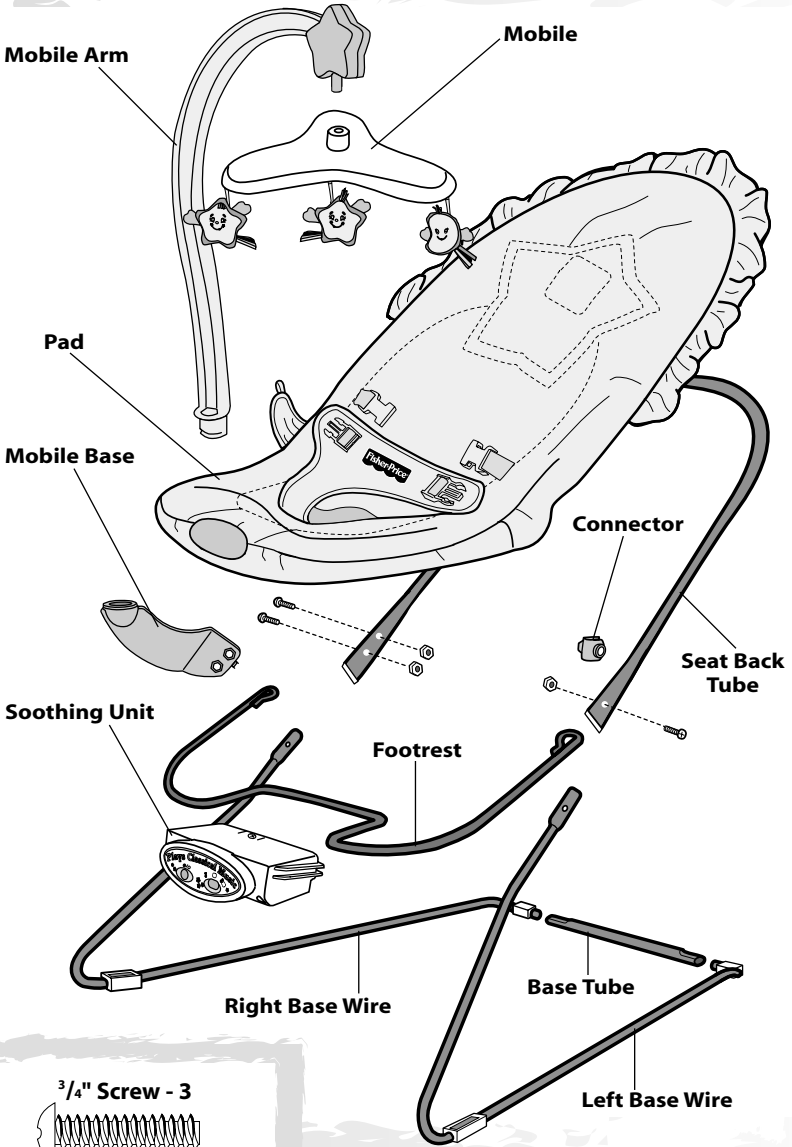

**3/4" Screw - 3**



**Lock Nut - 3**



**Both Shown Actual Size**

# Battery Installation

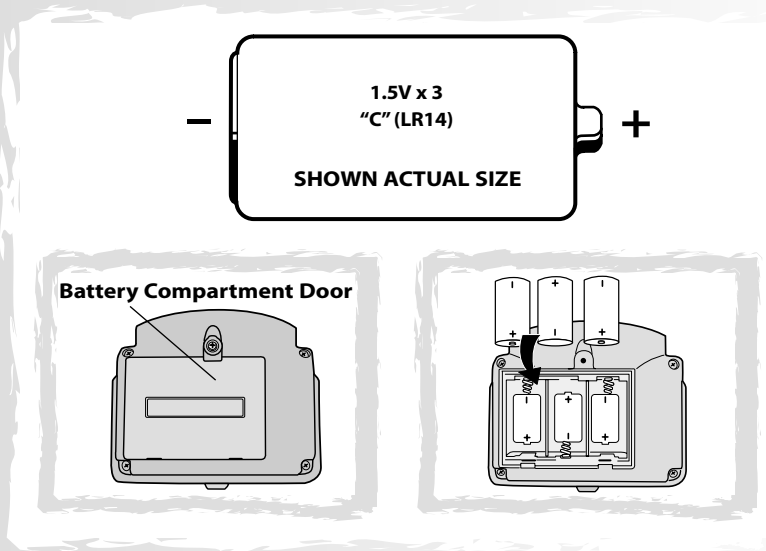

- Loosen the screw in the soothing unit battery compartment door with a Phillips screwdriver. Remove the battery compartment door.
- Insert three "C" (LR14) **alkaline** batteries, as indicated inside the battery compartment.
- Replace the battery compartment door. Tighten the screw with a Phillips screwdriver. Do not over-tighten.

**Hint:** We recommend the use of **alkaline** batteries for longest battery life.

## Battery Tips

- Do not mix old and new batteries.
- Do not mix different types of batteries: alkaline, standard (carbon-zinc) or rechargeable (nickel-cadmium).
- Remove the batteries during long periods of non-use. Always remove the exhausted batteries from the product. Battery leakage and corrosion can damage the product. Dispose of the batteries safely.
- Do not dispose of batteries in a fire. Batteries may explode or leak.
- Never short circuit the battery terminals.
- Non-rechargeable batteries are not to be recharged.
- Only batteries of the same or equivalent type as recommended in the "Battery Installation" instructions are to be used.
- If removable rechargeable batteries are used, they are only to be charged under adult supervision.
- Rechargeable batteries are to be removed from the product before they are charged.
- If you use a battery charger, it should be examined regularly for damage to the cord, plug, enclosure and other parts. Do not use a damaged battery charger until it has been properly repaired.

# Assembly



## CAUTION

This package contains small parts in its unassembled state.  
Adult assembly is required.

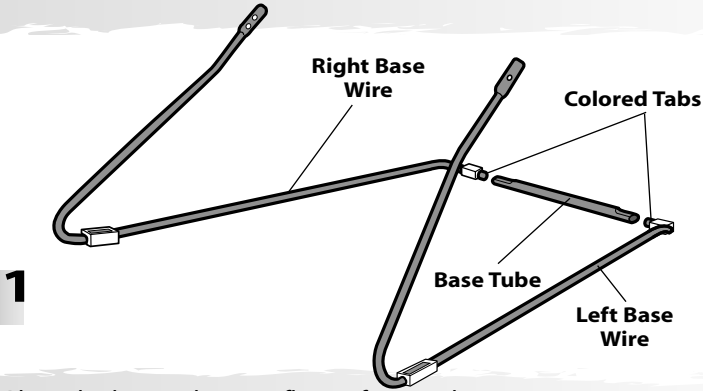

- Place the base tube on a flat surface as shown.
- Position the left and right base wires as shown. Note the location of the colored tabs on the left and right base wires.
- Fit the left base wire into the base tube.
- Fit the right base wire into the base tube.

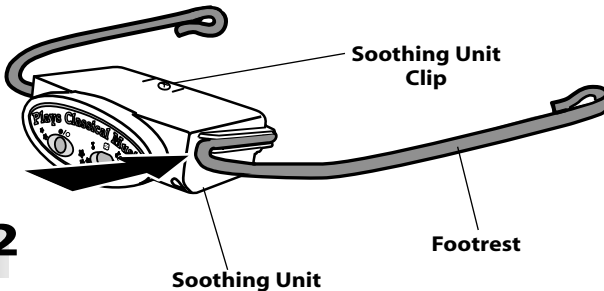

- Loosen the screw in the soothing unit clip with a Phillips screwdriver.
- Slide the soothing unit onto the footrest, as shown. **Make sure the footrest is completely in the grooves around the sides and back end of the soothing unit.**
- Tighten the screw in the soothing unit clip with a Phillips screwdriver. Do not over-tighten.

# Assembly

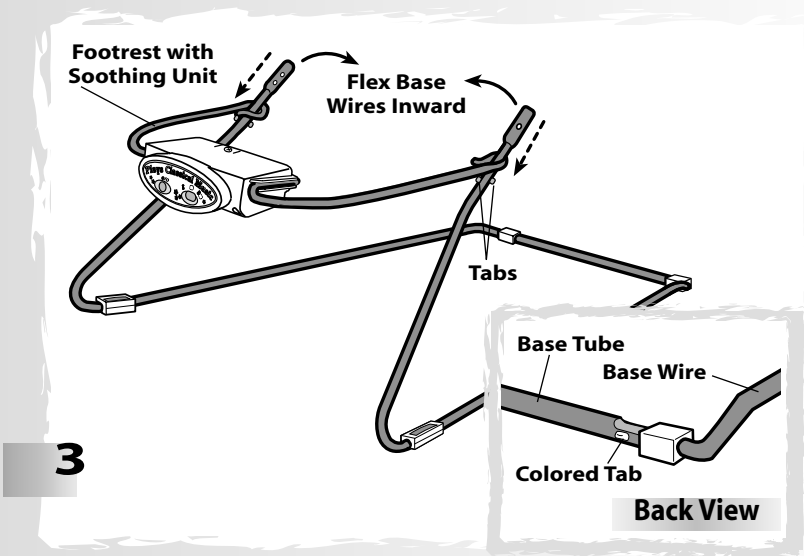

- Position the footrest so that the soothing unit is upright.
- While flexing the base wires toward each other, hook the footrest onto the ends of the base wires.
- Push the footrest **down completely to the tabs** on the base wires.
- Make sure the colored tabs on the left and right base wires are visible through the base tube holes (see inset). If the colored tabs are not visible through the base tube holes, you have assembled the base incorrectly. Disassemble all parts and refer back to Assembly Step 1.

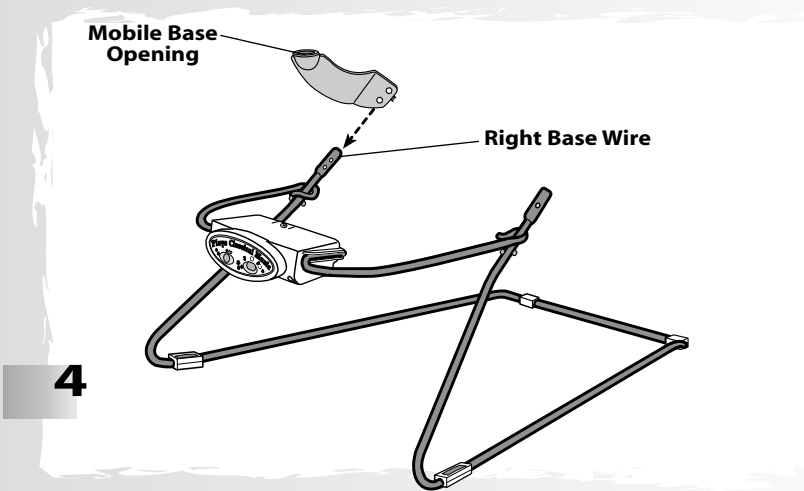

- Position the mobile base so that the opening is upright.
- Slide the mobile base onto the right base wire.

# Assembly

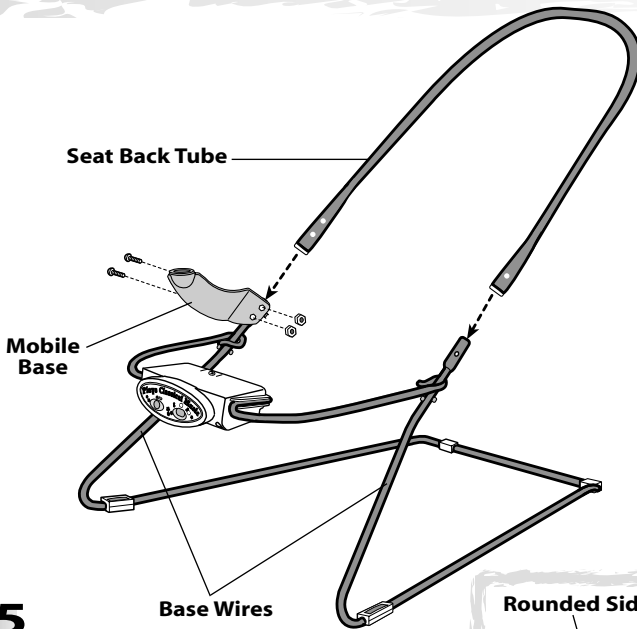

**5**

- Fit the seat back tube completely onto the base wires.

**Hint:** You will need to fit the seat back tube into the mobile base on one side of the assembly.

- Align the screw holes in the mobile base, seat back tube and base wire.
- Fit a lock nut (rounded side outward) into the hexagonal openings on the **inside** of the mobile base.
- Insert two screws into the holes in the **outside** of the mobile base.
- Tighten the screws with a Phillips screwdriver. Do not over-tighten.

# Assembly

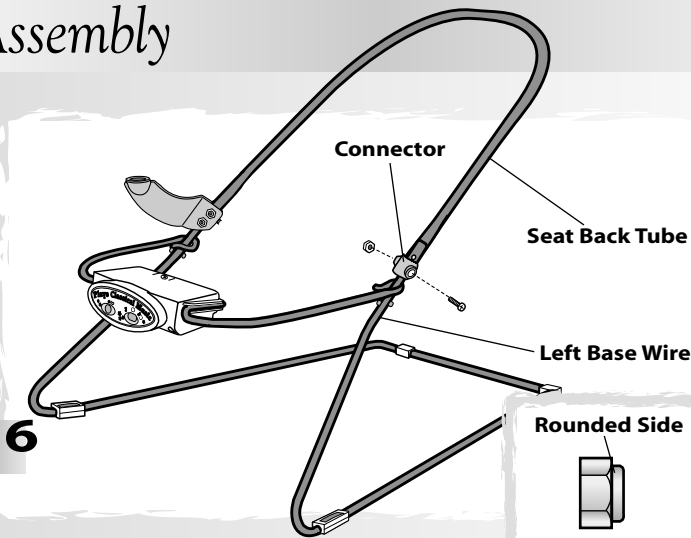

- Fit the connector onto the seat back tube, as shown.
- Align the holes in the connector, seat back tube and left base wire.
- Fit a lock nut (rounded side outward) into the hexagonal opening on the **inside** of the connector.
- Insert a screw through the hole in the **outside** of the connector.
- Tighten the screw with a Phillips screwdriver. Do not over-tighten.

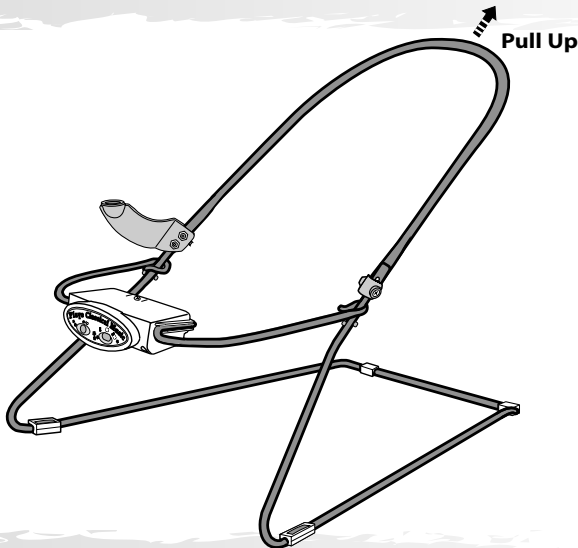

- Pull up on the seat back tube to be sure it is secure. If you can remove either end of the seat back tube, you have not assembled it correctly. Remove the screws and lock nut. Re-read and repeat Assembly steps 5 – 7.



# Assembly

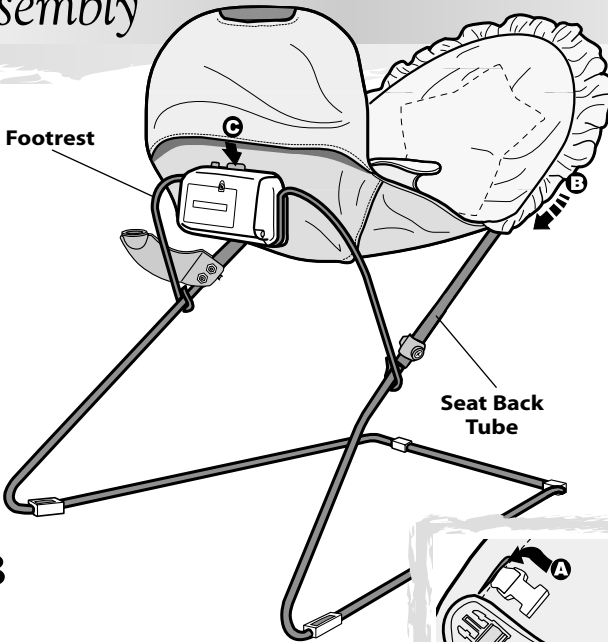

8

- Unbuckle the restraint belts from the buckle pad. Push the restraint belts through the slots in the pad **A**.
- Fit the pad upper pocket onto the seat back tube **B**.
- Lift the footrest. Fit the pad lower pocket onto the footrest **C**. Lower the footrest.

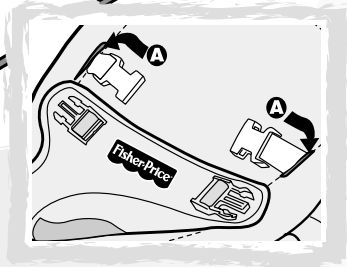

9

- Fit both restraint belts back through the pad slots, as shown.

# Assembly

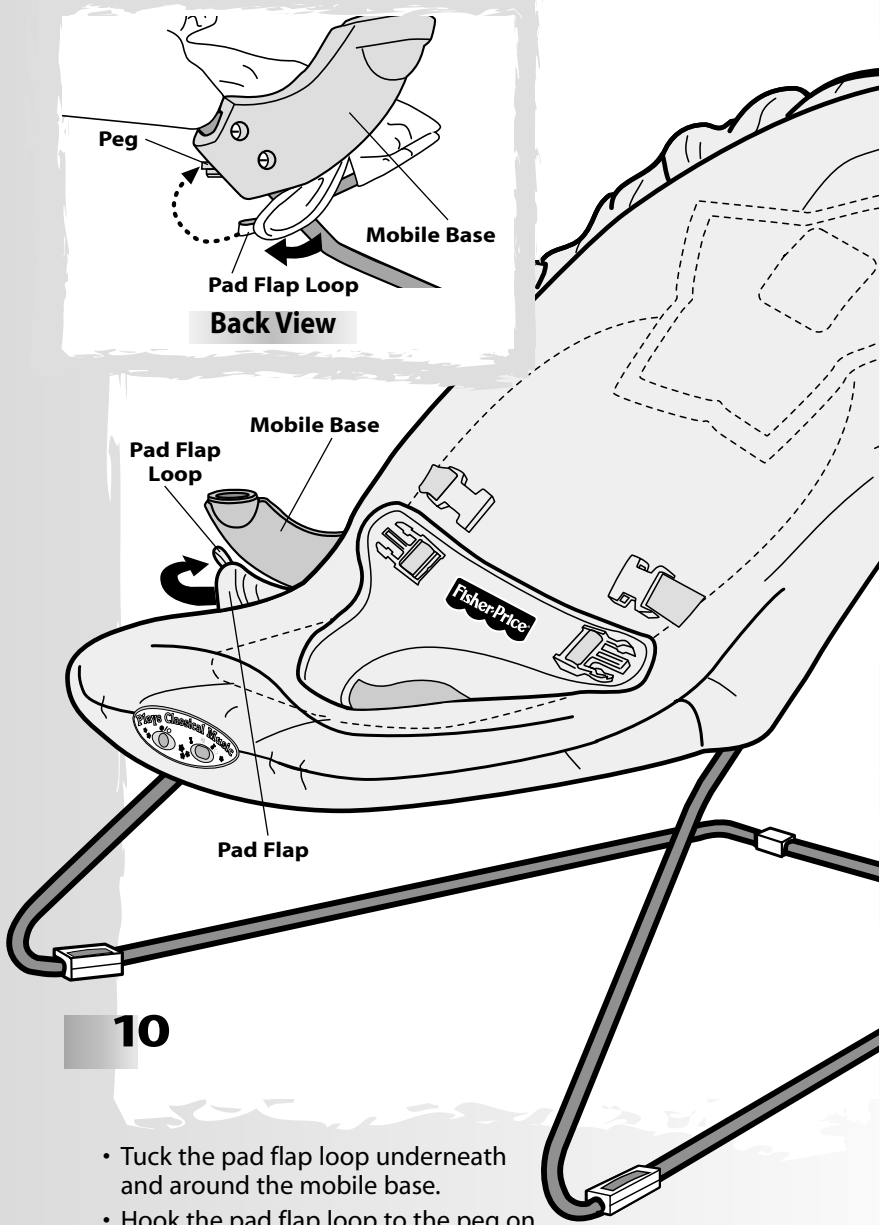

**10**

- Tuck the pad flap loop underneath and around the mobile base.
- Hook the pad flap loop to the peg on the underside of the mobile base.

# Assembly

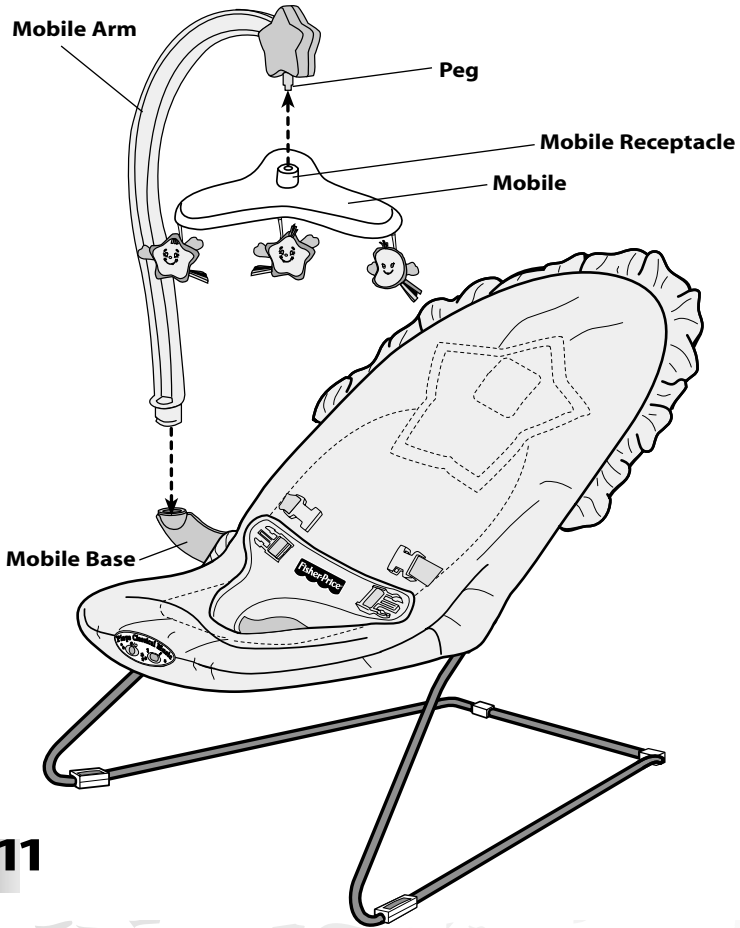

- Insert and “snap” the mobile arm into the mobile base.
- Push the mobile receptacle onto the mobile arm peg to “snap” the mobile in place.

# Set-Up & Use



## WARNING

### To prevent serious injury and/or falls:

- Never use on any elevated surface, since child's movement may cause bouncer to slide or tip over.
- Always use the restraint system.
- Never use with a child able to sit up unassisted.

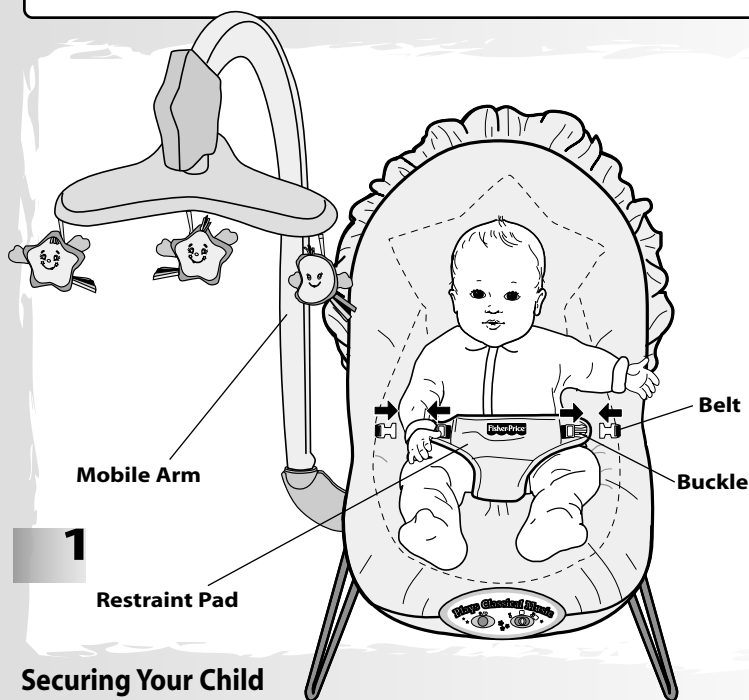

### Securing Your Child

- Turn the mobile arm away from the seating area.
- Place your child in the seat. Position the restraint pad between your child's legs.
- Fasten both restraint belts to the buckles on each side of the restraint pad. **Make sure you hear a "click" on both sides.**
- Check to be sure the restraint is securely attached by pulling it away from your child. The restraint should remain attached.
- Turn the mobile arm back toward the seating area for baby's enjoyment.

# Set-up & Use

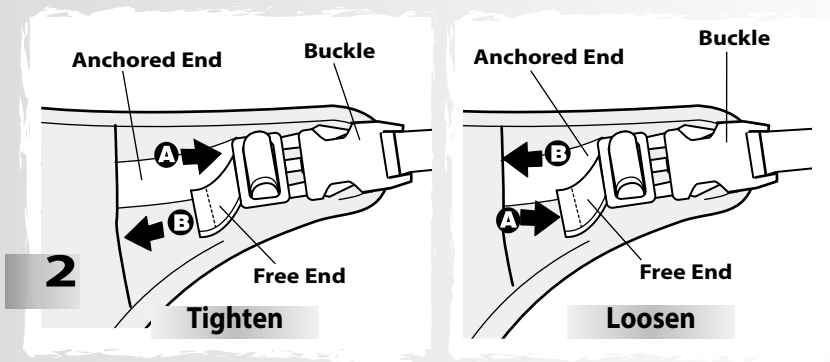

## To tighten the belts:

- Feed the anchored end of the belt up through the buckle to form a loop A.
- Pull the free end of the belt B.
- Repeat this procedure to tighten the other belt.

## To loosen the belts:

- Feed the free end of the belt up through the buckle to form a loop A. Enlarge the loop by pulling on the end of the loop toward the buckle.
- Pull the anchored end of the belt to shorten the free end of the belt B.
- Repeat this procedure to loosen the other belt.

**Please Note:** After adjusting the belts to fit your child, make sure you pull on them to be sure they are securely fastened.

# Set-up & Use



## WARNING

**To prevent serious injury and/or falls:**

- Never use as a carrier or lift while child is seated.
- Never leave child unattended.

3



### Soothing Sounds and Calming Vibrations

- Make sure your child is properly secured in the seat.
- First, slide the switch on the soothing unit to select soothing sounds, calming vibrations or both!

🎵 **Soothing Sounds (various lullabies)**

≈ **Calming Vibrations**

🎵 ≈ **Soothing Sounds and Calming Vibrations**

- Then press the power button ●/○ on the soothing unit to turn the unit on.

#### Hints:

- After each soothing selection, be sure to press the power button ●/○ again to turn the soothing unit on.
- If you slide the switch too quickly, the soothing unit will not turn off. Simply press the Power button ●/○ to turn the soothing unit off, then press again to turn back on.
- Press the power button ●/○ to turn the soothing unit off.
- Soothing sounds and/or vibrations will shut off automatically after 10-15 minutes. To turn back on, simply press the power button ●/○.

**IMPORTANT!** Change the batteries when vibrations/sounds will not shut off or the soothing unit does not function properly as described in the instructions. You will also need to change the batteries if vibrations/sounds from the soothing unit become faint, or if there are no vibrations or sounds. Remove the batteries from the soothing unit and dispose of them properly. Replace the batteries with three, new "C" (LR14) **alkaline** batteries.

# Care

The pad is machine washable. Wash it separately in cold water on the gentle cycle. Do not use bleach. Tumble dry separately on low heat and remove promptly. The frame and mobile may be wiped clean using a mild cleaning solution and a damp cloth. Do not immerse the soothing unit.

## **To remove the pad:**

- Unhook the pad flap strap from the peg on the underside of the mobile base.
- Lift the footrest wire and remove the pad lower pocket.
- Push the restraint belts back through the pad.
- Slide the pad upper pocket off of the seat back tube.

## **To re-assemble the pad:**

- Refer to Assembly steps 8 and 9.

# FCC Note (United States Only)

Note: This equipment has been tested and found to comply with the limits for a Class B digital device, pursuant to Part 15 of the FCC Rules. These limits are designed to provide reasonable protection against harmful interference in a residential installation. This equipment generates, uses and can radiate radio frequency energy and, if not installed and used in accordance with the instructions, may cause harmful interference to radio communications. However, there is no guarantee that interference will not occur in a particular installation. If this equipment does cause harmful interference to radio or television reception, which can be determined by turning the equipment off and on, the user is encouraged to try to correct the interference by one or more of the following measures:

- Reorient or relocate the receiving antenna.
- Increase the separation between the equipment and receiver.
- Consult the dealer or an experienced radio/TV technician for help.

CAUTION: Changes or modifications not expressly approved by the manufacturer responsible for compliance could void the user's authority to operate the equipment.

## Consumer Information

### Questions? We'd like to hear from you!

Call Fisher-Price® Consumer Relations, toll-free at **1-800-432-KIDS**, 8 AM – 6 PM EST Monday through Friday. Hearing-impaired consumers using TTY/TDD equipment, please call 1-800-382-7470. Or, write to:

Fisher-Price® Consumer Relations  
636 Girard Avenue  
East Aurora, New York 14052

For other countries, outside the United States:

**Canada:** call **1-800-567-7724**, or write to: Mattel Canada Inc, 6155 Freemont Blvd., Mississauga, Ontario L5R 3W2.

**Great Britain:** telephone 01628 500303.

**Australia:** Mattel Australia Pty. Ltd., 658 Church Street, Locked Bag #870, Richmond, Victoria 3121 Australia. Consumer Advisory Service 1300 135 312.

**New Zealand:** 16-18 William Pickering Drive, Albany 1331, Auckland.

Fisher-Price, Inc., a subsidiary of Mattel, Inc., East Aurora, NY 14052 U.S.A.

©2001 Mattel, Inc. All Rights Reserved. ® and ™ designate U.S. trademarks of Mattel, Inc.

Printed in China

79635pr-0920