

ESPN FAST ACTION FOOTBALL

J7512



⚠ CAUTION - ELECTRIC TOY

Not recommended for children under 6 years of age. As with all electric products, precautions should be observed during handling and use to prevent electric shock.

Fisher-Price

PRINTED IN CHINA

ASSEMBLY

J7512pr-0920

CONSUMER INFORMATION

General

- Please keep this instruction sheet for future reference, as it contains important information.
- Adult assembly is required. Tool needed for assembly: Phillips screwdriver.
- If you experience a problem, or are missing a part, please call us at 1-800-432-5437 rather than return this product to the store. Or, visit us on-line at www.fisher-price.com.
- Call Fisher-Price® Consumer Relations between 9 AM – 7 PM (EST) Monday through Friday or 11 AM – 5 PM (EST) Saturday. Hearing-impaired consumers using TTY/TDD equipment, please call 1-800-382-7470. Write to us at: Fisher-Price, Inc., Consumer Relations, 636 Girard Avenue, East Aurora, New York 14052.

6V AC Adaptor

- Requires a 6V AC adaptor (UL listed Class 2 Toy Transformer; 120VAC, 6VDC, 2.5 amp) for operation (included).
- Always use this toy where there is adequate ventilation. To prevent overheating, keep this toy away from heat sources such as radiators, heat registers, direct sunlight, stoves, amplifiers or other appliances that produce heat.
- Use the 6V AC adaptor only in a wall outlet. Do not plug the adaptor into a ceiling outlet.
- Never use extension cords with the 6V AC adaptor.
- Never use this toy near water (ie.: bathtub, sink, laundry tub or wet basement, etc.).
- **Adults Note:** Regularly examine the 6V AC adaptor for damage to the cord, plug, enclosure or other parts that may result in the risk of fire, electric shock or injury. If the 6V AC adaptor is damaged, do not use this toy.
- Do not connect to more than the recommended number of power supplies.
- This toy must only be used with the recommended 6V AC adaptor.
- The 6V AC adaptor is not a toy.
- Disconnect the 6V AC adaptor from the toy before cleaning.
- This toy is intended for use for children 6 years to adult.

PARTS



CAUTION

This product contains small parts in its unassembled state. Adult assembly is required.

Please identify all parts before assembly and save all packaging material until assembly is complete to ensure that no parts are discarded.



Table Top



**2 Legs with
Connectors**

2 Legs



**4 Retainers
(2 Lefts, 2 Rights)**



2 Braces



**2 Connector
Covers**



2 Grandstands

PARTS



2 Goal Posts



6V AC Adaptor



2 Joysticks



2 Footpads



M4 x 22 mm Black Screw - 22



M5 x 22 mm Screw - 8



M6 x 62 mm Screw - 4

All Fasteners Shown Actual Size

**Tighten and loosen all screws with a Phillips screwdriver.
Do not over-tighten.**

ASSEMBLY

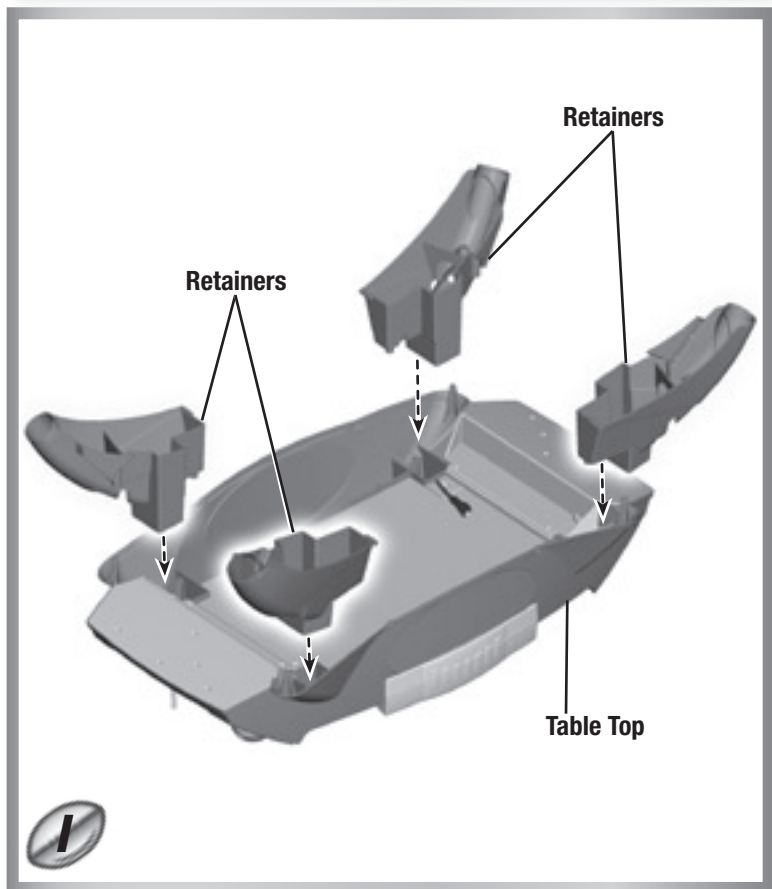

- Position the table top upside down on a flat surface.

Hint: You may want to place a blanket on the surface to protect the table top.

- Fit the retainers into the sockets in the table top.

Hint: The retainers are designed to fit into the table top one way. If a retainer does not seem to fit into a socket, try another socket!

ASSEMBLY

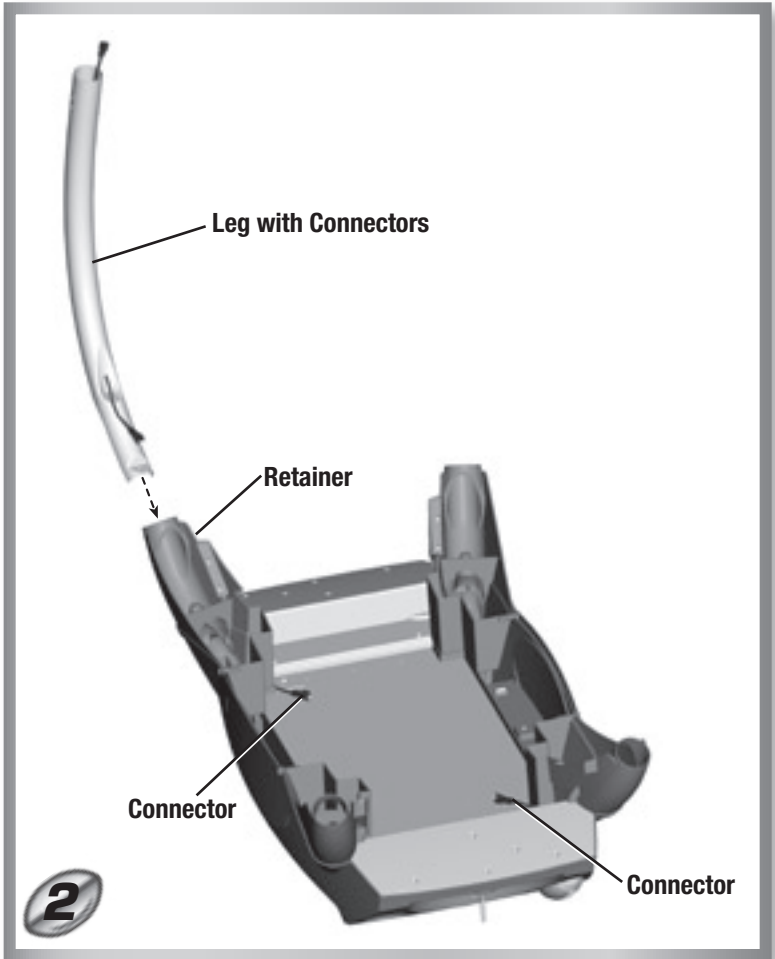

- Slide a leg with a connectors, flat side first, into a retainer that is next to a connector.

Hint: The connectors on the table top are diagonal from each other.

ASSEMBLY

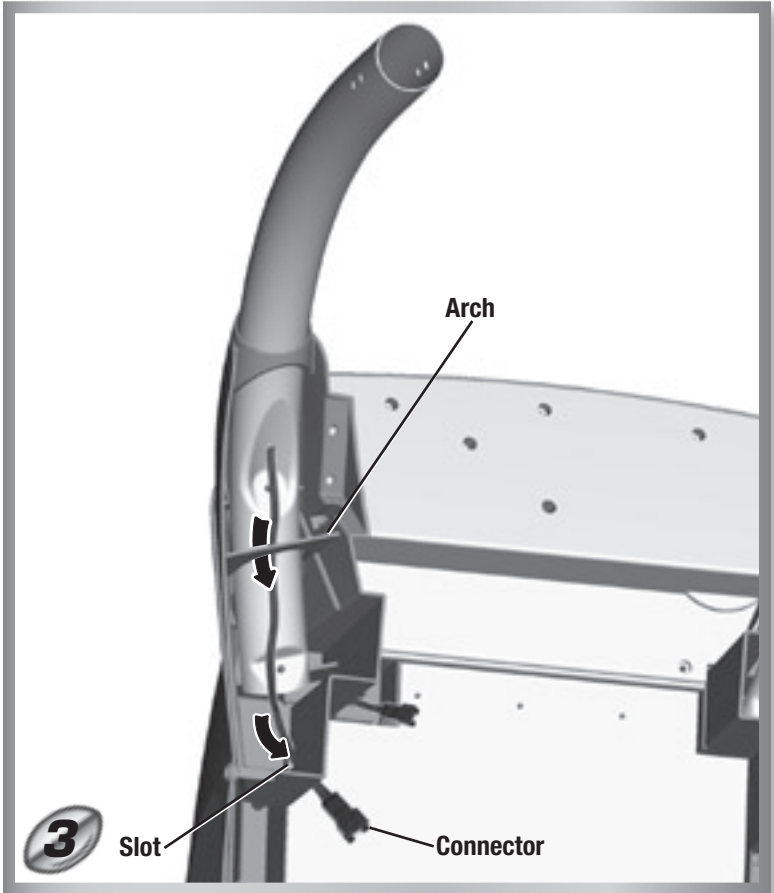

- Feed the wire on the leg under the arch in the retainer.
- Fit the connector on the end of the wire out through the slot in the retainer.

ASSEMBLY

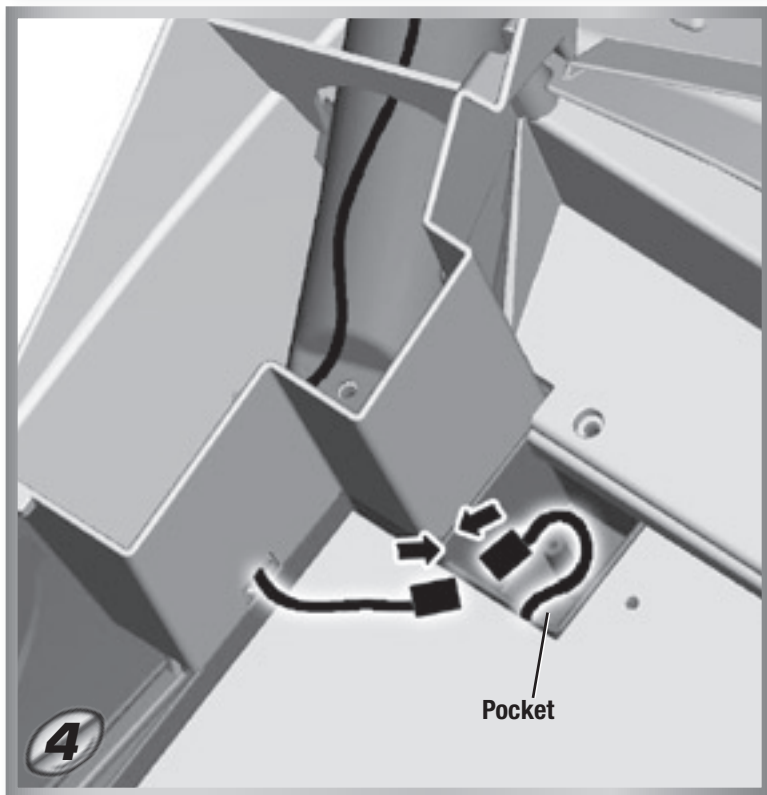

- Plug the connector from the leg into the connector on the table top.
- Tuck the connectors into the pocket in the table top.

ASSEMBLY

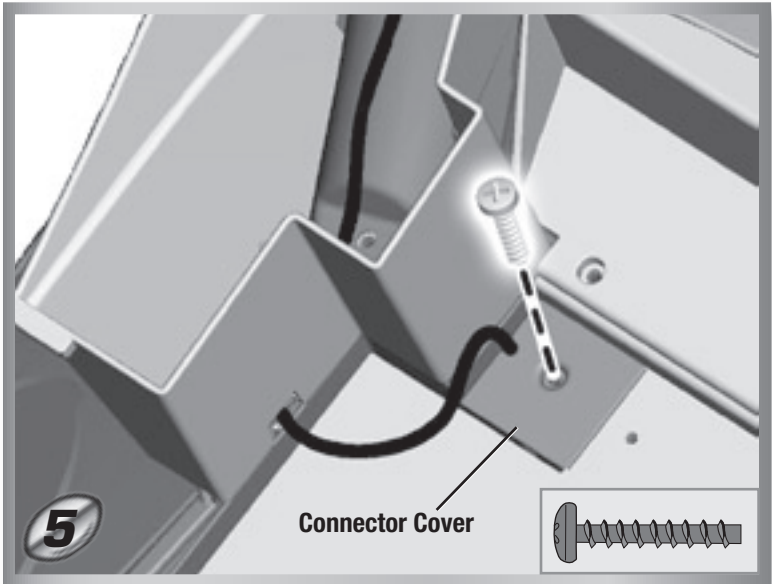

- Fit the connector cover over the pocket.
- Fit the connector wire into the groove in the connector cover.
- Insert an M4 x 22 mm black screw into the connector cover and tighten.
- Repeat Assembly Steps 1 - 5 to attach the other leg with connectors to the other retainer (next to a connector); make the connector connection and assemble the remaining connector cover.

ASSEMBLY

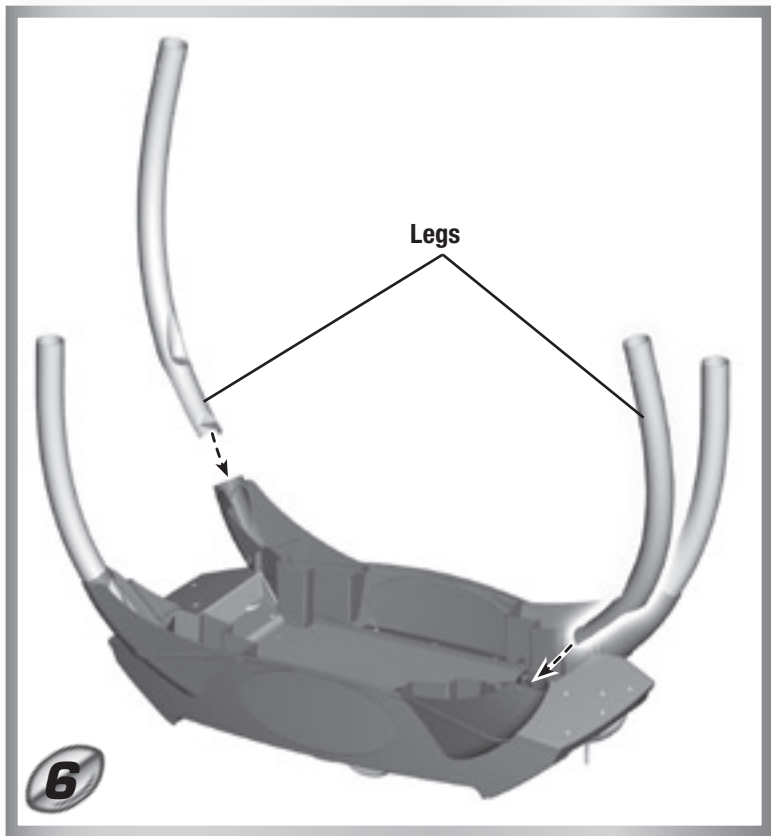

- Fit the two remaining legs, flat end first into the openings in the retainers.

ASSEMBLY

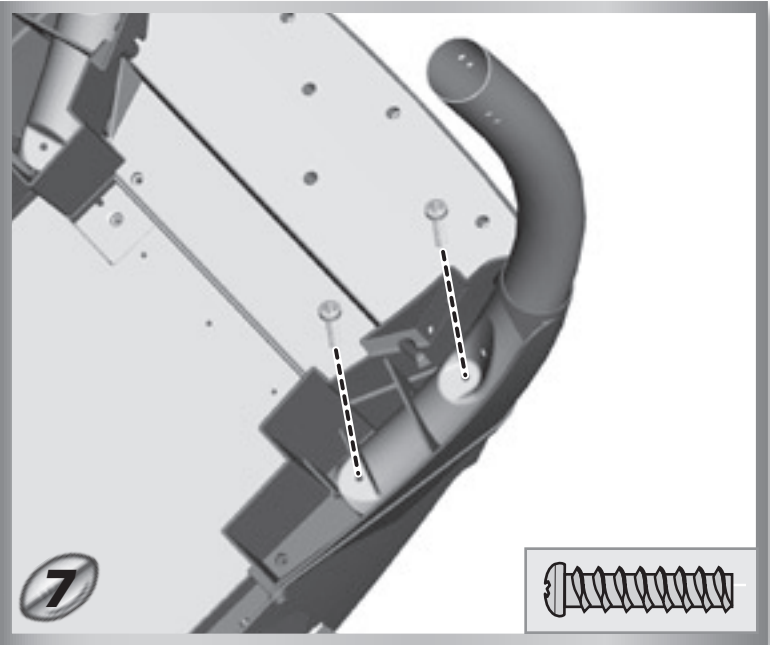

- Insert two M5 x 22 mm screws through the leg and into the table top, as shown. Tighten the screws.

ASSEMBLY

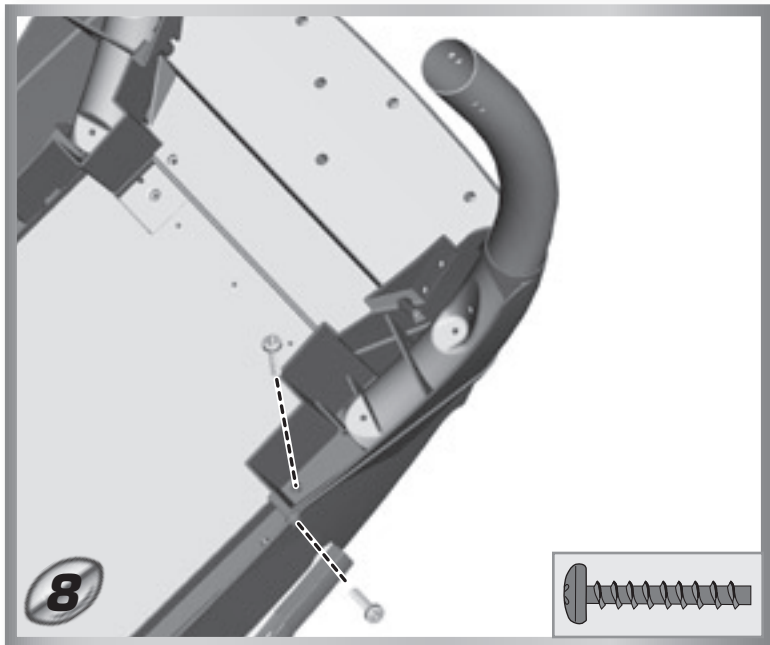

- Insert an M4 x 22 mm black screw through each retainer and into the table top, as shown. Tighten the screw.
- Insert an M4 x 22 mm black screw through each side of the table top and into the retainer, as shown. Tighten the screw.

ASSEMBLY

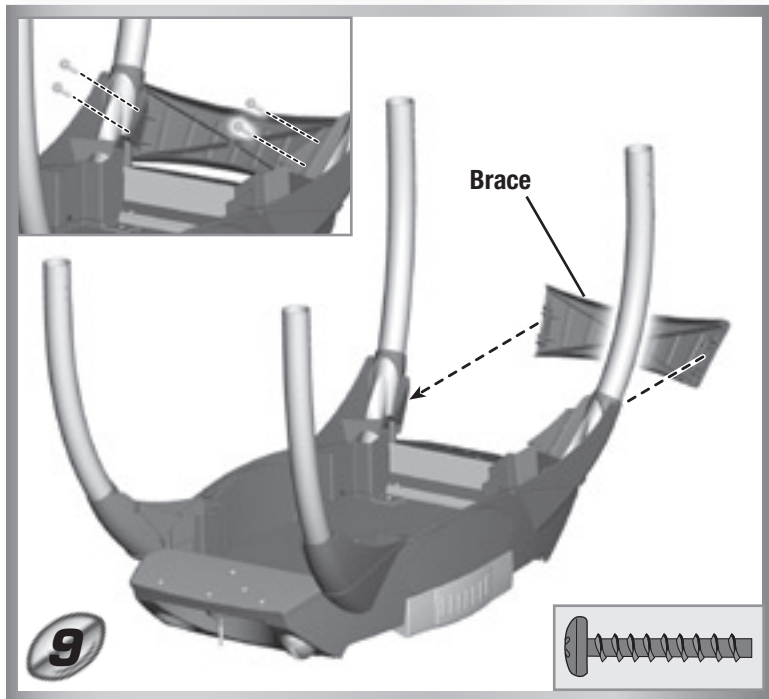

9

- Fit a brace to the leg assemblies on one end of the table top.
- Insert four M4 x 22 mm black screws through the retainers and into the brace. Tighten the screws.
- Repeat this assembly step to assemble the other brace.

ASSEMBLY



- Locate the connector extending from one side of each footpad.
- Plug the footpad connector into the connector extending from two of the legs. Tuck the excess wire down into each leg.
- Now, fit the footpads onto the legs.

ASSEMBLY



- Insert an M6 x 62 mm screw through the hole in the side of each footpad and through the leg. Tighten the screws.
- Turn the assembly upright.

ASSEMBLY

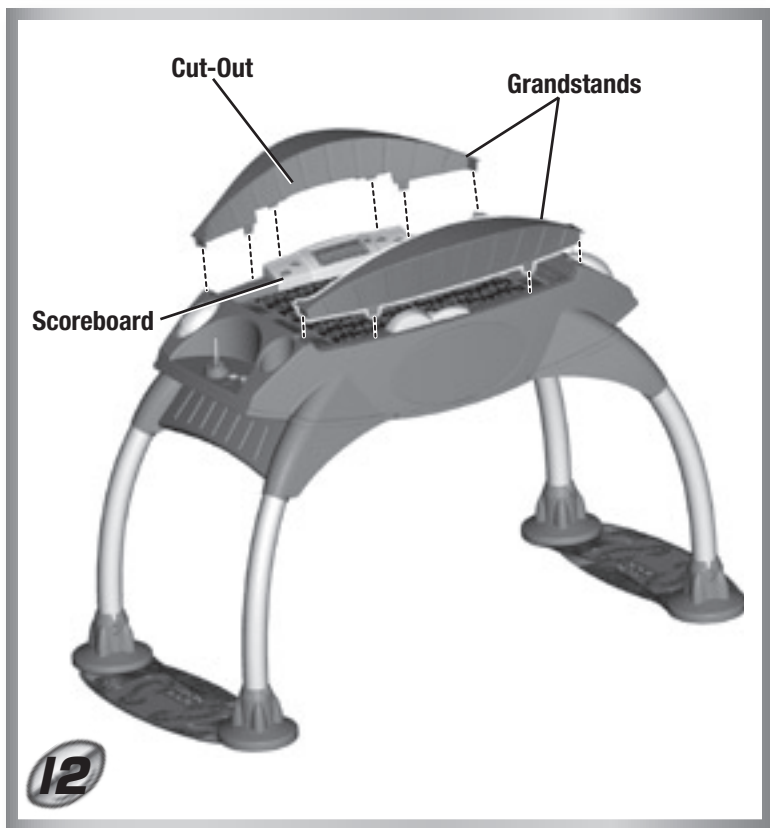

- “Snap” both grandstands to the table top.

Hint: The grandstand with the cut-out attaches to the scoreboard side of the table top.

ASSEMBLY



- “Snap” both goal posts into the holes on each end of the field in the table top.

ASSEMBLY

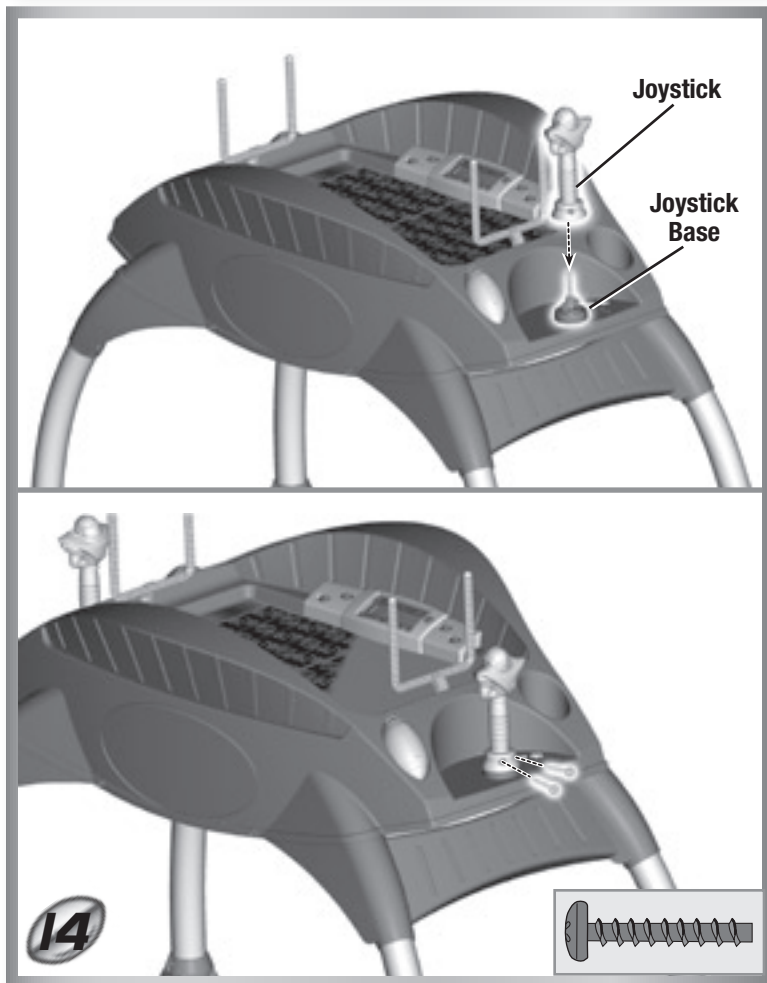

Hint: The joystick base and joystick are designed to be assembled one way. Attach the red joystick to the red joystick base and yellow joystick to the yellow joystick base.

- After attaching the joysticks to the joystick bases, insert two M4 x 22 mm black screws into each joystick base. Tighten the screws.

ASSEMBLY

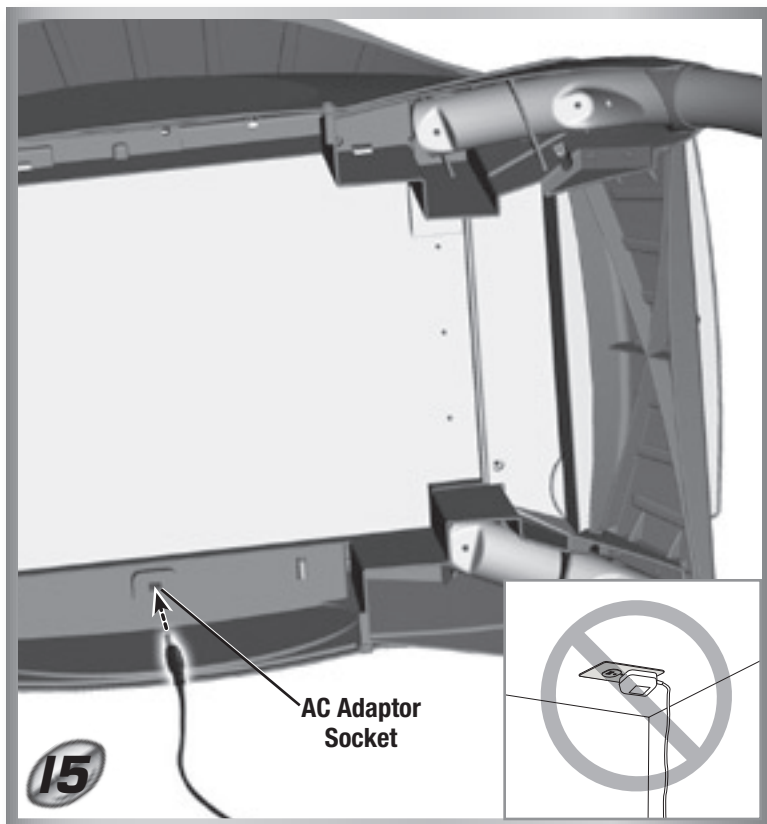

- Locate the AC adaptor socket on the underside of the table.
- Fit the 6V AC adaptor pin into the socket.
- Plug the 6V AC adaptor into a standard wall outlet.

Note: Use the AC adaptor only in a wall outlet. Do not plug the AC adaptor into a ceiling outlet.

CARE

- This toy is not intended for use outdoors.
- Wipe this toy with a clean cloth dampened with a mild soap and water solution. Wipe clean to remove soap residue.
- Do not immerse this toy.
- Keep this toy away from direct sunlight and excess heat.

FCC STATEMENT

(UNITED STATES ONLY)

This equipment has been tested and found to comply with the limits for a Class B digital device, pursuant to Part 15 of the FCC Rules. These limits are designed to provide reasonable protection against harmful interference in a residential installation. This equipment generates, uses and can radiate radio frequency energy and, if not installed and used in accordance with the instructions, may cause harmful interference to radio communications. However, there is no guarantee that interference will not occur in a particular installation.

If this equipment does cause harmful interference to radio or television reception, which can be determined by turning the equipment off and on, the user is encouraged to try to correct the interference by one or more of the following measures:

- Reorient or relocate the receiving antenna.
- Increase the separation between the equipment and receiver.
- Consult the dealer or an experienced radio/TV technician for help.

Note: Changes or modifications not expressly approved by the manufacturer responsible for compliance could void the user's authority to operate the equipment.

WARRANTY

ONE (1) YEAR LIMITED WARRANTY

Fisher-Price, Inc., 636 Girard Avenue, East Aurora, New York 14052 warrants to the original owner that ESPN Fast Action Football is free from all defects in material and workmanship when used under normal conditions for a period of one (1) year from the date of purchase.

Should the product fail to perform properly, we will repair or replace it at our option, free of charge. Purchaser is responsible for shipping the product to Consumer Relations at the address indicated above and for all associated freight and insurance cost. Fisher-Price, Inc. will bear the cost of shipping the repaired or replaced item to you.

This warranty is void if the owner repairs or modifies the product. This warranty excludes any liability other than that expressly stated above including but not limited to any incidental or consequential damages.

SOME STATES DO NOT ALLOW THE EXCLUSION OR LIMITATION OF INCIDENTAL OR CONSEQUENTIAL DAMAGES, SO THE ABOVE LIMITATION OR EXCLUSION MAY NOT APPLY TO YOU.

THIS WARRANTY GIVES YOU SPECIFIC LEGAL RIGHTS, AND YOU MAY ALSO HAVE OTHER RIGHTS WHICH MAY VARY FROM STATE TO STATE.

CONSUMER INFORMATION

Questions?

Visit us on line at www.service.fisher-price.com.

Call our Consumer Relations Department, toll-free at 1-800-432-5437, 9 AM - 7 PM EST Monday through Friday and 11 AM - 5 PM EST Saturday. Hearing-impaired consumers using TTY/TDD equipment, please call 1-800-382-7470. Write to us at: Fisher-Price® Consumer Relations, 636 Girard Avenue, East Aurora, New York 14052.

Fisher-Price, Inc., a subsidiary of Mattel, Inc., East Aurora, NY 14052 U.S.A.

©2006 Mattel, Inc. All Rights Reserved. ® and ™ designate U.S. trademarks of Mattel, Inc.

ESPN FAST ACTION FOOTBALL

J7512



©2006 ESPN, Inc. All Rights Reserved.
www.ESPN.com

Fisher-Price

PLAYBOOK

FEATURES

For 1-2 players

We recommend that players begin in Training Camp BEFORE playing either the Rookie or Pro games. Each game in training camp reviews the skills and strategy needed to play games successfully.

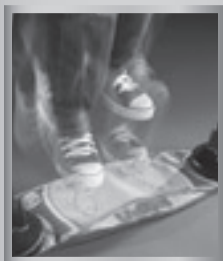

Footpad

Football



Scoreboard

Line Marker

Speaker



Joystick



Play Call Buttons

FEATURES



Power Switch – Slide to turn power ON or OFF.

Volume Switch – Slide for LOW volume or HIGH volume.

Scoreboard – Includes time clock, score, yards and downs marker and time out tracker.

Game Status Button – Press during Rookie/Pro game play to see more information on the scoreboard.

Level Selector Switch – Choose Training Camp, Rookie or Pro play.

Player Switch – Choose 1-PLAYER or 2-PLAYER.

Line Marker – Keeps track of the yard line the football is on.

Speaker – Listen to play-by-play voice-action and sounds.

Field – Player's and the football light up for play.

Football – Press the football to break the huddle, hike the ball and begin play. You will also use the football to make pre-game setup selections.

Play Call Buttons – Call a play in Pro mode – run, pass or kick. Use the Play Call Buttons for 4th down kicking plays in Rookie mode too.

Footpad – Run on the footpad to control your player's speed on the field. Tap the footpad to kick the ball.

Joystick – Move the joystick right, left, forward or backward to control player direction.

TRAINING CAMP

ESPN

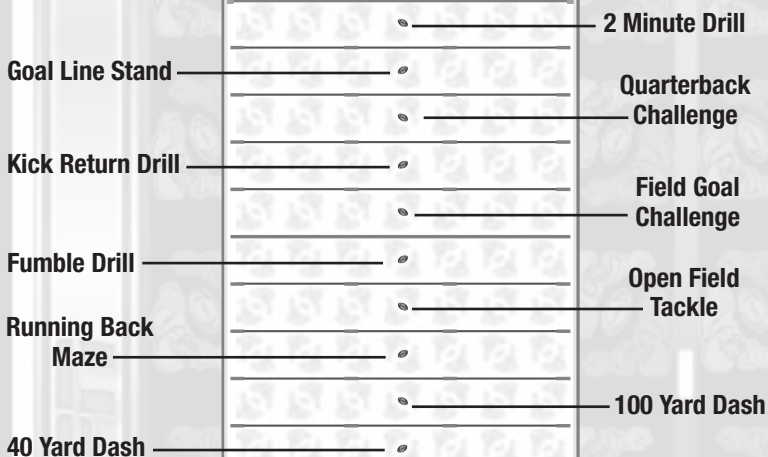

- Move the joystick forward or backward to choose a game.
- When you find one that you like, press the football!
- If you are playing with two players, the red team plays first and then the yellow team plays.

TRAINING CAMP

40 Yard & 100 Yard Dash

Object: See how fast your player can run!



- Press the football to begin!
- Move the joystick forward.

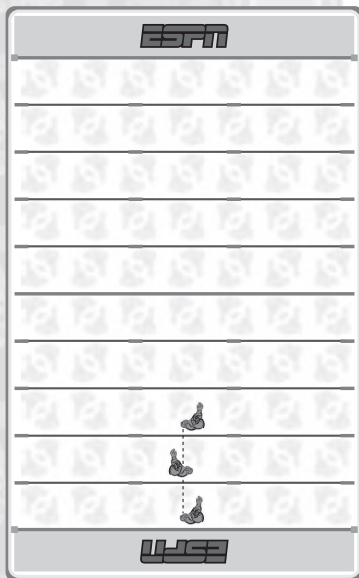

- Run on the footpad. Keep running as fast as you can until you cross the goal line!
- Look and listen to your time.
- Do you want to play again and beat your time or play the next game in Training Camp? Move the joystick to make your selection and press the football to begin.

TRAINING CAMP

Running Back Maze

Object: Move the running back through a maze of defensive players and score a touchdown!

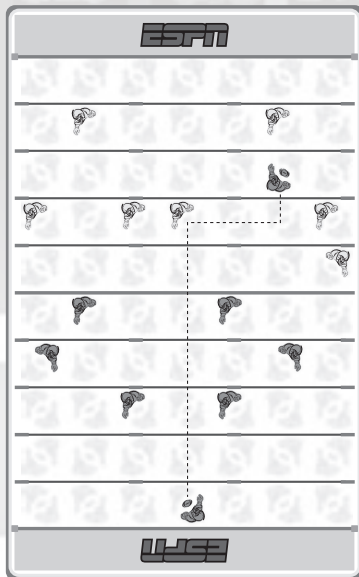
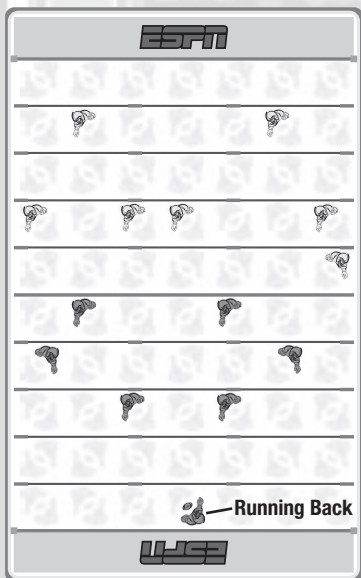

- Press the football to begin.
- Position the joystick in the direction you want your running back to move.
- Run on the footpad as fast as you can to move the running back.

- Try to avoid the defense.
- Use the joystick to move the running back around the defense.
- Keep running!

TRAINING CAMP

Running Back Maze

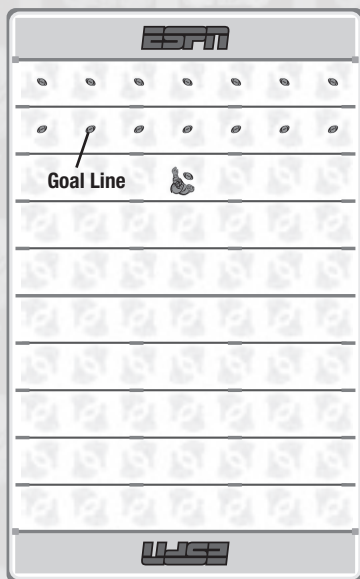

- Keep running until the running back crosses the goal line.
- Touchdown! Look and listen to your time.
- Do you want to try again or play the next game in Training Camp? Move the joystick to make your selection and press the football to begin.

TRAINING CAMP

Open Field Tackle Linebacker

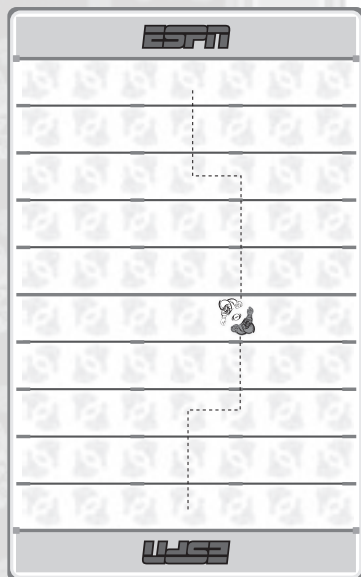

- Press the football to begin.
- Move the joystick in the direction you want your linebacker to move.
- Run on the footpad as fast as you can to move the linebacker and catch up to the running back.

- Great tackle! You score one point!
- Keep playing until you or your opponent scores 10 points.
- Do you want to play again or play the next game in Training Camp? Move the joystick to make your selection and press the football to begin.

TRAINING CAMP

Fumble Drill

Object: Jump on the football and score 10 points to win!

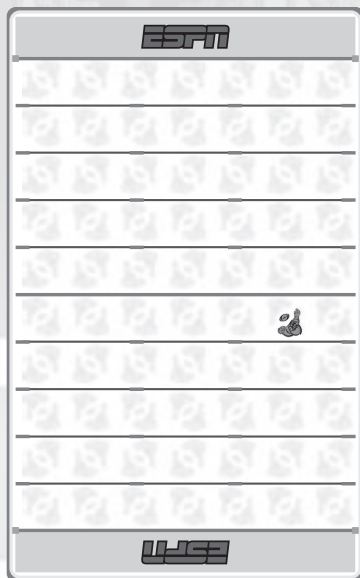
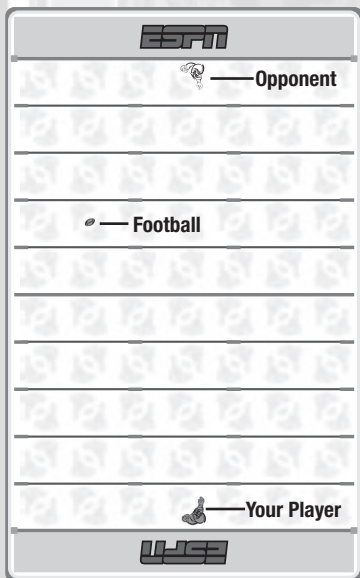

- Press the football to begin.
- Watch the football "bounce" on the field.
- Move the joystick in the direction you want your player to move.
- Run on the footpad as fast as you can to get to the football first.

- You picked up the fumble and score one point!
Hint: If your opponent beats you to the football, the opponent scores one point.
- After each point, press the football. Keep playing until you or your opponent scores 10 points.
- Do you want to play again or play the next game in Training Camp? Move the joystick to make your selection and press the football to begin.

TRAINING CAMP

Field Goal Challenge

Object: See how far you can kick a field goal and score 10 points.

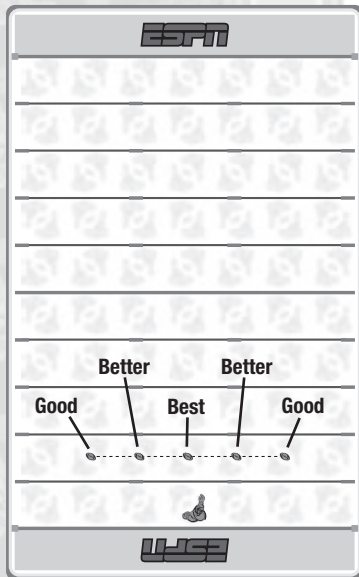
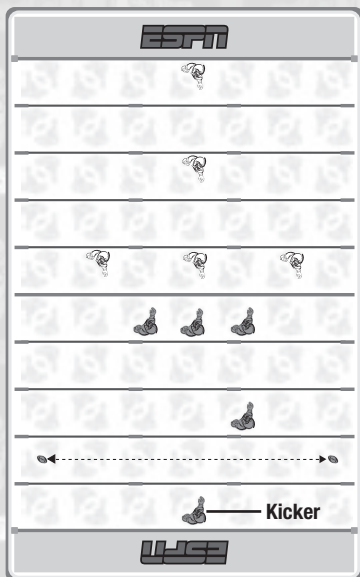

- Press the football to begin.
- Watch the football being hiked to your kicker. The football will move back and forth across the field.

- Watch the football and try to time your kick. The closer you come to aligning the football with your kicker, the further and straighter the kick will be.

TRAINING CAMP

Field Goal Challenge

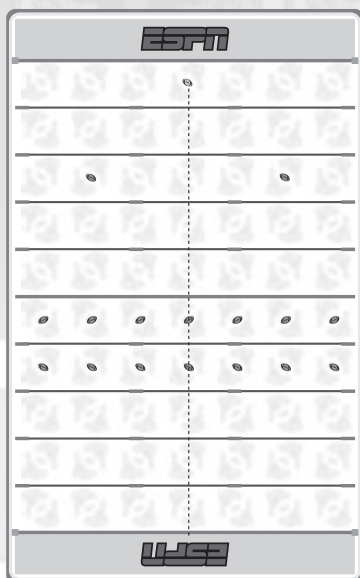
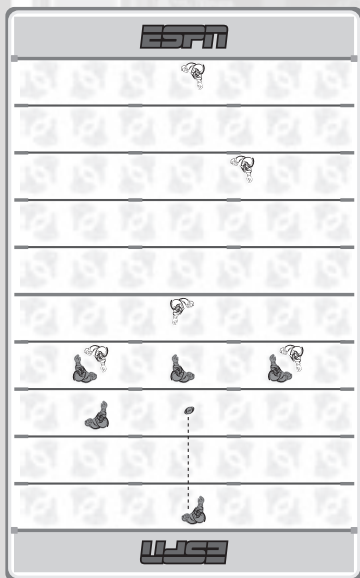

- Tap the footpad with your foot when the ball is aligned with your kicker.

Hint: Make sure you don't run out of time and get a delay of game penalty. This will count as a missed attempt. After three missed attempts, the game is over!

- It's good! You made a 20 yard field goal and scored a point.
- Each time you make a field goal, your kicker backs up 5 yards for a longer kick. Keep playing until you make 10 field goals or miss three times.
- Do you want to play again or play the next game in Training Camp? Move the joystick to make your selection and press the football to begin.

TRAINING CAMP

Kick Return Drill

Object: Try to run the football back for a touchdow.

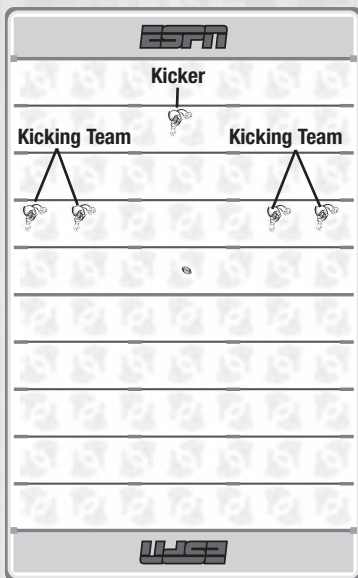

- Press the football to begin.

TRAINING CAMP

Kick Return Drill

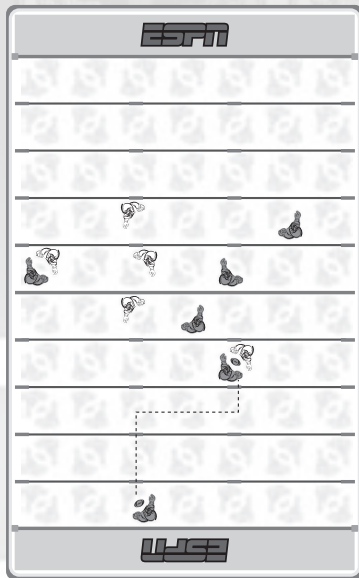

- Run on the footpad as fast as you can and move the joystick in the direction you want the kick returner to go.

- You've been tackled! Listen to how far you ran the kick back.
- You have two more tries to get a touchdown and increase your distance.
- Do you want to play again or play the next game in Training Camp? Move the joystick to make your selection and press the football to begin.

TRAINING CAMP

Quarterback Challenge

Object: Complete 10 passes to get the highest quarterback rating.

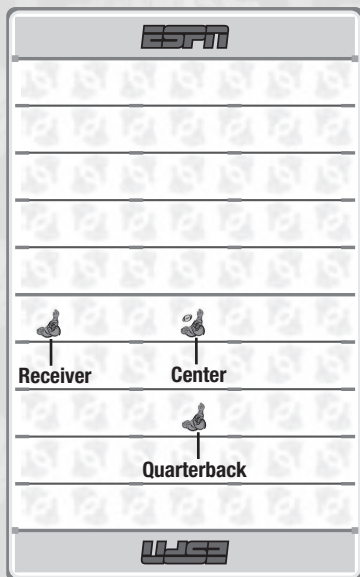

- Look at the field and note the position of the center, quarterback and receiver.
- Press the football to hike the ball.

TRAINING CAMP

Quarterback Challenge

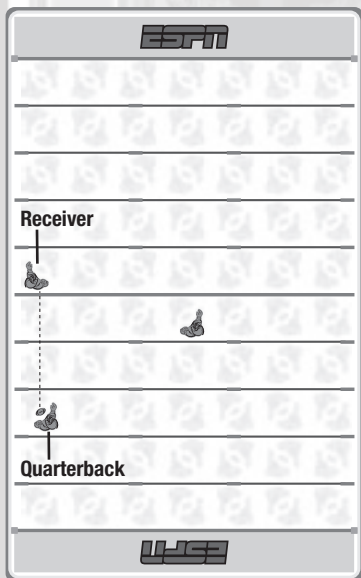

- Run on the footpad and move the joystick to align the quarterback with the receiver.
- Press the football to pass.

- You completed your first pass!
Hint: Defensive players will be added to this challenge after the first few tries. Review pages 16-18.

TRAINING CAMP

Quarterback Challenge

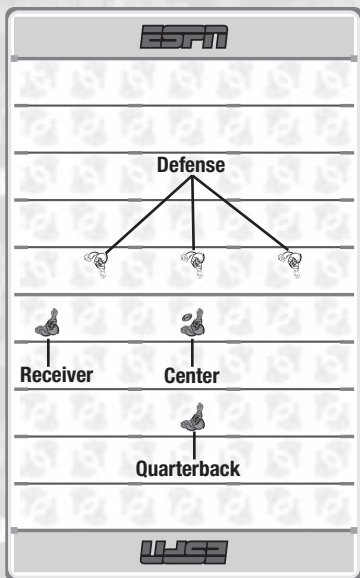

- Press the football to hike the ball.
- Run on the footpad and move the joystick to align the quarterback with the receiver.

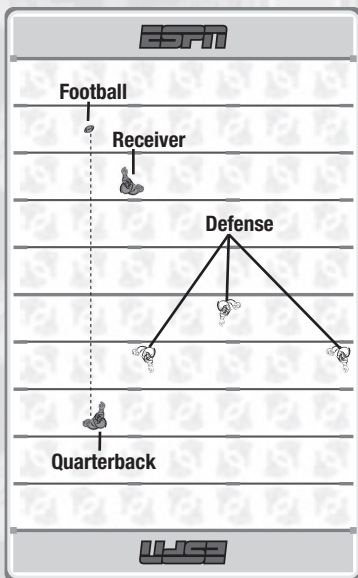

- Press the football to pass.
- You made an incomplete pass. Try again for a completed pass.

Hint: Make sure you align the quarterback with the receiver before you pass.

TRAINING CAMP

Quarterback Challenge

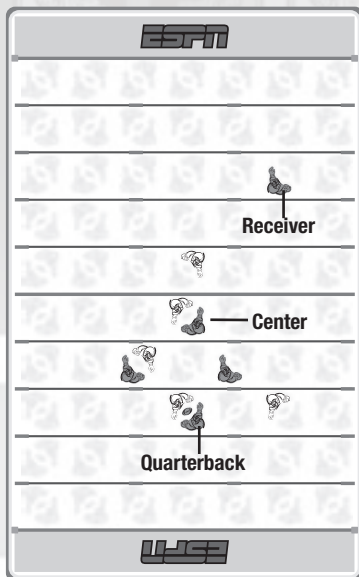
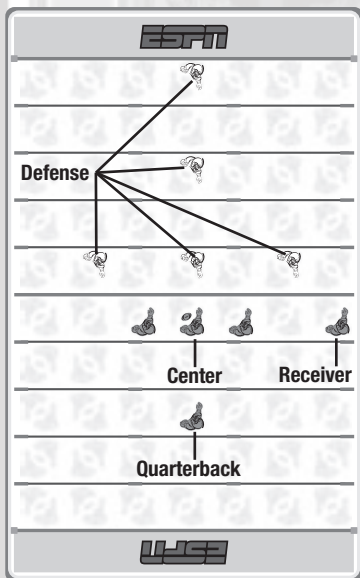

- Press the football to hike the ball.
- Run on the footpad and move the joystick to align the quarterback with the receiver.

Hint: Watch out for the defense!

- You've been sacked! Try again!
- Keep playing until you have 10 attempts. Listen to your rating.
- Do you want to play again or play the next game in Training Camp? Move the joystick to make your selection and press the football to begin.

TRAINING CAMP

Goal Line Stand

Object: Score a touchdown or stop a touchdown in four plays.



- Choose offense or defense. Move the joystick forward or backward.
- Press the football to select!

TRAINING CAMP

Goal Line Stand Offense

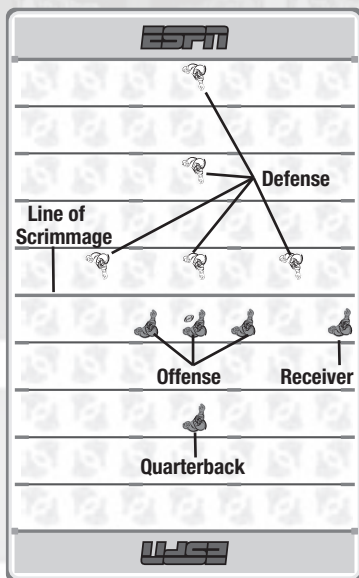
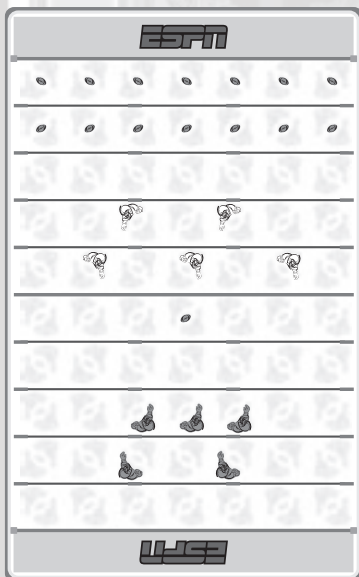

- Try to score a touchdown from the 2 yard line.
- Press the football to break the huddle.

Hint: If you don't hurry, you'll get a delay of game penalty and move back 5 yards.

- Watch how your offense lines up at the line of scrimmage. Your receiver is on either side of the field.
- Decide whether you will run or pass the ball to the receiver.

TRAINING CAMP

Goal Line Stand Offense - Run Play

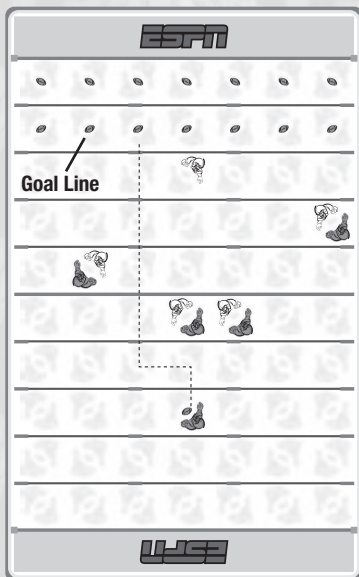

- Press the football to hike the ball.
- Run on the footpad as fast as you can and move the joystick in the direction you want to run.
- Keep running until you reach the goal line.
- You did it! You scored a touchdown.
- Do you want to play again or play the next game in Training Camp? Move the joystick to make your selection and press the football to begin.

TRAINING CAMP

Goal Line Stand Offense - Pass Play

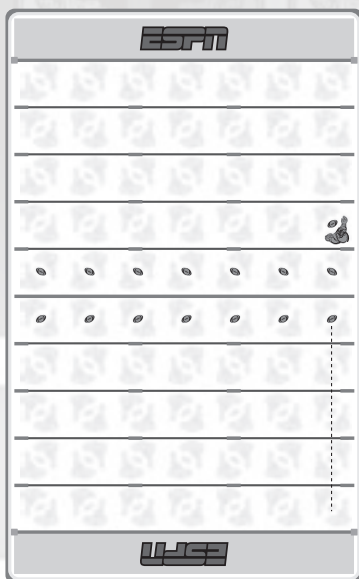
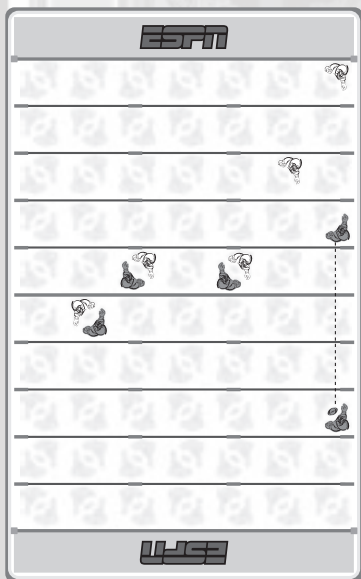

- Press the football to hike the ball.
- Run on the footpad and move the joystick to align the quarterback with the receiver.
- Press the football to pass.

- After the receiver catches the football, run on the footpad and use the joystick to run into the end zone.
- You did it! You scored a touchdown.
- Do you want to play again or play the next game in Training Camp? Move the joystick to make your selection and press the football to begin.

TRAINING CAMP

Goal Line Stand Defense

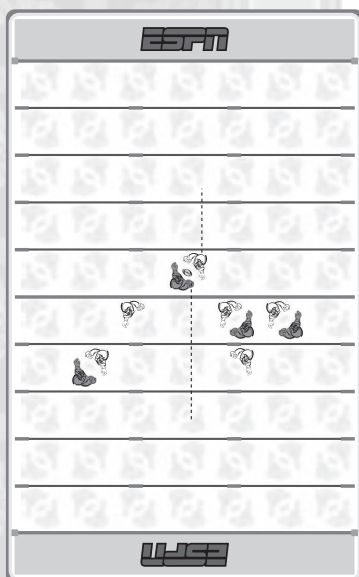
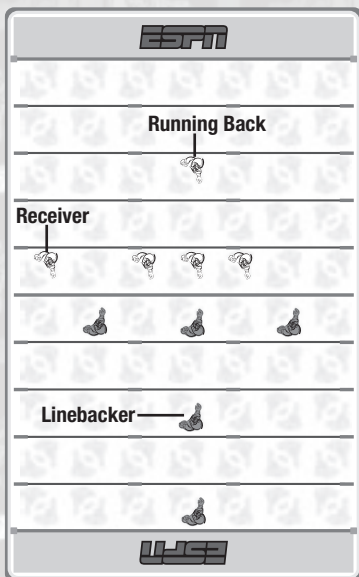

- Look at your defense. Using the joystick, you will move your linebacker (blinks) to tackle the ball carrier
- Press the football to break the huddle.

- Run on the footpad as fast as you can and move the joystick to move your linebacker.
- Try to catch the running back or receiver.
- "Ouch, that's gotta hurt!" You tackled the running back.
- Do you want to play again or play the next game in Training Camp? Move the joystick to make your selection and press the football to begin.

TRAINING CAMP

2-Minute Drill

Object: Play offense, defense and special teams all in 2 minutes.



- Look at the scoreboard to see 2 minutes left on the time clock and the score.
- You are on offense first. You have 2 minutes to score a touchdown.
- Press the football to break the huddle.

TRAINING CAMP

2-Minute Drill Offense - Pass Play

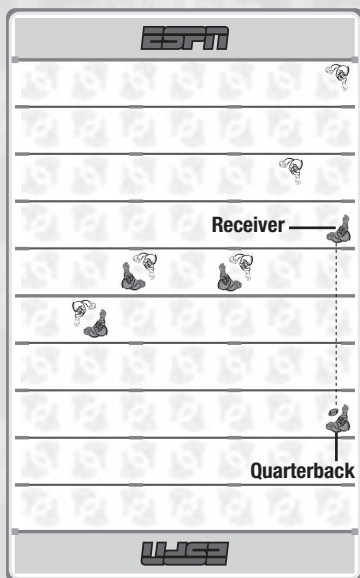

- Run on the footpad and move the joystick to align the quarterback with the receiver.
- Press the football to pass.
- When the receiver catches the football, run on the footpad and move the joystick to score a touchdown.

TRAINING CAMP

2-Minute Drill Offense - Field Goal

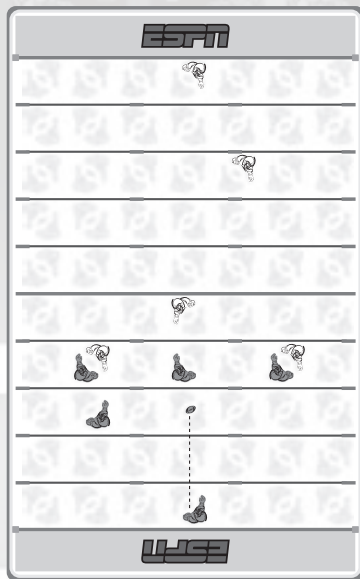

- Press the football to begin.
- Watch the football being hiked to your kicker.

- Tap the footpad with your foot when the ball is best aligned with your kicker.

TRAINING CAMP

2-Minute Drill Offense - Punt Return

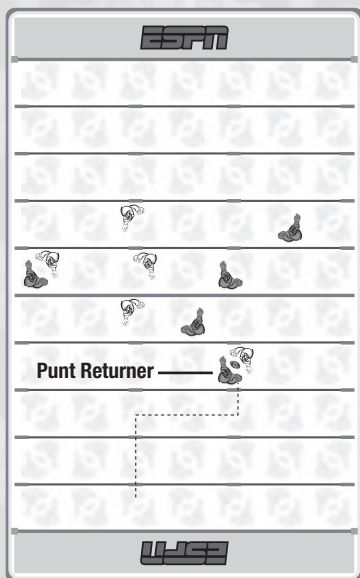

- Run on the footpad as fast as you can and move the joystick in the direction you want your punt returner to move.

TRAINING CAMP

2-Minute Drill Defense

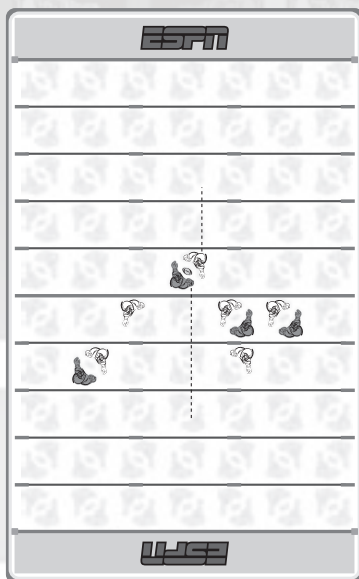
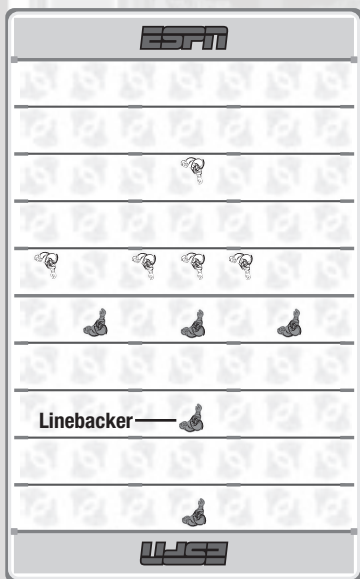

- Look at your defense. Using the joystick, you will move your linebacker (blinking) to tackle the ball carrier.
- Press the football to break the huddle.

- Run on the footpad as fast as you can and move the joystick to move your linebacker.
- Try to catch the running back or receiver.
- Do you want to play again or play the next game in Training Camp? Move the joystick to make your selection and press the football to begin.

ROOKIE PLAY



- First, choose a team.
- Move the joystick to scroll through team choices.
- When you find one that you like, press the football.



- Next, it's time for the coin toss.
- Move the joystick. Choose heads or tails.
- Press the football.

ROOKIE PLAY

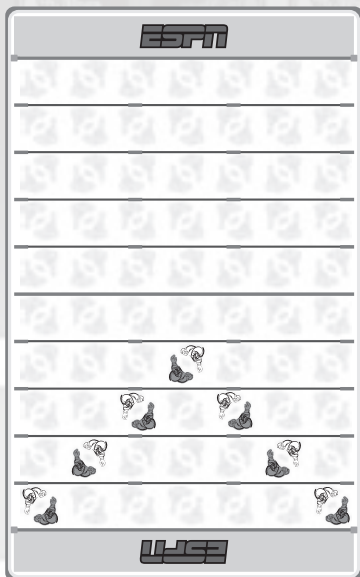

- If you win the coin toss, choose whether you will kick or receive.
- Move the joystick to choose and press the football.

- Begin game play! Listen carefully to the voice prompts and use the skills learned in Training Camp to play the game.

ROOKIE PLAY

- You will play on a 100 yard field.
- Each quarter is 3 minutes and it is a 12 minute game.
- On offense, you have 3 downs to move the football at least 10 yards. If you do not move the football at least 10 yards, you need to call a play on 4th down. Use the play call buttons to select a punt, field goal or fake kick. Make sure you break the huddle within 30 seconds or you'll receive a delay of game penalty. Press the game status button to see the game clock.
- To run the football, press the football to hike the ball. Next, run on the footpad and move the joystick to move your player.
- To pass the football, press the football to hike the ball. Next, locate the receiver (on either side of the field). Run on the footpad and move the joystick to align the quarterback with the receiver. Make sure there are no players between the quarterback and the receiver. Press the football to pass. If the receiver catches the football, keep running on the footpad and move the joystick to score a touchdown.
- Scoring:
 - Touchdown – 6 Points
 - Extra Point – 1 Point
 - Fake Extra Point – 2 Points
 - Field Goal – 3 Points
- On defense, you need to stop the offense from gaining 1st downs and/or touchdowns. Make sure you align your linebacker (blinking) with the ball carrier by moving the joystick and running on the footpad.
- If you'd like to call a time-out, simply pull back on the joystick while your team is still in the huddle.

ROOKIE PLAY

4th Down Play Calling



- Press the left arrow three times to punt.
- Press the center arrow three times to try a field goal.
- Press the right arrow three times to fake a kick and run a play.
- Press the football to break the huddle.

Hint: If you do not call a special teams play, you will either run or pass.

PRO PLAY

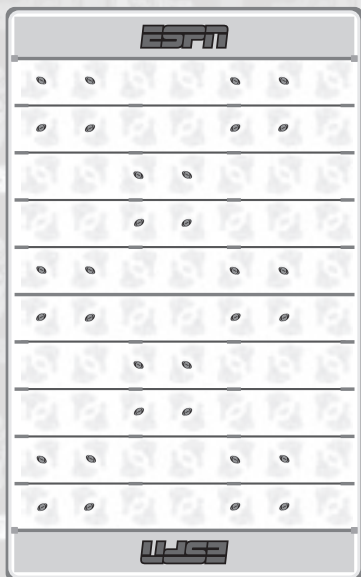

- First, choose a team.
- Move the joystick to scroll through team choices.



- Next, it's time for the coin toss.
- Move the joystick to choose heads or tails.
- Press the football.

PRO PLAY



- If you win the coin toss, choose whether you will kick or receive.
- Move the joystick to choose and press the football.

- Begin game play! Listen carefully to the voice prompts and use the skills learned in Training Camp and Rookie modes to play the game.

PRO PLAY

- You will play on a 100 yard field.
- Each quarter is 4 minutes and it is a 16 minute game.
- On offense, you have 4 downs to move the football at least 10 yards. Use the play call buttons. Decide whether you will run or pass and in which direction. On fourth down, choose whether you will kick a field goal, punt or fake. Make sure you break the huddle within 30 seconds or you'll receive a delay of game penalty. Press the game status button to see the play clock.
- Watch out for the interception. If the defense intercepts the pass, you're on defense!
- Scoring:
 - Touchdown – 6 Points
 - Extra Point – 1 Point
 - Fake Extra Point – 2 Points
 - Field Goal – 3 Points
- On defense, you need to stop the offense from gaining a 1st down and/or a touchdown. Can you guess if the offense will run or pass and in which direction? Use the play call buttons to call a play.
- You can also cause a fumble. Press the football at the same time you are tackling the offensive player!
- If you'd like to call a time out, simply pull back on the joystick while your team is still in the huddle.

PRO PLAY

Offensive Play Calling

Running Plays



- Press the left arrow once to run left.
- Press the center arrow once to run up the middle.
- Press the right arrow once to run right.
- Press the football to break the huddle.

Passing Plays



- Press the left arrow twice to pass left.
- Press the center arrow twice to pass up the middle.
- Press the right arrow twice to pass right.
- Press the football to break the huddle.

Hint: Call your play as fast as you can and press the football to block the defense from calling a play!

PRO PLAY

Offensive Play Calling

4th Down and Kick



- Press the left arrow three times to punt.
- Press the center arrow three times to try a field goal.
- Press the right arrow three times to fake a kick and run a play.
- Press the football to break the huddle.

PRO PLAY

Defensive Play Calling

Run Defense Plays



Pass Defense Plays



- Press the left arrow once to prevent the run to the left.
- Press the center arrow once to prevent the run up the middle.
- Press the right arrow once to prevent the run to the right.

- Press the left arrow twice to prevent the pass to the left.
- Press the center arrow twice to prevent the pass up the middle.
- Press the right arrow twice to prevent the pass to the right.

Hint: Call your play as fast as you can because once your opponent presses the football, you won't be able to call a play.

PLAY TIPS

- The player you control (red joystick or yellow joystick) is the same color (red or yellow) on the field.
- Always move your feet on the footpad while moving the joystick. The faster you run the faster your player moves.
- Remember that the receiver always lines up to the far left or far right of the line of scrimmage.
- If you are on offense and you get beyond the defense don't stop! You will see a line of footballs scrolling toward you every 10 yards. Keep track of where you are on the field by looking at the yard marker and listen to the voice prompts. Keep running to score a touchdown.
- If you are on defense and the running back or receiver gets by you, don't give up! Keep running on the footpad and pull your joystick back to catch up and make the tackle!
- If you do not call a play in Pro mode, the play will automatically go up the middle on offense and defense.
- The lights will turn off after about 5 minutes of non-use. Simply move the joystick to turn them back on and continue to play.
- This product will completely turn off after an hour of non-use. Slide the power switch OFF and then back ON again for a new game.

TROUBLESHOOTING

PROBLEM	SOLUTIONS
No power (no lights or sounds)	Slide the power button to the ON position. If the product has automatically turned off, you will need to slide the power button OFF and then back ON.
	AC adaptor is not plugged into the socket on the underside of the table top. Insert the AC adaptor plug into the socket.
	Power to the wall outlet is turned off. Turn on the light switch that powers the wall outlet.
	This product turns off after about one hour of non-use. To turn back on, slide the power button OFF and then back ON.
	AC adaptor may be damaged. Please contact Fisher-Price® Consumer Relations on-line at www.service.fisher-price.com or call 1-800-432-5437.
Product has sound but no lights	Lights will turn off after about five minutes of non-use. Move the joystick to turn lights on and continue game play.
Sounds and/or lights are erratic	Product electronics are locked up. Slide the power switch OFF and then back ON again.

TROUBLESHOOTING

PROBLEM	SOLUTIONS
Red team player does not move	The red joystick is assembled to the yellow joystick base. Loosen the screws and remove both joysticks. Replace them on the opposite joystick base. Make sure the color of the joystick matches the color of the joystick base.
Yellow team player does not move	The yellow joystick is assembled to the red joystick base. Loosen the screws and remove both joysticks. Replace them on the opposite joystick base. Make sure the color of the joystick matches the color of the joystick base.
Player does not move	Press the football to begin play.
	Move the joystick in the direction you want your player to go and run on the footpad.
	Footpad connectors are not connected to the leg connectors. Refer back to the assembly instructions for proper assembly of the footpads to the legs.
	Footpad may be damaged. Please contact Fisher-Price® Consumer Relations on-line at www.service.fisher-price.com or call 1-800-432-5437.

CONSUMER INFORMATION

Questions?

Visit us on line at www.service.fisher-price.com.

Call our Consumer Relations Department, toll-free at 1-800-432-5437, 9 AM - 7 PM EST Monday through Friday and 11 AM - 5 PM EST Saturday. Hearing-impaired consumers using TTY/TDD equipment, please call 1-800-382-7470. Write to us at: Fisher-Price® Consumer Relations, 636 Girard Avenue, East Aurora, New York 14052.

Fisher-Price, Inc., a subsidiary of Mattel, Inc., East Aurora, NY 14052 U.S.A.

©2006 Mattel, Inc. All Rights Reserved. ® and ™ designate U.S. trademarks of Mattel, Inc.