

FISHMAN[®]

USER GUIDE
LOUDBOX MINI CHARGE[™]



Whenever this symbol appears, it alerts you to the presence of important operating and maintenance (servicing) instructions in the user's manual for this amplifier.



Whenever this symbol appears, it alerts you to the presence of uninsulated dangerous voltage inside the enclosure that may be sufficient to constitute a risk of shock.



Important Safety Instructions

To ensure your personal safety and the safety of others, operate this apparatus only after reading these instructions and heeding the warnings listed below.

1. Read these instructions.
2. Keep these instructions.
3. Heed all warnings.
4. Follow all instructions.
5. Do not use this apparatus near water.
6. Clean only with a dry cloth.
7. Do not block the ventilation openings. Install in accordance with the manufacturer's instructions.
8. Do not install near any heat sources such as radiators, heat registers, stoves or other apparatus (including amplifiers) that produce heat.
9. Do not defeat the safety purpose of the polarized or grounding-type plug. A polarized plug has two blades with one wider than the other. A grounding-type plug has two blades and a third grounding prong. The wide blade or the third prong are provided for your safety. If the provided plug does not fit into your outlet, consult an electrician for replacement of the obsolete outlet.
10. Protect the power cord from being walked on or pinched, particularly at the plugs, convenience receptacles and the point where they exit from the apparatus.
11. Use only attachments/accessories specified by the manufacturer.
12. Use only with a cart, stand, tripod, bracket or table specified by the manufacturer, or sold with the apparatus. When a cart is used, use caution when moving the cart/apparatus combination to avoid injury from tip-over.
13. Unplug this apparatus during lightning storms or when unused for long periods of time.
14. Refer all servicing to qualified service personnel. Servicing is required when the apparatus has been damaged in any way, such as a power-supply cord or plug is damaged, liquid has been spilled or objects have fallen into the apparatus, the apparatus has been exposed to rain or moisture, does not operate normally, or has been dropped.
15. Do not expose the apparatus to dripping or splashing liquids and do not place objects filled with liquids (such as a beverage container or a vase) on the apparatus.
16. Warning” To reduce the risk of fire or electric shock, do not expose this apparatus to moisture.
17. The device is designed and evaluated under the condition of non-tropical climate; and, it can be only used in locations in non-tropical climate areas. Using the device in tropical climate areas would result in high safety risk.
18. Normal operating environmental temperature range: 0 °C [32 °F] to 35 °C [95 °F].
19. WARNING: The battery (battery or batteries or battery pack) shall not be exposed to excessive heat such as sunshine, fire or the like.
20. CAUTION: Danger of explosion if battery is incorrectly replaced. To replace battery use Fishman's approved battery kit only at Certified Service Centers
21. No naked flame sources, such as lighted candles, should be placed on the apparatus.
22. Do not install this equipment in a confined or building-in space such as a book case or similar unit, and remain a well ventilation conditions at open site. The ventilation should not be impeded by covering the ventilation openings with items such as newspaper, table-cloths, curtains etc.

Warning: The mains plug/appliance coupler is used as disconnect device, the disconnect device shall remain readily operable.

Copyright © 2017 FISHMAN TRANSDUCERS, INC.

All rights reserved. No part of this document may be reproduced in any form without the written permission of FISHMAN TRANSDUCERS, INC.

Hear This!

The Loudbox Mini Charge amplifier is capable of cleanly reproducing the sound of your instrument at very high volume levels. Prolonged repeated exposure to high sound pressure levels (SPLs) without protection can cause permanent hearing loss. OSHA has set guidelines and specified permissible sound-exposure limits for those who work in high SPL environments.

Permissible Noise Exposures

Duration per day, hours Sound level dBA slow response

| | |
|-------------|-----|
| 8 | 90 |
| 6 | 92 |
| 4 | 95 |
| 3 | 97 |
| 2 | 100 |
| 1 1/2 | 102 |
| 1 | 105 |
| 1/2 | 110 |
| 1/4 or less | 115 |

To ensure against permanent hearing loss, wear hearing protection when you perform with amplification.



This symbol means the product must not be discarded as household waste, and should be delivered to an appropriate collection facility for recycling. For more information on disposal and recycling of this product, contact your local municipality, disposal service, or the shop where you bought this product.

FCC Compliance Notice

This equipment has been tested and found to comply with the limits for a Class B digital device, pursuant to Part 15 of the FCC Rules. These limits are designed to provide reasonable protection against harmful interference in a residential installation. This equipment generates, uses, and can radiate radio frequency energy and, if not installed and used in accordance with the instructions, may cause harmful interference to radio communications. However, there is no guarantee that interference will not occur in a particular installation. If this equipment does cause harmful interference to radio or television reception, which can be determined by turning the equipment off and on, the user is encouraged to try to correct the interference by one or more of the following measures:

- Reorient or relocate the receiving antenna.
- Increase the separation between the equipment and receiver.
- Connect the equipment into an outlet on a circuit different from that to which the receiver is connected. – Consult the dealer or an experienced radio/TV technician for help. Changes and modifications not expressly approved by FISHMAN TRANSDUCERS can void your authority to operate this equipment under Federal Communications Commissions rules.

M/N: 494-000-582

FCC ID: RMU-494000582

IC: 10812A-494000582

FCC Compliance Statement:

This device complies with Part 15 of the FCC Rules. Operation is subject to the following two conditions:

1. This device may not cause harmful interference, and
2. This device must accept any interference received, including interference that may cause undesired operation.

EU Declaration of Conformity CE: Hereby, Fishman declares that this Loudbox Mini Charge is in compliance with the essential requirements and other relevant provisions of Directive 2014/53/EU, 2014/30/EU, 2014/35/EU.

This device complies with Industry Canada license-exempt RSS standard(s): Operation is subject to the following two conditions: (1) this device may not cause interference, and (2) this device must accept any interference that may cause undesired operation of the device.

Cet appareil est conforme aux normes Industry Canada exemptes de licence standard RSS(s): Son fonctionnement est sujet aux deux conditions suivantes: (1) cet appareil ne peut pas provoquer d'interférences et (2) cet appareil doit accepter toute interférence, y compris les interférences susceptibles de provoquer un fonctionnement indésirable.

Bluetooth®

The Bluetooth® word mark and logos are registered trademarks owned by Bluetooth SIG, Inc. and any use of such marks by Fishman Transducers is under license. Other trademarks and trade names are those of their respective owners.

WARNING!**FCC and IC Radiation Exposure Statement:**

This equipment complies with FCC's and IC's RF radiation exposure limits set forth for an uncontrolled environment under the following conditions:

1. This equipment should be installed and operated such that a minimum separation distance of 20cm is maintained between the radiator (antenna) & user's/nearby person's body at all times.
2. This transmitter must not be co-located or operating in conjunction with any other antenna or transmitter.

Before using Loudbox Mini Charge, carefully read the following:

Important Safety Instructions (Page 1)

Getting Started (Page 5)

Welcome

Thank you for making Fishman a part of your acoustic experience. We are proud to offer the finest acoustic amplification products available; high-quality professional-grade tools which empower you to sound your very best.

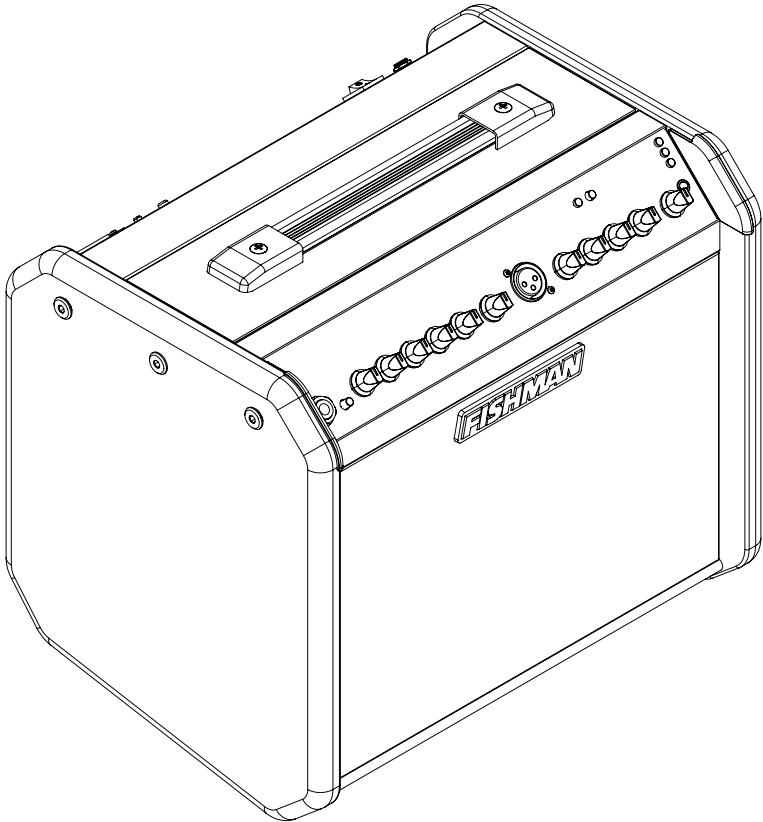

Getting Started

Your new Loudbox Mini Charge is a portable, battery-powered amplifier designed to faithfully reproduce the sound of acoustic instruments and a diverse assortment of vocal or recorded accompaniments.

With the addition of Bluetooth® wireless connectivity, you can now easily and neatly add backing tracks or other accompaniment to your performances, jams, or wherever your Loudbox Mini Charge takes you and your music. Where Are You Going to Take It?™

Here are some basic setup tips to help get you going. To operate your Loudbox Mini Charge safely, please read the entire manual, especially the Important Safety Instructions on page 2.

1. Locate the **Power** switch (next to the rear panel power cord socket) and switch it off, then connect the provided AC adapter into the back of the amplifier and the provided line cord into the AC adapter.
2. Plug the Loudbox Mini Charge line cord into an electrical outlet with the appropriate AC voltage, 100-240VAC 50/60 Hz.
3. Turn down the **Master Volume** control and turn on the **Power** switch. The **Power Indicator** should illuminate. Either the **Battery Indicator** will illuminate if the battery is fully charged or the **Low Battery Indicator** will illuminate if the battery needs charging.
4. Connect your instrument to the **Instrument** input with a shielded ¼" cable.
5. Gradually increase the **Instrument** channel **Gain**:
 - For instruments featuring active (battery-powered) onboard preamps, start with the control around 10 o'clock.
 - For passive pickups, you may start with the control set much higher. It is normal to run this control near its maximum with many passive soundhole pickups.
6. Slowly raise the **Master Volume** to the desired level.

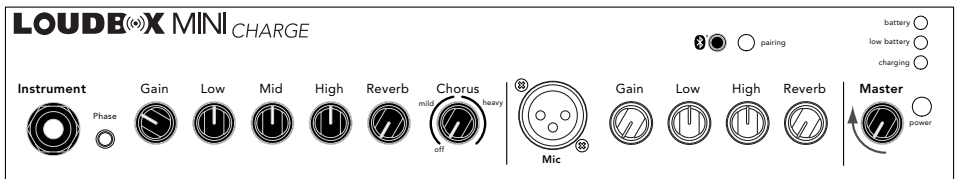

Front Panel

1. Instrument Input

This 1/4" input accepts all types of passive or active acoustic pickups.

2. Phase

Use the Phase switch to improve bass at low volume and suppress feedback at high volumes.

3. Gain

Use the Gain knob to set the signal level for the instrument input.

4. Low

Boost here to add weight to the sound. In general, boost bass at low volumes and cut bass at higher levels. With the dial set at 12 o'clock, the control is effectively out of the circuit.

5. Mid

This control affects how well the instrument blends in or stands out in the mix. At loud volumes, a midrange cut will achieve a more natural sound. With the dial set at 12 o'clock, the control is effectively out of the circuit.

6. High

Boost highs to add "air" to the sound of the instrument. With the knob set at 12 o'clock, the control is effectively out of the circuit.

7. Reverb

Controls the amount of digital reverb in the Instrument channel.

8. Chorus

Controls the depth of two separate chorus presets.

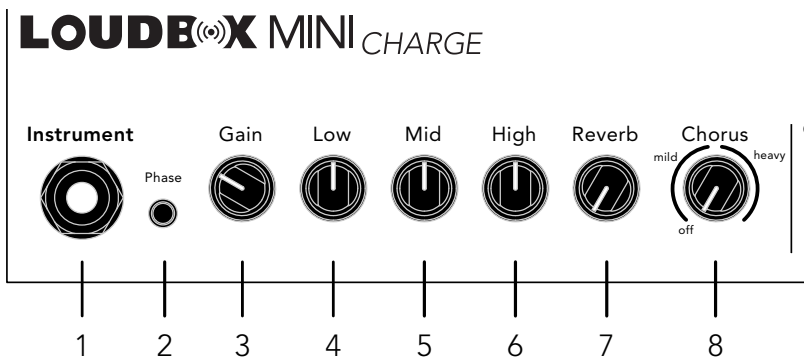

Front Panel (cont.)

9. Mic Input

Plug in a balanced microphone into this XLR input for vocal or for your instrument. The Loudbox Mini Charge makes an excellent mini PA or vocal monitor. You may also connect an outboard preamp with balanced XLR out to this input.

10. Gain

Use the Gain knob to set the signal level for the Microphone input.

11. Low

Boost here to add weight to the sound. In general, boost bass at low volumes and cut bass at higher levels. With the dial set at 12 o'clock, the control is effectively out of the circuit.

12. High

Boost highs to add "air" to the sound of the microphone. With the knob set at 12 o'clock, the control is effectively out of the circuit.

13. Reverb

Controls the amount of digital reverb in the Microphone channel.

14. Master Volume

Set the overall level of the Loudbox Mini Charge with the Master Volume. In general, put the Master Volume as high as possible using less Gain (2 o'clock to 5 o'clock) to achieve the cleanest sound.

15. Power

Lights up when the amplifier power is on. The Power switch is located behind the amp next to the power cord socket.

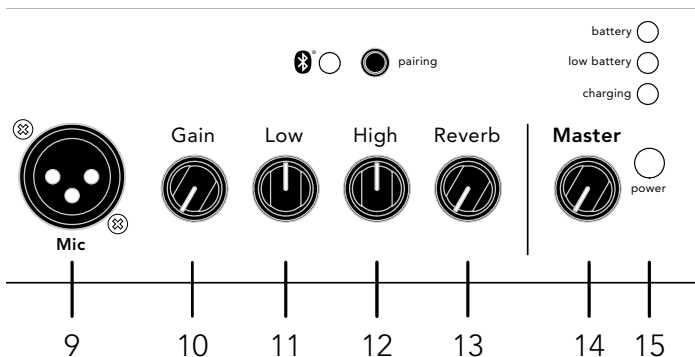

Front Panel (cont.)

16. Bluetooth® Indicator

This green indicator will display a medium flash indicating the Bluetooth® module is ready for pairing. It will display a slow flash indicating the module is ready for reconnection with a previously paired device. The indicator will be on when playback is active and display a fast flash when playback is paused.

17. Bluetooth® Pairing

To pair a Bluetooth® enabled device for the first time, hold the Pairing button more than 5 seconds. You will hear an ascending tone and the Bluetooth® Indicator will change from a slow flash to a fast flash indicating it is ready to pair. Ensure your Bluetooth® enabled device is in pairing mode. Once paired the indicator will stop flashing and will allow you to stream music to the amplifier.

If the button is pressed during paired playback, the playback will be paused and the Bluetooth® Indicator will display a fast flash. Press the button again to resume playback and the Bluetooth® Indicator will return to on.

To activate Bluetooth® for a previously paired device, hold the Pairing button for approximately 1-2 seconds (must be less than 5 seconds). An ascending tone will play briefly to indicate the Bluetooth® is powering on. The Bluetooth® Indicator will slowly flash informing it is ready to reconnect and will pair if your device is in pairing mode.

To turn off the Bluetooth® when already paired, hold the button for 1-2 seconds. A descending tone will indicate that the connection is powering down and the Bluetooth® Indicator will turn off.

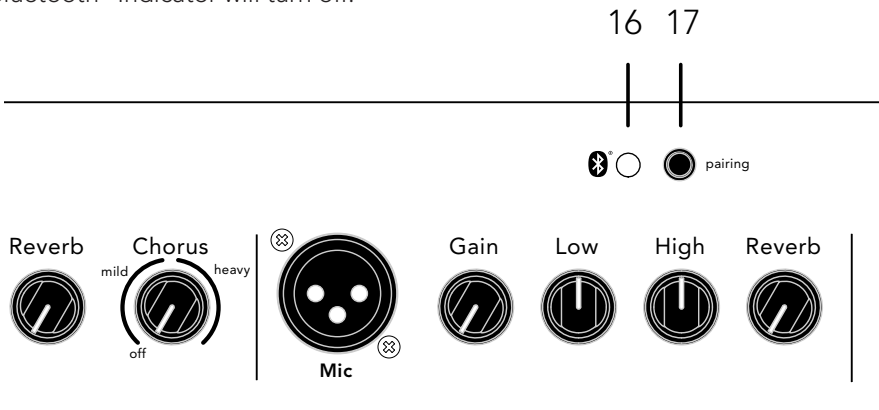

Front Panel (cont.)

18. Green Battery Indicator

When on, this green indicator tells you that the battery is charged, functional and power is available.

19. Red Low Battery Indicator

When on, this red indicator denotes that the battery's available charge is low. All indicators will turn off and the amplifier will shut down if the battery no longer has enough charge to power the amplifier. At this point, the amplifier cannot be powered up until the AC adapter has been plugged in to recharge the battery. The amplifier can be used normally while charging.

20. Yellow Charging Indicator

When on, this yellow indicator denotes that the battery is charging. It only illuminates when the AC adapter is plugged in and the battery is receiving external power to recharge. After the battery is fully charged, this indicator will turn off. The Charging Indicator will also be off if the AC adapter is not connected or receiving power.

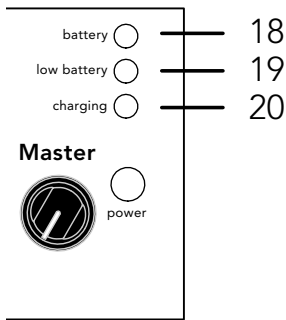

Rear Panel

1. DC In

Operate the amplifier only at the voltage indicated on the rear panel.

Plug in the supplied DC cable into the DC In power socket on the amp. Plug the provided AC cable with the female IEC-style 320 connector into the AC Adapter and the male AC plug appropriate for your region into an outlet.

The DC In is the power input, and when connected appropriately as described above, it will also simultaneously charge the battery if it is below full charge. The amplifier may be used while charging and may be charged when powered down. See the battery indicators on the front panel for battery charge status.

2. Power switch

Lower the Master Volume before you turn on the amp. Flip the power switch to the up position for On.

3. Aux Input - 1/8"

Plug in a line-level stereo audio source such as a CD or MP3 player in this input. The input is stereo; however, the left and right signals are mixed to mono within the amplifier.

4. Mix D.I. (Post)

Plug in here when you wish to send signals from both Channel 1 and 2, plus 1/8" Aux and Bluetooth signals, to a mixing console or a slave amplifier. This post-EQ output is always ground-isolated to prevent ground loop hum.



Tone Tips

Set up

For reference, start with the tone controls set straight-up, (twelve o'clock). In this position, there is no additional boost or cut equalization applied to your sound. Begin at a very low volume and work your way up. As you turn up, try adjusting the Loudbox Mini Charge's tone controls as recommended below.

1. Low volume

At a low volume (just above conversation level) our ears are not very sensitive to bass and treble, so give the Low and High controls a good boost. Try three o'clock on the dial.

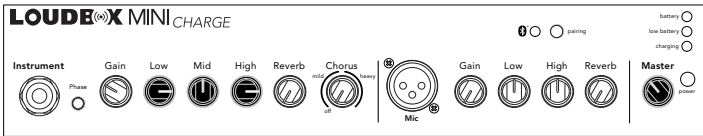

2. Medium volume

At medium levels, when you need to raise your voice to be heard over the music, the human ear is quite sensitive to midrange. Cut the Mid control to about ten o'clock or to your taste. At this level, our perception of bass and treble starts to catch up to the rest of the tonal spectrum, so you can back off the Low and High controls slightly for good tonal balance.

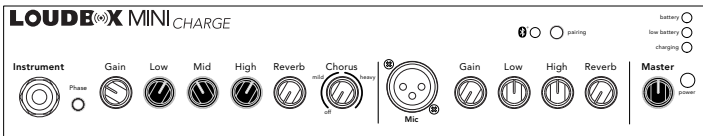

3. High volume

At loud levels, when you must shout to be heard over the music, your ears (and your audience) will benefit from a deep midrange cut. Set the Mid dial between nine and seven o'clock. Our perception of bass and treble "flattens out" at high volumes, so you won't need much, if any, Low or High boost. Set the Low and High knobs to between twelve and one o'clock. In many cases, you can also improve the tone at very high volume if you cut bass. Try setting the Low knob between ten and eleven o'clock.

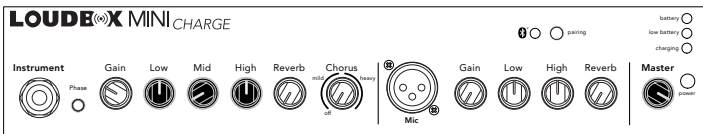

Block Diagram

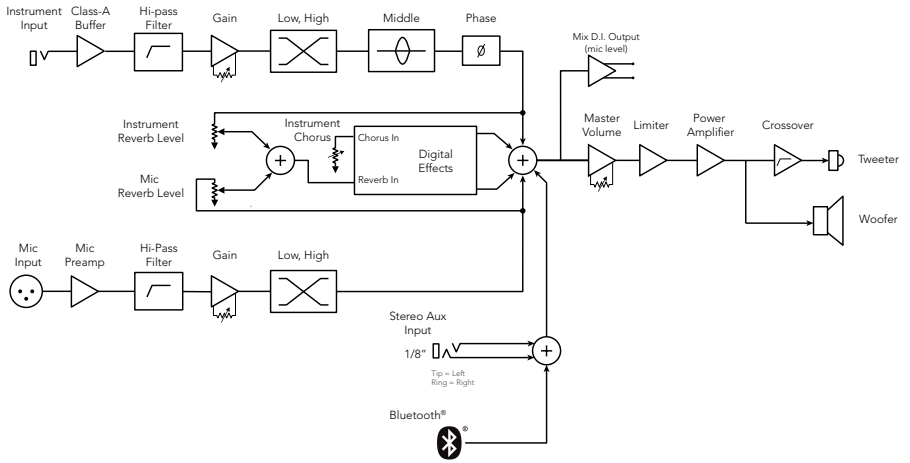

Technical Specifications

Ratings applicable to internal battery or external power source

Output rating:

| | |
|--------------------|-------------------|
| SPL @ 1 meter | 108 dB (measured) |
| Frequency Response | 80 Hz – 20 kHz |

Power rating: 60 W

Battery:

| | |
|------------------------|---------------------------|
| Est. Performance Times | 18 hours (low volume) |
| | 12 hours (average volume) |
| | 4 hours (full volume) |
| Charge Time | 10 hours |

Input impedance:

| | |
|--------------------|---------------|
| Ch. 1 | 10 M Ω |
| Ch. 2 | 2 k Ω |
| Aux Input (stereo) | 10 k Ω |

Tone controls:

| | |
|------|-----------------------------------|
| Low | \pm 12 dB @ 80 Hz (resonant) |
| Mid | \pm 10.5 dB @ 750 Hz (resonant) |
| High | \pm 12.5 dB @ 15 kHz (shelving) |

Mix D.I. out:

| | |
|------------------|--|
| Output Impedance | 600 Ω balanced, mic level Phantom power tolerant |
|------------------|--|

Speaker system:

| | |
|--------------|-----------------|
| Woofers | 6.5" paper cone |
| Tweeter | 1" soft dome |
| Baffle Angle | 10 degrees |

Physical:

| | |
|------------|---|
| Dimensions | 9.7" [D] x 13.7" [W] x 12" [H] (24.7 cm x 34.9 cm x 30.5 cm) |
| Weight | 21.2 lbs (9.6 kg) |

Connectivity:

| | |
|----------|----------------|
| Playback | Bluetooth® 4.0 |
|----------|----------------|

We reserve the right to change any of the specifications and information in this manual without notice.

FISHMAN[®]

fishman.com