



## Raymarine Limited

### 8-Pulse Width Radome Radars

FCC ID: PJ5MTX2-8P & PJ5MTX4-8P

### Pathfinder Radar Scanners Owner's Handbook

**Note:** The Owner's Handbook covers the new 8-Pulse Width Radome Scanner Units as well as the existing Open Array Scanner Units and is in final draft form.

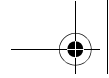

# Pathfinder Radar Scanners Owner's Handbook

Document number: 81154\_6  
Date: 15th December 2001

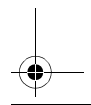
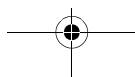
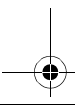
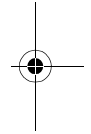
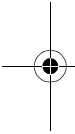

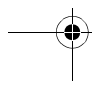
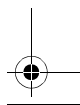
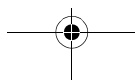
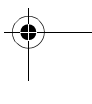
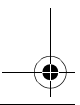
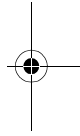
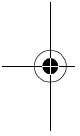
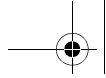

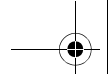

# Pathfinder Radar Scanners Owners Handbook

**December 2001**

## Intended Use

The scanner units detailed in this handbook form part of navigational radar systems intended for light marine use. These radar systems are only an aid to navigation.

### **WARNING:**

**The SL74 radar system (4D radome scanner with an SL70 7" LCD display unit) does not conform to the EU directive 95/5/EC, therefore the SL74 radar system cannot be installed on a vessel within the EU after April 2001.**

## Safety Notices

This radar equipment must be installed and operated in accordance with the instructions contained in this manual. Failure to do so can result in personal injury and/or navigational inaccuracies. In particular:

**1. High Voltage.** The scanner unit contains high voltages. Adjustments require specialised service procedures and tools only available to qualified service technicians – there are no user serviceable parts or adjustments. The operator should never remove the scanner unit internal covers or attempt to service the equipment.

**2. Electromagnetic Energy.** The radar scanner transmits electromagnetic energy. It is important that the radar is turned off whenever personnel are required to come close to the scanner to perform work on the scanner assembly or associated equipment.

It is recommended that the radar scanner is mounted out of range of personnel (above head height).

Do not look directly at the antenna at close range as your eyes are the most sensitive part of the body to electromagnetic energy.

When properly installed and operated, the use of this radar will conform to the requirements of ANSI/IEEE C95.1-1992 Standard for Safety Levels with Respect to Human Exposure to Radio Frequency Electromagnetic Fields, 3 Hz to 300 GHz and NRPB,

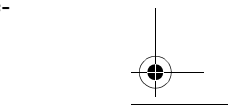
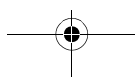
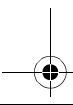
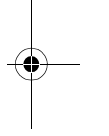
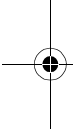



Board Statement on Restrictions on Human Exposure to Static and Time Varying Electromagnetic Fields and Radiation, Doc *NRPB, No. 5 (1993)*.

**3. Navigation Aid.** This radar unit is only an aid to navigation. Its accuracy can be affected by many factors, including equipment failure or defects, environmental conditions, and improper handling or use. It is the user's responsibility to exercise common prudence and navigational judgements. This radar unit should not be relied upon as a substitute for such prudence and judgement.

Raymarine products are supported by a network of Authorized Service Representatives. For information on Raymarine products and services, contact either of the following:

United States Raymarine Inc.  
Recreational Products  
22 Cotton Road, Unit D  
Nashua  
NH 03063-4219, USA  
Telephone +1 603 881 5200  
Fax +1 603 864 4756  
[www.raymarine.com](http://www.raymarine.com)

Europe Raymarine Limited  
Anchorage Park  
Portsmouth  
Hampshire PO3 5TD  
England  
Telephone +44 (0)23 9269 3611  
Fax +44 (0)23 9269 4642  
[www.raymarine.com](http://www.raymarine.com)

Copyright © Raymarine Ltd. 2001

The technical and graphical information contained in this handbook, to the best of our knowledge, was correct as it went to press. However, the Raymarine policy of continuous improvement and updating may change product specifications without prior notice. As a result, unavoidable differences between the product and handbook may occur from time to time, for which liability cannot be accepted by Raymarine.

SeaTalk is a registered trademark of Raymarine Limited.

HSB and *hsb<sup>2</sup>* are trademarks of Raymarine Limited.

Pathfinder is a trademark of Raymarine Limited.

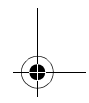
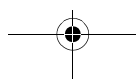
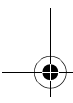
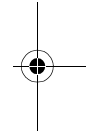
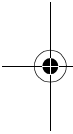

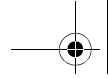

## Preface

This handbook describes the following Raymarine Pathfinder radar scanners:

- 2D 18" 2 kW Radome Scanner
- 4D 24" 4 kW Radome Scanner
- 5S 48" 4 kW Open Array Scanner
- 7S 72" 4 kW Open Array Scanner
- 9S 48" 10 kW Open Array Scanner
- 11S 72" 10 kW Open Array Scanner

These scanner units may be connected to any HSB/*hsb*<sup>2</sup> display unit. In addition, the 2D radome scanner unit may be connected to an SL70 or SL70 PLUS 7" LCD display.

### **CAUTION:**

**The open array scanners must not be used with the SL70 or Autohelm 7" LCD Display Unit. This may result in damage to the display due to the high power requirements of the open array scanner.**

The handbook contains very important information on the installation and operation of your new equipment. In order to obtain the best results in operation and performance, please read this handbook thoroughly.

Raymarine's Product Support representatives or your local dealer will be available to answer any questions you may have.

### **Display Software Version**

For full operation of the Pathfinder scanners, the display unit requires an appropriate software version. For new displays, the correct software version is normally already installed in the display unit and is fully compatible with the Pathfinder scanners.

Early display units may not have the correct software and will therefore require upgrading.

The software version can be confirmed by switching-on the display and checking the version number during the magnetron warm-up sequence.

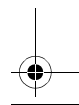
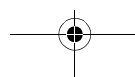
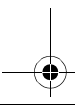
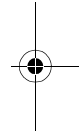
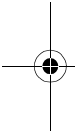



**Note:** *If a scanner unit is not connected the version number is only displayed for 10 seconds.*

Where, necessary Software Upgrade Kits are available from your dealer, distributor or from Raymarine.

We recommend that where a repeater display is fitted, both the repeater and the master display are upgraded.

## Warranty

To register your Pathfinder Radar Scanner ownership, please take a few minutes to fill out the warranty registration card found at the end of this handbook. It is very important that you complete the owner information and return the card to the factory in order to receive full warranty benefits.

The radome scanner package includes a barcode label indicating the serial number of the unit. This label should be stuck to the warranty registration card.

The open array scanner has two barcode labels indicating the serial numbers of the pedestal and the antenna units. Both labels should be stuck to the warranty registration card.

## EMC Conformance

All Raymarine equipment and accessories are designed to the best industry standards for use in the leisure marine environment.

The design and manufacture of Raymarine equipment and accessories conform to the appropriate Electromagnetic Compatibility (EMC) standards, but correct installation is required to ensure that performance is not compromised.

### Declaration of Conformity

The following Declarations of Conformity, RT009, RT010, RT011 and RT012 apply to the equipment described in this handbook.

**Raymarine**  
ON BOARD

Certificate No.  
**RT009**

# EC Declaration of Conformity

We **Raymarine Limited**

**Anchorage Park  
Portsmouth  
Hampshire  
England PO3 5TD**

*declare, under our sole responsibility, that the products identified in this declaration, and to which this declaration relates, are in conformity with the essential requirements of European Parliament and Council Directive:*

*1999/5/EC on radio equipment and telecommunication terminal equipment and the mutual recognition of their conformity.*

Product Name: **Raymarine or Raytheon 2D – 2kW, 18" Radome Scanner Unit**

Product Number(s): **M92650**

Ancillary Units **'PLUS' Displays - details given on Sheet 2**

*The products have been assessed to Conformity Procedure Annex IV of the Directive and by application of the following standard(s):*

EMC **EN 60945 : 1997**  
Health & Safety **EN 60945 : 1997**

*The assessment is consistent with a Technical Construction File showing conformity with the essential requirements of the Directive and has been reviewed by Notified Body No. 0191*

*The product is labelled with the CE conformity marking, the identification number of the Notified Body and class identifier.*

Signatory:	Name	<b>Adil Abbas</b>
	Title	<b>EMC Manager</b>
	Company Name	<b>Raymarine Limited</b>
	Company Address	<b>Anchorage Park Portsmouth, Hampshire England PO3 5TD</b>

Signature	_____
Date	<b>24 September 2001</b>

Sheet 1 of 2



Certificate No.

**RT009**

## Declaration of Conformity – Schedule of Ancillary Equipment and Radar Systems

*The following Raymarine Display Units are combined with the Raymarine or Raytheon 2D – 2kW, 18" Radome Scanner Unit (transceiver) listed on Sheet 1 to form the operational radar systems given below. Details of these units are included in the Technical Construction File:*

DISPLAY (one of)

Description	Designation	Part No.
Display Unit, 7" Mono LCD	SL70 PLUS	E52028
Display Unit, 7" Mono LCD/hsb <sup>2</sup>	RL70 PLUS	E52031
Display Unit, 7" Mono LCD/hsb <sup>2</sup> /Chart	RL70RC PLUS	E52032
Display Unit, 7" CRT/hsb <sup>2</sup>	R70 PLUS	E52039
Display Unit, 7" CRT/hsb <sup>2</sup> /Chart	R70RC PLUS	E52040
Display Unit, 10" CRT/hsb <sup>2</sup>	R80 PLUS	E52035
Display Unit, 10" CRT/hsb <sup>2</sup> /Chart	R80RC PLUS	E52036
Display Unit, 7" Colour LCD/hsb <sup>2</sup>	RL70C PLUS	E52033
Display Unit, 7" Colour LCD hsb <sup>2</sup> /Chart	RL70CRC PLUS	E52034
Display Unit, 10" Colour LCD/hsb <sup>2</sup>	RL80C PLUS	E52037
Display Unit, 10" Colour LCD/hsb <sup>2</sup> /Chart	RL80CRC PLUS	E52038

PATHFINDER RADAR SYSTEMS

Radar System Designation	Scanner Unit Designation	Display Unit Designation
SL72 PLUS	2D	SL70 PLUS
RL72 PLUS	2D	RL70 PLUS
RL72RC PLUS	2D	RL70RC PLUS
R72 PLUS	2D	R70 PLUS
R72RC PLUS	2D	R70RC PLUS
R82 PLUS	2D	R80 PLUS
R82RC PLUS	2D	R80RC PLUS
RL72C PLUS	2D	RL70C PLUS
RL72CRC PLUS	2D	RL70CRC PLUS
RL82C PLUS	2D	RL80C PLUS
RL82CRC PLUS	2D	RL80CRC PLUS

Sheet 2 of 2

**Raymarine**  
ON BOARD

Certificate No.  
**RT010**

# EC Declaration of Conformity

We **Raymarine Limited**

**Anchorage Park  
Portsmouth  
Hampshire  
England PO3 5TD**

*declare, under our sole responsibility, that the products identified in this declaration, and to which this declaration relates, are in conformity with the essential requirements of European Parliament and Council Directive:*

*1999/5/EC on radio equipment and telecommunication terminal equipment and the mutual recognition of their conformity.*

Product Name: **Raymarine or Raytheon 4D – 4kW, 24"  
Radome Scanner Unit**

Product Number(s): **M92652**

Ancillary Units **'PLUS' Display details given on Sheet 2**

*The products have been assessed to Conformity Procedure Annex IV of the Directive and by application of the following standard(s):*

EMC **EN 60945 : 1997**  
Health & Safety **EN 60945 : 1997**

*The assessment is consistent with a Technical Construction File showing conformity with the essential requirements of the Directive and has been reviewed by Notified Body No. 0191*

*The product is labelled with the CE conformity marking, the identification number of the Notified Body and class identifier.*

Signatory:	Name	<b>Adil Abbas</b>
	Title	<b>EMC Manager</b>
	Company Name	<b>Raymarine Limited</b>
	Company Address	<b>Anchorage Park Portsmouth, Hampshire England PO3 5TD</b>

Signature	_____
Date	<b>24 September 2001</b>

Sheet 1 of 2

Certificate No.

**RT010**

## Declaration of Conformity – Schedule of Ancillary Equipment and Radar Systems

*The following Raymarine Display Units are combined with the Raymarine or Raytheon 4D – 4kW, 24" Radome Scanner Unit (transceiver) listed on Sheet 1 to form the operational radar systems given below. Details of these units are included in the Technical Construction File:*

DISPLAY (one of)

Description	Designation	Part No.
Display Unit, 7" Mono LCD/hsb <sup>2</sup>	RL70 PLUS	E52031
Display Unit, 7" Mono LCD/hsb <sup>2</sup> /Chart	RL70RC PLUS	E52032
Display Unit, 7" CRT/hsb <sup>2</sup>	R70 PLUS	E52039
Display Unit, 7" CRT/hsb <sup>2</sup> /Chart	R70RC PLUS	E52040
Display Unit, 10" CRT/hsb <sup>2</sup>	R80 PLUS	E52035
Display Unit, 10" CRT/hsb <sup>2</sup> /Chart	R80RC PLUS	E52036
Display Unit, 7" Colour LCD/hsb <sup>2</sup>	RL70C PLUS	E52033
Display Unit, 7" Colour LCD hsb <sup>2</sup> /Chart	RL70CRC PLUS	E52034
Display Unit, 10" Colour LCD/hsb <sup>2</sup>	RL80C PLUS	E52037
Display Unit, 10" Colour LCD/hsb <sup>2</sup> /Chart	RL80CRC PLUS	E52038

PATHFINDER RADAR SYSTEMS

Radar System Designation	Scanner Unit Designation	Display Unit Designation
RL74 PLUS	4D	RL70 PLUS
RL74RC PLUS	4D	RL70RC PLUS
R74 PLUS	4D	R70 PLUS
R74RC PLUS	4D	R70RC PLUS
R84 PLUS	4D	R80 PLUS
R84RC PLUS	4D	R80RC PLUS
RL74C PLUS	4D	RL70C PLUS
RL74CRC PLUS	4D	RL70CRC PLUS
RL84C PLUS	4D	RL80C PLUS
RL84CRC PLUS	4D	RL80CRC PLUS

Sheet 2 of 2

**Raymarine**  
ON BOARD

Certificate No.  
**RT011**

# EC Declaration of Conformity

We **Raymarine Limited**

**Anchorage Park  
Portsmouth  
Hampshire  
England PO3 5TD**

*declare, under our sole responsibility, that the products identified in this declaration, and to which this declaration relates, are in conformity with the essential requirements of European Parliament and Council Directive:*

*1999/5/EC on radio equipment and telecommunication terminal equipment and the mutual recognition of their conformity.*

Product Name: **Raymarine or Raytheon 4kW Open Array Scanner Unit**  
Product Number(s): **M92654**  
Ancillary Units **'PLUS' Display details given on Sheet 2**

*The products have been assessed to Conformity Procedure Annex IV of the Directive and by application of the following standard(s):*

EMC **EN 60945 : 1997**  
Health & Safety **EN 60945 : 1997**

*The assessment is consistent with a Technical Construction File showing conformity with the essential requirements of the Directive and has been reviewed by Notified Body No. 0191*

*The product is labelled with the CE conformity marking, the identification number of the Notified Body and class identifier.*

Signatory: Name **Adil Abbas**  
Title **EMC Manager**  
Company Name **Raymarine Limited**  
Company Address **Anchorage Park  
Portsmouth, Hampshire  
England PO3 5TD**

Signature \_\_\_\_\_  
Date **24 September 2001**

Sheet 1 of 2

**RT011****Declaration of Conformity – Schedule of Ancillary Equipment and Radar Systems**

The following Raymarine Display Units are combined with the Raymarine or Raytheon 4kW, Open Array Scanner Unit (transceiver) listed on Sheet 1 to form the operational radar systems given below. Details of these units are included in the Technical Construction File:

DISPLAY (one of)

Description	Designation	Part No.
Display Unit, 7" Mono LCD/hsb <sup>2</sup>	RL70 PLUS	E52031
Display Unit, 7" Mono LCD/hsb <sup>2</sup> /Chart	RL70RC PLUS	E52032
Display Unit, 7" CRT/hsb <sup>2</sup>	R70 PLUS	E52039
Display Unit, 7" CRT/hsb <sup>2</sup> /Chart	R70RC PLUS	E52040
Display Unit, 10" CRT/hsb <sup>2</sup>	R80 PLUS	E52035
Display Unit, 10" CRT/hsb <sup>2</sup> /Chart	R80RC PLUS	E52036
Display Unit, 7" Colour LCD/hsb <sup>2</sup>	RL70C PLUS	E52033
Display Unit, 7" Colour LCD hsb <sup>2</sup> /Chart	RL70CRC PLUS	E52034
Display Unit, 10" Colour LCD/hsb <sup>2</sup>	RL80C PLUS	E52037
Display Unit, 10" Colour LCD/hsb <sup>2</sup> /Chart	RL80CRC PLUS	E52038

ANTENNA (one of)

Description	Part No.	Scanner Unit Designation (Transceiver + Antenna)
48" Antenna	M92693	5S
72" Antenna	M92743	7S

PATHFINDER RADAR SYSTEMS

Designation		
Radar System	Scanner Unit	Display Unit
RL75 PLUS	5S	RL70 PLUS
RL75RC PLUS	5S	RL70RC PLUS
R75 PLUS	5S	R70 PLUS
R75RC PLUS	5S	R70RC PLUS
R85 PLUS	5S	R80 PLUS
R85RC PLUS	5S	R80RC PLUS
RL75C PLUS	5S	RL70C PLUS
RL75CRC PLUS	5S	RC70CRC PLUS
RL85C PLUS	5S	RL80C PLUS
RL85CRC PLUS	5S	RL80CRC PLUS

Designation		
Radar System	Scanner Unit	Display Unit
RL77 PLUS	7S	RL70 PLUS
RL77RC PLUS	7S	RL70RC PLUS
R77 PLUS	7S	R70 PLUS
R77RC PLUS	7S	R70RC PLUS
R87 PLUS	7S	R80 PLUS
R87RC PLUS	7S	R80RC PLUS
RL77C PLUS	7S	RL70C PLUS
RL77CRC PLUS	7S	RC70CRC PLUS
RL87C PLUS	7S	RL80C PLUS
RL87CRC PLUS	7S	RL80CRC PLUS

**Raymarine**  
ON BOARD

Certificate No.  
**RT012**

# EC Declaration of Conformity

We **Raymarine Limited**

**Anchorage Park  
Portsmouth  
Hampshire  
England PO3 5TD**

*declare, under our sole responsibility, that the products identified in this declaration, and to which this declaration relates, are in conformity with the essential requirements of European Parliament and Council Directive:*

*1999/5/EC on radio equipment and telecommunication terminal equipment and the mutual recognition of their conformity.*

Product Name: **Raymarine or Raytheon 10kW Open Array Scanner Unit**

Product Number(s): **M92655**

Ancillary Units **'PLUS' Display details given on Sheet 2**

*The products have been assessed to Conformity Procedure Annex IV of the Directive and by application of the following standard(s):*

EMC **EN 60945 : 1997**  
Health & Safety **EN 60945 : 1997**

*The assessment is consistent with a Technical Construction File showing conformity with the essential requirements of the Directive and has been reviewed by Notified Body No. 0191*

*The product is labelled with the CE conformity marking, the identification number of the Notified Body and class identifier.*

Signatory:	Name	<b>Adil Abbas</b>
	Title	<b>EMC Manager</b>
	Company Name	<b>Raymarine Limited</b>
	Company Address	<b>Anchorage Park Portsmouth, Hampshire England PO3 5TD</b>

Signature	_____
Date	<b>24 September 2001</b>

**RT012****Declaration of Conformity – Schedule of Ancillary Equipment and Radar Systems**

The following Raymarine Display Units are combined with the Raymarine or Raytheon 10kW, Open Array Scanner Unit (transceiver) listed on Sheet 1 to form the operational radar systems given below. Details of these units are included in the Technical Construction File:

DISPLAY (one of)

Description	Designation	Part No.
Display Unit, 7" Mono LCD/hsb <sup>2</sup>	RL70 PLUS	E52031
Display Unit, 7" Mono LCD/hsb <sup>2</sup> /Chart	RL70RC PLUS	E52032
Display Unit, 7" CRT/hsb <sup>2</sup>	R70 PLUS	E52039
Display Unit, 7" CRT/hsb <sup>2</sup> /Chart	R70RC PLUS	E52040
Display Unit, 10" CRT/hsb <sup>2</sup>	R80 PLUS	E52035
Display Unit, 10" CRT/hsb <sup>2</sup> /Chart	R80RC PLUS	E52036
Display Unit, 7" Colour LCD/hsb <sup>2</sup>	RL70C PLUS	E52033
Display Unit, 7" Colour LCD hsb <sup>2</sup> /Chart	RL70CRC PLUS	E52034
Display Unit, 10" Colour LCD/hsb <sup>2</sup>	RL80C PLUS	E52037
Display Unit, 10" Colour LCD/hsb <sup>2</sup> /Chart	RL80CRC PLUS	E52038

ANTENNA (one of)

Description	Part No.	Scanner Unit Designation (Transceiver + Antenna)
48" Antenna	M92693	5S
72" Antenna	M92743	7S

PATHFINDER RADAR SYSTEMS

Designation			Designation		
Radar System	Scanner Unit	Display Unit	Radar System	Scanner Unit	Display Unit
RL79 PLUS	9S	RL70 PLUS	RL711 PLUS	11S	RL70 PLUS
RL79RC PLUS	9S	RL70RC PLUS	RL11RC PLUS	11S	RL70RC PLUS
R79 PLUS	9S	R70 PLUS	R11 PLUS	11S	R70 PLUS
R79RC PLUS	9S	R70RC PLUS	R711RC PLUS	11S	R70RC PLUS
R89 PLUS	9S	R80 PLUS	R811 PLUS	11S	R80 PLUS
R89RC PLUS	9S	R80RC PLUS	R811RC PLUS	11S	R80RC PLUS
RL79C PLUS	9S	RL70C PLUS	RL711C PLUS	11S	RL70C PLUS
RL79CRC PLUS	9S	RC70CRC PLUS	RL711CRC PLUS	11S	RC70CRC PLUS
RL89C PLUS	9S	RL80C PLUS	RL811C PLUS	11S	RL80C PLUS
RL89CRC PLUS	9S	RL80CRC PLUS	RL811CRC PLUS	11S	RL80CRC PLUS

## Contents

<b>Chapter 1: Overview .....</b>	<b>1</b>
1.1 Introduction .....	1
EMC installation guidelines .....	2
1.2 Unpacking and inspecting the components .....	4
1.3 Selecting the scanner unit site .....	5
1.4 Cable runs .....	11
Radome scanner cables .....	13
Open array scanner cables .....	16
<b>Chapter 2: Installing the Scanner .....</b>	<b>21</b>
2.1 Radome scanner .....	21
Securing the radome scanner to the mounting surface ....	21
Connecting the radome scanner inter-unit cable .....	22
2.2 Open array scanner .....	27
Securing the pedestal to the mounting platform .....	28
Connecting the open array scanner inter-unit cable .....	29
Fitting the open array to the pedestal .....	33
2.3 System connections .....	35
DC power connection .....	35
Scanner connection .....	36
Display unit connection .....	38
<b>Chapter 3: Post Installation Checks and Maintenance .....</b>	<b>39</b>
EMC Conformance .....	39
3.1 System Checks and Alignment .....	39
System check .....	39
Set up, alignment and timing checks .....	39
72" open array position alignment .....	40
3.2 Maintenance .....	41
Warnings .....	41
Routine Checks .....	41
Servicing and Safety .....	41
3.3 Problem Solving .....	42
How to Contact Raymarine (US) .....	43
How to Contact Raymarine (Europe) .....	44
Worldwide Support .....	45
<b>Appendix A: Specification .....</b>	<b>47</b>
2D 18" Radome Scanner Unit .....	47
4D 24" Radome Scanner Unit .....	48
5S and 9S 48" Open Array Scanner Unit .....	50
7S and 11S 72" Open Array Scanner Unit .....	53



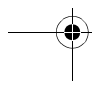
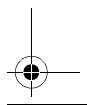
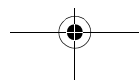
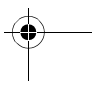
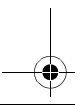
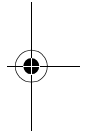
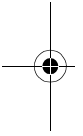
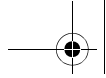

# Chapter 1: Overview

## 1.1 Introduction

This handbook provides instructions to assist you in the installation and set up of the following radar scanners:

- 2D 18" 2 kW Radome Scanner
- 4D 24" 4 kW Radome Scanner
- 5S 48" 4 kW Open Array Scanner
- 7S 72" 4 kW Open Array Scanner
- 9S 48" 10 kW Open Array Scanner
- 11S 72" 10 kW Open Array Scanner

These scanner units may be connected to any HSB/*hsb*<sup>2</sup> display unit.

A typical Pathfinder Radar system is illustrated below.

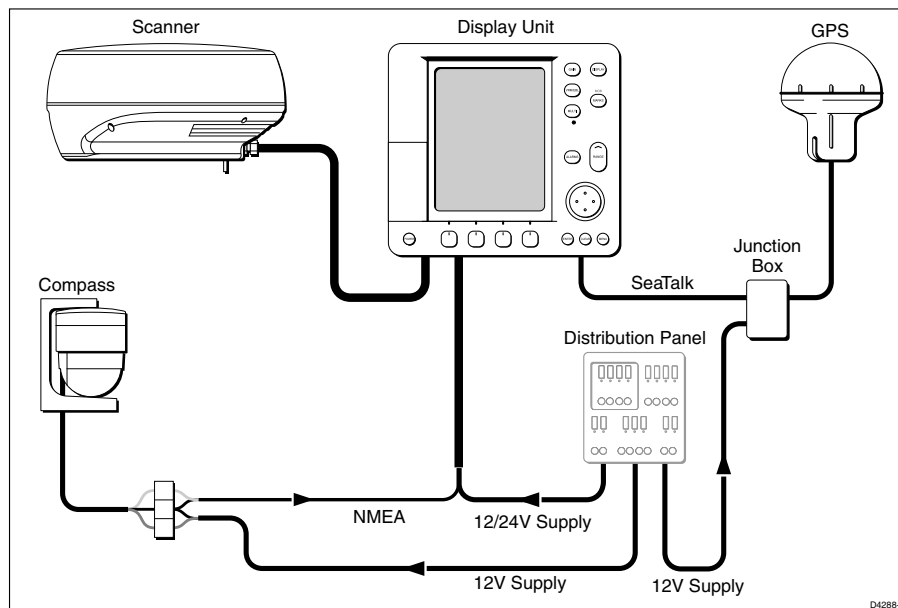

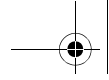
**CAUTION:**

**Do not use an open array scanner with an SL70 or SL70 PLUS 7" LCD display unit. Failure to observe this may result in permanent damage to these display units. The 10 kW open array scanner requires 24 V or higher; it will not operate on 12 V systems.**

This handbook is divided into three chapters as follows:

**Chapter One** provides an overview of the scanner installation. It includes sections on Unpacking and Inspecting the Components, Selecting the Scanner Site and a description of the Cable Runs.

**Chapter Two** provides detailed instructions on how to mount and connect each type of scanner.

**Chapter Three** provides instructions on how to perform the system checks, alignment and adjustments. It also provides information on maintenance and what to do if you have problems.

## EMC installation guidelines

All Raymarine equipment and accessories are designed to the best industry standards for use in the leisure marine environment.

Their design and manufacture conforms to the appropriate Electromagnetic Compatibility (EMC) standards, but correct installation is required to ensure that performance is not compromised. Although every effort has been taken to ensure that they will perform under all conditions, it is important to understand what factors could affect the operation of the product.

The guidelines given here describe the conditions for optimum EMC performance, but it is recognized that it may not be possible to meet all of these conditions in all situations. To ensure the best possible conditions for EMC performance within the constraints imposed by any location, always ensure the maximum separation possible between different items of electrical equipment.

For **optimum** EMC performance, it is recommended that **wherever possible**:

- Raymarine equipment and cables connected to it are:
  - At least 1 m (3 ft) from any equipment transmitting or cables carrying radio signals e.g. VHF radios, cables and antennas.

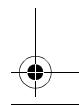
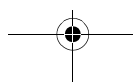
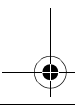
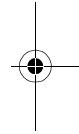
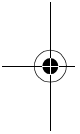



In the case of SSB radios, the distance should be increased to 2 m (7 ft).

- More than 2 m (7 ft) from the path of a radar beam. A radar beam can normally be assumed to spread 20 degrees above and below the radiating element.
- The equipment is supplied from a separate battery from that used for engine start. Voltage drops below 10 V (20 V for 10 kW open array scanners) in the power supply to our products, and starter motor transients, can cause the equipment to reset. This will not damage the equipment, but may cause the loss of some information and may change the operating mode.
- Raymarine specified cables are used at all times. Cutting and rejoining these cables can compromise EMC performance and so must be avoided unless doing so is detailed in the installation manual.
- If a suppression ferrite is attached to a cable, this ferrite should not be removed. If the ferrite needs to be removed during installation it must be reassembled in the same position. *Section 2.1, Radome scanner* includes instructions on fitting a ferrite.

The following illustration shows a typical range of suppression ferrites fitted to Raymarine equipment.

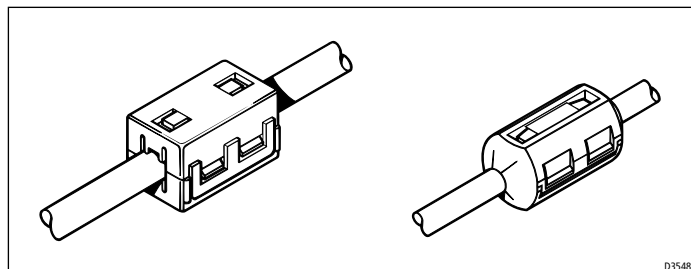

## Connections to Other Equipment

If your Raymarine equipment is to be connected to other equipment using a cable not supplied by Raymarine, a suppression ferrite **MUST** always be fitted to the cable close to the Raymarine unit.

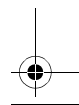
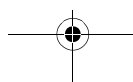
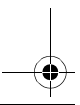
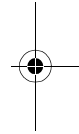
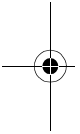

## 1.2 Unpacking and inspecting the components

Unpack your system carefully, to prevent damage to the equipment. It is good practice to save the carton and packing for future use, in case you need to return the unit for service. Check that you have all the correct system components. These depend on your system package, as detailed in the following tables.

Table 1-1: Radome scanners

Item	Part No.	Supplied with:	Option for:
2D 18" 2 kW Radome Scanner	M92650	US Version	-
2DE 18" 2 kW Radome Scanner	M92650E	European Version	-
4D 24" 4 kW Radome Scanner	M92652	-	-
Inter-unit cable 15 m heavy	M92668	4D	-
Inter-unit cable 25 m heavy	M92669	-	Both
Inter-unit cable 10 m light	M92692	2D (US version)	-
Inter-unit cable 15 m light	M92720	2D (Europe version)	-
Extension cable 5 m	M92699	-	Both
Extension cable 10 m	M92700	-	Both
Mast Mount 18" Scanner	M92722	-	2D
Mast Mount 24" Scanner	M92698	-	4D
Radar Interface adapter (To fit radome to M88390 type 18" mast mount)	M92721	-	2D
Radome mounting interface plate	M92731	-	2D

Table 1-2: Open array scanners

Item	Part No.	Supplied with:	Option for:
4 kW Scanner Pedestal	M92654	5S, 7S	-
10 kW Scanner Pedestal	M92655	9S, 11S	-
48" Open Array	M92693	5S, 9S	-
72" Open Array	M92743	7S, 11S	-
Inter-unit cable 15 m heavy	M92728	-	5S, 7S, 9S, 11S
Inter-unit cable 25 m heavy	M92705	-	5S, 7S, 9S, 11S
Cable kit: 5 m +10 m extension (To fit open array scanner on a radar arch)	E55017	-	5S, 7S, 9S, 11S
Extension cable 5m	M92699	-	5S, 7S, 9S, 11S
Extension cable 10m	M92700	-	5S, 7S, 9S, 11S
Note: 9S and 11S scanners require 24/32V			
Software Upgrade Kit	Please contact your authorized dealer or distributor for details		



## 1.3 Selecting the scanner unit site

This section provides information that affects the possible locations of the scanner, and its position relative to the display unit and to the power supply.

The dimensions of the each scanner unit are shown in the following diagrams.

Selecting the best location for the scanner unit requires careful consideration of the following points, to ensure reliable and trouble free operation:

**Note:** *In order to minimize potential interference to other systems on board ship (EMC), it is advisable to mount the scanner on a part of the boat that is insulated from the ship's battery negative. If you cannot do this, and encounter problems, you can fit insulating bushes between the scanner and its mounting bracket.*

- **Height:** The scanner unit should normally be mounted as high as practical above the waterline, for three reasons:
  - For safety reasons the scanner should be out of range of personnel, preferably above head height. This avoids mechanical danger and electromagnetic contact, particularly with the eyes.
  - Radar operates at the line-of-sight, so a high mounting position gives better long range performance.
  - Surrounding large objects, in the same horizontal plane, can interfere with the radar signal and cause blind areas or shadow sectors and false targets on the radar screen (see below).

However, do not mount the scanner so high that it is affected by the pitching and rolling of the vessel. In addition, you may need to lower the scanner to avoid creating a shadow sector underneath the scanner's beam.

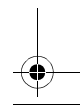
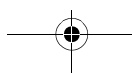
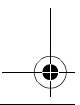
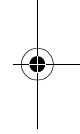
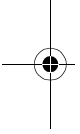

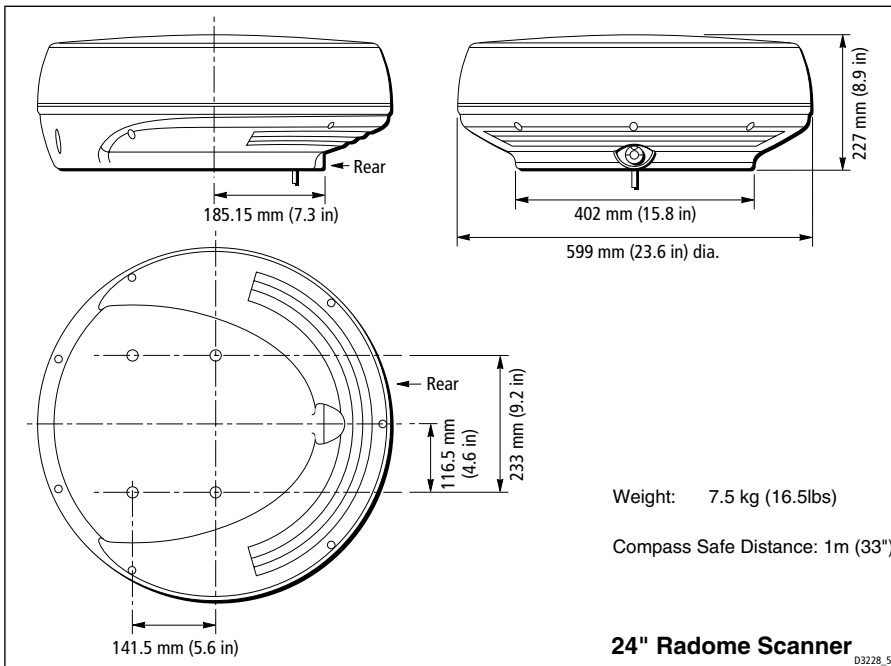
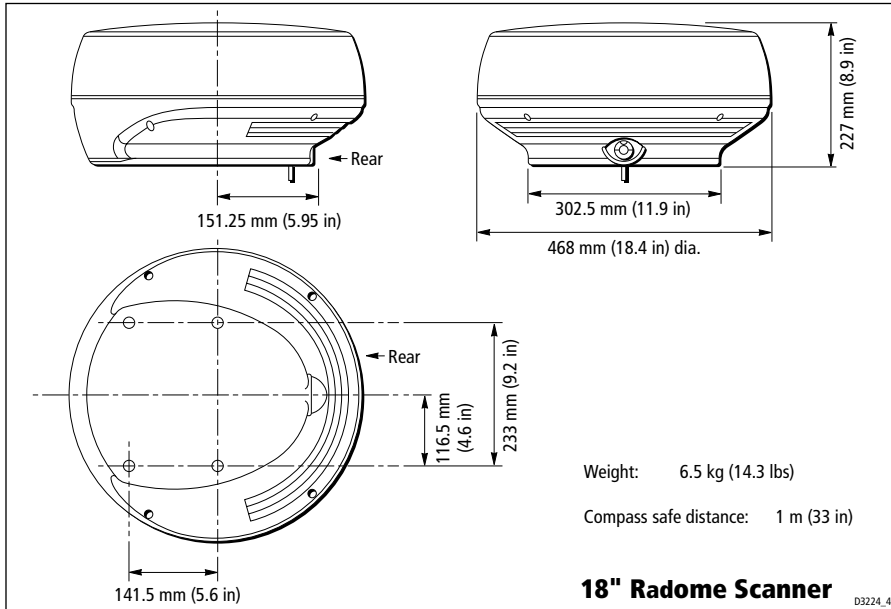

### Open Array Scanners

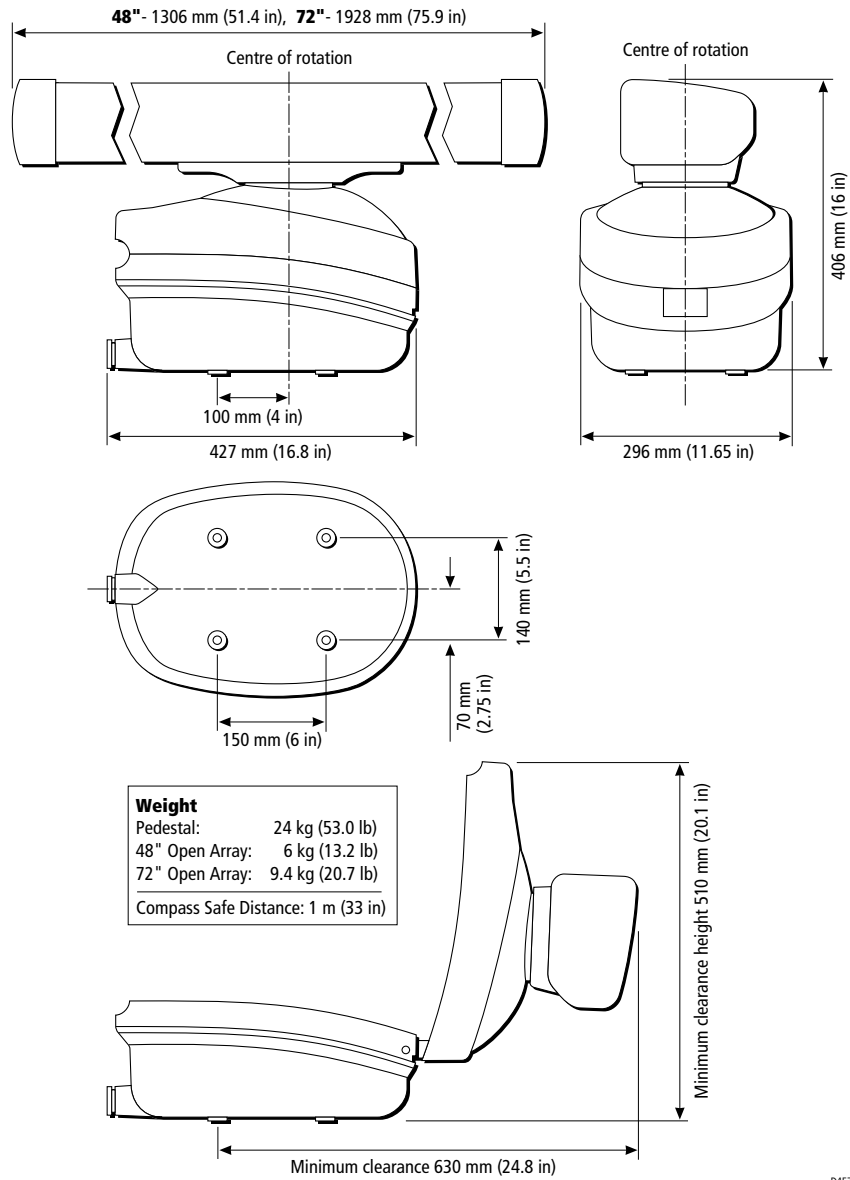

D4572-4



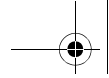

- **Access:** The scanner unit site should be easily accessible to allow maintenance to be carried out safely.
- **Magnetic compass:** Mount the scanner unit at least 1 m away from a magnetic compass.
- **Cable run:** The maximum length of cable between the display unit and the scanner unit should not normally exceed 20 m (60 ft) for radome scanners, or 15 m (45 ft) for open array scanners. If you need to use a longer cable power cable lengths must be considered, refer to *Section 1.4 Cable Runs* to determine appropriate lengths.
- **Shadow sectors and false echoes:** Mount the scanner away from large structures or equipment, such as the fly bridge, large engine stacks, searchlights, horns, or masts. It is particularly important to avoid shadow sectors near the bow. Raising or even lowering the scanner may help to reduce these effects.

In shadow areas beyond the obstruction there will be a reduction of the beam intensity, although not necessarily a complete cut-off; there will be a blind sector if the subtended angle is more than a few degrees.

In some shadow sectors the beam intensity may not be sufficient to obtain an echo from a very small object, even at close range, despite the fact that a large vessel can be detected at a much greater range. For this reason the angular width and relative bearing of any shadow sector must be determined at installation.

Sometimes shadowing can be seen by increasing the radar gain until noise is present. Dark sectors indicate possible shadowed areas. This information should be posted near the display unit and operators must be alert for targets in these blind sectors.

It should also be noted that wet sails create shadow areas and thus sail boat operators should be aware that radar performance may reduce in rain.

If you mount the scanner on a mast, echoes from the mast may appear on the radar display. These can be minimized by placing absorbing material, such as a block of wood, between the scanner and mast.

- **Platform rigidity/stability:** The scanner platform should not twist (causing bearing errors) or be subject to excessive vibration.
- **Heat/fumes:** Mount the scanner away from the top of exhaust stacks, since the scanner and cables can be damaged by excessive heat and the corrosive effects of exhaust gases.

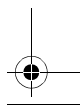
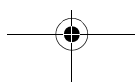
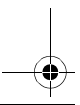
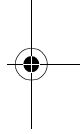
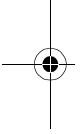



For open array scanners you should also consider the following points:

- **Mounting Platform:** The platform must be mechanically secure and capable of supporting the mass and inertia of the open array scanner. The complete unit weighs: 48" scanner - 30 kg (66.2 lb); 72" scanner - 33.4 kg (73.7 lb).
- The site must be clear of ropes and moving rigging.
- Sufficient clearance must be allowed to fully open the open array pedestal for maintenance.

### Mounting surface: sailboats

The scanner unit can be installed on a mast platform, an arch, or a bridge structure. Make sure that the platform surface is flat and the scanner unit drain hole (radome scanners) is not obstructed. Raymarine recommends that radome scanner units are best suited for sailboat operation as open array systems are more difficult to protect from ropes and sails.

For sailboat installations, Raymarine offers a universal mast mount kit for each radome scanner type. This optional mount is used to fit a radome scanner to a flat surface on a mast with a minimum diameter of 60 mm (2½ in). When using the mast mount kit, appropriate hardware should be used for the style and structure of the mast aboard the vessel. Typically, the scanner will be mounted near the first set of mast spreaders. If there is any doubt concerning the appropriate type of hardware, consult your boat dealer or representative for their recommendations.

Depending on the type of sailboat, a radar scanner guard should be installed if the sails could touch the scanner or platform. Without a proper radar guard the mounting platform and the radar scanner could be severely damaged.

### Mounting surface: power boats

On many small vessels the scanner unit can be installed on a mast platform, an arch, or a bridge structure, but take care to follow the scanner site guidelines, particularly regarding height. If necessary, construct a radar mounting platform to obtain a sufficiently high mounting position. Make sure that the platform surface is flat and the scanner unit drain hole (radome scanners) is not obstructed. Ensure the platform is strong enough to support the maximum shock loads likely to occur.

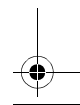
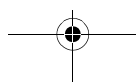
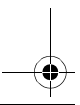
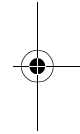
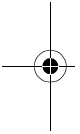



### Setting the radiation plane

The scanner unit should be mounted so that the array rotates parallel to the waterline. The radar beam is approximately 25° wide in the vertical direction, providing good target detection during the vessel's pitching and rolling.

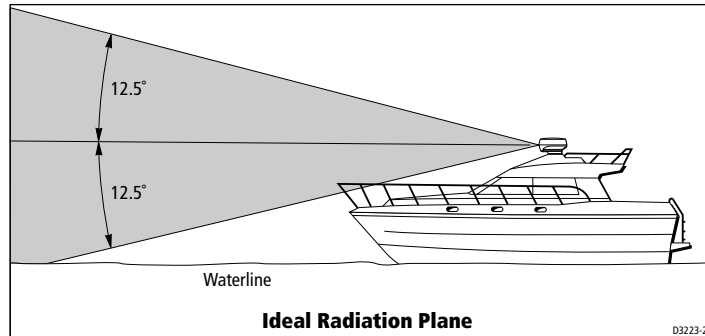

Planing hull vessels, and some displacement hull vessels, adopt a higher bow angle when the vessel is at its cruising speed. In many cases this substantially alters and raises the radar's main radiation plane, and can cause poor detection of nearby targets. It may be helpful to lower the radar beam back towards the parallel, by shimming the rear of the radar, so that the beam points slightly downwards with respect to the waterline when the vessel is at rest.

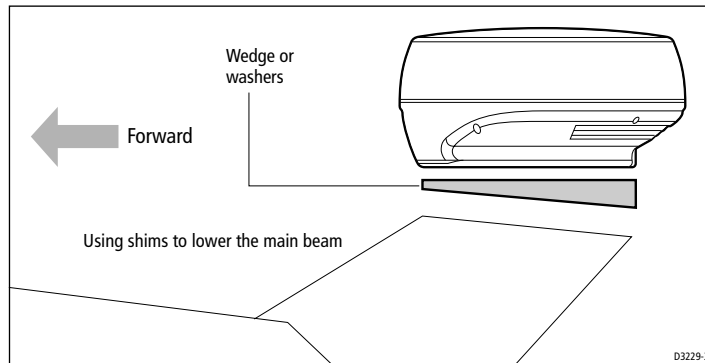

The shims may be made from aluminium plate wedges, simple flat washers, or an angled wooden block. For thick shims, you may need longer securing bolts than the M8x40 bolts supplied with the radome scanner, or the M10 studding supplied with the open array scanners.

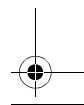
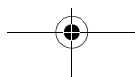
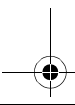
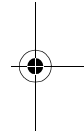
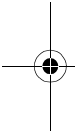



## 1.4 Cable runs

You need to consider the following before installing the system cables:

- You need to fit the inter-unit cable and the power cable.
- All cables should be adequately clamped and protected from physical damage and exposure to heat - avoid running cables through bilges or doorways, or close to moving or hot objects.
- Acute bends must be avoided.
- Where a cable passes through an exposed bulkhead or deckhead, a watertight gland or *swan neck* tube should be used.
- Avoid cutting and re-joining cables (if necessary, refer to the notes below).

You need to run the following cables:

### CAUTION:

**Do not pull the cable through bulkheads using a cord attached to the connector. This could damage the connections.**

- **Inter-unit cable.** A vinyl-covered and shielded cable is supplied with the radome scanner unit. The cable has a connector plug at one end for connecting to the display unit or extension cable; the other end of the radome scanner cable is fitted with an 8-way plug and power cores (covered by a clear protective sleeve) for connecting to the scanner.

For open array scanners, various length cables are available.

These cables have a connector plug at one end for connecting to the display unit or extension cable; the other end is prepared ready to fit to the power and signal connectors (see *Section 2.2*)

- **Power cable.** The scanner receives power via the display unit; the power cable is supplied with the display unit. However, cable details are provided in this section.

### Rejoining Cables

You should avoid cutting and re-joining cables. If this is necessary you must:

- Fit a ferrite on each side of the join. The specific ferrite to use depends on the cable type - contact Raymarine for details.
- Take care not to damage any of the wires. Make sure that all the wires and, in particular, the screen are reconnected correctly.

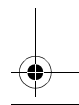
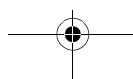
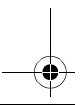
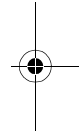
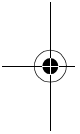



If you are mounting the scanner on the mast of a sailboat, and will need to unstep the mast, you should install a suitable junction box inside the boat.

On a radome scanner, the junction box should provide an 11- or 13-way terminal strip, depending on the number of power cores in your cable, with a 10 A rating. Also, you should keep the length of the un-screened coaxial cores to less than 30 mm to maintain EMC conformance.

On an open array scanner, the junction box should provide a 13-way terminal strip with a 20 A rating for power cores. It is essential that all 4 power cores are connected and that the connection is of very low resistance as considerable power passes through this connection. Also, you should keep the length of the un-screened coaxial cores to less than 30 mm to maintain EMC conformance.

### Inter-unit cable

The inter-unit cable entrance is at the rear of the scanner unit. If the unit is mounted on a hollow mast the cable may be run inside the mast and then fed through the radar's cable entrance. Make sure that the cable does not chafe where it enters and exits the mast.

**Note:** Route the cable from the display up to the scanner, since this will require the smallest clearance hole.

#### CAUTION:

**The display connector on the inter-unit cable is a moulded plug that cannot be replaced. DO NOT remove this moulded plug.**

The inter-unit cable, for connecting the scanner to the display unit, depends on your scanner package as follows:

Table 1-3: Inter Unit Cables required for each Scanner Type

Scanner Package	Inter-Unit Cable
2D (US)	10 m light (2 power cores)
2DE (European)	15 m light (2 power cores)
4D	15 m heavy (4 power cores)
5S, 7S (4 kW) and 9S, 11S (10 kW) Note: All 10 kW systems require a minimum of 24 V.	15 m heavy or radar arch kit (5 m + 10 m extension) 25 m heavy (24/32 V systems only)

The minimum bends permitted are:

Minimum bend, light cable	60 mm (~2.5 in) radius
Minimum bend, heavy cable	82 mm (~3.75 in) radius

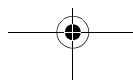
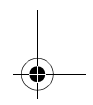
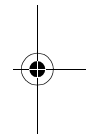

## Radome scanner cables

### Inter-unit cable

The length of the supplied cable should be sufficient to complete the cable run required on most small vessels. For longer runs, additional or replacement cables are available, which have 4 power cores to minimize voltage drops over the longer cable run: these optional cables include 5 m and 10 m extension cables, and a 25 m replacement cable.

The maximum inter-unit cable length is limited by the minimum supply voltage, the scanner type (18" radome or 24" radome), and the cable type (2 or 4 power cores): if a mix of light and heavy cables is used, only 2 power cores are connected through.

**Note:** For vessels with 24 V power systems, any combination of inter-unit cables can be used.

For vessels with 12 V power systems, the recommended cable(s) for different run lengths are given in the following table, which assumes a minimum supply voltage of 10.7 V (the lowest voltage likely to be reached by a 12 V battery in normal marine use). **Do not use cable combinations that are not included in the table.**

Table 1-4: Recommended Radome Inter-Unit Cable(s) for Vessels with 12 V Power Systems

Inter-Unit Cable Length Required (m)	Scanner Package		
	2D (US)	2DE (Eur)	4D
10	Std 10 m light	N/A	N/A
15	Std + 5 m ext	Std 15 m light	Std 15 m heavy
20	Std + 10 m ext	25 m assembly	Std + 5 m ext
25	25 m assembly	25 m assembly	Std + 10 m ext
30	25 m + 5 m ext	25 m + 5 m ext	25 m + 5 m ext
35	25 m + 10 m ext	25 m + 10 m ext	25 m + 10 m ext

Refer to the packing list in *Section 1.2* for cable part numbers

**Note:** This table applies to systems using the standard 1.5 m power cable. If you extend the power cable you may need to select different inter-unit cable(s), as discussed in the following section *Power Cable*.

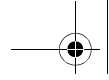

## Power cable

The radome radar systems are intended for use on ships' DC power systems operating in the 10.7 to 32 V DC range (that is, 12 V and 24 V systems, not 32 V systems). A 1.5 m (5 ft) power cable is supplied (with the display unit) for connecting the ship's DC power to the radar scanner via the display unit. Refer to the HSB/*hsb*<sup>2</sup> Series Display Owner's Handbook for details on connecting this cable. This section provides details for extending the length of the power cable.

If a longer power cable run is required, use the supplied power cable to connect to the display unit. Then use a suitable connector block to connect the free end to the extension cable. The supplied power cable has a cross-section of 2.0 mm<sup>2</sup>.

**Note:** For vessels with 24 V power systems, the power cable may be extended by up to 20 m using a wire gauge of 1.5 mm<sup>2</sup> (AWG 16) or greater, irrespective of the inter-unit cable length.

For vessels with 12 V power systems, longer power cable runs may require larger wire gauges to minimize any voltage drop in the cable. The scanner type and the length and type of the inter-unit cable (see tables) also affect the wire gauge required for the extension power cable. In order to determine the correct supply cable size if the power cable must be extended, estimate the length of cable between the ship's main power source and the connector block, and then select the wire size indicated by the distance and inter-unit cable in the appropriate table following.

For example, you might have a 24" scanner, with 20 m between the scanner and display unit, that you plan to connect by extending the supplied 15 m heavy inter-unit cable with a 5 m extension cable. In addition, your 12 V power supply might be 10 m from the display unit, requiring an extension of 8.5 m. To determine the wire gauge required for the power cable extension, refer to the table for the 24" scanner, go to the row labelled *15 m Heavy + 5 m ext*, and read across until you come to a maximum cable length greater than 8.5 m. This is the 10 m entry, in the column for 4.0 mm<sup>2</sup> wire gauge.

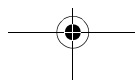
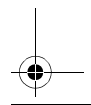
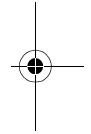

Table 1-5: Max. Extension Power Cable Lengths (m), 12 V Systems - 18" Radome Scanner

Inter-Unit Cable(s)	Power Cable Core (each core)					
	mm <sup>2</sup> : AWG:	1.5 16	2.0 15	2.5 14	4.0 11	6.0 10
10 m Light	5.0	7.0	9.0	14.0	20.0	35.0
10 m Light + 5 m ext	1.0	2.0	3.0	4.5	7.0	12.0
10 m Light + 10 m ext	Do NOT extend the power cable					
15 m Light	1.0	2.0	3.0	4.5	7.0	12.0
15 m Heavy	7.0	10.0	13.0	20.0	30.0	50.0
15 m Heavy + 5 m ext	5.0	7.0	10.0	15.0	25.0	40.0
25 m Heavy	4.5	6.0	8.0	12.0	20.0	35.0
25 m Heavy + 5 m ext	3.5	4.5	6.0	9.0	15.0	25.0
25 m Heavy + 10 m ext	2.0	3.0	4.0	6.0	9.0	15.0

**Note:** If you have an 18" radome scanner, and the wire gauge required for your extended power cable is unacceptably large, you should replace the supplied light (2 power core) inter-unit cable with the 25 m heavy (4 power core) inter-unit cable assembly (see table).

Table 1-6: Max. Extension Power Cable Lengths (m), 12 V Systems - 24" Radome Scanner

Inter-Unit Cable(s)	Power Cable Core (each core)					
	mm <sup>2</sup> : AWG:	1.5 16	2.0 15	2.5 14	4.0 11	6.0 10
15 m Heavy	5.0	7.0	9.0	14.0	20.0	35.0
15 m Heavy + 5 m ext	4.0	5.0	6.0	10.0	15.0	25.0
15 m Heavy + 10 m ext	2.0	3.0	4.0	7.0	10.0	17.0
25 m Heavy	2.0	3.0	4.0	7.0	10.0	17.0
25 m Heavy + 5 m ext	1.0	1.5	2.0	3.0	4.0	8.0
25 m Heavy + 10 m ext	Do NOT extend the power cable					



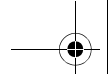

## Open array scanner cables

### Inter-unit cable

Heavy duty cables are available in 15 m and 25 m lengths which should be sufficient to complete the cable run required on most small vessels. For longer runs, 5 m and 10 m extension cables are available, both have 4 power cores to minimize voltage drops over the cable run and incorporate in-line moulded plugs.

The maximum inter-unit cable length is limited by the minimum supply voltage and the scanner type.

#### CAUTION:

**10 kW scanner systems cannot be used directly with 12 V systems; they require a 12 V to 24 V converter rated to 180 W. Contact your authorized Raymarine dealer or distributor for details.**

### 12 V Systems (4 kW scanners only)

For vessels with 12 V power systems, the recommended cable(s) for different run lengths are given in the following table, which assumes a minimum supply voltage of 10.7 V (the lowest voltage likely to be reached by a 12 V battery in normal marine use). **Do not use cable combinations that are not included in the table.**

Table 1-7: Recommended 4 kW Open Array Scanner Inter-Unit Cable(s) for Vessels with 12 V Power Systems

Inter-Unit Cable Length Required (m)	4 kW Scanners
5	5m heavy
15	15 m heavy
15	5 m heavy + 10 m extension

Refer to the packing list in *Section 1.2* for cable part numbers

### 24 V and 32 V Systems - 4 kW scanners

For vessels with 24 V and 32 V power systems, any combination of inter-unit cable up to a maximum length of 35 m can be used.

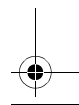
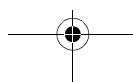
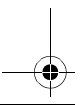
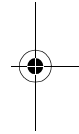
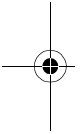



### 24 V and 32 V Systems - 10kW scanners

10 kW open array scanners can use any combination of inter-unit cable up to a maximum length of 35 m. However, these systems use considerable power and installations should be planned to minimize all cable lengths. Refer to the tables on page 1-19, *Max. Extension Power Cable Lengths (m) - 10 kW Scanner*.

### Power cable

The open array scanner systems are intended for use on ships' DC power systems operating in the following ranges:

4 kW 10.7 to 44 V DC range (that is, 12 V, 24 V and 32 V systems)

10 kW 20 to 44 V DC range (that is, 24 V and 32 V systems).

#### **CAUTION:**

**10 kW open array scanner systems cannot be used directly with 12 V systems; they require a 12 V to 24 V converter rated to 180 W. Contact your authorized Raymarine dealer or distributor for details.**

Open array scanners draw considerable power from the vessels power source, especially in high wind speeds. It is essential for reliable operation that the unit is supplied with a low resistance power cable system, especially when operated from a 12 V power system.

#### **CAUTION:**

**Do not use the open array scanner with an SL70 or Autohelm 7" LCD display unit. Failure to observe this may result in permanent damage to the display unit.**

### 12 V systems (4 kW scanners only)

Extensions to the supplied power cable must be kept to a minimum and the power should be fed directly from the output of the battery isolator switch via its own dedicated cable system. It is recommended that no additional power switch is included in this power cable.

#### **CAUTION:**

**The display unit does not include a fuse for scanner power, so an in-line fuse or circuit breaker MUST be included in the power cable.**

All power connections must be of high quality to minimize their resistance and to remove the risk of accidental shorts. Recommended



maximum power cable extensions are given in the table below. These figures relate to the total cable extension, from the end of the supplied 1.5 m power cable to the system battery terminals. Do not exceed these lengths as unreliable operation may result.

Table 1-8: Max. Extension Power Cable Lengths (m), 12 V Systems - 4 kW scanners

	Power Cable Core Size (each core)				
	mm: AWG:	4.0 11	6.0 10	8.0 8	10.0 7
4 kW Scanners	<3.0	4.5	6.0	7.5	

**Note:** *If the required extension results in unacceptably large diameter cables, use two or more smaller gauge wires to achieve the required copper wire cross-section. For example, using two pairs of 2 mm<sup>2</sup> is equivalent to using two single 4.0 mm<sup>2</sup> cables.*

### 24 V and 32 V systems

These systems are less sensitive than 12 V systems to voltage loss in the power cables. However, it is still necessary to use adequate cables to prevent excessive power loss. The table below gives the recommended wire gauge for different power cable extension lengths. Raymarine recommends that power is fed directly from the output of the battery isolator switch via its own dedicated cable system.

**CAUTION:**  
**The display unit does not include a fuse for scanner power, so an in-line fuse or circuit breaker MUST be included in the power cable.**

**Note:** *If the required extension results in unacceptably large diameter cables, use two or more smaller gauge wires to achieve the required copper wire cross-section. For example, using two pairs of 2 mm<sup>2</sup> is equivalent to using two single 4.0 mm<sup>2</sup> cables.*

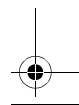
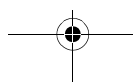
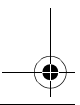
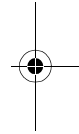
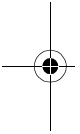

Table 1-9: Max. Extension Power Cable Lengths (m), 24/32 V Systems - 4 kW Scanners

	<b>Power Cable Core Size (each core)</b>					
	mm <sup>2</sup> : AWG:	2.0 14	4.0 11	6.0 10	8.0 8	10.0 7
4 kW Scanners		8.0	16.0	24	32	35

Table 1-10: Max. Extension Power Cable Lengths (m), 24 V Systems - 10 kW Scanners

<b>Inter-Unit Cable(s)</b>	<b>Power Cable Core (each core)</b>				
	mm <sup>2</sup> : AWG:	1.5 16	2.0 15	2.5 14	4.0 11
5 m Heavy		12.0	16.0	20.0	32.0
10 m Heavy		10.5	14.0	18.0	28.0
15 m Heavy		9.0	12.0	16.0	24.0
15 m Heavy + 5 m ext		7.5	10.0	13.0	20.0
15 m Heavy + 10 m ext		6.0	8.0	10.0	16.0
25 m Heavy		6.0	8.0	10.0	16.0
25 m Heavy + 5 m ext		4.5	6.0	8.0	12.0
25 m Heavy + 10 m ext.		3.0	4.0	5.0	8.0

Table 1-11: Max. Extension Power Cable Lengths (m), 32 V Systems - 10 kW Scanners

	<b>Power Cable Core Size (each core)</b>			
	mm <sup>2</sup> : AWG:	1.5 16	2.0 15	2.5 14
10 kW Scanners		≤15.0	≤20.0	≤25.0

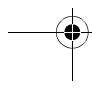
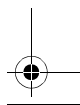
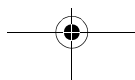
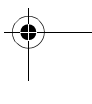
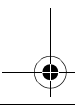
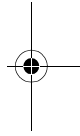
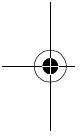
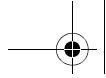

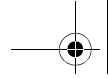

## Chapter 2: Installing the Scanner

### 2.1 Radome scanner

#### Securing the radome scanner to the mounting surface

**CAUTION:**

The drain tube must always be used, but may be shortened if necessary

1. Using the paper template supplied with the scanner mounting kit, mark the flat mounting surface with the mounting holes and drain tube hole, and drill the holes as indicated on the template.  
If it is impractical to drill a hole for the drain tube, then the scanner unit should be mounted on 4 suitable spacers 10 mm high and the drain tube length reduced by 10 mm. It will then be clear of the flat surface and can still perform its function.

**Note:** *If you are using a Raymarine mast mount bracket, the surface is pre-prepared.*

**Note:** *If you are mounting the scanner on a flat surface, you may find it easier to fit the drain tube, as described in the following section, before securing the scanner.*

2. Position the scanner on the mounting surface, ensuring that the cable inlet is pointing aft.
3. Locate the bolts and washers supplied with the scanner, grease the bolts, and secure the scanner to the mounting surface as shown in the following diagram. Tighten the bolts to 20 Nm (14.7 lb ft); ensure the scanner is tightly fitted.

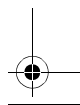
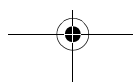
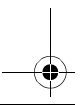
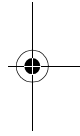
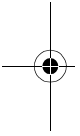

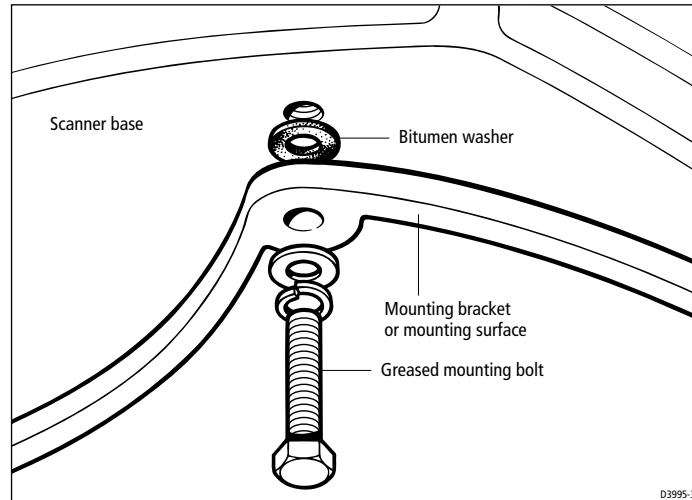

You may need to use longer M8 mounting bolts to secure the scanner if you have used shims to lower the radar beam.

## Connecting the radome scanner inter-unit cable

### **CAUTION:**

**Before wiring the scanner unit, make sure that the inter-unit cable is not connected and power is not applied to the display unit.**

When you have run the inter-unit cable to the scanner location, connect the cable as follows:

1. Loosen the 4 (18") or 7 (24") screws securing the scanner cover. These screws are captive and should remain assembled to the lower flange assembly. Press the radome inwards to release the top. This breaks the seal and makes removal easier.
2. To avoid losing the scanner cover, tie the cord, attached to the inside of the base of the scanner, to the eye provided in the cover.
3. If you have a 24" scanner, unscrew and remove the inner cover:

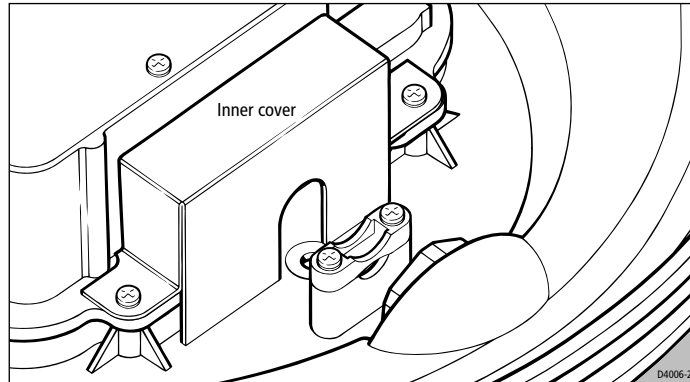

4. Remove the drain tube from inside the base of the scanner, and insert it into the drain hole as shown in the following diagram. Pull the tube gently from outside the scanner so that it clips into place.

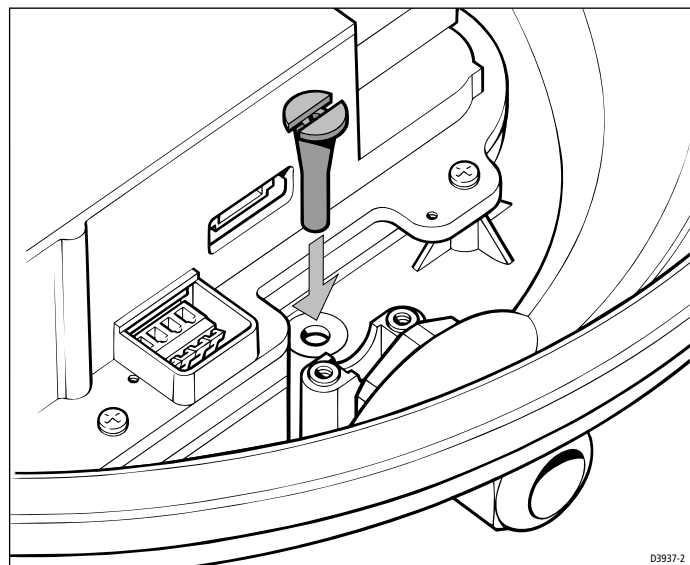



5. Referring to the following illustration, remove the securing nut (1) from the watertight gland and grommet (2), where the inter-unit cable (3) will enter the base.

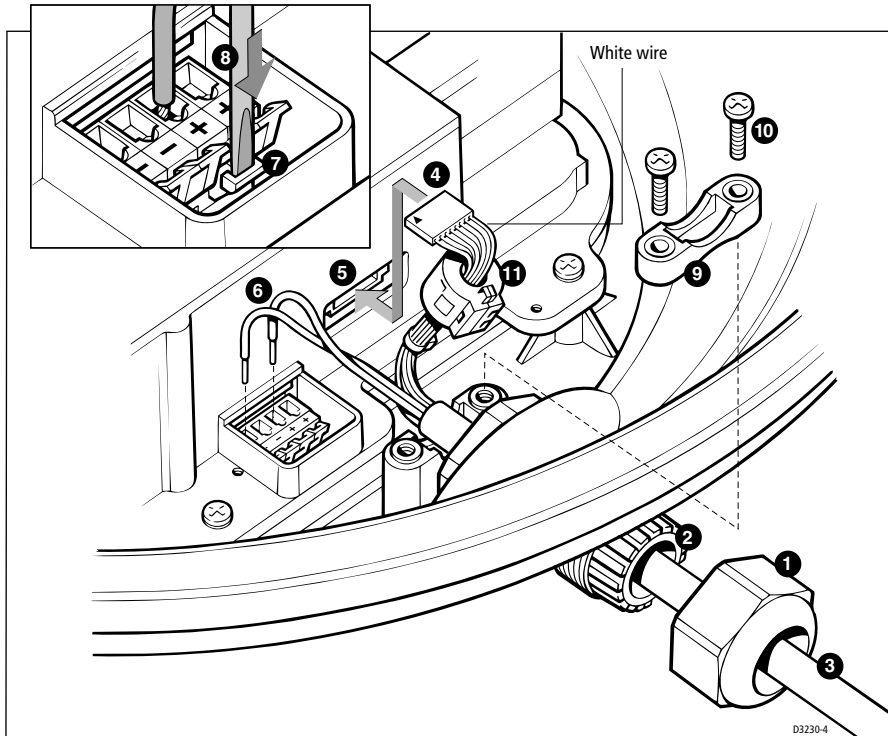

1 Securing nut 2 Gland 3 Inter-unit cable 4 Eight-way plug 5 Eight-way socket 6 Power cores (2 or 4)  
7 Terminal clamp 8 Screwdriver 9 Cable clamp 10 Cable clamp screws 11 Ferrite clamp

6. Slide the gland nut onto the inter-unit cable (3), and insert the cable, still covered by its protective sleeve, through the gland into the base.
7. Cut and remove the protective sleeve to expose the 8-way plug (4) and power cores (6).
8. If the scanner is connected to an HSB/*hst*<sup>2</sup> Series Pathfinder Radar display, fit the ferrite clamp (11) supplied, as follows:

**CAUTION:**

**If any wires are damaged when the clamp is fitted, the scanner unit will not function correctly.**

- The ferrite clamp is supplied open. If the clamp has been closed, insert a small, flat-blade screwdriver into the slots at the end of the clamp opposite the hinge and twist gently.
- Position one-half of the clamp around the eight cores of the inter-unit cable between the 8-way plug (4) and the cable clamp, as close to the 8-way plug as possible. (It may be necessary to fit the clamp over the cable tie closest to the 8-way plug – this will not affect the ferrite clamp's function).

**Note:** *on the 24" scanner, the clamp must be contained inside the inner cover.*

- With the clamp positioned correctly, close the clamp ensuring none of the cores are trapped by the hinge, latch or the ferrite itself.
9. Connect the 8-way plug (4) to the connector (5). The correct fitting is with the small arrow marked on the body of the plug facing upwards and to the left hand side. The grey wire will then be at the left hand side and the white wire will be at the right hand side.
10. Connect the red and black power cores (6).

If you have a 10 m or light 15 m inter-unit cable, there is one pair of cores. Connect the red cable lead to one of the terminal sockets marked "+", and the black cable lead to one of the sockets marked "-".

If you have a heavy 15 m inter-unit cable, there are two pairs of cores. Connect the red cable leads to the terminal sockets marked "+", and the black cable leads to the terminal sockets marked "-", with one lead in each socket.

The terminal clamps (7) are operated using a screwdriver (8), as shown in the inset diagram on the previous page.

**CAUTION:**

**Do not earth the cable screen to the scanner. The radar system is earthed via the display unit.**

11. Secure the nut (1) on the watertight gland, making sure that it grips the cable's outer sheath.
12. Secure the cable with the cable clamp (9), using the two screws (10) provided. The clamp can be installed either way up, depend-

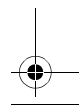
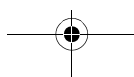
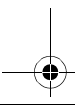
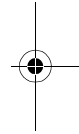
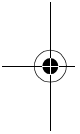

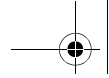

ing on the thickness of the cable: use the position that matches the profile of the cable.

**CAUTION:**

**It is essential that the drain tube is fitted and that the nut on the watertight gland is adequately tightened. If this is not done, water could become trapped in the scanner and cause irreparable damage.**

13. Tighten the securing nut (1) again to ensure a waterproof seal.
14. If you have a 4D scanner, replace the inner cover over the connectors.
- 15. Untie the cord from the scanner cover, and coil it up in the base of the scanner unit so that it cannot foul the rotating antenna.**
16. Replace the scanner cover, aligning the mark on the cover with the mark on the scanner base above the cable gland, and tighten the 4 or 7 captive screws. **Do not over-tighten these screws.**

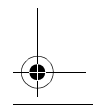
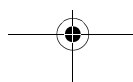
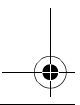
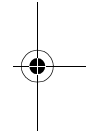
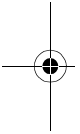



## 2.2 Open array scanner

Installation of the open array scanner should only be undertaken by a competent installer. If you have any difficulty with the installation, please contact your local Raymarine dealer or distributor.

The open array scanner is supplied in two sections; the pedestal unit and the antenna. The pedestal unit is secured from below the mounting platform. The open array is then secured to the pedestal. Full details for mounting the scanner are given below.

### **CAUTION:**

The pedestal unit has a cap fitted over the open array mounting shaft to protect the protruding co-axial pin. This cap must be left in place until the open array is fitted.

The pedestal base is fitted with a gasket: **DO NOT** grease this gasket.

### **WARNING:**

The open array scanner weighs: 48" scanner - 30 kg (66.2 lb); 72" scanner - 33.4 kg (73.7 lb). For safety reasons it is recommended that the unit is not lifted by one person.

The unit is fitted with lifting eyes (maximum SWL 40 kg) to facilitate the use of standard lifting accessories, e.g. rope, chain or strop. The safe working load (SWL) of the lifting accessories should be 150 kg. Suitable lifting equipment could include a crane, hoist, or an appropriate rigid, overhead structure.

Alternatively, the unit is suitable for a two person lift. Care should be taken to ensure that each person is standing on a stable surface, and that the pedestal is held carefully to ensure it cannot slip.

The T-bar beneath the open array antenna can be used to aid lifting.

You should never lift the scanner by holding onto the open array antenna.

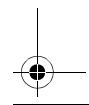
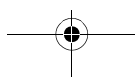
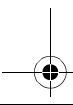
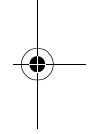
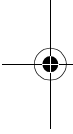



## Securing the pedestal to the mounting platform

1. Using the paper template supplied with the scanner mounting kit, mark the flat mounting surface with the holes and drill as indicated on the template. Refer to *Section 1.2* when selecting the scanner unit site.
2. Stick the four self-adhesive bitumen washers over the mounting holes.
3. Ensure the lifting eyes are securely fitted to the top of the pedestal, and the yellow protective cap is in place.

### CAUTION:

To prevent damage to the internal mounting bar, ensure the stud penetration is no more than 32 mm into the pedestal base. We recommend you mark each stud with tape, 32 mm from one end, to act as a gauge.

4. Grease the studs. Using two nuts locked together on the stud, screw each stud into the pedestal to a **maximum of 32 mm**, or until they bottom out. Remove these two nuts.

**Note:** *If the studding supplied is not long enough, use M10 stainless steel, grade A4 studding of a suitable length. Refer to the following illustration for details.*

5. Using suitable lifting equipment, raise the pedestal over the mounting surface. Carefully lower into position, taking care that the studs pass through the holes without damaging the threads. Ensure that the cable inlet is pointing aft.

### WARNING:

**Support the pedestal unit until it has been secured to the mounting platform. It is important that all four sets of nuts and washers are used to secure the pedestal to the mounting platform.**

6. Referring to the following illustration, use the four nuts and associated washers supplied to secure the pedestal. Tighten the nuts to 20 Nm (14.7 lb ft); ensure the scanner is tightly fitted. Grease the nuts. If required, cut-off any excess stud.

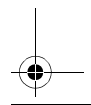
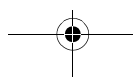
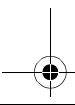
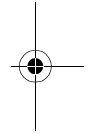
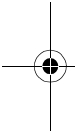

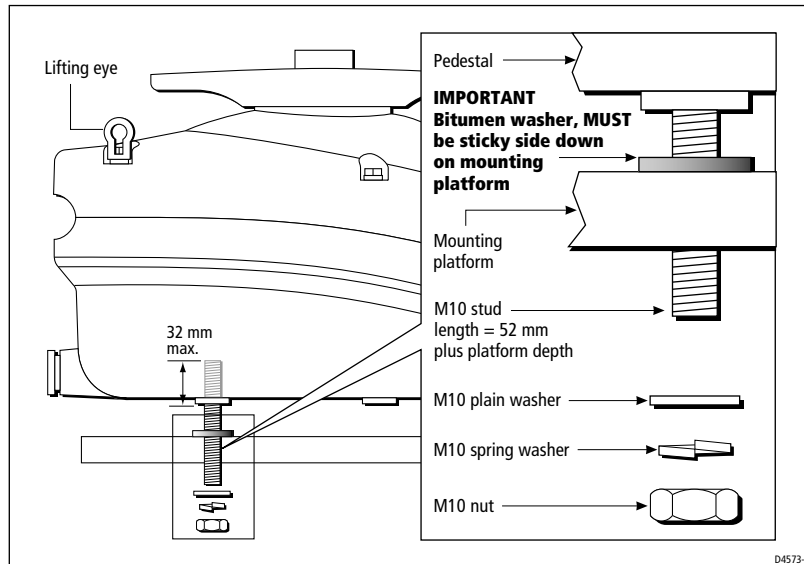

### Connecting the open array scanner inter-unit cable

#### CAUTION:

Before wiring the scanner unit check that it is securely mounted to the platform, then make sure that the inter-unit cable is not connected and power is not applied to the display unit. The scanner switch must be in the OFF position.

1. Loosen the four self-retaining bolts securing the pedestal lid to the base. Pull-up and turn the bolts anti-clockwise to lock them in the upright position. Remove the lifting eyes.

**Note:** It is important to remove lifting eyes to avoid corrosion. Retain the lifting eyes: they will be required if the scanner is removed from its platform.

2. Open the pedestal lid. Ensure the securing stay has automatically locked into position.
3. Referring to the following illustration, remove the cable gland nut, washer and grommet from the watertight gland, where the inter-unit cable will enter the base.

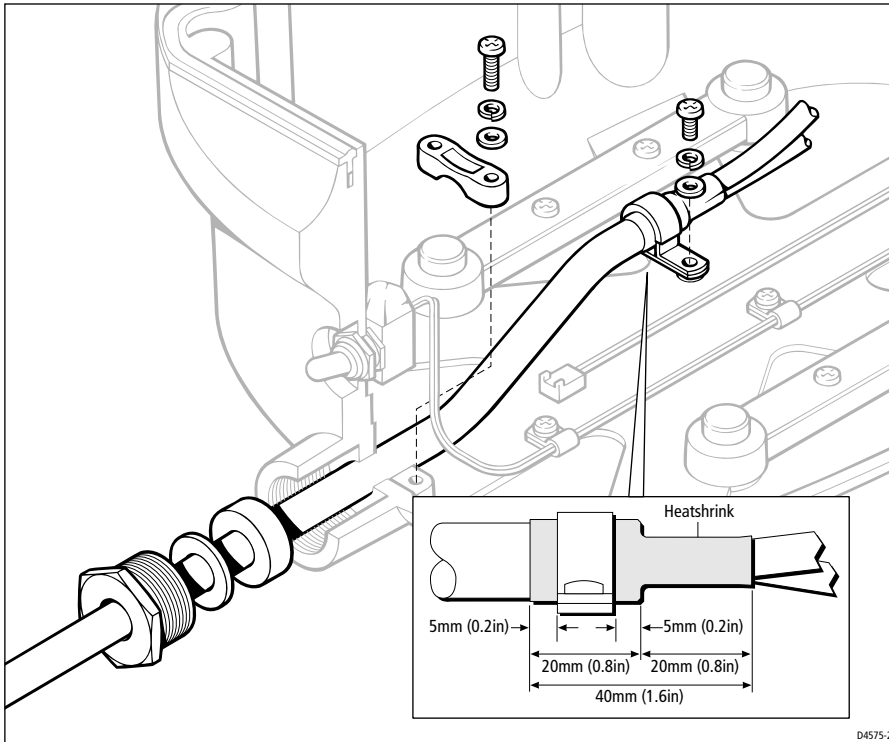

D4575-2

4. Slide the cable through the gland nut, washer and grommet, then into the base. Clamp into position, ensuring the section of main cable covered in yellow heat shrink is clamped.
5. The cable is supplied prepared and ready to fit to the signal and power connectors. If you need to cut the cable to length, strip off the protective outer sleeve then use the supplied kit to prepare the cable as detailed in the following illustration

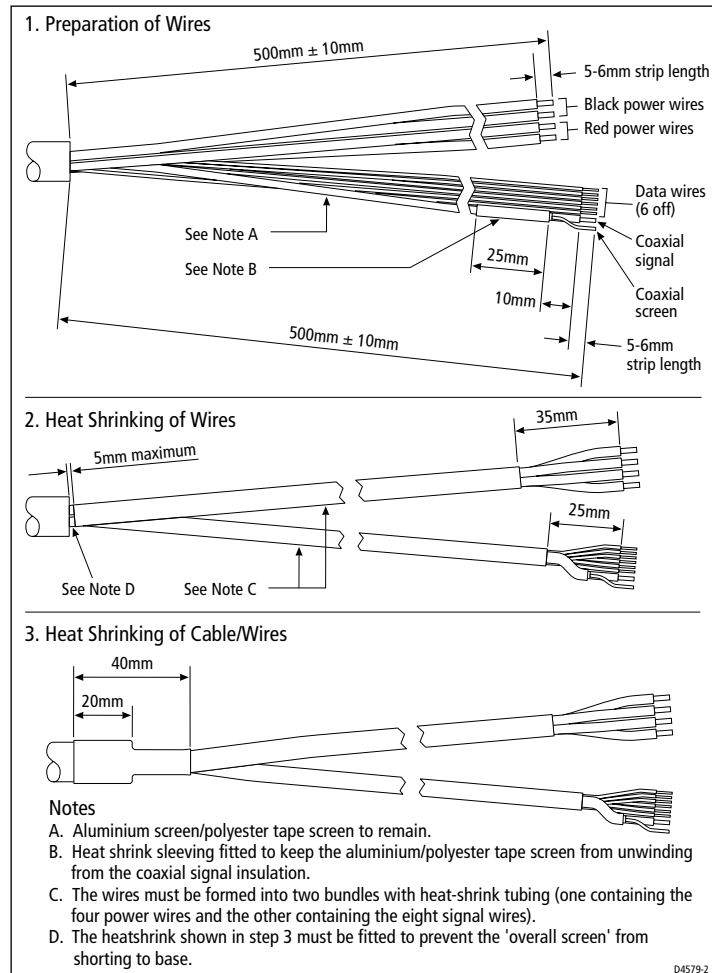
**CAUTION:**

**If any of the wires are incorrectly fitted, the scanner will not function correctly.**

Remove the 8-way plug from the signal connector and fit to the cable as shown in the following diagram. The terminal clamps are operated using a screwdriver as shown. Alternatively, you can leave the connector in position whilst connecting the cable, you should then remove the connector and visually check each wire connection.



Re-connect to the plug. When correctly fitted the white wire (coaxial) will be at the outer edge of the unit.

6. Connect the red and black power cores. Connect the red cable leads to the terminal sockets marked "+", and the black cable leads to the terminal socket marked "-", with one lead in each socket. The terminal clamps are operated using a screwdriver as shown in the inset diagram.

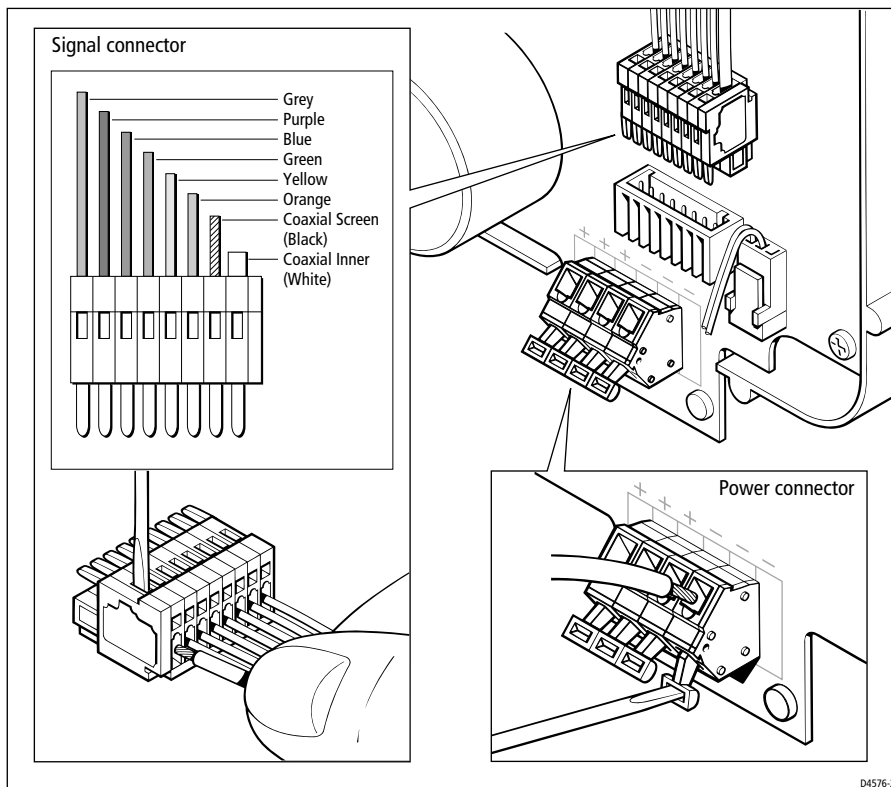

**CAUTION:**  
Do not earth the cable screen to the scanner. The radar system is earthed via the display unit.

7. Using the tie-wrap fitting on the pedestal lid, secure the cable.
8. Check the gasket in the pedestal lid is correctly seated. Close the pedestal lid, ensuring that the cable does not become trapped and that the gasket is not pushed-out at the front of the pedestal: it will help if you support the front of the lid (by holding

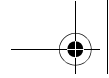

the mounting bracket) as you lower the rear of the lid.  
Tighten the four self-retaining bolts.

**CAUTION:**  
Do not grease the gasket in the pedestal lid.

### Fitting the open array to the pedestal

**CAUTION:**  
The pedestal unit has a cap fitted over the open array mounting shaft to protect the protruding co-axial pin. This cap must be left in place until the open array is fitted to the pedestal.

1. Remove the cap from the open array shaft. Retain the cap, it will be required if the open array is removed from the pedestal.
2. Grease the four securing studs.

**CAUTION:**  
If the pin is damaged during the following operation you should contact your service dealer.

3. Lift the open array into position. Carefully lower the array - to prevent damage to the mounting pin, ensure the array remains parallel to the pedestal so that the studs slot into the holes on the pedestal mounting bracket.

**Note:** *The open array mounting bracket is designed so that the array can only be fitted to the pedestal in the correct orientation.*

4. Use the four nuts and associated washers supplied to secure the array to the pedestal as shown in the diagram below.

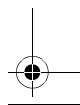
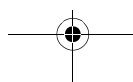
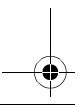
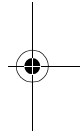
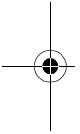

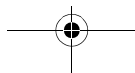
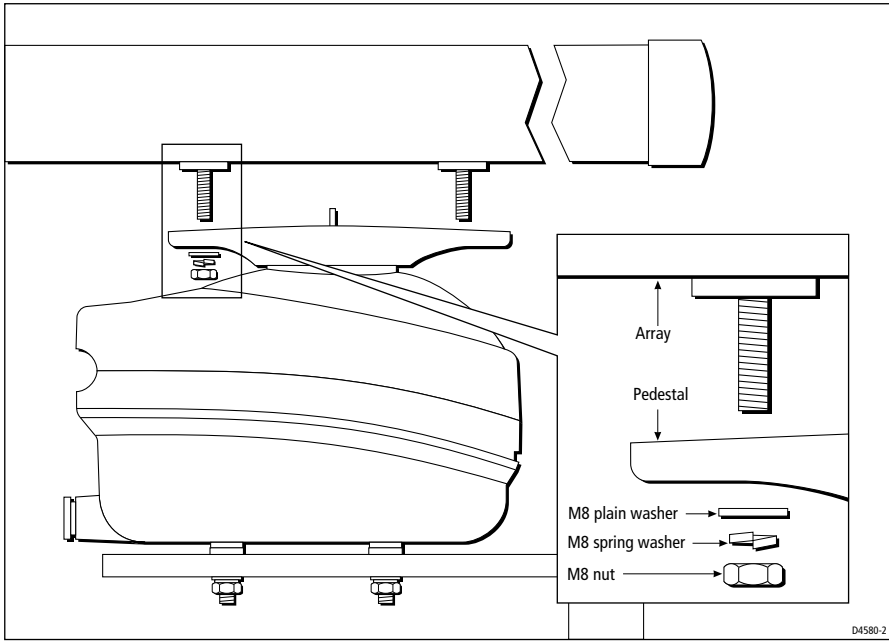

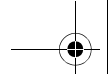

## 2.3 System connections

### DC power connection

Power is supplied to the scanner via the display unit; the power cable is supplied with the display unit, refer to your display unit *Owner's Handbook* for details on connecting power. However, you should be aware of the following.

The DC system should be either:

- Negative grounded, with the negative battery terminal connected to the ship's ground.
- Floating, with neither battery terminal connected to the ship's ground.

#### **CAUTION:**

**This radar is not intended for use on "positive" ground vessels. The power cable Earth screen connections must be connected to the ship's ground.**

#### **Grounding the radar system**

It is important that an effective RF ground is connected to the radar system. You must ground the radar by connecting the drain wire (screen) of the Power/NMEA Input cable to the nearest ground point of the ship's RF ground system. Refer to your display unit *Owner's Handbook* for details.

**Note:** Use only this ground connection.

#### **Power Connections**

The power connection to the radar should be made at either the output of the battery isolator switch, or at a DC power distribution panel. Raymarine recommends that power is fed directly to the radar via its own dedicated cable system and **MUST** be protected by a thermal circuit breaker or fuse, fitted close to the power connection. Refer to the table below for isolator switch, circuit breaker or fuse value ratings. Check all terminal connections are clean.

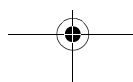
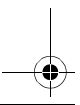
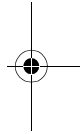
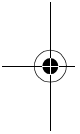

**CAUTION:**

If you do not have a thermal circuit breaker or fuse in your power circuit, e.g. fitted to the DC distribution panel, you **MUST** fit an in-line breaker or fuse to the positive (red) lead of the power cable.

Table 2-1: Isolator Switch/Thermal Breaker/Fuse Values

Vessels Supply	Device	Open Array Systems		Radome Systems
		4 kW	10 kW	
12 V*	Isolator Switch min. rating	30 A	n/a	20A
	Thermal Breaker rating	15 A	n/a	10A
	Fuse value	20 A	n/a	15 A
24/32 V**	Isolator Switch min. rating	15 A	15 A	15 A
	Thermal Breaker rating	8 A	10 A	5 A
	Fuse value	10 A	15 A	8 A

\* 10 kW scanners cannot be directly connected to 12 V

\*\* Radome systems cannot use 32V.

The open array scanner has a power switch fitted to the pedestal. This switch can normally be left ON. However, if the scanner is being serviced or if any personnel are in the vicinity of the open array, the switch should be set to OFF.

**Scanner connection**

The inter-unit cable is connected to the scanner as described in *Sections 2.1 and 2.2*. If you are using an inter-unit extension cable, connect this to the display unit, and connect the supplied cable to the extension cable. The scanner connector pins are shown in the following diagram, together with the connections and core colors.

**CAUTION:**

The display connector on the inter-unit cable is a moulded plug that cannot be replaced. **DO NOT** remove this moulded plug.

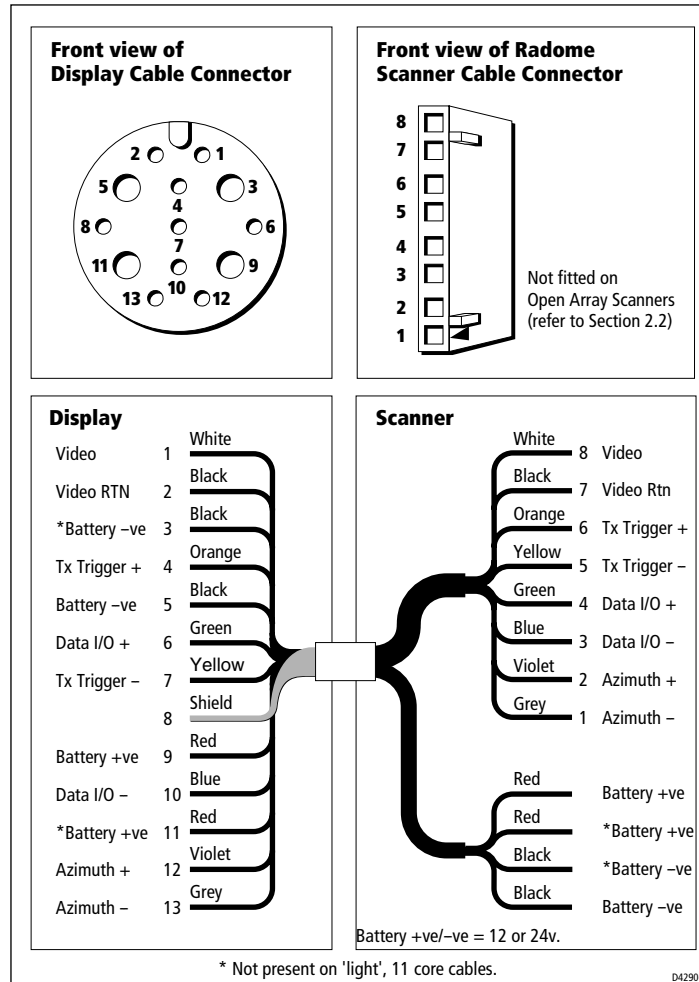

## Display unit connection

### CAUTION:

Do not use an open array scanner with an SL70 or SL70 PLUS 7" LCD display unit. Failure to observe this may result in permanent damage to the display unit.

10 kW open array scanners cannot be directly connected to 12 V systems.

The rear of the Pathfinder display includes the following connection sockets:

- **Scanner** connection
- **Power/NMEA Input** DC power connection, two NMEA 0183 inputs and one RF ground (screen) connection.

**Note:** *If you have an integrated system that includes a radar display with MARPA as a primary function, the scanner must be connected to this display to enable the function. MARPA is then available on any repeater display.*

Connect the scanner cable to the scanner connector and power to the power/NMEA input connector.

Power and all other connector details are supplied in the display unit *Owner's Handbook*.

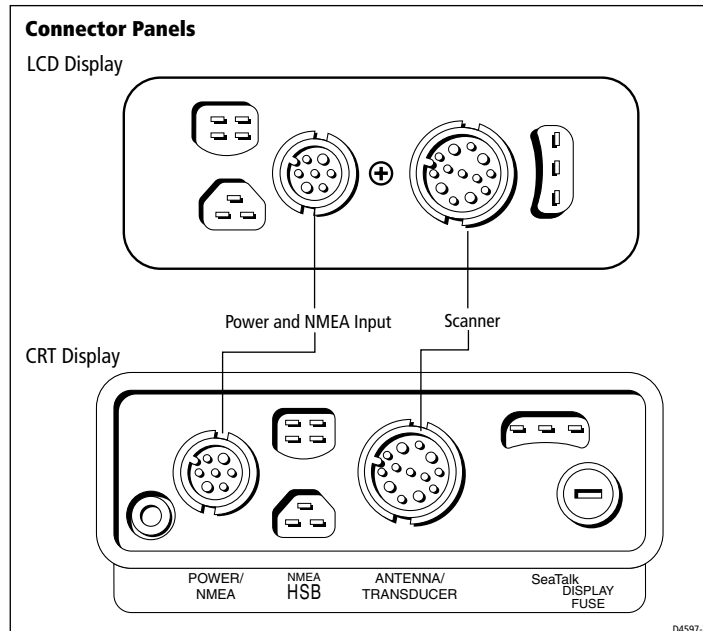



## Chapter 3: Post Installation Checks and Maintenance

Once you have installed your radar scanner and display unit, and made all the connections, you need to check your installation. You can then set up the radar system, align the scanner and check the display timing. In addition, for a 72" open array scanner you need to set the antenna size to ensure the scanner rests in the correct position when rotation stops.

Set up, alignment and timing checks are performed from the radar system display unit. The procedures are outlined below; full details are provided in the display unit *Owner's Handbook*. You should read the Pathfinder radar display unit *Owner's Handbook* and familiarize yourself with the operation of the radar.

### EMC Conformance

Always check the installation before going to sea to make sure that it is not affected by radio transmissions, engine starting etc.

### 3.1 System Checks and Alignment

#### System check

Before performing the functional test, check the following:

- All securing bolts are fully tightened and mechanical locking arrangements as specified are in place
- All connections have been made
- All connecting wires are secured and protected as necessary

**Note:** *If you are the boat owner and have performed the installation yourself, ask your authorized installation dealer to check the installation before going to sea.*

#### Set up, alignment and timing checks

##### Switch on and initial set up

On the open array scanner, ensure the power switch on the pedestal is set to ON.

To switch on the display unit, press and hold the **POWER** key until the unit beeps. The magnetron warm-up sequence should start, after

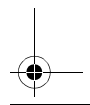
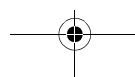
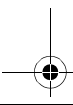
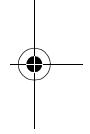
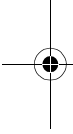



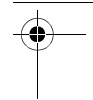
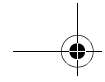

which the unit should enter Standby mode.  
If necessary, adjust the lighting and contrast.  
If required, change the default language settings.

## Checking transmission

### WARNING:

**The radar scanner transmits electromagnetic energy. Ensure that the scanner has been installed according to the recommendations given in *Chapter 1*, and that all personnel are clear of the scanner, before switching to transmit mode.**

Run through the radar operations described in the display unit *Owner's Handbook* and check that all the expected data is displayed.

## Bearing alignment

When the system is correctly installed, you must check the bearing alignment to ensure that targets appear at their correct bearing relative to the ship's bow, and adjust the alignment if necessary.

## Display timing adjustment

The display timing can be affected by the length of the cable used to connect the scanner to the display unit. This in turn affects the short range accuracy shown on the display.

It is advisable to check the display timing before using the system for navigation.

## 72" open array position alignment

To ensure the 72" open array scanner rests in correct position when rotation stops, you need to adjust the radar set up as follows:

1. With the display switched on in Radar mode, press **MENU** then press the RADAR SET UP soft key.
2. Use the cursor to select the ANTENNA SIZE option, then press the 6 ft soft key.  
press **ENTER** twice to return to the default display.

If the Radar Set Up menu option ANTENNA SIZE is not available, then you have an older version of display software. The 72" open array scanner will operate correctly with this display. However, for details on adjusting the open array stopping-position, please contact your authorized Raymarine dealer or distributor.

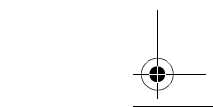
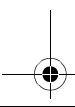
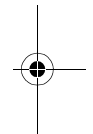
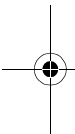

## 3.2 Maintenance

### Warnings



The display unit and scanner unit contain *high voltage*. Adjustments require specialized service procedures and tools only available to qualified service technicians - there are no user serviceable parts or adjustments and the operator should not attempt to service the equipment. *The operator should not remove the rear cover of the display or any internal covers in the scanner.*

Always turn the radar system off before carrying out any routine maintenance on the scanner or nearby equipment. Switch off the display unit before removing the power cord.

### Routine Checks

The radar scanners are sealed units. Maintenance procedures are therefore limited to the following periodical checks:

- Examine the cables for signs of damage, such as chafing, cuts or nicks.
- Check that the cable connectors are firmly attached.
- Make sure the scanner and pedestal are still attached securely to the mounting.
- Once a year, remove, grease and re-attach the mounting bolts securing the scanner and pedestal.

### Servicing and Safety

- Raymarine equipment should be serviced only by authorized Raymarine service technicians. They will ensure that service procedures and replacement parts used will not affect performance. There are no user serviceable parts in any Raymarine product.
- Some products generate high voltages, so never handle the cables/connectors when power is being supplied to the equipment.
- When powered, all electrical equipment produces electromagnetic fields. These can cause adjacent pieces of electrical equipment to interact with one another, with a consequent adverse effect on operation. In order to minimize these effects and enable you to get the best possible performance from your Raymarine equipment, guidelines are given in the installation instructions, to

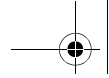

enable you to ensure minimum interaction between different items of equipment, i.e. ensure optimum Electromagnetic Compatibility (EMC).

- Always report any EMC-related problem to your nearest Raymarine dealer. We use such information to improve our quality standards.
- In some installations, it may not be possible to prevent the equipment from being affected by external influences. In general this will not damage the equipment but it can lead to spurious resetting action, or momentarily may result in faulty operation.

### 3.3 Problem Solving

All Raymarine products are subjected to comprehensive test and quality assurance programmes prior to packing and shipping. However, if this unit should develop a fault, please refer to the following table to identify the most likely cause and the corrective action required to restore normal operation.

If you still have a problem after referring to the table below, contact your local dealer, national distributor or Raymarine Product Support Department for further advice.

Always quote the product serial numbers. The display unit serial number is printed on the back of the unit, and the scanner serial number is on the back of the scanner near the gland.

Table 3-1: Common Problems and Their Solutions

Problem	Correction
"Scanner not responding" message.	Check that the cable connecting the scanner to the radar display unit is firmly attached and undamaged. Check that the polarity of the cables is correct.
The bearing displayed on the radar display is not the same as the actual bearing	Perform the bearing alignment procedure described in the display unit Owner's Handbook Section 8.7.
The 72" antenna stops in the wrong position.	Refer to 72" open array position alignment.

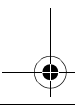
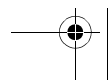
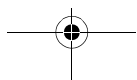
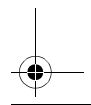
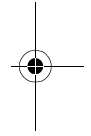



## How to Contact Raymarine (US)

### For Marine Product and Services Information

Visit the Raymarine World Wide Web site for the latest information on the newest Raymarine electronic equipment and systems at:

[www.raymarine.com](http://www.raymarine.com)

### For Accessories and Parts

Many Raymarine accessory items and parts can be obtained directly from your authorized Raymarine dealer. However, if you are in need of an item not available from the retailer, please contact Raymarine Technical Services at:

1-800-539-5539 extension 2333 or  
(603) 881-5200 extension 2333.

Technical Services are available Monday through Friday 8:15 AM to 5:00 PM Eastern Standard Time.

Please have the Raymarine item or part number ready when calling if placing an order. If you are not sure which item is appropriate for your unit, you should first contact the Technical Support Department at:

1-800-539-5539 ext. 2444 or  
(603) 881-5200 extension 2444

to verify your requirements.

### For Technical Support:

For technical support, call:

1-800-539-5539 extension 2444 or  
(603) 881-5200 extension 2444.

Our Technical Support Specialists are available to answer questions about installing, operating and trouble-shooting all Raymarine products. Questions may be addressed directly to our Technical Support Department via e-mail at:

[techsupport@raymarine.com](mailto:techsupport@raymarine.com).

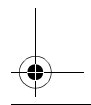
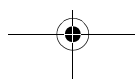
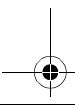
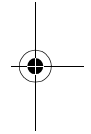
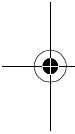

### **For Product Repair and Service**

In the unlikely event your Raymarine unit should develop a problem, please contact your authorized Raymarine dealer for assistance. The dealer is best equipped to handle your service requirements and can offer time saving help in getting the equipment back into normal operation.

In the event that repairs can not be obtained conveniently, product service may also be obtained by returning the unit to:

Raymarine Product Repair Center  
22 Cotton Road, Unit D  
Nashua, NH03063-4219

The Product Repair Center is open Monday through Friday 8:15 a.m. to 5:00 p.m. Eastern Standard Time or Eastern Daylight Savings Time. All products returned to the Repair Center are registered upon receipt. A confirmation letter will be sent to you acknowledging the repair status and the product's reference number. Should you wish to inquire about the repair status of your unit, contact the Product Repair Center at:

1-800-539-5539 extension 2118.

Please have the product reference number, or unit serial number, ready when you call. We will do everything possible to make the repair and return your unit as quickly as possible

### **How to Contact Raymarine (Europe)**

In Europe, Raymarine support, service and accessories may be obtained from your authorized dealer, or contact:

Raymarine Ltd  
Anchorage Park, Portsmouth  
PO3 5TD, England  
Tel: +44 (0) 23 9269 3611  
Fax: +44 (0) 23 9269 4642

Or visit the Raymarine World Wide Web site:

*[www.raymarine.com](http://www.raymarine.com)*



## Technical Support

The Technical Services Department handles enquiries concerning installation, operation, fault diagnosis and repair. For technical help desk contact:

Tel: +44 (0) 23 9271 4713

Fax: +44 (0) 23 9266 1228

Our technical support staff may also be reached via e-mail at:

*techsupport@Raymarine.com.*

## Accessories and Parts

Raymarine accessory items and parts are available through your authorized Raymarine dealer. Please refer to the lists of component part numbers and optional accessories in the Installation chapter of this manual, and have the Raymarine part number ready when speaking with your dealer.

If you are uncertain about what item to choose for your Raymarine unit, please contact our Customer Services Department prior to placing your order.

## Worldwide Support

Please contact the authorized distributor in the country. A list of worldwide distributors is supplied with your system.

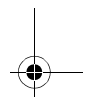
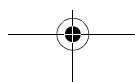
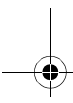
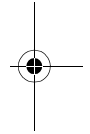
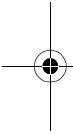

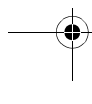
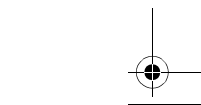
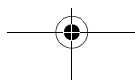
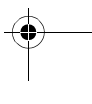
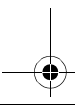
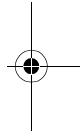
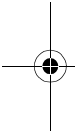
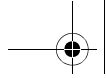

# Appendix A: Specification

## 2D 18" Radome Scanner Unit

<b>General</b>		
Approvals	1999/5/EC, EN60945	
CE - conforms to	Part 80 (47CFR) and Part 2 (47CFR)	
FCC - conforms to		
Dimensions	Φ468 x 227 mm (18.4 x 8.9 in)	
Weight	6.5 kg (14.3 lbs)	
Input Voltage	8.7 - 32 V DC (from display unit)	
Power Consumption	28 W (9 W Standby)	
Environmental	Waterproof to CFR46 Temperature range: -10° to +55°C Humidity limit: up to 95% at 35°C Maximum wind speed for satisfactory operation: 100 Kts	
Maximum Range Scale	24 nm	
<b>Transmitter</b>		
Transmitter Frequency	9410 +/- 30 MHz	
Peak Power Output	2.0 kW (nominal)	
Transmitter	Solid-state modulator driving Magnetron	
Pulse Length/PRF		
Range (nm)	Pulse Length (μS)	PRF (Hz)
0.25 or less	0.065	3000
0.50	0.090	3000
0.75	0.150	3000
0.75 expanded	0.250	2500
1.50	0.350	1800
3.00	0.450	1400
3.00 expanded	0.600	1000
6.00 or greater	1.000	740
Standby Mode	Magnetron heater and control left on, all other services off	
Duplexer	Circulator	





---

<b>Antenna</b>	
Antenna Type	Patch array
Beam Width (nominal)	5.2° horizontal, 25° vertical
Polarization	Horizontal
Antenna Side lobes	Less than -22 dB
Rotation Rate	24 rpm (nominal)

---

<b>Receiver</b>	
IF Frequency	60 MHz (nominal)
Receiver Characteristic	Semi-log
Receiver Noise Figure	Less than 5 dB (including Low Noise Converter/Limiter & IF Receiver)
Receiver Bandwidth	12/3/1 MHz

---

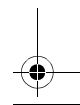
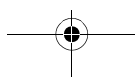
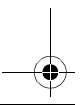
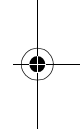
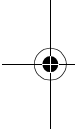

## 4D 24" Radome Scanner Unit

<b>General</b>		
Approvals CE - conforms to FCC - conforms to	1995/5/EC, EN60945 Part 80 (47CFR) and Part 2 (47CFR)	
Dimensions	Φ599 x 227 mm (23.6 x 8.9 in)	
Weight	7.5 kg (16.5 lbs)	
Input Voltage	8.7 - 32 V DC (from display unit)	
Power Consumption	34 W (10 W Standby)	
Environmental	Waterproof to CFR46 Temperature range: -10° to +55°C Humidity limit: up to 95% at 35°C Maximum wind speed for satisfactory operation: 100 Kts	
Maximum Range Scale	48 nm	
<b>Transmitter</b>		
Transmitter Frequency	9410 +/- 30 MHz	
Peak Power Output	4.0 kW (nominal)	
Transmitter	Solid-state modulator driving Magnetron	
Pulse Length/PRF		
Range (nm)	Pulse Length (μs)	PRF (Hz)
0.25 or less	0.065	3000
0.50	0.090	3000
0.75	0.150	3000
0.75 expanded	0.250	3000
1.50	0.350	2000
3.00	0.450	1500
3.00 expanded	0.600	1300
6.00 or greater	1.000	740
Standby Mode	Magnetron heater and control left on, all other services off	
Duplexer	Circulator	

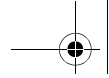

---

<b>Antenna</b>	
Antenna Type	Patch array
Beam Width (nominal)	3.9° horizontal, 25° vertical
Polarization	Horizontal
Antenna Side lobes	Less than -22dB
Rotation Rate	24 rpm (nominal)

---

---

<b>Receiver</b>	
IF Frequency	60 MHz (nominal)
Receiver Characteristic	Semi-log
Receiver Noise Figure	Less than 5 dB (including Low Noise Converter/Limiter & IF Receiver)
Receiver Bandwidth	12/3/1 MHz

---

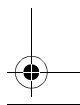
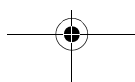
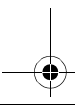
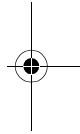
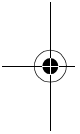

## 5S and 9S 48" Open Array Scanner Unit

### General

Approvals	
CE - conforms to	1995/5/EC, EN60945
FCC - conforms to	Part 80 (47CFR) and Part 2 (47CFR)
Dimensions	
Pedestal:	427 x 296 x 406 mm (16.8 x 10.5 x 16 in)
Array:	1306 mm (51.4 in) length
Weight	
Pedestal:	24 kg (53.0 lb)
Array:	6 kg (13.2 lb)
Environmental	
Waterproof to CFR46	
Temperature range: -10° to +55°C	
Humidity limit: up to 95% at 35°C	
Maximum wind speed for satisfactory operation: 100 Kts	
Maximum Range Scale	72 nm

### 5S Transmitter - 4 kW

Input Voltage	10.7 - 44 V DC (from display unit)					
Power Consumption	9.2 W Standby 46 W Typical operation in light winds 61 W Max. operation in 50 Kt winds 96 W Max. operation in 100 Kt winds					
Transmitter Frequency	9410 +/- 30 MHz					
Peak Power Output	4 kW (nominal)					
Transmitter	Solid state modulator driving magnetron					
Pulse Length/PRF						
		Normal		Expanded		
Range (nm)	Pulse Length (μS)	PRF (Hz)	Bandwidth (MHz)	Pulse Length (μS)	PRF (Hz)	Bandwidth (MHz)
0.125	0.065	3000	12	0.09	3000	12
0.25	0.065	3000	12	0.09	3000	12
0.50	0.09	3000	12	0.15	3000	12
0.75	0.15	3000	12	0.25	3000	12
1.50	0.35	2000	3	0.45	1600	3
3.00	0.45	1600	3	0.60	1200	0.7
6.0 - 72	1.00	740	0.5	-	-	-
Standby Mode	Magnetron heater and control left on, all other services off					
Duplexer	Circulator					

**95 Transmitter - 10 kW**

Input Voltage	16 - 44 V DC (from display unit)					
Power Consumption	11 W Standby 80 W Typical operation in light winds 95 W Max. operation in 50 Kt winds 140 W Max. operation in 100 Kt winds					
Transmitter Frequency	9410 +/- 30 MHz					
Peak Power Output	10 kW (nominal)					
Transmitter	Solid state modulator driving magnetron					
Pulse Length/PRF	Normal			Expanded		
Range (nm)	Pulse Length (μS)	PRF (Hz)	Bandwidth (MHz)	Pulse Length (μS)	PRF (Hz)	Bandwidth (MHz)
0.125	0.065	3000	12	0.09	3000	12
0.25	0.065	3000	12	0.09	3000	12
0.50	0.09	3000	12	0.15	3000	12
0.75	0.15	3000	12	0.25	3000	12
1.50	0.35	2000	3	0.45	1600	3
3.00	0.45	1600	3	0.60	1200	0.7
6.0 - 72	1.20	740	0.5	-	-	-
Standby Mode	Magnetron heater and control left on, all other services off					
Duplexer	Circulator with integral limiter					

**48" Antenna**

Antenna Type	Slotted waveguide array
Beam Width (nominal)	1.85°
Polarization	Horizontal
Antenna Side lobes	Less than -22 dB
Rotation Rate	24 rpm (nominal)

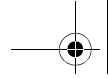

---

**Receiver**

---

IF Frequency 60 MHz (nominal)

---

Receiver Characteristic Semi-log

---

Receiver Noise Figure Less than 5 dB  
(including Low Noise Converter/Limiter & IF Receiver)

---

Receiver Bandwidth 12/3/0.7/0.5 MHz

---

**Note:** *If the scanner is bought for use with an existing display, contact your dealer/service agent for the latest display software to ensure you can use all the open array scanner features.*

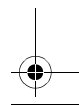
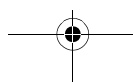
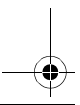
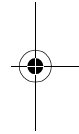
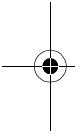

## 7S and 11S 72" Open Array Scanner Unit

### General

Approvals CE - conforms to FCC - conforms to	1995/5/EC, EN60945 Part 80 (47CFR) and Part 2 (47CFR)
Dimensions	Pedestal: 427 x 296 x 406 mm (16.8 x 10.5 x 16 in) Array: 1918 mm (75.5 in) length
Weight	Pedestal: 24 kg (53.0 lb) Array: 9.4 kg (20.7 lb)
Environmental	Waterproof to CFR46 Temperature range: -10° to +55°C Humidity limit: up to 95% at 35°C Maximum wind speed for satisfactory operation: 100 Kts
Maximum Range Scale	72 nm

### 7S Transmitter - 4 kW

Input Voltage	10.7 - 44 V DC (from display unit)					
Power Consumption	9.2 W Standby 46 W Typical operation in light winds 83W Max. operation in 50 Kt winds 135W Max. operation in 100 Kt winds (min. input voltage 11.4 V for winds >75kt)					
Transmitter Frequency	9410 +/- 30 MHz					
Peak Power Output	4 kW (nominal)					
Transmitter	Solid state modulator driving magnetron					
Pulse Length/PRF	Normal			Expanded		
Range (nm)	Pulse Length (μS)	PRF (Hz)	Bandwidth (MHz)	Pulse Length (μS)	PRF (Hz)	Bandwidth (MHz)
0.125	0.065	3000	12	0.09	3000	12
0.25	0.065	3000	12	0.09	3000	12
0.50	0.09	3000	12	0.15	3000	12
0.75	0.15	3000	12	0.25	3000	12
1.50	0.35	2000	3	0.45	1600	3
3.00	0.45	1600	3	0.60	1200	0.7
6.0 - 72	1.00	740	0.5	-	-	-
Standby Mode	Magnetron heater and control left on, all other services off					
Duplexer	Circulator					

**11S Transmitter - 10 kW**

Input Voltage	20 - 44 V DC (from display unit)					
Power Consumption	11 W Standby 80 W Typical operation in light winds 117 W Max. operation in 50 Kt winds 179 W Max. operation in 100 Kt winds					
Transmitter Frequency	9410 +/- 30 MHz					
Peak Power Output	10 kW (nominal)					
Transmitter	Solid state modulator driving magnetron					
Pulse Length/PRF	Normal			Expanded		
Range (nm)	Pulse Length (μS)	PRF (Hz)	Bandwidth (MHz)	Pulse Length (μS)	PRF (Hz)	Bandwidth (MHz)
0.125	0.065	3000	12	0.09	3000	12
0.25	0.065	3000	12	0.09	3000	12
0.50	0.09	3000	12	0.15	3000	12
0.75	0.15	3000	12	0.25	3000	12
1.50	0.35	2000	3	0.45	1600	3
3.00	0.45	1600	3	0.60	1200	0.7
6.0 - 72	1.20	740	0.5	-	-	-
Standby Mode	Magnetron heater and control left on, all other services off					
Duplexer	Circulator with integral limiter					

**72" Antenna**

Antenna Type	Slotted waveguide array
Beam Width (nominal)	1.15°
Polarization	Horizontal
Antenna Side lobes	Less than -25 dB
Rotation Rate	24 rpm (nominal)



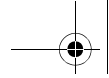

<b>Receiver</b>	
IF Frequency	60 MHz (nominal)
Receiver Characteristic	Semi-log
Receiver Noise Figure	Less than 5 dB (including Low Noise Converter/Limiter & IF Receiver)
Receiver Bandwidth	12/3/0.7/0.5 MHz

**Note:** *If the scanner is bought for use with an existing display, contact your dealer/service agent for the latest display software to ensure you can use all the open array scanner features.*

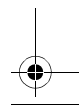
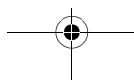
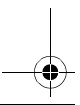
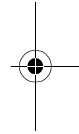
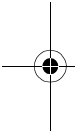

# Index

## A

### Alignment

- Bearing 40
- Position of 72" Open Array Scanner 40

## B

### Bearing Alignment 40

## C

### Cable Runs 11

### Cables

- Extension 4
  - Open Array 16, 18, 19
  - Radome 13, 15, 17
- Inter-unit 4, 11, 12
  - Open Array 16, 30
  - Radome 13, 22
- Part Numbers 4
- Power 11
  - Open Array 17
  - Radome 14
- Rejoining 11

### Connections

- Display Unit 38
- Open Array Scanner 29
- Power 35, 38
- Radome Scanner 22
- Scanner 36
- System 35

## D

### Display Timing Adjustment 40

### Display Unit

- Connections 38

## E

### Electromagnetic Energy i, 40

### EMC iv

- Conformance iv
- Installation Guidelines 2

## F

### Ferrite 24

## G

### Grounding the System 35

## H

### Help from Raytheon

- Europe 44
- US 43
- Worldwide 45

### High Voltage i

## L

### Location 5

## M

### Maintenance and Problem Solving 39

### Mounting

- Open Array Scanner 28
- Radome Scanner 21
- Scanner
  - on Power Boats 9
  - on Sailboats 9

## N

### Navigation Aid ii

## O

### Open Array Scanner

- 48" iii, 1, 51
- 72" iii, 1, 54
- 72" - Position Alignment 40
- Connections 29
- Mounting 28
- Pedestal 33

## P

### Parts List 4

### Power

- Cables 11
  - Open Array 17
  - Radome 14
- Connections 35, 38

### Problem Solving 42

## R

### Radar System

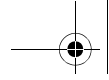

Grounding 35  
Typical System Diagram 1

Radome Scanner  
18" iii, 1, 47  
24" iii, 1, 49  
Connections 22  
Mounting 21  
Rejoining Cables 11  
Routine Checks 41

**S**

Safety  
- and Servicing 41  
Electromagnetic Energy i  
High Voltage i  
Navigation Aid ii

Scanner i

Connections 36  
Location 5  
Mounting  
on Power Boats 9  
on Sailboats 9

Scanner. See also Open Array Scanner,

Radome Scanner i  
Servicing and Safety 41

Set Up 39

Specification

18" Radome Scanner 47  
24" Radome Scanner 49  
48" Open Array Scanner 51  
72" Open Array Scanner 54

System Check 39

**T**

Timing Adjustment 40  
Transmission Check 40

**W**

Warranty iv

