

Ray240 VHF **Radio** with Digital Selective Calling

Users Manual

Document # 81219_1
Date: June 2004

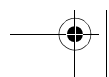

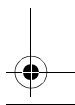
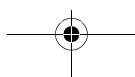
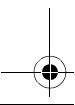
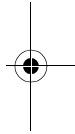
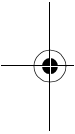
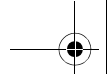

Trademarks and registered trademarks

Autohelm, HSB Raymarine, RayTech, RayTech RNS, Sail Pilot, SeaTalk and Sportpilot are registered trademarks of Raymarine Limited. Apelco is a registered trademark of Raymarine Holdings Limited (Registered in all major marketing territories).

AST, Autoadapt, Auto GST, Autoseastate, Autotrim, Bidata, Marine Intelligence, Maxiview, On Board, Raychart, Raynav, Raypilot, Raystar, ST40, ST60, Seaclutter, Smart Route, Tridata and Waypoint Navigation are trademarks of Raymarine Limited.

All other product names mentioned are trademarks or registered trademarks (if applicable) of their respective companies.

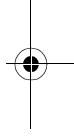
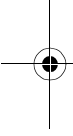

www.raymarine.com

© Copyright - Raymarine 2004

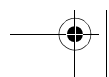
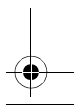
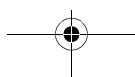
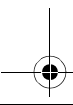

How to make a DSC Distress call

Step 1

Slide up cover

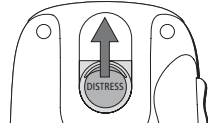

Step 2



PRESS and HOLD for 5 SECONDS

Step 3



Step 4



WAIT WHILE RADIO AUTOMATICALLY RE-TUNES

Step 5

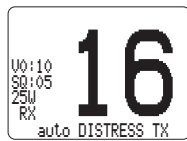

Step 6

Press and Hold PTT



THEN SPEAK



SLOWLY and CLEARLY

MAYDAY, MAYDAY, MAYDAY

This is.... (repeat name of vessel 3 times)

MAYDAY

THIS IS.... (name of vessel spoken once)

MY POSITION IS.... (latitude and longitude) or true bearing and distance from a known point). **IF YOU DON'T KNOW, DON'T GUESS.**

I AM.... (sinking, on fire, etc)

I HAVE.... (number of persons on board and any other information - drifting, flares fired, etc)

I REQUIRE IMMEDIATE ASSISTANCE

OVER

RELEASE THE PTT SWITCH

How to make a Mayday call

Step 1

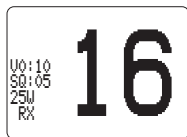

MAYDAY, MAYDAY, MAYDAY

This is.... (name of vessel, spoken 3 times)

Step 2

Press and Hold PTT



THEN



SLOWLY and CLEARLY

MAYDAY

This is....(name of vessel spoken once)

MY POSITION IS....(latitude and longitude, or true bearing and distance from a known point - IF YOU DON'T KNOW, DON'T GUESS).

I AM....(sinking, on fire, etc)

I HAVE.... (number of persons on board and any other information - drifting, flares fired, etc)

I REQUIRE IMMEDIATE ASSISTANCE

OVER

RELEASE THE PTT SWITCH

Step 3

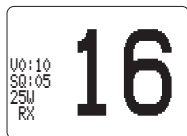

FOR ACKNOWLEDGEMENT AND INSTRUCTIONS

IF AN ACKNOWLEDGEMENT IS NOT RECEIVED THEN REPEAT THE DISTRESS CALL

D6790_1

Contents

How to make a DSC Distress call	i
How to make a Mayday call	ii
Contents	iii
Important Information	5
Chapter 1: General Information	13
1.1 What is the Ray240?	13
1.2 What is DSC?	13
Calls to other ships	14
Group calls	14
Safety broadcasts	14
Distress alerts	14
1.3 Can I use the Ray240 as part of an integrated system?	14
1.4 How do I use the Ray240?	15
Which menu do I need?	17
What does the display tell me?	18
Chapter 2: Operations	19
2.1 Introduction	19
2.2 Using the handset - the controls	19
....power the radio On and Off?	19
....adjust the handset volume?	19
....set the squelch?	20
....change channels?	20
....tune to the priority channel?	20
....monitor channels?	21
....get the weather forecast?	21
....select Private channels?	21
....scan the channels?	22
....use the Memory?	22
....change the transmitting power?	22
....navigate the menus?	23
....use the Menu shortcuts	24
....adjust the active speaker volume?	24
2.3 Using the handset - making and receiving calls	25
....use the intercom?	25
....receive a routine call?	25
....call another ship?	26
....make a specified Distress call?	27
....cancel a Distress call?	28

....make an All Ships Call (Urgency)?	29
....make a position request?	30
2.4 Using the DSC phone book	31
....make a DSC phone call?	31
....view phone book details?	32
.... add an entry to the DSC phone book?	33
2.5 Receiving distress alerts	34
Distress calls	34
Distress acknowledgement	34
Distress acknowledgement to a call from your radio	34
Distress acknowledgement for another vessel?	34
Distress relay	35
2.6 Receiving weather alerts	35
2.7 Additional functions	35
Intercom/fog/hailer	35
Intercom	35
Fog warnings	35
....set up the automatic fog signal?	37
Chapter 3: Installation	39
3.1 EMC Installation Guidelines	39
3.2 What's in the box?	40
Can I get optional extras?	41
3.3 Where should I install my radio?	42
3.4 Typical installation	44
3.5 How much space does the Ray240 need?	45
3.6 How do I make the electrical connections?	47
3.7 How do I get position data?	48
3.8 Setting up the Ray240	49
.... enter my boat's MMSI number?	49
....enter my ATIS number?	50
Chapter 4: Maintenance and Troubleshooting	51
4.1 Introduction	51
4.2 What maintenance can I do?	51
4.3 How do I troubleshoot the Ray240?	51
4.4 How do I get the radio serviced?	52
4.5 How do I contact Raymarine?	53
Appendix A: VHF Channels	55
Appendix B: Technical specification	63
Appendix C: Hints and Tips	65
Appendix D: List Of Abbreviations	67
Limited Warranty Certificate - VHF Products	69

Important Information

Purpose

This handbook contains important information on the installation, operation and maintenance of the US and European versions of the Ray240 VHF radio, which is intended for light marine use and covers the following models:

- E42001 Ray240 System - US and Canadian version.
- E42002 Ray240E System - European version.

To get the best results in operation and performance, please take the time to read this handbook thoroughly.

Safety notices

**WARNING: Electrical safety**

Make sure the power supply is switched off before you make any electrical connections.

**WARNING: Electromagnetic exposure**

Failure to observe the Antenna and EME Exposure guidelines may expose those within the Maximum Permissible Exposure radius to RF radiation absorption that exceeds the FCC MPE limit. It is the Radio Operator's responsibility to ensure that no one is within this radius before transmitting.

**WARNING: Navigation aid**

Although we have designed this product to be accurate and reliable, many factors can affect its performance. As a result, it should only be used as an aid to navigation and never replace common sense and navigational judgement. Always maintain a permanent watch so you can respond to situations as they develop.

CAUTION: Compass safe distance

The compass safe distance, measured in accordance with EN 60945, for the Ray 240 is 0.9 m.



FCC Notice

This device complies with Part 15 of the FCC Rules. Operation is subject to the following conditions:

1. This device may not cause harmful interference.
2. This device must accept any interference received, including interference that may cause undesired operation.

Changes or modifications to this equipment, not expressly approved in writing by Raymarine Inc, could violate compliance with FCC rules and void the operator's authority to operate the equipment.

EMC conformance

All Raymarine equipment and accessories are designed to the best industry standards for use in the recreational marine environment. Their design and manufacture conforms to the appropriate Electromagnetic Compatibility (EMC) standards, but correct installation is required to ensure that performance is not compromised.

Antenna mounting and EME exposure

Ensure that the antenna is connected to the radio before transmitting.

Raymarine declares a Maximum Permissible Exposure (MPE) radius of 1.5 meters (per OET Bulletin 65) for this system, assuming 25 watts output to an omnidirectional antenna of 3dBi gain or less.

For watercraft with suitable structures, the antenna base must be at least 3.5 meters above the main deck to meet the MPE for persons up to 2 meters tall. For watercraft without such structures, the antenna must be mounted so that its base is a minimum of 1.5 meters vertically from the heads of all persons.

Do not transmit when anyone is within the MPE radius of the antenna, unless they are shielded from the antenna field by a grounded metallic barrier.

Licensing requirements

United States

An Operator License is not required to operate a VHF Marine Radio within US territorial waters. However, a license is required to operate the radio if you dock in



a foreign port (including Canada and Mexico) or leave a foreign port to dock in a US port. You can request a Restricted Radiotelephone Operator Permit from the Federal Communications Commission (FCC) by filing Form 753.

Canada

A license is not required to operate this radio within the sovereign waters of Canada. You will require a license to operate this radio outside of these waters. To obtain Industry Canada licensing information, contact the nearest field or regional office or write to:

Industry Canada
Radio Regulatory Branch
300 Slater Street
Ottawa
Ontario
Canada, K1A 0C8
Attention: DOSP

Europe

Regulations in some areas require that an Operator's license is obtained before operating a VHF radio. It is your responsibility to determine whether a license is required in your area before operating this equipment.

Additional Information

The following additional information will be required for completing a license application in Canada or the US:

Industry Canada Certification Number	4069BRAY240
FCC ID	PJ5RAY240
FCC Type Accepted	Parts 15 and 80
Output Power	1 watt (low), 25 Watts (high)
Modulation	Frequency
Frequency Range	156.000 - 165.000 MHz

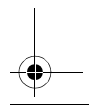
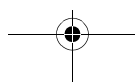
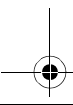
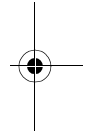
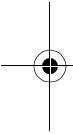



Maritime Mobile Service Identity

A nine-digit Maritime Mobile Service Identity (MMSI) number is required to operate the Digital Selective Calling (DSC) equipment in this radio.

United States

You can request an MMSI number from the FCC when you apply for a Station License. If your vessel does not require a license, you may obtain an MMSI by contacting either:

BoatUS (www.boatus.com), or

MariTEL (www.maritelusa.com).

Once obtained, you can program the MMSI number into your Ray240 using the Menu Operation described in this handbook.

Canada

You can obtain an MMSI number from your nearest Industry Canada Office.

Once obtained you can program the MMSI number into your Ray240 using the Menu Operation described in this handbook.

Europe

An MMSI number should be requested from the same agency that issues radio operator licenses in your area.

Once obtained, you can program the MMSI number into your Ray240 using the Menu Operation described in this handbook.

If regulations in your area do not permit you to program the MMSI number yourself, your Raymarine dealer can program the number for you.

For full details of programming your MMSI number into the Ray240 - see *Chapter 3:Installation*.

Automatic Transmission Identification System

Some European inland waterways require the use of the Automatic Transmission Identification System (ATIS). An ATIS number can be requested from the same agency that issues radio operator licenses in your area.

Once obtained, you can program the ATIS number into your Ray240 using the Menu Operation described in this handbook.

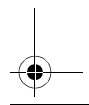
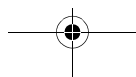
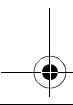
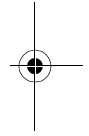
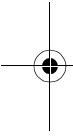



If the regulations in your area do not permit you to program the ATIS number yourself, your Raymarine dealer can program the number for you.

For full details of programming your ATIS number into the Ray240 - see *Chapter 3: Installation*.

Handbook information

To the best of our knowledge, the information in this handbook was correct as it went to press. However, our policy of continuous product improvement and updating may change specifications without prior notice. As a result, unavoidable differences between the product and handbook may occur from time to time.

Raymarine cannot accept liability for any inaccuracies or omissions it may contain.

For the latest product information visit our website:

www.raymarine.com

Warranty

To register your new Raymarine product, please take a few minutes to fill out the warranty card. It is important that you complete the owner information and return the card to us to receive full warranty benefits.

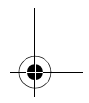
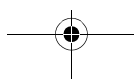
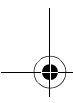
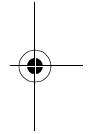
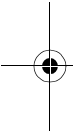

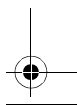
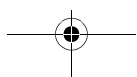
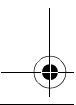
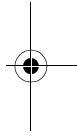
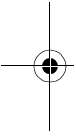
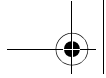

Certificate No.		Raymarine®
RT043		
<h2>EC Declaration of Conformity</h2>		
<i>We</i>	Raymarine Limited	Anchorage Park Portsmouth Hampshire England PO3 5TD
<i>declare, under our sole responsibility, that the products identified in this declaration, and to which this declaration relates, are in conformity with the essential requirements of European Parliament and Council Directive:</i>		
<i>1999/5/EC on radio equipment and telecommunication terminal equipment and the mutual recognition of their conformity.</i>		
Product Name:		Raymarine RAY 240E VHF Radio System including Class "D" DSC
Product Number(s):		E42002 (without DTMF facility)
Product Options:		E45002 (Second Station Kit) E45010 (Second Handset) E45003 (Second Active Speaker)
<i>The products have been satisfactorily assessed to Conformity Procedure Annex IV of the Directive and by application of all or part of the following standard(s):</i>		
Non-Harmonised Standards(s):		EN 60945, EN 301 025-1, EN 300 698-1
Harmonised Standard(s):		EN 301 025-2, EN 301 025-3, EN 300 698-2, EN 300 698-3, EN 301 843-1, EN 301 843-2, EN 60950
<i>The assessment is consistent with a Technical Construction File showing conformity with the essential requirements of the Directive and has been reviewed by Notified Body No. 0191</i>		
<i>The product is labelled with the CE conformity marking, the identification number of the Notified Body and class identifier.</i>		
Signatory:	Name	Adil Abbas
	Title	International Compliance Manager
	Company Name	Raymarine Limited
	Company Address	Anchorage Park Portsmouth, Hampshire England PO3 5TD
	Signature	_____
	Date	March 2004

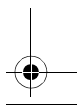
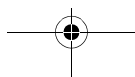
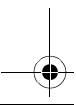
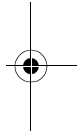
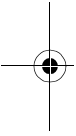
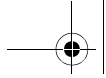



Chapter 1: General Information

1.1 What is the Ray240?

The Ray240 is a combined VHF radio and Class D Digital Selective Calling (DSC) system, using a phone style handset to access and control all functions. It enables you to make digitally selected calls, which are quicker and simpler to make than traditional voice calls using Channel 16. It can transmit and receive on all available US, Canadian and International Marine VHF channels.

Should a distress situation occur, using the Ray240 you can quickly raise an alert, automatically indicating your identity and position, and establishing distress communication on the emergency voice channel.

1.2 What is DSC?

The present VHF radio system requires users to listen until someone speaks, and then determine whether the call is for them - more often than not, it isn't. DSC makes sure that you receive messages, and alerts you to the fact that it is for you.

DSC is part of the Global Maritime Distress and Safety System (GMDSS), a maritime communication system - not just for emergency and distress messages, but also for all types of existing ship-to-ship and ship-to-shore routine communications.

DSC is simply a tone signalling system, which operates on VHF Channel 70 and is similar to the tone dialling on your phone, but with the ability to include other information such as your boat's identification number, the purpose of the call, your position and the channel you want to speak on.

DSC calls can be divided into four categories:

- Calls to other ships.
- Group calls.
- Safety broadcasts.
- Distress alerts.



Calls to other ships

To call another ship or a coast station, you simply enter their dedicated Maritime Mobile Service Identity (MMSI) number, select your chosen VHF working channel and send the call - it's like using a telephone. Both your radio and the one you are calling automatically switch to the chosen channel for conversation.

Group calls

When groups of ships need the same information (yacht races, club rallies etc.) a special group-call identity can be used to enable restricted broadcast messages.

Safety broadcasts

Safety broadcasts from coast stations and other shipping automatically generate an alert (ring tone) to ensure that this vital information is not missed.

Distress alerts

At the touch of a button, you can send your ships identity, your position and the nature of your distress. The position given will be precise and the alert will be heard immediately by all DSC equipped vessels and coast stations within range. The message is automatically repeated at approximately 4 minute intervals until it is acknowledged either by a coast station or a vessel within radio range.

Note: *To transmit precise positions, the radio must be interfaced to your Global Positioning System (GPS). Otherwise, regular manual position updating is required.*

1.3 Can I use the Ray240 as part of an integrated system?

Your Ray240 can receive position information, e.g. latitude and longitude, using either of the following protocols:

- National Maritime Electronics Association (NMEA) 0183.
- SeaTalk

enabling DSC integration with other instruments.

You can also add an additional handset and active speaker to the standard Ray240, giving two fully functional stations with an intercom function. This is particularly useful where your boat has dual helms or a second navigation station.

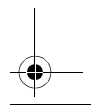
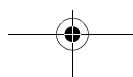
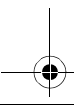
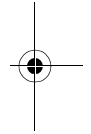
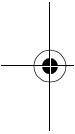

1.4 How do I use the Ray240?

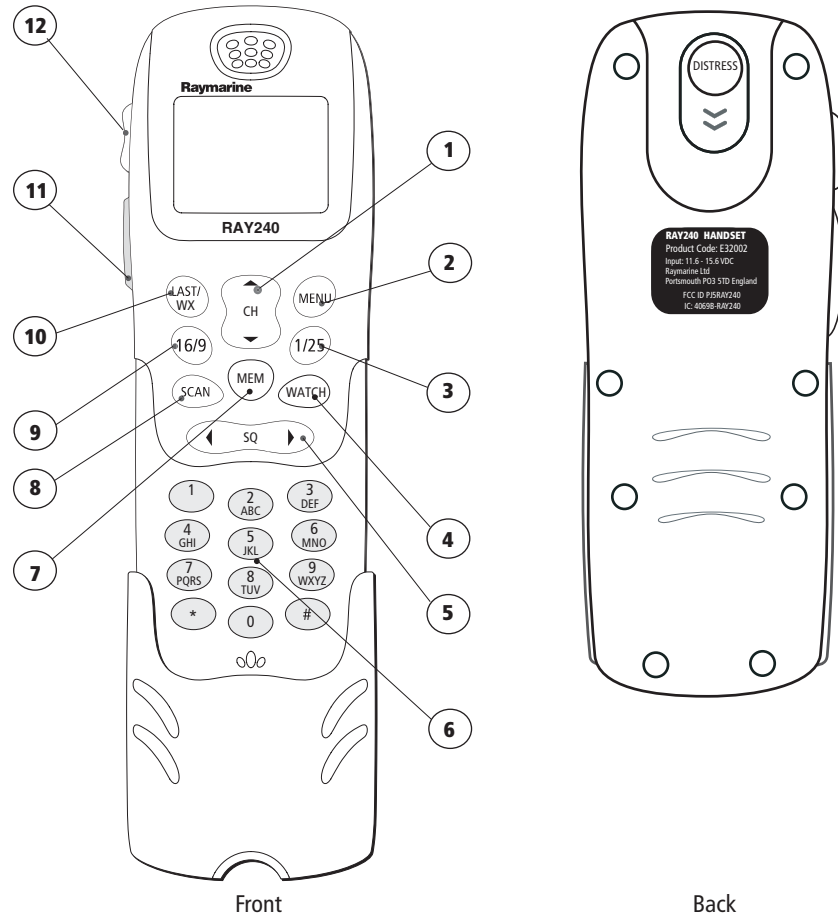

D6741_1

You can access all of the functions of the Ray240, with the exception of adjusting the active speaker volume, from the handset. The clearly marked buttons and alpha-numeric keypad make operation simple.

The **DISTRESS** button can be found beneath a sliding cover on the back of the handset. By simply sliding the cover up and pressing the button, the DSC Distress Call procedure is started.

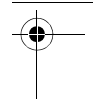
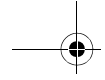

- 1. CHANNEL UP/DOWN** moves the selected channel up or down, or scrolls through the menus.
 - 2. MENU** Press to access the menus, or to select a menu option. Press and hold to access the call menu.
 - 3. 1/25** changes the transmitting power setting from 1 watt (low) to 25 watt (high) or vice versa.
 - 4. WATCH** Press to activate the Dual Watch function (2 channels). Press and hold to activate the Tri-Watch function (3 channels).
 - 5. SQUELCH** mutes any background noise. Also used for the backspace function when making alpha-numeric entries.
 - 6. Key pad** The alpha-numeric keypad has multi-tap operation, the same as a mobile phone.
 - 7. MEMORY** commits a channel to the radio memory.
 - 8. SCAN** starts the scanning of available channels. Press to start priority scanning. Press and hold to start non-priority scanning.
 - 9. 16/9 (16)** Press to power up the radio. Press and hold for 5 seconds to power off the radio. When using the radio, press to re-tune to the priority channel.
 - 10. LAST/WX (PRIV)** Press to return to either the last selected channel, or when navigating the menus to return to the previous screen. Press and hold to access the Weather channels. (Press and hold to access private channels).
 - 11. Push to Talk** Press and hold to send a voice message. Release to return to receive mode.
- Note:** *The maximum transmit time is limited to 5 minutes to prevent non-intentional transmissions from occupying the VHF channel.*
- 12. Volume** adjusts the volume of the radio up or down.

Note: *Differences for European versions of the radio are shown in brackets.*

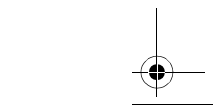
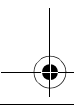
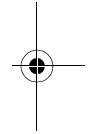
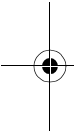

Which menu do I need?

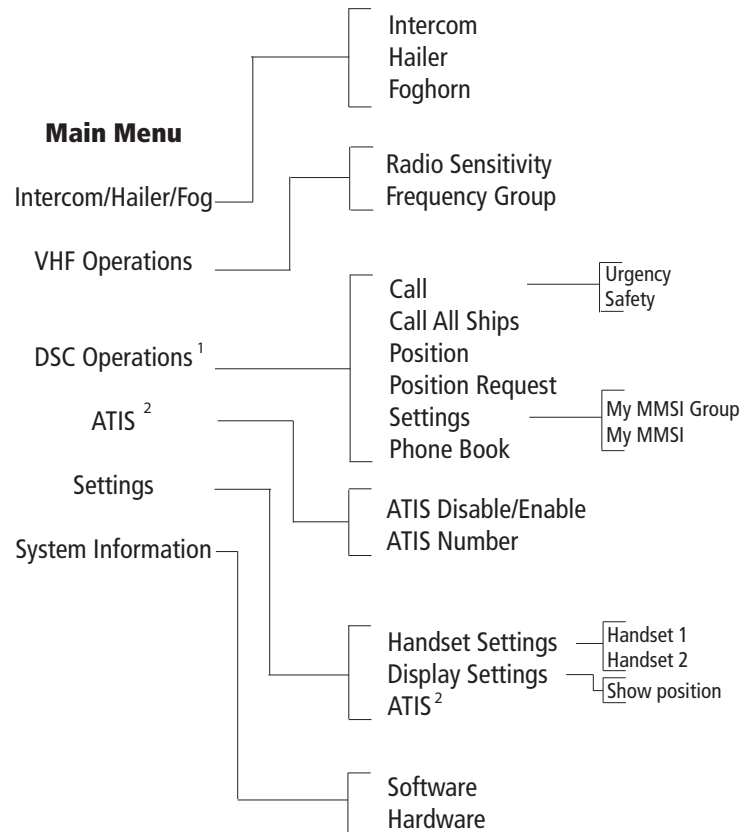

D6742_1

- Notes:** (1) *A Maritime Mobile Service Identity (MMSI) number is required to operate DSC functions.*
- (2) *ATIS function only available on European models. An Automatic Transmission Identification System (ATIS) number is required to operate.*

What does the display tell me?

The liquid crystal display (LCD) screen will give you the following information in normal operating mode:

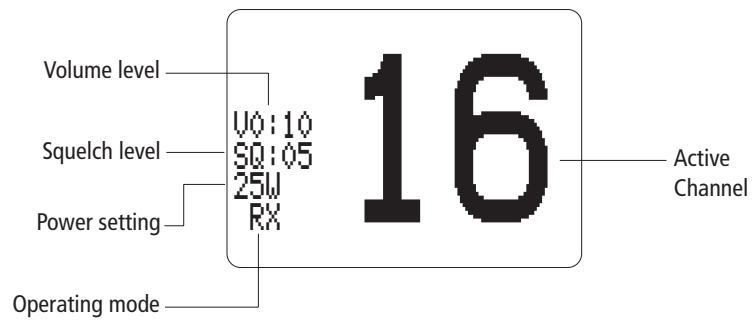

Volume level

Shows the current volume level. Adjustable from 0 to 10.

Squelch level

Shows the current squelch level. Adjustable from 0 to 10.

Power setting

Shows the power level. 1 watt (low) or 25 watts (high).

Operating mode

Shows which operating mode the radio is in, transmit (TX), or receive (RX).

Active channel

Shows the channel on which the radio is currently operating.



Chapter 2: Operations

2.1 Introduction

This chapter shows you how to operate the controls of the Ray240 and use it to make the common Digital Selective Calling (DSC) calls. There are many other useful functions accessed through the Menu, which are listed in detail at the end of this chapter.

Using the radio is simple. All of the functions, except adjusting the active speaker volume are controlled from the handset.

Note: *Differences for the European versions of the radio are shown in brackets in the text.*

2.2 Using the handset - the controls

How do I

....power the radio On and Off?



Power ON

PRESS the **16/9 (16)** button to turn on the radio.

Power OFF

PRESS and HOLD the **16/9 (16)** button for 5 seconds.

After a five second countdown the radio powers off.

....adjust the handset volume?



PRESS the volume key on the side of the handset to adjust the handset volume up or down. Each press of the key raises or lowers the volume by one level.

Note: *It is not possible to adjust the volume while the radio is in 'Menu' mode.*

How do I

....set the squelch?



PRESS this button to reduce background noise from the receiver. Press the right arrow to increase the squelch and the left arrow to decrease it.

The optimum squelch setting is obtained by turning the squelch down until background noise is heard. Then increase the setting by one level to reduce this noise.

Note: *It is not possible to adjust the squelch setting while the radio is in 'Menu' mode.*

....change channels?

Channel UP/DOWN button

Press the Channel UP/DOWN button to change the channels sequentially.



OR

Keypad

By using the keypad you can directly select the required channel number.



....tune to the priority channel?



PRESS this button at anytime when using the radio to tune to the priority channel.

How do I

....monitor channels?

Dual Watch (2 channels)

PRESS this button to start the Dual Watch function.

The radio keeps operating on the current channel, while monitoring the priority channel. If activity is detected on the priority channel it becomes active. When the priority channel is no longer active the radio resumes Dual Watch.



Tri-Watch (3 channels)

PRESS and HOLD this button to start the Tri-Watch function.

The radio will keep operating on the current channel, while monitoring the priority channel and the last channel. Activity detected on any of these channels will make it active. When that channel is no longer active the radio resumes Tri-Watch.

....get the weather forecast?

PRESS and HOLD this button to access the Weather channels.

Use the channel button to select W0 through to W9 depending upon which weather channel is required.

Note: *This function is available only on US/Canadian versions of the Ray240.*



....select Private channels?

PRESS and HOLD the this button to access the Private channels.

Use the channel button to select the required Private channel.

Note: *This function is available only on European versions of the Ray240.*



How do I

....scan the channels?

Priority scanning

PRESS this button to start priority scanning.



The radio scans the priority channel in between scanning each channel in sequence. If activity is detected on a channel the radio automatically tunes to that channel.

Non-priority scanning

PRESS and HOLD this button for non-priority scanning.

The radio will scan the channels in sequence for activity, automatically tuning to a channel if activity is detected.

....use the Memory?

Create a channel list

To create a channel list, select the first channel required, PRESS and hold this button.



Add channels by selecting the number and then pressing and holding this button.

Scan a memory list

PRESS and HOLD this button.

Press or Press and Hold the scan button to start the required mode of scanning.

....change the transmitting power?



PRESS this button to change the transmitting power of the radio from 1Watt (Low) to 25 Watt (High) and vice versa.

How do I

....navigate the menus?



MENU

PRESS this button to access the menus or to accept a menu option.



CHANNEL UP/DOWN

PRESS this button to scroll through the menu options.



LAST/WX (PRIV)

PRESS this button to return to the previous screen.



16/9 (16)

PRESS this button to return to the priority channel



How do I

....use the Menu shortcuts



Press and hold to access the DSC call mode. The Make Call screen will appear, prompting you to enter the MMSI of the boat you want to call.



PRESS to move the cursor bar to the last item on the current display. If the cursor is on the last item, the next page, if available, is shown.

PRESS and HOLD to move the cursor bar to the last item in the menu.



PRESS to move the cursor bar to the top item on the current display. If the cursor is on the top item, the previous page, if available, is shown.

PRESS and HOLD to move the cursor bar to the first item in the selected menu.

....adjust the active speaker volume?



Turn the active speaker knob clockwise to turn the speaker on and increase the volume.

Turn the knob counter-clockwise to decrease the volume and turn the speaker off.

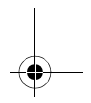
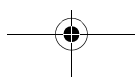
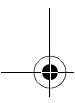

2.3 Using the handset - making and receiving calls

How do I

....use the intercom?

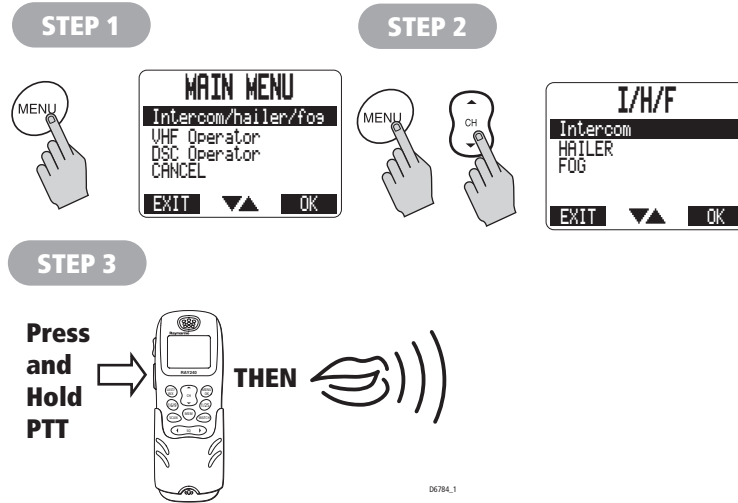

Note: The intercom function is only available when a second station is installed.

....receive a routine call?

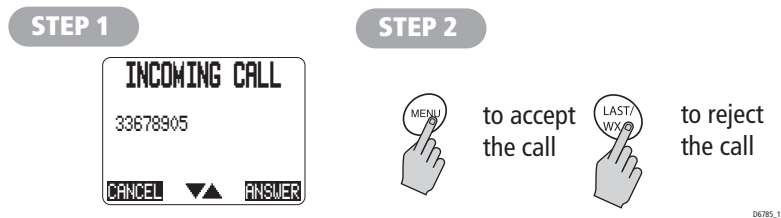

Any calls that remain unanswered for more than 30 seconds or that you reject are logged. Any logged information can be retrieved from the Call Log.

How do I

...call another ship?

STEP 1

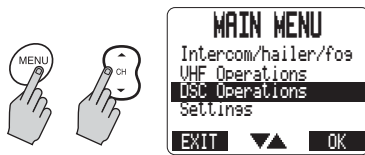

STEP 2



STEP 3

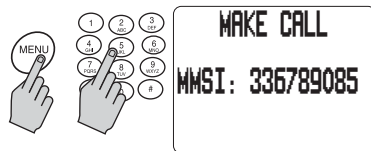

STEP 4

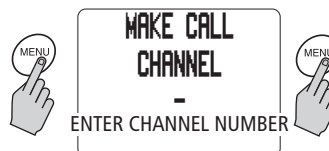

STEP 5



STEP 6

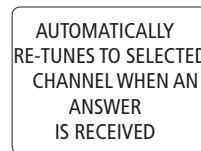

STEP 7



How do I

....make a specified Distress call?

STEP 1



STEP 2

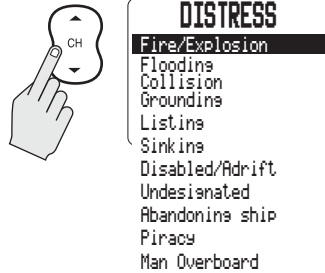

STEP 3

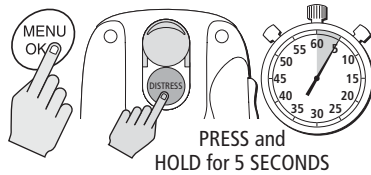

STEP 4



STEP 5

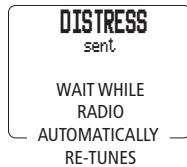

MAYDAY, MAYDAY, MAYDAY

This is.... (repeat name of vessel 3 times)

MAYDAY

THIS IS.... (name of vessel spoken once)

MY POSITION IS.... (latitude and longitude) or true bearing and distance from a known point).

IF YOU DON'T KNOW, DON'T GUESS.

I AM.... (sinking, on fire, etc)

I HAVE.... (number of persons on board and any other information - drifting, flares fired, etc)

I REQUIRE IMMEDIATE ASSISTANCE

OVER

RELEASE THE PTT SWITCH

STEP 6

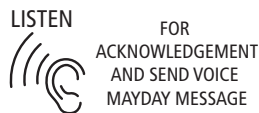
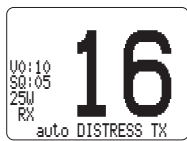

How do I

....cancel a Distress call?

Note: The 'Distress' option on the main menu is only available after a DSC distress call has been sent.

STEP 1

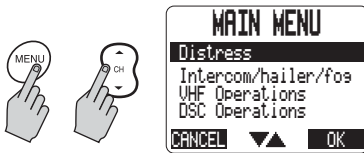

STEP 2



STEP 3

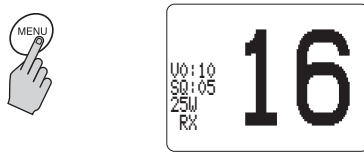

STEP 4

Press and Hold PTT

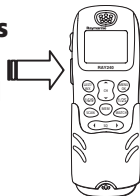

THEN



ALL STATIONS, ALL STATIONS, ALL STATIONS

THIS IS.. (MMSI number and Vessel name or Call sign spoken 3 times)

DISTRESS ALERT SENT....(time and date) **IS CANCELLED**

OVER

SLOWLY and CLEARLY

How do I

....make an All Ships Call (Urgency)?

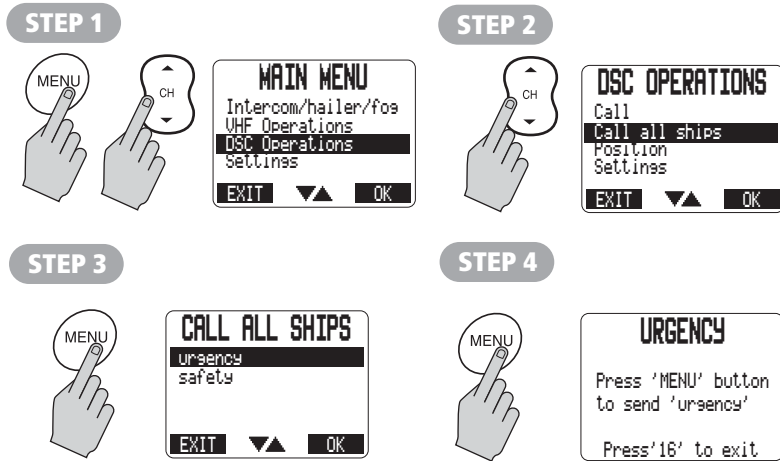

STEP 5

Press and Hold PTT



THEN

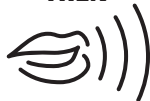

SLOWLY and CLEARLY

PAN PAN, PAN PAN, PAN PAN

ALL STATIONS or individual Coast Guard Station (spoken 3 times)

THIS IS.. (MMSI number and Vessel name or Call sign spoken 3 times)

MY POSITION IS.... (latitude and longitude) or true bearing and distance from a known point).
IF YOU DON'T KNOW, DON'T GUESS.

I HAVE... (lost power and am drifting)

I REQUIRE (state type of assistance required e.g. a tow urgently.)

OVER

How do I

....make a position request?

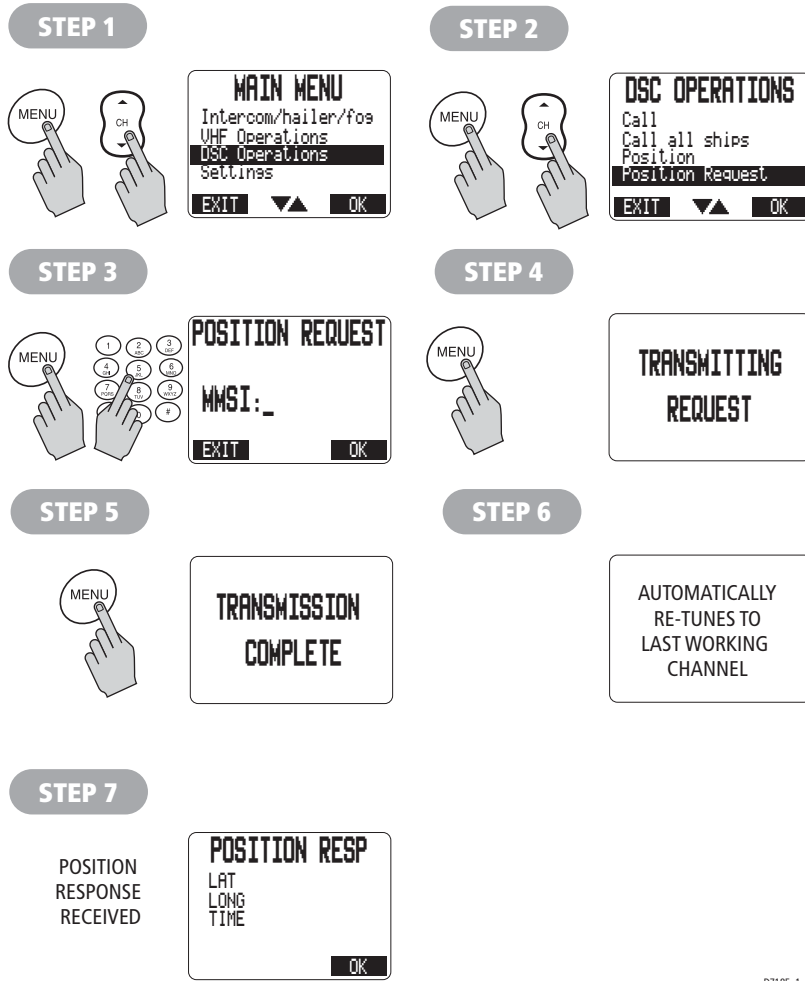

2.4 Using the DSC phone book

How do I

....make a DSC phone call?

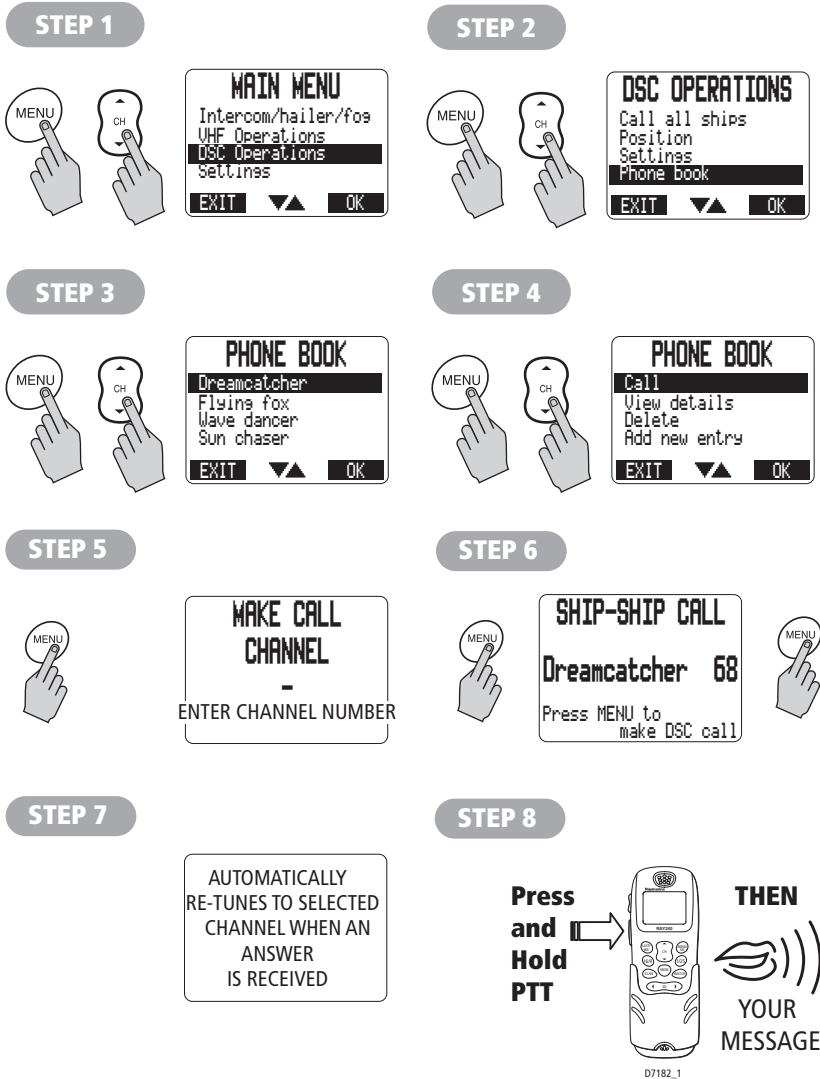

How do I

....view phone book details?

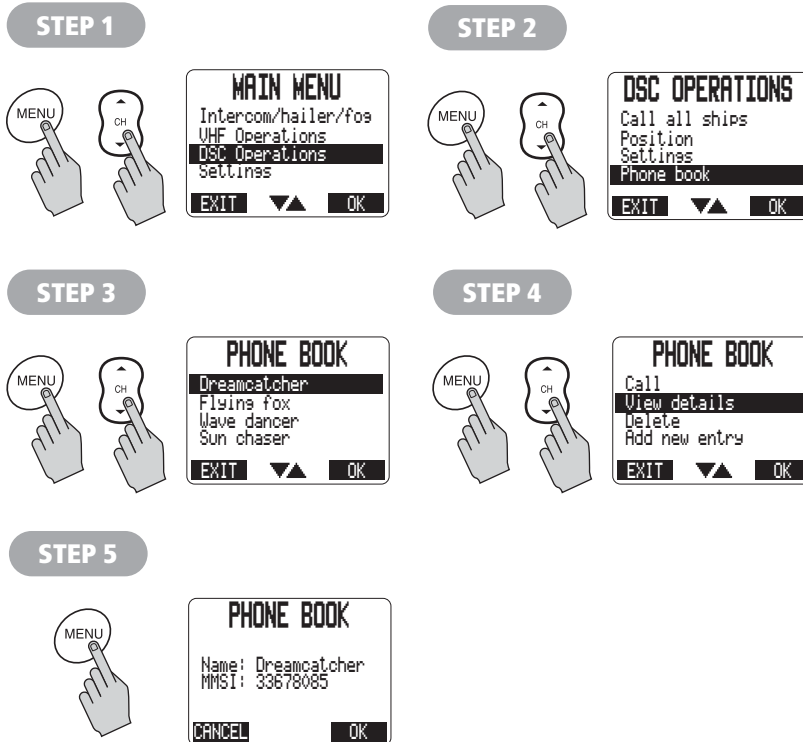

D7183_1

- Notes:** (1) Boat names are limited to 15 characters.
(2) MMSI numbers can be entered as boat, group or shore numbers.

How do I

.... add an entry to the DSC phone book?

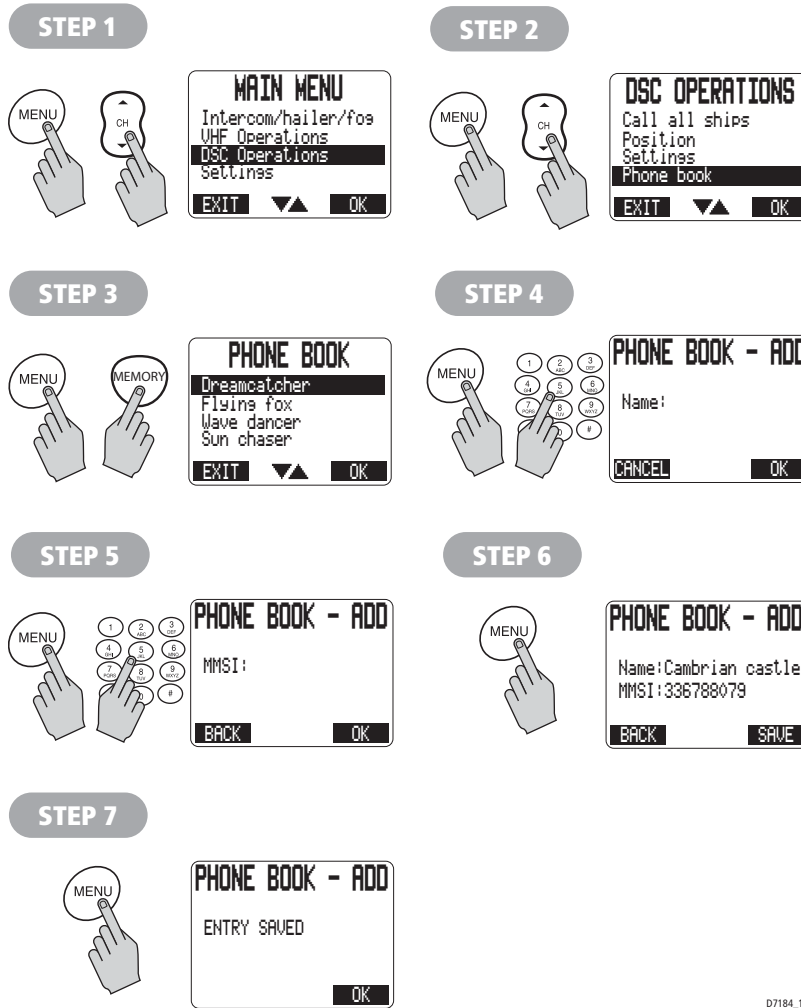

D7184_1

- Notes:** (1) Boat names are limited to 15 characters.
(2) MMSI numbers can be entered as bat, group or shore numbers.

2.5 Receiving distress alerts

Distress calls

When your radio receives a distress call, it displays the message:



and sounds an audible alarm. Your action should be, either:

- Press **MENU**, and accept the call. The alarm is cancelled and the radio will automatically re-tune to Channel 16.

or

- Press **LAST/WX (LAST/PRIV)**, and reject the call, if for example you are unable to offer any assistance. The alarm is cancelled and the call is logged.

Distress acknowledgement

When your radio receives a distress acknowledgement as a result of a distress call transmitted by you or another vessel, your radio responds in the following way:

Distress acknowledgement to a call from your radio

If an acknowledgement is received to a distress call transmitted by your radio, it responds by:

- cancelling automatic re-transmission of the distress alert.
- displaying a message showing the replying vessels MMSI and position.

Your action should be to press **MENU**. The radio automatically re-tunes to Channel 16 and monitors it.

Distress acknowledgement for another vessel?

If a distress acknowledgement is received for another vessel that is in distress, the radio displays a suitable message and sounds an audible alarm. Your action should be, either:

- Press **MENU**, and accept the call. The radio automatically re-tunes to Channel 16 and monitors it.



or

- Press **LAST/WX (LAST/PRIV)**, and reject the call. The alarm is cancelled and the call is logged.

Distress relay

When your radio receives a distress relay call, it displays a suitable message and sounds an audible alarm. Your action should be, either:

- Press **MENU**, to accept the call. The alarm is cancelled and the radio automatically re-tunes to Channel 16.

or

- Press **LAST/WX (LAST/PRIV)**, to reject the call. The alarm is cancelled and the call is logged.

2.6 Receiving weather alerts

Whilst the radio is in Dual or Tri-Watch modes a National Oceanographic and Atmospheric Association (NOAA) weather alert will cause an audible alert tone to be sounded.

2.7 Additional functions

In addition to those already described in this chapter, the Ray240 has further functions that can be accessed from the Main menus.

This section gives a brief description of these functions and what they do.

Intercom/fog/hailer

Intercom

for full details of using the intercom function refer to *How do I...use the intercom?* on *page 25*.

Fog warnings

The Ray240 has in-built fog warning tones that can be transmitted through a hailer horn. These tones can be used in manual or automatic modes.

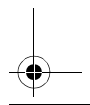
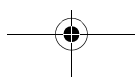
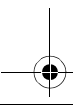
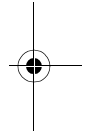
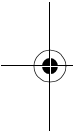

**Manual mode**

In manual mode a whistle or bell tone is transmitted whenever the PTT switch is pressed. Releasing the PTT will stop the tone.

Automatic mode

In automatic mode a signal is generated and transmitted by the unit at preset intervals not exceeding 2 minutes until cancelled. The available tones are:

Signal	Tone
Power boat Underway and making way	1 long whistle
Powerboat Underway and not making way	2 long whistles
Sailboat under sail Any type of boat that is: Fishing Not under command Restrictred ability to manoeuver Constrained by draught Towing	1 long, 2 short whistle
Under tow	1 long, 3 short whistle
Pilot	4 short whistle
Boat at anchor (less than 100m in length)	Either a rapidly ringing bell, or 1 short, 1long, 1 short whistle tone
Boat aground	3 single, 5 rapid, 3 single bell tones

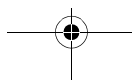
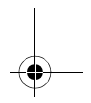
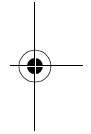

How do I

....set up the automatic fog signal?

Step 1

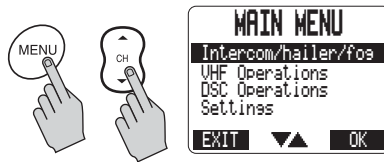

Step 2

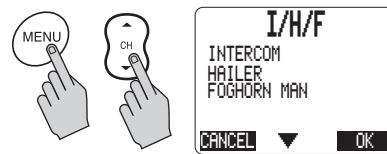

Step 3

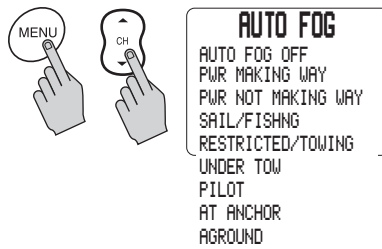

Step 4

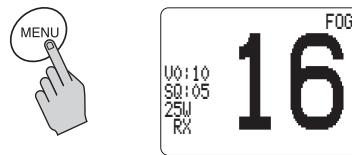

D7174_1

VHF Settings

Radio Sensitivity

Enables the receiving sensitivity of the Ray240 to be reduced in areas of high traffic to decrease unwanted reception. This is also known as local mode.

DSC Operations

Position

Enables you to manually enter your position and time using the alpha-numeric keypad.

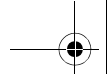

Position Request

Enables the use of DSC messages to determine the position of other vessels within radio range. The positions of other vessels can be sent to a chart plotter, if interfaced with your radio. *See How do I... make a position request?, page 30.*

Settings

Handset Settings

Enables you to adjust the following:

- Display contrast
- Keypad backlighting
- Keypad clicks
- Alert tones

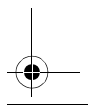
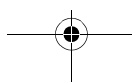
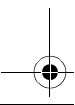
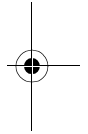
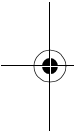

Chapter 3: Installation

3.1 EMC Installation Guidelines

All Raymarine Equipment and accessories are designed to the best industry standards for use in the recreational marine environment.

Their design and manufacture conforms to the appropriate Electromagnetic Compatibility (EMC) standards, but correct installation is required to ensure that performance is not compromised. Although every effort has been taken to ensure that they will perform under all conditions, it is important to understand what factors could affect the operation of the product.

The guidelines given here describe the conditions for optimum EMC performance, but it is recognized that it may not be possible to meet all of these conditions in all situations. To ensure the best possible conditions for EMC performance within the constraints imposed by any location, always ensure the maximum separation possible between different items of electrical equipment.

For optimum EMC performance, it is recommended that wherever possible:

- Raymarine equipment and cables connected to it are:
 - At least 3 ft. (1m) from any other equipment transmitting or carrying radio signals. In the case of Single Side Band (SSB) radio, the distance should be increased to 7 ft. (2m).
 - More than 7 ft. (2m) from the path of a radar beam. A radar beam can normally be assumed to spread 20 degrees above and below the radiating element.
- The equipment is supplied from a separate battery to that used for engine start. Voltage drops below 10 V, and starter motor transients, can cause the equipment to reset. This will not damage the equipment, but may cause the loss of some information and may change the operating mode.
- Raymarine specified cables are used. Cutting and rejoining these cables can compromise EMC performance and must be avoided unless doing so is detailed in the installation manual.

Suppression Ferrite

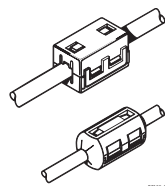

If a suppression ferrite is attached to a cable, this ferrite should not be removed. If the ferrite needs to be removed during installation it must be reassembled in the same position.

The illustration shows typical cable suppression ferrites used with Raymarine equipment. Always use the ferrites supplied by Raymarine.

Connections to other equipment

If your Raymarine equipment is to be connected to other equipment using a cable not supplied by Raymarine, a suppression ferrite **MUST** always be attached to the cable near to the Raymarine unit.

3.2 What's in the box?

You will find these items in the box:

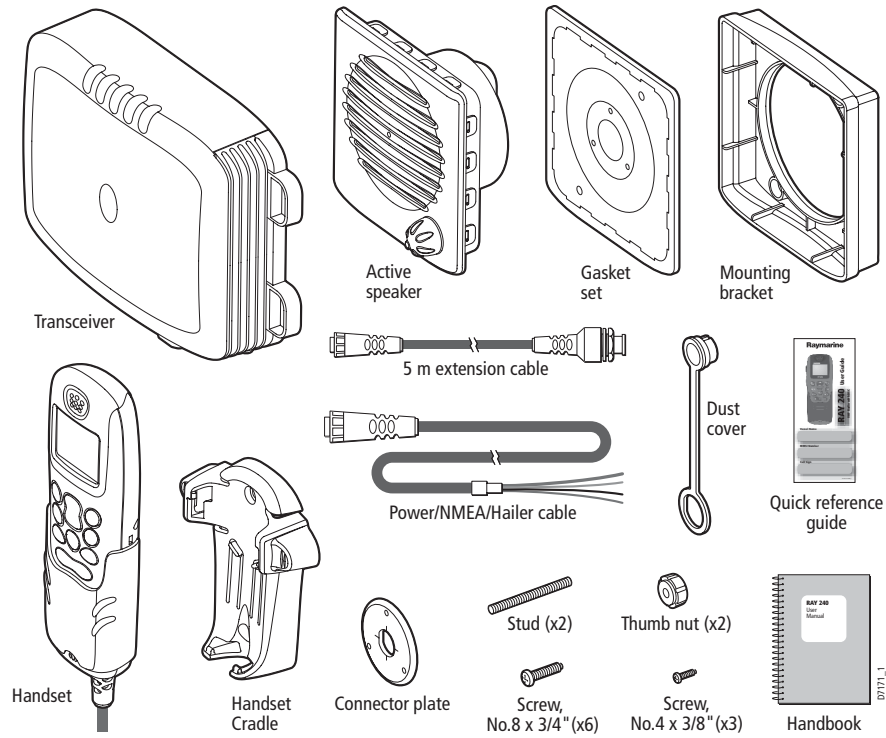

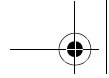

Can I get optional extras?

You can obtain the following optional extras for the Ray240:

Description	Part No.
Second station includes handset, cradle and speaker and 5m extension cable	
Ray240	E45001
Ray240E	E45002
Handset only	
Ray240	E45009
Ray240E	E45010
Active speaker	E45003
Extension cable, 3m	E45011
Extension cable, 5m	E45012
Extension cable, 10m	E45013
Bulkhead Mounting Kit	E45014
Bracket (trunnion) Mounting Kit	E25009

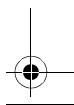
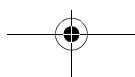
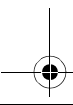
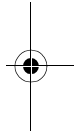
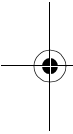



3.3 Where should I install my radio?

CAUTION: Compass safe distance

The compass safe distance, measured in accordance with EN60945, for the Ray240 is 0.9 m.

Before installing the Ray240 you should plan the installation, considering the following points:

Transceiver Unit

You should mount the transceiver unit on a bulkhead, below decks that is:

- dry, protected and well ventilated.
- free from high operating temperatures.
- free from excessive vibration.
- accessible for cable routing.
- at least three feet from the antenna.
- in such a position that accidental contact with the heatsink is avoided.

You must avoid mounting it:

- in an engine compartment.
- where there might be flammable vapors, such as in an engine room or compartment, or in a fuel tank bay.
- where there is water splash or spray from bilges and hatches.
- where it is a risk of physical damage from heavy items, such as hatch covers, tool boxes, etc.
- where it might be covered by any other equipment.

Handset and cradle

You should mount the primary handset and cradle:

- where they are easily accessed from the location where the ship is normally navigated. Federal Communications Commission (FCC) law requires that the primary handset is located in the wheelhouse or a room adjacent to it.
- at least three feet from the antenna.

Active speaker

You should mount the active speaker in a position where it is easy to hear and is convenient for your use.

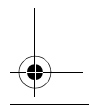
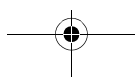
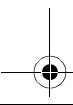
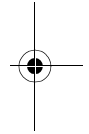
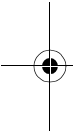



Antenna **(not supplied)**

You should use a good quality VHF antenna, designed for marine use installed in accordance with the following:

- ensure that the antenna is connected to the radio before transmitting.
- Raymarine declares a Maximum Permissible Exposure (MPE) radius of 1.5 meters (per OET Bulletin 65) for this system, assuming 25 watts output to an omnidirectional antenna of 3dBi gain or less.
- for watercraft with suitable structures, the antenna base must be at least 3.5 meters above the main deck to meet the MPE for persons up to 2 meters tall.
- for watercraft without such structures, the antenna must be mounted so that its base is a minimum of 1.5 meters vertically from the heads of all persons.
- as high as possible and free from obstruction for maximum range. VHF transmission is essentially line-of-sight.
- if you have to extend the length of the co-axial cable between the antenna and the radio, use one that is designed for minimum power loss over the cable length.

Cables

When planning the installation, consideration should be given to where cables are to be run:

- Try and avoid acute bends in cables.
- Secure and protect cables from physical damage and protect them from exposure to heat. Avoid running cable through bilges or doorways, or close to moving or hot objects.
- Where a cable passes through an exposed bulkhead or deck head, a water-tight feed-through should be used.

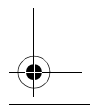
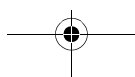
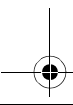
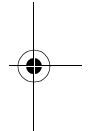
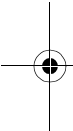

3.4 Typical installation

A typical installation for the Ray 240 is shown below:

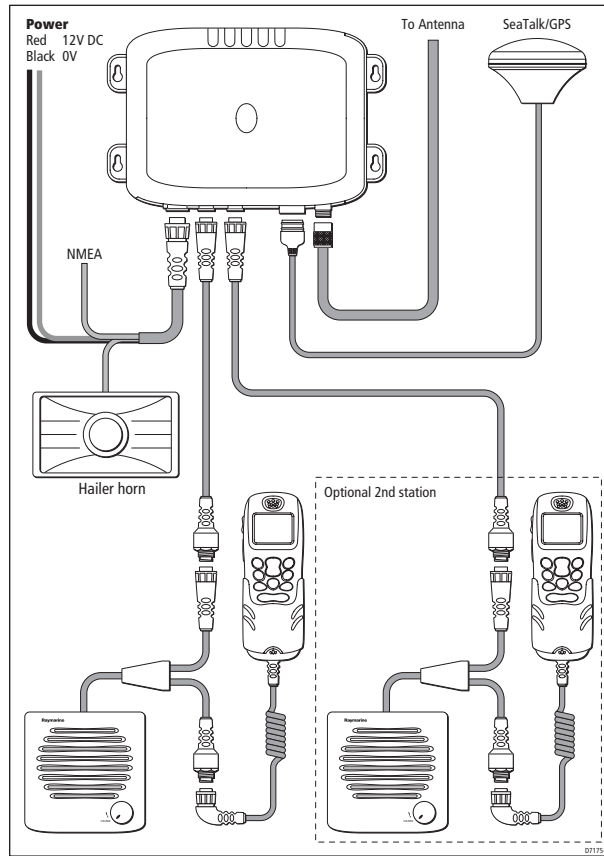

3.5 How much space does the Ray240 need?

To help you plan the installation of your Ray240 and its associated components the dimensions are:

Transceiver Unit

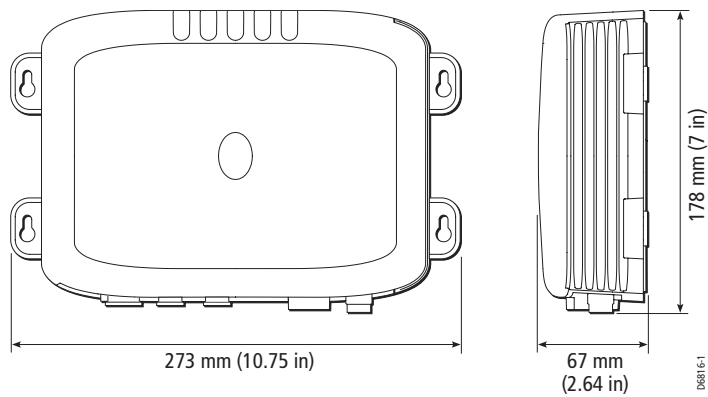

A **50mm** air space should be left around the transceiver when installed to enable airflow and ventilation for cooling the heatsink.

Note: During normal operation, the transceiver unit heat sink will become warm. This does not affect the operation of the unit.

Active speaker

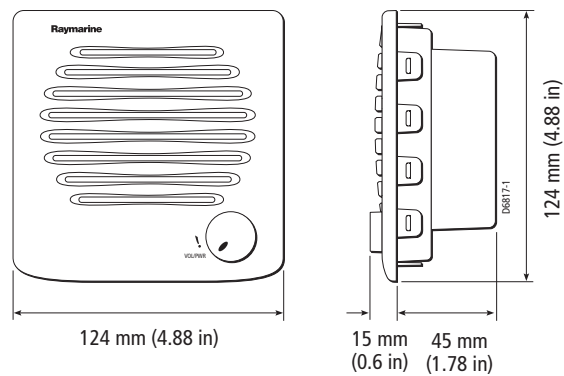

Handset and Cradle

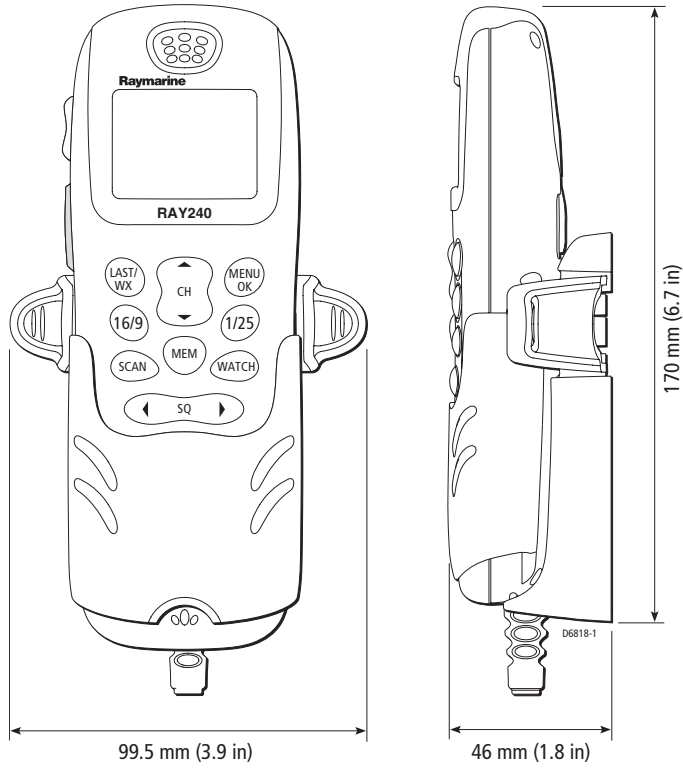



3.6 How do I make the electrical connections?

You should use the combined Power/Hailer/NMEA cable to make the electrical connections. This cable contains four wire pairs for connection to Direct Current (DC) power, National Marine Electronics Association (NMEA) input, and the Hailer/Horn speaker. The connections are:

Cable color	Connection
Red	12 Volt Positive
Black	12 Volt Negative
Yellow	Hailer +
Green	Hailer -
Black	Not used
White	NMEA In +
Blue	NMEA In -
Brown	NMEA Out +
Orange	NMEA Out -
Black	Not used

Raymarine recommend that unused connections have the tinned ends removed and the tails are taped back to the main cable sheath.

For optimal installation, used screened cables throughout, ensuring that the screen connection is continuous and terminates at the boat's earth.

The Ray240 base transceiver does not have an ON/OFF switch. It is therefore strongly recommended that your radio is connected to the boat's power supply through a dedicated power breaker to avoid unnecessary drain on the electrical system when your boat is not in use.

To ensure that the unit works correctly:

- You should connect the power cable to the DC supply using lugs (not supplied) that have been crimped and soldered.
- Use an antenna and mount that does not connect the co-axial cable outer to the ships earth.

How do I connect the cables to the transceiver?

You connect the cables to the labelled connectors as follows:

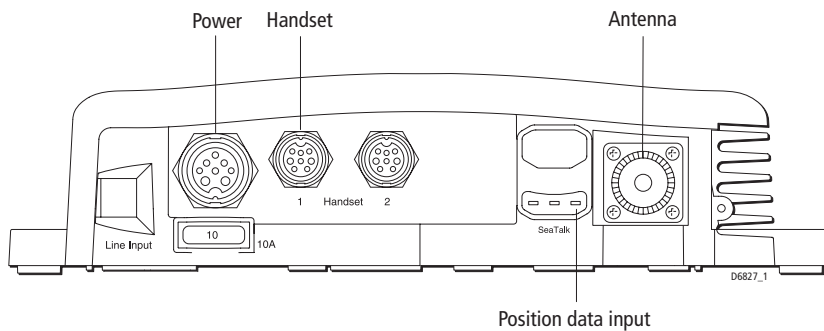

How do I connect the handset to the transceiver?

You should connect the handset cable to the transceiver using the bulkhead mounted connector. Full details of which are shown on the Installation Guide.

3.7 How do I get position data?

You can get position data for providing latitude and longitude information using either NMEA or SeaTalk connections.

SeaTalk data

If you have a SeaTalk instruments installed, this is the most convenient way to connect your radio for position data to be received. Using the SeaTalk Auxiliary Junction Box, Part No. R55006 (not supplied), enables Sea Talk and Global Positioning System (GPS) inputs to be connected in one place.

NMEA data

You should connect the White and Blue (NMEA + and -) wires of the combined cable to the input wires of the positioning device using a suitable connector block.

The following sentences are used by the Ray240:

Received - GGA, GLL, RMC, ZDA.

For specific instructions on how to connect your particular GPS, refer to the handbook which came with that device.

3.8 Setting up the Ray240

How do I

.... enter my boat's MMSI number?

 Have your MMSI number ready before you start

Step 1

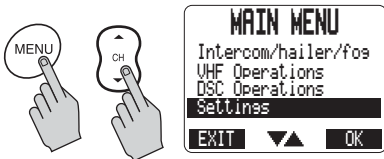

Step 2

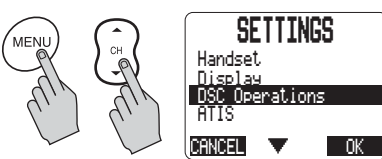

Step 3

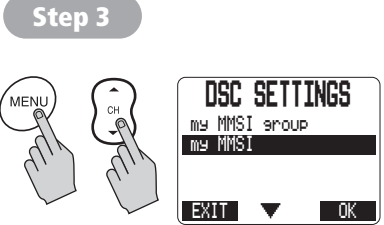

Step 4

 **CAUTION: MMSI NUMBER**
You only get one chance to enter the MMSI number. Take care to get it right!

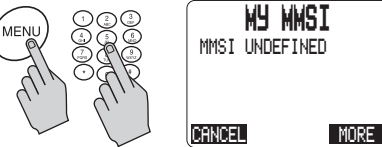

Step 5

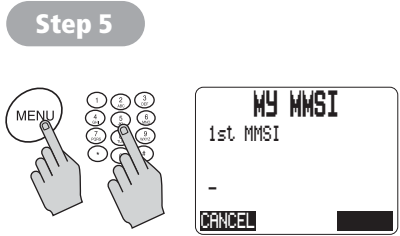

Step 6

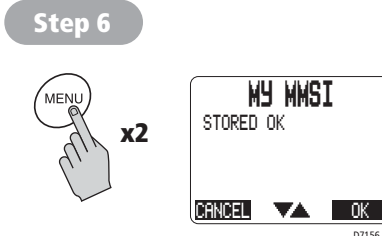

D7156_1

Note: To change the MMSI number the radio must be returned to your Raymarine dealer.

How do I

....enter my ATIS number?

 Have your ATIS number ready before you start

Step 1

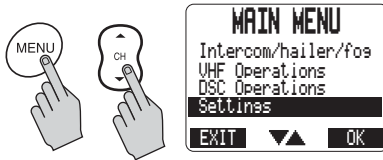

Step 2

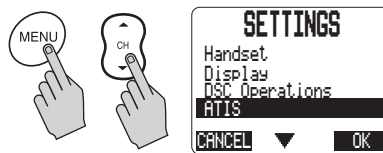

Step 3

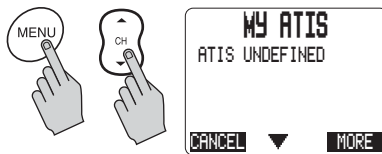

Step 4

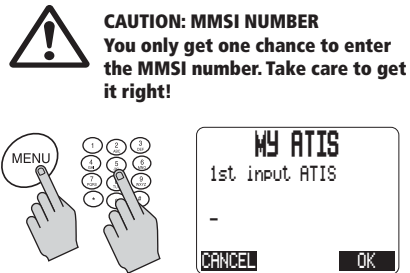

Step 5

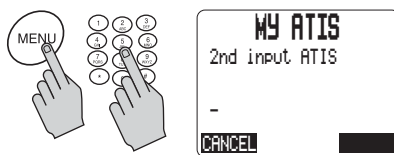

Step 6



D7157_1

Note: This procedure is only applicable to the European version of the Ray240.



Chapter 4: Maintenance and Troubleshooting

4.1 Introduction

The Ray240 is designed to provide long-term operation. It is recognized, however that environmental and other factors may result in the need for occasional service.

4.2 What maintenance can I do?

The Ray240 has no user serviceable parts or adjustments. Never remove the cover or attempt to service the product.

Your attention to a few basic points should ensure many years of service:

- Although the unit is waterproof, keep it as dry as possible.
- Clean the exterior of the unit with a tissue or soft non-abrasive cloth.

CAUTION:

Do not use solvents or other chemicals to clean this equipment.

- Regularly inspect the radio case and antenna for any physical damage.

4.3 How do I troubleshoot the Ray240?

All Raymarine products are, prior to packing and shipping, subjected to comprehensive test and quality assurance programs. However, if your Ray240 should develop a fault, please refer to the following table to identify the most likely cause and the suggested action required to return the radio to normal operation.

If you still have a problem after referring to the table below, contact your local Raymarine dealer, national distributor or Raymarine Technical Services Department for further advice.

Always quote the product serial number, which you will find printed on the unit.

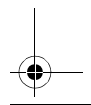
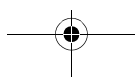
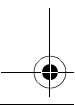
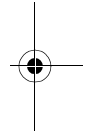
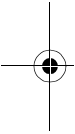

Problem	Possible cause	Suggested action
Radio will not power up	(a) Loose wiring connection (b) 10 amp Fuse has blown	(a) Check all connections (b) Check 10 amp fuse and replace if necessary.
Radio does not appear to be transmitting	Poor connection to antenna	Use Standing Wave Ratio (SWR) function in System Diagnostics menu.
DSC functions are not working	MMSI number not entered	Check MMSI number has been entered correctly
Position data not shown	Information not being received from GPS	Check GPS is switched on and connected to the radio. Check units are interfaced correctly.

4.4 How do I get the radio serviced?

In the US/Canada

In the unlikely event of your Ray240 developing a problem, contact the Raymarine dealer from where it was purchased.

Service may also be obtained by returning the unit to:

Product Repair Center
Raymarine Inc.,
22 Cotton Road, Unit D,
Nashua, NH 03063-4219.
Telephone: 1-603-881-5200
Fax: 1-603-864-4756



In Europe

In the unlikely event of your Ray240 developing a problem, contact the Raymarine dealer from where it was purchased.

Service may also be obtained by returning the unit to:

Raymarine Ltd.
Anchorage Park
Portsmouth, Hampshire
England, PO3 5TD.
Tel +44 (0) 23 9269 3611
Fax +44(0) 23 9269 4642

Rest of the World

Please contact the authorized distributor in your country. A list of worldwide distributors is supplied with your unit and is also displayed on the Raymarine web site.

4.5 How do I contact Raymarine?

In the US/Canada

In the US and Canada you can contact Raymarine as follows:

Technical Support	1-800-539-5539 ext 2444
	1-603-881-5200 ext 2444

Our Technical Support Specialists are available to answer installation, operation and troubleshooting questions, Monday to Friday 0815 hours to 1800 hours Eastern Standard Time.

Accessories and Parts	1-800-539-5539 ext 2333
	1-603-881-5200 ext 2333

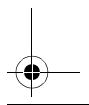
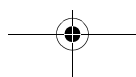
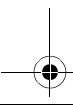
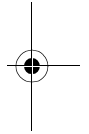
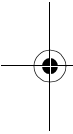



Most Raymarine accessory items and parts are available through your authorized Raymarine dealer. However items not available from them may be ordered Monday to Friday 0815 hours to 1700 hours Eastern Standard Time.

In Europe and the Rest of the World

In Europe and the Rest of the World you can contact Raymarine as follows:

Technical Support

Tel: +44 (0) 23 9271 4713

Fax: +44 (0) 23 9266 1228

The Technical Services Department handles enquiries concerning installation, operation, fault diagnosis and repair.

On the Internet

You can also reach us on the Raymarine World Wide Web site:

www.raymarine.com

Navigate to the Customer Support page, which provides links for:

- Finding factory service locations and Authorized dealers near you.
- Accessing handbooks.
- Searching questions and answers in our solution database by product, category, keywords and phrases.
- Submitting a question to our technical support staff, who will reply to you via e-mail.

Questions also be sent directly to the Technical Support department on the Customer Support page by clicking Ask Raymarine.

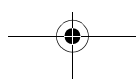
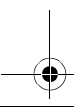
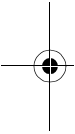
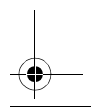
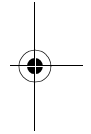

Appendix A: VHF Channels

US Marine VHF Channels

Type of Message	Appropriate Channel(s)
DISTRESS, SAFETY and CALLING Use this channel to get the attention of another station (calling) or in emergencies (distress and safety)	16
INTERSHIP SAFETY Use this channel for ship-to-ship safety messages and for search and rescue messages. Also to communicate with Coast Guard ships and aircraft	6
COAST GUARD LIAISON Use this channel to talk to the Coast Guard after first contact on Channel 16	22
NON-COMMERCIAL Working channel for voluntary boats. Messages must be about the needs of the ship. Typical uses include fishing reports, rendezvous, scheduling repairs and berthing information. Use Channels 67 and 72 only for ship-to-ship messages	9 ⁶ , 68, 69, 71, 72, 78, 79 ⁴ , 80 ⁴
COMMERCIAL Working channels for working ships only. Messages must be about business or the needs of the ship. Use Channels 8, 67, 72 and 88 only for ship-to-ship messages.	1 ⁵ , 7, 8, 9, 10, 11, 18, 19, 63 ⁵ , 67, 72 ⁷ , 79, 80, 88 ²
PUBLIC CORRESPONDENCE (MARINE OPERATOR) Use these channels to call the marine operator at a public coast station. By contacting a public coast station you can make and receive calls from telephones on shore. Except for distress calls, public coast stations usually charge for this service.	24, 25, 26, 27, 28, 84, 85, 86, 87, 88 ²
PORT OPERATIONS These channels are used in directing the movement of ships in or near ports, locks or waterways. Messages must be about the operational handling, movement and safety of ships. In certain major ports Channels 11 and 12 are not available for general port operations messages. Use Channel 20 only for ship-to-coast messages. Channel 77 is limited to intership communications to and from pilots	1 ⁵ , 5 ³ , 12, 14, 20, 63 ⁵ , 65, 66, 73, 74, 77

US Marine VHF Channels (Continued)

Type of Message	Appropriate Channel(s)
<p>NAVIGATIONAL (Also known as the bridge-to-bridge channel) This channel is available to all ships. Messages must be about ship navigation, for example, passing or meeting other ships. <i>You must keep your messages short. Your power output must not be more than 1 watt.</i> This is also the main working channel at most locks and drawbridges.</p>	13, 67
<p>MARITIME CONTROL This channel may be used to talk to ships and coast stations operated by state or local governments. Messages must pertain to regulation and control, boating activities, or assistance to ships</p>	17
<p>DIGITAL SELECTIVE CALLING Is available for Digital Selective calling only and is not available for voice transmissions.</p>	70
<p>WEATHER On these channels you may receive weather broadcasts of the National Oceanic and Atmospheric Administration. These channels are only for receiving. You cannot transmit on them.</p>	Wx-1 162.55 Wx-2 162.4 Wx-3 162.475

Footnotes to table

1. Not available in the Great Lakes, St. Lawrence Seaway, or the Puget Sound and the Strait of Juan de Fuca and its approaches.
2. Only for use in the Great Lakes, St. Lawrence Seaway, or the Puget Sound and the Strait of Juan de Fuca and its approaches.
3. Available only in the Houston and New Orleans areas.
4. Available only in the Great Lakes.
5. Available only in the New Orleans area.
6. Available for intership, ship and coast general purpose calling by non-commercial ships.
7. Available only in the Puget Sound and the Strait of Juan de Fuca.

Note: *Operators should check order of preference for channel use with local information for chosen area of operation.*

Important Notice

Channels 3A, 21A, 23A, 61A, 64A, 81A, 82A, and 83A are not for use by the general public in U.S. waters. These frequencies may be used only under authorization by the U.S. Coast Guard or under private land mobile license.

International Marine VHF Channels

Type of Message	Appropriate Channel(s)
DISTRESS, SAFETY and CALLING Use this channel to get the attention of another station (calling) or in emergencies (distress) and safety)	16
INTERSHIP SAFETY Use this channel for bridge to bridge communications under the Global Maritime Distress Safety System (GMDSS).	13
SEARCH and RESCUE OPERATIONS Use of these channels is restricted to co-ordinate search and rescue operations	6 ¹ , 10, 67, 73
INTERSHIP Use these channels for communications between ship stations	8, 9, 13, 15 ² , 17 ² , 69, 72, 77
PUBLIC CORRESPONDENCE (Marine Operator) Use these channels to make a call to the public telephone network. They are also known as 'link channels'	1, 2, 3, 4, 5, 7, 18, 19, 20, 21, 22, 23, 24, 25, 27, 28, 60, 61, 62, 63, 64, 65, 66, 78, 79, 81, 82, 83, 84, 85, 86, 87, 88
PORT OPERATIONS and SHIP MOVEMENT These channels are used in directing the movement of ships in or near ports, locks or waterways. Messages must be about the operational handling, movement and safety of ships. These channels are assigned to a particular user, e.g marina or oil terminal.	5, 7, 9, 11, 12, 14, 18, 19, 20, 21, 22, 60, 61, 62, 63, 64, 65, 66, 68, 69, 71, 72, 74, 75, 76 ³ , 78, 79, 81, 82, 83, 84, 85, 86, 87, 88
MARINA CHANNELS - UK ONLY Use these channels for matters relating to mooring, berthing and race control.	80, M1 ⁴ , M2 ⁴
MARINE SAFETY INFORMATION - UK ONLY Use of this channel is primarily for Search and Rescue operations, and the broadcasting of Marine Safety Information	15,17
DIGITAL SELECTIVE CALLING Is available for Digital Selective calling only and is not available for voice transmissions.	70

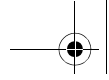

Footnotes to table:

1. This channel may also be used for communications between ship stations and aircraft engaged in co-ordinated search and rescue operations.
2. These channels may also be used for on-board communications provided the power emitted does not exceed 1 watt.
3. These channels should be restricted to navigation related communications only at power of 1 watt.
4. These channels are for use in UK territorial waters only.

Note: *Operators should check order of preference for channel use with local information for chosen area of operation.*

Important Notice

The international frequency mode is not legal for use while operating in U.S waters. The TX/RX frequencies available in the International frequency mode were agreed upon by the attending countries at the 1968 International Telecommunications Union meeting in Geneva, and are legal for use in International waters only.

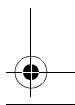
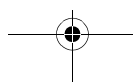
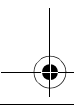
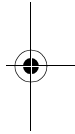
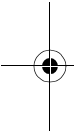

Canadian Marine VHF Channels

Type of Message	Appropriate Channel(s)
<p>DISTRESS, SAFETY and CALLING Use this channel to get the attention of another station (calling) or in emergencies (distress and safety)</p>	16
<p>INTERSHIP SAFETY Use this channels for ship-to-ship safety messages and for search and rescue messages. Also to communicate with Coast Guard ships and aircraft</p>	6, 26, 77
<p>COAST GUARD LIAISON Use this channel to talk to the Coast Guard after first contact on Channel 16</p>	4 ¹ , 19, 21, 61 ¹ , 62 ¹ , 81, 82, 83
<p>NON-COMMERCIAL Working channel for voluntary boats. Messages must be about the needs of the ship. Typical uses include fishing reports, rendezvous, scheduling repairs and berthing information. Use Channels 67 and 72 only for ship-to-ship messages</p>	68, 69, 71
<p>COMMERCIAL Working channels for working ships only. Messages must be about business or the needs of the ship. Use Channels 8, 67, 72 and 88 only for ship-to-ship messages.</p>	4 ¹ , 7, 8, 18, 61 ¹ , 62 ¹ , 64, 65 ² , 67 ³ , 69 ³ , 71, 73 ³ , 78, 79, 80
<p>PUBLIC CORRESPONDENCE (MARINE OPERATOR) Use these channels to call the marine operator at a public coast station. By contacting a public coast station you can make and receive calls from telephones on shore. Except for distress calls, public coast stations usually charge for this service.</p>	1, 2, 3, 23 ⁴ , 24, 25 ⁵ , 26, 27 ⁶ , 28 ¹ , 60, 84, 85, 86, 87, 88
<p>PORT OPERATIONS These channels are used in directing the movement of ships in or near ports, locks or waterways. Messages must be about the operational handling, movement and safety of ships. In certain major ports Channels 11 and 12 are not available for general port operations messages. Use Channel 20 only for ship-to-coast messages. Channel 77 is limited to intership communications to and from pilots</p>	11, 12, 14, 20 ² , 65 ⁷ , 66 ⁸ ,
<p>NAVIGATIONAL (Also known as the bridge-to-bridge channel) This channel is available to all ships. Messages must be about ship navigation, for example, passing or meeting other ships. <i>You must keep your messages short. Your power output must not be more than 1 watt.</i> This is also the main working channel at most locks and drawbridges.</p>	5, 10, 13, 74, 77,



Canadian Marine VHF Channels

Type of Message	Appropriate Channel(s)
BOATER CALLING CHANNEL Use this channel for calling other leisure ships	9
DIGITAL SELECTIVE CALLING Is available for Digital Selective calling only and is not available for voice transmissions.	70
MARIME SUPPORT OPERATIONS	72, 73
CANADIAN COAST GUARD These channels are reserved for use by the Canadian Coast Guard only	19, 22, 81, 82, 83

Footnotes to table:

1. Pacific Coast only.
2. Great Lakes only.
3. East Coast only.
4. Pacific Coast, Inland Waterways of British Columbia and the Yukon only.
5. Pacific Coast and Lake Winnipeg only.
6. Pacific Coast, Atlantic Coast and Great Lakes only.
7. St. Lawrence River, power limited to 1 watt.

Note: *Operators should check order of preference for channel use with local information for chosen area of operation.*

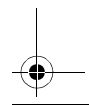
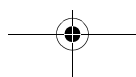
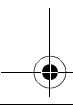
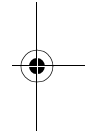
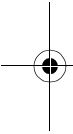

National Channels

Country	Channel Designation	Channel use
United Kingdom	M1	Pleasure Boat
	M2	Pleasure Boat
Denmark	L1	Pleasure Boat
	L2	Pleasure Boat
Finland, Norway & Sweden	L1	Pleasure Boat
	L2	Pleasure Boat
	L3	Pleasure Boat
Netherlands	31	NL Marina
	37	UK Marina
Denmark, Finland, Norway & Sweden	F1	Fishing Boat
	F2	Fishing Boat
	F3	Fishing Boat

These National channels have been allocated for the specific use within those countries listed. To use them you must have the appropriate license and your Ray240 must be programmed by an authorized Raymarine dealer to use the national channels that are approved for your country.

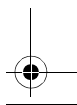
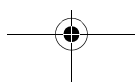
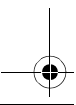
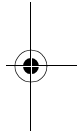
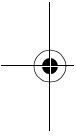
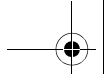



Appendix B: Technical specification

Transmitter

Channels	All available US, International and Canadian VHF Marine Band
Frequency Stability	± 1.5 kHz
Frequency Range	155.000 - 165.000 MHz
Channel Spacing	25 kHz
Power Output	25 W / 1 W
Modulation	Frequency modulation
Modulation Audio Response	+1 to -30dB of 6db/ octave 300 Hz to 3000 Hz
FM Hum & Noise level	< -40 dB
Audio Distortion	< 10%
Spurious & Harmonic (25W)	better than 80 dB
Antenna Impedance	50 ohms

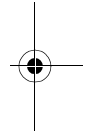
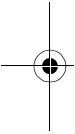

Receiver

Channels	All available US, International and Canadian VHF Marine Band
Frequency Range	155.000 - 165.000 MHz
Frequency Stability	± 1.5 kHz
Usable Sensitivity (20dB) SINAD	<0.4 μ V
Squelch Sensitivity	<0.2 μ V
Adjacent Channel Rejection	> 70 dB
Spurious Image Rejection	> 70 dB
Inter modulation Rejection	> 68 dB

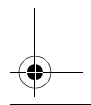
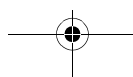
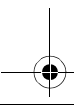

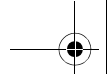

Audio Output (active speaker)	5W
Audio distortion	< 5%
Hum & Noise in Audio	< -40 dB

Hailer

Output (4 ohms)	22W
-----------------	-----

Operating requirements

Input Voltage	12V nominal (10.8 to 15.6)
Current 25W @ 13.8V transmit	<6 amps
Temperature Range	-4° F to + 122° F (-15° C to +50° C)
Water Protection	Handset - submersible Active speaker - submersible Transceiver unit - drip resistant



Appendix C: Hints and Tips

Phonetic Alphabet

To help make call letters more clearly understood, and to assist in spelling out similar sounding or unfamiliar word, radiotelephone users employ the international phonetic alphabet.

A	ALPHA	N	NOVEMBER
B	BRAVO	O	OSCAR
C	CHARLIE	P	PAPA
D	DELTA	Q	QUEBEC
E	ECHO	R	ROMEO
F	FOXTROT	S	SIERRA
G	GOLF	T	TANGO
H	HOTEL	U	UNIFORM
I	INDIA	V	VICTOR
J	JULIET	W	WHISKEY
K	KILO	X	X-RAY
L	LIMA	Y	YANKEE
M	MIKE	Z	ZULU

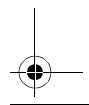
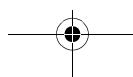
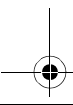
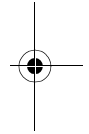
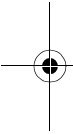



Prowords

Prowords can be used to simplify and speed up radio communications.

Proword	Meaning
ACKNOWLEDGE	Have you received and understood?
CONFIRM	My version is..... is that correct?
CORRECTION	An error has been made; the correct version is.....
I SAY AGAIN	I repeat.... (e.g. important words)
I SPELL	What follows is spelt phonetically
OUT	End of work
OVER	I have completed this part of my message, and I am inviting you to reply
RECEIVED	Receipt acknowledged
SAY AGAIN	Repeat your message (or the part indicated)
STATION CALLING	Used when a station is uncertain of the identity of a station which is calling

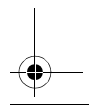
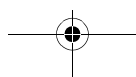
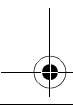
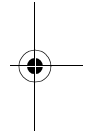
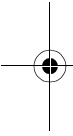



Appendix D: List Of Abbreviations

Abbreviation Meaning

A	Amperes
ATIS	Automatic Transmission Identification System
dB	Decibels
dc	Direct Current
DSC	Digital Selective Calling
DTMF	Dual Tone Multi-Frequency
EMC	Electromagnetic Compatibility
EME	Electromagnetic Energy
FCC	Federal Communications Commission
GMDSS	Global Maritime Distress and Safety System
GPS	Global Positioning System
Hz	Hertz
kHz	Kilo Hertz
LCD	Liquid Crystal Display
MHz	Mega Hertz
mm	millimeters
MMSI	Maritime Mobile Service Identity
NMEA	National Marine Electronics Association
NOAA	National Oceanographic and Atmospheric Administration
PTT	Push To Talk
RF	Radio Frequency
RX	Receiver
SWR	Standing Wave Ratio
TX	Transmit

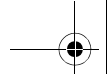

Abbreviation Meaning

UK	United Kingdom
V	Volts
VHF	Very High Frequency

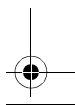
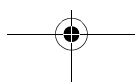
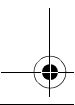
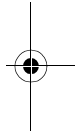
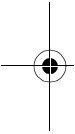

Limited Warranty Certificate - VHF Products

In order to ensure that the equipment continues to operate efficiently and reliably, we recommend that before using the product, the customer carefully read the Owner's handbook and follow the advice on the safe and correct operation and use of the product. We recommend that Raymarine equipment, be installed by an approved Raymarine installer.

Warranty Registration

Please register your warranty on-line at www.raymarine.com to ensure smooth warranty processing.

1. Limited Product Warranty

Raymarine warrants that all of its product, in the course of normal use, will be free from defects in material and workmanship for a period of 3 years (36 months) from date of sale to the original end user, subject to the limitations set forth in this warranty. The Raymarine warranty covers the parts and labor associated with a warranty repair as described above, provided that the product is returned to Raymarine or one of its approved agents in accordance with Section 3 hereof.

2. On-board Warranty

Raymarine will authorize on-board warranty service by the nearest Raymarine approved service agent, subject to maximum mileage and travel times referred to in Section 4, on products where *proof of installation, or commission by Raymarine certified installers is shown.*

In the case of a product installed by a Raymarine certified installer or boat-builder, the warranty commences on date of installation or from the date of sale of the boat to the original end user, subject to the limitations set forth in this warranty.

3. Obtaining Warranty Service

In the event of warranty service being necessary, the customer should contact Raymarine Technical Support or the nearest Raymarine approved service agent, the contact details of whom are available on the Internet at www.raymarine.com or directly from Raymarine.

In cases where the customer is requesting a warranty service on a Raymarine product under this warranty, and where a Raymarine certified installer has not installed the product; i.e. *Limited Product Warranty*, the affected product must be returned to the customers local Raymarine approved service agent or direct to Raymarine with a copy of either:

- (a) Proof of purchase showing the date of purchase, the name of the seller and the serial number of the affected product; or
- (b) A warranty card completed by the seller of the product containing the information required in (a) above.

In cases where the customer is making a warranty claim on a Raymarine product under this warranty, and where the product has been installed by a Raymarine certified installer, (boat-builder, installer dealer etc.) i.e. On-board Warranty, the nearest Raymarine approved service agent should be contacted and on-board service requested (which will be subject to the mileage and travel time limits referred to in



Section 4 hereof). Before the installed warranty service is performed, the customer must have available, either:

- (a) Proof of purchase showing the date of purchase, the name of the seller and the serial number of the affected product and proof of installation by a Raymarine certified installer; or
- (b) A warranty card completed by the seller of the product containing the information required in (a) above.

Subject to the limitations and other provisions set forth in this warranty, the product will be either repaired or replaced by Raymarine within a reasonable period of time and at no further cost to the customer. The determination of whether to repair or replace a product shall be at the sole discretion of Raymarine, and shall be the sole remedy of the customer under this warranty.

4. Warranty Limitations

Raymarine warranty does not apply to equipment that has been subjected to accident, abuse or mis-use, shipping damage, alterations, corrosion, incorrect and/or non-authorized service, or to a product on which the serial number has been altered, mutilated or removed.

Raymarine assumes no responsibility for damage incurred during installation or as a result of incorrect installation.

This warranty does not cover routine system checkouts, alignment or calibration, sea-trials or commissioning, unless required by replacement of part(s) in the area being aligned.

Hailer horns, external speaker and accessories are warranted for 1 year (12 months) from date of sale. These items must be returned to a Raymarine facility.

Raymarine is not liable and assumes no responsibility for damage caused by or to other equipment, systems or components occasioned by improper or unauthorized connection, or use of the product.

Consumable items, including, but not limited to; fuses, batteries, lamps are specifically excluded from this warranty.

Overtime/premium labor portion of services outside of normal working hours is not covered by this warranty.

If repairs are necessary under the warranty, the affected product must be forwarded to a Raymarine facility or an approved Raymarine service agent, at the owners expense in a manner set forth in Section 3 hereof.

This warranty does not cover any differences in material, coloring or size between those alluded to in corporate advertising, literature or published on the Internet, which is not specifically objected to at the time of delivery.

Travel costs other than those qualifying for on-board warranty (up to a maximum of 100 auto miles, tolls and two (2) hours travel time), are specifically excluded from the warranty and shall be the responsibility of the customer. Costs, which are excluded from the coverage of this warranty, include, but are not limited to: taxi fares, launch fees, aircraft rental, subsistence, customs, shipping and communication charges etc.

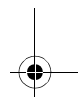
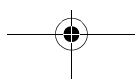
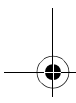
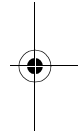
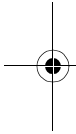



To the extent consistent with State and Federal Law:

The foregoing warranty is Raymarine's sole warranty and is applicable only to products sold as new. The remedies provided herein are in lieu of:

any and all other remedies and warranties, whether express or implied including but not limited to, any implied warranty of merchantability or fitness for a particular purpose.

all obligations of Raymarine for damages including, but not limited to accidental, consequential or special damages (including punitive or multiple), or any financial loss, loss of profit, business, contracts, opportunity, goodwill or other similar loss arising out of or in connection with the purchase, use or performance of any Raymarine product, even if Raymarine has been advised of the possibility of such damages, and no case shall exceed the cost of the product. The remedies to the customer are herein exclusive.

Some jurisdictions do not allow exclusion or limitation of incidental or consequential damages, so the above limitations or exclusions may not apply to you. This warranty gives you specific legal rights and you may also have other rights, which vary from jurisdiction to jurisdiction.

The Raymarine warranty terms and conditions as described herein do not affect the customer's statutory rights and comply with EU Directive 1999/44/EC.

Raymarine is the sole author of this policy and makes no further warranties, express or implied unless a separate, specific warranty has been written and provided to the customer. This warranty supersedes and replaces all previous warranties.

All Raymarine products are merely aids to navigation. It is the responsibility of the user to exercise discretion and proper navigational skill, independent of any Raymarine equipment.

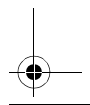
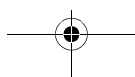
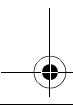
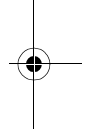
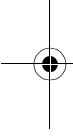

Raymarine

Factory Service Centers

United States of America

Raymarine Inc.
22 Cotton Road, Unit D,
Nashua, NH03063-4219, USA

Telephone: +1 603 881 5200
Fax: +1 603 864 4756
www.raymarine.com

Sales & Order Services

Telephone: +1 800 539 5539 Ext. 2333 or
+1 603 881 5200 Ext 2333

Technical Support

Telephone: +1 800 539 5539 Ext: 2444 or
+1 603 881 5200 Ext:2444
www.raymarine.com

Product Repair Centre

Telephone: +1 800 539 5539 Ext:2218

UK, Europe, Middle East, Far East

Raymarine Ltd.
Anchorage Park, Portsmouth
PO3 5TD, England

Telephone: +44 (0) 23 9269 3611
Fax: + 44 (0) 23 9269 4642
www.raymarine.com

Customer Support

Telephone: + 44 (0) 23 9271 4713
Fax: + 44 (0) 23 9266 1228
www.raymarine.com

Stick barcode label here

Purchased from

Purchase date

Dealer address

Installed by

Installation date

Commissioned by

Commissioning date

Owners name

Mailing address

This Portion should be completed and retained by the Owner

**WHY NOT SAVE TIME & EFFORT AND REGISTER YOUR PRODUCT WARRANTY at
www.raymarine.com**