

Chapter 25: Sirius audio application (North America only)

Chapter contents

- [25.1 Sirius audio overview on page 300](#)

25.1 Sirius audio overview

A connected, compatible Raymarine Sirius marine weather / satellite radio receiver can be controlled using the Sirius audio application.

Note: A Sirius subscription is required to enable use of a Sirius marine weather / satellite radio receiver.

To enable volume controls the Raymarine Sirius marine weather / satellite radio receiver also needs to be connected to a vessel entertainment system. Volume control is achieved using a combination of the multifunction display controls and the vessel entertainment system controls.

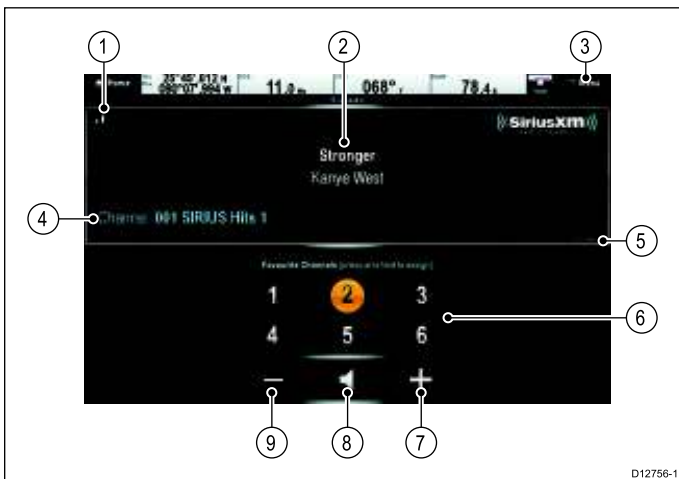

1	Signal strength (Between 0 and 3 bars).
2	Track name and Artist name.
3	Menu — The menu is used to browse available satellite radio channels.
4	Station details.
5	Sirius receiver ID.
6	Favorite channels.
7	Volume up.
8	Mute / Unmute.
9	Volume down.

The Sirius audio application can be used to:

- Browse available radio channels.
- Switch radio channel.
- Assign channels as favorites.
- Change the volume level.
- Mute the volume.

Note: Sirius satellite radio is only available in North America.

Accessing the Sirius audio application

1. Select the **Sirius Audio** page icon from the homescreen.

Changing the channel

You can view a list of available satellite radio channels and select the station you want to listen to.

From the Sirius Audio application:

1. Select **Menu**.
2. Select **Select channel**.

The Channel browser is displayed.



3. Select the relevant channel from the list.

Adding favorites

You can programme up to 6 favorite channels in the Sirius audio application. To save the current channel as a favorite follow the steps below.

1. Switch to the channel you want to save as a favorite.
2. When the channel is displayed onscreen select and hold on a favorite channel number (1 to 6) for 2 seconds.

The radio channel is now assigned as a favorite.

Using the volume controls

The Sirius audio application can be used to control the volume of your Sirius audio receiver.

With the Sirius audio application displayed:

1. Select the **Volume up** or **Volume down** icon to change the volume level, or
2. Select the **Mute icon** to mute and un-mute the audio.

Chapter 26: Mobile applications

Chapter contents

- [26.1 Raymarine mobile apps on page 302](#)
- [26.2 Enabling Wi-Fi on page 303](#)
- [26.3 Enabling mobile apps on page 303](#)
- [26.4 Setting up Wi-Fi security on page 304](#)
- [26.5 Selecting a Wi-Fi channel on page 304](#)

26.1 Raymarine mobile apps

Raymarine mobile apps enable viewing and control of your multifunction display via a compatible mobile device, using a Wi-Fi connection.

Raymarine currently offers the following mobile apps:

- **RayView**
- **RayRemote**
- **RayControl**

Note: Your multifunction display must have software version V3.15 or later in order to use mobile apps.

RayView

This app enables you to stream what you see on your multifunction display to a compatible smartphone or tablet device, using a Wi-Fi connection.

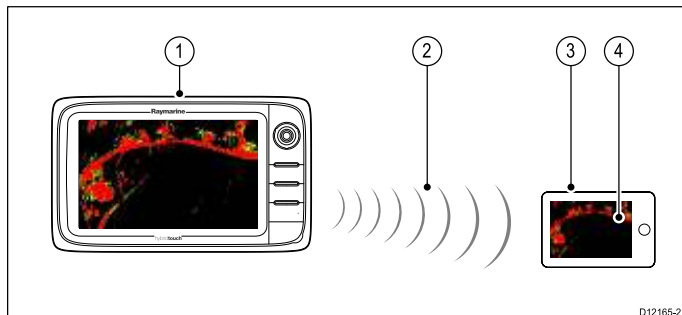

1. Multifunction display.
2. Wi-Fi connection (1 way – streaming only).
3. Compatible device.
4. “RayView” video streaming app.

RayControl

— This app enables you to stream and remotely control your multifunction display from a compatible tablet device, using a Wi-Fi connection.

Note: For safety reasons pilot controls and power button options are not available remotely.

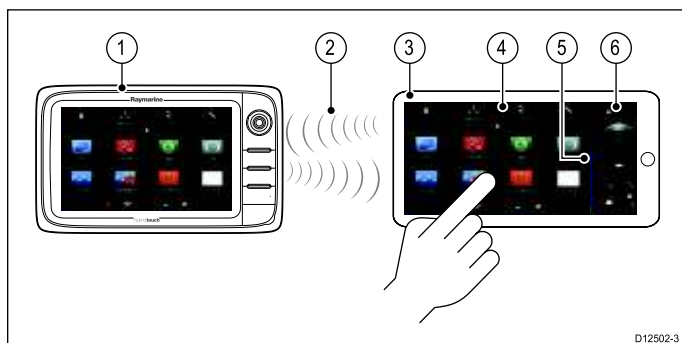

1. Multifunction display.
2. Wi-Fi connection (2 way – streaming and remote control).
3. Compatible tablet.
4. “RayControl” streaming and remote control app.
5. “RayControl” controls access (Touch the arrow to access controls).
6. “RayControl” remote controls

RayRemote

This app enables you to stream or control your multifunction display remotely from a compatible smartphone, using a Wi-Fi connection.

Note: RayRemote is able to switch between displaying the remote controls or the video stream.

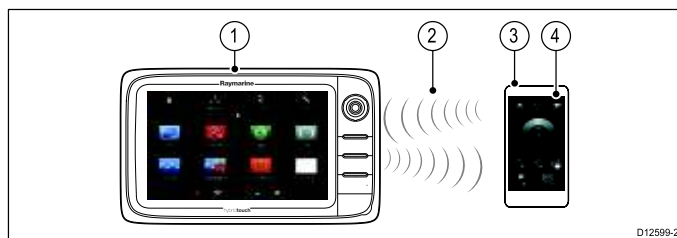

1. Multifunction display.
2. Wi-Fi connection (2 way – streaming or remote control).
3. Compatible smartphone.
4. RayRemote app

To use Raymarine mobile apps you must first:

- Download and install the required app from the relevant app store.
- Enable Wi-Fi in the System Settings on the multifunction display.
- Enable Wi-Fi on your compatible device.
- Select the Raymarine Wi-Fi connection from the list of available Wi-Fi networks on your compatible device.
- Enable the relevant type of connection (i.e. Viewing or Remote Control) in the System Settings on the multifunction display.

Mobile app compatibility

The Raymarine mobile apps are compatible with the following devices.

Device	Operating system
iPhone 4 or later	iOS
iPad 2 or later	iOS
Android smartphone	Android V2.2.2 or greater with 1GHz or greater processor
Android tablet	Android V2.2.2 or greater with 1GHz or greater processor
Kindle Fire	Android \ amazon

26.2 Enabling Wi-Fi

With the homescreen displayed:

1. Select **Set-up**.
2. Select **System Settings**.
3. Select **Wireless Connections**.
4. Select **Wi-Fi > ON**.

26.3 Enabling mobile apps

Raymarine mobile apps must be enabled on your multifunction display before you can stream video or remote control your multifunction display via a tablet or smartphone device.

With the homescreen displayed:

1. Select **Set-up**.
2. Select **System Settings**.
3. Select **Wireless Connections**.
4. Select **Mobile apps**.
5. Select **Viewing only** to enable video streaming only, or
6. Select **Remote Control** to enable remote control and video streaming using.
7. Launch the relevant Raymarine mobile app on your tablet or smartphone device and follow the on-screen instructions.

26.4 Setting up Wi-Fi security

You can encrypt the Wi-Fi connection on the multifunction display to prevent unauthorized devices from accessing the connection. The default encryption is WPA2.

With the homescreen displayed:

1. Select **Set-up**.
2. Select **System Settings**.
3. Select **Wireless Connections**.
4. Select **Wi-Fi > On**.
5. Select **Wi-Fi Name** and specify the SSID. This should be a memorable word and must be unique to each multifunction display in your system.
By default the SSID is the serial number of the multifunction display.
6. Select **Wi-Fi Security** and specify the type of encryption you want to use — None, WPA only, WPA2 only (default), or WPA/WPA2.

Note:

- Raymarine strongly recommends the use of the **WPA2** security setting.
- Selecting **None** for your Wi-Fi Security will leave your Wi-Fi open and allow anyone with a Wi-Fi enabled device access to your system.

7. It is recommended that the default **Wi-Fi Passphrase** is NOT changed.

Note: Once Wi-Fi security is set up on the multifunction display you must specify the same SSID and password credentials on your iPhone or iPad before wireless video streaming can be used.

Changing the default passphrase

It is recommended that the default passphrase is not changed, however if you do need to change the passphrase follow the steps below:

From the Wireless Connections menu: **Set-up > System Settings > Wireless Connections**

1. Select **Wi-Fi Passphrase**.
The on-screen keyboard will be displayed, showing the current passphrase.
2. Use **DEL** to delete the current passphrase.
3. Enter a new passphrase.

Note: Ensure the passphrase you choose is 'strong' by using a combination of upper/lower case letters, numbers and special characters. The passphrase can be between 8 and 63 characters in length with longer passphrases being more secure.

4. Select **SAVE** to save the new passphrase.

26.5 Selecting a Wi-Fi channel

By default the multifunction display automatically selects an available Wi-Fi channel. If you're experiencing difficulties with wireless video streaming it may be necessary to manually specify a Wi-Fi channel for both the multifunction display and the device you want to stream video to.

With the homescreen displayed:

1. Select **Set-up**.
2. Select **System Settings**.
3. Select **Wireless Connections**.
4. Select **Wi-Fi > On**.
5. Select **Wi-Fi Channel**.
6. Select one of the listed channels.

Chapter 27: Customizing your display

Chapter contents

- [27.1 Language selection on page 306](#)
- [27.2 Boat details on page 307](#)
- [27.3 Units set-up on page 308](#)
- [27.4 Time and Date set-up on page 309](#)
- [27.5 Display preferences on page 310](#)
- [27.6 Databar and databox overview on page 312](#)
- [27.7 List of data items on page 313](#)
- [27.8 System set-up menus on page 320](#)

27.1 Language selection

The system can operate in the following languages:

English (US)	English (UK)	Arabic
Bulgarian	Chinese	Croatian
Czech	Danish	Dutch
Finnish	French	German
Greek	Icelandic	Italian
Japanese	Korean	Norwegian
Polish	Portuguese (Brazilian)	Russian
Slovenian	Spanish	Swedish
Turkish		

With the Homescreen displayed:

1. Select **Customize**.
2. Select **Language**.
3. Select your language from the list of languages.

27.2 Boat details

You can customize various settings to make them specific to your vessel.

Menu item	Description	Options
Boat Type	<p>You can change the appearance of the vessel in the chart application. Select the option that most closely resembles the type and size of your vessel.</p> <div style="border: 1px solid black; padding: 5px; margin: 5px 0;"> <p>Note: When boat type is selected during the initial set up of the multifunction display the boat type shall determine the datapage configuration in the data application.</p> </div>	<ul style="list-style-type: none"> • Power Cruiser 1 (default) • Power Cruiser 2 • Power Cruiser 3 • Inboard Speed Boat • Outboard Speed Boat • Workboat • RIB • Sail Cruiser • Race Sail • Catamaran • Sport Fishing • Pro Fishing
Num. of Engines	Allows you to specify the number of engines your vessel has. This setting determines the number of engines shown in the engine data application.	• 1 to 5
Num. of Fuel Tanks	Allows you to specify the number of fuel tanks your vessel has. This setting determines the number of fuel tanks available in the Data application.	• 1 to 5
Num. of Batteries	Allows you to specify the number of batteries your vessel has. This setting determines the number of batteries available in the Data application.	• 1 to 5
Total Fuel Capacity	Allows you to specify the total fuel capacity of your vessel, this is required in order to enable the fuel manager function.	• 0 to 9999 units.

Customizing the vessel icon

With the homescreen displayed:

1. Select **Customize**.
2. Select **Boat Details**.
3. Select **Boat Type**.
4. Select the icon that most closely resembles your vessel type and size.

27.3 Units set-up

You can specify your preference for the units of measurement that will be used in all applications.

Menu item	Description	Options
Distance Units	The units of measure that will be used in all applications for the display of all values related to distance.	<ul style="list-style-type: none"> • Nautical Miles • NM & m (major units = Nautical Miles, minor units = meters) • Statute Miles • Kilometers
Speed Units	The units of measure that will be used in all applications for the display of all values related to speed.	<ul style="list-style-type: none"> • Knots • MPH (Miles Per Hour) • KPH (Kilometers Per Hour)
Depth Units	The units of measure that will be used in all applications for the display of all values related to depth.	<ul style="list-style-type: none"> • Feet • Meters • Fathoms
Temperature Units	The units of measure that will be used in all applications for the display of all values related to temperature.	<ul style="list-style-type: none"> • Fahrenheit • Celsius
Pressure Units	The units of measure that will be used in all applications for the display of all values related to pressure.	<ul style="list-style-type: none"> • Bar • PSI • Kilopascals
Volume Units	The units of measure that will be used in all applications for the display of all values related to volume.	<ul style="list-style-type: none"> • US Gallons • Imperial Gallons • Liters
Economy Units	The units of measure that will be used in all applications for the display of all values related to fuel usage.	<ul style="list-style-type: none"> • Distance per Volume • Volume per Distance • Liters per 100 km
Wind Speed Units	The units of measure that will be used in all applications for the display of all values related to wind speed.	<ul style="list-style-type: none"> • Knots • Metres per second

Specifying preferred units of measurement

1. Select **Customize**.
2. Select **Units Set-up**.
3. Select the type of measurement you want to change (for example, Distance Units).
4. Select the preferred type of unit (for example, Statute Miles).

27.4 Time and Date set-up

You can specify your preference for the way that time and date will appear in all applications.

Menu item	Description	Options
Date Format	Allows you to specify the preferred format for the display of date information in all applications.	<ul style="list-style-type: none">• MM:DD:YY (Month, Day, Year)• DD:MM:YY (Day, Month, Year)
Time Format	Allows you to specify the preferred format for the display of time information in all applications.	<ul style="list-style-type: none">• 12hr• 24hr
Local Time: UTC	Allows you to specify the local time zone that will be used, in terms of an offset from UTC (Universal Coordinated Time), in 0.5 hour increments.	<ul style="list-style-type: none">• -13 to +13 hours (in 0.5 hour increments)

27.5 Display preferences

You can specify your preference for general display behavior.

Menu item	Description	Options
Starting page	Allows you to select what page the display opens at start up.	<ul style="list-style-type: none"> • Homescreen (default) • Last page — After power up the last used page is displayed. • Choose page — After power up the page selected is displayed.
Key Beep	An audible sound can be made each time a button is pressed or the touchscreen is used.	<ul style="list-style-type: none"> • ON (default) • OFF
Cursor Autohide	If set to On, the cursor will be automatically hidden after a period of no movement. If set to Off, the cursor will persist on the screen until moved.	<ul style="list-style-type: none"> • ON • OFF (default)
Range Controls	<p>On New e Series and gS Series displays you can specify whether the Chart, Radar and Weather application display the onscreen range in and range out icons.</p> <div style="border: 1px solid black; padding: 5px;"> <p>Note:</p> <ul style="list-style-type: none"> • Onscreen range controls are not available on non-touchscreen displays. • Onscreen range controls cannot be hidden on touch only displays. </div>	<ul style="list-style-type: none"> • Show (default) • Hide
Context Menu	(Touchscreen displays only) Determines how the context menu is accessed using touch	<ul style="list-style-type: none"> • Touch (default) — touching a chart object opens the context menu. • Hold — Touch and holding on a chart object opens the context menu.
Pilot Control Bar	<p>Allows you to enable and disable the pilot bar on each display individually, when connected to an SPX or SeaTalk autopilot.</p> <div style="border: 1px solid black; padding: 5px;"> <p>Note: For evolution autopilots the Pilot Bar option is in the Pilot Set-up page.</p> </div>	<ul style="list-style-type: none"> • Shown • Hidden
Shared Brightness	You can set up shared brightness groups (or “zones”) to adjust the brightness on multiple units simultaneously.	<p>Share Brightness</p> <ul style="list-style-type: none"> • ON (default) • OFF <p>Brightness Group</p> <ul style="list-style-type: none"> • Helm 1 (default) • Helm 2 • Cockpit • Flybridge • Mast • Group 1 • Group 2 • Group 3 • Group 4 • Group 5
Screenshot File	<p>Enables you to specify the default memory card slot for screen capture images.</p> <div style="border: 1px solid black; padding: 5px;"> <p>Note: This option is only available on displays with multiple card reader slots.</p> </div>	<ul style="list-style-type: none"> • MicroSD 1 • MicroSD 2

Onscreen range controls

You can enable and disable onscreen range controls on New e Series and gS Series displays by following the steps below.

From the homescreen:

1. Select **Customize**.
2. Select **Display Preferences**.

3. Select **Range Controls**.

Selecting Range Controls will switch between showing and hiding the onscreen range controls.

Shared brightness

You can set up shared brightness groups to adjust the brightness on multiple units simultaneously.

The following units are compatible with shared brightness groups:

- New a Series
- New c Series.
- New e Series.
- gS Series
- i50
- i60
- i70
- p70 / p70R pilot controllers
- ST70
- ST70+

Once compatible units are added to a shared brightness group, any brightness adjustment made to any of the units in the group is also reflected in all other units in that group. An on-screen single brightness control is available for controlling any units in the brightness group:

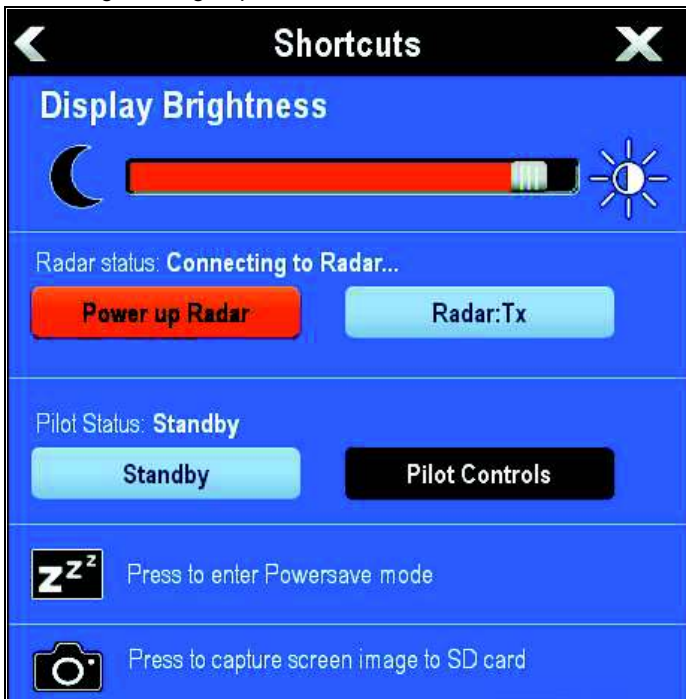

Multiple brightness groups can be configured. This can reflect the physical location of the units on your vessel if required. For example, the units at your helm can be set to one group, and the units on the flybridge can be set to a different group. In this example, any brightness adjustments made to a unit at the helm would be automatically reflected in the other units at the helm but not on the flybridge.

The shared brightness function requires the following:

- All units must be compatible with the shared brightness function (see list of compatible units above).
- Before a unit can respond to a shared brightness adjustment it must be assigned to the relevant **Brightness Group**.
- A single unit can only belong to one brightness group at any one time.
- The **Share brightness** setting must be set to On for all units in the brightness group.
- When setting up a brightness group an initial **Sync brightness** operation must be performed, with all the displays in that group powered on, to configure the display brightness of all units in the group.

Setting up shared brightness

With the homescreen displayed:

Customizing your display

1. Select **Customize**.
2. Select **Display Preferences**.
3. Select **Shared Brightness**.
4. Select the On option for the **Shared brightness** menu item.
5. Select **Brightness Group**.
6. Select an appropriate brightness group.
7. Repeat the process for the other displays you want in the brightness group. If the display is not a multifunction display, refer to the documentation that accompanies the unit for instructions on setting-up shared brightness.
8. Once all required displays have been added to the same brightness group, select **Sync Brightness** on the multifunction display.
A shared brightness message is displayed.
9. Ensure all displays in the brightness group are powered on.
10. Select **Sync**.
When completed a message is displayed confirming that shared brightness has been configured.

Once shared brightness has been successfully configured, changing the brightness of any display in that brightness group will automatically change the brightness of all displays in that group.

27.6 Databar and databox overview

You can customize the data displayed in the databar and onscreen databoxes.

Customizable data is displayed in the databar, extended databar (HybridTouch displays only) or databoxes. The databar, extended databar and databoxes are available in all applications.

These areas of the screen are illustrated and described below:

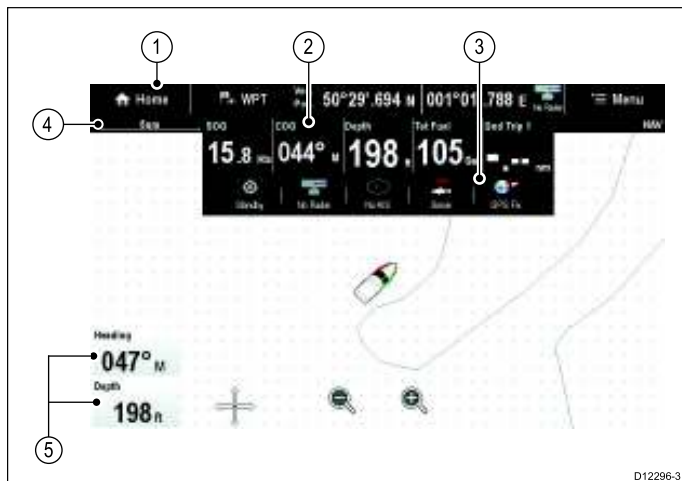

1. **Databar** — displayed at the top of the screen in all applications. The databar contains cells that can be customized to display data from a wide range of categories. The databar can also be hidden to provide
2. **Expanded Databar** — (Touchscreen displays only) displayed when you touch the databar. The extended databar can be displayed. The expanded databar is displayed until the screen is touched again.
3. **Status icons** — You can display the status icons below the expanded databar. This provides status information for externally connected equipment:
4. **Status Bar** — Permanently displayed in all applications. The status bar contains information on the currently selected settings of the application displayed onscreen.
5. **Databoxes** — up to 2 databoxes can be displayed. Each box can display one item of data from the available data categories. Data is permanently displayed onscreen.

The databar can be set to auto-hide so that only the Status bar is visible onscreen.

Auto-hide the databar

On multifunction displays that have a touchscreen, the databar that is displayed at the top of all applications pages can be set to auto-hide. This provides a larger screen area for the application pages.

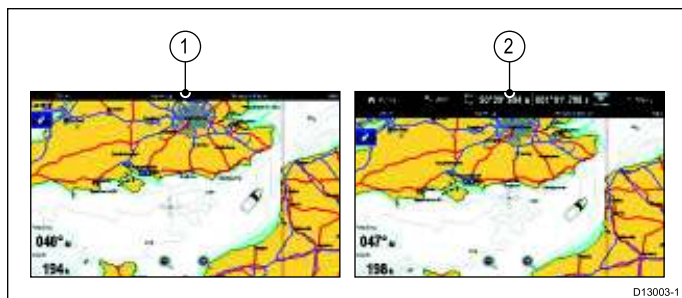

From the Homescreen:

1. Select **Customize**.
2. Select **Databar Set-up**.
3. Select **Auto-Hide** so that On is selected.

When viewing application pages the databar will now auto-hide after 10 seconds. You can view the databar again by touching the databar with your finger.

Customizing databoxes in the chart application

To switch databoxes on and off and to select data to display follow the steps below.

From the Chart application menu:

1. Select **Presentation**.
2. Select **Overlay**.
3. Select **Databoxes**.
4. Select **Databox 1 > On**.
5. Select **Databox 2 > On**.
6. Choose the **Select Data** option for the relevant databox.
7. Select the category that reflects the type of data you want to display in the databox. For example, Depth data.
8. Select the data item.
The data you selected is displayed onscreen in the appropriate databox.

Customizing Databoxes

In the Radar, Fishfinder, or Weather application:

1. Select **Menu**.
2. Select **Presentation**.
3. Select **Databoxes**.
4. Select **Databox 1 > ON**.
5. Select **Databox 2 > ON**.
6. Choose the **Select Databox 1** or **Select Databox 2** menu item, as appropriate.
7. Select the category that reflects the type of data you want to display in the databox. For example, Depth data.
8. Select the data item.
The data you selected is displayed onscreen in the appropriate databox.

Customizing the databar

From the homescreen:

1. Select **Customize**.
2. Select **Databar Set-up**.
3. Select **Edit Databar**.
4. In the databar, select the cell that you want to change.
The Select Data Category menu will be displayed.
5. Select the category that reflects the type of data you want to display in the cell. For example, Depth data.
6. Select the data item.
The data you selected is displayed on-screen in the appropriate cell.
7. Select **Home** or **Back** when completed.

Displaying status icons in the databar

Touchscreen multifunction displays enable you to display status icons in the databar.



























From the homescreen:















































1. Select **Customize**.
2. Select **Databar Set-up**.
3. Select **Status Icon Bar** so that On is highlighted.
The status icons are now displayed below the expanded databar.

































27.7 List of data items































Categories of data available to display in the data application, databoxes, databar, and expanded databar are shown below. Dial graphics are not available in databoxes or databars.





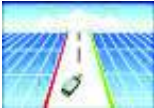



































The following table shows the data items available by category.



































Data Category	Description	Data Item	Data application Graphics			
Battery**	Battery status	Battery Amps				
		Battery Temperature				
		Battery Voltage				
Boat	Types of data generated by your vessel. For example, tank levels.	Rate of Turn				
		Heel Angle				
		Trim Tabs (Data application only.)				
Depth	Depth data.	Depth				
		Maximum Depth				
		Minimum Depth				
Distance	Types of data related to distance travelled by your vessel. For example, trip distance.	Log & Trip				
		Log				
		Trip				
		Ground Log and Trip				
		Ground Log				
		Ground Trip 1				
		Ground Trip 2				
		Ground Trip 3				
		Ground Trip 4				











Data Category	Description	Data Item	Data application Graphics			
Engine**	Types of data generated by engines. For example, oil pressure.	RPM				
		RPM & Speed				
		Coolant Temperature				
		Coolant Pressure				
		Oil Temperature				
		Oil Pressure				
		Oil Pressure & Coolant Temperature				
		Transmission Oil Temperature				
		Transmission Oil Pressure				
		Transmission Gear				
		Boost Pressure				
		Fuel Pressure				
		Fuel Flow Rate				
		Fuel Flow (Inst)				
		Fuel Flow (Avg)				
		Engine Hours				
		Engine Trim				
		Alternator				
Engine Load						

Data Category	Description	Data Item	Data application Graphics			
Fuel**	Types of data related to the fuel system. For example, fuel levels.	Fuel Level (%)				
		Total Fuel (vol)				
		Fuel Flow Total				
		Economy				
		Estimated Fuel Remaining				
		Distance to Empty				
		Time to Empty				
		Fuel Used (Trip)				
		Fuel Used (Season)				
Environment	Environmental-related data. For example, air temperature.	Pressure				
		Air Temperature				
		Minimum Air Temperature				
		Maximum Air Temperature				
		Drift				
		Set				
		Set & Drift				
		Apparent Wind Chill				
		True Wind Chill				
		Humidity				
		Dew Point				
		Sunset / Sunrise				
		Water Temperature				
		Minimum Water Temperature				

Data Category	Description	Data Item	Data application Graphics				
		Maximum Water Temperature					
GPS	GPS-related data. For example, vessel position.	Vessel Position					
		COG & SOG					
		COG					
		SOG					
		Maximum SOG					
		Average SOG					
Heading	Heading-related data. For example, locked heading.	Heading					
		Heading and Speed (Data application only.)					
		Locked Heading					
		Locked Heading Error					
		LH Error and LH (Data application only.)					
		Tack Heading					
		Compass (Data application only.)					
Navigation	Types of data related to navigation. For example, bearing to waypoint.	Cursor Position (Only available in the Databar and data overlay.)					
		Cursor info (Only available in the Databar and data overlay.)					
		Cross Track Error					
		Rolling Road (Data application only.)					
		Waypoint Info					
		Active Waypoint Name					
		Target Position					

Data Category	Description	Data Item	Data application Graphics			
		Bearing to Waypoint				
		BTW & DTW (Data application only.)				
		Course Made Good				
		CMG & DMG				
		CMG & VMG (Data application only.)				
		Distance to Waypoint				
		Distance Made Good				
		Waypoint ETA				
		Waypoint TTG				
		Route ETA				
		Route TTG				
		Pilot	Pilot-related data. For example, rudder.	Rudder Angle		
Speed	Speed-related data. For example, VMG (Velocity Made Good) to Waypoint.	Speed				
		Maximum Speed				
		Average Speed				
		Speed and SOG				
		VMG to Windward				
		VMG to Waypoint				
Tanks**	Data related to water tanks	Fresh Water (%)				
		Grey Water (%)				
		Black Water (%)				
		Live Well (%)				

Data Category	Description	Data Item	Data application Graphics			
Time	Time-related data. For example, local time.	Local Time				
		Local Date				
Wind	Wind-related data. For example, VMG (Velocity Made Good) to Windward.	AWA				
		Maximum AWA				
		Minimum AWA				
		AWS				
		Maximum AWS				
		Minimum AWS				
		TWA				
		Maximum TWA				
		Minimum TWA				
		TWS				
		Maximum TWS				
		Minimum TWS				
		TWD				
		Cardinal Wind				
		Ground Wind				
		Beaufort				
		AWA and TWA				
		AWA & AWS				
		AWA (CH) and AWS				
		AWA and VMG				

Data Category	Description	Data Item	Data application Graphics			
		TWA & TWS				
		TWA (CH) and TWS				
		TWA and VMG				
		GWD and Beaufort				
		GWD & GWS				
None						

Note: *Dials and graphical representations are only available from the Data application. Databar and data cell overlays can only display digital items.

Note: **The Battery, Engine, Fuel and Tanks menus will display 1 set of data items per configured device (e.g. if the system has been configured with 3 engines then 3 sets of engine data items will be displayed).

27.8 System set-up menus

The system set-up menus enable you to configure your display and connected external devices.

The following menus are available:

Menu item	Description	Notes
Touch-Lock	<p>Enables you to lock the touchscreen of a touch only display when the display is paired with a remote keypad.</p> <div style="border: 1px solid black; padding: 2px; margin-bottom: 5px;"> <p>Note: This option is not available on touch-only displays which do not have a remote keypad connected.</p> </div> <div style="border: 1px solid black; padding: 2px;"> <p>Note: This option is not available on displays which have physical buttons.</p> </div>	<ul style="list-style-type: none"> • ON • OFF (default)
Alarms	Enables you to configure all the different types of alarms produced by the display and connected equipment.	
Fuel Manager	Displays the Fuel manager page	
Pilot Controls	Displays the Pilot Control dialog.	Only available when a Raymarine autopilot is detected on the system and Autopilot Control is set to On.
Pilot Response	<p>Enables selection of the pilot response level when connected to an Evolution autopilot.</p> <div style="border: 1px solid black; padding: 2px;"> <p>Note: Pilot Response is not available on SPX and SeaTalk autopilots.</p> </div>	<ul style="list-style-type: none"> • Leisure • Cruise • Performance
Audio Controls	<p>Displays the audio controls pop-up.</p> <div style="border: 1px solid black; padding: 2px;"> <p>Note: Not available on non-touch displays.</p> </div>	Only available when connected to an audio device via bluetooth.
Ground Trip Resets	Resets the chosen ground trip distance counter to zero.	
System Settings	Enables you to configure the settings for external devices connected to the display.	
Maintenance	Provides diagnostic information. Also enables you to designate the data master and reset the display to factory settings.	

Alarms menu

Menu item	Description	Options
MOB Data Type	Determines whether Position or Dead Reckoning (DR) data is displayed. Assuming that your vessel and the MOB are subject to the same tide and wind effects, the Dead Reckoning setting normally gives a more accurate course.	<ul style="list-style-type: none"> • Dead Reckoning • Position (default)
Alarm Clock	When set to On, an alarm is triggered at the time you specify for the Alarm Clock Time setting.	<p>Alarm Clock</p> <ul style="list-style-type: none"> • Off (default) • On <p>Alarm Clock Time</p> <ul style="list-style-type: none"> • 00:00 (default) • 00.01 to 24:00 hrs
Anchor Drift	When set to On, the Anchor Drift alarm is triggered when your vessel drifts from your anchor position by more than the distance you specify for the Anchor Drift Range setting.	<p>Anchor Drift</p> <ul style="list-style-type: none"> • Off (default) • On <p>Anchor Drift Range</p> <ul style="list-style-type: none"> • 0.01 — 9.99 nm (or equivalent units)
Countdown Timer	When set to On, counts down the time period you specify for the Timer Period setting, and triggers an alarm when zero is reached.	<p>Countdown Timer</p> <ul style="list-style-type: none"> • Off (default) • On <p>Timer Period</p> <ul style="list-style-type: none"> • 00h00m (default) • 00h01m to 99h59m
AIS Targets	When set to On, the alarm for Dangerous Targets is enabled. This option is only available when an AIS unit is detected. Refer to the AIS section for details.	<p>Dangerous Targets</p> <ul style="list-style-type: none"> • On (default) • Off
Engine Alarms	When set to On then warning alarms from connected engine management systems will be displayed on the multifunction display.	<p>Engine Alarms</p> <ul style="list-style-type: none"> • On (default) • Off
Fishfinder Deep	<p>If this option is set to On, an alarm is triggered when the depth exceeds the value that you specify. This option is only available when a sonar module is detected.</p> <div style="border: 1px solid black; padding: 5px; margin-top: 10px;"> <p>Note: The Fishfinder Deep alarm limit cannot be set to a value less than the Shallow Limit.</p> </div>	<p>Fishfinder Deep</p> <ul style="list-style-type: none"> • Off (default) • On <p>Deep Limit</p> <ul style="list-style-type: none"> • 2 ft (or equivalent units) to the maximum of the transducer range
Fishfinder Shallow	<p>If this option is set to On, an alarm is triggered when the depth drops below the value that you specify. This option is only available when a sonar module is detected.</p> <div style="border: 1px solid black; padding: 5px; margin-top: 10px;"> <p>Note: The Fishfinder Shallow alarm limit cannot be set to a value greater than the Deep Limit.</p> </div>	<p>Fishfinder Shallow</p> <ul style="list-style-type: none"> • Off (default) • On <p>Shallow Limit</p> <ul style="list-style-type: none"> • 2 ft (or equivalent units) to the maximum of the transducer range
Fish	<p>If the Fish alarm and fish depth limits alarm are set to On, a warning sounds is triggered if any target meets the sensitivity level and is within the Shallow Fish Limit and Deep Fish Limit that you specify. The following items are available in the sub-menu:</p> <ul style="list-style-type: none"> • Fish — Switches fish alarm On and Off. • Fish Sensitivity — If the Fish alarm is set to On, an alarm is triggered when the fish return strength reaches the sensitivity that you specify. • Fish Depth Limits — Switches depth limits On and Off. • Shallow Fish Limit — Specifies the lower value for the Fish Alarm Depth Limit. 	<p>Fish</p> <ul style="list-style-type: none"> • Off (default) • On <p>Fish Sensitivity</p> <ul style="list-style-type: none"> • 1 to 10 <p>Fish Depth Limits</p> <ul style="list-style-type: none"> • On • Off (default) <p>Shallow Fish Limit</p>

Menu item	Description	Options
	<ul style="list-style-type: none"> • Deep Fish Limit — Specifies the upper value for the Fish Alarm Depth Limit. 	<ul style="list-style-type: none"> • 2 ft (or equivalent units) to the maximum of the transducer range <p>Deep Fish Limit</p> <ul style="list-style-type: none"> • 2 ft (or equivalent units) to the maximum of the transducer range
Fuel Manager	In the fuel manager alarm options you can switch the low fuel warning alarm on or off and specify the fuel level at which the alarm is triggered.	<p>Low Fuel</p> <ul style="list-style-type: none"> • On • Off (default) <p>Fuel Level</p> <ul style="list-style-type: none"> • 0 to 99999
Guard Zone	The Guard Zone feature in the radar application triggers an alarm when a target is within a specified zone. You can adjust the sensitivity of the alarm. Ensure that the sensitivity is not set too low, or targets may be missed and the alarm will not be triggered.	<p>Guard Zone Sensitivity</p> <ul style="list-style-type: none"> • 1% to 100%
Off Track	When set to On, during active navigation an alarm is triggered when your vessel steers off-track more than the value you specify for the Off Track XTE setting.	<p>Off Track Alarm</p> <ul style="list-style-type: none"> • Off (default) • On <p>Off Track XTE</p> <ul style="list-style-type: none"> • 0.01 to 9.99 nm (or equivalent units)
Water Temperature	When set to On, triggers an alarm when the water temperature is equal to or lower than the limit you specify for the Lower Temp Limit or equal to or greater than the limit you specify for the Upper Temp Limit setting.	<p>Water Temperature</p> <ul style="list-style-type: none"> • Off (default) • On <p>Lower Temp Limit</p> <ul style="list-style-type: none"> • 60 degrees fahrenheit (or equivalent units) • -09.9 to +99.7 degrees fahrenheit (or equivalent units) <p>Upper Temp Limit</p> <ul style="list-style-type: none"> • 75 degrees fahrenheit (or equivalent units) • -09.7 to 99.9 degrees fahrenheit (or equivalent units)
Waypoint Arrival	When you arrive at a waypoint, an alarm is triggered. This setting allows you to specify the distance from the target waypoint at which the alarm is triggered. The units used for this setting are based on the units you specify for distance in the Units Set-up menu.	0.01 to 9.99 nm (or equivalent units)

Ground trip resets menu

This menu enables you to reset the chosen ground trip distance counter to zero.

Menu item	Description
Ground Trip 1 Reset	Resets the ground trip 1 distance counter to zero.
Ground Trip 2 Reset	Resets the ground trip 2 distance counter to zero.
Ground Trip 3 Reset	Resets the ground trip 3 distance counter to zero.
Ground Trip 4 Reset	Resets the ground trip 4 distance counter to zero.

System settings menu

Menu item	Description	Options
Autopilot Control	Enables and disables autopilot controls from your multifunction display.	<ul style="list-style-type: none"> On Off
DSC Alerts	Enables and disables DSC radio alerts on your multifunction display.	<ul style="list-style-type: none"> On Off
GPS Set-up	Provides GPS setting options.	<ul style="list-style-type: none"> View Satellite Status Differential GPS COG/SOG Filter Restart GPS
Internal GPS	Switches the multifunction displays internal GPS On or Off. Note: The Internal GPS option is not available on the e165 multifunction display.	<ul style="list-style-type: none"> On Off
Data Sources	Enables selection of preferred sources of data for connected equipment. Note: The Data Sources menu is only available on displays set as Data Master.	<ul style="list-style-type: none"> GPS GPS Datum Time and Date Heading Depth Speed Wind
External Devices	Enables set-up of compatible externally connected devices.	Refer to the <i>External devices menu</i> section of the manual.
Wireless Connections	Provides access to the Wi-Fi and bluetooth connection options.	Refer to the <i>Wireless connections menu</i> section of the manual.
NMEA Set-up	Enables you to configure settings for NMEA devices.	Refer to the <i>NMEA set-up menu</i> section of the manual.
System Preferences	Enables you to configure system settings	Refer to the <i>System preferences menu</i> section of the manual.
Simulator	Switches simulator mode On or Off.	<ul style="list-style-type: none"> Off On On (Demo movie)

GPS setup

The GPS setup options enable you to configure a GPS receiver.

The Global Positioning System (GPS) is used to position your vessel on the chart. You can set up your GPS receiver and check its status from the GPS Status option in the **System Settings** menu. For each tracked satellite, the screen provides the following information:

- Satellite number.
- Signal strength bar.
- Status.
- Azimuth angle.
- Elevation angle.
- A sky-view to show the position of tracked satellites.

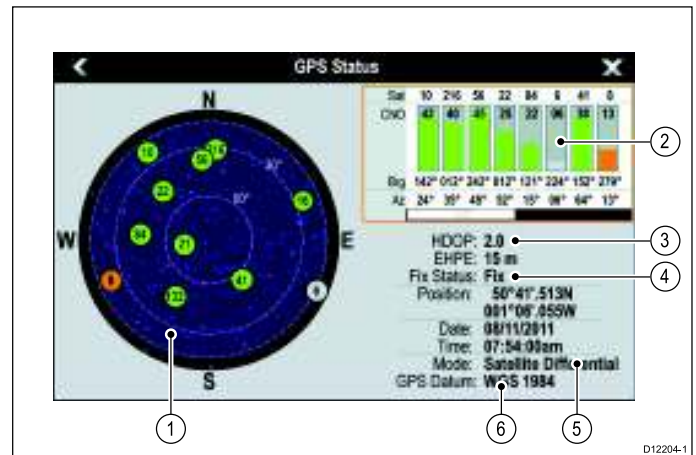

Item	Description
1	Sky view — a visual representation of the position of tracked satellites.
2	Satellite status — displays the signal strength and status of each satellite identified in the sky view diagram on the left of the screen. The colored bars have the following meanings: <ul style="list-style-type: none"> Grey = searching for satellite. Green = satellite in use. Orange = tracking satellite.
3	Horizontal Dilution of Position (HDOP) — a measure of GPS accuracy, calculated from a number of factors including satellite geometry, system errors in the data transmission and system errors in the GPS receiver. A higher figure signifies a greater positional error. A typical GPS receiver has an accuracy of between 5 and 15 m. As an example, assuming a GPS receiver error of 5 m, an HDOP of 2 would represent an error of approximately 15 m. Please remember that even a very low HDOP figure is NO guarantee that your GPS receiver is providing an accurate position. If in doubt, check the displayed vessel position in the chart application against your actual proximity to a known charted object. Estimated Horizontal Position Error (EHPE) — a measure of GPS accuracy, this indicates that your position is within a circle radius of the stated size 67% of the time.
4	Fix status — indicates the actual mode the GPS receiver is reporting (No Fix, Fix, D Fix or SD Fix).
5	Mode — the mode currently selected by the GPS receiver.
6	Datum — The GPS receiver's datum setting affects the accuracy of the vessel position information displayed in the chart application. In order for your GPS receiver and multifunction display to correlate accurately with your paper charts, they must be using the same datum.

The accuracy of the GPS receiver depends on the parameters detailed above, especially the azimuth and elevation angles which are used in triangulation to calculate your position.

Multiple data sources (MDS) overview

Installations that include multiple instances of data sources can cause data conflicts. An example is an installation featuring more than one source of GPS data.

MDS enables you to manage conflicts involving the following types of data:

- GPS Position.
- Heading.
- Depth.
- Speed.
- Wind.

Typically this exercise is completed as part of the initial installation, or when new equipment is added.

If this exercise is NOT completed the system will automatically attempt to resolve data conflicts. However, this may result in the system choosing a source of data that you do not want to use.

If MDS is available the system can list the available data sources and allow you to select your preferred data source. For MDS to be available all products in the system that use the data sources listed above must be MDS-compliant. The system can list any products that are NOT compliant. It may be necessary to upgrade the software for these non-compliant products to make them compliant. Visit the Raymarine website (www.raymarine.com) to obtain the latest software for your products. If MDS-compliant software is not available and you do NOT want the system to automatically attempt to resolve data conflicts, any non-compliant product(s) can be removed or replaced to ensure the entire system is MDS-compliant.

Data sources menu

This menu enables you to select the external sensors and devices that will provide data to the display.

Auto / manual selection

Each dialog enables you to view and select your preferred data source. selection of data source can be manual or set to automatic:

- **Auto** — the display will automatically select a device and attempt to resolve any data conflicts that may occur where there is more than one source of data for that particular data source (for example, multiple GPS receivers).
- **Manual** — once the display has performed a search for connected devices you can manually select the preferred device from the list.

Note: Selecting the **Auto** option may result in the system choosing a source of data that you do not want to use.

Device selection

Menu item	Description
GPS	Enables you to search for any externally-connected GPS devices, and select the one you want to use.
GPS Datum	In order for your GPS receiver and multifunction display to correlate accurately with your paper charts, they must be using the same datum. This option enables you to choose the data source for this datum.
Time and Date	Enables you to select the device you want to use for the time and date information used by the display.
Heading	Enables you to select the device you want to use for heading data.
Depth	Enables you to select the device you want to use for depth data.
Speed	Enables you to select the device you want to use for speed data.
Wind	Enables you to select the device you want to use for wind data.

External devices menu

This menu enables you to configure the external devices connected to the display.

Menu item	Description	Notes
Pilot Set-up	When connected to an Evolution autopilot this option allows you to enable and disable pilot control and the pilot bar. You can also access certain pilot settings and modes.	
Fishfinder Set-up	Enables you to select an external transducer and configure the options for the unit, such as depth offset. Also enables you to configure the options for an internal or external sonar module.	For an explanation of these options refer to the <i>Transducer set-up menu options</i> described in the Fishfinder section of this document.
Radar Set-up	Enables you to make radar scanner adjustments, such as tune adjust and time transmit.	For an explanation of these options refer to the <i>Radar set-up menu options</i> described in the Radar section of this document.
AIS Unit Set-up	Enables you to configure additional functions for AIS units, such as Silent Mode. This menu item is only available when an AIS unit is detected or when Simulator mode is On.	For an explanation of these options refer to the <i>AIS menu options</i> described in the AIS section of this document.
Remote Control	Enables you to customize certain controls for Raymarine Bluetooth remote control units (for example, RCU-3).	For an explanation of these options refer to the <i>Remote Control</i> section of this document.
Transducers Set-up	Displays a list of connected transducers which you can select and calibrate.	
Weather Set-up	Enables you to select the bus your weather receiver is connected to: <ul style="list-style-type: none"> • SeaTalk^{hs} • SeaTalk^{ng} 	
Switch Panel Set-up	Enables you to install and uninstall Switch Panel configuration files.	
External Keypad	Enables you to pair and unpair remote keypads.	
Engines Set-up	Enables you to run the engine identification wizard	For an explanation of these options refer to <i>Engine identification wizard</i> section of this document.

Connections menu

This menu enables you to connect wireless Bluetooth and Wi-Fi devices to the display.

Menu item	Description	Options
Bluetooth	Enable or disable Bluetooth on the display.	<ul style="list-style-type: none"> • On • Off (default)
Wi-Fi	Enable or disable Wi-Fi on the display.	<ul style="list-style-type: none"> • On • Off (default)
Connection Manager	<p>Provides a list of Bluetooth devices in range. When you highlight a connection in the list and press OK, the following options are available:</p> <ul style="list-style-type: none"> • Unpair / Forget this device — Disconnect the device and remove it from the connection list. If you unpair a device in this way you must re-pair the device if you want to connection it again to the multifunction display. • Audio Control — If this option is set to On, you can control the audio for a compatible wireless media player, from the multifunction display. 	<ul style="list-style-type: none"> • Unpair / Forget this device • Audio control On / Off.
New Bluetooth Connection	Selecting this menu item initiates the Bluetooth pairing process. This is necessary for connecting a wireless remote control unit or media player device to the multifunction display.	
Wi-Fi Name	Enables you to specify an SSID (WiFi Name) for connecting WiFi devices using an encrypted connection. If you want to prevent unauthorized devices from connecting to your display you must specify the same SSID for both the multifunction display and the wireless device you want to connect to the display.	
Wi-Fi Security	You can encrypt the WiFi connection on the multifunction display to prevent unauthorized devices from accessing the connection. This menu item enables you to select the type of WPA (WiFi Protected Access) encryption you want to use. WPA2 provides stronger security than WPA.	<ul style="list-style-type: none"> • None • WPA Only • WPA 2 Only. (default) • WPA / WPA2.
Wi-Fi Passphrase	Enables you to specify a password for the WiFi connection. If you want to prevent unauthorized devices from connecting to your display you must specify the same password for both the multifunction display and the wireless device you want to connect to the display.	
Wi-Fi Channel	By default the multifunction display automatically selects an available WiFi channel. If you're experiencing difficulties with wireless video streaming it may be necessary to manually specify a WiFi channel for both the multifunction display and the device you want to stream video to.	<ul style="list-style-type: none"> • 1 (default) • 2 • 3 • 4 • 5 • 6 • 7 • 8 • 9 • 10 • 11
Mobile apps	<p>Enables you to select the type of mobile app in use:</p> <ul style="list-style-type: none"> • Viewing only — RayView • Remote Control — RayRemote or RayControl 	<ul style="list-style-type: none"> • Off (default) • Viewing only • Remote Control

NMEA Set-up menu

This menu enables you to configure settings for NMEA devices.

Menu item	Description	Options
Bridge NMEA Heading	If set to ON, NMEA heading data will be bridged onto the SeaTalk data bus, and will be sent to all NMEA-connected devices. If set to OFF, NMEA heading data will NOT be bridged onto the SeaTalk bus. An example of a use for this setting is when using MARPA with an external fast heading sensor, in which case you should set this option to OFF to ensure that all NMEA-connected units receive heading data from the external heading sensor.	<ul style="list-style-type: none"> • On • Off (default)
NMEA Output Settings	Allows you to enable or disable the individual NMEA "sentences" that are sent by the multifunction display to any devices connected the NMEA output port.	<ul style="list-style-type: none"> • APB • BWC • BWR • DBT • DPT • GGA • GLL • GSA • GSV • MTW • MWV • RMA • RMB • RMC • RSD • RTE • TTM • VHW • VLW • VTG • WPL • ZDA
NMEA Input Port 1	Enables you to specify the appropriate port speed for the equipment connected to NMEA Input port 1. Use the AIS 38400 option for AIS receivers.	<ul style="list-style-type: none"> • NMEA 4800 • AIS 38400
NMEA Input Port 2	Enables you to specify the appropriate port speed for the equipment connected to NMEA Input port 2. Use the AIS 38400 option for AIS receivers.	<ul style="list-style-type: none"> • NMEA 4800 • AIS 38400

System preferences menu

Menu item	Description	Options
Bearing mode	Determines how all bearing and heading data is displayed in. This does not affect how the chart or radar displays are drawn.	<ul style="list-style-type: none"> • True (default) • Magnetic
Variation Source	This setting compensates for the naturally occurring offset of the earth's magnetic field. When set to Auto, the system automatically compensates, and displays the compensation value in brackets. To enter your own compensation value, use the Manual option, then specify the value using the Manual Variation setting (see below). This value is also transmitted to any other connected Raymarine instruments.	<ul style="list-style-type: none"> • Auto (compensation value displayed) (default) • Manual
Manual Variation	When the Variation Source menu item is set to Manual (see above), you use the Manual Variation setting to specify the compensation value that you want to use.	<ul style="list-style-type: none"> • Range: 0 to 30 degrees, East or West •
System Datum	<p>In order for your GPS receiver and multifunction display to correlate accurately with your paper charts, they must be using the same datum.</p> <p>The default datum for your multifunction display is WGS1984. If this is not the datum used by your paper charts, you can change the datum used by your multifunction display.</p> <p>When you change the datum for your multifunction display, the chart grid will subsequently move according to the new datum, and the latitude / longitude of the cartographic features will also change accordingly. Your multifunction display will attempt to set up any GPS receiver to the new datum, as follows:</p> <ul style="list-style-type: none"> • The internal GPS receiver will automatically correlate each time you change the datum. • If you have a Raymarine GPS receiver using SeaTalk or SeaTalk^{ng}, it will automatically correlate each time you change the datum on the multifunction display. • If you have a Raymarine GPS receiver using NMEA 0183, or a third-party GPS receiver, you must correlate it separately. <p>It may be possible to use your multifunction display to correlate an NMEA 0183 GPS receiver. From the homescreen go to Set-up > System settings > GPS Set-up > View Satellite Status. If the datum version is displayed, it may be possible to change it. From the homescreen go to Set-up > System settings > Data Sources > GPS Datum.</p> <div style="border: 1px solid black; padding: 5px; margin-top: 10px;"> <p>Note: Raymarine recommends that you check the displayed vessel position in the chart application against your actual proximity to a known charted object. A typical GPS has an accuracy of between 5 and 15 m.</p> </div>	

Maintenance menu

This menu provides access to systems settings reset and diagnostics.

Menu item	Description	Options
Touchscreen Alignment	<p>If the touchscreen is misaligned to your touch, you can realign it to improve the accuracy. Realignment involves a simple exercise to align an on-screen object with your touch. For best results, perform this exercise when your vessel is anchored or moored.</p> <div style="border: 1px solid black; padding: 5px; margin-top: 10px;"> <p>Note: The Touchscreen alignment option is not required on New c Series displays.</p> </div>	
Data Master	<p>Any system containing more than one networked multifunction display must have a designated data master. The data master is the display which serves as a primary source of data for all displays, it also handles all external sources of information.</p>	
System Settings Reset	<p>This option resets your menu options, datapages, and databar settings to factory default. It will NOT affect your waypoints, routes, or tracks data.</p>	<ul style="list-style-type: none"> • Yes • No
System Settings and Data Reset	<p>In addition to the settings reset detailed above, performing a settings and data reset will also remove ALL waypoints, routes, and tracks data.</p>	<ul style="list-style-type: none"> • Yes • No
Diagnostics	<p>Diagnostics provides detailed information on the multifunction display and connected devices. The range of information available includes product serial number, software version, and network status. When you select the Diagnostics menu item the multifunction display scans for any connected equipment and enables you to select the product you want to view. You can also save the diagnostics information to a memory card. This is particularly useful for sending detailed information to Raymarine Customer Support in the event of a technical issue.</p> <p>The Interfaces option allows you to view statistics and buffer information for NMEA 0183 ports 1 and 2 and SeaTalk^{ng}.</p> <p>The Sirius options allows you to view received messages, memory and errors.</p>	<ul style="list-style-type: none"> • Select Device • Sirius • Save Logs • Erase Logs • Interfaces

Diagnostics menu

If you encounter problems with your multifunction display or peripheral devices you can use the Diagnostics menu to view information about your device and connected equipment.

Select Device	Enables you to view a list of all devices connected to the SeaTalk ^{hs} network. You can also select an item in the list to view further details for that device.	<ul style="list-style-type: none"> • Device • Serial No. • Network • Software
Sirius	If connected to a Sirius weather receiver this option enables you to view Sirius weather statistics.	
Save Logs	Allows you to save error logs to a MicroSD card for troubleshooting purposes.	
Erase Logs	Selecting this option will erase any crash logs on the device.	
Interfaces	Enables viewing of statistics and viewing and recording of buffers on NMEA inputs and the SeaTalk ^{ng} bus. On multifunction displays with multiple MicroSD card slots you can also choose which MicroSD card slot the buffer will be recorded to.	<ul style="list-style-type: none"> • NMEA 1 • NMEA 2 • SeaTalk^{ng} • Record File

Chapter 28: Maintaining your display

Chapter contents

- [28.1 Service and maintenance on page 334](#)
- [28.2 Cleaning on page 334](#)

28.1 Service and maintenance

This product contains no user serviceable components. Please refer all maintenance and repair to authorized Raymarine dealers. Unauthorized repair may affect your warranty.

Routine equipment checks

Raymarine strongly recommends that you complete a number of routine checks to ensure the correct and reliable operation of your equipment.

Complete the following checks on a regular basis:

- Examine all cables for signs of damage or wear and tear.
- Check that all cables are securely connected.

28.2 Cleaning

Best cleaning practices.

When cleaning this product:

- Do NOT wipe the display screen with a dry cloth, as this could scratch the screen coating.
- Do NOT use abrasive, or acid or ammonia based products.
- Do NOT use a jet wash.

Cleaning the display case

The display unit is a sealed unit and does not require regular cleaning. If it is necessary to clean the unit, follow this basic procedure:

1. Switch off the power to the display.
2. Wipe the display with a clean, soft cloth (a microfibre cloth is ideal).
3. If necessary, use a mild detergent to remove grease marks.

Note: Do NOT use solvents or detergents on the screen itself.

Note: In certain conditions, condensation may appear inside the display screen. This will not harm the unit, and can be cleared by powering on the display for a short time.

Cleaning the display screen

A coating is applied to the display screen. This makes it water repellent, and prevents glare. To avoid damaging this coating, follow this procedure:

1. Switch off the power to the display.
2. Rinse the screen with fresh water to remove all dirt particles and salt deposits.
3. Allow the screen to dry naturally.
4. If any smears remain, very gently wipe the screen with a clean microfibre cleaning cloth (available from an opticians).

Cleaning the sun cover

The supplied sun cover features an adhesive surface. In certain conditions unwanted contaminants may stick to this surface. To avoid damaging the monitor display, clean the sun cover regularly following this procedure:

1. Carefully remove the sun cover from the display.
2. Rinse the sun cover with fresh water to remove all dirt particles and salt deposits.
3. Allow the sun cover to dry naturally.

Chapter 29: Troubleshooting

Chapter contents

- [29.1 Troubleshooting on page 336](#)
- [29.2 Power up troubleshooting on page 337](#)
- [29.3 Radar troubleshooting on page 338](#)
- [29.4 GPS troubleshooting on page 339](#)
- [29.5 Sonar troubleshooting on page 340](#)
- [29.6 Thermal camera troubleshooting on page 341](#)
- [29.7 System data troubleshooting on page 342](#)
- [29.8 Video troubleshooting on page 343](#)
- [29.9 Wi-Fi troubleshooting on page 344](#)
- [29.10 Bluetooth troubleshooting on page 345](#)
- [29.11 Touchscreen troubleshooting on page 346](#)
- [29.12 Touchscreen alignment on page 347](#)
- [29.13 Miscellaneous troubleshooting on page 348](#)

29.1 Troubleshooting

The troubleshooting information provides possible causes and corrective action required for common problems associated with marine electronics installations.

All Raymarine products are, prior to packing and shipping, subjected to comprehensive test and quality assurance programs. However, if you experience problems with the operation of your product this section will help you to diagnose and correct problems in order to restore normal operation.

If after referring to this section you are still having problems with your unit, please contact Raymarine Technical Support for further advice.

29.2 Power up troubleshooting

Problems at power up and their possible causes and solutions are described here.

Problem	Possible causes	Possible solutions
The system (or part of it) does not start up.	Power supply problem.	Check relevant fuses and breakers.
		Check that the power supply cable is sound and that all connections are tight and free from corrosion.
		Check that the power source is of the correct voltage and sufficient current.

29.3 Radar troubleshooting

Problems with the radar and their possible causes and solutions are described here.

Problem	Possible causes	Possible solutions
No Data or No scanner message	Radar scanner power supply	Check that the scanner power supply cable is sound and that all connections are tight and free from corrosion.
		Check relevant fuses and breakers.
		Check power source is of the correct voltage and sufficient current (using voltage booster if appropriate).
	SeaTalk ^{hs} / RayNet network problem	Check that the Scanner is correctly connected to a Raymarine network switch or SeaTalk ^{hs} crossover coupler (as applicable).
		Check the status of the Raymarine network switch.
		Check that SeaTalk ^{hs} / RayNet cables are free from damage.
Software mismatch between equipment may prevent communication.	Contact Raymarine technical support.	
Switch at scanner pedestal in OFF position	Ensure scanner pedestal switch is in ON position.	
Radar will not initialize (Voltage control module (VCM) stuck in "sleep mode")	Intermittent or poor power connection	Check power connection at VCM. (Voltage at input = 12 / 24 V, Voltage at output = 40 V)
The bearing of a target on the radar screen is incorrect.	The radar bearing alignment requires correcting.	Check and adjust radar bearing alignment.

29.4 GPS troubleshooting

Problems with the GPS and their possible causes and solutions are described here.

Problem	Possible causes	Possible solutions
"No Fix" GPS status icon is displayed.	Geographic location or prevailing conditions preventing satellite fix.	Check periodically to see if a fix is obtained in better conditions or another geographic location.
	GPS connection fault.	Ensure that external GPS connections and cabling are correct and fault free.
	External GPS antenna in poor position. For example: <ul style="list-style-type: none">• Below decks.• Close proximity to transmitting equipment such as VHF radio.	Ensure GPS antenna has a clear view of the sky.
	GPS installation problem.	Refer to the installation instructions.

Note: A GPS Status screen is available within the display. This provides satellite signal strength and other relevant information.

29.5 Sonar troubleshooting

Problems with the sonar and their possible causes and solutions are described here.

Problem	Possible causes	Possible solutions
Sonar data not available on multifunction display.	Unit power supply fault.	Check the unit power supply and cables.
	Other unit fault.	Refer to the instructions supplied with the unit.
	SeaTalk ^{hs} / RayNet network problem.	Check that the unit is correctly connected to a Raymarine network SeaTalk ^{hs} switch or crossover coupler (as applicable).
		Check the status of the Raymarine network switch (if applicable).
		Check that SeaTalk ^{hs} / RayNet cables are free from damage.
Software mismatch between equipment may prevent communication.	Contact Raymarine technical support.	
Problematic depth readings or sonar image.	Gain or Frequency settings may be inappropriate for present conditions.	Check the sonar presets, gain and frequency settings.
	Unit power supply fault	Check the voltage from the power supply, if this is too low it can affect the transmitting power of the unit.
	Unit cable fault.	Ensure that the power, transducer and all other cables to the unit are properly connected and free from damage.
	Transducer fault	Check that the transducer is mounted correctly and is clean.
		If you have a transom-mount transducer, check that the transducer hasn't kicked up due to hitting an object.
	Other unit fault.	Refer to the instructions supplied with the unit.
	Vessel stationary	Fish arches are not displayed if the vessel is stationary, fish will appear on the display as straight lines.
	High vessel speed	Turbulence around the transducer may be confusing the unit.
Scroll speed set to zero	Adjust scroll speed	
Incorrect speed reading	Paddle wheel fault	Check that the paddle wheel is clean.
	No speed offset set	Add speed offset.
	Incorrect calibration	Re-calibrate equipment

29.6 Thermal camera troubleshooting

Problems with the thermal camera and their possible causes and solutions are described here.

Problem	Possible causes	Possible solutions
Video not displayed.	Camera is in Standby mode.	The camera will not display video if it is in Standby mode. Use the camera controls (either the thermal camera application or JCU) to “wake” the camera from standby.
	Problem with the thermal camera video connections.	<ul style="list-style-type: none"> • Check thermal camera video cables are sound and properly connected. • Ensure that the video is connected into video input 1 at the multifunction display or GVM. • Ensure that the correct video input is selected at the display.
	Problem with power supply to the camera or JCU (if used as the primary controller)	<ul style="list-style-type: none"> • Check the power connections to the camera and JCU / PoE injector (if used). • Ensure that the power switch / breaker is on. • Check the fuse / breaker state.
Cannot control thermal camera from Raymarine display or keyboard.	Thermal camera application is not running.	Ensure the thermal camera application is running on the multifunction display (as oppose to the video application which does not have camera controls).
Erratic or unresponsive controls.	Network problem.	Check that the controller and thermal camera are correctly connected to the network. (Note: This may be a direct connection or via a Raymarine network switch.)
		Check the status of the Raymarine network switch.
		Check that SeaTalk ^{hs} / RayNet cables are free from damage.
	Control conflict, e.g. caused by multiple users at different stations.	Ensure that no other controllers are in use at the same time.
Problem with the controller.	Check power / network cabling to the controller and PoE injector (PoE only used with optional Joystick Control Unit).	
	Check other controllers if available. If other controllers are operating this will eliminate the possibility of a more fundamental camera fault.	
Cannot switch between thermal and visible (VIS / IR) video image .	Camera is not a dual payload model.	Only “dual payload” (dual lens) thermal cameras support VIS / IR switching.
	VIS / IR cable not connected.	Ensure that the VIS / IR cable is connected from the camera to the Raymarine system. (The IR-only cable does not support switching).
Noisy image.	Poor quality or faulty video cable.	Ensure that the video cable is no longer than necessary. The longer the cable is (or the smaller the wire gauge / thickness), the more severe the losses become. Use only high quality shielded cable suitable for a marine environment.
	Cable is picking up electromagnetic interference (EMI) from another device.	<ul style="list-style-type: none"> • Ensure you are using a high quality shielded cable. • Ensure proper cable separation, for example do not run data and power cables in close proximity with each other.
Image too dark or too light.	Display brightness is set too low.	Use the brightness controls at the display to adjust accordingly.
	The contrast or brightness settings in the thermal camera application are set too low.	Use the appropriate menu in the thermal camera application to adjust the contrast and brightness of the image.
	The Scene Mode is not appropriate for the current conditions.	A particular environment may benefit from a different Scene Mode setting. For example, a very cold background (such as the sky) could cause the camera to use a wider temperature range than appropriate. Use the SCENE button.
Image freezes momentarily.	FFC (Flat Field Correction).	The image will pause momentarily on a periodic basis during the Flat Field Correction (FFC) cycle. Just prior to the FFC, a small green square will appear in the upper left corner of the screen.
Image is inverted (upside down).	Camera “Ball down” setting is incorrect.	Ensure that the Ball down setting within the thermal camera system setup menu is set correctly.

29.7 System data troubleshooting

Aspects of the installation can cause problems with the data shared between connected equipment. Such problems, their possible causes and solutions are described here.

Problem	Possible causes	Possible solutions
Instrument, engine or other system data is unavailable at all displays.	Data is not being received at the display.	Check the data bus (e.g. SeaTalk ^{ng}) wiring and connections.
		Check the overall integrity of the data bus (e.g. SeaTalk ^{ng}) wiring.
		If available refer to the reference guide for the data bus (e.g. SeaTalk ^{ng} reference manual).
	Data source (e.g. ST70 instrument or engine interface) is not operating.	Check the source of the missing data (e.g. ST70 instrument or engine interface).
		Check the power to the SeaTalk bus.
		Refer to the manufacturer's handbook for the equipment in question.
Software mismatch between equipment may prevent communication.	Contact Raymarine technical support.	
Instrument or other system data is missing from some but not all displays.	Network problem.	Check that all required equipment is connected to the network.
		Check the status of the Raymarine network Switch.
		Check that SeaTalk ^{hs} / RayNet cables are free from damage.
	Software mismatch between equipment may prevent communication.	Contact Raymarine technical support.

29.8 Video troubleshooting

Problems with the video inputs and their possible causes and solutions are described here.

Problem	Possible causes	Possible solutions
No signal message on screen (video image not displayed)	Cable or connection fault	Check that the connections are sound and free from corrosion.

29.9 Wi-Fi troubleshooting

Aspects of the installation can cause problems with the data shared between wireless devices. Such problems, their possible causes and solutions are described here.

Problem	Possible causes	Possible solutions
No wireless connection.	Tablet / smartphone does not have a wireless connection established with the multifunction display.	Ensure that Wi-Fi is enabled on the multifunction display (Homescreen: > Set-Up > System Settings > Wireless Connections > Wi-Fi > On).
		Ensure that the "Wi-Fi" option is enabled on the iPhone (available from the phone's Settings menu).
		Ensure that the Raymarine connection is selected as the Wi-Fi network. If a passcode has been specified for the multifunction display's Wi-Fi connection ensure that the same passcode is entered into the iPhone when prompted.
No Raymarine app on device.	Tablet / smartphone does not have Raymarine app installed and running.	Download the required Raymarine app from the relevant application store.
		Start the Raymarine app on your device.
Raymarine app runs slowly or not at all.	Mobile applications are NOT enabled on the multifunction display.	Enable "Viewing only" or "Remote Control" (Homescreen: > Set-Up > System Settings > Wireless Connections > Mobile Apps).
	Device not compatible with Raymarine app.	Recommended device requirements: <ul style="list-style-type: none"> • iOS Devices = Best performance achieved on iPhone 4 or later and iPad 2 or later. • Android/Kindle Fire = Best performance achieved with 1GHz processor and better and running 2.2.2. or later.
No waypoint / routes synchronization with Navionics Marine app.	MFD software incompatible with mobile application.	Ensure your MFD contains software application version 3.15 or later.
	Smartphone / tablet does not have "Navionics Marine" app installed and running.	Download the "Navionics Marine" app from the relevant app store. Start the "Navionics Marine" app on the device.
Weak or intermittent Wi-Fi signal.	Chart application is not running on the multifunction display.	Start the chart application on the multifunction display.
	Interference from other wireless devices in the vicinity.	Multiple wireless devices running simultaneously (such as laptops, phones, and other wireless devices) can sometimes cause wireless signal conflicts. Temporarily disable each wireless device in turn until you have identified the device causing the interference.
Smartphone / tablet can no longer connect to the internet or receive e-mails after using a Raymarine mobile app.	Device still connected to the multifunction display.	Ensure the access point on your device is switched back to your previous access point (e.g. the marina Wi-Fi).

29.10 Bluetooth troubleshooting

Aspects of the installation can cause problems with the data shared between wireless devices. Such problems, their possible causes and solutions are described here.

Problem	Possible causes	Possible solutions
No wireless connection.	iPhone does not have a Bluetooth connection established with the multifunction display.	Ensure that Bluetooth is enabled on the multifunction display (Homescreen: > Set-Up > System Settings > Connections > Bluetooth > On).
		Ensure that the "Bluetooth" option is enabled on the iPhone (available from the phone's Settings / General menu).
		Ensure that the Bluetooth device is paired with the multifunction display that you want to use it with. To do this: Homescreen: > Set-Up > System Settings > Connections > New Bluetooth Connection .
No media player control.	Media player device is not compatible with the Bluetooth 2.1+ EDR power class 1.5 (supported profile: AVRCP 1.0) or higher.	Check the Bluetooth compatibility with the device manufacturer. If the device is not Bluetooth 2.1+ EDR power class 1.5 (supported profile: AVRCP 1.0) compatible then it is not suitable for wireless use with the multifunction display.
	"Audio Control" is NOT enabled on the multifunction display.	Enable "Audio Control" (Homescreen: > Set-Up > System Settings > Connections > Connections Manager > Audio Control > On).
Weak or intermittent Bluetooth signal.	Interference from other wireless devices in the vicinity.	Multiple wireless devices running simultaneously (such as laptops, phones, and other wireless devices) can sometimes cause wireless signal conflicts. Temporarily disable each wireless device in turn until you have identified the device causing the interference.

29.11 Touchscreen troubleshooting

Problems with the touchscreen and their possible causes and solutions are described here.

Problem	Possible causes	Possible solutions
Touchscreen does not operate as expected.	Touch lock is enabled.	Use the Joystick to turn off the touch lock on the home screen.
	Screen is not being operated with bare fingers, for example gloves are being worn.	Bare fingers must make contact with the screen for correct operation. Alternatively you may use conductive gloves.
	Touchscreen requires calibration.	Use the setup menus to calibrate the touchscreen.
	Saltwater deposits on the screen.	Carefully clean and dry the screen in accordance with the instructions provided.

29.12 Touchscreen alignment

If the touchscreen is misaligned to your touch, you can realign it to improve the accuracy.

Realignment involves a simple exercise to align an on-screen object with your touch. For best results, perform this exercise when your vessel is anchored or moored.

Note: This only applies to touchscreen multifunction displays.

Aligning the touchscreen

With the homescreen displayed:

1. Select **Set-up**.
2. Select **Maintenance**.
3. Select **Touchscreen Alignment**.
4. Place your finger over the on-screen object momentarily, then remove it.
5. Repeat the action a further 3 times.
6. If the operation was successful, an "Alignment Completed" message is displayed.
7. Select **Exit** to return to the Maintenance menu.
8. If the operation was unsuccessful at any point during the alignment exercise, an "Incorrect touch detected" message is displayed, the alignment exercise is repeated.
9. After 2 failed alignment exercises you may be asked to perform a precision alignment exercise.

29.13 Miscellaneous troubleshooting

Miscellaneous problems and their possible causes and solutions are described here.

Problem	Possible causes	Possible solutions
Display behaves erratically: <ul style="list-style-type: none"> • Frequent unexpected resets. • System crashes or other erratic behavior. 	Intermittent problem with power to the display.	Check relevant fuses and breakers.
		Check that the power supply cable is sound and that all connections are tight and free from corrosion.
		Check that the power source is of the correct voltage and sufficient current.
	Software mismatch on system (upgrade required).	Go to www.raymarine.com and click on support for the latest software downloads.
	Corrupt data / other unknown issue.	Perform a factory reset. <div style="border: 1px solid black; padding: 5px; margin-top: 5px;"> <p>Important: This will result in the loss of any settings and data (such as waypoints) stored on the product. Save any important data to a memory card before resetting.</p> </div>

Chapter 30: Technical support

Chapter contents

- [30.1 Raymarine customer support on page 350](#)
- [30.2 Third-party support on page 350](#)

30.1 Raymarine customer support

Raymarine provides a comprehensive customer support service. You can contact customer support through the Raymarine website, telephone and e-mail. If you are unable to resolve a problem, please use any of these facilities to obtain additional help.

Web support

Please visit the customer support area of our website at:

www.raymarine.com

This contains Frequently Asked Questions, servicing information, e-mail access to the Raymarine Technical Support Department and details of worldwide Raymarine agents.

Telephone and e-mail support

In the USA:

- **Tel:** +1 603 324 7900
- **Toll Free:** +1 800 539 5539
- **E-mail:** support@raymarine.com

In the UK, Europe, and the Middle East:

- **Tel:** +44 (0)13 2924 6777
- **E-mail:** ukproduct.support@raymarine.com

In Southeast Asia and Australia:

- **Tel:** +61 (0)29479 4800
- **E-mail:** aus.support@raymarine.com

Product information

If you need to request service, please have the following information to hand:

- Product name.
- Product identity.
- Serial number.
- Software application version.
- System diagrams.

You can obtain this product information using the menus within your product.

Viewing product information

With the homescreen displayed:

1. Select **Set-up**.
2. Select **Maintenance**.
3. Select **Diagnostics**.
4. Select **Select Device**.
5. Select the relevant product from the list.
6. Select **Show All Data**.

30.2 Third-party support

Contact and support details for third-party suppliers can be found on the appropriate websites.

Fusion

www.fusionelectronics.com

Navionics

www.navionics.com

Sirius

www.sirius.com

Chapter 31: Technical specification

Chapter contents

- [31.1 a Series on page 352](#)
- [31.2 c and e Series on page 354](#)

31.1 a Series

a6x Physical specifications

Dimensions	<ul style="list-style-type: none"> Width: 163.57 mm (6.44 in) Height (NOT including bracket): 143.47 mm (5.65 in) Height (including bracket): 162.72 mm (6.41 in) Depth (NOT including cables): 74.1 mm Depth (including cables): 167.5 mm (6.6 in)
Weight (bare unit)	0.715 kg (1.58 lbs)

a7x Physical specifications

Dimensions	<ul style="list-style-type: none"> Width: 205.1 mm (8 in) Height (NOT including bracket): 147.1 mm (5.8 in) Height (including bracket): 163.3 mm (6.4 in) Depth (NOT including cables): 73.6 mm (2.9 in) Depth (including cables): 164.5 mm (6.48 in)
Weight (bare unit)	0.715 kg (1.58 lbs)

a6x Power specification

Nominal supply voltage	12 V dc
Operating voltage range	10.8 V dc to 15.6 V dc
Fuse / Breakers	It is recommended that you fit a thermal breaker or fuse at the distribution panel. The suitable fuse rating for the thermal breaker is dependent on the number of devices you are connecting. If in doubt consult an authorized Raymarine dealer
Power consumption	<p>Full brightness:</p> <ul style="list-style-type: none"> a65 / a65 Wi-Fi — 8.6 W Max a67 / a67 Wi-Fi — 12.2 W Max a68 / a68 Wi-Fi — 10.6 W Max <p>PowerSave mode:</p> <ul style="list-style-type: none"> a65 / a65 Wi-Fi — 3.8 W Max a67 / a67 Wi-Fi — 7.4 W Max a68 / a68 Wi-Fi — 5.8 W Max <p>Note: Power consumption figures represent a loaded system and for sonar variants include an active 600 W transducer.</p>
LEN (Refer to Seataalk^{ng} reference manual for further information).	1

a7x Power specification

Nominal supply voltage	12 V dc
Operating voltage range	10.8 V dc to 15.6 V dc

Fuse / Breakers	It is recommended that you fit a thermal breaker or fuse at the distribution panel. The suitable fuse rating for the thermal breaker is dependent on the number of devices you are connecting. If in doubt consult an authorized Raymarine dealer
Power consumption	<p>Full brightness:</p> <ul style="list-style-type: none"> a75 / a75 Wi-Fi — 9.1 W Max a77 / a77 Wi-Fi — 12.7 W Max a78 / a78 Wi-Fi — 11.1 W Max <p>PowerSave mode:</p> <ul style="list-style-type: none"> a75 / a75 Wi-Fi — 3.8 W Max a77 / a77 Wi-Fi — 7.4 W Max a78 / a78 Wi-Fi — 5.8 W Max <p>Note: Power consumption figures represent a loaded system and for sonar variants include an active 600 W transducer.</p>
LEN (Refer to Seataalk^{ng} reference manual for further information).	1

Environmental specification

Environmental specifications below apply to all display variants

Operating temperature	-25 °C to +55 °C (-13 °F to 131 °F)
Storage temperature	-30 °C to +70 °C (-22 °F to 158 °F)
Relative humidity	Maximum 75%
Waterproof rating	<ul style="list-style-type: none"> IPX6 and IPX7 IPX6 (e165 only)

Viewing angle

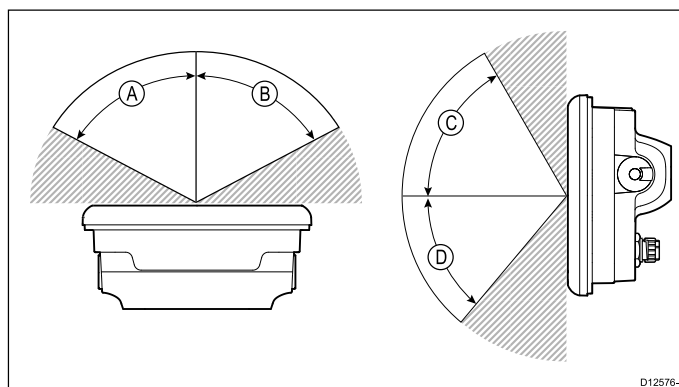

	a6x	a7x
A	60°	75°
B	60°	75°
C	60°	70°
D	50°	75°

Note: The viewing angles stated above were taken using internationally agreed standards and should be used for comparison purposes only. Do NOT install the product before testing the viewability in the desired location.

a6x Display specification

Size	5.7 in
Type	TFT backlit LED
Color depth	24-bit
Resolution	640 x 480 VGA
Aspect	4:3
Maximum allowable wrongly illuminated pixels	5

a7x Display specification

Size	7.0 in
Type	TFT backlit LED
Color depth	24-bit
Resolution	800 x 480 WVGA
Aspect	16:9
Maximum allowable wrongly illuminated pixels	6

Data connections

Wired connections

NMEA 0183	<p>2x NMEA 0183 ports:</p> <ul style="list-style-type: none"> NMEA port 1: Input and output, 4800 / 38400 baud NMEA port 2: Input only, 4800 / 38400 baud <p>Note: NMEA 0183 connection does not apply to New a Series multifunction displays.</p>
Network (SeaTalk^{hs})	<ul style="list-style-type: none"> New a Series, e7 and e7D = 1 x SeaTalk^{hs} port. 100 Mbits/s. RayNet type connection. New c Series and New e Series (excluding e7 and e7D) = 2 x SeaTalk^{hs} port. 100 Mbits/s. RayNet type connection.
SeaTalk^{ng}	1 x SeaTalk ^{ng} connection

Wireless connections

Wi-Fi	<p>802.11 b / g</p> <p>Note: Wi-Fi connection only applies to multifunction displays that include built-in Wi-Fi.</p>
Bluetooth	Bluetooth 2.1+ EDR power class 1.5 (supported profile: AVRCP 1.0)

Internal GPS specification

The Internal GPS specification applies to the following multifunction displays New a Series, New c Series and New e Series (excluding the e165).

Channels	50
Cold start	<2 minutes
Receiver IC Sensitivity	163 dBm Tracking
Satellite Based Aiding System (SBAS)	WAAS + EGNOS + MSAS
Special features	Active Jamming Reduction

Operating frequency	1575.42MHz
Signal Acquisition	Automatic
Almanac Update	Automatic
Geodetic Datum	WGS-84, alternatives available through Raymarine displays.
Update Rate	1 second
Antenna	Ceramic chip
Accuracy	<ul style="list-style-type: none"> Without SBAS: <= 15 metres 95% of the time With SBAS: <= 5 metres 95% of the time

Internal sonar specification

The internal sonar specifications only apply to sonar variant multifunction display variants.

Operating frequencies	50 / 83 / 200 KHz
Transmit power	Up to 600 W RMS, depending on transducer
Depth range	Up to 3000 ft, depending on transducer

Sonar / DownVision specification

Channels	2 x CHIRP (1 x sonar and 1 x DownVision)
Beam coverage	<ul style="list-style-type: none"> Sonar — conical beam. DownVision — Wide (port / starboard) and thin (fore / aft) fan beam.
Depth	Typical depth performance of 189 m (600 ft). Applies to both Sonar and DownVision channels.

Electronic chart specification

Embedded electronic charts	<ul style="list-style-type: none"> LightHouse Charts world base map. Navionics world base map.
Compatible LightHouse charts	<ul style="list-style-type: none"> Vector — LightHouse charts Raster — LightHouse charts
Compatible Navionics chart cards	<ul style="list-style-type: none"> Navionics Ready to Navigate Navionics Silver Navionics Gold Navionics Gold+ Navionics Platinum Navionics Platinum+ Navionics Fish'N Chip Navionics Hotmaps

Note:

Refer to the Raymarine website (www.raymarine.com) for the latest list of supported charts.

Conformance specification

Conformance certification applies to all display variants

Conformance	<ul style="list-style-type: none"> • NMEA 2000 certification • WiFi Alliance certification • Bluetooth certification • Europe: 1999/5/EC • Australia and New Zealand: C-Tick, Compliance Level 2 • FCC 47CFR part 15 • Industry Canada RSS210
--------------------	--

31.2 c and e Series

e7 / e7D Physical specifications

Dimensions	<ul style="list-style-type: none"> • Width: 233 mm (9.17 in.) • Height (NOT including bracket): 145 mm (5.71 in.) • Height (including bracket): 180 mm (7.09 in.) • Depth (NOT including cables): 64 mm (2.52 in.) • Depth (including cables): 160 mm (6.29 in.)
Weight (bare unit)	<p>e7</p> <ul style="list-style-type: none"> • 1.465 kg (3.23 lb.) <p>e7D</p> <ul style="list-style-type: none"> • 1.550 kg (3.42 lb.)
Weight (boxed unit)	<p>e7</p> <ul style="list-style-type: none"> • 2.385 kg (5.26 lb.) <p>e7D</p> <ul style="list-style-type: none"> • 2.423 kg (5.34 lb.)

e95 / e97 / c95 / c97 Physical specifications

Dimensions	<ul style="list-style-type: none"> • Width: 290 mm (11.42 in.) • Height (NOT including bracket): 173 mm (6.81 in.) • Height (including bracket): 212 mm (8.35 in.) • Depth (NOT including cables): 64 mm (2.52 in.) • Depth (including cables): 160 mm (6.29 in.)
Weight (bare unit)	<p>e95 / c95</p> <ul style="list-style-type: none"> • 2.165 kg (4.77 lb.) <p>e97 / c97</p> <ul style="list-style-type: none"> • 2.265 kg (4.99 lb.)
Weight (boxed unit)	<p>e95 / c95</p> <ul style="list-style-type: none"> • 3.540 kg (7.8 lb.) <p>e97 / c97</p> <ul style="list-style-type: none"> • 3.635 kg (8 lb.)

e125 / e127 / c125 / c127 Physical specifications

Dimensions	<ul style="list-style-type: none"> • Width: 354 mm (13.94 in.) • Height (NOT including bracket): 222 mm (8.74 in.) • Height (including bracket): 256 mm (10.08 in.) • Depth (NOT including cables): 69 mm (2.72 in.) • Depth (including cables): 160 mm (6.29 in.)
Weight (bare unit)	<p>e125 / c125</p> <ul style="list-style-type: none"> • 3.320 kg (7.32 lb.) <p>e127 / c127</p>

	<ul style="list-style-type: none"> • 3.450 kg (7.6 lb.)
Weight (boxed unit)	e125 / c125 <ul style="list-style-type: none"> • 4.955 kg (10.9 lb.) e127 / c127 <ul style="list-style-type: none"> • 5.070 kg (11.18 lb.)

e165 Physical specifications

Dimensions	<ul style="list-style-type: none"> • Width: 426 mm (16.8 in) • Height (NOT including bracket): 281.4 mm (11.1 in) • Height (including bracket): 295 mm (11.6 in) • Depth (NOT including cables): 68.4 mm (2.7 in) • Depth (including cables): 176.6 mm (7 in)
Weight (bare unit)	5.6 kg (12.3lb)

Power consumption	Full brightness: <ul style="list-style-type: none"> • c95 — 13.1 W • c97 — 16.7 W • e95 — 18 W • e97 — 22.1 W PowerSave mode: <ul style="list-style-type: none"> • c95 —5.9 W • c97 — 9.7 W • e95 — 11.2 W • e97 — 14.9 W <div style="border: 1px solid black; padding: 5px; margin-top: 10px;"> Note: Power consumption figures represent a loaded system and for sonar variants include an active 600 W transducer. </div>
LEN (Refer to Seatalk^{ng} reference manual for further information).	1

e7 / e7D Power specification

Nominal supply voltage	12 V dc
Operating voltage range	10.8 V dc to 15.6 V dc
Fuse / Breakers	In-line fuse (fitted within power cable) <ul style="list-style-type: none"> • 7 A. (Standard 20 mm glass fuse)
Power consumption	Full brightness: <ul style="list-style-type: none"> • e7 — 10 W • e7D — 13.8 W PowerSave mode: <ul style="list-style-type: none"> • e7 — 4.3 W • e7D — 10.3 W <div style="border: 1px solid black; padding: 5px; margin-top: 10px;"> Note: Power consumption figures represent a loaded system and for sonar variants include an active 600 W transducer. </div>
LEN (Refer to Seatalk^{ng} reference manual for further information).	1

c125 / c127 / e125 / e127 power specification

Nominal supply voltage	12/24 V dc
Operating voltage range	10.8 V dc to 31.2 V dc
Fuse / Breakers	In-line fuse (fitted within power cable) <ul style="list-style-type: none"> • 7 A. (Standard 20 mm glass fuse)
Power consumption	Full brightness: <ul style="list-style-type: none"> • c125 — 16.3 W • c127 — 20.8 W • e125 — 27.6 W • e127 — 33.5 W PowerSave mode: <ul style="list-style-type: none"> • c125 —6.1 W • c127 — 14.6 W • e125 — 10.9 W • e127 — 17 W <div style="border: 1px solid black; padding: 5px; margin-top: 10px;"> Note: Power consumption figures represent a loaded system and for sonar variants include an active 600 W transducer. </div>
LEN (Refer to Seatalk^{ng} reference manual for further information).	1

c95 / c97 / e95 / e97 power specification

Nominal supply voltage	12/24 V dc
Operating voltage range	10.8 V dc to 31.2 V dc
Fuse / Breakers	In-line fuse (fitted within power cable) <ul style="list-style-type: none"> • 7 A. (Standard 20 mm glass fuse)

e165 power specification

Nominal supply voltage	12/24 V dc
Operating voltage range	10.8 V dc to 31.2 V dc
Fuse / Breakers	In-line fuse (fitted within power cable) <ul style="list-style-type: none"> • 7 A. (Standard 20 mm glass fuse)

Power consumption	Full brightness: <ul style="list-style-type: none"> • e165 — 59.5 W PowerSave mode: <ul style="list-style-type: none"> • e165 — 10.9 W <div style="border: 1px solid black; padding: 5px; margin-top: 10px;"> Note: Power consumption figures represent a loaded system and for sonar variants include an active 600 W transducer. </div>
LEN (Refer to Seatalk ^{ng} reference manual for further information).	1

Color depth	24-bit
Resolution	800 x 480 pixels (WVGA)
Maximum allowable wrongly illuminated pixels	8

e125 / e127 / c125 / c127 Display specification

Size	12 in.
Type	TFT backlit LED
Color depth	24-bit
Resolution	1280 x 800 pixels (WXGA)
Maximum allowable wrongly illuminated pixels	8

Environmental specification

Environmental specifications below apply to all display variants

Operating temperature	-25 °C to +55 °C (-13 °F to 131 °F)
Storage temperature	-30 °C to +70 °C (-22 °F to 158 °F)
Relative humidity	Maximum 75%
Waterproof rating	<ul style="list-style-type: none"> • IPX6 and IPX7 • IPX6 (e165 only)

e165 Display specification

Size	15.4 in.
Type	TFT backlit LED
Color depth	24-bit
Resolution	1280 x 800 pixels (WXGA)
Aspect ratio	16:9
Maximum allowable wrongly illuminated pixels	8

Viewing angle

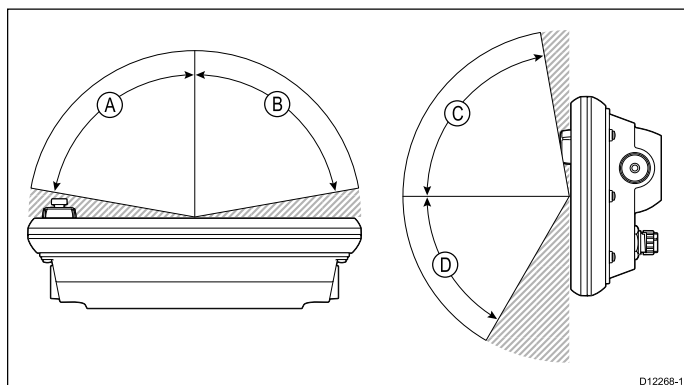

	e7 / e7D	e95 / e97 / c95 / c97	e125 / e127 / c125 / c127	e165
A	70°	80°	80°	80°
B	70°	80°	80°	80°
C	70°	80°	80°	70°
D	50°	60°	60°	70°

Note: The viewing angles stated above were taken using internationally agreed standards and should be used for comparison purposes only. Do NOT install the product before testing the viewability in the desired location.

Data connections

Wired connections

NMEA 0183	2x NMEA 0183 ports: <ul style="list-style-type: none"> • NMEA port 1: Input and output, 4800 / 38400 baud • NMEA port 2: Input only, 4800 / 38400 baud <div style="border: 1px solid black; padding: 5px; margin-top: 10px;"> Note: NMEA 0183 connection does not apply to New a Series multifunction displays. </div>
Network (SeaTalk ^{hs})	<ul style="list-style-type: none"> • New a Series, e7 and e7D = 1 x SeaTalk^{hs} port. 100 Mbits/s. RayNet type connection. • New c Series and New e Series (excluding e7 and e7D) = 2 x SeaTalk^{hs} port. 100 Mbits/s. RayNet type connection.
SeaTalk^{ng}	1 x SeaTalk ^{ng} connection

Wireless connections

Wi-Fi	802.11 b / g <div style="border: 1px solid black; padding: 5px; margin-top: 10px;"> Note: Wi-Fi connection only applies to multifunction displays that include built-in Wi-Fi. </div>
Bluetooth	Bluetooth 2.1+ EDR power class 1.5 (supported profile: AVRCP 1.0)

e7 / e7D Display specification

Size	7 in.
Type	TFT backlit LED
Color depth	24-bit
Resolution	800 x 480 pixels (WVGA)
Maximum allowable wrongly illuminated pixels	7

e95 / e97 / c95 / c97 Display specification

Size	9 in.
Type	TFT backlit LED

Internal GPS specification

The Internal GPS specification applies to the following multifunction displays New a Series, New c Series and New e Series (excluding the e165).

Channels	50
Cold start	<2 minutes

Receiver IC Sensitivity	163 dBm Tracking
Satellite Based Aiding System (SBAS)	WAAS + EGNOS + MSAS
Special features	Active Jamming Reduction
Operating frequency	1575.42MHz
Signal Acquisition	Automatic
Almanac Update	Automatic
Geodetic Datum	WGS-84, alternatives available through Raymarine displays.
Update Rate	1 second
Antenna	Ceramic chip
Accuracy	<ul style="list-style-type: none"> Without SBAS: <= 15 metres 95% of the time With SBAS: <= 5 metres 95% of the time

Conformance specification

Conformance certification applies to all display variants

Conformance	<ul style="list-style-type: none"> NMEA 2000 certification WiFi Alliance certification Bluetooth certification Europe: 1999/5/EC Australia and New Zealand: C-Tick, Compliance Level 2 FCC 47CFR part 15 Industry Canada RSS210
--------------------	--

Internal sonar specification

The internal sonar specifications only apply to sonar variant multifunction display variants.

Operating frequencies	50 / 83 / 200 KHz
Transmit power	Up to 600 W RMS, depending on transducer
Depth range	Up to 3000 ft, depending on transducer

Video specification

Signal type	Composite
Format	PAL or NTSC
Connector type	BNC (female)
Output resolution	720p

Electronic chart specification

Embedded electronic charts	<ul style="list-style-type: none"> LightHouse Charts world base map. Navionics world base map.
Compatible LightHouse charts	<ul style="list-style-type: none"> Vector — LightHouse charts Raster — LightHouse charts
Compatible Navionics chart cards	<ul style="list-style-type: none"> Navionics Ready to Navigate Navionics Silver Navionics Gold Navionics Gold+ Navionics Platinum Navionics Platinum+ Navionics Fish'N Chip Navionics Hotmaps

Note:

Refer to the Raymarine website (www.raymarine.com) for the latest list of supported charts.

Chapter 32: Spares and accessories

Chapter contents

- [32.1 Transducer accessories on page 360](#)
- [32.2 DownVision transducers and accessories on page 360](#)
- [32.3 Network hardware on page 361](#)
- [32.4 Network cable connector types on page 361](#)
- [32.5 Network cables on page 362](#)
- [32.6 Network cable types on page 362](#)
- [32.7 SeaTalk^{ng} cabling components on page 363](#)
- [32.8 SeaTalk^{ng} cables and accessories on page 363](#)
- [32.9 SeaTalk accessories on page 364](#)
- [32.10 Video cables on page 365](#)
- [32.11 a65 / a67 spares on page 365](#)
- [32.12 e7 e7D spares on page 366](#)
- [32.13 e95 / e97 / c95 / c97 spares on page 366](#)
- [32.14 e125 / e127 / c125 / c127 spares on page 367](#)
- [32.15 e165 Spares on page 367](#)

32.1 Transducer accessories



Item	Part number	Notes
P48 sonar transducer	A102140	Transom mount.
P58 sonar transducer	A102138	Transom mount.
1 m (3.28 ft) Minn Kota transducer adaptor cable	A62363	Only for direct connection to sonar variant multifunction display.
0.5 m (1.64 ft) transducer adaptor cable	E66066	For connecting any 600 watt sonar module-compatible sonar transducer directly to a sonar variant multifunction display.

32.2 DownVision transducers and accessories

The following DownVision™ accessories are available for use with DownVision™ variant multifunction displays.

Item	Part number
CPT-100 Transom DownVision transducer	A80270
CPT-110 Through-hull DownVision transducer (plastic)	A80277
CPT-120 Through-hull DownVision transducer (bronze)	A80271
Transom transducer shield for vessels with a trolling motor	A80207
4 m (13.12 ft) transducer extension cable for CPT-100 transom transducer	A80273

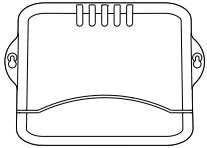
32.3 Network hardware

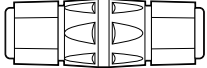
Item	Part number	Notes
HS5 RayNet network switch 	A80007	5-port switch for network connection of multiple devices featuring RayNet connectors. Equipment with RJ45 SeaTalk ^{hs} connectors can also be connected using suitable adapter cables.
RJ45 SeaTalk ^{hs} network switch 	E55058	8-port switch for network connection of multiple SeaTalk ^{hs} devices featuring RJ45 connectors.
RJ45 SeaTalk ^{hs} crossover coupler 	E55060	<ul style="list-style-type: none"> Enables direct connection of RJ45 SeaTalk^{hs} devices to smaller systems where a switch is not required. Enables the connection of RJ45 SeaTalk^{hs} devices to a HS5 RayNet network switch (in conjunction with suitable adapter cables). Enables 2 RJ45 SeaTalk^{hs} cables to be connected together to extend the length of the cabling. Recommended for internal installations.
Ethernet RJ45 coupler 	R32142	<ul style="list-style-type: none"> Enables direct connection of RJ45 SeaTalk^{hs} devices to smaller systems where a switch is not required. Enables the connection of RJ45 SeaTalk^{hs} devices to a HS5 RayNet network switch (in conjunction with suitable adapter cables). Enables 2 RJ45 SeaTalk^{hs} cables to be connected together to extend the length of the cabling. Recommended for external installations.

32.4 Network cable connector types

There are 2 types of network cable connector — SeaTalk^{hs} and RayNet.

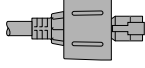
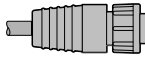
	SeaTalk^{hs} connector — used for connecting SeaTalk ^{hs} devices to a Raymarine network switch via SeaTalk ^{hs} cables.
	RayNet connector — used for connecting Raymarine network switches and SeaTalk ^{hs} devices to the multifunction display via RayNet cables. Also required for connecting a crossover coupler if only one device is being connected to the display's Network connector.

32.5 Network cables

RayNet to RayNet cables

Cable	Part number
400 mm (1.3 ft) RayNet (F) to RayNet (F) cable	A80161
2 m (6.56 ft) RayNet (F) to RayNet (F) cable	A62361
5 m (16.4 ft) RayNet (F) to RayNet (F) cable	A80005
10 m (32.8 ft) RayNet (F) to RayNet (F) cable	A62362
20 m (65.6 ft) RayNet (F) to RayNet (F) cable	A80006
100 mm (3.9 in) RayNet (M) to RayNet (M) cable	A80162
RayNet right-angled coupler	A80262
RayNet cable puller 5-pack	R70014

RayNet adapter cables

Cable	Part number
1 m (3.28 ft) RayNet (F) to RJ45 SeaTalk ^{hs} (M) cable	A62360
3 m (9.84 ft) RayNet (F) to RJ45 SeaTalk ^{hs} (M) cable	A80151
10 m (32.8 ft) RayNet (F) to RJ45 SeaTalk ^{hs} (M) cable	A80159
400 mm (1.3 ft) RayNet (F) to RJ45 SeaTalk ^{hs} (F) cable	A80160
100 mm (3.9 in) RayNet (F) to RJ45 (F) cable	A80247
350 mm (13.78 in) RayNet (M) to RJ45 SeaTalk ^{hs} (M) cable	A80272
3 m (9.84 ft) RayNet (F) to RJ45 SeaTalk ^{hs} (M) cable	A80276

32.6 Network cable types

There are 2 types of SeaTalk^{hs} network cable — “patch” and “network”.

- **Patch** — for connecting the following devices to a Raymarine network switch:
 - Thermal camera via PoE injector.
 - Additional Raymarine network switch.
 - PC or laptop using Voyager planning software.
- **Network** — for connecting the following devices to a Raymarine network switch:
 - Sonar Module.
 - SR100 Sirius weather receiver.
 - Additional compatible Raymarine multifunction displays.

SeaTalk^{hs} network cables

Cable	Part number
1.5 m (4.9 ft) SeaTalk ^{hs} network cable	E55049
5 m (16.4 ft) SeaTalk ^{hs} network cable	E55050
10 m (32.8 ft) SeaTalk ^{hs} network cable	E55051
20 m (65.6 ft) SeaTalk ^{hs} network cable	E55052

SeaTalk^{hs} patch cables

Cable	Part number
1.5 m (4.9 ft) SeaTalk ^{hs} patch cable	E06054
5 m (16.4 ft) SeaTalk ^{hs} patch cable	E06055
10 m (32.8 ft) SeaTalk ^{hs} patch cable	E06056
15 m (49.2 ft) SeaTalk ^{hs} patch cable	A62136
20 m (65.6 ft) SeaTalk ^{hs} patch cable	E06057

32.7 SeaTalk^{ng} cabling components

SeaTalk^{ng} cabling components and their purposes.

Connection / Cable	Notes
Backbone cable (various lengths)	The main cable carrying data. Spurs from the backbone are used to connect SeaTalk ^{ng} devices.
T-piece connector	Used to make junctions in the backbone to which devices can then be connected.
Terminator	Required at either end of the backbone.
Inline terminator	Used to connect a spur cable directly to the end of a backbone; useful for longer cable runs.
Spur cable	Used to connect devices to the backbone. Devices may be daisy chained or connected directly to the T-pieces.
SeaTalk ^{ng} 5-way connector	Used to branch, split, or make additional connections in SeaTalk or SeaTalk ^{ng} networks.
Blanking plug	Inserted into unused spur connector positions in a 5-way connector or T-piece.

32.8 SeaTalk^{ng} cables and accessories

SeaTalk^{ng} cables and accessories for use with compatible products.

Description	Part No	Notes
SeaTalk ^{ng} starter kit	T70134	Includes: <ul style="list-style-type: none"> • 1 x 5 Way connector (A06064) • 2 x Backbone terminator (A06031) • 1 x 3 m (9.8 ft) spur cable (A06040) • 1 x Power cable (A06049)
SeaTalk ^{ng} Backbone Kit	A25062	Includes: <ul style="list-style-type: none"> • 2 x 5 m (16.4 ft) Backbone cable (A06036) • 1 x 20 m (65.6 ft) Backbone cable (A06037) • 4 x T-piece (A06028) • 2 x Backbone terminator (A06031) • 1 x Power cable (A06049)
SeaTalk ^{ng} 0.4 m (1.3 ft) spur	A06038	
SeaTalk ^{ng} 1 m (3.3 ft) spur	A06039	
SeaTalk ^{ng} 3 m (9.8 ft) spur	A06040	
SeaTalk ^{ng} 5 m (16.4 ft) spur	A06041	
SeaTalk ^{ng} 0.4 m (1.3 ft) elbow spur	A06042	
SeaTalk ^{ng} 0.4 m (1.3 ft) backbone	A06033	
SeaTalk ^{ng} 1 m (3.3 ft) backbone	A06034	
SeaTalk ^{ng} 3 m (9.8 ft) backbone	A06035	
SeaTalk ^{ng} 5 m (16.4 ft) backbone	A06036	
SeaTalk ^{ng} 9 m (29.5 ft) backbone	A06068	
SeaTalk ^{ng} 20 m (65.6 ft) backbone	A06037	
SeaTalk ^{ng} to bare ends 1 m (3.3 ft) spur	A06043	
SeaTalk ^{ng} to bare ends 3 m (9.8 ft) spur	A06044	
SeaTalk ^{ng} Power cable	A06049	
SeaTalk ^{ng} Terminator	A06031	
SeaTalk ^{ng} T-piece	A06028	Provides 1 x spur connection
SeaTalk ^{ng} 5-way connector	A06064	Provides 3 x spur connections
SeaTalk ^{ng} backbone extender	A06030	
SeaTalk to SeaTalk ^{ng} converter kit	E22158	Allows the connection of SeaTalk devices to a SeaTalk ^{ng} system.

Description	Part No	Notes
SeaTalk ^{ng} Inline terminator	A80001	Provides direct connection of a spur cable to the end of a backbone cable. No T-piece required.
SeaTalk ^{ng} Blanking plug	A06032	
ACU / SPX SeaTalk ^{ng} spur cable 0.3 m (1.0 ft)	R12112	Connects an SPX course computer or an ACU to a SeaTalk ^{ng} backbone.
SeaTalk (3 pin) to SeaTalk ^{ng} adaptor cable 0.4 m (1.3 ft)	A06047	
SeaTalk to SeaTalk ^{ng} spur 1 m (3.3 ft) spur	A22164	
SeaTalk2 (5 pin) to SeaTalk ^{ng} adaptor cable 0.4 m (1.3 ft)	A06048	
DeviceNet adaptor cable (Female)	A06045	Allows the connection of NMEA 2000 devices to a SeaTalk ^{ng} system.
DeviceNet adaptor cable (Male)	A06046	Allows the connection of NMEA 2000 devices to a SeaTalk ^{ng} system.
DeviceNet adaptor cable (Female) to bare ends.	E05026	Allows the connection of NMEA 2000 devices to a SeaTalk ^{ng} system.
DeviceNet adaptor cable (Male) to bare ends.	E05027	Allows the connection of NMEA 2000 devices to a SeaTalk ^{ng} system.

32.9 SeaTalk accessories

SeaTalk cables and accessories for use with compatible products.

Description	Part No	Notes
3-way SeaTalk junction box	D244	
1 m (3.28 ft) SeaTalk extension cable	D284	
3 m (9.8 ft) SeaTalk extension cable	D285	
5 m (16.4 ft) SeaTalk extension cable	D286	
9 m (29.5 ft) SeaTalk extension cable	D287	
12 m (39.4 ft) SeaTalk extension cable	E25051	
20 m (65.6 ft) SeaTalk extension cable	D288	

32.10 Video cables

The following video cable is required for the video in / out connector on the e95 / e97 / e125 / e127 variant multifunction displays.

Part number	Description	Notes
R70003	e-series accessory video cable	

32.11 a65 / a67 spares

Item	Part number	Notes
Trunnion (bracket) mount kit	R70147	
Front bezel	R70148	
Suncover	R70149	
Power cable 1.5m	R70157	
1.5 m (4.9 ft) Right angled power cable	A80221	

32.12 e7 e7D spares

Item	Part number	Notes
Trunnion (bracket) mount kit	A62358	
Documentation pack	R62378	
Flush mount panel set	R62376	
Front bezel	R62377	
Suncover	R62365	
1.5 m (4.9 ft) Straight power and data cable	R62379	
1.5 m (4.9 ft) Right angled power and data cable	R70029	

32.13 e95 / e97 / c95 / c97 spares

Item	Part number	Notes
c/e series trunnion kit	R70001	
c/e series front bezel	R7004	
c/e series suncover	R70005	
c/e series rear bezel	R70027	
c/e series gasket	R70079	
Mounting adaptor kit — C90W/E90W	R70008	
Mounting adaptor kit — C80/E80	R70010	
Mounting screw kit	R62369	
Document pack	R70061	
1.5 m (4.9 ft) Straight power and data cable	R62379	
1.5 m (4.9 ft) Right angled power and data cable	R70029	

32.14 e125 / e127 / c125 / c127 spares

Item	Part number	Notes
c/e series trunnion kit	R70002	
c/e series front bezel	R7006	
c/e series suncover	R70007	
c/e/ series rear bezel	R70028	
c.e series gasket	R70080	
Mounting adaptor kit — C120W/E120W	R70009	
Mounting adaptor kit — C120/E120	R70011	
Mounting screw kit	R62369	
Document pack	R70061	
1.5 m (4.9 ft) Straight power and data cable	R62379	
1.5 m (4.9 ft) Right angled power and data cable	R70029	

32.15 e165 Spares

Item	Part number	Notes
e165 trunnion kit	A80176	
e165 front bezel	R70126	
e165 suncover	R70127	
e165 flush mount kit	R70125	
1.5 m (4.9 ft) Straight power and data cable	R62379	
1.5 m (4.9 ft) Right angled power and data cable	R70029	

Appendix A NMEA 0183 sentences

The display supports the following NMEA 0183 sentences. These are applicable to NMEA 0183 and SeaTalk protocols.

Sentence	Description	Transmit	Receive
AAM	Waypoint arrival alarm sentence		•
APB	Autopilot sentence 'B'	•	•
BWC	Bearing and distance to waypoint	•	•
BWR	Bearing and distance to waypoint — Rhumb	•	•
DBT	Depth below transducer	•	•
DPT	Depth	•	•
DSC	Digital selective calling information sentence		•
DSE	Distress sentence expansion		•
DTM	Datum reference sentence		•
GBS	GPS satellite fault detection data sentence		•
GGA	GPS System fix data	•	•
GLC	Geographic position loran C sentence		•
GLL	Geographic position latitude longitude	•	•
GSA	GPS DOP and active satellites	•	•
GSV	GPS satellites in view	•	•
HDG	Heading deviation and variation sentence		•
HDT	Heading true sentence		•
HDM	Heading magnetic sentence		•
MDA	Meteorological composite sentence		•
MSK	MSK receiver interface sentence		•
MSS	MSK receiver signal status sentence		•
MTW	Water temperature	•	•
MWV	Wind speed and angle	•	•
RMB	Recommended minimum navigation information	•	•
RMC	Recommended minimum specific GNSS data	•	•
RSD	Radar system data	•	•
TTM	Tracked target message	•	•
VHW	Water speed and heading	•	•
VLW	Distance travelled through the water	•	•
VTG	Course over ground and ground speed	•	•
XTE	Cross track error measured sentence		•
ZDA	Time and date	•	•

Appendix B NMEA data bridging

NMEA data bridging allows data that exists on the display's NMEA 2000 bus to be repeated to NMEA 0183 devices, and vice versa.

An example of NMEA data bridging is in a system that includes a third-party GPS receiver connected to the NMEA 0183 Input of a Raymarine display. The GPS data messages transmitted by the GPS receiver are repeated to any appropriate devices connected to the display's NMEA 2000 bus. Bridging only occurs when the data is being transmitted by an NMEA 0183 device that is not already being transmitted by a NMEA 2000 device, and vice versa.

For a list of data messages (PGN sentences) that are bridged between NMEA 2000 and NMEA 0183, refer to the list of supported NMEA 2000 sentences provided in this document.

Appendix C NMEA 2000 sentences

The display supports the following NMEA 2000 sentences. These are applicable to NMEA 2000, SeaTalk^{ng} and SeaTalk 2 protocols.

Message number	Message description	Transmit	Receive	Bridged to NMEA 0183
59392	ISO Acknowledgment	•	•	
59904	ISO Request	•	•	
60928	ISO Address Claim	•	•	
126208	NMEA - Request group function	•	•	
126464	PGN List – Transmit/Receive PGN's Group function	•	•	
126992	System time	•	•	
126996	Product information	•	•	
127237	Heading/Track Control		•	
127245	Rudder		•	
127250	Vessel heading	•	•	•
127251	Rate of Turn	•	•	
127257	Attitude	•	•	
127258	Magnetic Variation	•		
127488	Engine parameters, rapid update		•	
127489	Engine parameters, dynamic		•	
127493	Transmission parameters, dynamic		•	
127496	Trip parameters, Vessel		•	
127497	Trip parameters, Engine		•	
127498	Engine parameters, static		•	
127505	Fluid level		•	
127508	Battery status		•	
128259	Speed, water referenced	•	•	•
128267	Water depth	•	•	•
128275	Distance log	•	•	•
129025	Position, rapid update	•	•	•
129026	COG & SOG, rapid update	•	•	•
129029	GNSS position data	•	•	•
129033	Time and date	•	•	•
129038	AIS Class A Position Report		•	
129039	AIS Class B Position Report		•	
129040	AIS Class B Extended Position Report		•	
129041	AIS Aids to Navigation (AToN) report		•	
129044	Datum	•	•	•
129283	Cross track error	•	•	•
129284	Navigation data	•	•	•
129291	Set and drift, rapid update	•	•	•
129301	Time to or from mark		•	
129539	GNSS DOPs		•	
129540	GNSS Sats in view	•	•	
129542	GNSS pseudorange noise statistics		•	
129545	GNSS RAIM output		•	
129550	GNSS differential correction receiver interface		•	
129551	GNSS differential correction receiver signal		•	
129793	AIS UTC and Date Report		•	

Message number	Message description	Transmit	Receive	Bridged to NMEA 0183
129794	AIS Class A Static and Voyage Related Data		•	
129798	AIS SAR aircraft position report		•	
129801	AIS Addressed Safety Related Message		•	
129802	AIS Safety Related Broadcast Message		•	
129808	DSC call information		•	
129809	AIS class B "CS" static data report part A		•	
129810	AIS class B "CS" static data report part B		•	
130306	Wind data	•	•	•
130310	Environmental parameters	•	•	•
130311	Environmental parameters		•	•
130312	Temperature		•	
130313	Humidity		•	
130314	Actual pressure		•	
130576	Small craft status		•	
130577	Direction data	•	•	•
130578	Vessel speed components		•	

PGN 127489 - Support engine alarms

The following engine alarms are supported.

Engine Error
Check Engine
Over Temperature
Low Oil Pressure
Low Oil Level
Low Fuel Pressure
Low System Voltage
Low Coolant Level
Water Flow
Water in Fuel
Charge Indicator
High Boost Pressure
Rev Limit Exceeded
EGR System
Throttle Position Sensor
Engine Emergency Stop Mode
Warning Level 1
Warning Level 2
Power Reduction
Maintenance Needed
Engine Comm Error
Sub or Secondary Throttle
Neutral Start Protect
Engine Shutting Down
unknown error

Appendix D Connectors and pinouts

Power, data, and video connector

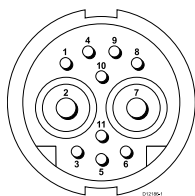

Item	Remarks
Identification	PWR / NMEA / Video
Connector type	11 pin twist-lock
Current source to network	No current sourced for external devices
Current sink from network	<ul style="list-style-type: none"> PSU: Main Power input. NMEA: No power required for interface. Video: No power required for interface.

Power, data and video cable cores and colors

Signal	Pin	AWG	Color
BATT+	2	16	Red
BATT-	7	16	Black
SCREEN	10	26	Black
NMEA1 TX+	8	26	Yellow
NMEA1 TX-	9	26	Brown
NMEA1 RX+	1	26	White
NMEA1 RX-	4	26	Green
NMEA2 RX+	3	26	Orange / White
NMEA2 RX-	11	26	Orange / Green
VIDEO IN	6	RG179 coaxial	
VIDEO RTN	5	Screen	

Network connector

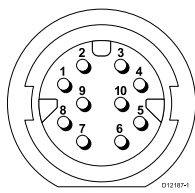

Item	Remarks
Identification	Network
Connector type	RJ45 (with suitable waterproofing)
Current source to network	No current sourced for external devices
Current sink from network	No power required for interface

Pin	Signal
1	Rx+
2	Rx-
3	Not connected
4	Not connected
5	Tx+
6	Tx-
7	Not connected

Pin	Signal
8	Not connected
9	Screen
10	Not connected

Note: Use only Raymarine RayNet cables when connecting SeaTalk^{hs} devices.

SeaTalk^{ng} connector

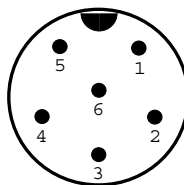

Item	Remarks
Identification	ST2/NMEA2000
Connector type	STNG
Current source to network	No current sourced for external devices
Current sink from network	<160mA (Interface drive only)

Pin	Signal
1	+12V
2	0V
3	Screen
4	CanH
5	CanL
6	SeaTalk (not connected)

Note: Use only Raymarine cables when connecting to SeaTalk^{ng}

Video in/out connector

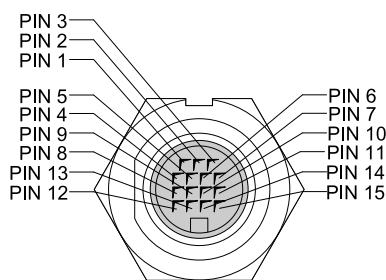

PIN	Signal
1	H-SYNC
2	V-SYNC
3	V-SYNC 0V
4	DDC CLK
5	DDC DATA
6	BLUE RTN
7	BLUE
8	Not used
9	H-SYNC 0V
10	GREEN RTN
11	GREEN
12	VIDEO IN2

PIN	Signal
13	VIDEO IN2 RTN
14	RED RTN
15	RED

Appendix E Switch panel application

Vessel control and monitoring systems

When integrated with a vessel control and monitoring system your multifunction display can provide monitoring and controls for your power circuits, breakers, switches and equipment.

The Switch Panel application can be used to:

- Show the status of power circuits, breakers, switches and other equipment.
- Apply power to each circuit individually.
- Reset tripped breakers.
- Control power to individual equipment.
- Alert users to a tripped circuit.

Vessel control and monitoring system connection

The multifunction display can connect to and control an EmpirBus NXT vessel control and monitoring system.

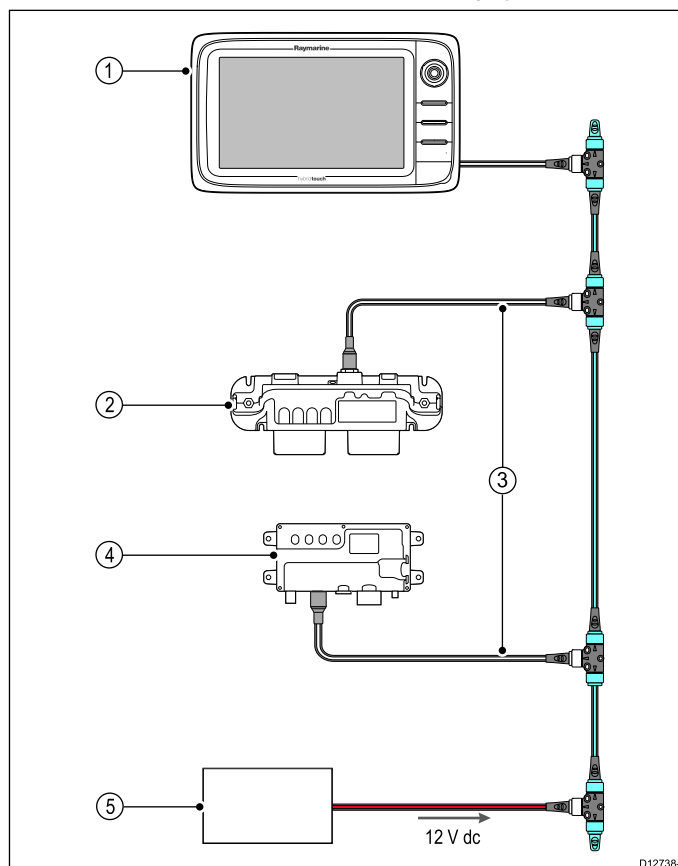

1	Raymarine multifunction display.
2	EmpirBus NXT DCM (dc module).
3	SeaTalkng to DeviceNet adaptor cable.
4	EmpirBus NXT MCU (Master control unit).
5	12 V dc supply into backbone.

Note: Ensure your vessel control and monitoring system has been installed in accordance with the instructions provided with the system.

Switch panel configuration

The switch panel application must be configured.

A Configuration file can be obtained from the system supplier.

Loading a configuration file

The switch panel application will only be available when a valid configuration file has been loaded.

1. Obtain the configuration file from the system supplier.
2. Save the configuration file to the root directory of your memory card.

3. Insert the memory card into the card reader on your multifunction display.
4. From the homescreen select **Set-up**.
5. Select **System Settings**.
6. Select **External Devices**.
7. Select **Switch Panel Set-up**.
8. Select **Install Config File**.
9. If prompted select the memory card slot that contains your configuration file.
The file browser is opened.
10. Select the configuration file.
11. Select **OK**.

You can now add the Switch panel application from the Customize menu on the homescreen.

Note: If your multifunction display only has 1 card slot then step 9 is skipped.

Switch panel overview

The switch panel application is used to monitor and control compatible vessel control and monitoring systems. The pages and page layouts and vessel schematics are configured at installation and are unique for each vessel. The images below are examples.

Example 1 — Switch panel mode page



If configured a Mode page provides controls to switch between pre-configured modes.

In the example above selecting a mode icon will place the system into the selected mode.

You can cycle through available pages to monitor or control switches and configured groups of switches.

Example 2 — Vessel controls page



1	Toggle switch.
2	Rotary (multi-state) switch.
3	Position control switch.
4	Momentary switch.
5	Data item (dial gauge).
6	Data item (tank level).

Using the switches on a Touchscreen

 This only applies to HybridTouch displays.

From the switch panel application:

1. **Toggle switch** — Select the switch to switch on or off.
2. **Rotary control** — Selecting the rotary control will cycle through its available states.
3. **Position Control** — Select and hold on a direction to move.
4. **Momentary switch** — Select the switch to activate.
5. **Dimmer switch** — Select and then drag the control to adjust the value.

Using the switches

From the switch panel application:

1. Use the **Joystick** to highlight the relevant switch.
2. **Toggle switch** — Press **Ok** to switch on or off.
3. **Rotary control** — Pressing **Ok** will cycle through its available states.
4. **Position Control** — Press **Ok** and use the **Joystick** to move direction.
5. **Momentary switch** — Press **Ok** to activate.
6. **Dimmer switch** — Press **Ok** on the switch and use the **Rotary Control** to adjust the value, then select **back** to exit adjust mode.

Resetting a tripped circuit

When a circuit is tripped a pop-up message will be displayed on-screen providing details of the tripped circuit and options, the circuit will also be identified as tripped in the switch panel pages.

1. With a tripped circuit pop-up message displayed select **Reset** to reset the tripped circuit, or
2. Select the switch on a switch panel page to reset the tripped switch.

Note: Performing multiple resets risks causing damage to your system so if a trip persists check the main circuits.

Appendix F Software releases

Raymarine regularly updates its multifunction display software to introduce improvements, additional hardware support and user interface features. The table below details some of the important enhancements and which software revision they were introduced with.

Software version	Applicable product manual	Multifunction displays compatibility	Changes
LightHouse II — V10.xx	81337-10	a65 / a65 Wi-Fi / a67 / a67 Wi-Fi a68 / a68 Wi-Fi / a75 / a75 Wi-Fi / a77 / a77 Wi-Fi / a78 / a78 Wi-Fi / c95 / c97 / c125 / c127 / e7 / e7D / e95 / e97 / e125 / e127 / e165	<p>New Fishfinder application</p> <ul style="list-style-type: none"> • Support for multiple active sonar modules on the network • Ability to display multiple sonar channels simultaneously using splitscreen pages • Ability to create custom sonar channel profiles • New sonar module specific Fishfinder simulator • Corrected (reversed) TVG control on CP450C to match all sonar modules • Switch panel alarms can now be enabled/disabled globally across the network • Added horizontal splitscreen template for 5.7 and 7 inch MFDs • Added support for Navionics Sonar Log depth recording • Added support for Navionics Plotter Sync mobile chart updates • Updated SiriusXM NOAA Marine Zone Boundaries updates for April 1st 2014 • AIS dangerous target alarm defaults to Off in Simulator mode and cannot be enabled. • Added additional language support for Czech and Slovenian
LightHouse II — V9.45	81337-9	a65 / a65 Wi-Fi / a67 / a67 Wi-Fi a68 / a68 Wi-Fi / a75 / a75 Wi-Fi / a77 / a77 Wi-Fi / a78 / a78 Wi-Fi / c95 / c97 / c125 / c127 / e7 / e7D / e95 / e97 / e125 / e127 / e165	<ul style="list-style-type: none"> • LightHouse II Graphics refresh • Added hide databar option • Added support for LightHouse charts • Waypoint management improvements • Chart and Radar application menu improvements • Added support for multiple sonars • Added estimated time of arrival for Routes • Added NM & m to distance units • Added digital widget to Switch panel app • Added support for DSC over NMEA 2000 • Added support for Navionics Gold chip encryption • Updated Japanese limitations of use statement • Added support for multi-touch gesture on a Series displays
V8.52	81337-9	a65 / a65 Wi-Fi / a67 / a67 Wi-Fi a68 / a68 Wi-Fi / a75 / a75 Wi-Fi / a77 / a77 Wi-Fi / a78 / a78 Wi-Fi / c95 / c97 / c125 / c127 / e7 / e7D / e95 / e97 / e125 / e127 / e165	<ul style="list-style-type: none"> • Added support for ECI-100 (Engine Identification Wizard)
V7.43	81337-7	a65 / a65 Wi-Fi / a67 / a67 Wi-Fi / c95 / c97 / c125 / c127 / e7 / e7D / e95 / e97 / e125 / e127 / e165	<ul style="list-style-type: none"> • Added User manual shortcut to Homescreen. • Added IP camera record, playback and image capture to Camera application. • Added support for Evolution autopilots • Added Pilot bar. • Added support for T200 Series fixed mount thermal cameras. • Added support for CP100 and CP300 sonar modules. • Added additional data types to data application. • Improved dial graphics in Data application. • Improved menu layouts in Chart and Radar applications.

Software version	Applicable product manual	Multifunction displays compatibility	Changes
			<ul style="list-style-type: none"> • Added support for RMK-9 remote keypad. • Added feature to allow simultaneous software update of networked displays and keypads. • Improved engine support for fuel manager. • Add feature to allow choice of startup page. • Moved Cartography menu to Homescreen Setup menu. • Removed compatibility mode (for E-Wide and G Series compatibility). • Added Pilot Standby function to power button for displays that do not have a pilot button.
V6.27	81337-6	a65 / a65 Wi-Fi / a67 / a67 Wi-Fi / c95 / c97 / c125 / c127 / e7 / e7D / e95 / e97 / e125 / e127 / e165	<ul style="list-style-type: none"> • Addition of Sirius audio application. • Addition of Fusion link application. • Addition of Switch panel application. • New homescreen application icons • Changed Chart navigation to include vessel position to target WPT and original position to target WPT lines. • Added Icelandic and Bulgarian language support.
V5.27	81337-5	a65 / a67 / c95 / c97 / c125 / c127 / e7 / e7D / e95 / e97 / e125 / e127 / e165	<ul style="list-style-type: none"> • Addition of Fuel Manager including: Estimated fuel remaining, distance to empty and time to empty calculations, fuel used and fuel economy data, fuel range rings in the Chart application and low fuel alarm). • Addition of Document (pdf) Viewer application. • Addition of Slew to Cue (Auto slew thermal camera to AIS, MARPA or MOB targets). • Support for multiple thermal camera JCUs. • Thermal cameras OSD menu options now available directly from Thermal Camera application's menu. • Video application now called Camera application. • Support for networked IP cameras in the Camera application. • Ability to automatically cycle through available video / camera feeds in the Camera application. • Support for up to 5 engines in the Data application. • Improved engine data selection in the Data application. • Support for detailed engine warning alarms. • Addition of on-screen range controls to the Weather application • Ability to view images saved to MicroSD card from the homescreen My Data menu. • Addition of Demo Video mode for retail. • Ability to record live bus messages (NMEA 0183 and SeaTalk^{ng}) to MicroSD card.
V4.32	81337-4	c95 / c97 / c125 / c127 / e7 / e7D / e95 / e97 / e125 / e127	<ul style="list-style-type: none"> • Addition of on-screen range controls to the Chart & Radar applications. • Addition of on-screen Gain, Rain & Sea controls to Radar application. • Addition of on-screen Gain & TVG controls to Sonar application. • Addition of slider bar control adjustment. • Addition of new numeric adjustment controls. • Improved Power Key shortcuts to Brightness and Capture Screen image options

Software version	Applicable product manual	Multifunction displays compatibility	Changes
V3.15	81337-3	c95 / c97 / c125 / c127 / e7 / e7D / e95 / e97 / e125 / e127	<ul style="list-style-type: none"> • Added support for Raymarine CP450C CHIRP Sonar Module. • Added support for AIS feature support for STEDS E AIS integration & display of SAR aircraft & SART devices. • Added limited support for Sirius Marine Weather Module. • Added Standby / PowerSave Mode. • Added support for RayRemote and RayControl Applications. • Enhanced home screen customize option permitting 9 and 12 inch MFDs to view up to 4 applications on a single page. • Default Fuel data page added. • Added Arabic language support. • Inclusion of Remote Upgrade Utility to permit the upload of software to peripheral Raymarine products using SeaTalk^{ng} / SeaTalk^{hs}. • Display of Aids To Navigation (AToNs) AIS targets when data received on either SeaTalk^{ng} or NMEA 0183. • Added 1kW transducer support added to MFDs featuring internal ClearPulse Digital Sounder circuitry (i.e. c97/c127/e7D/e97/e127 MFDs) transducer output limited to 600W. • Corrected the ability to select Tide and/or Current Station using the Find Nearest feature. • Added NMEA 0183 & SeaTalk^{ng} data monitors to the diagnostics features. • Increased touch area for Alarm pop-ups and Back buttons.
V2.10	81337-1	c95 / c97 / c125 / c127 / e7 / e7D / e95 / e97 / e125 / e127	<ul style="list-style-type: none"> • Cartography redraw performance has been improved when sharing cartography via the SeaTalk^{ng}/RayNet network. • Added support to display fuel flow rate. • Addition of NMEA 0183 and SeaTalk^{ng} data buffer diagnostics. • Improvements to databar customization. • Ability to manually change the aspect ratio of the Video application.
V1.11	81332-1	e7 / e7D	<ul style="list-style-type: none"> • Initial software release.

Appendix G Multifunction display compatibility

The table below identifies the MFD software version required to support the listed hardware.

CP450C	V3.15
Raymarine mobile applications	V3.15
1kW transducer support for sonar variant displays	V3.15
Multiple thermal camera JCU's	V5.27
IP cameras	V5.27
Sirius weather receiver	V6.27
Fusion entertainment	V6.27
Digital Switching	V6.27
Evolution autopilots	V7.43
T200 fixed mount thermal cameras	V7.43
CP100	V7.43
CP300	V7.43
RMK-9 remote keypad	V7.43
ECl-100	V8.52
LightHouse Charts	V9.45 — LightHouse II
Multiple sonar support (1 active)	V9.45 — LightHouse II
Multiple active sonar modules	V10.xx — LightHouse II

Raymarine[®]
A FLIR COMPANY